

## RF exposure compliance assessment

massive MIMO Adaptive Antenna Products – AEUA/AEUF

---

Author	Christophe Grangeat
Owner	Christophe Grangeat
Organization	MN ATF
Approver	tbd
Document Type	Preliminary test report
Document ID	tbd
Document location	tbd

---

### Change History

Version	Status	Date	Author	Owner	Reviewed by	Reviewed date	Approver	Approval date	Description of changes
0.1	Draft	29-08-2018	C. Grangeat	C. Grangeat					Initial draft

This material, including documentation and any related computer programs, is protected by copyright controlled by Nokia. All rights are reserved. Copying, including reproducing, storing, adapting or translating, any or all of this material requires the prior written consent of Nokia. This material also contains confidential information, which may not be disclosed to others without the prior written consent of Nokia.

## Contents

1	General content.....	4
2	References.....	4
2.1	Applicable RF exposure standards and regulations .....	4
2.2	Product and assessment method.....	5
3	RF exposure limits .....	5
4	Description of the equipment under test (EUT) .....	6
5	RF exposure assessment method.....	8
6	RF exposure computation results.....	8
7	Conclusion and installation recommendations.....	11

## List of Tables

Table 1 – Applicable RF exposure levels at 28 GHz expressed in power density .....	5
Table 2 – AEUA/AEUF products general technical characteristics .....	6
Table 3 – Measured antenna gain characteristics for various beam steering directions (from datasheet until [11] is available) .....	7
Table 4 – Validation of the antenna model at 28 GHz.....	8
Table 5 – AEUA/AEUF RF exposure compliance distances based on the time-averaged maximum transmitted power of 1.33 W (corresponding to 1.26 W rated max transmitted power).....	11
Table 6 – AEUA/AEUF RF exposure compliance distances based on the time-averaged actual maximum transmitted power of 0.33 W (corresponding to 1.26 W rated max transmitted power) .....	12

## List of Figures

Figure 1 – Shape of the compliance boundary used for the RF exposure compliance assessment (from [4]).....	7
Figure 2 – Top view of the power density for the time-averaged maximum transmitted power of 1.33 W and the beam oriented in azimuth = 0° & elevation = 0° .....	9

Figure 3 – Top view of the power density for the time-averaged actual maximum transmitted power of 0.33 W and the beam oriented in azimuth = 0° & elevation = 0° ..... 9

Figure 4 – Side view of the power density for the time-averaged maximum transmitted power of 1.33 W and the beam oriented in azimuth = 0° & elevation = -11° ..... 9

Figure 5 – Side view of the power density for the time-averaged actual maximum transmitted power of 0.33 W and the beam oriented in azimuth = 0° & elevation = -11° ..... 10

Figure 6 – Top view of the power density for the time-averaged maximum transmitted power of 1.33 W and the beam oriented in azimuth = 45° & elevation = 0° ..... 10

Figure 7 – Top view of the power density for the time-averaged actual maximum transmitted power of 0.33 W and the beam oriented in azimuth = 45° & elevation = 0° ..... 10

## 1 General content

This test report is addressing human exposure to radiofrequency electromagnetic fields (RF-EMF) transmitted by the following LTE massive MIMO Adaptive Antenna (MAA) Products (see §2.2):

- Nokia AirScale MAA 2T2R 512 AE 8W n257 AEUA/AEUF

It provides the RF exposure compliance boundaries for these products regarding both general population and occupational exposure. Outside of these compliance boundaries, human exposure to RF-EMF is below the limits defined by the US Federal Communications Commission (FCC), Canada Safety Code 6 and European regulations (see §2.1 and 3).

## 2 References

### 2.1 Applicable RF exposure standards and regulations

- [1] EU 1999/519/EC, “Council Recommendation on the limitation of exposure of the general public to electromagnetic fields (0 Hz to 300 GHz)”, July 1999
- [2] EU 2013/35/EU, “Directive of the European Parliament and of the Council on the minimum health and safety requirements regarding the exposure of workers to the risks arising from physical agents (electromagnetic fields) (20th individual Directive within the meaning of Article 16(1) of Directive 89/391/EEC) and repealing Directive 2004/40/EC”, June 2013
- [3] EN 50385:2017, “Product standard to demonstrate the compliance of base station equipment with radiofrequency electromagnetic field exposure limits (110 MHz - 100 GHz), when placed on the market”, July 2017
- [4] IEC/EN 62232:2017, “Determination of RF field strength, power density and SAR in the vicinity of radiocommunication base stations for the purpose of evaluating human exposure”, September 2017.
- [5] IEC/EN 62479:2010, “Assessment of the compliance of low-power electronic and electrical equipment with the basic restrictions related to human exposure to electromagnetic fields (10 MHz to 300 GHz)”, June 2010.
- [6] Canada Safety Code 6, “Limits of Human Exposure to Radiofrequency Electromagnetic Energy in the Frequency Range from 3 kHz to 300 GHz”, June 2015

- [7] Canada RSS-102, “Radio Frequency (RF) Exposure Compliance of Radiocommunication Apparatus (All Frequency Bands)”, Issue 5, March 2015,
- [8] US FCC 47CFR 1.1310 “Radiofrequency radiation exposure limits”, August 1997.
- [9] US FCC OET Bulletin 65, “Evaluating Compliance with FCC Guidelines for Human Exposure to Radiofrequency Electromagnetic Fields and its supplements”, edition 97-01, August 1997.

## 2.2 Product and assessment method

- [10] Nokia, “Massive MIMO Adaptive Antenna Product Description” DN207523773, Issue 02, 16-04-2018.
- [11] Nokia, “Pattern Test Report For AEUA Antenna”, (under preparation) xx-2018.
- [12] Microwave Vision Group (MVG), “EMF Visual Version 3.03 User Manual”, EMF/11 - 01.135/A – v3.
- [13] Z. Altman, B. Begasse, C. Dale, A. Karwowski, J. Wiart, M. Wong and L. Gattoufi, “Efficient models for base station antennas for human exposure assessment”, IEEE Trans. Electromagnetic Compatibility, Nov 2002, vol.44, pp. 588-592.
- [14] P. Baracca, A. Weber, T. Wild and C. Grangeat, “A Statistical Approach for RF Exposure Compliance Boundary Assessment in Massive MIMO Systems”, WSA 2018, <https://arxiv.org/abs/1801.08351>.
- [15] IEC TR62669, “Case studies supporting the implementation of IEC 62232”, (106/463/CD, July 2018).

## 3 RF exposure limits

The applicable RF exposure limits are defined by [1] and [2] to in Europe and ICNIRP countries, by [6] in Canada and by [6] in the US and related countries such as Bolivia, Estonia, Mexico and Panama. The applicable power density limits are recalled in Table 1 for the frequency range applicable to the equipment under test.

**Table 1 – Applicable RF exposure levels at 28 GHz expressed in power density**

Region of application	General Population /Uncontrolled Exposures	Occupational /Controlled Exposures
EU/ICNIRP, US/related, Canada	10 W/m <sup>2</sup>	50 W/m <sup>2</sup>

## 4 Description of the equipment under test (EUT)

The main technical characteristics of AEUA/AEUF products are shown in Table 2 and Table 3.

**Table 2 – AEUA/AEUF products general technical characteristics**

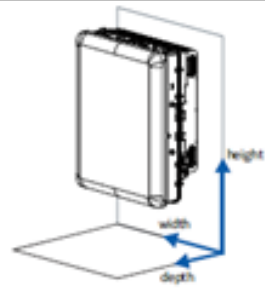
Product name	Nokia AirScale MAA 2T2R 512 AE 8W n257 AEUA/AEUF	
Model number	474214A	
Rated max Tx power	1.26 W (31 dBm)	
Number of TXRX	2TX2RX	
Beamforming	Yes	
SW supported techno.	TD-LTE	
Frequency range	26.5 – 29.5 GHz (3GPP Band n257)	
Nb of antenna elements	16 (horizontal) x 16 (vertical)	
Distance between AE	5.1 mm (horizontal) x 7.7 mm (vertical)	
Gain	29 dBi	
EIRP	60 dBm	
Beam steering range	$\pm 45^\circ$ (horizontal @3 dB) and $\pm 11.25^\circ$ (vertical 1.5 dB)	
Dimensions	Height: 522 mm Depth: 304 mm Width: 161 mm Note: includes front covers. With optional fans.	
Technology duty cycle factor	75 %	
Transmitted power tolerance	1.5 dB	

AEUF is the DC version of AEUA. The relevant RF characteristics are the same.

Table 3 – Measured antenna gain characteristics for various beam steering directions  
(from datasheet until [11] is available)

Azimuth	Elevation	Gain (dBi)		
		26.5 GHz	28 GHz	29.5 GHz
<b>0°</b>	<b>0°</b>	<b>29.00</b>	29.00	29.00
0°	-11°	27.50	27.50	27.50
<b>45°</b>	<b>0°</b>	<b>26.00</b>	26.00	<b>26.00</b>
45°	-11°	24.50	24.50	24.50

In order to provide a conservative assessment on the frequency range, we performed the calculation at the central frequency (i.e. 28 GHz) scaled to the maximum gain over the whole frequency band (indicated in bold letters in Table 3). The compliance boundary is defined by the box shape perimeter shown in Figure 4 of IEC/EN 62232:2017 [4] and displayed in Figure 1. The distances  $D_f$ ,  $D_s$ ,  $D_{a,u}$  and  $D_{a,d}$  are taken from the nearest point of the antenna. For convenience, the distances  $D_{sc}$ ,  $D_{uc}$  and  $D_{dc}$  (respectively) taken from antenna center are also provided. For low power conditions, the applicable standard is IEC/EN 62479 [5].

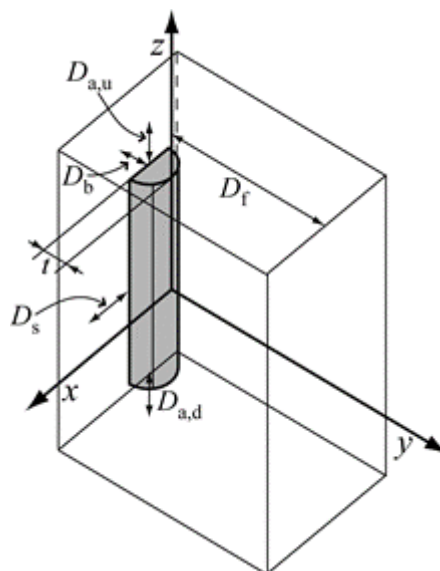

Figure 1 – Shape of the compliance boundary used for the RF exposure compliance assessment (from [4]).

## 5 RF exposure assessment method

RF exposure assessment is performed using the synthetic model computation method defined in B.4.4.1 of IEC 62232:2017 [4]. Calculations are performed with the “EMF Visual” software release 3.03 (see [12] and [13]).

The validation of the model is performed in the configuration with the beam in front (azimuth = 0° and elevation = 0°). The validation results are provided in Table 4.

**Table 4 – Validation of the antenna model at 28 GHz**

	Product (from [11]*)	Model	Deviation
Gain	29 dBi	29 dBi	0
Horizontal half-power beamwidth	6.5°	7°	0.5°
Vertical half-power beamwidth	4.5°	5°	0.5°

\* Note: From datasheet until [11] is available.

For each configuration, the directivity pattern is derived from the simulation model and the antenna gain is adjusted to match exactly the measured values for accurate scaling.

The RF compliance distances are provided for the time-averaged maximum transmitted power of 1.33 W and, for information, the time-averaged actual maximum transmitted power of 0.33 W taking a 95<sup>th</sup> percentile approach as defined in [4], [14] and [15]. These values include a technology duty cycle factor of 75 % (see Table 2) for time averaging and a power tolerance of 1.5 dB due to electronic component dispersion and operational environmental conditions (temperature).

## 6 RF exposure computation results

The computed power density distributions are displayed in Figure 2 to Figure 7 for RF exposure limits defined in [1] and [2] for EU/ICNIRP countries, in [6] for Canada and [8] for US/related countries.



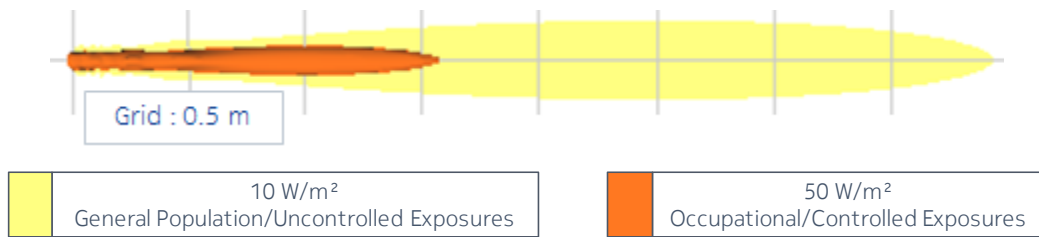

Figure 2 – Top view of the power density for the time-averaged maximum transmitted power of 1.33 W and the beam oriented in azimuth = 0° & elevation = 0°

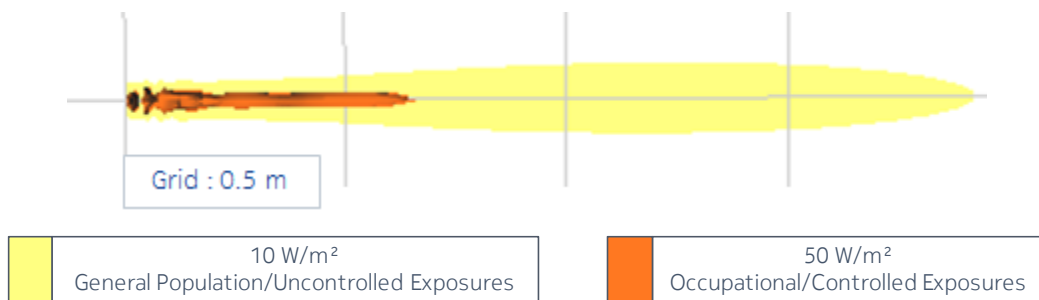

Figure 3 – Top view of the power density for the time-averaged actual maximum transmitted power of 0.33 W and the beam oriented in azimuth = 0° & elevation = 0°

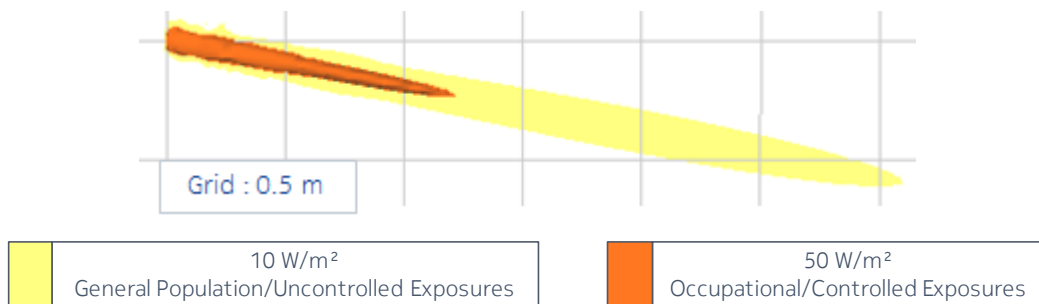

Figure 4 – Side view of the power density for the time-averaged maximum transmitted power of 1.33 W and the beam oriented in azimuth = 0° & elevation = -11°

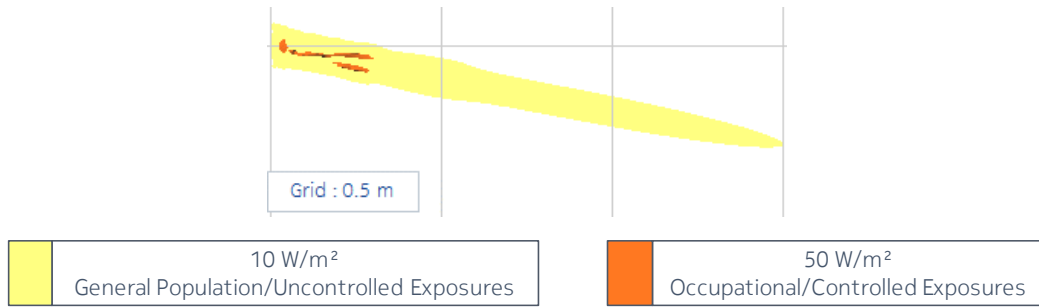

Figure 5 – Side view of the power density for the time-averaged actual maximum transmitted power of 0.33 W and the beam oriented in azimuth = 0° & elevation = -11°

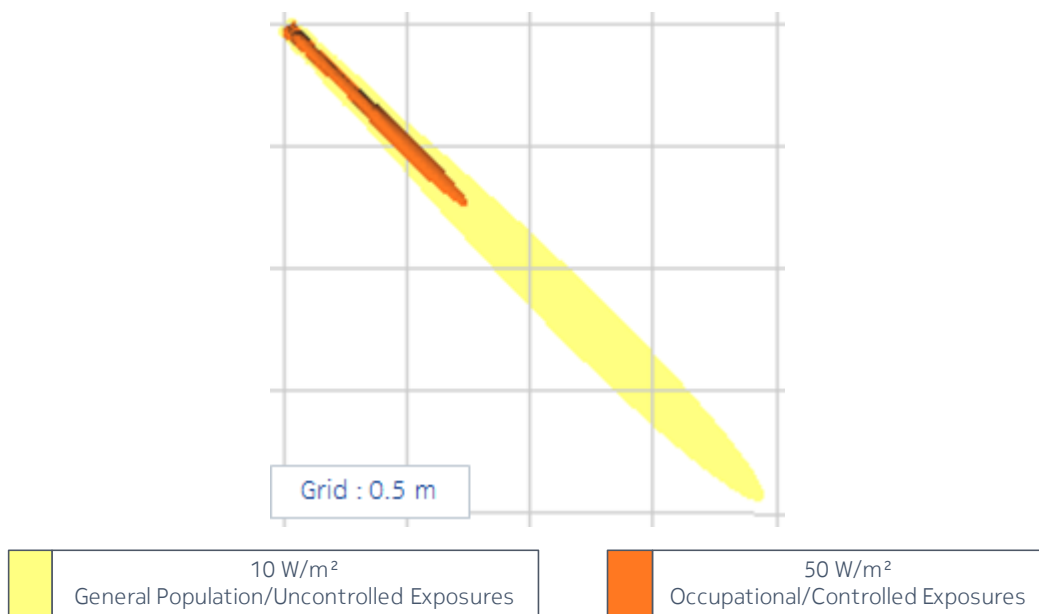

Figure 6 – Top view of the power density for the time-averaged maximum transmitted power of 1.33 W and the beam oriented in azimuth = 45° & elevation = 0°

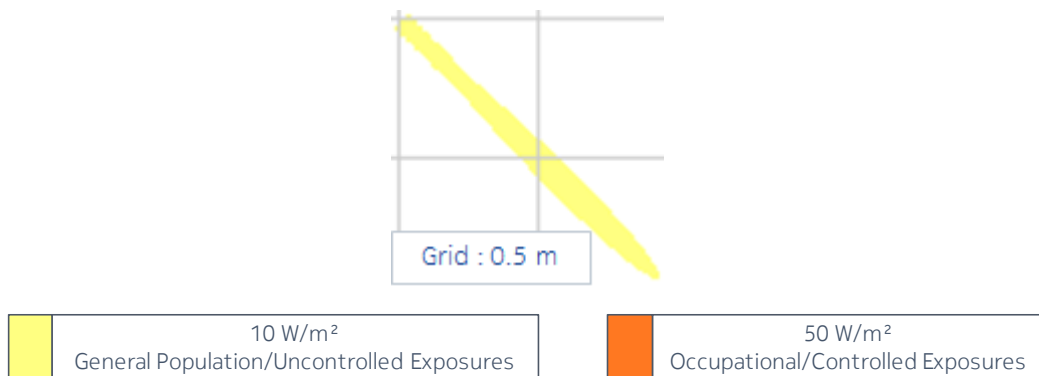

Figure 7 – Top view of the power density for the time-averaged actual maximum transmitted power of 0.33 W and the beam oriented in azimuth = 45° & elevation = 0°

## 7 Conclusion and installation recommendations

The RF exposure compliance distances for the Nokia AirScale MAA 2T2R 512 AE 8W n257 AEUA/AUEF products according to EU/ICNIRP [1][2], Canada [6] and US/related [8] requirements are summarized in Table 5.

**Table 5 – AEUA/AEUF RF exposure compliance distances based on the time-averaged maximum transmitted power of 1.33 W (corresponding to 1.26 W rated max transmitted power)**

Region of application: EU/ICNIRP, Canada and US/related	General Population/Uncontrolled Exposures	Occupational/Controlled Exposures
Power density exposure limits	10 W/m <sup>2</sup>	50 W/m <sup>2</sup>
Distance in front (Df)	2.9 m	1.2 m
Distance to the side (Ds)	1.4 m	0.5 m
Distance below and above (Da,d and Da,u)	0.3 m	0 m
Distance to the side (Dsc)	1.5 m	0.6 m
Distance below and above (Ddc and Duc)	0.5 m	0.2 m

The AEUA/AEUF RF exposure compliance distances based on the actual maximum transmitted power considering a 95<sup>th</sup> percentile approach are summarized in Table 6. These values are provided for information about the RF exposure levels that may be reached in operational conditions considering a time-averaging window of 6 minutes according to [4], [14] and [15].

Table 6 – AEUA/AUEF RF exposure compliance distances based on the time-averaged actual maximum transmitted power of 0.33 W (corresponding to 1.26 W rated max transmitted power)

For information based on IEC/EN 62232:2017 [4] and IEC TR62669 [15]	General Population/Uncontrolled Exposures	Occupational/Controlled Exposures
Power density exposure limits	10 W/m <sup>2</sup>	50 W/m <sup>2</sup>
Distance in front (Df)	1.4 m	0.3* m
Distance to the side (Ds)	0.5 m	0 m
Distance below and above (Da,d and Da,u)	0 m	0 m
Distance to the side (Dsc)	0.6 m	0 m
Distance below and above (Ddc and Duc)	0.2 m	0 m

\*Note: Since the Tx power is below 100 mW, this distance is zero in Europe/ICNIRP countries according to IEC/EN62479:2010.

Installation of the Nokia AirScale MAA 2T2R 512 AE 8W n257 AEUA/AEUF products shall be performed in accordance with all applicable manufacturer's recommendations and national laws and regulations related to human exposure to radiofrequency fields.

In particular:

- The operator or entity putting the equipment into service shall take the necessary measures to ensure that the general population cannot access the area within the general population/uncontrolled compliance boundary in the vicinity of the transmitting antennas (see Table 5).
- Depending on the site installation configuration, the operator or the entity putting the equipment into service determines the most suitable place to display the appropriate warning signs and any other necessary information or precautionary measures.
- Workers that are required to operate in the close proximity of the transmitting antennas connected to the equipment, for example installation and maintenance personnel, need to be informed about the potential risks of human exposure to RF fields and how to protect against them. They should strictly follow instructions provided by their employer. They should stand-off the occupational/controlled exposure compliance boundary defined in the vicinity of transmitting antennas (see Table 5). If it is necessary to operate within this compliance boundary, workers shall make sure that the transmitters contributing to exposure in this area are all switched off, or they must contact the relevant operator(s) to switch off emissions during operation period.

---- end to the test report -----