

Global Product Compliance Laboratory
600-700 Mountain Avenue
Room 5B-108
Murray Hill, New Jersey 07974-0636 USA

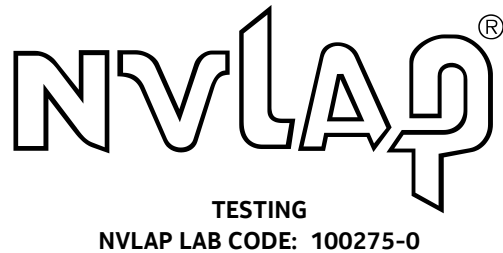

Title 47 Code of Federal Regulations Test Report

Regulation:
FCC Part 2 and 27

Client:
NOKIA SOLUTIONS AND NETWORKS

Product Evaluated:
AirScale MAA 64T64R 192AE n78 200W AEQU

Report Number:
TR-2022-0086-FCC2-27

Date Issued:
August 18, 2022

This report shall not be reproduced, in whole or in part without the approval of Nokia Global Product Compliance Laboratory. This report must not be used by the recipient to claim product certification, approval, or endorsement by NVLAP, NIST, or any agency of the U.S. Government.

Table of Contents

- 1. SYSTEM INFORMATION AND REQUIREMENTS..... 4**
 - 1.1 INTRODUCTION 5
 - 1.2 PURPOSE AND SCOPE..... 5
 - 1.3 EUT DETAILS..... 6
 - 1.4 TEST REQUIREMENTS 7
 - 1.5 TEST STANDARDS & MEASUREMENT PROCEDURES 7
 - 1.6 EXECUTIVE SUMMARY 8
 - 1.7 TEST CONFIGURATION FOR ALL ANTENNA PORT MEASUREMENTS. 9
- 2. FCC SECTION 2.1046 - RF POWER OUTPUT 11**
 - 2.1 RF POWER OUTPUT 11
 - 2.2 CHANNEL RF POWER – PLOTS 13
 - 2.3 PEAK-TO-AVERAGE POWER RATIO (PAPR) – PLOTS..... 16
- 3. FCC SECTION 2.1047 - MODULATION CHARACTERISTICS 18**
 - 3.1 MODULATION CHARACTERISTICS..... 18
- 4. FCC SECTION 2.1049 – OCCUPIED BANDWIDTH/EDGE OF BAND EMISSIONS..... 20**
 - 4.1 OCCUPIED BANDWIDTH 20
 - 4.2 OCCUPIED BANDWIDTH – PLOTS..... 21
 - 4.3 EDGE OF BAND EMISSIONS 22
- 5. FCC SECTION 2.1051 - SPURIOUS EMISSIONS AT TRANSMIT ANTENNA PORT..... 26**
 - 5.1 MEASUREMENT OF SPURIOUS EMISSIONS AT TRANSMIT ANTENNA PORT 26
- 6. FCC SECTION 2.1053 - FIELD STRENGTH OF SPURIOUS RADIATION 33**
 - 6.1 SPURIOUS RADIATION AND RADIATED EMISSIONS REQUIREMENTS. 33
 - 6.2 FIELD STRENGTH OF SPURIOUS RADIATION RESULTS:..... 34
 - 6.3 TRANSMITTER MEASUREMENTS OF RADIATED SPURIOUS EMISSIONS PLOTS 35
- 7. FCC SECTION 2.1055 - MEASUREMENT OF FREQUENCY STABILITY..... 52**
- 8. NVLAP CERTIFICATE OF ACCREDITATION 63**

Revisions

Date	Revision	Section	Change
08/18/2022	0		Initial Release

Nokia Global Product Compliance Laboratories is accredited by the National Voluntary Laboratory Accreditation Program (NVLAP®) for specific services, listed on the Scope of Accreditation, for: Electromagnetic Compatibility and Telecommunications. This laboratory is accredited in accordance with the recognized International Standard ISO/IEC 17025:2017. This accreditation demonstrates technical competence for a defined scope and the operation of a laboratory quality management system (refer to joint ISO-ILAC-IAF Communiqué dated January 2009). NVLAP LAB CODE: 100275-0.

Nokia Global Product Compliance Laboratory represents to the client that the laboratory's accreditation or any of its calibration or test reports in no way constitutes or implies product certification, approval, or endorsement by NVLAP, NIST, or any agency of the U.S. Government.

Prepared By:



Signed: _____ 08/18/2022

Ann Chang
Compliance Engineer
NVLAP Signatory
ann.chang@nokia-bell-labs.com

Approved By:



Signed: _____ 08/18/2022

Raymond Johnson
Technical Manager
NVLAP Signatory
ray.johnson@nokia-bell-labs.com

Reviewed By:



Signed: _____ 08/18/2022

Steve Gordon
EMC Engineer
NVLAP Signatory
steve.gordon@nokia-bell-labs.com

1. System Information and Requirements

Report copies and other information not contained in this report are held by either the product engineer or in an identified file at the Global Product Compliance Laboratory in Murray-Hill, NJ.

Equipment Under Test (EUT):	AirScale MAA 64T64R 192AE n78 200W AEQU
Serial Number:	1M22400009 (Radio) / 1M222400008 (Frequency Stability)
FCC ID:	VBNAEQU-01
Hardware Version:	093263A.203
Software Version:	SBTS22R4
Frequency Range:	3450 – 3550 MHz
GPCL Project Number:	2022-0086
Manufacturer:	NOKIA SOLUTIONS AND NETWORKS OY KARAKAARI 7, FI-02610 ESPOO FINLAND
Test Requirement(s):	Title 47 CFR Parts 2 and 27
Test Standards:	See Section 1.5.1
Measurement Procedure(s):	See Section 1.5.2
Test Date(s):	7/19/2022 - 8/2/2022
Test Performed By:	Nokia Global Product Compliance Laboratory 600-700 Mountain Ave. P.O. Box 636 Murray Hill, NJ 07974-0636 Test Site Number: US5302
Product Engineer(s):	Ron Remy
Lead Engineer:	Steve Gordon
Test Engineer (s):	Joe Bordonaro, Jaideep Yadav, Mike Soli, Greg Manuel
Test Results:	The EUT, <i>as tested</i> met the above listed Test Requirements. The decision rule employed is binary (Pass/Fail) based on the measured values without accounting for Measurement Uncertainty or any Guard Band. The measured values obtained during testing were compared to a value given in the referenced regulation or normative standard. Report copies and other information not contained in this report are held by either the product engineer or in an identified file at the Global Product Compliance Laboratory in New Providence, NJ.

1.1 Introduction

This Conformity test report applies to the **AirScale MAA 64T64R 192AE n78 200W AEQU**, hereinafter referred to as the Equipment Under Test (EUT).

1.2 Purpose and Scope

The purpose of this document is to provide the testing data required for qualifying the EUT in compliance with FCC Parts 2 and 27 measured in accordance with the procedures set out in Section 2.1033 (c) (14) of the Rules.

The original filing for this product was documented in GPCL project 2020-0155 for FCC ID: VBNAEQU-01 which includes 20 MHz at 200 W, 30 MHz at 200 W, and 40 MHz at 200 W in the 5G-NR and LTE-TDD mode of operation in the frequency range of 3450 – 3550 MHz.

This Class II Change is due to an alternate component change. The new components have the same basic function as the old components and only a small area of the PCB has been changed to accommodate the new chip. Two single carrier configurations (20 and 40 MHz) were tested.

1.3 EUT Details

1.3.1 Specifications

Specification Items	Description
Radio Access Technology	5G-NR, LTE
Duplex Mode	Time Division Duplex (TDD)
Modulation Type(s)	QPSK, 16QAM, 64QAM, 256QAM, QPSK/16QAM
Operation Frequency Range	3450 – 3550 MHz
Channel Bandwidth	20, 30, 40 MHz
Number of Tx Ports per Unit	64
MIMO	Yes
Deployment Environment	Outdoor
Supply Voltage	-48.0 VDC

1.3.2 Photographs

Radio / RE



Serial Number

Frequency Stability



1.4 Test Requirements

Each required measurement is listed below:

47 CFR FCC Sections	Description of Tests	Test Required
2.1046, 27.53	RF Power Output	Yes
2.1047, 27.53	Modulation Characteristics	Yes
2.1049, 27.53	(a) Occupied Bandwidth (b) Out-of-Band Emissions	Yes
2.1051, 27.53	Spurious Emissions at Antenna Terminals	Yes
2.1053, 27.53	Field Strength of Spurious Radiation	Yes
2.1055, 27.53	Frequency Stability	Yes

1.5 Test Standards & Measurement Procedures

1.5.1 Test Standards

- Title 47 Code of Federal Regulations, Federal Communications Commission Part 2.
- Title 47 Code of Federal Regulations, Federal Communications Commission Part 27.
- KDB 971168 D01 Power Measurement License Digital Systems v03r01 April 9, 2018.
- KDB 662911 D01 Multiple Transmitter Output v02r01 Oct 2013.
- ANSI C63.26-2015, American National Standard for Compliance Testing of Transmitters Used in Licensed Radio Services.
- ANSI C63.4-2014, American National Standard for Methods of Measurement of Radio-Noise Emissions from Low-Voltage Electrical and Electronic Equipment in the Range of 9 kHz to 40 GHz.

1.5.2 Measurement Procedures

- FCC-IC-OB - GPCL Power Measurement, Occupied Bandwidth & Modulation Test Procedure 6-20-2019.
- FCC-IC-SE - GPCL Spurious Emissions Test Procedure 6-20-2019.
- FCC-IC-FS – GPCL Frequency Stability Measurement Process 6-20-2019.

1.5.3 MEASUREMENT UNCERTAINTY

The results of the calculations to estimate uncertainties for the several test methods and standards are shown in the Table below. These are the worst-case values.

Worst-Case Estimated Measurement Uncertainties

Standard, Method or Procedure	Condition	Frequency MHz	Expanded Uncertainty (k=2)
a. Classical Emissions, (e.g., ANSI C63.4, CISPR 11, 14, 22, etc., using ESHS 30,	Conducted Emissions	0.009 - 30	±3.5 dB
	Radiated Emissions (AR-6 Semi-Anechoic Chamber)	30 MHz – 200MHz H 30 MHz – 200 MHz V 200 MHz – 1000 MHz H 200 MHz – 1000 MHz V 1 GHz - 18 GHz	±5.1 dB ±5.1 dB ±4.7 dB ±4.7 dB ±3.3 dB

Antenna Port Test	Signal Bandwidth	Frequency Range	Expanded Uncertainty (k=2), Amplitude
Occupied Bandwidth, Edge of Band, Conducted Spurious Emissions	10 Hz	9 kHz to 20 MHz	1.78 dB
	100 Hz 10 kHz to 1 MHz 1MHz	20 MHz to 1 GHz 1 GHz to 10 GHz 10 GHz to 40 GHz:	
RF Power	10 Hz to 20 MHz	50 MHz to 18 GHz	0.5 dB

1.6 Executive Summary

Requirement	Description	Result
47 CFR FCC Parts 2 and 27		
2.1046, 27.53	RF Power Output Peak to Average Power Ratio	COMPLIES
2.1047, 27.53	Modulation Characteristics	COMPLIES
2.1049, 27.53	(a) Occupied Bandwidth (b) Edge of Band Emissions	COMPLIES
2.1051, 27.53	Spurious Emissions at Antenna Terminals	COMPLIES
2.1053, 27.53	Field Strength of Spurious Radiation	COMPLIES
2.1055, 27.53	Frequency Stability	COMPLIES

1. **COMPLIES** - Passed all applicable tests.
2. **N/A** – Not Applicable.
3. **NT** – Not Tested.

1.7 Test Configuration for all Antenna Port Measurements.

Test Setup for Antenna Port Measurements

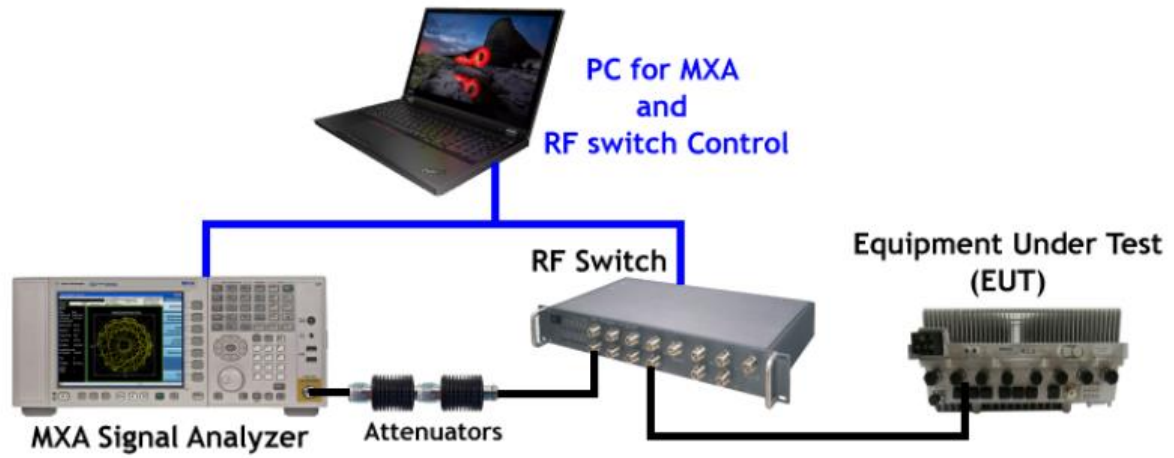

Frequency Stability Setup

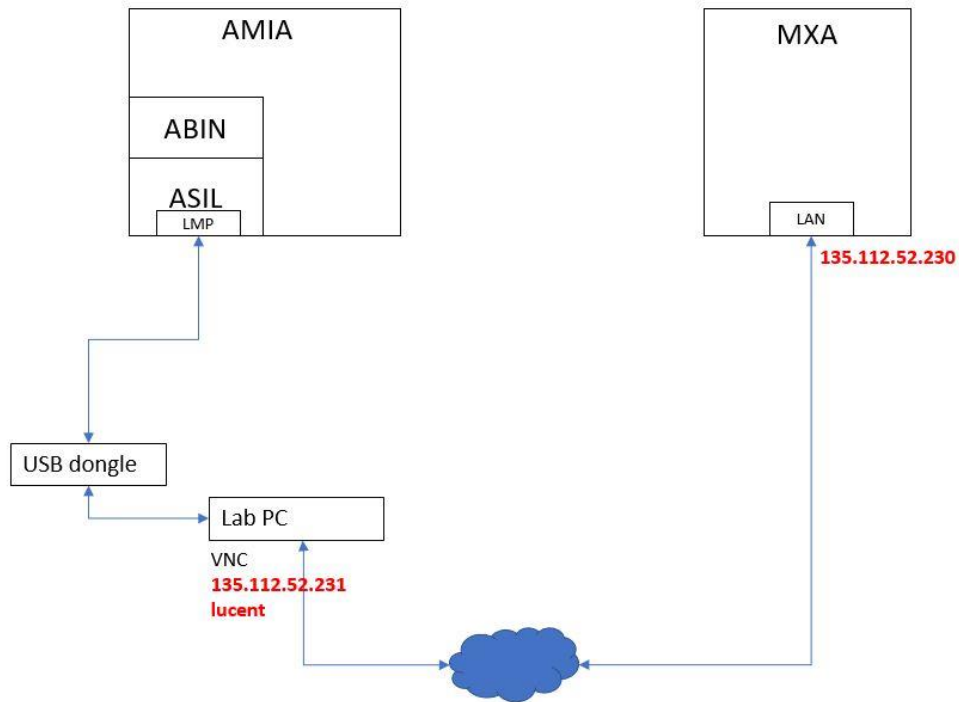
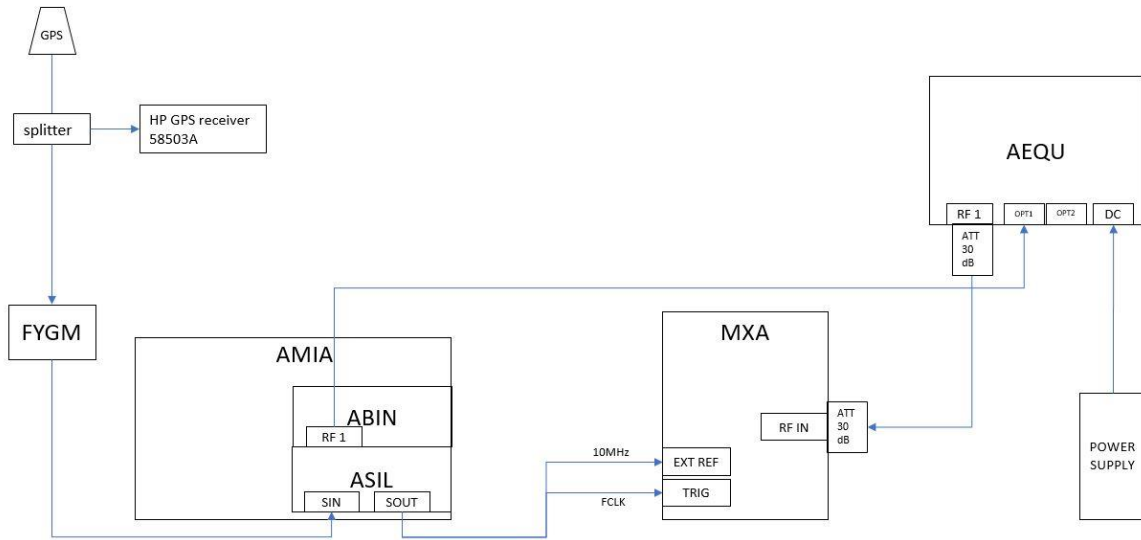

2. FCC Section 2.1046 - RF Power Output

2.1 RF Power Output

This test is a measurement of the total RF power level transmitted at the antenna-transmitting terminal. The product was configured for test as shown in section above and allowed to warm up and stabilize per KDB 971168 D01 and ANSI C63.26. All 64 ports were measured, converted to W, and summed to determine total conducted power. Power measurements were made with an MXA Signal Analyzer.

Per FCC 27.50(k)(2), the power of each fixed or base station transmitting in the 3450 - 3550 MHz band is limited to an EIRP of 1640 W/MHz, i.e., 62.15 dBm/MHz EIRP. With 24.5 dBi antenna gain, the total conducted Power Spectral Density limit is 38 dBm/MHz per 64 ports (per polarization). See Summary of PSD Results Table below.

The Average Max RF Power Values are bolded in each configuration.

Summary of PSD Results – calculated using channel power

Channel Bandwidth	Maximum Channel Power (dBm)	Correction for 64 Ports	Conversion Power/MHz	Maximum PSD	PSD Limit	Margin
		(10 Log n)		(dBm)/ MHz	(dBm/MHz)	(dBm/MHz)
20	32.53	18.06	-13.01	37.58	38	0.42
40	35.59	18.06	-16.02	37.63	38	0.37

Manufacturer tolerance: ± 1 dB

Tabular Data – Channel RF Power

Channel Power - 20MHz					
Test Model 3.1 Modulation 64QAM Channel Frequency 3460.005MHz		Test Model 3.2 Modulation QPSK/16QAM Channel Frequency 3500.01MHz		Test Model 3.1a Modulation 256QAM Channel Frequency 3540MHz	
TX Port	(dBm)	TX Port	(dBm)	TX Port	(dBm)
8	32.46	8	32.34	1	31.94
9	32.23	9	31.90	2	31.73
10	32.36	10	32.08	3	31.89
11	32.04	11	32.08	4	31.65
12	32.34	12	32.08	9	31.81
13	32.53	13	31.98	10	31.91
14	31.96	14	31.98	11	31.48
15	31.86	15	31.57	12	31.44

Channel Power - 40MHz					
Test Model 3.1 Modulation 64QAM Channel Frequency 3470.01MHz		Test Model 3.2 Modulation QPSK/16QAM Channel Frequency 3500.01MHz		Test Model 3.1a Modulation 256QAM Channel Frequency 3529.995MHz	
TX Port	(dBm)	TX Port	(dBm)	TX Port	(dBm)
1	35.48	1	35.08	1	35.59
2	35.21	2	34.90	2	35.33
3	35.37	3	34.98	3	35.19
4	35.14	4	34.76	4	35.38
9	35.31	9	34.94	9	35.41
10	35.37	10	35.16	10	35.50
11	35.01	11	34.64	11	35.07
12	34.91	12	34.53	12	34.96

2.2 Channel RF Power – Plots

NOTE: Only a sample of the plots are used in this report. The full suite of raw data resides at the MH, New Jersey location.

2.2.1 20 MHz BW

Test Model 3.1, Modulation 64QAM, Channel Frequency 3460.005MHz, TX13

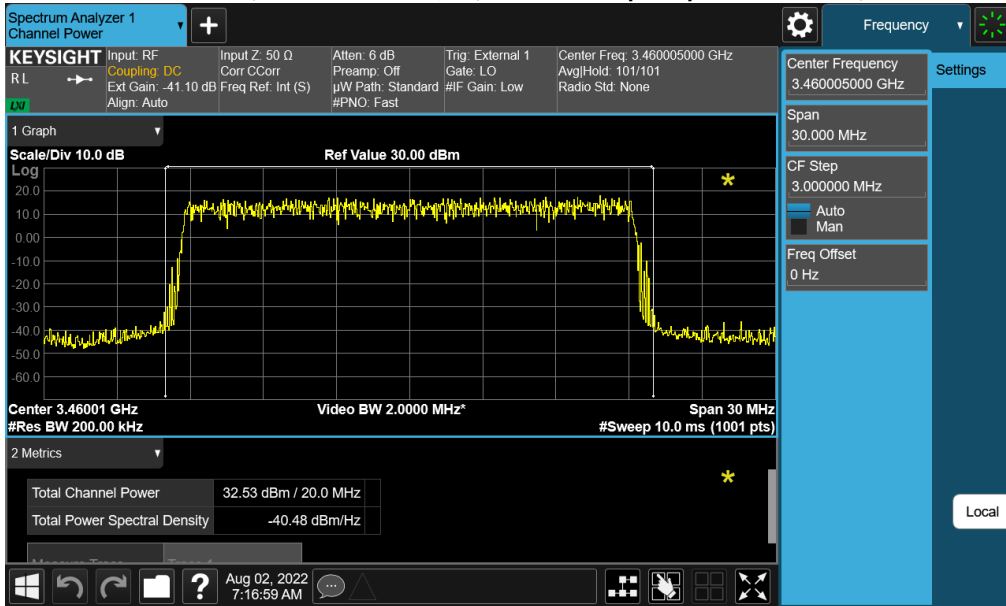

Test Model 3.2, Modulation QPSK/16QAM, Channel Frequency 3500.01MHz, TX8

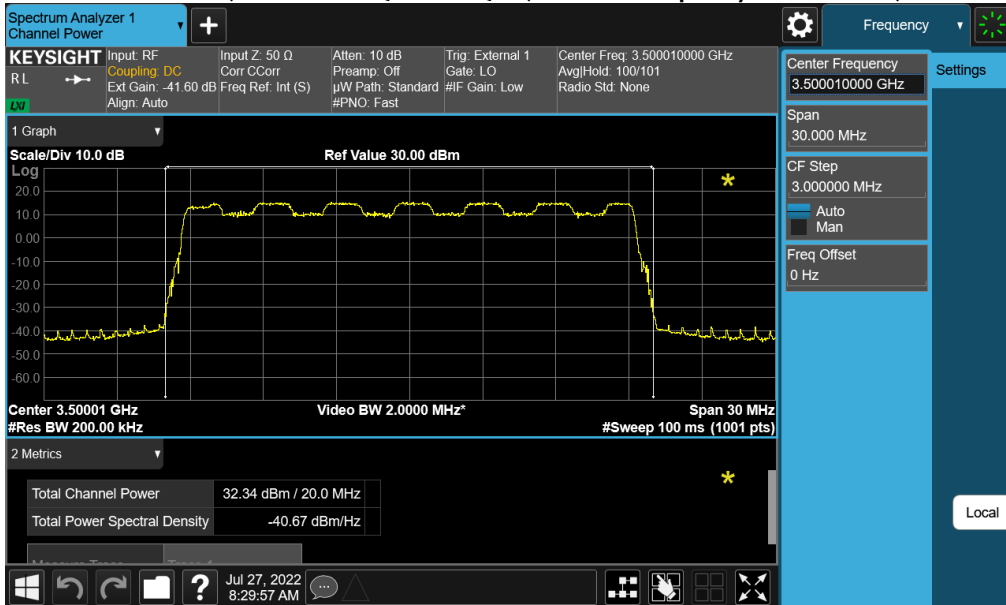

Test Model 3.1a, Modulation 256QAM, Channel Frequency 3540MHz, TX1

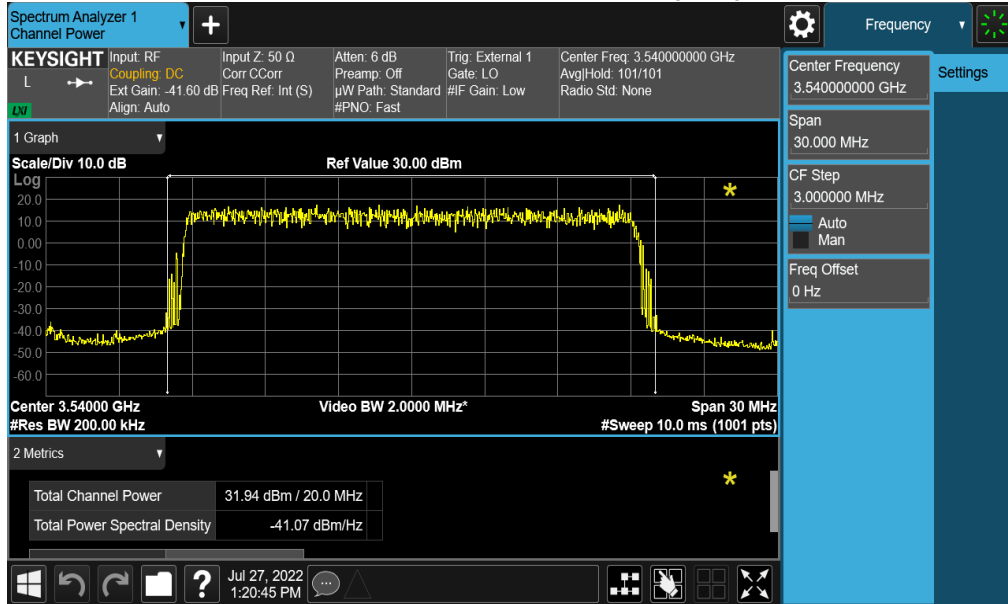

2.2.2 40 MHz BW

Test Model 3., 1Modulation 64QAM. Channel Frequency 3470.01MHz, TX1

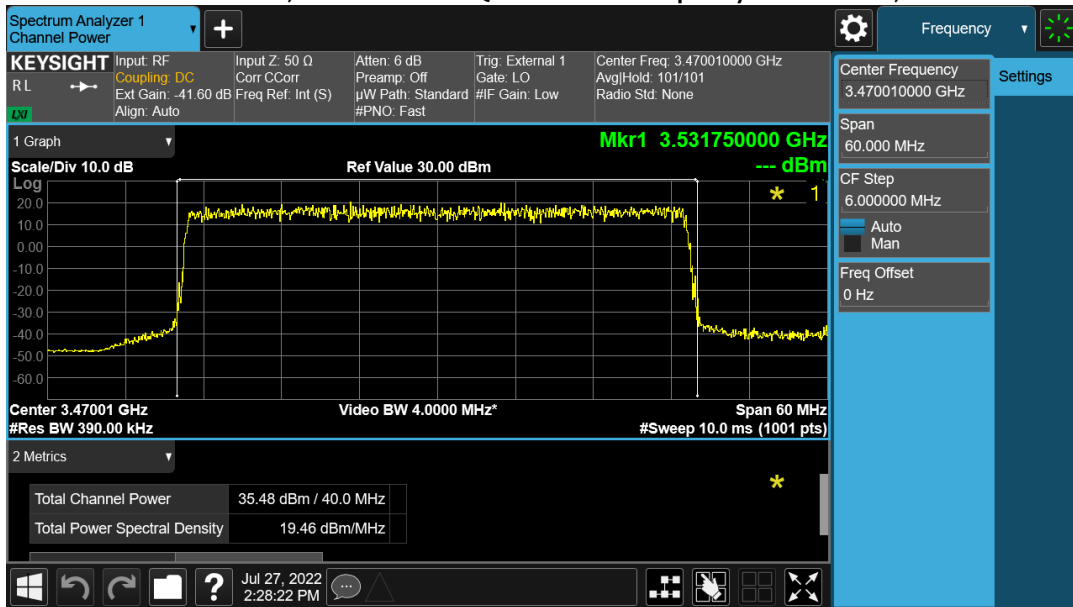

Test Model 3.2, Modulation QPSK/16QAM, Channel Frequency 3500.01MHz, TX10

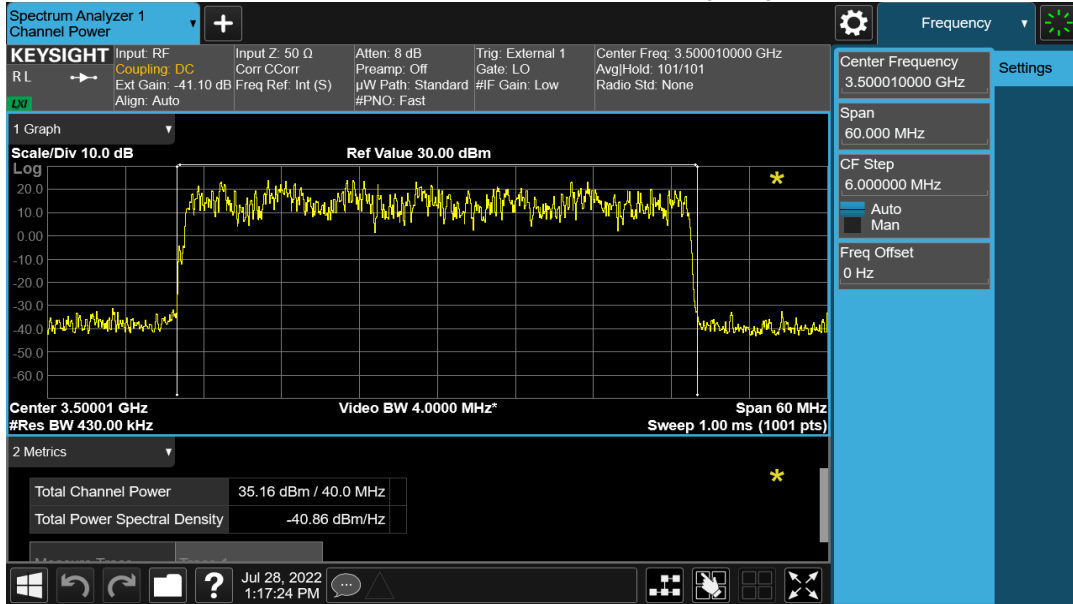

Test Model 3.1a, Modulation 256QAM, Channel Frequency 3529.995MHz, TX1

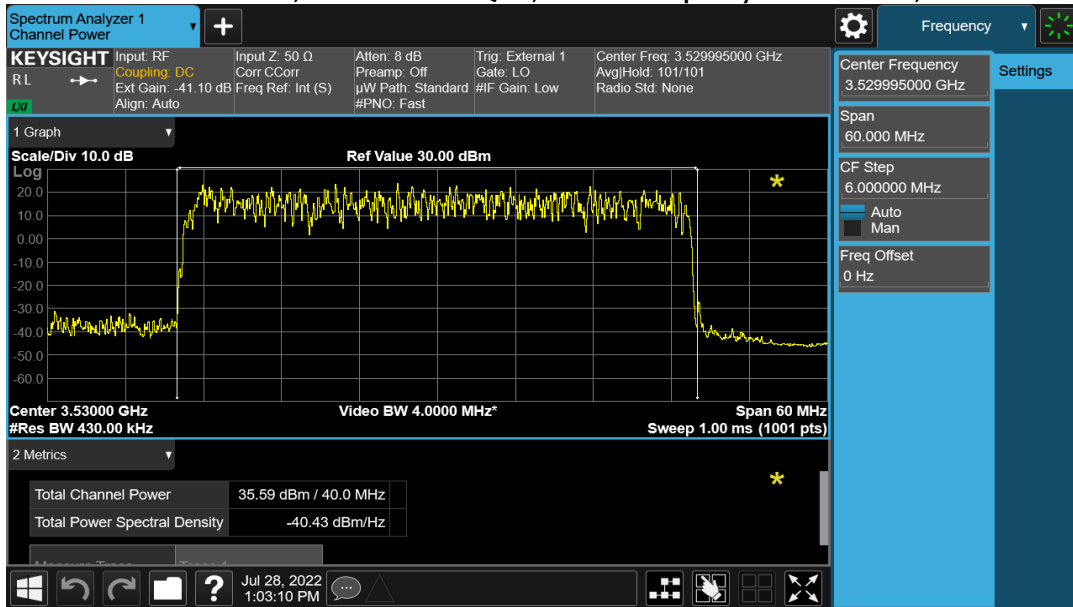

2.3 Peak-to-Average Power Ratio (PAPR) – Plots

The Peak-to-Average Power Ratio (PAPR) of the EUT was measured per KDB 971168 D01 using the Power Complementary Cumulative Distribution Function (CCDF) feature of the MXA Analyzer.

The FCC requirement for PAPR is that the transmitter’s peak-to-average power ratio (PAPR) shall not exceed 13 dB for more than 0.1% of the time using a signal corresponding to the highest PAPR during periods of continuous transmission. The maximum PAPR value for each measured configuration is given in Table below.

2.3.1 Peak-to-Average Power Ratio Results:

The maximum Peak-to-Average Power Ratio (PAPR) of the EUT measured at its antenna transmitting terminals was measured to be 8.56 dB maximum, which is in full compliance with the requirement to not exceed 13 dB as specified by the FCC.

Peak to Average Power Ratio Table

# of Carriers	Signal BW MHz	Test Model	Modulation	TX Port	Channel Frequency MHz	PAR at 0.1% Limit - 13 dB
1	20	3.1	64QAM	1	3460.005	8.59
1	20	3.2	QPSK/16QAM	1	3500.01	8.52
1	20	3.1a	256QAM	1	3540	8.61
1	40	3.1	64QAM	1	3470.01	8.01
1	40	1.1	QPSK	1	3500.01	7.94
1	40	3.1a	256QAM	1	3529.995	7.89

20 MHz BW, 3.1a, 256QAM, TX1, 3540 MHz

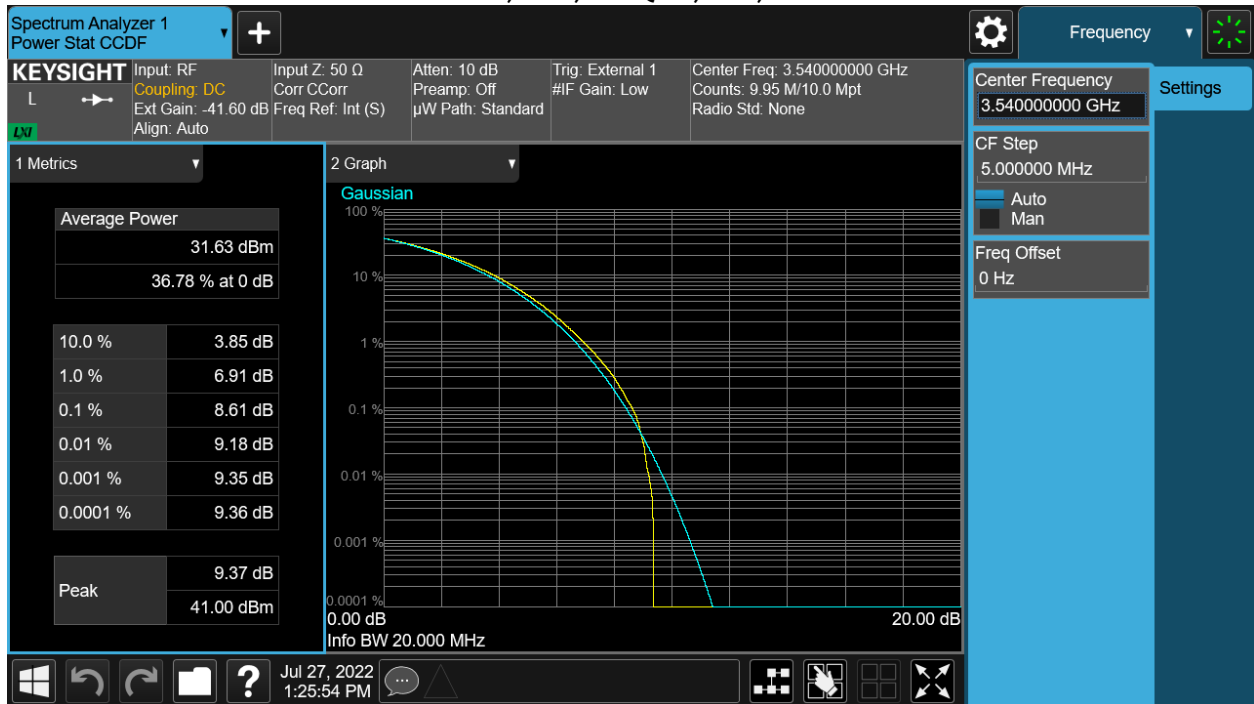

40 MHz BW, 3.1, 64QAM, TX1, 3470.01 MHz



3. FCC Section 2.1047 - Modulation Characteristics

3.1 Modulation Characteristics

The RF signal at the antenna port was demodulated and verified for correctness of the modulation signal used before each test was performed.

3.1.1 Modulation Characteristics – Plots

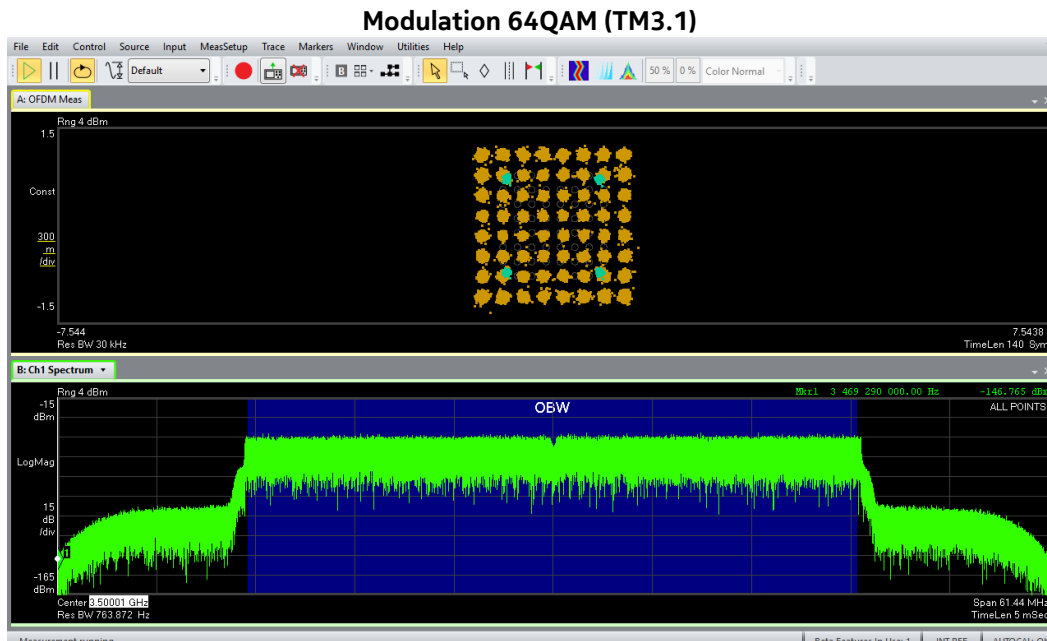
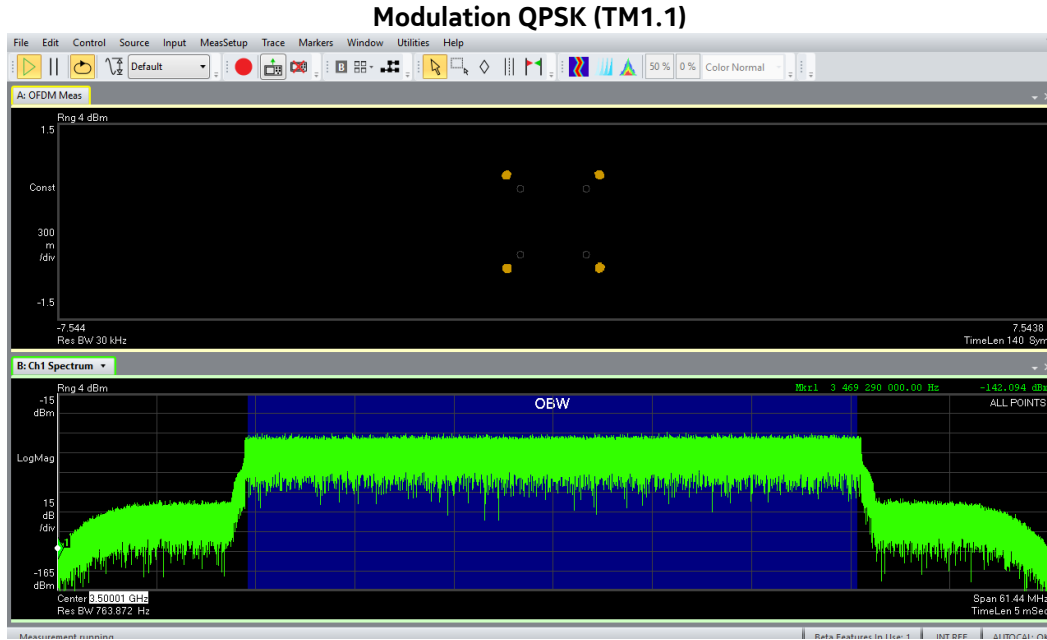

Modulation 256QAM (TM3.1a)

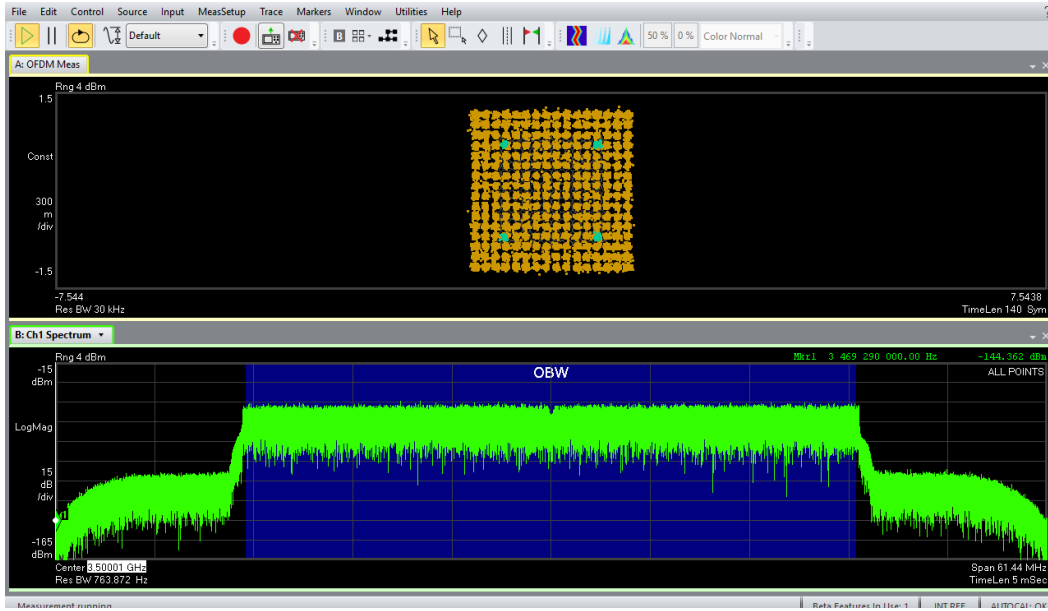

Modulation QPSK/16QAM (TM3.2)

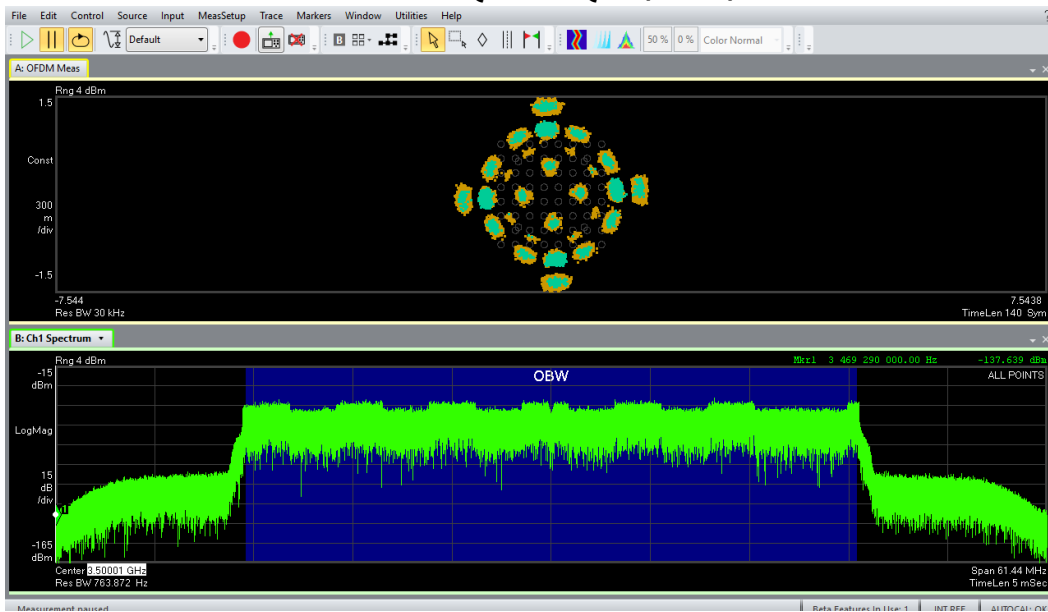

4. FCC Section 2.1049 – Occupied Bandwidth/Edge of Band Emissions

4.1 Occupied Bandwidth

In 47CFR 2.1049 the FCC requires:

“The occupied bandwidth, that is the frequency bandwidth such that, below its lower and above its upper frequency limits, the mean powers radiated are each equal to 0.5 percent of the total mean power radiated by a given emission shall be measured under the following conditions as applicable.”

This required measurement is the 99% Occupied Bandwidth, also called the designated signal bandwidth and needs to be within the parameters of the products specified emissions designator. During these measurements it is customary to evaluate the Edge of Band emissions at block/band edges.

The transmitted signal occupied bandwidth was measured using a Keysight MXA Signal Analyzer. All emissions were within the parameters as required.

Tabular Data – Occupied Bandwidth

Signal BW MHz	Test Model	Modulation	TX Port	Channel Frequency MHz	99% Occupied BW MHz
20	3.1	64QAM	1	3460.005	18.212
20	3.2	QPSK/16QAM	1	3500.01	18.031
20	3.1a	256QAM	1	3540	18.277
40	3.1	64QAM	1	3470.01	37.945
40	1.1	QPSK	1	3500.01	37.828
40	3.1a	256QAM	1	3529.995	37.959

4.2 Occupied Bandwidth – Plots

4.2.1 20 MHz BW

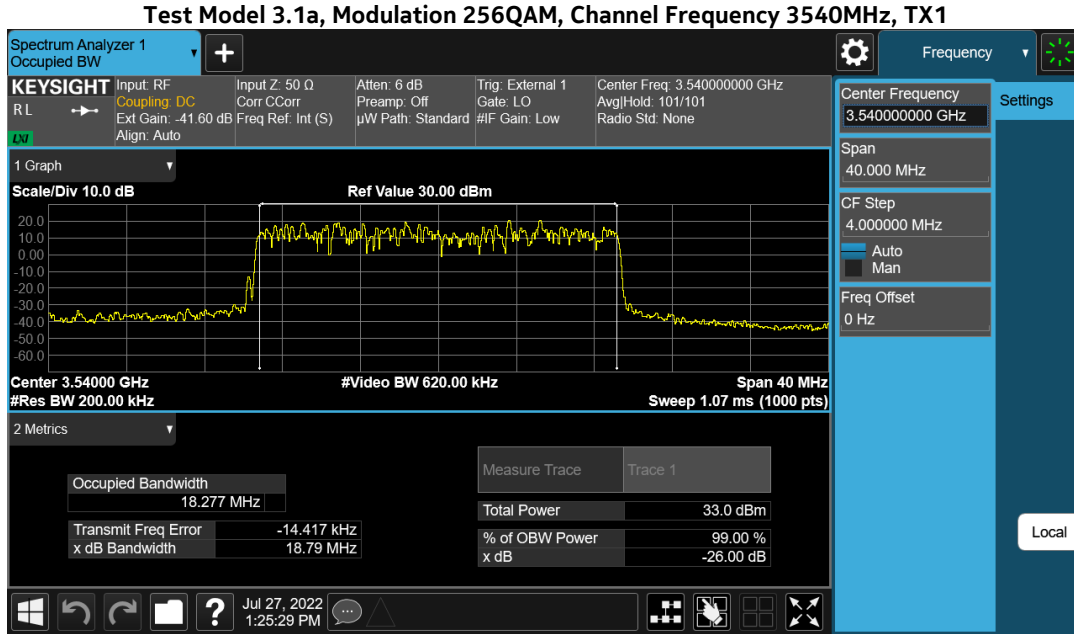

4.2.2 40 MHz BW

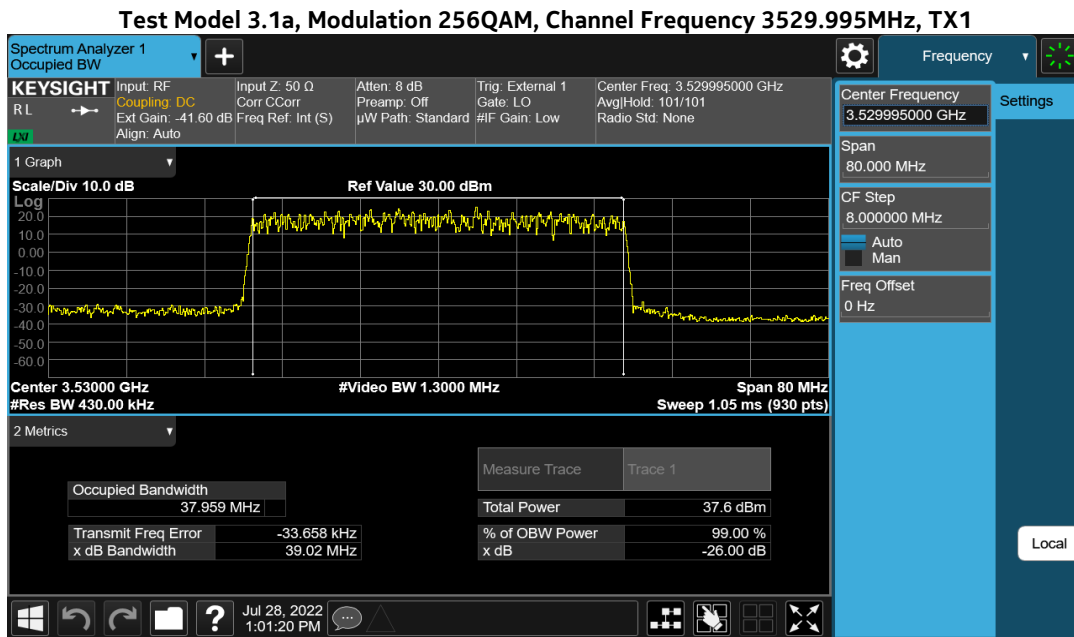

4.3 Edge of band Emissions

The Edge of Band emissions of the EUT at the TX ports were measured using a Keysight MXA Signal Analyzer. The RF power level was continuously measured using a Keysight MXA Signal Analyzer. The RF output from the TX port to signal analyzer was reduced (to an amplitude usable by the signal analyzer) by using a calibrated attenuator and RF Switch. The path attenuation was offset on the display and the signal for the carrier was adjusted to the corrected RF power level for the resolution bandwidth used for the transmit signal. All mask values were adjusted based upon the designated signal bandwidth and measurement bandwidths. The Top of Mask corresponds to the set rated power level as confirmed by the Keysight MXA Signal Analyzer.

The required emission limitation is specified as appropriate in 27.53 (n). The measured spurious emission levels were plotted for the frequency range as specified in 2.1057. For 64 ports where $10\log(64) = 18\text{dBm}$, the -13dBm limit is corrected to -31dBm and after 1 MHz above and below the band further correct to -38dBm with the RBW correction $10\log(1\text{M}/200\text{k}) = -6.99\text{dBm}$ resulting in -37.99dBm

4.3.1 Edge of Band Emissions – Plots

All of the measurements met the requirements of Part 27.53 when measured per Part 2.1049.

4.3.1.1 20 MHz BW OOB E Plots

Test Model 3.1, Modulation 64QAM, Channel Frequency 3460.005MHz, TX1

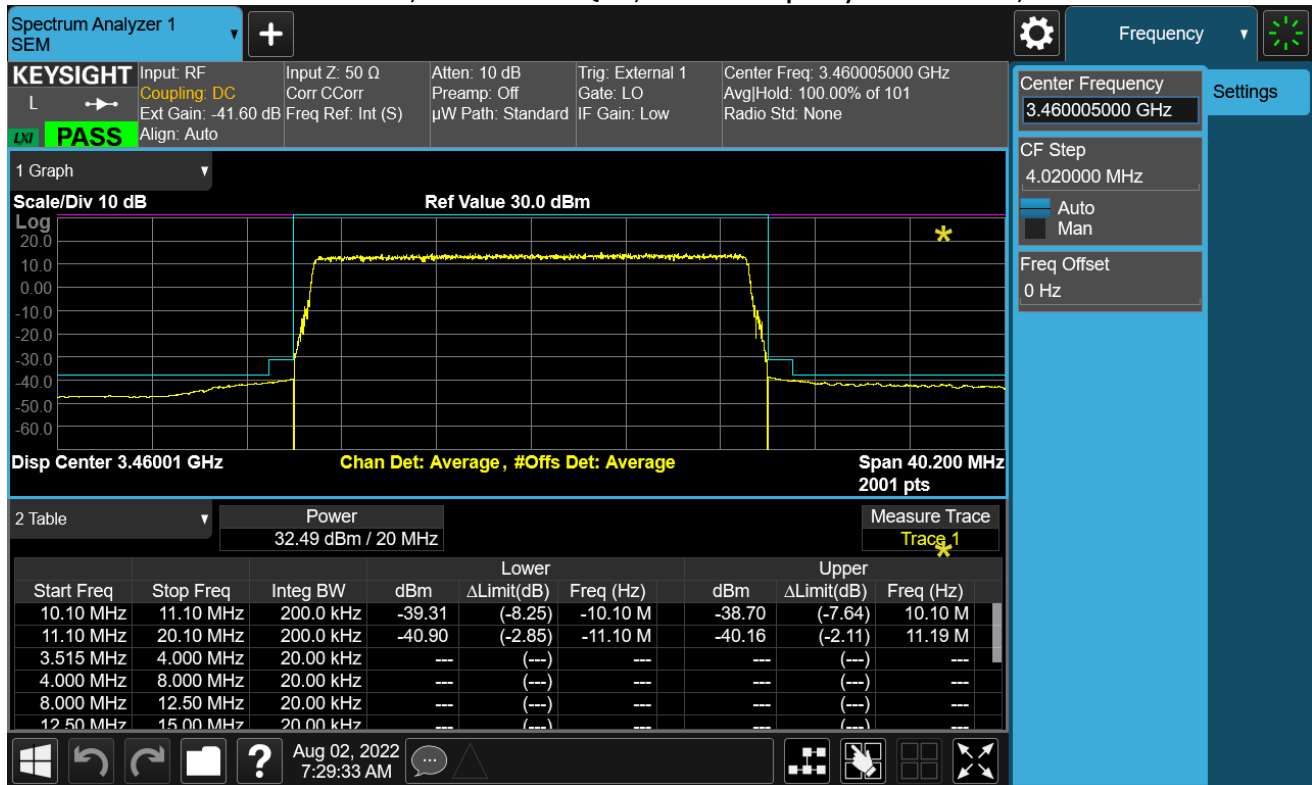

Test Model 3.2, Modulation QPSK/16QAM, Channel Frequency 3500.01MHz, TX1

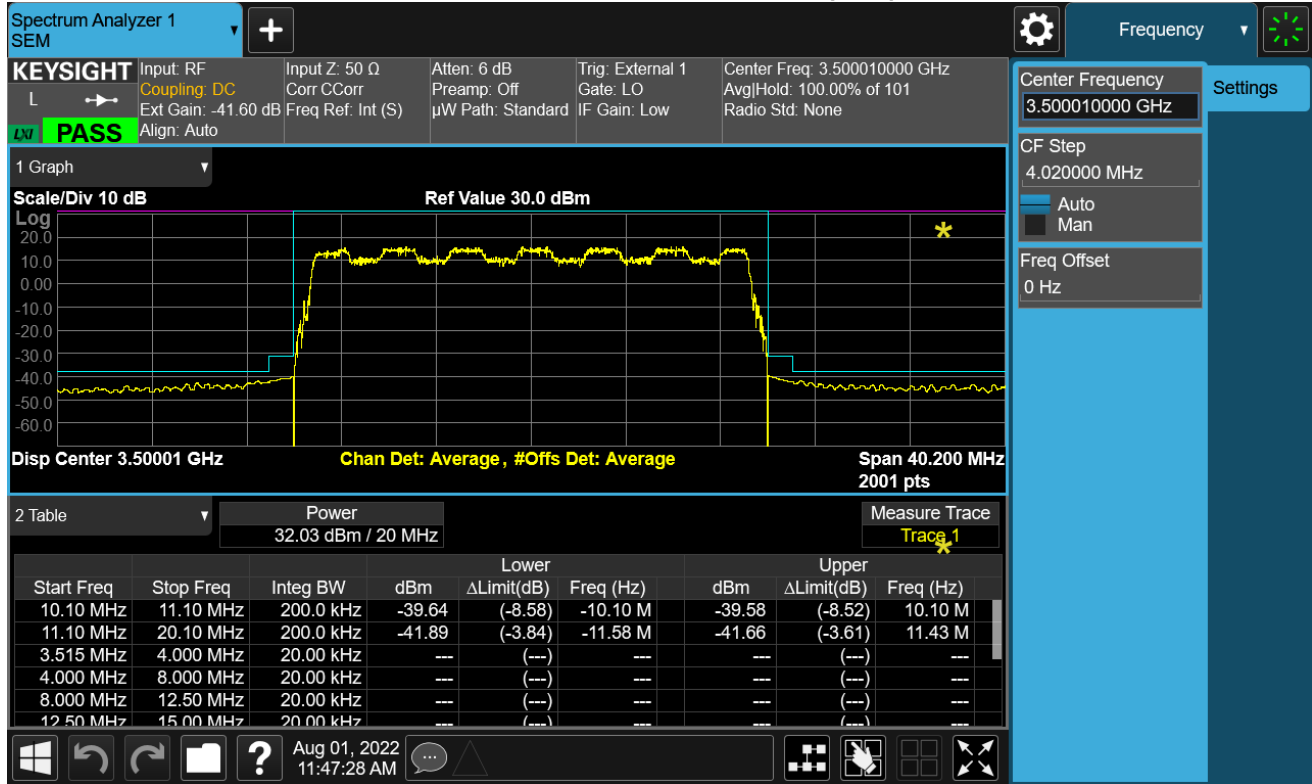

Test Model 3.1a, Modulation 256QAM, Channel Frequency 3540MHz, TX1

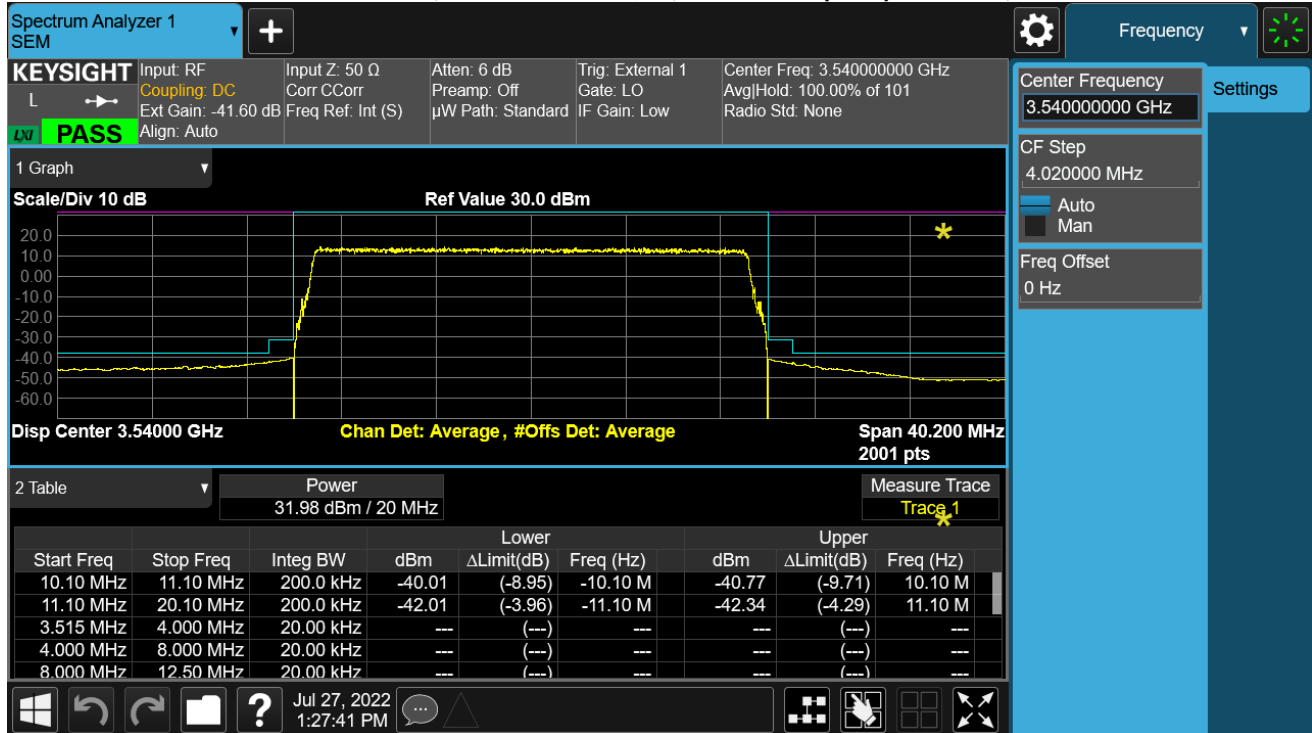

4.3.1.2 40 MHz BW OBE Plots

Test Model 3., 1Modulation 64QAM. Channel Frequency 3470.01MHz, TX1

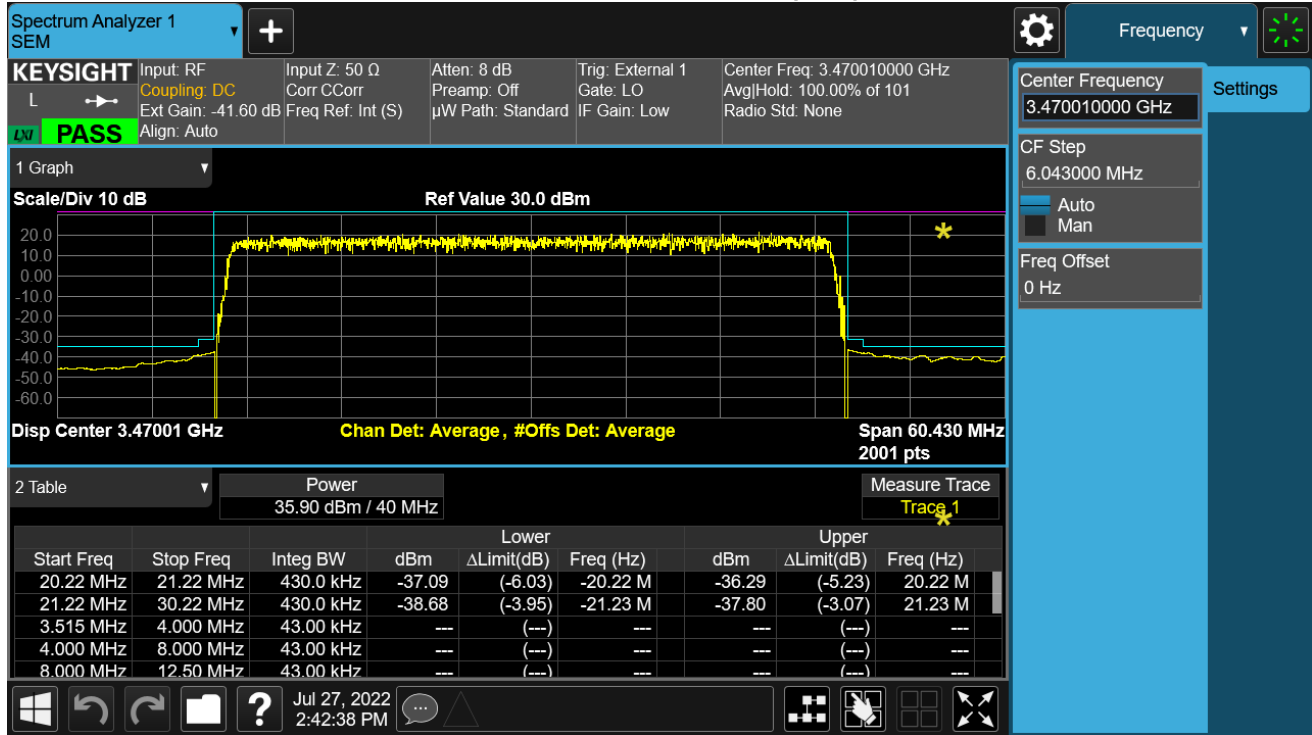

Test Model 3.2, Modulation QPSK/16QAM, Channel Frequency 3500.01MHz, TX1

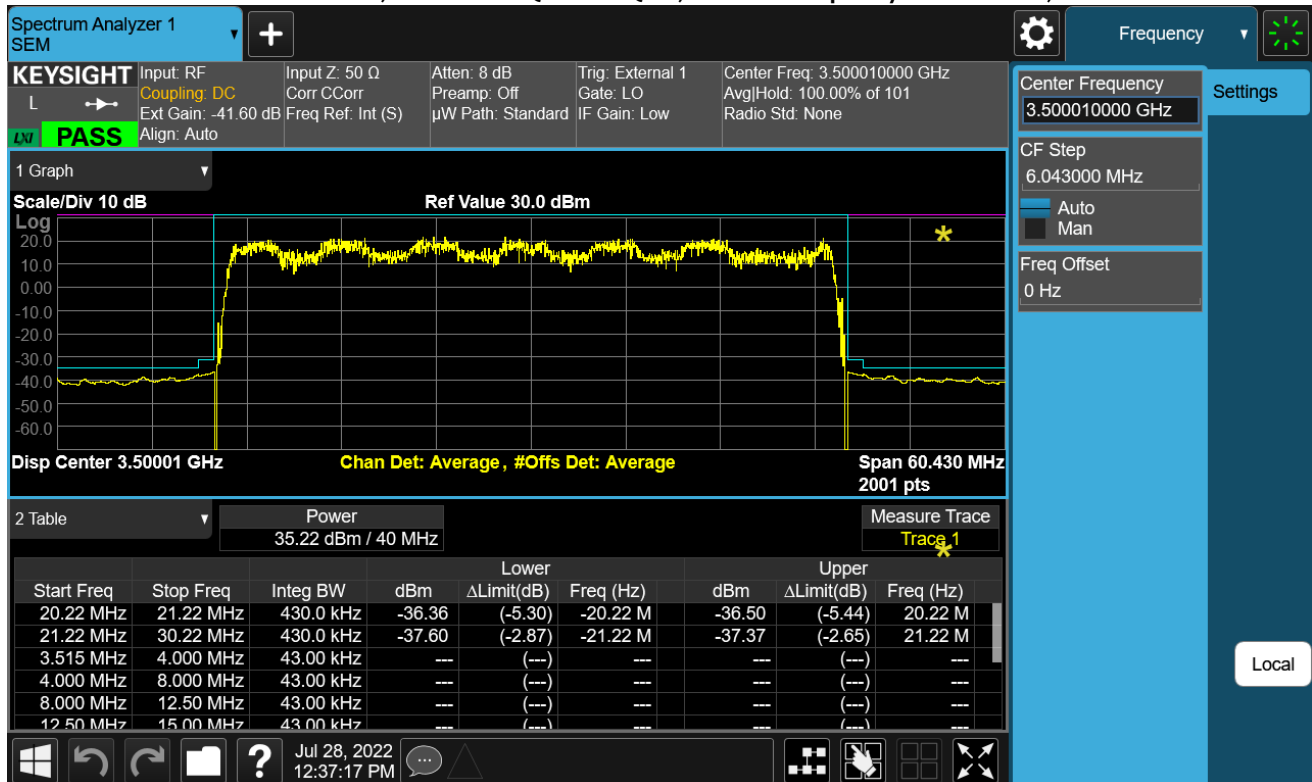

Test Model 3.1a, Modulation 256QAM, Channel Frequency 3529.995MHz, TX1

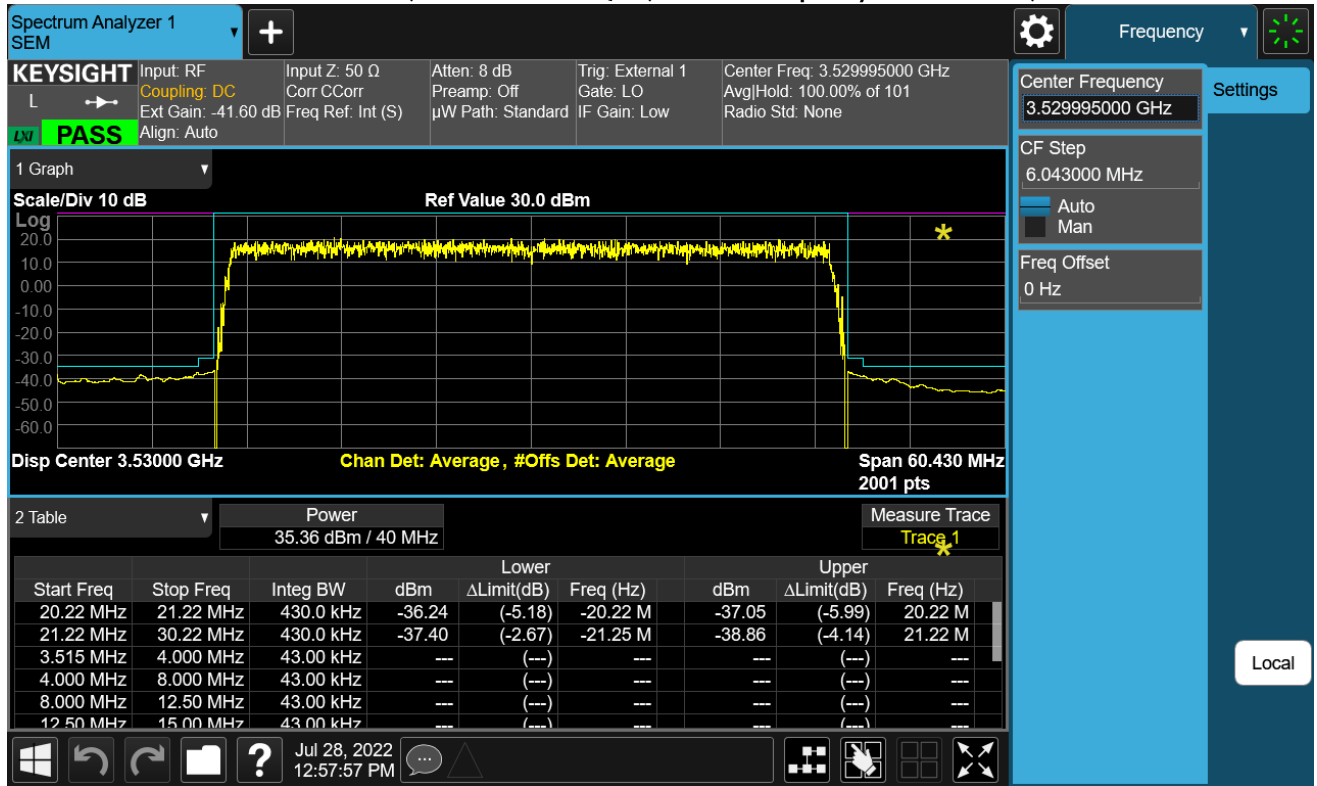

5. FCC Section 2.1051 - Spurious Emissions at Transmit Antenna Port

5.1 Measurement of Spurious Emissions at Transmit Antenna Port

Spurious Emissions at the transmit-antenna terminals were investigated over the frequency range of 10 MHz to beyond the 10th harmonic of the specific transmit band. Carrier Bandwidth is exempt. For this band of operation, the measurements were performed up to 36 GHz. Measurements were made using a Keysight MXA Signal Analyzer. The RF output from the transmitter was reduced (to an amplitude usable by the receivers) using calibrated attenuators. The RF power level was continuously monitored via a Keysight MXA Signal Analyzer.

The required emission limitation is specified as appropriate in 27.53. The measured spurious emission levels were plotted for the frequency range as specified in 2.1057. The limits are corrected for 64 ports where $10\log(64) = 18\text{dBm}$. Notwithstanding the channel edge requirement of -13 dBm per megahertz, for base station operations in the 3450-3550 MHz band, the conducted power of any emission below 3440 MHz or above 3560 MHz shall not exceed -25 dBm/MHz (corrected to -43 dBm/MHz for 64 ports), and the conducted power of emissions below 3430 MHz or above 3570 MHz shall not exceed -40 dBm/MHz (corrected to -58 dBm/MHz for 64 ports). Data below documents performance up to 37 GHz. There were no reportable emissions. Data below documents performance up to 36 GHz.

NOTE: Only plots with lowest margin in each frequency range are used in this report. The full suite of raw data resides at the MH, New Jersey location.

5.1.1 Spurious Emissions at Tx Port - Plots

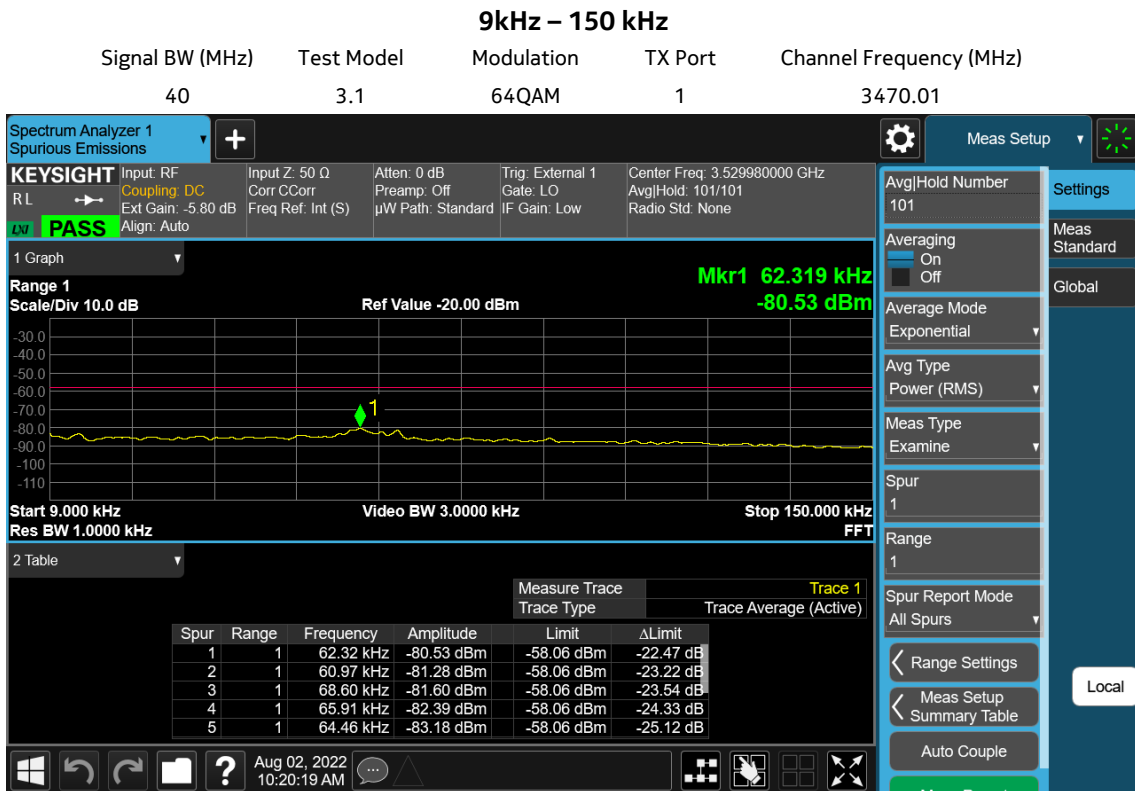

150kHz – 30 MHz

Signal BW (MHz) 40 Test Model 1.1 Modulation QPSK TX Port 1 Channel Frequency (MHz) 3500.01

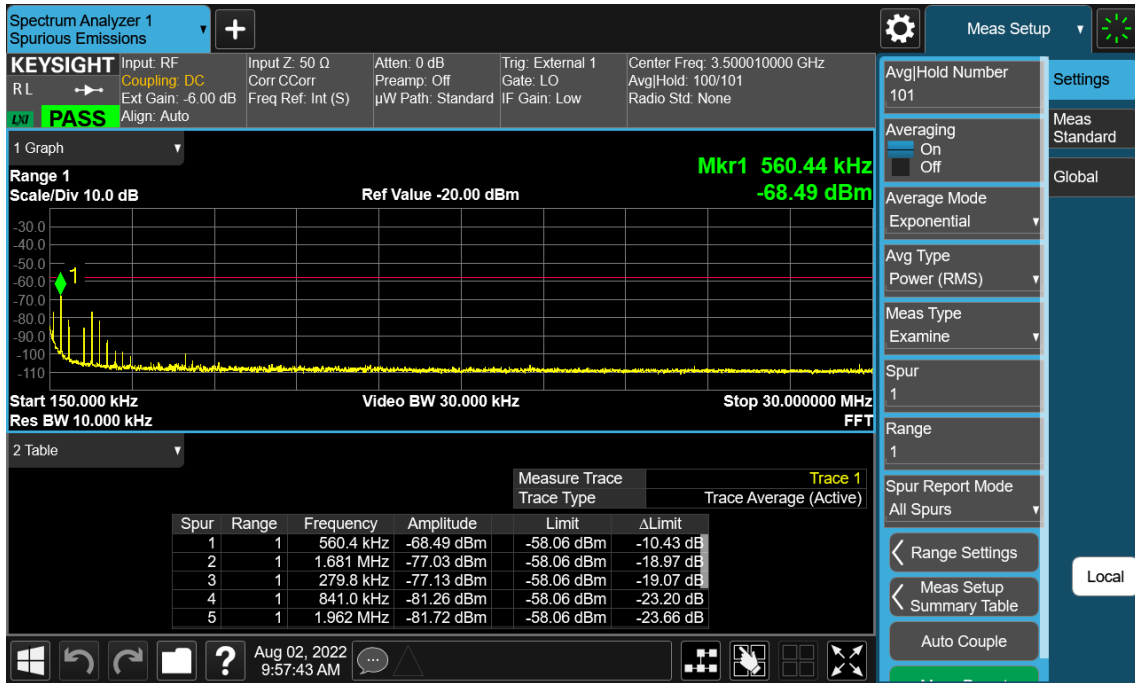

30 MHz – 1 GHz

Signal BW (MHz) 20 Test Model 3.2 Modulation QPSK/16QAM TX Port 1 Channel Frequency (MHz) 3500.01

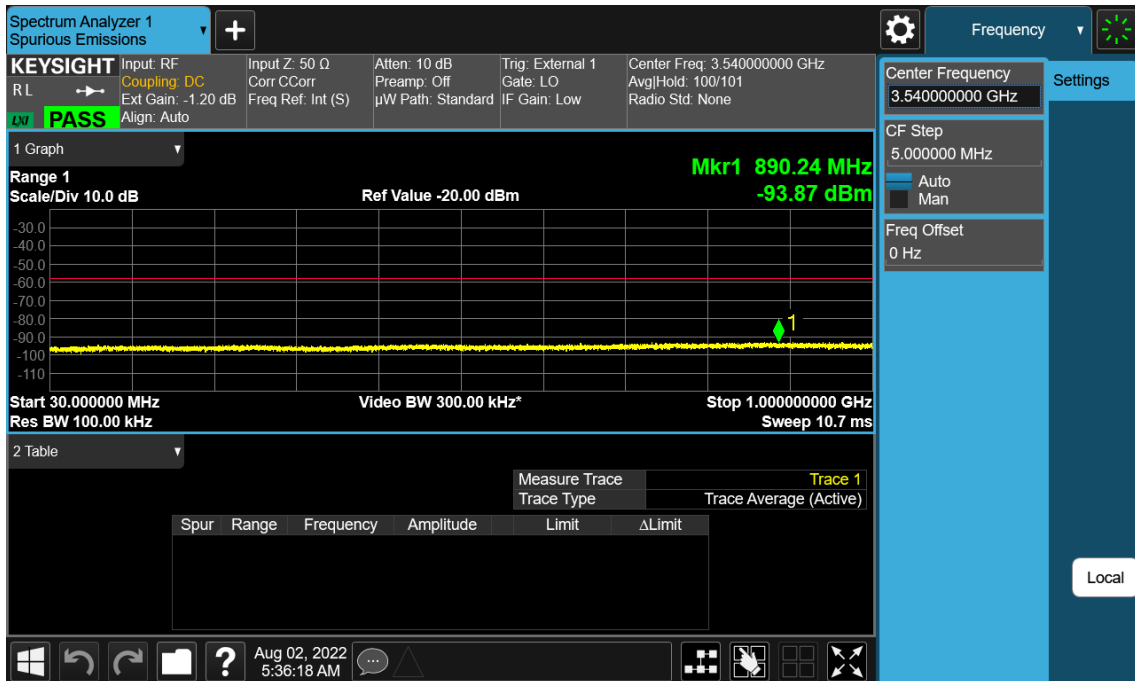

1 GHz – 3.43 GHz

Signal BW (MHz) 20 Test Model 3.1 Modulation 64QAM TX Port 1 Channel Frequency (MHz) 3460.005

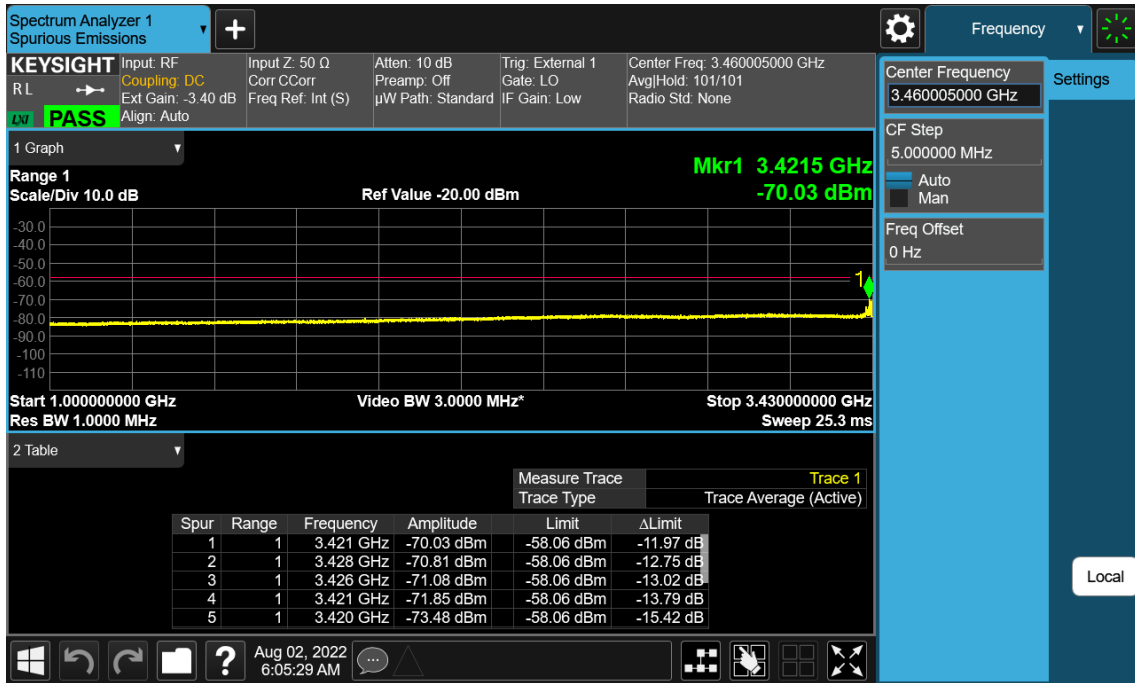

3.43 GHz – 3.44 GHz

Signal BW (MHz) 40 Test Model 3.1 Modulation 64QAM TX Port 1 Channel Frequency (MHz) 3470.01

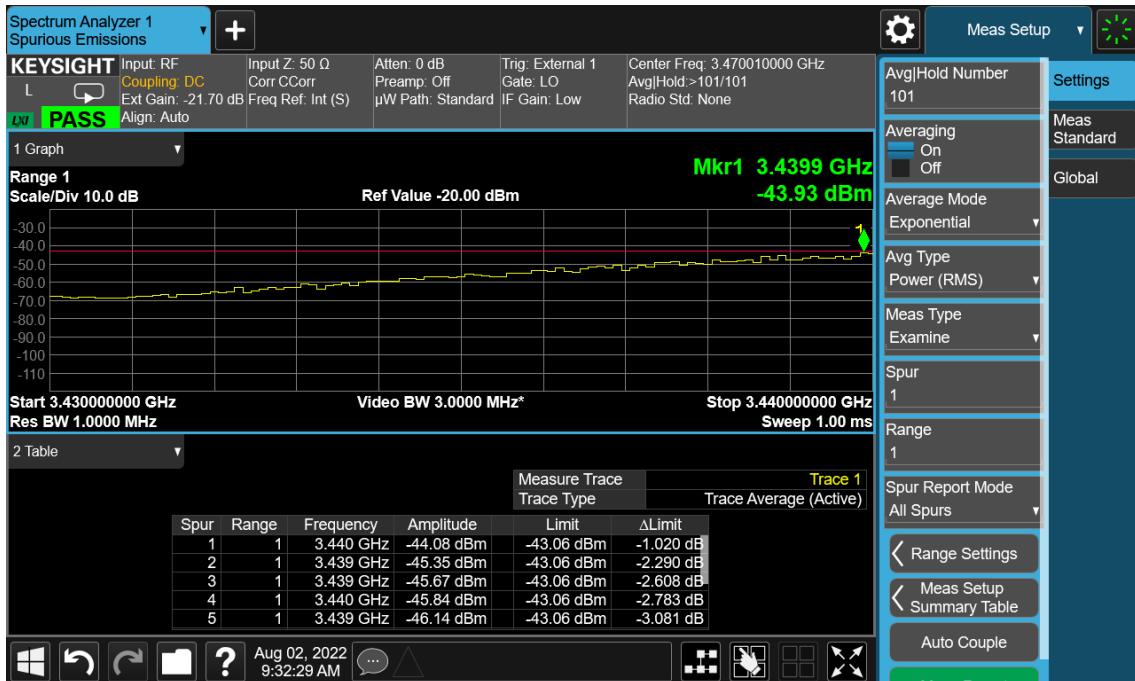

3.56 GHz – 3.57 GHz

Signal BW (MHz) 20 Test Model 3.1a Modulation 256QAM TX Port 1 Channel Frequency (MHz) 3540

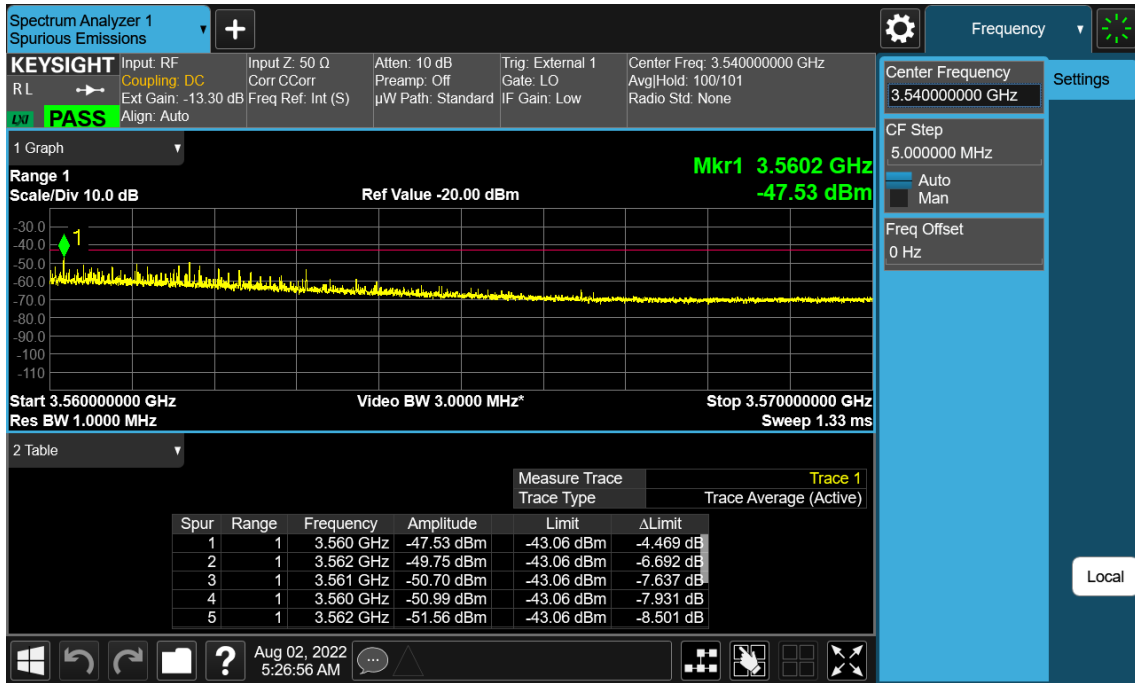

3.57 GHz – 6 GHz

Signal BW (MHz) 40 Test Model 3.1a Modulation 256QAM TX Port 1 Channel Frequency (MHz) 3529.995

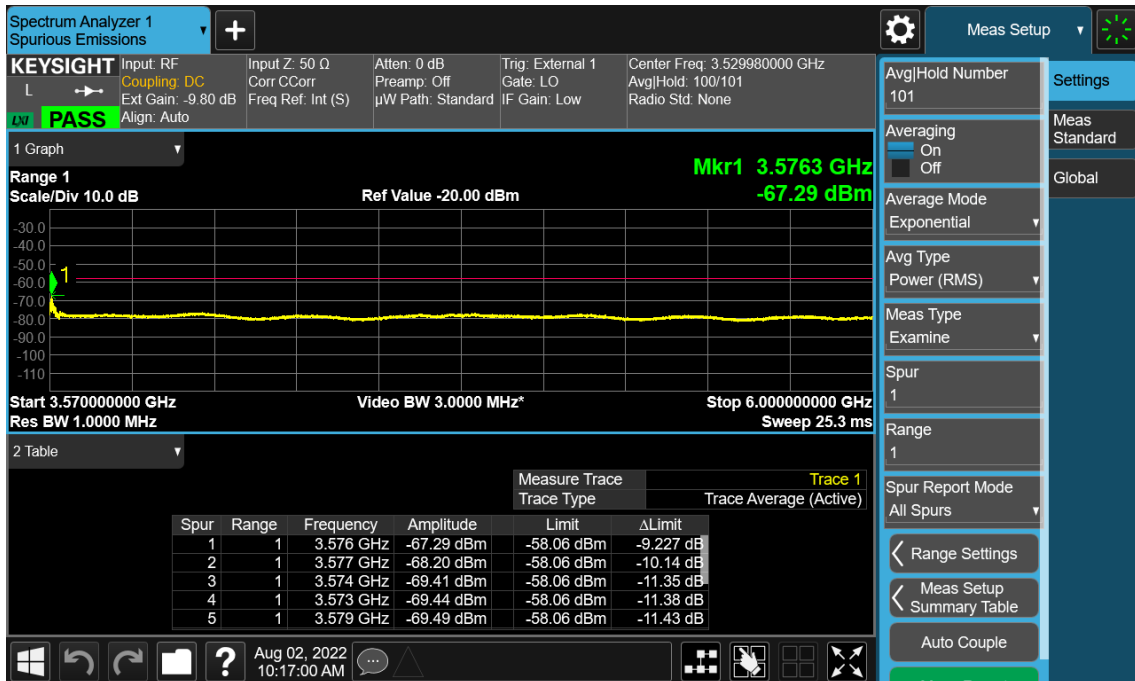

6 GHz – 10 GHz

Signal BW (MHz) 40 Test Model 3.1 Modulation 64QAM TX Port 1 Channel Frequency (MHz) 3470.01

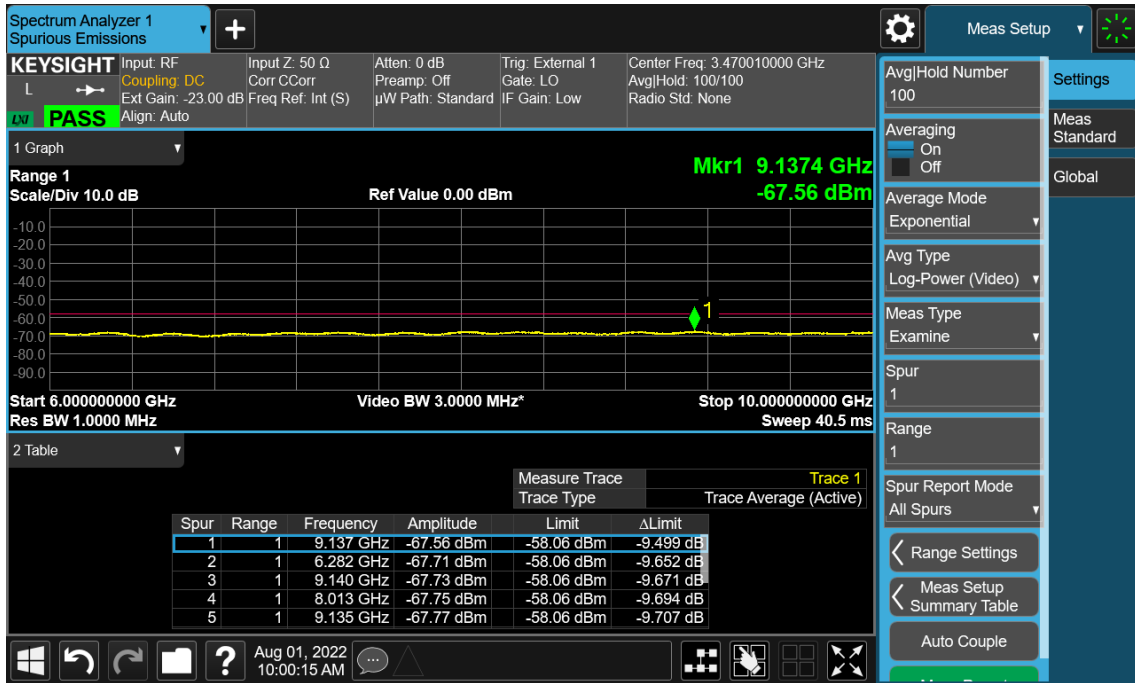

10 GHz – 36 GHz

Signal BW (MHz) 20 Test Model 3.1 Modulation 64QAM TX Port 1 Channel Frequency (MHz) 3460.005

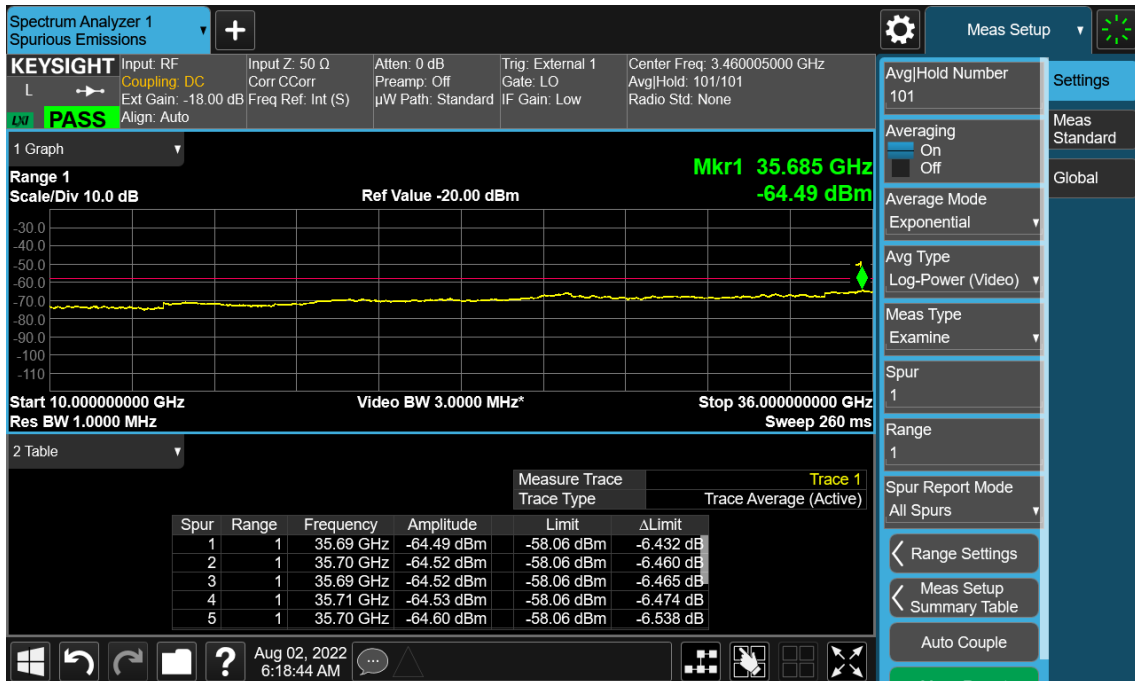

Photographs

AEQU Unit

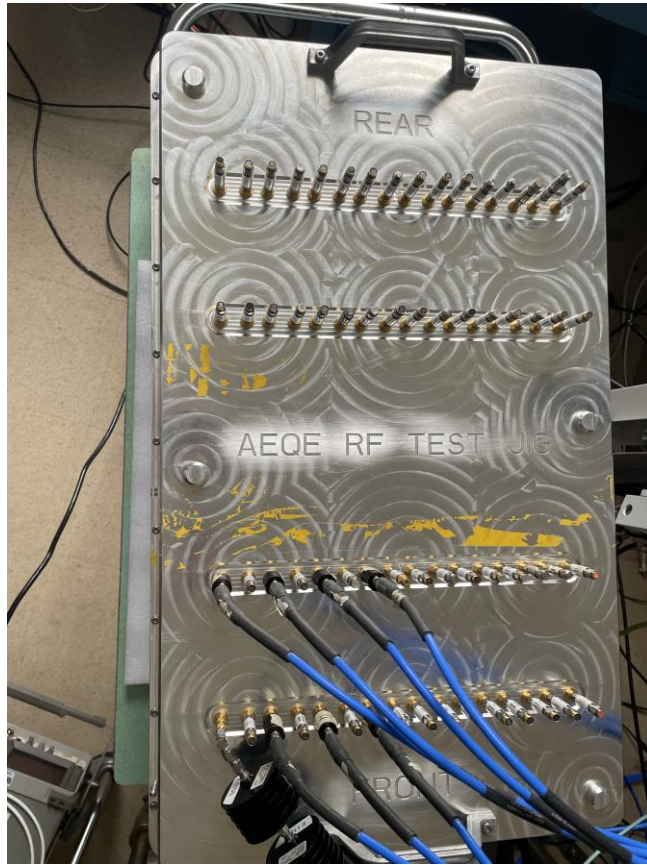

Radio Testing Setup

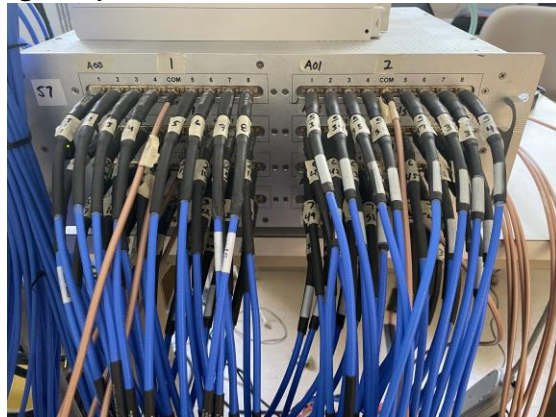

Test Equipment

Asset ID	Manufacturer	Type	Description	Model	Serial	Calibration Date	Calibration Due
E896	Agilent Technologies	Network Analyzer	10 MHz - 40 GHz	N5230C	MY49000897	2021-03-03	2023-03-03
E1338	KeySight Technologies	MXA Signal Analyzer		N9020B	MY57430927	2021-01-07	2023-01-07
E1212	RLC Electronics Inc	Filter, High Pass	10 - 30 GHz, 2W, 5dB	F-19414	1444002	CNR-V	CNR-V
E1480	Reactel, Inc.	Filter, High Pass	DC - 4.3 GHz	11HS-X4.3GS11	SN20-02	CNR-V	CNR-V
E1156	Weinschel	Attenuator	10dB 0.05GHz-26GHz 25W	74-10-12	1069	CNR-V	CNR-V
E1155	Weinschel	Attenuator	10dB 25Watt 0.05GHz - 26GHz	74-10-12	1068	CNR-V	CNR-V
Customer Provided Equipment							
	Utiflex Micro-coax	RF Cable		MFR6 64639 858616-001	UFB142A-Q-0760-2002G0	CNR-V	CNR-V
		Band Reject Filter		QQBSF6-C3540-3550-1778	08213750	CNR-V	CNR-V
	Mini Circuit	RF Switch		ZTS-8SP8T-63	1170228003	NA	NA
	Mini Circuit	RF Switch		RCM-202	0211020002	NA	NA

CNR-V: Calibration Not Required, Must Be Verified

Tests Dates: 7/27/2022 – 8/2/2022.

6. FCC Section 2.1053 - Field strength of spurious radiation

The field strength measurements of radiated spurious emissions were made in a FCC registered 3-meter semi-anechoic chamber AR-4, (FCC Registration Number: 395774) NVLAP Lab Code: 100275-0 and IC (Filing Number: 6933F-4) which is maintained by Nokia Bell Labs in Murray Hill, New Jersey.

The spectrum from 30 MHz to beyond the tenth harmonic of the carrier, 40 GHz, was searched for spurious radiation. Measurements were made using both horizontally and vertically polarized broadband antennas. When the emissions are more than 20 dB below the specification limit, the use of field strength measurements for compliance determination is acceptable and those emissions are considered not reportable (Section 2.1053 and the FCC Interpretive database for 2.1053). For this case the evaluation of acceptable radiated field strength is as follows.

6.1 Spurious Radiation and Radiated Emissions Requirements.

Sections 2.1053 and 27.53 contain the requirements for the levels of spurious radiation as a function of the level of the unmodulated carrier. The reference level for the unmodulated carrier is calculated as the field produced by an ideal dipole excited by the transmitter output power according to the following relation taken from Reference Data for Radio Engineers, page 676, 4th edition, IT&T Corp.

$$E = [(30 \cdot P)^{1/2}] / R$$

$$20 \log (E \cdot 10^6) - (43 + 10 \log P) = 82.23 \text{ dB}\mu\text{V}/\text{meter}$$

Where:

E = Field Intensity in Volts/meter

P = Transmitted Power in Watts

R = Measurement distance in meters = 3 m

The Part 27 Limit is 82.23 dB μ V/m at 3m and 91.77 dB μ V/m at 1m

The Part 27 non-report level is 62.23 dB μ V/m at 3m.

The calculated emission levels were found by:

$$\text{Measured level (dB}\mu\text{V)} + \text{Cable Loss(dB)} + \text{Antenna Factor(dB)} = \text{Field Strength (dB}\mu\text{V/m)}$$

6.2 Field Strength of Spurious Radiation Results:

For compliance with 47CFR Parts 2 and 27, the field strength of any spurious radiation, measured at 3m, is required to be less than 82.23 dB μ V/meter (82.23 @ 3m). Emissions equal to or less than 62.23 dB μ V/meter at 3m are not reportable and may be verified using field strength measurements and broadband antennas. Over the out of band spectrum investigated from 30 MHz to beyond the tenth harmonic of the carrier (up to 40 GHz), no reportable spurious emissions were detected.

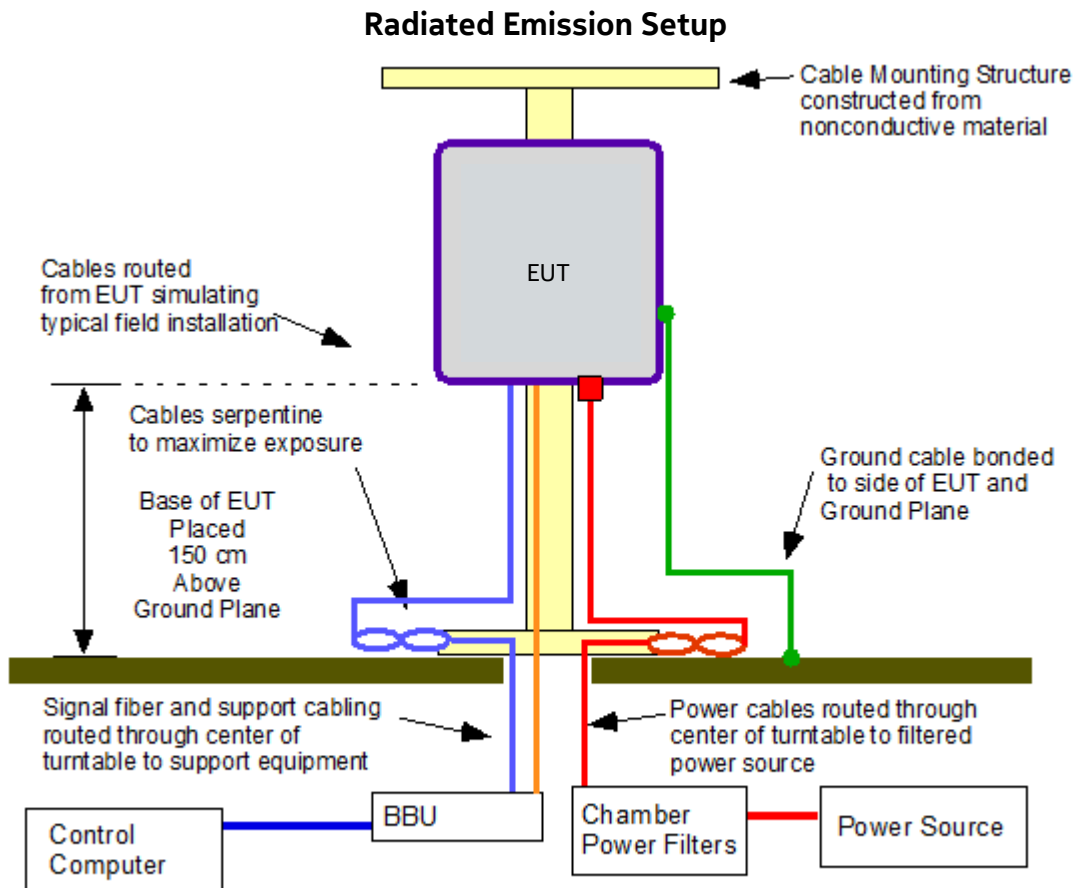

6.3 Transmitter Measurements of Radiated Spurious Emissions Plots

RE 30MHz – 1GHz

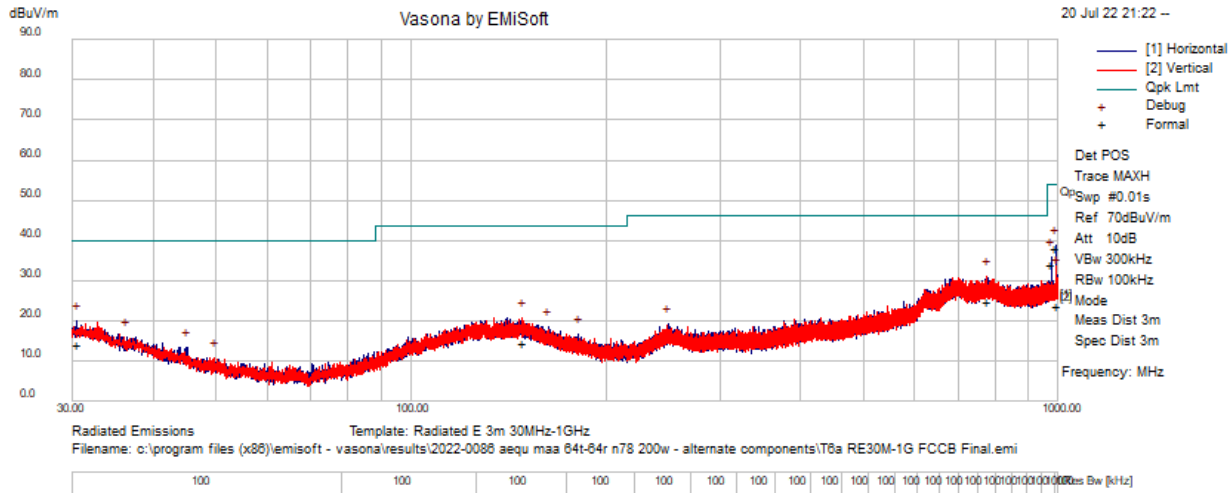

Test Information

Results Title	Radiated E 3m 30MHz-1GHz
File Name	T6a RE30M-1G FCCB Final.emi
Test Laboratory	MH-AR4, 56.6%RH, 22.8C, 994hPa
Test Engineer	MJS
Test Software	Vasona by EMISoft, version 6.061
Equipment	Nokia Wireless
EUT Details	2022-0086 AEQU MAA 64T-64R N78 200W - Alternate, Carrier Tx 3500.010MHz, ETM3.1A,20MHz, 20MHz BW, 35dBm total power
Configuration	FCC Pt.15-B/ICES/GR1089, RE 30MHz-1GHz FCC B 3 meter distance. 10dB Int Attn, RBW: Default, VBW: Default. ESU 954, PA E812, LPF-E1268, BiLog E766, RF cables, AR4 Cable set.
Date	2022-07-20 21:22:37

Formal Data

Freq. (MHz)	Raw (dBuV)	Cable (dB)	Factor (dB)	Level (dBuV/m)	Emission Type	Pol (H/V)	Ht (cm)	Az (deg)	Limit (dBuV/m)	Margin (dB)	Pass/Fail	Comments
990.719	37.72	3.59	-3.06	38.25	QuasiMax	H	189	258	54.00	-15.75	Pass	
975.364	33.88	3.56	-3.21	34.23	QuasiMax	H	128	237	54.00	-19.77	Pass	
776.136	24.18	3.24	-2.72	24.70	QuasiMax	V	330	4	46.00	-21.30	Pass	
30.528	22.37	1.98	-10.38	13.97	QuasiMax	H	126	288	40.00	-26.03	Pass	
148.896	22.94	1.69	-9.95	14.68	QuasiMax	V	107	133	43.50	-28.82	Pass	
995.555	23.02	3.60	-3.01	23.60	QuasiMax	H	247	345	54.00	-30.40	Pass	

Preview Data

Freq. (MHz)	Raw (dBuV)	Cable (dB)	Factor (dB)	Level (dBuV/m)	Emission Type	Pol (H/V)	Ht (cm)	Az (deg)	Limit (dBuV/m)	Margin (dB)	Pass/Fail	Comments
776.136	30.33	3.24	-2.72	30.85	Debug	V	100	270	46.00	-15.15	Pass	
990.725	38.12	3.59	-3.06	38.65	Debug	H	100	315	54.00	-15.35	Pass	
975.360	35.56	3.56	-3.21	35.91	Debug	H	100	90	54.00	-18.09	Pass	
30.528	28.16	1.98	-10.38	19.76	Debug	H	100	315	40.00	-20.24	Pass	
995.555	30.66	3.60	-3.01	31.25	Debug	H	175	45	54.00	-22.75	Pass	
148.896	28.95	1.69	-9.95	20.69	Debug	V	300	315	43.50	-22.81	Pass	

Freq. (MHz)	Raw (dBuV)	Cable (dB)	Factor (dB)	Level (dBuV/m)	Emission Type	Pol (H/V)	Ht (cm)	Az (deg)	Limit (dBuV/m)	Margin (dB)	Pass/Fail	Comments
36.408	27.60	1.80	-13.61	15.80	Debug	H	100	0	40.00	-24.20	Pass	
163.128	28.76	1.71	-12.00	18.47	Debug	H	100	270	43.50	-25.03	Pass	
45.096	29.28	1.61	-17.71	13.18	Debug	H	175	135	40.00	-26.82	Pass	
249.816	29.18	1.88	-11.98	19.08	Debug	H	275	0	46.00	-26.92	Pass	
181.848	29.09	1.73	-14.43	16.39	Debug	H	100	45	43.50	-27.11	Pass	
49.800	28.36	1.53	-19.41	10.48	Debug	V	375	315	40.00	-29.52	Pass	

Note: Preview data was measured using a peak detector to identify frequencies of interest for formal measurement. Formal data consist of all frequencies in the preview list within 6 dB of specification limit or the top six frequencies. Failure in preview data does not necessarily constitute failure in formal data.

Freq. (MHz)	Raw (dBuV)	Cable (dB)	Factor (dB)	Level (dBuV/m)	Emission Type	Pol (H/V)	Ht (cm)	Az (deg)	Limit (dBuV/m)	Margin (dB)	Pass/Fail	Comments
4922.866	51.58	4.04	-4.07	51.55	PeakMax	H	207	355	74.00	-22.45	Pass	

Preview Data

Freq. (MHz)	Raw (dBuV)	Cable (dB)	Factor (dB)	Level (dBuV/m)	Emission Type	Pol (H/V)	Ht (cm)	Az (deg)	Limit (dBuV/m)	Margin (dB)	Pass/Fail	Comments
3500.67145	82.13	3.39	-5.47	80.05	Debug	H	380	315	54.00	26.05	Fail	Tx Exempt
3501.674125	81.64	3.39	-5.47	79.57	Debug	H	380	315	54.00	25.57	Fail	Tx Exempt
4431.354385	58.09	3.74	-4.38	57.45	Debug	H	100	90	54.00	3.45	Fail	
3940.043635	54.84	3.56	-4.75	53.66	Debug	H	200	45	54.00	-0.34	Pass	
4677.210295	52.48	3.89	-4.23	52.13	Debug	H	100	90	54.00	-1.87	Pass	
4416.113725	52.57	3.74	-4.39	51.91	Debug	H	200	135	54.00	-2.09	Pass	
4907.825545	51.89	4.03	-4.08	51.83	Debug	H	200	315	54.00	-2.17	Pass	
4661.7691	52.01	3.88	-4.24	51.65	Debug	H	200	90	54.00	-2.35	Pass	
4922.86567	51.62	4.04	-4.07	51.58	Debug	H	200	315	54.00	-2.42	Pass	
5398.93576	50.58	4.50	-3.57	51.51	Debug	H	100	270	54.00	-2.49	Pass	
2695.523425	54.30	2.88	-6.01	51.17	Debug	H	300	315	54.00	-2.83	Pass	
4170.257815	51.73	3.65	-4.54	50.84	Debug	H	100	90	54.00	-3.16	Pass	
5890.447045	48.90	4.72	-3.11	50.51	Debug	H	300	90	54.00	-3.49	Pass	
5414.376955	49.30	4.51	-3.55	50.26	Debug	H	300	90	54.00	-3.74	Pass	
9853.44997	45.23	6.88	-2.04	50.07	Debug	H	380	180	54.00	-3.93	Pass	
2710.96462	53.13	2.89	-6.01	50.01	Debug	H	200	315	54.00	-3.99	Pass	
2450.068585	53.29	2.73	-6.13	49.89	Debug	H	100	45	54.00	-4.11	Pass	
6889.111345	47.31	5.19	-2.62	49.88	Debug	H	200	315	54.00	-4.12	Pass	
9037.4428	45.47	6.82	-2.50	49.79	Debug	V	100	0	54.00	-4.21	Pass	
4185.899545	50.65	3.65	-4.53	49.77	Debug	H	100	90	54.00	-4.23	Pass	
9976.35436	44.71	6.98	-1.93	49.76	Debug	H	380	180	54.00	-4.24	Pass	
8854.755415	45.39	6.84	-2.60	49.64	Debug	V	100	315	54.00	-4.36	Pass	
8653.61881	45.34	6.85	-2.70	49.49	Debug	H	200	45	54.00	-4.51	Pass	
4413.50677	50.13	3.74	-4.39	49.47	Debug	H	100	90	54.00	-4.53	Pass	
4423.734055	50.11	3.74	-4.39	49.46	Debug	H	100	90	54.00	-4.54	Pass	
5660.232865	48.04	4.65	-3.31	49.38	Debug	H	100	90	54.00	-4.62	Pass	
9589.916725	44.98	6.66	-2.28	49.36	Debug	H	200	180	54.00	-4.64	Pass	
9161.7745	45.03	6.75	-2.46	49.32	Debug	H	200	135	54.00	-4.68	Pass	
5905.88824	47.67	4.72	-3.09	49.30	Debug	H	300	270	54.00	-4.70	Pass	
9359.10094	45.04	6.65	-2.40	49.29	Debug	V	100	180	54.00	-4.71	Pass	
9057.89737	44.96	6.81	-2.50	49.27	Debug	V	100	90	54.00	-4.73	Pass	
8779.15372	45.06	6.84	-2.64	49.26	Debug	V	280	45	54.00	-4.74	Pass	
8819.26072	45.02	6.84	-2.62	49.24	Debug	V	380	90	54.00	-4.76	Pass	
8973.873205	44.93	6.84	-2.53	49.24	Debug	H	200	90	54.00	-4.76	Pass	
8882.22871	44.98	6.84	-2.59	49.24	Debug	V	100	180	54.00	-4.76	Pass	
8913.1111	44.95	6.84	-2.57	49.23	Debug	H	300	270	54.00	-4.77	Pass	
9094.996345	44.91	6.79	-2.48	49.21	Debug	H	380	180	54.00	-4.79	Pass	
8128.818715	45.32	6.59	-2.76	49.16	Debug	V	280	135	54.00	-4.84	Pass	
8763.311455	44.92	6.84	-2.65	49.12	Debug	V	180	135	54.00	-4.88	Pass	
8965.851805	44.80	6.84	-2.54	49.11	Debug	H	380	180	54.00	-4.89	Pass	
9653.08525	44.61	6.71	-2.22	49.10	Debug	H	300	45	54.00	-4.90	Pass	
4472.664595	49.69	3.76	-4.36	49.09	Debug	H	200	90	54.00	-4.91	Pass	
9543.392605	44.76	6.62	-2.32	49.06	Debug	H	300	0	54.00	-4.94	Pass	
9170.798575	44.75	6.75	-2.46	49.03	Debug	H	380	45	54.00	-4.97	Pass	
9384.568885	44.74	6.64	-2.39	48.98	Debug	V	280	270	54.00	-5.02	Pass	
5399.938435	48.02	4.50	-3.57	48.95	Debug	H	100	270	54.00	-5.05	Pass	
2465.710315	52.32	2.74	-6.10	48.95	Debug	H	100	45	54.00	-5.05	Pass	
4908.42715	48.97	4.03	-4.08	48.92	Debug	H	200	315	54.00	-5.08	Pass	
9744.12814	44.25	6.79	-2.14	48.89	Debug	H	300	0	54.00	-5.11	Pass	

Freq. (MHz)	Raw (dBuV)	Cable (dB)	Factor (dB)	Level (dBuV/m)	Emission Type	Pol (H/V)	Ht (cm)	Az (deg)	Limit (dBuV/m)	Margin (dB)	Pass/Fail	Comments
5153.07985	48.45	4.25	-3.85	48.86	Debug	H	100	135	54.00	-5.14	Pass	
8985.70477	44.49	6.84	-2.52	48.81	Debug	H	300	315	54.00	-5.19	Pass	
4446.996115	49.39	3.75	-4.37	48.77	Debug	H	200	90	54.00	-5.23	Pass	
8937.375835	44.48	6.84	-2.55	48.77	Debug	V	280	315	54.00	-5.23	Pass	
8233.497985	44.70	6.67	-2.76	48.61	Debug	V	380	180	54.00	-5.39	Pass	
4441.381135	49.24	3.75	-4.38	48.61	Debug	H	100	90	54.00	-5.39	Pass	
8484.36727	44.54	6.84	-2.78	48.60	Debug	V	280	45	54.00	-5.40	Pass	
8447.8699	44.56	6.81	-2.78	48.59	Debug	V	380	135	54.00	-5.41	Pass	
8218.05679	44.70	6.66	-2.76	48.59	Debug	V	100	135	54.00	-5.41	Pass	
8313.11038	44.62	6.72	-2.77	48.57	Debug	V	100	315	54.00	-5.43	Pass	
3924.401905	49.75	3.56	-4.77	48.54	Debug	H	300	45	54.00	-5.46	Pass	

Note: Preview data was measured using a peak detector to identify frequencies of interest for formal measurement. Formal data consist of all frequencies in the preview list within 6 dB of specification limit or the top six frequencies. Failure in preview data does not necessarily constitute failure in formal data.

RE 10 GHz – 18 GHz

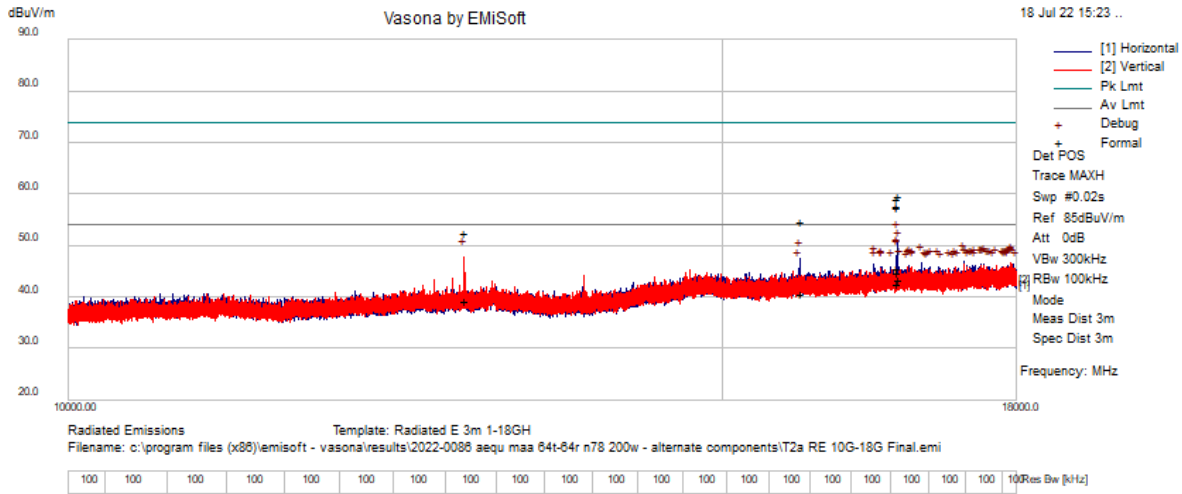

Test Information

Results Title	Radiated E 3m 1-18GH
File Name	T2a RE 10G-18G Final.emi
Test Laboratory	MH-AR4, 42.6%RH, 25C, 1005hPa
Test Engineer	GM
Test Software	Vasona by EMiSoft, version 6.061
Equipment	Nokia
EUT Details	2022-0086 AEQU MAA 64T-64R N78 200W - Alternate, Carrier Tx 3500.010MHz, ETM3.1A,20MHz, 20MHz BW, 35dBm total power
Configuration	FCC Pt.15-B/ICES/GR1089, RE 10GHz-18GHz FCC B 3 meter distance. 0dB Int Attn, RBW: 1MHz, VBW: 3MHz. ESU 954, PA E477, Horn E1073, RF cables, AR4 Direct Cable
Date	2022-07-18 15:23:56

Formal Data

Freq. (MHz)	Raw (dBuV)	Cable (dB)	Factor (dB)	Level (dBuV/m)	Emission Type	Pol (H/V)	Ht (cm)	Az (deg)	Limit (dBuV/m)	Margin (dB)	Pass/Fail	Comments
16707.849	32.67	8.95	3.92	45.54	AvgMax	H	140	319	54.00	-8.46	Pass	
16715.496	31.86	8.94	3.93	44.73	AvgMax	H	114	48	54.00	-9.27	Pass	
16719.384	30.61	8.94	3.94	43.49	AvgMax	H	118	79	54.00	-10.51	Pass	
16704.019	29.77	8.95	3.91	42.63	AvgMax	H	163	152	54.00	-11.37	Pass	
15739.361	29.61	8.91	2.30	40.82	AvgMax	H	318	355	54.00	-13.18	Pass	
16719.384	46.96	8.94	3.94	59.84	PeakMax	H	118	79	74.00	-14.16	Pass	
12775.712	30.20	7.48	1.74	39.42	AvgMax	V	140	300	54.00	-14.58	Pass	
16707.849	46.43	8.95	3.92	59.29	PeakMax	H	140	319	74.00	-14.71	Pass	
16715.496	44.78	8.94	3.93	57.65	PeakMax	H	114	48	74.00	-16.35	Pass	
16704.019	44.73	8.95	3.91	57.58	PeakMax	H	163	152	74.00	-16.42	Pass	
15739.361	43.58	8.91	2.30	54.78	PeakMax	H	318	355	74.00	-19.22	Pass	
12775.712	43.40	7.48	1.74	52.62	PeakMax	V	140	300	74.00	-21.38	Pass	

Preview Data

Freq. (MHz)	Raw (dBuV)	Cable (dB)	Factor (dB)	Level (dBuV/m)	Emission Type	Pol (H/V)	Ht (cm)	Az (deg)	Limit (dBuV/m)	Margin (dB)	Pass/Fail	Comments
16715.527	38.13	8.94	3.93	51.01	Debug	H	100	315	54.00	-2.99	Pass	
16719.337	36.46	8.94	3.94	49.34	Debug	H	200	45	54.00	-4.66	Pass	
16707.706	35.15	8.95	3.92	48.01	Debug	H	100	45	54.00	-5.99	Pass	
12771.806	38.49	7.48	1.73	47.71	Debug	V	180	135	54.00	-6.29	Pass	
16703.896	34.82	8.95	3.91	47.68	Debug	H	100	90	54.00	-6.32	Pass	
15736.314	36.19	8.90	2.30	47.39	Debug	H	200	90	54.00	-6.61	Pass	
17415.193	33.15	8.81	4.88	46.84	Debug	H	100	270	54.00	-7.16	Pass	
17938.519	33.01	8.88	4.86	46.75	Debug	V	180	315	54.00	-7.25	Pass	
16965.193	33.39	8.83	4.42	46.64	Debug	H	100	45	54.00	-7.36	Pass	
17642.199	32.72	8.83	4.92	46.48	Debug	H	380	45	54.00	-7.52	Pass	
17943.636	32.61	8.88	4.86	46.35	Debug	V	180	135	54.00	-7.65	Pass	
16471.275	33.85	9.04	3.44	46.34	Debug	H	300	0	54.00	-7.66	Pass	
17598.482	32.52	8.82	4.93	46.27	Debug	H	100	90	54.00	-7.73	Pass	
17959.529	32.53	8.88	4.85	46.27	Debug	H	380	0	54.00	-7.73	Pass	
17425.621	32.57	8.81	4.89	46.27	Debug	V	180	135	54.00	-7.73	Pass	
17607.306	32.42	8.82	4.93	46.18	Debug	V	280	270	54.00	-7.82	Pass	
17769.138	32.40	8.85	4.90	46.15	Debug	V	180	135	54.00	-7.85	Pass	
17630.167	32.37	8.83	4.93	46.12	Debug	V	180	135	54.00	-7.88	Pass	
17611.116	32.34	8.83	4.93	46.10	Debug	V	100	225	54.00	-7.90	Pass	
17905.568	32.32	8.88	4.87	46.06	Debug	H	100	135	54.00	-7.94	Pass	
16840.260	32.98	8.89	4.18	46.04	Debug	H	300	225	54.00	-7.96	Pass	
17448.683	32.32	8.81	4.91	46.03	Debug	H	300	270	54.00	-7.97	Pass	
17538.924	32.25	8.81	4.95	46.01	Debug	H	380	315	54.00	-7.99	Pass	
17509.846	32.24	8.81	4.95	46.00	Debug	H	300	90	54.00	-8.00	Pass	
16741.195	33.03	8.93	3.98	45.94	Debug	H	380	90	54.00	-8.06	Pass	
17679.900	32.19	8.84	4.92	45.94	Debug	H	200	270	54.00	-8.06	Pass	
17851.918	32.19	8.87	4.88	45.93	Debug	V	280	315	54.00	-8.07	Pass	
17687.119	32.17	8.84	4.91	45.92	Debug	H	100	45	54.00	-8.08	Pass	
17324.953	32.30	8.81	4.79	45.90	Debug	V	380	315	54.00	-8.10	Pass	
17890.993	32.16	8.87	4.87	45.90	Debug	V	180	225	54.00	-8.10	Pass	
16823.214	32.86	8.90	4.14	45.90	Debug	V	280	225	54.00	-8.10	Pass	
17486.584	32.14	8.81	4.94	45.89	Debug	H	200	315	54.00	-8.11	Pass	
17878.821	32.15	8.87	4.87	45.89	Debug	H	380	225	54.00	-8.11	Pass	
17890.605	32.14	8.87	4.87	45.89	Debug	H	100	270	54.00	-8.11	Pass	
16869.738	32.77	8.87	4.23	45.88	Debug	V	280	90	54.00	-8.12	Pass	
17062.452	32.48	8.82	4.55	45.84	Debug	H	200	135	54.00	-8.16	Pass	
17142.466	32.39	8.81	4.62	45.83	Debug	H	200	90	54.00	-8.17	Pass	
17702.360	32.03	8.84	4.91	45.78	Debug	H	100	45	54.00	-8.22	Pass	
17855.562	32.02	8.87	4.88	45.76	Debug	H	380	315	54.00	-8.24	Pass	
16546.476	33.13	9.02	3.60	45.75	Debug	H	100	270	54.00	-8.25	Pass	
16552.291	33.08	9.01	3.61	45.70	Debug	H	300	270	54.00	-8.30	Pass	
17457.506	31.97	8.81	4.92	45.69	Debug	H	380	0	54.00	-8.31	Pass	
16648.548	32.91	8.97	3.80	45.68	Debug	H	100	180	54.00	-8.32	Pass	
17893.086	31.94	8.87	4.87	45.68	Debug	H	300	0	54.00	-8.32	Pass	
17530.902	31.92	8.81	4.95	45.68	Debug	H	380	270	54.00	-8.32	Pass	
15721.074	34.48	8.89	2.29	45.66	Debug	H	100	315	54.00	-8.34	Pass	
17730.635	31.91	8.85	4.90	45.66	Debug	V	100	0	54.00	-8.34	Pass	
16481.101	33.13	9.04	3.47	45.64	Debug	H	200	90	54.00	-8.36	Pass	
16865.728	32.53	8.88	4.23	45.63	Debug	V	380	135	54.00	-8.37	Pass	
17356.838	31.99	8.81	4.82	45.63	Debug	H	300	180	54.00	-8.37	Pass	
17979.765	31.87	8.89	4.85	45.60	Debug	V	380	90	54.00	-8.40	Pass	
16556.102	32.89	9.01	3.62	45.52	Debug	H	380	315	54.00	-8.48	Pass	
17040.995	32.16	8.82	4.53	45.50	Debug	H	200	270	54.00	-8.50	Pass	
17864.090	31.73	8.87	4.88	45.47	Debug	H	200	45	54.00	-8.53	Pass	

Freq. (MHz)	Raw (dBuV)	Cable (dB)	Factor (dB)	Level (dBuV/m)	Emission Type	Pol (H/V)	Ht (cm)	Az (deg)	Limit (dBuV/m)	Margin (dB)	Pass/Fail	Comments
17257.372	31.93	8.81	4.73	45.47	Debug	V	180	270	54.00	-8.53	Pass	
17005.500	32.15	8.82	4.49	45.46	Debug	H	200	270	54.00	-8.54	Pass	
17171.945	31.96	8.81	4.65	45.42	Debug	H	380	270	54.00	-8.58	Pass	
17310.915	31.83	8.81	4.78	45.42	Debug	H	200	0	54.00	-8.58	Pass	
16811.784	32.36	8.90	4.12	45.38	Debug	H	200	225	54.00	-8.62	Pass	
17014.926	32.05	8.82	4.50	45.37	Debug	H	300	45	54.00	-8.63	Pass	

Note: Preview data was measured using a peak detector to identify frequencies of interest for formal measurement. Formal data consist of all frequencies in the preview list within 6 dB of specification limit or the top six frequencies. Failure in preview data does not necessarily constitute failure in formal data.

RE 18 GHz – 26.5 GHz

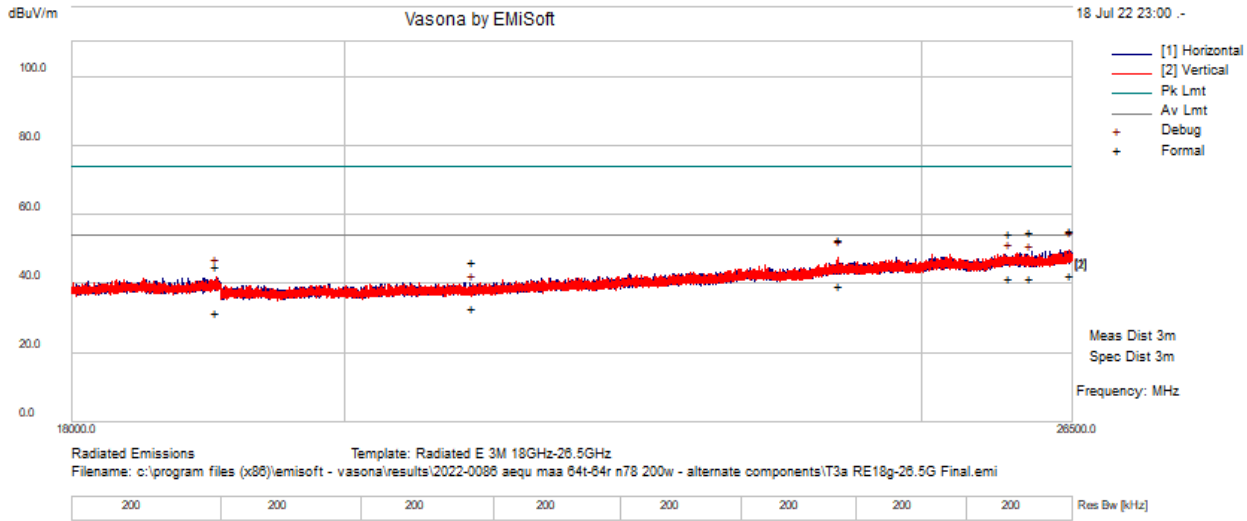

Test Information

Results Title	Radiated E 3M 18GHz-26.5GHz
File Name	T3a RE18g-26.5G Final.emi
Test Laboratory	MH-AR4, 42.6%RH, 25C, 1005hPa
Test Engineer	MJS
Test Software	Vasona by EMISoft, version 6.061
Equipment	Nokia
EUT Details	2022-0086 AEQU MAA 64T-64R N78 200W - Alternate, Carrier Tx 3500.010MHz, ETM3.1A,20MHz, 20MHz BW, 35dBm total power
Configuration	FCC Pt.15-B/ICES/GR1089, RE 18GHz-26.5GHz FCC B 3 meter distance. 5dB Int Attn, RBW: 100kHz, VBW: 3MHz. ESU 954, PA E1525, Horn E1452, RF cables, E1501 and E1502 Cable set.
Date	2022-07-18 23:00:04

Formal Data

Freq. (MHz)	Raw (dBuV)	Cable (dB)	Factor (dB)	Level (dBuV/m)	Emission Type	Pol (H/V)	Ht (cm)	Az (deg)	Limit (dBuV/m)	Margin (dB)	Pass/Fail	Comments
26465.999	32.01	13.61	-3.22	42.41	AvgMax	V	194	352	54.00	-11.59	Pass	
26057.876	31.17	13.50	-3.13	41.54	AvgMax	H	271	352	54.00	-12.46	Pass	
25847.085	31.17	13.44	-3.13	41.48	AvgMax	H	188	352	54.00	-12.52	Pass	
24203.421	30.37	13.11	-3.91	39.56	AvgMax	V	206	352	54.00	-14.44	Pass	
26465.999	45.14	13.61	-3.22	55.53	PeakMax	V	194	352	74.00	-18.47	Pass	
26057.876	44.61	13.50	-3.13	54.98	PeakMax	H	271	352	74.00	-19.02	Pass	
25847.085	44.29	13.44	-3.13	54.61	PeakMax	H	188	352	74.00	-19.39	Pass	
24203.421	43.80	13.11	-3.91	52.99	PeakMax	V	206	352	74.00	-21.01	Pass	
21003.606	29.56	12.13	-8.79	32.90	AvgMax	H	116	352	54.00	-21.10	Pass	
19028.500	29.37	11.46	-8.94	31.88	AvgMax	V	212	352	54.00	-22.12	Pass	
21003.606	43.08	12.13	-8.79	46.42	PeakMax	H	116	352	74.00	-27.58	Pass	
19028.500	42.70	11.46	-8.94	45.22	PeakMax	V	212	352	74.00	-28.78	Pass	

Preview Data

Freq. (MHz)	Raw (dBuV)	Cable (dB)	Factor (dB)	Level (dBuV/m)	Emission Type	Pol (H/V)	Ht (cm)	Az (deg)	Limit (dBuV/m)	Margin (dB)	Pass/Fail	Comments
26465.999	39.42	13.61	-3.22	49.82	Debug	V	325	154	54.00	-4.18	Pass	
19028.500	39.32	11.46	-8.94	41.84	Debug	V	325	176	54.00	-12.16	Pass	
24203.421	38.13	13.11	-3.91	47.32	Debug	V	101	352	54.00	-6.68	Pass	
26057.876	35.65	13.50	-3.13	46.01	Debug	H	101	352	54.00	-7.99	Pass	
21003.606	34.05	12.13	-8.79	37.39	Debug	H	101	352	54.00	-16.61	Pass	
25847.085	35.95	13.44	-3.13	46.26	Debug	H	101	352	54.00	-7.74	Pass	

Note: Preview data was measured using a peak detector to identify frequencies of interest for formal measurement. Formal data consist of all frequencies in the preview list within 6 dB of specification limit or the top six frequencies. Failure in preview data does not necessarily constitute failure in formal data.

RE 26.5 GHz – 34 GHz

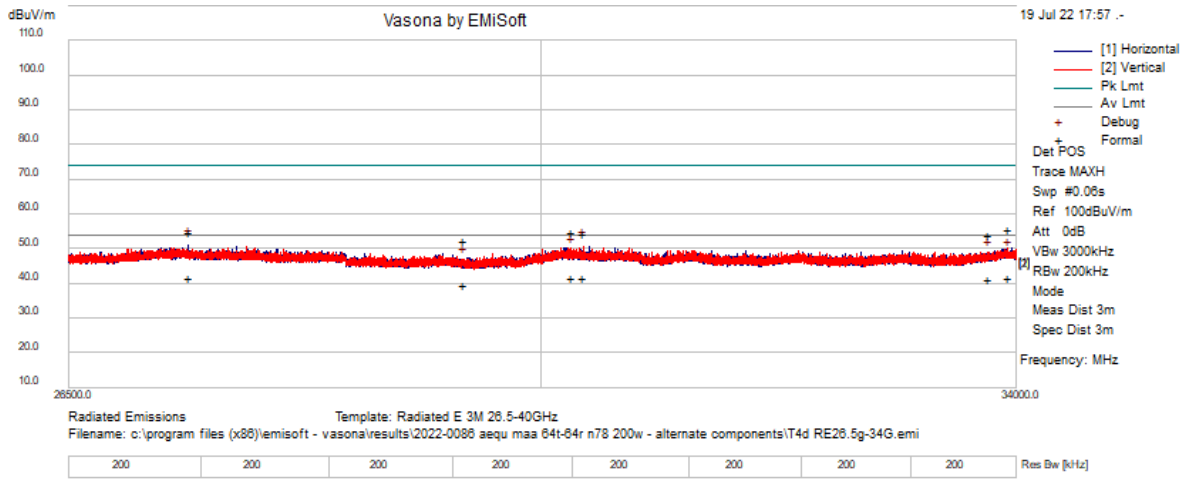

Test Information

Results Title	Radiated E 3M 26.5-40GHz
File Name	T4d RE26.5g-34GHz Final.emi
Test Laboratory	MH-AR4, 56%RH, 22.8C, 994hPa
Test Engineer	MJS
Test Software	Vasona by EMISoft, version 6.061
Equipment	Nokia Wireless
EUT Details	2022-0086 AEQU MAA 64T-64R N78 200W - Alternate, Carrier Tx 3500.010MHz, ETM3.1A,20MHz, 20MHz BW, 35dBm total power
Configuration	FCC Pt.15-B/ICES/GR1089, RE 26.5GHz-40GHz FCC B 3 meter distance. 0dB Int Attn, RBW: 100kHz, VBW: 3MHz. ESU 954, PA E1525, Horn E1375, RF cables, E1501 and E1502 Cable set.
Date	2022-07-19 17:57:44

Formal Data

Freq. (MHz)	Raw (dBuV)	Cable (dB)	Factor (dB)	Level (dBuV/m)	Emission Type	Pol (H/V)	Ht (cm)	Az (deg)	Limit (dBuV/m)	Margin (dB)	Pass/Fail	Comments
33928.053	25.77	16.57	-0.46	41.89	AvgMax	H	307	352	54.00	-12.11	Pass	
27345.625	27.54	13.86	0.30	41.69	AvgMax	H	217	352	54.00	-12.31	Pass	
30238.154	26.43	14.60	0.64	41.66	AvgMax	H	206	352	54.00	-12.34	Pass	
30337.188	26.25	14.63	0.66	41.54	AvgMax	V	240	352	54.00	-12.46	Pass	
33742.543	25.25	16.36	-0.48	41.14	AvgMax	V	100	352	54.00	-12.86	Pass	
29398.484	24.56	14.35	0.60	39.51	AvgMax	V	262	352	54.00	-14.49	Pass	
33928.053	39.67	16.57	-0.46	55.78	PeakMax	H	307	352	74.00	-18.22	Pass	
30238.154	39.69	14.60	0.64	54.92	PeakMax	H	206	352	74.00	-19.08	Pass	
27345.625	40.77	13.86	0.30	54.92	PeakMax	H	217	352	74.00	-19.08	Pass	
30337.188	39.22	14.63	0.66	54.50	PeakMax	V	240	352	74.00	-19.50	Pass	
33742.543	38.11	16.36	-0.48	54.00	PeakMax	V	100	352	74.00	-20.00	Pass	
29398.484	37.30	14.35	0.60	52.25	PeakMax	V	262	352	74.00	-21.75	Pass	

Preview Data

Freq. (MHz)	Raw (dBuV)	Cable (dB)	Factor (dB)	Level (dBuV/m)	Emission Type	Pol (H/V)	Ht (cm)	Az (deg)	Limit (dBuV/m)	Margin (dB)	Pass/Fail	Comments
27345.625	36.75	13.86	0.30	50.90	Debug	H	250	132	54.00	-3.10	Pass	
30337.188	35.18	14.63	0.66	50.46	Debug	V	175	220	54.00	-3.54	Pass	
33742.543	31.71	16.36	-0.48	47.59	Debug	V	100	352	54.00	-6.41	Pass	
29398.484	30.65	14.35	0.60	45.60	Debug	V	100	352	54.00	-8.40	Pass	
33928.053	31.69	16.57	-0.46	47.81	Debug	H	100	352	54.00	-6.19	Pass	
30238.154	33.22	14.60	0.64	48.45	Debug	H	100	352	54.00	-5.55	Pass	

Note: Preview data was measured using a peak detector to identify frequencies of interest for formal measurement. Formal data consist of all frequencies in the preview list within 6 dB of specification limit or the top six frequencies. Failure in preview data does not necessarily constitute failure in formal data.

RE 34 GHz – 40 GHz

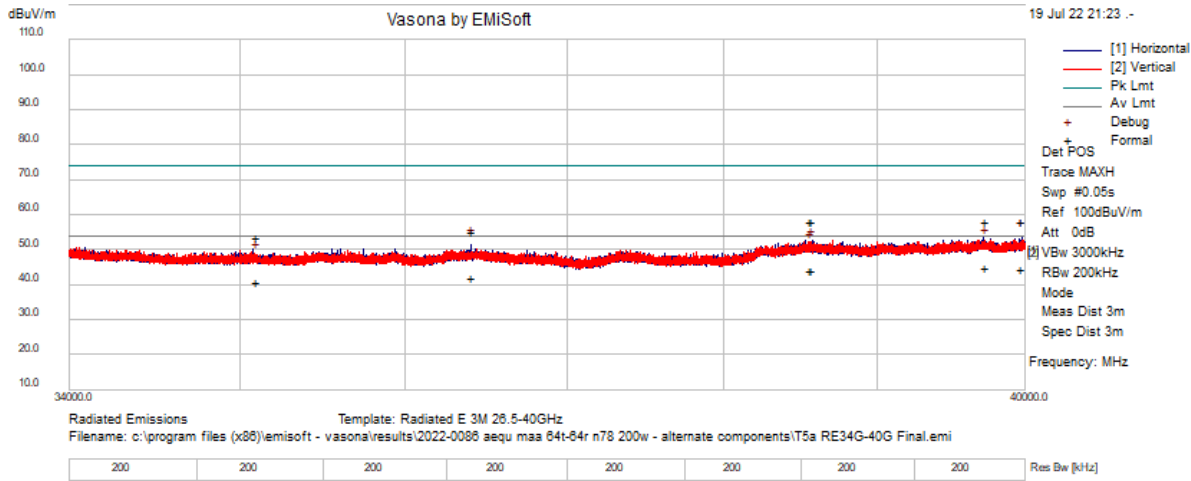

Test Information

Results Title	Radiated E 3M 26.5-40GHz
File Name	T5a RE34G-40G Final.emi
Test Laboratory	MH-AR4, 56.6%RH, 22.8C, 994hPa
Test Engineer	MJS
Test Software	Vasona by EMISoft, version 6.061
Equipment	Nokia Wireless
EUT Details	2022-0086 AEQU MAA 64T-64R N78 200W - Alternate, Carrier Tx 3500.010MHz, ETM3.1A,20MHz, 20MHz BW, 35dBm total power
Configuration	FCC Pt.15-B/ICES/GR1089, RE 34GHz-40GHz FCC B 3 meter distance. 0dB Int Attn, RBW: 100kHz, VBW: 3MHz. ESU 954, PA E1525, Horn E1375, RF cables, E1501 and E1502 Cable set.
Date	2022-07-19 21:23:21

Formal Data

Freq. (MHz)	Raw (dBuV)	Cable (dB)	Factor (dB)	Level (dBuV/m)	Emission Type	Pol (H/V)	Ht (cm)	Az (deg)	Limit (dBuV/m)	Margin (dB)	Pass/Fail	Comments
39724.670	27.59	17.17	0.09	44.85	AvgMax	V	118	354	54.00	-9.15	Pass	
39973.750	27.51	17.17	0.13	44.81	AvgMax	H	319	361	54.00	-9.19	Pass	
38560.616	28.02	16.97	-0.62	44.37	AvgMax	V	264	354	54.00	-9.63	Pass	
38570.017	28.01	16.98	-0.63	44.35	AvgMax	H	124	354	54.00	-9.65	Pass	
36407.125	26.83	16.29	-1.06	42.06	AvgMax	H	283	354	54.00	-11.94	Pass	
35094.756	26.05	15.87	-1.18	40.74	AvgMax	V	298	354	54.00	-13.26	Pass	
38570.017	41.84	16.98	-0.63	58.18	PeakMax	H	124	354	74.00	-15.82	Pass	
39724.670	40.92	17.17	0.09	58.18	PeakMax	V	118	354	74.00	-15.82	Pass	
39973.750	40.82	17.17	0.13	58.13	PeakMax	H	319	361	74.00	-15.87	Pass	
38560.616	41.76	16.97	-0.62	58.11	PeakMax	V	264	354	74.00	-15.89	Pass	
36407.125	39.94	16.29	-1.06	55.17	PeakMax	H	283	354	74.00	-18.83	Pass	
35094.756	39.11	15.87	-1.18	53.80	PeakMax	V	298	354	74.00	-20.20	Pass	

Preview Data

Freq. (MHz)	Raw (dBuV)	Cable (dB)	Factor (dB)	Level (dBuV/m)	Emission Type	Pol (H/V)	Ht (cm)	Az (deg)	Limit (dBuV/m)	Margin (dB)	Pass/Fail	Comments
39973.750	36.26	17.17	0.13	53.56	Debug	H	325	44	54.00	-0.44	Pass	
36407.125	36.26	16.29	-1.06	51.49	Debug	H	100	330	54.00	-2.51	Pass	
39724.670	34.14	17.17	0.09	51.40	Debug	V	100	352	54.00	-2.60	Pass	
38560.616	33.72	16.97	-0.62	50.07	Debug	V	100	352	54.00	-3.93	Pass	
35094.756	32.80	15.87	-1.18	47.49	Debug	V	100	352	54.00	-6.51	Pass	
38570.017	34.69	16.98	-0.63	51.04	Debug	H	100	352	54.00	-2.96	Pass	

Note: Preview data was measured using a peak detector to identify frequencies of interest for formal measurement. Formal data consist of all frequencies in the preview list within 6 dB of specification limit or the top six frequencies. Failure in preview data does not necessarily constitute failure in formal data.

Photographs

30 MHz – 1GHz



1GHz – 18GHz

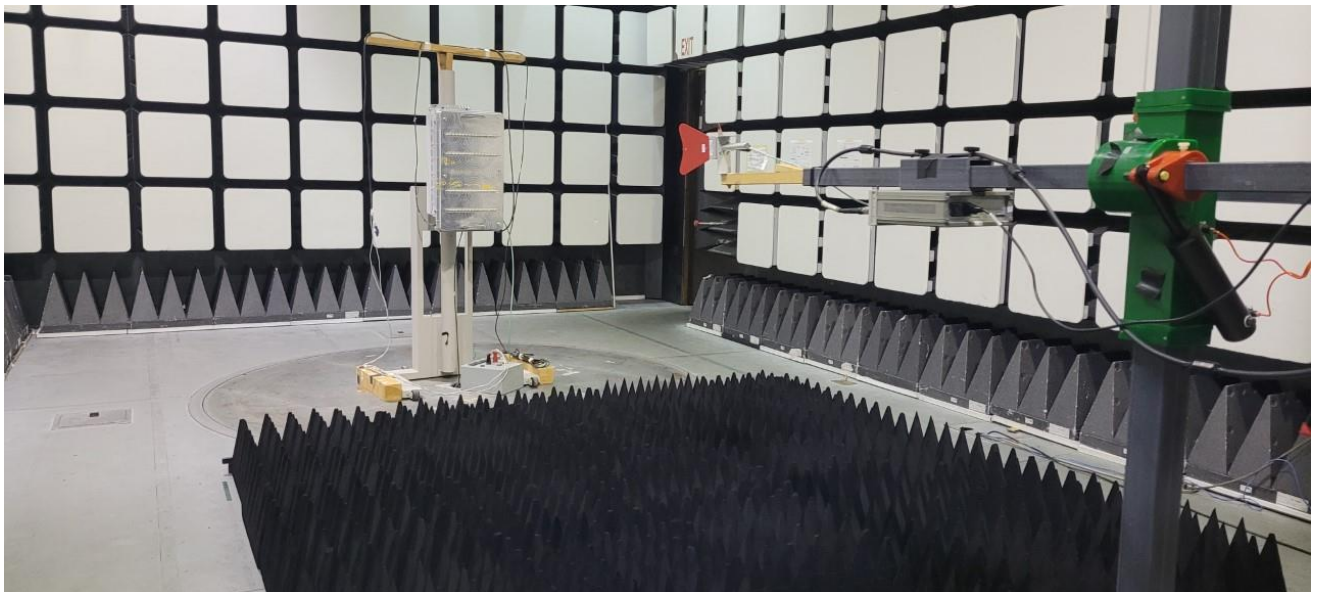

18GHz – 26.5 GHz

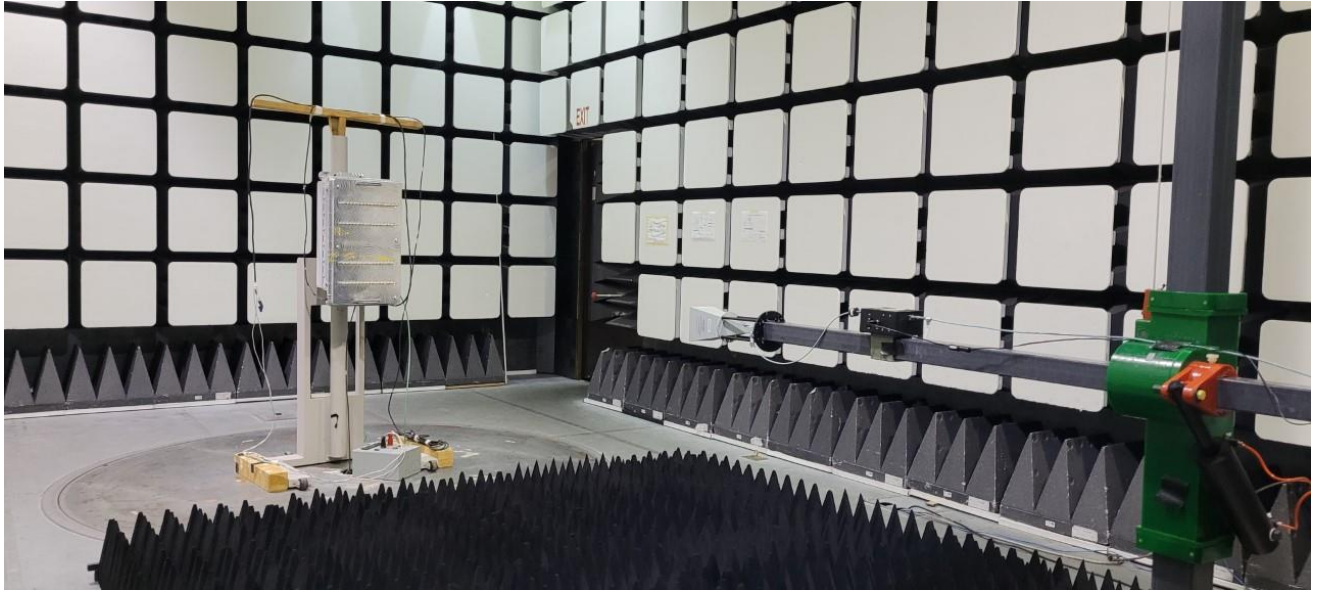

26.5GHz – 40GHz

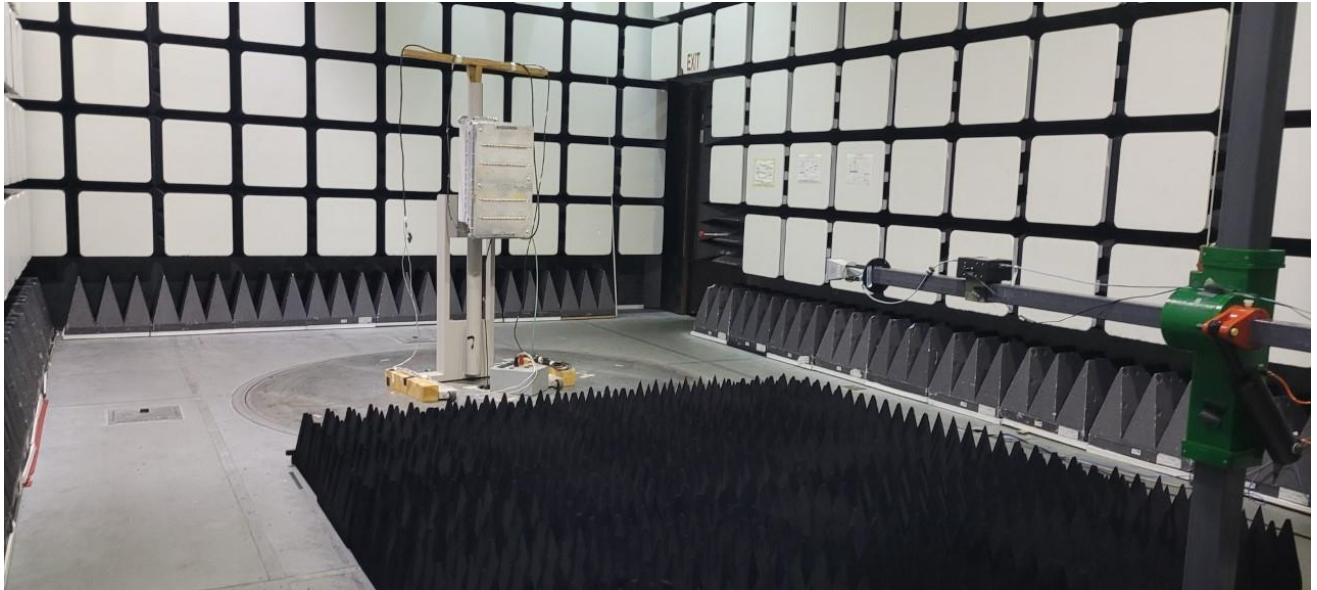

Test Equipment

Asset ID	Manufacturer	Type	Description	Model	Serial	Calibration Date	Calibration Due
E1452	A-Info	Horn Antenna	18 to 26.5 GHz WR42 25 dB	LB-42-25-C2-KF	J202066361	2020-07-24	2023-07-24
E1375	A-Info	Horn Antenna	26.5-40GHz WR28 25 dB	LB-28-25-C2-KF	J202023249	2020-07-27	2023-07-27
E766	A.H. Systems Inc.	Biological Antenna	25 - 2000 MHz	SAS-521-2	457	2021-05-18	2023-05-18
E1525	A.H. Systems Inc.	Pre-Amplifier	18 GHz-40 GHz, 37 dB	PAM-1840VH	186	2020-11-30	2022-11-30
E1073	ETS Lindgren	Horn Antenna	Double-Ridged Waveguide Horn 1-18 GHz	3117	00135198	2022-01-04	2024-01-04
E1150	Extech	Data Logger	Pressure Humidity Temp Data Logger	SD700	Q752767	2021-01-11	2023-01-11
E447	Hewlett Packard	Pre-Amplifier	Preamplifier 1-26.5 GHz	8449B	3008A01384	2020-08-31	2022-08-31
E954	Rohde & Schwarz	Test Receiver	EMI 20Hz - 40GHz - 155 dBm +30 dBm	ESU40	100246	2020-08-03	2022-08-03
E812	Sonoma Instrument Co.	Amplifier	9kHz-1GHz	310N	186744	2020-10-20	2022-10-20
E588	Sunol Sciences Corp	System Controller		SC99V	32802-1	CNR	CNR
E1268	Trilithic	Filter, Low Pass	DC - 1620 MHz	23042	200802040	CNR-V	CNR-V

CNR: Calibration Not Required

CNR-V: Calibration Not Required; Must be Verified

Test Dates: 7/15/22 – 7/20/22

7. FCC Section 2.1055 - Measurement of Frequency Stability

Frequency Stability testing was completed on AEQU Unit with Center Frequency 3500.01 MHz. Testing was performed from 07/21/2022 through 07/25/2022 on the radio, which was located in the T-11 Thermal chamber of the Global Product Compliance Laboratory (GPCL) test facility located in Building 4, Room 4-280, Murray Hill, NJ, by Joe Bordonaro from GPCL.

The temperatures to which the UUT were subjected ranged from a high temperature of +50°C system ambient to a low temperature of -30°C system ambient with measurements recorded at 10C increments

Frequency Stability performance was verified by measuring Frequency Tolerance using an MXA Signal Analyzer. Frequency Tolerance is a measurement of the difference between the actual transmit frequency and the assigned frequency (3500.01 MHz).

Baseline Measurement at +25°C

Transmit Frequency Deviation at +25°C at 100% of Nominal Voltage, -48VDC	
Time (minutes)	Transmit Carrier Deviation (Hz)
0	1.3585
0.5	-3.2727
1.0	-4.1493
1.5	1.3618
2.0	-3.3037
2.5	3.1329
3.0	3.8073
FCC SPECIFICATION	3500.01 MHz (±0.05ppm) ±0.05ppm = ± 175Hz
FCC RESULT	PASS

Transmit Frequency Deviation at +50°C at 100% of Nominal Voltage, -48VDC	
Time (minutes)	Transmit Carrier Deviation (Hz)
0	-2.4813
0.5	-1.8058
1.0	-12.230
1.5	5.0433
2.0	-4.6845
2.5	9.4401
3.0	-7.5572
FCC SPECIFICATION	3500.01 MHz (±0.05ppm) ±0.05ppm = ± 175Hz
FCC RESULT	PASS

Transmit Frequency Deviation at +40°C at 100% of Nominal Voltage, -48VDC	
Time (minutes)	Transmit Carrier Deviation (Hz)
0	-5.3117
0.5	-6.4088
1.0	3.4728
1.5	1.8974
2.0	-5.3340
2.5	433.90mHz
3.0	2.5781
FCC SPECIFICATION	3500.01 MHz (±0.05ppm) ±0.05ppm = ± 175Hz
FCC RESULT	PASS

Transmit Frequency Deviation at +30°C at 100% of Nominal Voltage, -48VDC	
Time (minutes)	Transmit Carrier Deviation (Hz)
0	-88.72mHz
0.5	2.5572
1.0	69.362mHz
1.5	1.6636
2.0	6.5773
2.5	3.9144
3.0	-3.5237
FCC SPECIFICATION	3500.01 MHz (±0.05ppm) ±0.05ppm = ± 175Hz
FCC RESULT	PASS

Transmit Frequency Deviation at +20°C at 100% of Nominal Voltage, -48VDC	
Time (minutes)	Transmit Carrier Deviation (Hz)
0	-376.4mHz
0.5	2.1147
1.0	-1.7045
1.5	1.0115
2.0	3.1468
2.5	696.50mHz
3.0	4.4119
FCC SPECIFICATION	3500.01 MHz (±0.05ppm) ±0.05ppm = ± 175Hz
FCC RESULT	PASS

Transmit Frequency Deviation at +10°C at 100% of Nominal Voltage, -48VDC	
Time (minutes)	Transmit Carrier Deviation (Hz)
0	2.0119
0.5	1.0274
1.0	6.2248
1.5	1.5132
2.0	4.2471
2.5	-2.4347
3.0	-412.8mHz
FCC SPECIFICATION	3500.01 MHz (±0.05ppm) ±0.05ppm = ± 175Hz
FCC RESULT	PASS

Transmit Frequency Deviation at 0°C at 100% of Nominal Voltage, -48VDC	
Time (minutes)	Transmit Carrier Deviation (Hz)
0	-3.7966
0.5	3.0502
1.0	2.1986
1.5	1.2114
2.0	-6.3008
2.5	-1.7648
3.0	6.5149
FCC SPECIFICATION	3500.01 MHz (±0.05ppm) ±0.05ppm = ± 175Hz
FCC RESULT	PASS

Transmit Frequency Deviation at -10°C at 100% of Nominal Voltage, -48VDC	
Time (minutes)	Transmit Carrier Deviation (Hz)
0	14.149
0.5	11.601
1.0	2.7155
1.5	-2.8103
2.0	4.2540
2.5	-1.0421
3.0	1.5062
FCC SPECIFICATION	3500.01 MHz (±0.05ppm) ±0.05ppm = ± 175Hz
FCC RESULT	PASS

Transmit Frequency Deviation at -20°C at 100% of Nominal Voltage, -48VDC	
Time (minutes)	Transmit Carrier Deviation (Hz)
0	-12.273
0.5	-1.5723
1.0	-4.2469
1.5	10.012
2.0	1.7462
2.5	-1.8611
3.0	-5.7799
FCC SPECIFICATION	3500.01 MHz (±0.05ppm) ±0.05ppm = ± 175Hz
FCC RESULT	PASS

Transmit Frequency Deviation at -30°C at 100% of Nominal Voltage, -48VDC	
Time (minutes)	Transmit Carrier Deviation (Hz)
0	-3.1437
0.5	201.07mHz
1.0	-9.1115
1.5	3.1814
2.0	-1.6648
2.5	3.3382
3.0	-12.764
FCC SPECIFICATION	3500.01 MHz (±0.05ppm) ±0.05ppm = ± 175Hz
FCC RESULT	PASS

Upon return to +25°C.

Transmit Frequency Deviation at +25°C at 100% of Nominal Voltage, -48VDC	
Time (minutes)	Transmit Carrier Deviation (Hz)
0	3.1675
0.5	3.5935
1.0	2.2600
1.5	2.8356
2.0	6.4704
2.5	-7.1547
3.0	4.1308
FCC SPECIFICATION	3500.01 MHz (±0.05ppm) ±0.05ppm = ± 175Hz
FCC RESULT	PASS

Transmit Frequency Deviation at +25°C at 103% of Nominal Voltage, -49.44VDC	
Time (minutes)	Transmit Carrier Deviation (Hz)
0	7.8355
0.5	-2.7558
1.0	1.7392
1.5	-2.7123
2.0	-1.7579
2.5	-5.5250
3.0	-3.2683
FCC SPECIFICATION	3500.01 MHz (±0.05ppm) ±0.05ppm = ± 175Hz
FCC RESULT	PASS

Transmit Frequency Deviation at +25°C at 106% of Nominal Voltage, -50.88VDC	
Time (minutes)	Transmit Carrier Deviation (Hz)
0	-1.3365
0.5	-3.1338
1.0	1.7297
1.5	96.214mHz
2.0	-1.5848
2.5	1.8274
3.0	-3.1533
FCC SPECIFICATION	3500.01 MHz (±0.05ppm) ±0.05ppm = ± 175Hz
FCC RESULT	PASS

Transmit Frequency Deviation at +25°C at 109% of Nominal Voltage, -52.32VDC	
Time (minutes)	Transmit Carrier Deviation (Hz)
0	-2.1152
0.5	14.300
1.0	587.59mHz
1.5	10.929
2.0	-2.2236
2.5	933.20mHz
3.0	2.2417
FCC SPECIFICATION	3500.01 MHz (±0.05ppm) ±0.05ppm = ± 175Hz
FCC RESULT	PASS

Transmit Frequency Deviation at +25°C at 112% of Nominal Voltage, -53.76VDC	
Time (minutes)	Transmit Carrier Deviation (Hz)
0	5.5135
0.5	2.7271
1.0	-816.2mHz
1.5	1.5748
2.0	-2.0297
2.5	2.2083
3.0	2.8768
FCC SPECIFICATION	3500.01 MHz (±0.05ppm) ±0.05ppm = ± 175Hz
FCC RESULT	PASS

Transmit Frequency Deviation at +25°C at 115% of Nominal Voltage, -55.20VDC	
Time (minutes)	Transmit Carrier Deviation (Hz)
0	13.711
0.5	-1.1201
1.0	2.0263
1.5	2.3660
2.0	5.1558
2.5	390.80mHz
3.0	5.5371
FCC SPECIFICATION	3500.01 MHz (±0.05ppm) ±0.05ppm = ± 175Hz
FCC RESULT	PASS

Transmit Frequency Deviation at +25°C at 100% of Nominal Voltage, -48.0VDC	
Time (minutes)	Transmit Carrier Deviation (Hz)
0	1.3704
0.5	213.16mHz
1.0	-1.2319
1.5	-2.4576
2.0	1.6981
2.5	-2.9335
3.0	-4.6737
FCC SPECIFICATION	3500.01 MHz (±0.05ppm) ±0.05ppm = ± 175Hz
FCC RESULT	PASS

Transmit Frequency Deviation at +25°C at -3% of Nominal Voltage, -46.56VDC	
Time (minutes)	Transmit Carrier Deviation (Hz)
0	1.1902
0.5	-1.8084
1.0	-1.5811
1.5	-2.0636
2.0	2.3783
2.5	1.8157
3.0	22.96mHz
FCC SPECIFICATION	3500.01 MHz (±0.05ppm) ±0.05ppm = ± 175Hz
FCC RESULT	PASS

Transmit Frequency Deviation at +25°C at -6% of Nominal Voltage, -45.12VDC	
Time (minutes)	Transmit Carrier Deviation (Hz)
0	1.9176
0.5	-4.8123
1.0	1.8942
1.5	-404.3mHz
2.0	-2.3905
2.5	2.3277
3.0	92.386mHz
FCC SPECIFICATION	3500.01 MHz (±0.05ppm) ±0.05ppm = ± 175Hz
FCC RESULT	PASS

Transmit Frequency Deviation at +25°C at -9% of Nominal Voltage, -43.68VDC	
Time (minutes)	Transmit Carrier Deviation (Hz)
0	-2.6836
0.5	1.5664
1.0	5.1097
1.5	2.7077
2.0	1.2165
2.5	-4.6069
3.0	9.3073
FCC SPECIFICATION	3500.01 MHz (±0.05ppm) ±0.05ppm = ± 175Hz
FCC RESULT	PASS

Transmit Frequency Deviation at +25°C at -12% of Nominal Voltage, -42.24VDC	
Time (minutes)	Transmit Carrier Deviation (Hz)
0	-2.5642
0.5	-1.5572
1.0	2.8056
1.5	-11.010
2.0	-4.6133
2.5	-2.8280
3.0	-2.6790
FCC SPECIFICATION	3500.01 MHz (±0.05ppm) ±0.05ppm = ± 175Hz
FCC RESULT	PASS

Transmit Frequency Deviation at +25°C at -15% of Nominal Voltage, -40.80VDC	
Time (minutes)	Transmit Carrier Deviation (Hz)
0	-855.7mHz
0.5	-1.7586
1.0	1.2030
1.5	2.7842
2.0	9.6630
2.5	-2.7265
3.0	5.7039
FCC SPECIFICATION	3500.01 MHz (±0.05ppm) ±0.05ppm = ± 175Hz
FCC RESULT	PASS

Photographs

Radio in thermal chamber



Setup

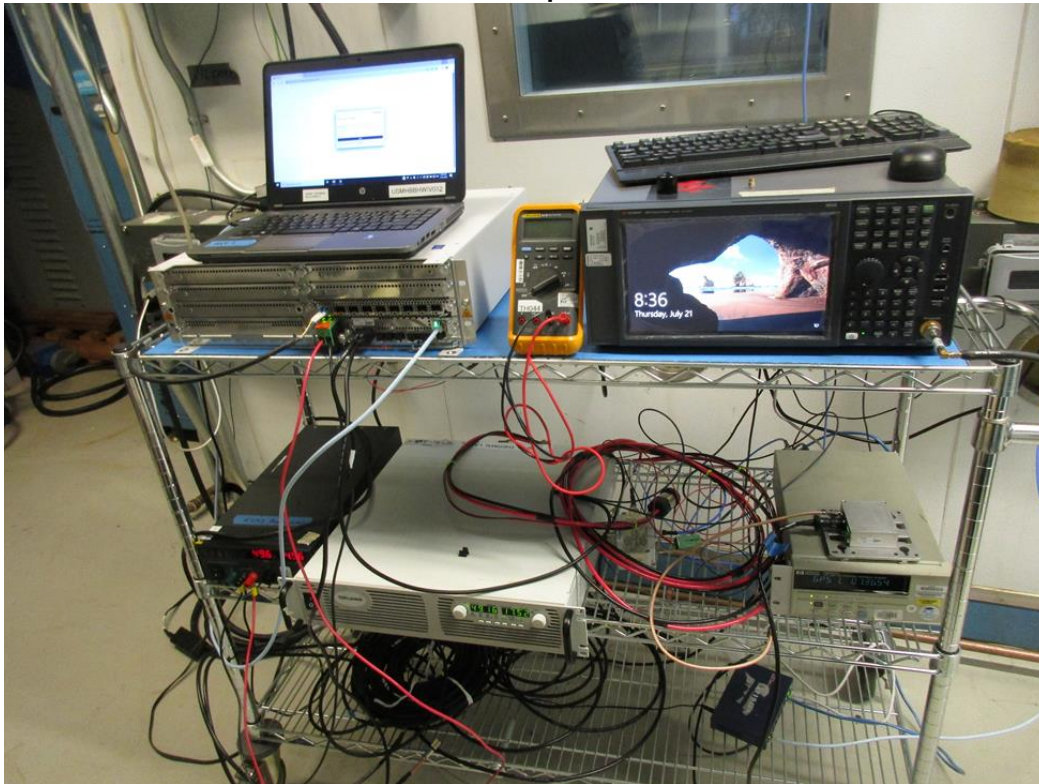

Chamber Temperature Plot

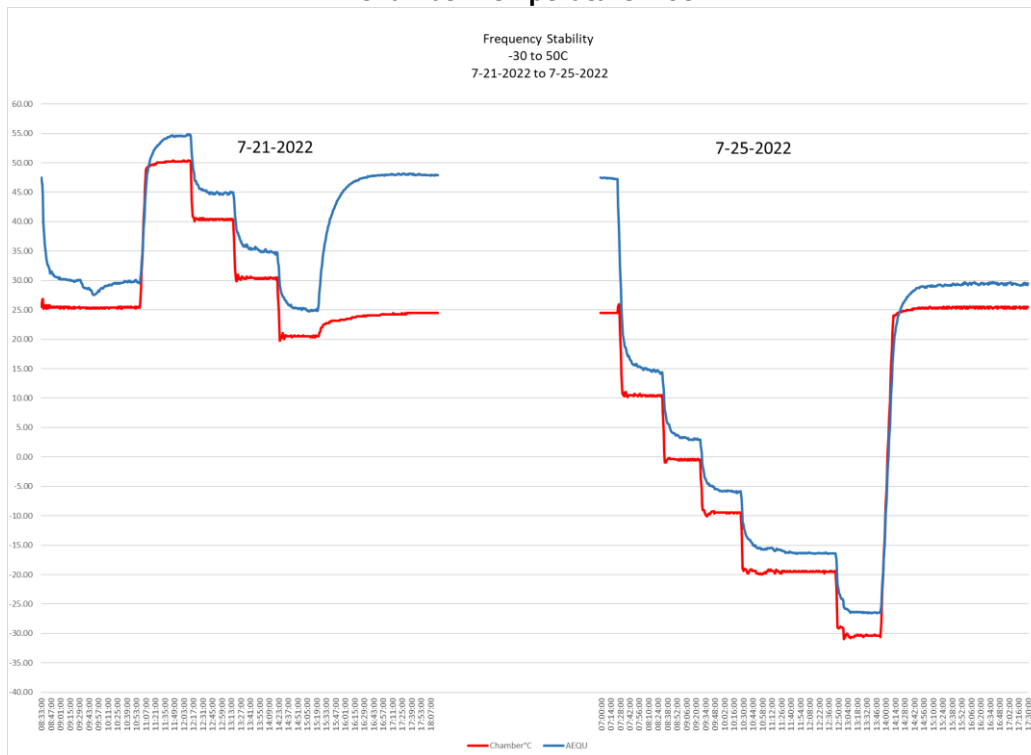

Test Equipment

Asset ID	Manufacturer	Type	Description	Model	Serial	Calibration Date	Calibration Due
TH509-T11	Envirotronics	Controller		Envirotronics SPPCM	SP000638	2021-06-08	2023-06-08
TH-T11	Envirotronics	Thermal Chamber		N/A	0999-4722	2020-09-19	2022-09-19
TH069	Extech	Data Logger	Barometric Pressure/Humidity/ Temperature	SD700	Q690305	2021-07-20	2023-07-20
TH044	Fluke	Multimeter		83III	74910377	2022-02-24	2024-02-24
TH088	Yokogawa	Data Logger	10 Channel Paperless Recorder	GP10	S5U604860	2020-09-19	2022-09-19
Customer Provided Equipment							
	Keysight	MXA	Signal Analyzer	N9020B	MY59050106	2020-12-27	2022-12-27

Test Dates: 7/21/2022 - 7/25/2022.

8. NVLAP Certificate of Accreditation

United States Department of Commerce
National Institute of Standards and Technology



Certificate of Accreditation to ISO/IEC 17025:2017

NVLAP LAB CODE: 100275-0

Nokia, Global Product Compliance Lab
Murray Hill, NJ

*is accredited by the National Voluntary Laboratory Accreditation Program for specific services,
listed on the Scope of Accreditation, for:*

Electromagnetic Compatibility & Telecommunications

*This laboratory is accredited in accordance with the recognized International Standard ISO/IEC 17025:2017.
This accreditation demonstrates technical competence for a defined scope and the operation of a laboratory quality
management system (refer to joint ISO-ILAC-IAF Communique dated January 2009).*

2021-09-24 through 2022-09-30
Effective Dates





For the National Voluntary Laboratory Accreditation Program