

Global Product Compliance Laboratory
600-700 Mountain Avenue
Room 5B-108
Murray Hill, New Jersey 07974-0636 USA



Title 47 Code of Federal Regulations Test Report

Regulation:

Title 47 CFR FCC Part 96

Client:

NOKIA SOLUTIONS AND NETWORKS

Product Evaluated:

AirScale MAA 64T64R 192AE B48 AEQM

Report Number:

TR-2021-0067-FCC96

Date Issued:

August 5, 2021

This report shall not be reproduced, in whole or in part without the approval of Nokia Global Product Compliance Laboratory. This report must not be used by the recipient to claim product certification, approval, or endorsement by NVLAP, NIST, or any agency of the U.S. Government.

Table of Contents

- 1. SYSTEM INFORMATION AND REQUIREMENTS 4**
 - 1.1 INTRODUCTION 5
 - 1.2 PURPOSE AND SCOPE 5
 - 1.3 EUT DETAILS 5
 - 1.4 TEST REQUIREMENTS..... 7
 - 1.5 TEST STANDARDS & MEASUREMENT PROCEDURES 7
 - 1.6 MEASUREMENT UNCERTAINTY 8
 - 1.7 EXECUTIVE SUMMARY 8
 - 1.8 TEST CONFIGURATIONS 9
- 2. FCC SECTION 2.1046 - RF POWER OUTPUT AND POWER SPECTRAL DENSITY 11**
 - 2.1 RF POWER OUTPUT..... 11
 - 2.2 POWER SPECTRAL DENSITY 14
 - 2.3 EIRP COMPLIANCE 16
 - 2.4 PEAK-TO-AVERAGE POWER RATIO (PAPR) 16
- 3. FCC SECTION 2.1047 - MODULATION CHARACTERISTICS 20**
 - 3.1 MODULATION CHARACTERISTICS 20
- 4. FCC SECTION 2.1049 – OCCUPIED BANDWIDTH/EDGE OF BAND EMISSIONS..... 22**
 - 4.1 OCCUPIED BANDWIDTH..... 22
 - 4.2 EDGE OF BAND EMISSIONS..... 30
- 5. FCC SECTION 2.1051 - SPURIOUS EMISSIONS AT TRANSMIT ANTENNA PORT..... 37**
 - 5.1 SECTION 2.1051 SPURIOUS EMISSIONS AT ANTENNA TERMINALS 37
 - 5.2 SPURIOUS EMISSIONS AT ANTENNA TERMINALS RESULTS 38
- 6. SECTION 2.1053 - MEASUREMENT REQUIRED: FIELD STRENGTH OF SPURIOUS RADIATION 45**
 - 6.1 SPURIOUS RADIATION AND RADIATED EMISSIONS REQUIREMENTS. 45
 - 6.2 FIELD STRENGTH OF SPURIOUS RADIATION RESULTS: 46
 - 6.3 TRANSMITTER MEASUREMENTS OF RADIATED SPURIOUS EMISSIONS PLOTS..... 47
- 7. FCC SECTION 2.1055 - MEASUREMENT OF FREQUENCY STABILITY 61**
- 8. NVLAP CERTIFICATE OF ACCREDITATION 72**

Revisions

Date	Revision	Section	Change
7/21/2021	0		Initial Release

Nokia Global Product Compliance Laboratories is accredited by the National Voluntary Laboratory Accreditation Program (NVLAP®) for specific services, listed on the Scope of Accreditation, for: Electromagnetic Compatibility and Telecommunications. This laboratory is accredited in accordance with the recognized International Standard ISO/IEC 17025:2017. This accreditation demonstrates technical competence for a defined scope and the operation of a laboratory quality management system (refer to joint ISO-ILAC-IAF Communiqué dated January 2009). NVLAP LAB CODE: 100275-0.

Nokia Global Product Compliance Laboratory represents to the client that the laboratory’s accreditation or any of its calibration or test reports in no way constitutes or implies product certification, approval, or endorsement by NVLAP, NIST, or any agency of the U.S. Government.

Prepared By: 
 Signed: _____ 8/5/2021
 Ann Chang
 Compliance Engineer
 NVLAP Signatory
 ann.chang@nokia-bell-labs.com

Approved By: 
 Signed: _____ 8/5/2021
 Raymond Johnson
 Technical Manager
 NVLAP Signatory
 ray.johnson@nokia-bell-labs.com

Reviewed By: 
 Signed: _____ 8/5/2021
 Steve Gordon
 EMC Engineer
 NVLAP Signatory
 steve.gordon@nokia-bell-labs.com

1. System Information and Requirements

Report copies and other information not contained in this report are held by either the product engineer or in an identified file at the Global Product Compliance Laboratory in Murray-Hill, NJ.

Equipment Under Test (EUT):	AEQM AirScale MAA 64T64R 192AE B48
Serial Number:	1M211503040, 1M211503041
FCC ID:	VBNAEQM-01
Hardware Version:	092851A.101
Software Version:	STBS21B
Frequency Range:	3550 - 3700 MHz
GPCL Project Number:	2021-0067
Manufacturer:	NOKIA SOLUTIONS AND NETWORKS OY KARAKAARI 7, FI-02610 ESPOO FINLAND
Applicant:	Nokia Solutions and Networks 3201 Olympus Blvd Dallas, Texas 75019 Steve Mitchell
Test Requirement(s):	Title 47 CFR Part96
Test Standards:	<ul style="list-style-type: none"> Title 47 CFR Parts 2 and 96 KDB 940660 D01 Certification And Test Procedures For Citizens Broadband Radio Service Devices Authorized Under Part 96, v03, Oct 29, 2020 KDB 971168 D01 Power Measurement License Digital Systems v03r01 April 9, 2018. KDB 662911 D01 Multiple Transmitter Output v02r01 Oct 2013 ANSI C63.26 (2015) ANSI C63.4 (2014)
Measurement Procedure(s):	<ul style="list-style-type: none"> FCC-IC-OB - GPCL Power Measurement, Occupied Bandwidth & Modulation Test Procedure 6-20-2019 FCC-IC-SE - GPCL Spurious Emissions Test Procedure 6-20-2019
Test Date(s):	5/19/2021 – 6/28/2021 (Radio) 7/1/2021 – 7/9/2021 (Radiated Emission) 6/4/2021 – 6/7/2021 (Frequency Stability)
Test Performed By:	Nokia Global Product Compliance Laboratory 600-700 Mountain Ave. P.O. Box 636 Murray Hill, NJ 07974-0636
Product Engineer(s):	Ron Remy
Lead Engineer:	Steve Gordon
Test Engineer (s):	Jaideep Yadav, Joe Bordonaro, Greg Manuel, Norman Albrecht
Test Results: The EUT, <i>as tested</i> met the above listed Test Requirements. The decision rule employed is binary (Pass/Fail) based on the measured values without accounting for Measurement Uncertainty or any Guard Band. The measured values obtained during testing were compared to a value given in the referenced regulation or normative standard. Report copies and other information not contained in this report are held by either the product engineer or in an identified file at the Global Product Compliance Laboratory in New Providence, NJ.	

1.1 Introduction

This Conformity test report applies to the AirScale MAA 64T64R 192AE B48 AEQM, hereinafter referred to as the Equipment Under Test (EUT).

1.2 Purpose and Scope

This document is to provide the testing data required for qualifying the EUT in compliance with FCC Part 96 measured in accordance with the procedures set out in Section 2.1033 (c) (14) of the Rules.

The purpose of this testing is to demonstrate compliance for **AirScale MAA 64T64R 192AE B48 - AEQM** product for a new FCC Product Certification under FCC ID: VBNAEQM-01. The AEQM is a LTE-TDD transceiver and operates in Band 48 Citizens Broadband Radio Service (CBRS) spectrum (3550-3700 MHz).

The AEQM supports 10MHz and 20 MHz single LTE carriers, plus 10+20 and 20+20 MHz multiple carriers and a maximum total output RF power capacity of 32W at its 64T/64R transmit ports. The AEQM also supports cross-polarized 32T/32R 4 streams per polarization and 64T/64R 8 streams per polarization MIMO operations.

1.3 EUT Details

1.3.1 Specifications

Specification	3GPP/FCC LTE compliant, TDD
Frequency range	3550 - 3700 MHz
Max. supported modulation	QPSK, 16QAM, 64QAM and 256 QAM
Number of TX/RX paths	64T/64R and 32T32R
Polarization	Cross Polarization
Mode of operation	16-Beam 64T64R and 8-Beam 32T32R MIMO
Occupied bandwidth OBW	10/20/30/40 MHz
Maximum number of carriers	2
Support non-contiguous carriers	yes
Total average EIRP	54.81 dBm
Max. output power	0.27 w per TRX and 8.6 W total
Antenna configuration	12, 8, 2 ($\pm 45^\circ$ X-polarized)
Max. Antenna gain	24.5dBi for 2-Beam 32T32R and 27.5 dBi for 2-Beam 64T64R with cross polarization
Horizontal beamwidth	15° (boresight)
Vertical beamwidth	6° (boresight)
Horizontal coverage angle	$\pm 45^\circ$ (3 dB), $\pm 60^\circ$ (5 dB)
Vertical steering angle	$\pm 6^\circ$
Dimensions	750 mm (H) x 450 mm (W) x 240 mm (D)

Volume	81 l
Weight	42.2 kg (without mounting brackets)
Supply voltage / Connector type	DC -40.5 V ... -57 V / 2 pole connector
Power Consumption	716 W typical (75% DL duty cycle, 30% RF load) 752 W max (75% DL duty cycle, 100% RF load)

1.3.2 Photographs

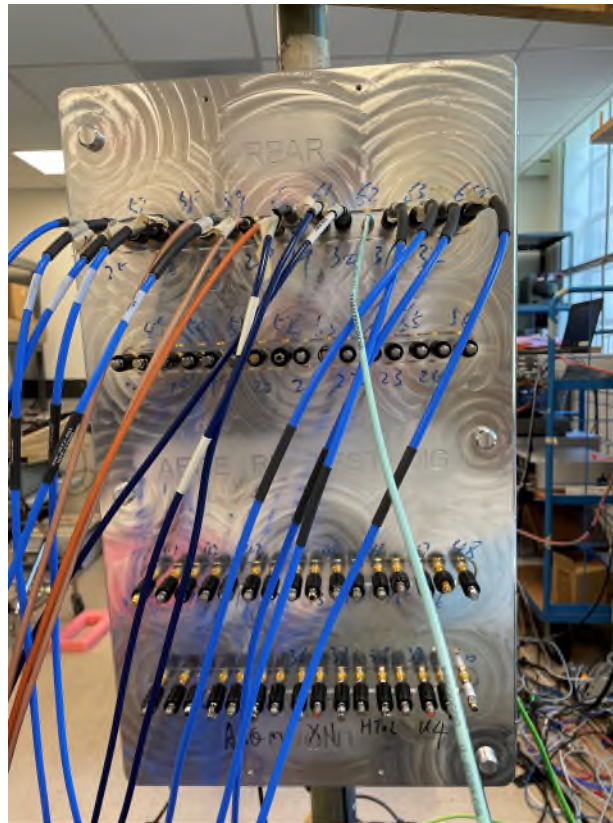

1.4 Test Requirements

Each required measurement is listed below:

47 CFR FCC Sections	Description of Tests	Test Required
2.1046, 96.41 (b) 96.41(g)	RF Power Output (b) Power Limits, EIRP, PSD (g) Peak-to-Average Power Ratio	Yes
2.1047, 96.41(a)	Modulation Characteristics	Yes
2.1049, 96.41(e)(2)(3)	(a) Occupied Bandwidth (b) Out-of-Band Emissions	Yes
2.1051, 96.41(e)	Spurious Emissions at Antenna Terminals	Yes
2.1053, 96.41(e)(2)(3)	Field Strength of Spurious Radiation	Yes
2.1055, 96.41(e)(2)(3)	Measurement of Frequency Stability	Yes

1.5 Test Standards & Measurement Procedures

1.5.1 Test Standards

- Title 47 Code of Federal Regulations, Federal Communications Commission Part 2.
- Title 47 Code of Federal Regulations, Federal Communications Commission Part 96.
- KDB 940660 D01 Certification And Test Procedures For Citizens Broadband Radio Service Devices Authorized Under Part 96, v03, Oct 29, 2020
- KDB 971168 D01 Power Measurement License Digital Systems v03r01 April 9, 2018.
- KDB 662911 D01 Multiple Transmitter Output v02r01 Oct 2013
- ANSI C63.26-2015, American National Standard for Compliance Testing of Transmitters Used in Licensed Radio Services
- ANSI C63.4-2014, American National Standard for Methods of Measurement of Radio-Noise Emissions from Low-Voltage Electrical and Electronic Equipment in the Range of 9 kHz to 40 GHz

1.5.2 Measurement Procedures

- FCC-IC-OB - GPCL Power Measurement, Occupied Bandwidth & Modulation Test Procedure 6-20-2019
- FCC-IC-SE - GPCL Spurious Emissions Test Procedure 6-20-2019

1.6 MEASUREMENT UNCERTAINTY

The results of the calculations to estimate uncertainties for the several test methods and standards are shown in the Table below. These are the worst-case values.

Worst-Case Estimated Measurement Uncertainties

Standard, Method or Procedure	Condition	Frequency MHz	Expanded Uncertainty (k=2)
a. Classical Emissions, (e.g., ANSI C63.4, CISPR 11, 14, 22, etc., using ESHS 30,	Conducted Emissions	0.009 - 30	±3.5 dB
	Radiated Emissions (AR-6 Semi-Anechoic Chamber)	30 MHz – 200MHz H 30 MHz – 200 MHz V 200 MHz – 1000 MHz H 200 MHz – 1000 MHz V 1 GHz - 18 GHz	±5.1 dB ±5.1 dB ±4.7 dB ±4.7 dB ±3.3 dB

Antenna Port Test	Signal Bandwidth	Frequency Range	Expanded Uncertainty (k=2), Amplitude
Occupied Bandwidth, Edge of Band, Conducted Spurious Emissions	10 Hz	9 kHz to 20 MHz	1.78 dB
	100 Hz	20 MHz to 1 GHz	
	10 kHz to 1 MHz	1 GHz to 10 GHz	
	1MHz	10 GHz to 40 GHz:	
RF Power	10 Hz to 20 MHz	50 MHz to 18 GHz	0.5 dB

1.7 Executive Summary

Requirement 47 CFR FCC Parts 2 and 96	Description of Tests	Result
2.1046, 96.41 (b) 96.41(g)	RF Power Output (b) Power Limits, EIRP, PSD (g) Peak-to-Average Power Ratio	COMPLIES
2.1047, 96.41(a)	Modulation Characteristics	COMPLIES
2.1049, 96.41(e)(2)(3)	(a) Occupied Bandwidth (b) Out-of-Band Emissions	COMPLIES
2.1051, 96.41(e)	Spurious Emissions at Antenna Terminals	COMPLIES
2.1053, 96.41(e)	Field Strength of Spurious Radiation	COMPLIES
2.1055	Measurement of Frequency Stability	COMPLIES

1. **COMPLIES** - Passed all applicable tests.
2. **N/A** – Not Applicable.
3. **NT** – Not Tested.

1.8 Test Configurations

Test Setup for all Antenna Port Measurements

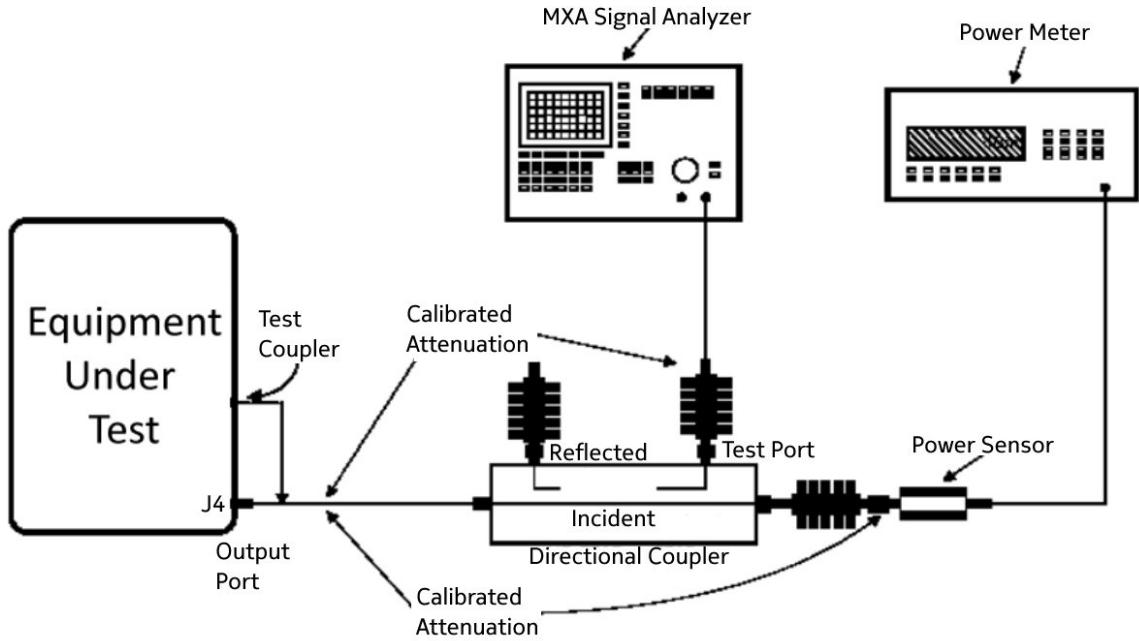

Test Setup for Frequency Stability

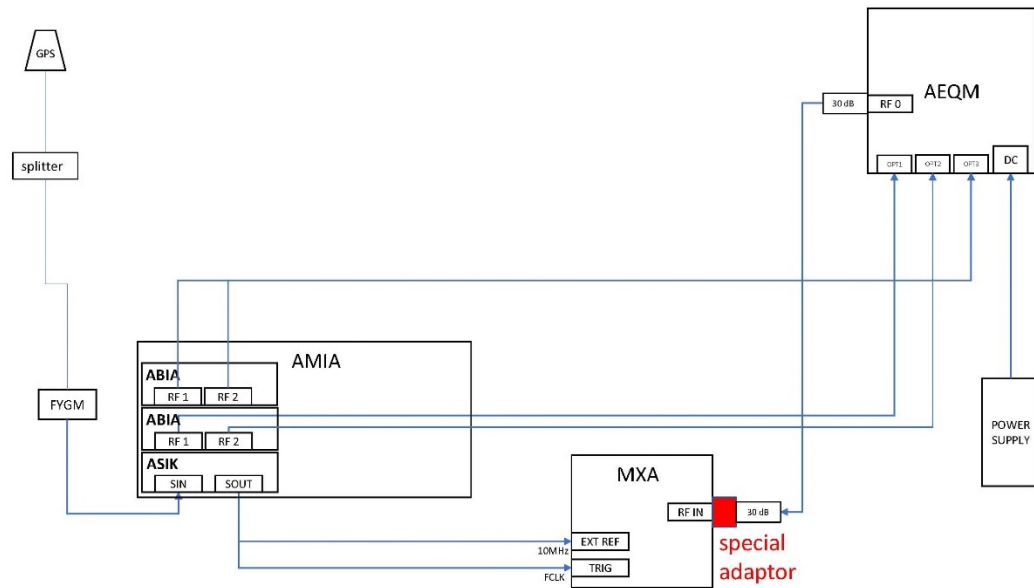

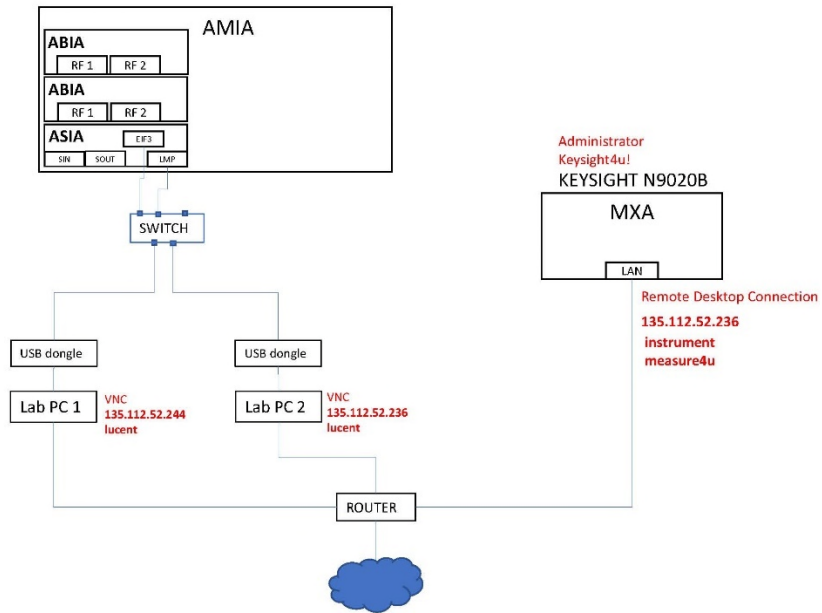

2. FCC Section 2.1046 - RF Power Output and Power Spectral Density

2.1 RF Power Output

2.1.1 Limits

The FCC Part 96.41 requirement for Category B CBSD is that the Output Power of the EUT shall not exceed 47 dBm/10MHz EIRP.

Limit Calculation:

- a. Antenna Gain from Section 1.3.1
 - i. Antenna Gain for 2-Beam 64T64R = 27.5 dBi,
 - ii. Antenna Gain for 2-Beam 32T32R = 24.5 dBi;
- b. Multi-Beam Antenna Gain Reduction
 - i. 16-Beam Reduction = $10^{\ast} \log(1/16)$ dB = -12.04
 - ii. 8-Beam Reduction = $10^{\ast} \log(1/8)$ dB = -9.03
- c. Effective Antenna Gain
 - i. Effective Antenna Gain for 16-Beam 64T64R = 27.5 – 12.04 = 15.46 dBi
 - ii. Effective Antenna Gain for 8-Beam 32T32R = 24.5 – 9.03 = 15.47 dBi

Table 2.1 RF Conducted Output Power Limits

Operation Modes	Effective Antenna Gain (dBi)	FCC 96.41 EIRP Limit (dBm/BW)	Total Conducted Output Power Limit (dBm/BW)	Conducted Output Power Limit per Port (dBm/BW)
16-Beam 64T64R 10MHz	15.46	47	34.55	16.49
8-Beam 32T32R 10MHz	15.47	47	34.54	19.49
16-Beam 64T64R 20MHz	15.46	50.01	37.56	19.50
8-Beam 32T32R 20MHz	15.47	50.01	37.55	22.50
16-Beam 64T64R 10+20MHz	15.46	51.77	39.32	21.26
8-Beam 32T32R 10+20MHz	15.47	51.77	39.31	24.26
16-Beam 64T64R 20+20MHz	15.46	53.02	40.57	22.51
8-Beam 32T32R 20+20MHz	15.47	53.02	40.56	25.51

The limits for 8-Beam 32T32R modes are higher than that for 16-Beam 64T64R modes. Therefore, the output power at the antenna ports for 8-Beam 32T32R modes was evaluated.

2.1.2 Results

Power measurements of the TDD transmit signal were conducted with an MXA Signal analyzer per KDB 971168 D01 and ANSI C63.26. The applied signal from the **AEQM**, met the recommended characteristics as defined in 3GPP TS 36.141 V16.9.0 (2021-04) Technical Specification Group Radio Access Network; Evolved Universal Terrestrial Radio Access (E-UTRA); Base Station (BS) conformance testing (Release 14). The Channel power was measured when the product was set to provide the maximum rated power at the antenna transmitting terminals. The output power of the EUT was measured per ANSI C63.26 methods and procedures and the Channel Power Measurement feature of the MXA Analyzer.

The measured output power at antenna ports was documented in the table below. The Maximum Average RF Power Values are bolded in each configuration.

Table 2.2 RF Power Output Results (8-Beam 32T32R Modes)

# of Carriers	Test Model	Modulation	TX Port	Channel Frequency MHz	Signal BW MHz	Channel Power dBm/BW	Channel Power Limit dBm/BW	Results
1	1.1	QPSK	3	3555	10	18.32	19.49	Pass
1	1.1	QPSK	3	3625	10	18.33	19.49	Pass
1	1.1	QPSK	3	3695	10	18.30	19.49	Pass
1	1.1	QPSK	3	3560	20	21.16	22.50	Pass
1	1.1	QPSK	3	3625	20	21.26	22.50	Pass
1	1.1	QPSK	3	3690	20	21.27	22.50	Pass
2 (Contiguous)	1.1	QPSK	3	3555+3570	10+20	22.55	24.26	Pass
2 (Contiguous)	1.1	QPSK	3	3625+3640	10+20	22.62	24.26	Pass
2 (Contiguous)	1.1	QPSK	3	3675+3690	10+20	23.27	24.26	Pass
2 (Contiguous)	1.1	QPSK	3	3560+3580	20+20	24.29	25.51	Pass
2 (Contiguous)	1.1	QPSK	3	3625+3645	20+20	24.23	25.51	Pass
2 (Contiguous)	1.1	QPSK	3	3670+3690	20+20	24.24	25.51	Pass

2.1.3 Maximum RF Conducted Output Power Plots

NOTE: Only a sample of the plots are used in this report. The full suite of raw data resides at the MH, New Jersey location.

Test Model 1.1 Modulation QPSK Mode 8-Beam 32T32R

1CC, 10MHz BW
Channel Frequency 3625MHz

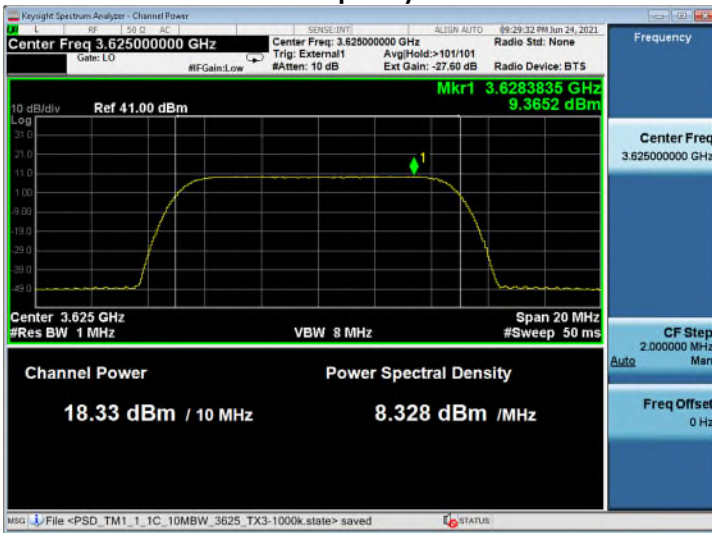

1CC, 20MHz BW
Channel Frequency 3690MHz

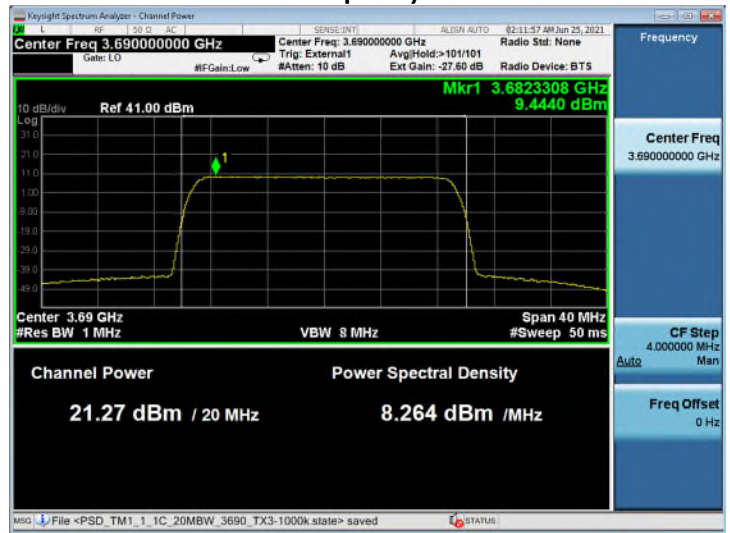

2CC, 10+20 MHz BW
Channel Frequency 3675+3690MHz

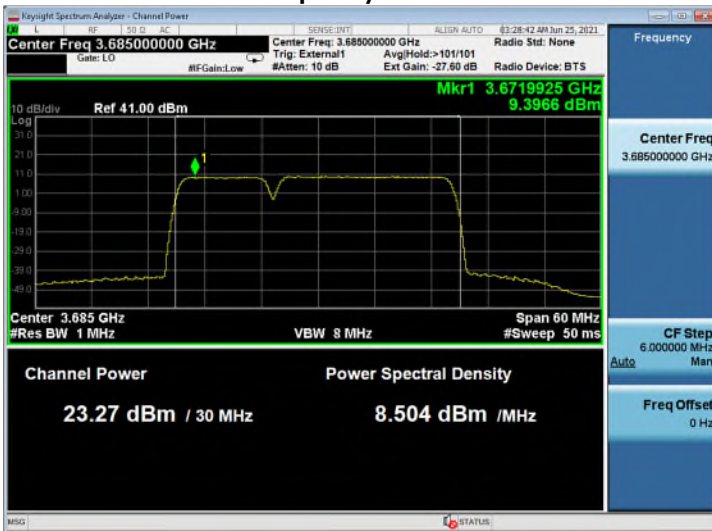

2CC, 20+20 MHz BW
Channel Frequency 3560+3580MHz

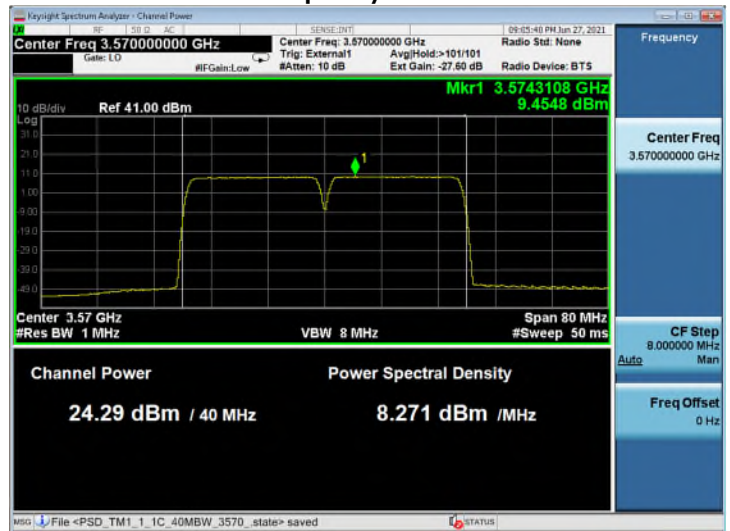

2.2 Power Spectral Density

2.2.1 Limits

The FCC Part 96.41 requirement for Category B CBSD is that the Power Spectral Density (PSD) of the EUT shall not exceed 37 dBm/MHz. The PSD per port limit was derived below.

Table 2.3 RF Conducted Power Spectrum Density Limits

Operation Modes	Effective Antenna Gain (dBi)	FCC 96.41 PSD Limit (dBm/MHz)	Total Conducted PSD Limit (dBm/MHz)	Conducted PSD Limit per Port (dBm/MHz)
16-Beam 64T64R	15.46	37	24.55	6.49
8-Beam 32T32R	15.47	37	24.54	9.49

Both the power and PSD limits for 8-Beam 32T32R modes are 3dB higher than that for 16-Beam 64T64R modes, Therefore, the output power at the antenna ports for 8-Beam 32T32R modes was evaluated only.

2.2.2 Results

The PSD of the EUT was measured per ANSI C63.26 methods and procedures and the PSD Measurement feature of the MXA Analyzer. The PSD was measured when the product was set to provide the maximum rated power at the antenna transmitting terminals. The signal bandwidths, modulations and transmit channels identified in Table below were evaluated. The measured power spectral density level was documented in the table below.

The Maximum Average PSD Values are bolded in each configuration.

Table 2.4 Power Spectral Density Results (8-Beam 32T32R Modes)

# of Carriers	Test Model	Modulation	TX Port	Channel Frequency MHz	Signal BW MHz	PSD Limit dBm/MHz	PSD dBm/MHz	PSD Results Pass/Fail
1	1.1	QPSK	3	3555	10	9.49	9.4609	Pass
1	1.1	QPSK	3	3625	10	9.49	9.3652	Pass
1	1.1	QPSK	3	3695	10	9.49	9.3762	Pass
1	1.1	QPSK	3	3560	20	9.49	9.3077	Pass
1	1.1	QPSK	3	3625	20	9.49	9.2891	Pass
1	1.1	QPSK	3	3690	20	9.49	9.4440	Pass
2 (Contiguous)	1.1	QPSK	3	3555+3570	10+20	9.49	9.1979	Pass
2 (Contiguous)	1.1	QPSK	3	3625+3640	10+20	9.49	9.1902	Pass
2 (Contiguous)	1.1	QPSK	3	3675+3690	10+20	9.49	9.3966	Pass
2 (Contiguous)	1.1	QPSK	3	3560+3580	20+20	9.49	9.4548	Pass
2 (Contiguous)	1.1	QPSK	3	3625+3645	20+20	9.49	9.3219	Pass
2 (Contiguous)	1.1	QPSK	3	3670+3690	20+20	9.49	9.3855	Pass

2.2.3 Maximum Conducted PSD Plots

NOTE: Only a sample of the plots are used in this report. The full suite of raw data resides at the MH, New Jersey location.

Test Model 1.1 Modulation QPSK Mode 8-Beam 32T32R

1CC, 10MHz BW
Channel Frequency 3555MHz

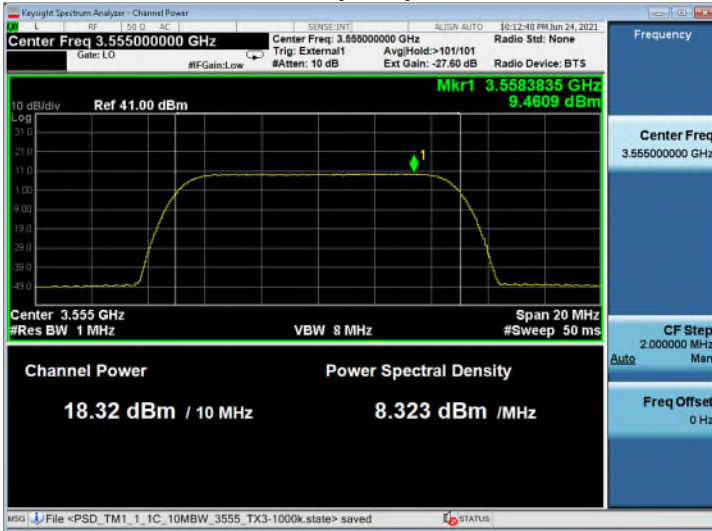

1CC, 20MHz BW
Channel Frequency 3690MHz

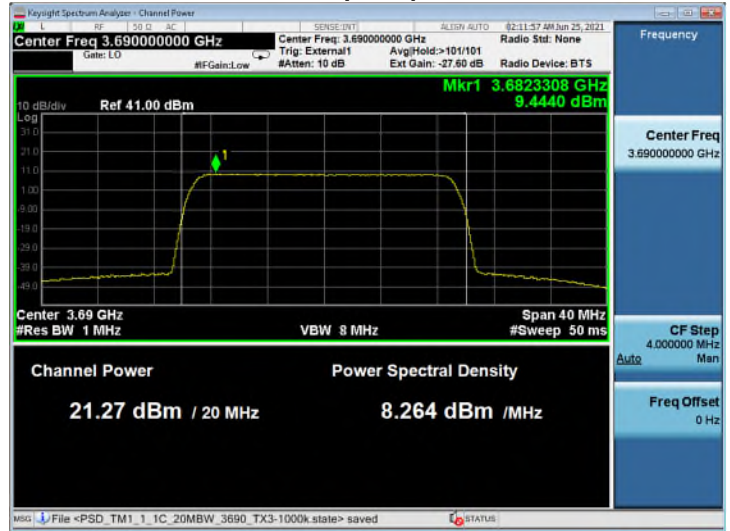

2CC, 10+20 MHz BW
Channel Frequency 3675+3690MHz

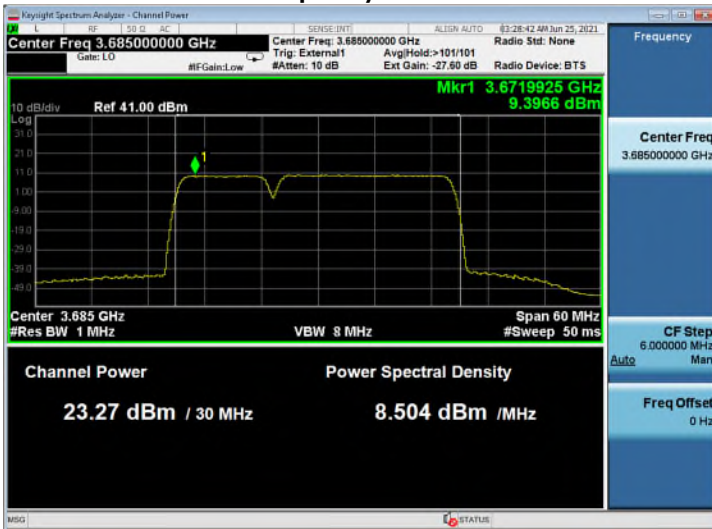

2CC, 20+20 MHz BW
Channel Frequency 3560+3580MHz

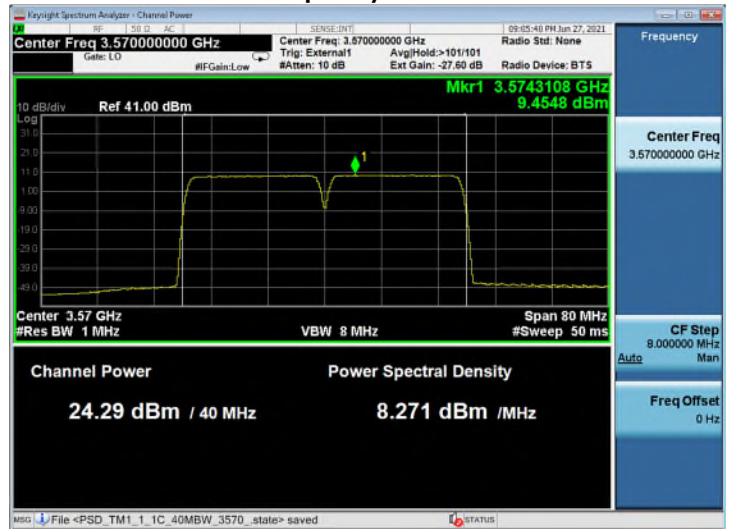

2.3 EIRP Compliance

As stated above, the EUT supports two operation modes:

- 1) 16-Beam 64T64R with two polarizations and
- 2) 8-Beam 32T32R with two polarizations.

Due to the fact that 8-Beam 32T32R mode allows higher conducted power per port. Therefore, only the output power levels for 8-Beam 32T32R modes with various channel bandwidths were evaluated in Section 2.1.

Table 2.5 Maximum Total EIRP Measured

Operation Mode	Maxi Output Power per Port* (dBm)	Maxi Total Conducted Output Power (dBm)	Effective Antenna Gain (dBi)	Total EIRP (dBm/W)	Total EIRP Limit (dBm)	Results
8-Beam 32T32R 10MHz	18.33	33.38	15.47	48.85/76.7	50.0	Pass
8-Beam 32T32R 20MHz	21.27	36.32	15.47	51.79/151.0	53.0	Pass
8-Beam 32T32R 10+20 MHz	23.27	38.32	15.47	53.79/239.3	54.8	Pass
8-Beam 32T32R 20+20 MHz	24.29	39.34	15.47	54.81/302.7	56.0	Pass

*From Table 2.4

The sample calculation for the maximum EIRP as follows,

- The maximum Conducted Output Power per port = 24.29 dBm;
- The maximum Total Conducted Output Power = 24.29 + 10 x log(32) = 39.34 dBm;
- The maximum total EIRP = 39.34 + 15.47 = 54.81 dBm.

2.4 Peak-to-Average Power Ratio (PAPR)

The Peak-to-Average Power Ratio (PAPR) was evaluated per ANSI C63.26 for 8-Beam 32T32R with 5, 10, 10+20, and 20+20 MHz bandwidth. The PAPR values of all carriers measured are below 13dB.

Table 2.6 Peak to Average Power Ratio (8-Beam 32T32R)

# of Carriers	Test Model	Modulation	TX Port	Channel Frequency MHz	Center Frequency MHz	Signal BW MHz	PAR at 0.1% Limit - 13 dB
1	3.2	QPSK/16QAM	15	3555	3555	10	8.62
1	3.1	64QAM	3	3625	3625	10	8.63
1	3.1a	256QAM	12	3695	3695	10	8.86
1	3.1	64QAM	3	3560	3560	20	8.57
1	3.1a	256QAM	3	3625	3625	20	8.44
1	3.1a	256QAM	2	3690	3690	20	8.46
2 (Contiguous)	3.2	QPSK/16QAM	4	3555+3570	3565	10+20	8.56
2 (Contiguous)	3.2	QPSK/16QAM	4	3625+3640	3635	10+20	8.37
2 (Contiguous)	3.2	QPSK/16QAM	4	3675+3690	3585	10+20	8.66
2 (Non-Contiguous)	3.1a	256QAM	12	3555+3690	3555	10+20	9.26
2 (Non-Contiguous)	3.1a	256QAM	12	3555+3690	3690	10+20	8.46
2 (Contiguous)	3.1	64QAM	6	3560+3580	3570	20+20	8.60
2 (Contiguous)	3.2	QPSK/16QAM	4	3560+3580	3570	20+20	8.35
2 (Contiguous)	3.2	QPSK/16QAM	3	3625+3645	3635	20+20	9.08
2 (Contiguous)	3.2	QPSK/16QAM	4	3670+3690	3680	20+20	9.08
2 (Non-Contiguous)	3.1a	256QAM	9	3560+3690	3560	20+20	6.12
2 (Non-Contiguous)	3.1a	256QAM	9	3560+3690	3690	20+20	6.20

Single Carrier - 8-Beam 32T32R 10 MHz

Test Model 3.1a, Modulation 256QAM, Channel Frequency 3695MHz, TX12

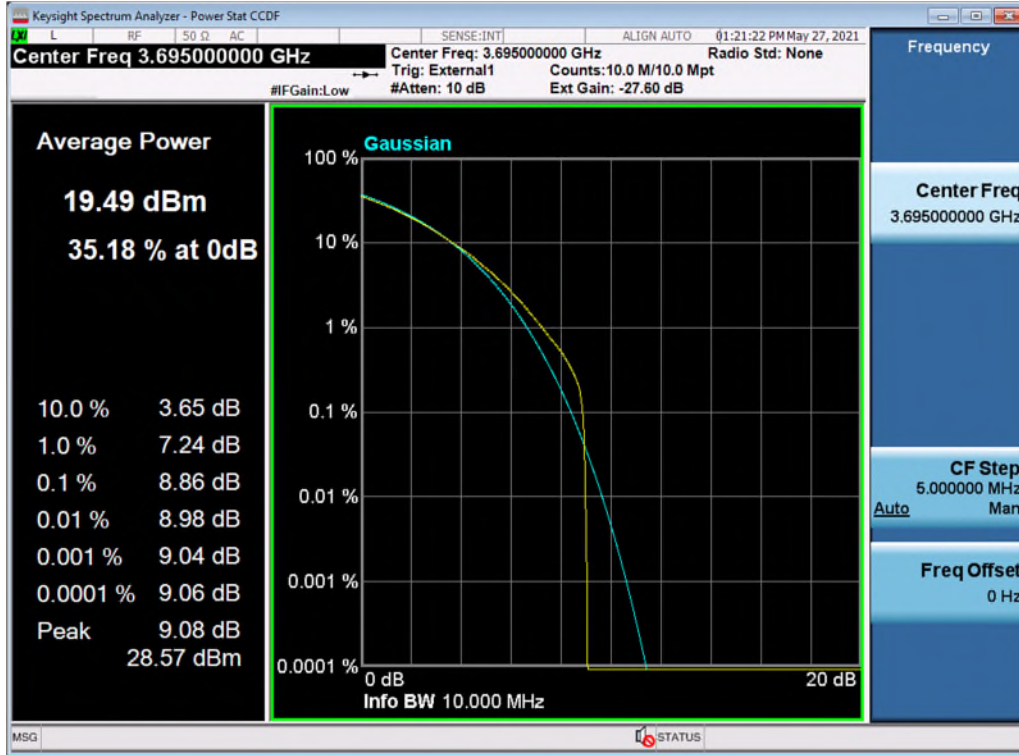

Single Carrier - 8-Beam 32T32R 20 MHz

Test Model 3.1, Modulation 64QAM, Channel Frequency 3560MHz, TX3

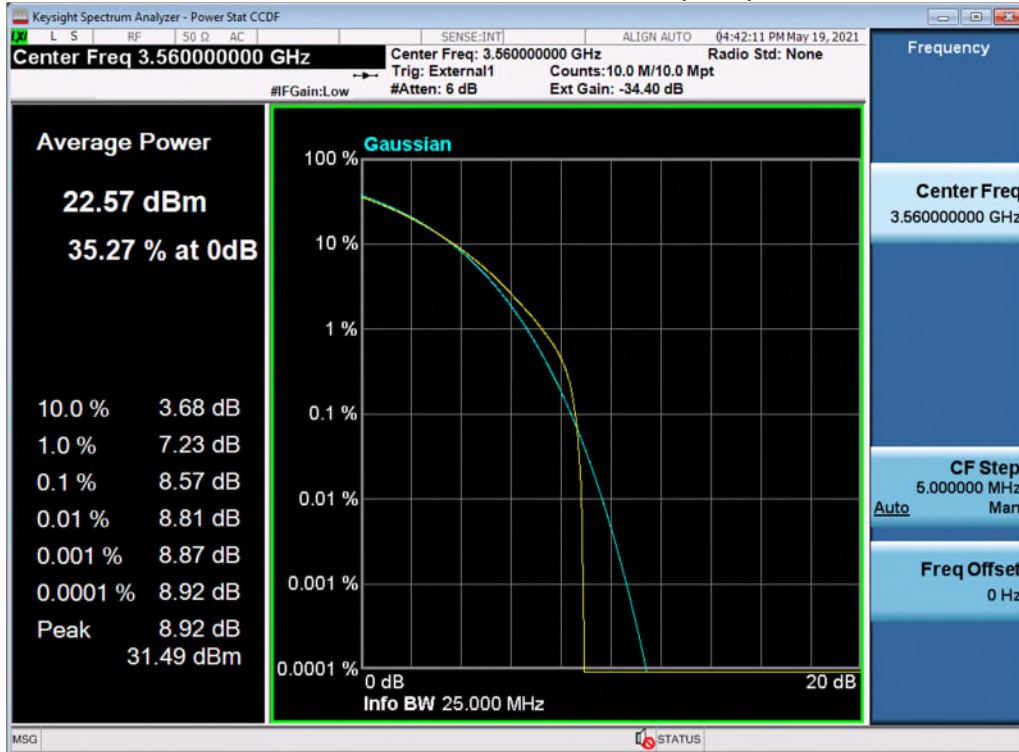

Dual Carrier Contiguous – 8-Beam 32T32R 10+20 MHz
Test Model 3.2, Modulation QPSK/16QAM, Channel Frequency 3675+3690 MHz, TX4

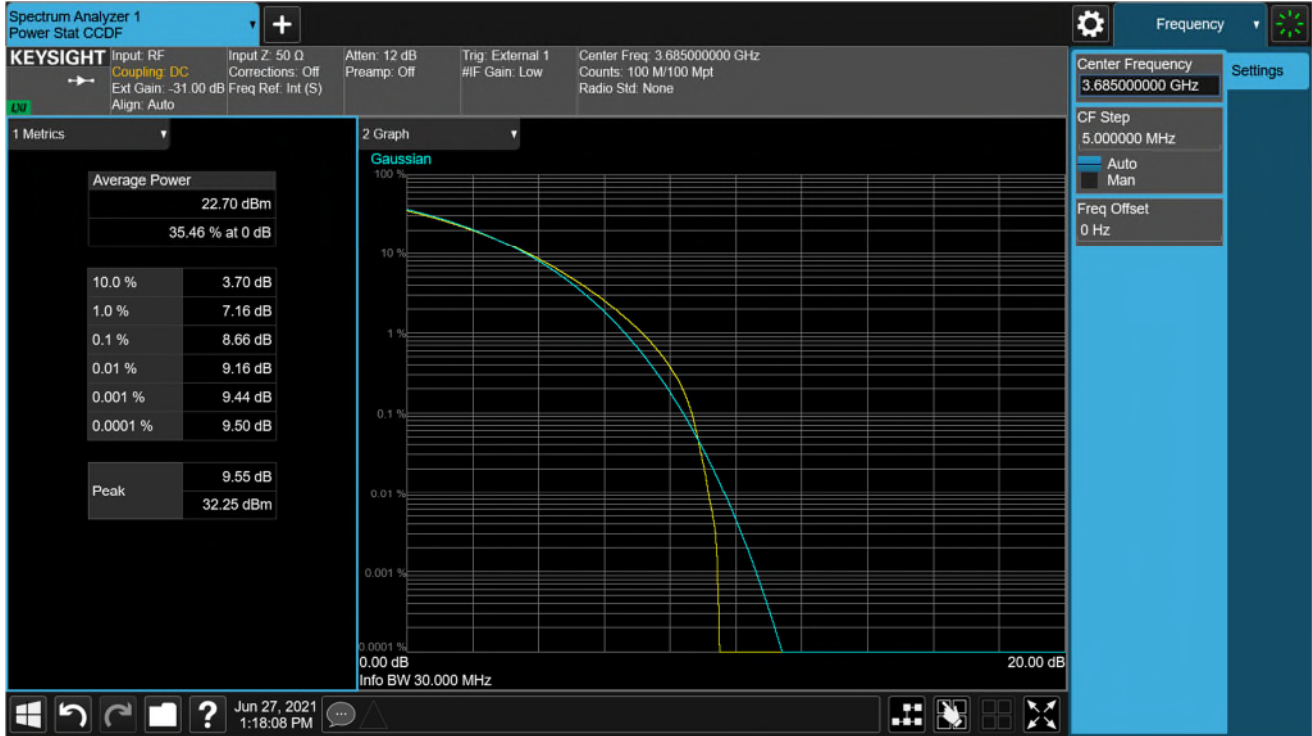

Dual Carrier Non-Contiguous – 8-Beam 32T32R 10+20 MHz
Test Model 3.1a, Modulation 256QAM, Channel Frequency 3555+3690 MHz, TX12

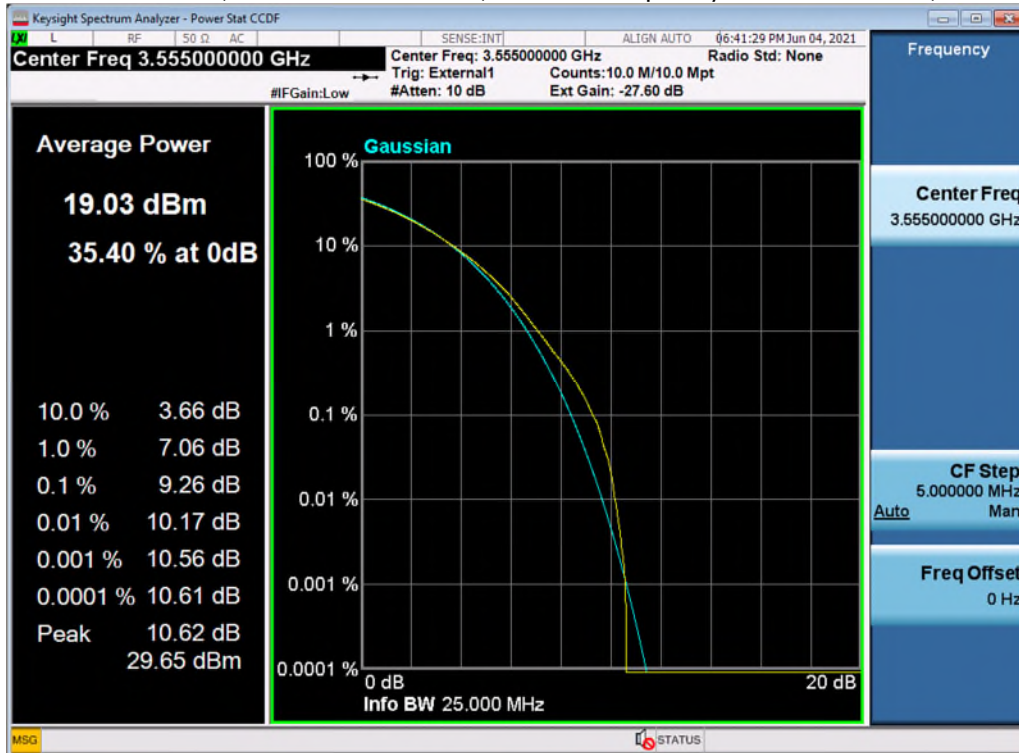

Dual Carrier Contiguous – 8-Beam 32T32R 20+20 MHz
 Test Model 3.2, Modulation QPSK/16QAM, Channel Frequency 3625+3645 MHz, TX3

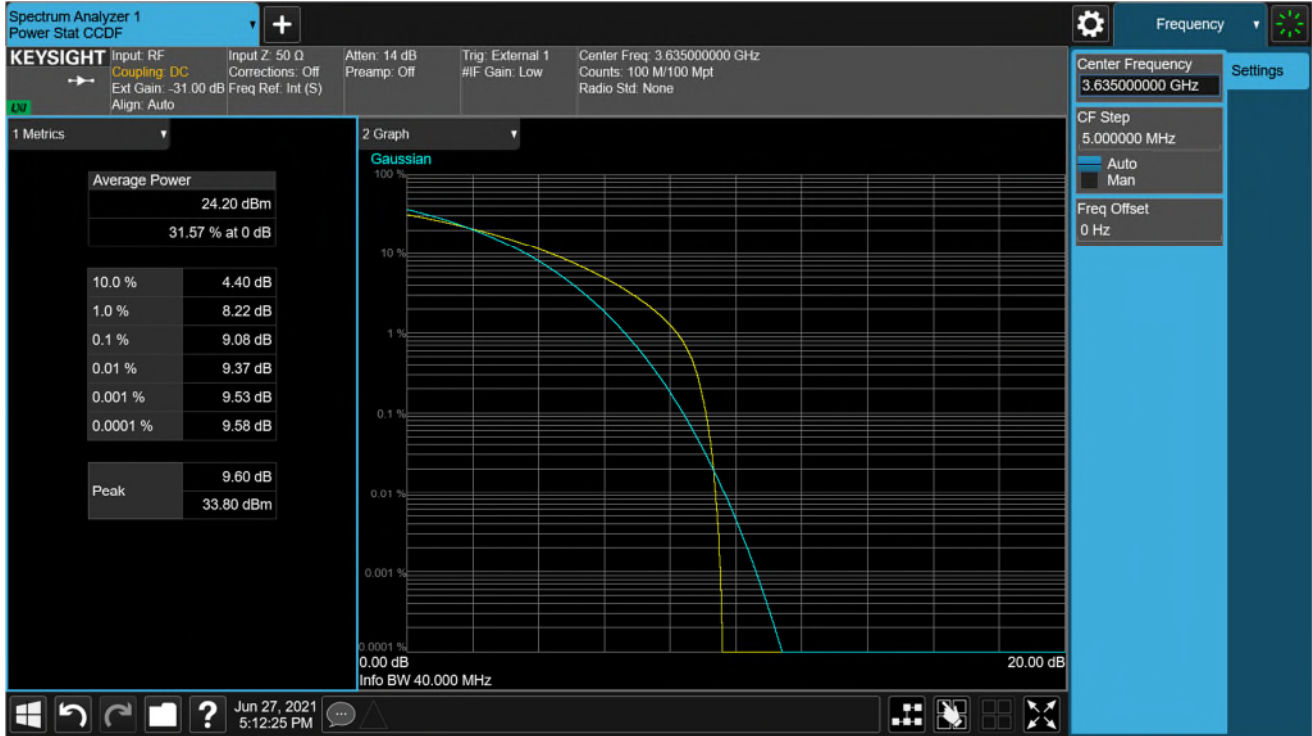

Dual Carrier Non-Contiguous – 20+20 MHz BW
 Test Model 3.1a, Modulation 256QAM, Channel Frequency 3560+3690 MHz, TX9

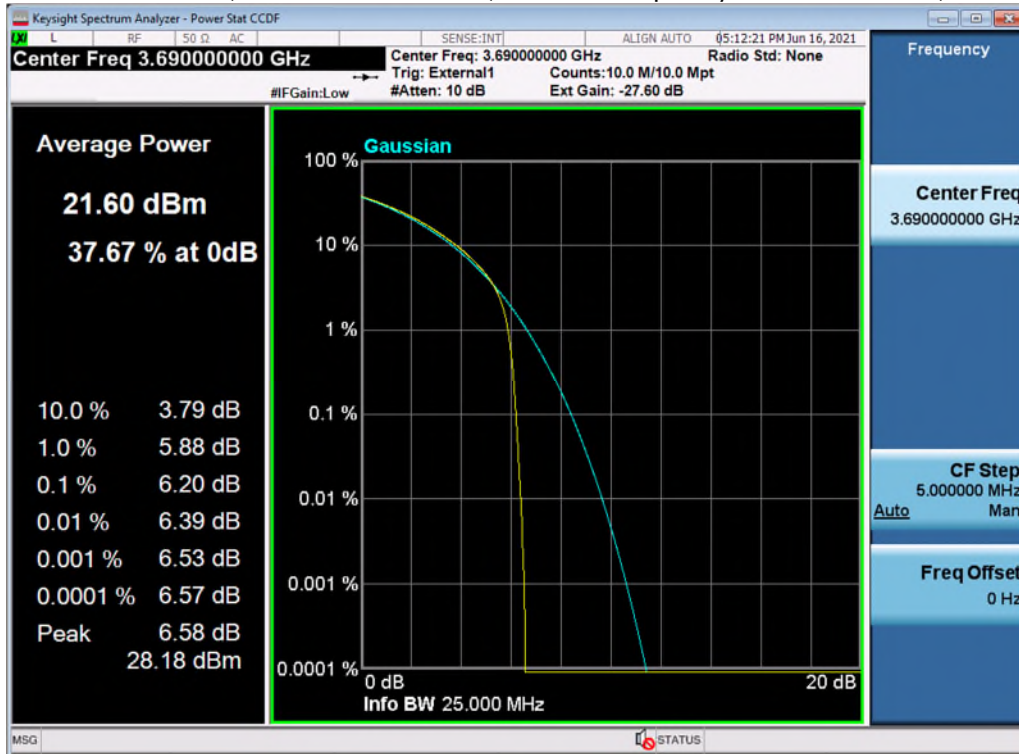

3. FCC Section 2.1047 - Modulation Characteristics

3.1 Modulation Characteristics

The RF signal at the antenna port was demodulated and verified for correctness of the modulation signal used before each test was performed.

3.1.1 Modulation Characteristics – Plots

Modulation QPSK TM1.1

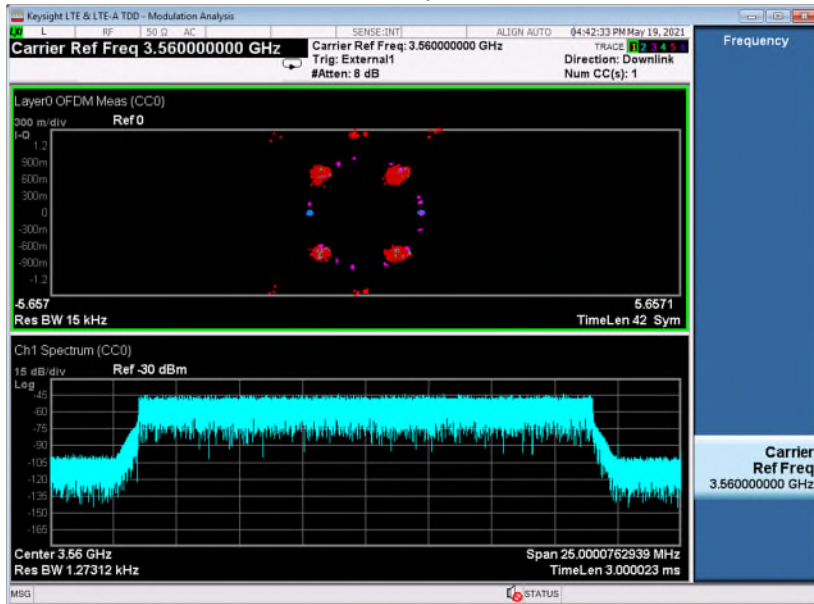

Modulation 64QAM TM3.1

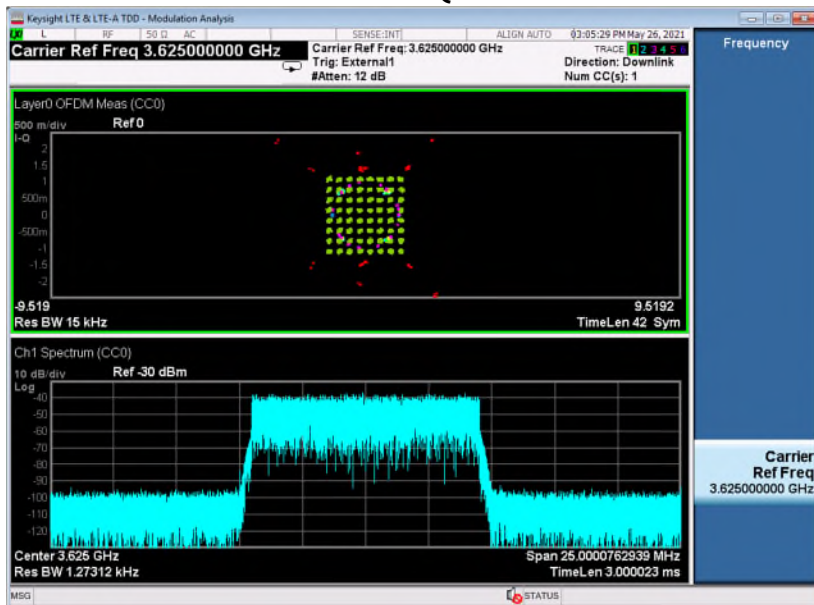

Modulation 256QAM TM3.1a

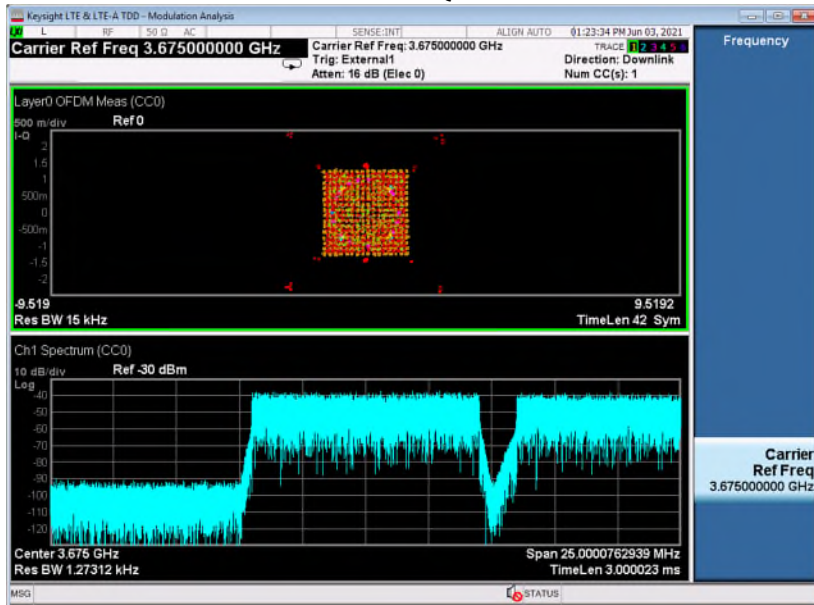

Modulation QPSK/16QAM TM3.2

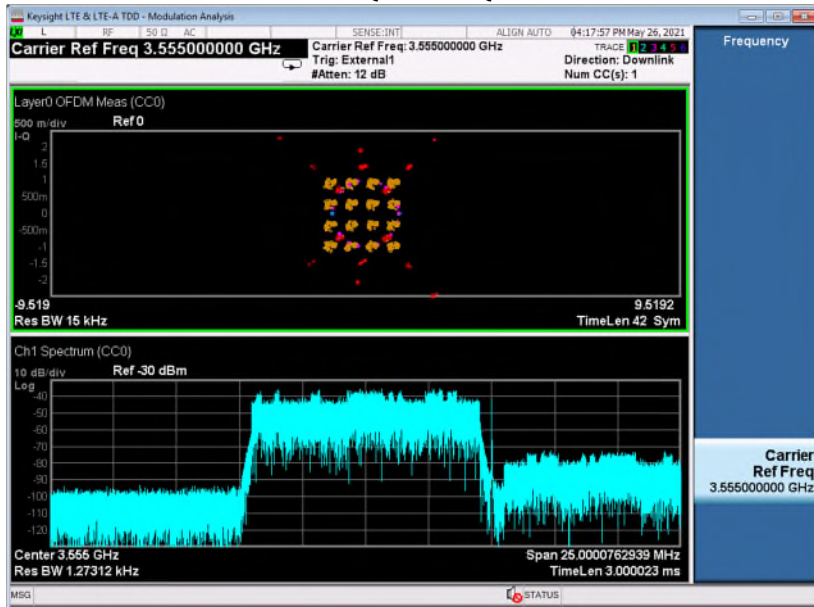

4. FCC Section 2.1049 – Occupied Bandwidth/Edge of Band Emissions

4.1 Occupied Bandwidth

In 47CFR 2.1049 the FCC requires:

“The occupied bandwidth, that is the frequency bandwidth such that, below its lower and above its upper frequency limits, the mean powers radiated are each equal to 0.5 percent of the total mean power radiated by a given emission shall be measured under the following conditions as applicable.”

This required measurement is the 99% Occupied Bandwidth, also called the designated signal bandwidth and needs to be within the parameters of the products specified emissions designator. During these measurements it is customary to evaluate the Edge of Band emissions at block/band edges.

Part 96.41e(3) specified that The fundamental emission bandwidth is defined as the width of the signal between two points, one below the carrier center frequency and one above the carrier center frequency, outside of which all emissions are attenuated at least 26 dB below the transmitter power.

The transmitted signal occupied bandwidth was measured using a Keysight MXA Signal Analyzer. All emissions were within the parameters as required. The 8-Beam 32T32R modes have higher conducted RF output power per port, therefore, 8-Beam 32T32R modes were used for occupied bandwidth and band edge emissions evaluations.

AEQM 99% Occupied Bandwidth (8-Beam 32T32R)

# of Carriers	Test Model	Modulation	TX Port	Channel Frequency MHz	Center Frequency MHz	Signal BW MHz	Occupied BW MHz
1	1.1	QPSK	3	3555	3555	10	8.8551
1	1.1	QPSK	3	3625	3625	10	8.8579
1	1.1	QPSK	3	3695	3695	10	8.8555
1	3.1	64QAM	3	3560	3560	20	17.728
1	1.1	QPSK	3	3625	3625	20	17.733
1	1.1	QPSK	3	3690	3690	20	17.732
2 (Contiguous)	1.1	QPSK	3	3555+3570	3565	10+20	28.15
2 (Contiguous)	1.1	QPSK	3	3625+3640	3635	10+20	28.144
2 (Contiguous)	3.1a	256QAM	14	3675+3690	3685	10+20	28.162
2 (Non-Contiguous)	3.1a	256QAM	12	3555+3690	3555+3690	10+20	9.1767+18.258
2 (Contiguous)	1.1	QPSK	6	3560+3580	3570	20+20	37.655
2 (Contiguous)	1.1	QPSK	8	3625+3645	3635	20+20	37.530
2 (Contiguous)	1.1	QPSK	10	3670+3690	3680	20+20	37.672
2 (Non-Contiguous)	3.1a	256QAM	9	3560+3690	3560+3690	20+20	18.232+18.259

AEQM 26dB Emission Bandwidth

# of Carriers	Test Model	Modulation	TX Port	Channel Frequency MHz	Center Frequency MHz	Signal BW MHz	Occupied BW MHz
1	1.1	QPSK	3	3555	3555	10	9.265
1	1.1	QPSK	3	3625	3625	10	9.268
1	1.1	QPSK	3	3695	3695	10	9.265
1	3.1	64QAM	3	3560	3560	20	18.32
1	1.1	QPSK	3	3625	3625	20	18.33
1	1.1	QPSK	3	3690	3690	20	18.31
2 (Contiguous)	1.1	QPSK	3	3555+3570	3565	10+20	29.18
2 (Contiguous)	1.1	QPSK	3	3625+3640	3635	10+20	29.07
2 (Contiguous)	3.1a	256QAM	14	3675+3690	3685	10+20	29.18
2 (Non-Contiguous)	3.1a	256QAM	12	3555+3690	3555+3690	10+20	9.747+20.0
2 (Contiguous)	1.1	QPSK	6	3560+3580	3570	20+20	39.60
2 (Contiguous)	1.1	QPSK	8	3625+3645	3635	20+20	39.94
2 (Contiguous)	1.1	QPSK	10	3670+3690	3680	20+20	39.58
2 (Non-Contiguous)	3.1a	256QAM	9	3560+3690	3560+3690	20+20	20.0+20.0

4.1.1 Occupied Bandwidth – Plots

NOTE: Only the plots which give the widest bandwidth for each configuration evaluated are used in this report. The full suite of raw data resides at the MH, New Jersey location.

4.1.1.1 99% Occupied Bandwidth Plots

Single Carrier - 8-Beam 32T32R 10 MHz

Test Model 1.1, Modulation QPSK, Channel Frequency 3625MHz, TX3

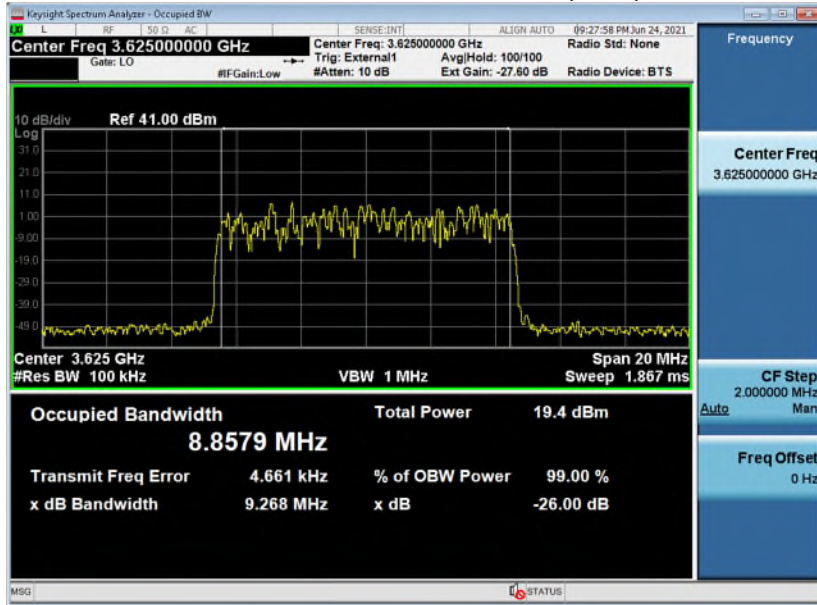

Single Carrier - 8-Beam 32T32R 20 MHz

Test Model 1.1, Modulation QPSK, Channel Frequency 3625MHz, TX3

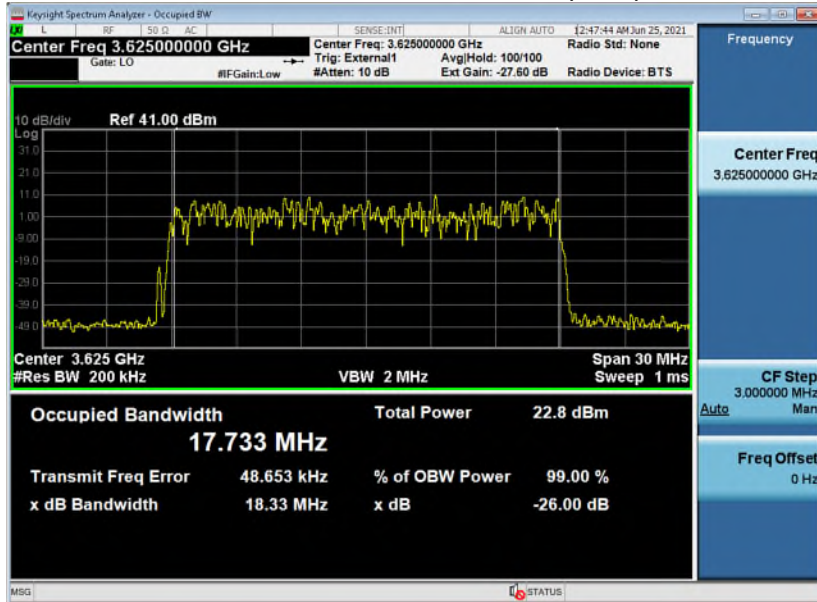

Dual Carrier Contiguous – 8-Beam 32T32R 10+20 MHz
 Test Model 3.1a, Modulation 256QAM, Channel Frequency 3675+3690 MHz, TX14

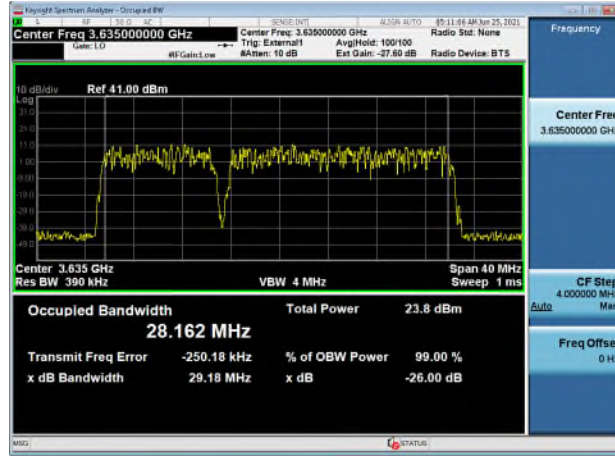

Dual Carrier Non-Contiguous – 8-Beam 32T32R 10+20 MHz
 Test Model 3.1a, Modulation 256QAM, Channel Frequency 3555+3690 MHz, TX12

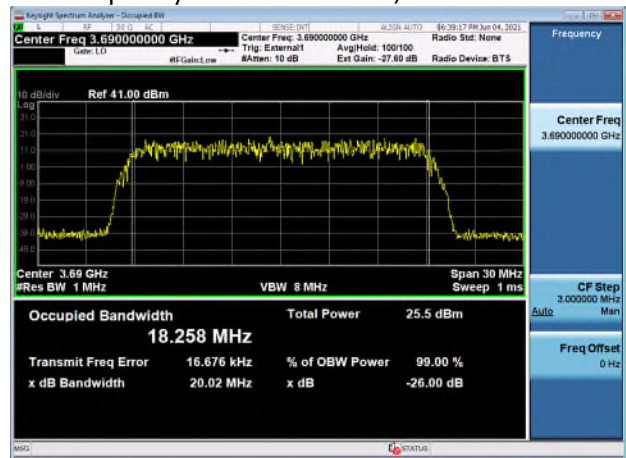
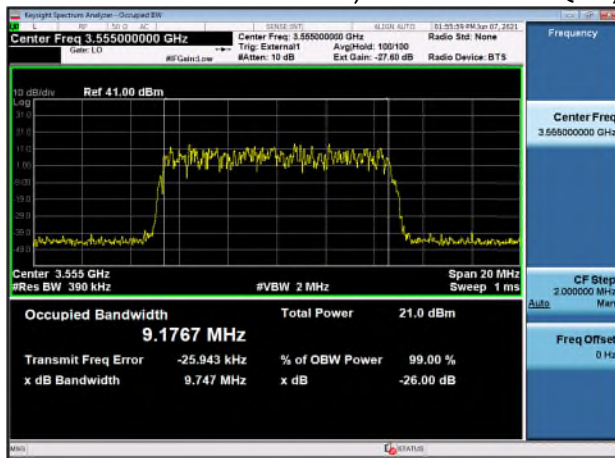

Dual Carrier Contiguous – 8-Beam 32T32R 20+20 MHz
 Test Model 1.1, Modulation QPSK, Channel Frequency 3670+3690 MHz, TX10

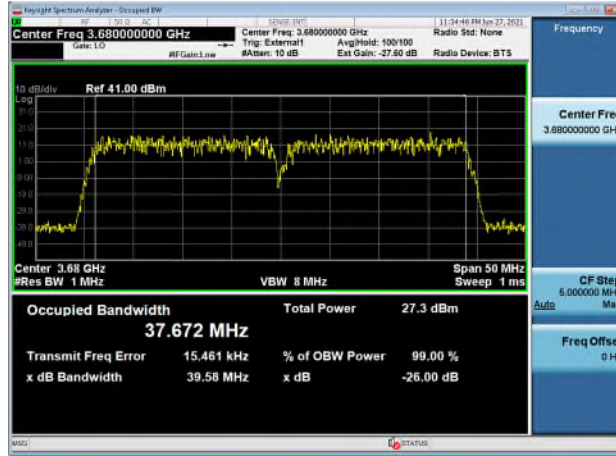

Dual Carrier Non-Contiguous – 8-Beam 32T32R 20+20 MHz
 Test Model 3.1a, Modulation 256QAM, Channel Frequency 3560+3690 MHz, TX9

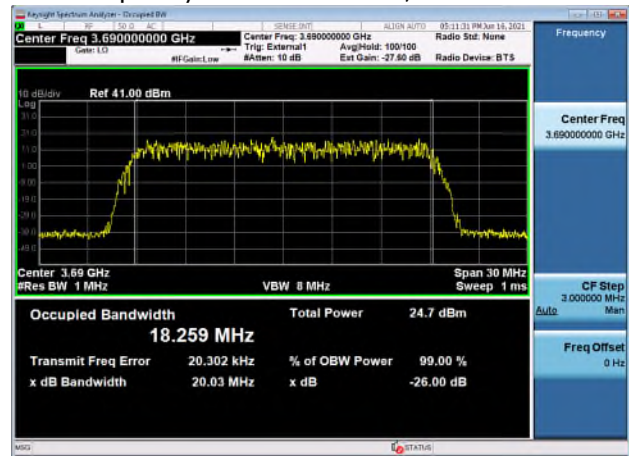
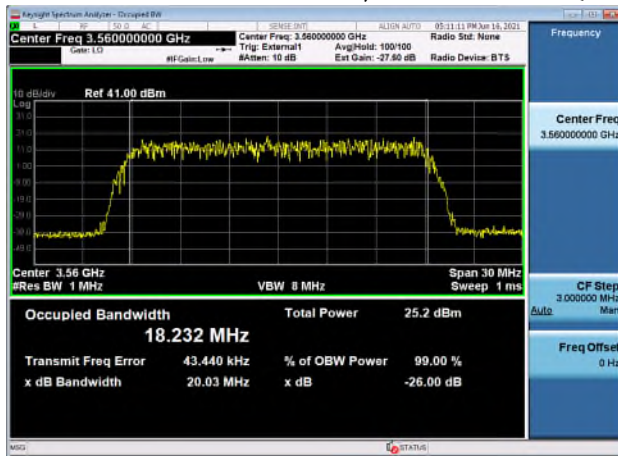

4.1.1.2 26 dB Emission Bandwidth Plots

Single Carrier - 8-Beam 32T32R 10 MHz

Test Model 1.1, Modulation QPSK, Channel Frequency 3625MHz, TX3

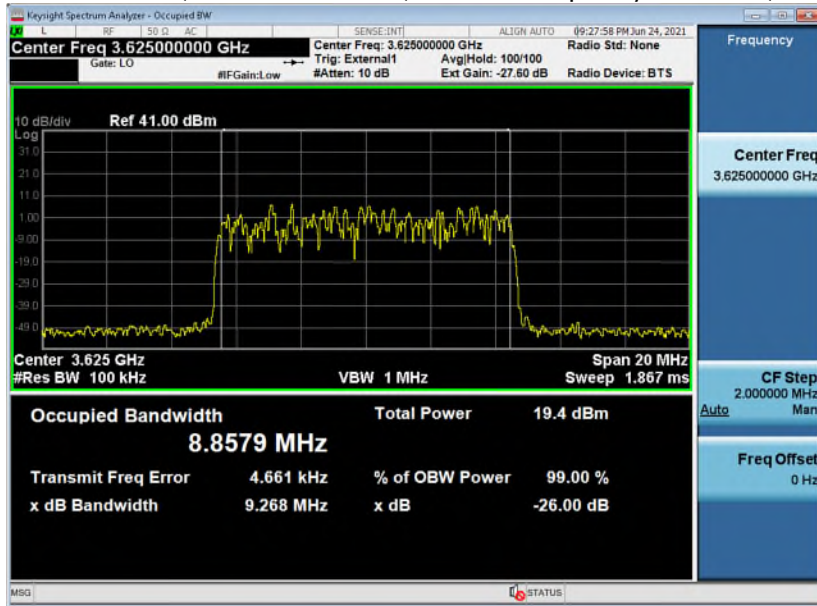

Single Carrier - 8-Beam 32T32R 20 MHz

Test Model 1.1, Modulation QPSK, Channel Frequency 3625MHz, TX3

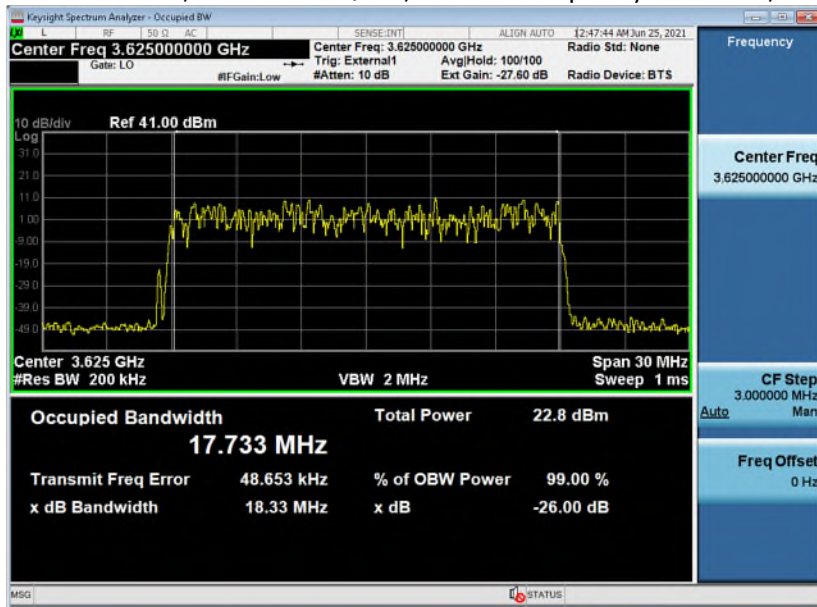

Dual Carrier Contiguous – 8-Beam 32T32R 10+20 MHz
 Test Model 3.1a, Modulation 256QAM, Channel Frequency 3675+3690 MHz, TX14

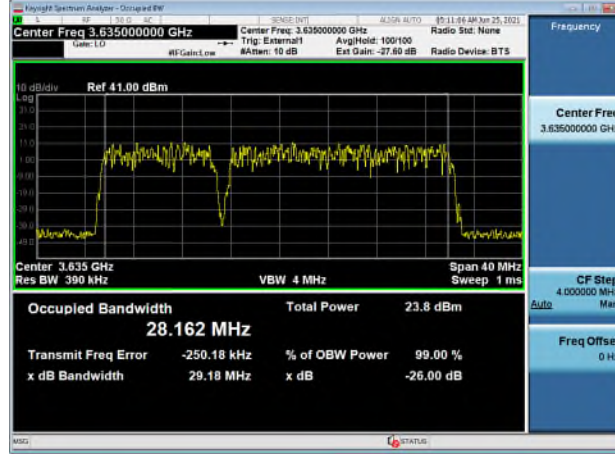

Dual Carrier Non-Contiguous – 8-Beam 32T32R 10+20 MHz
 Test Model 3.1a, Modulation 256QAM, Channel Frequency 3555+3690 MHz, TX12

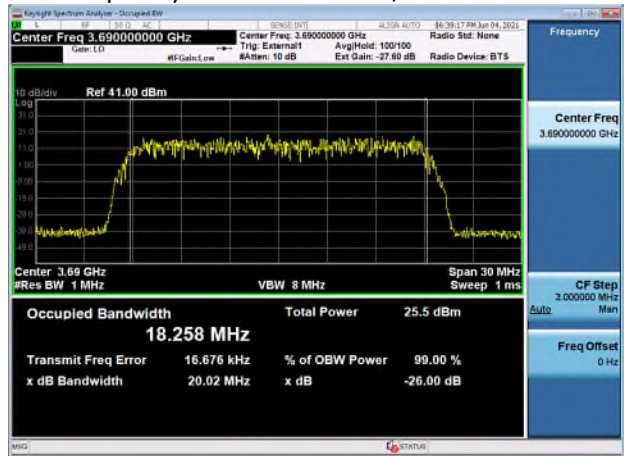
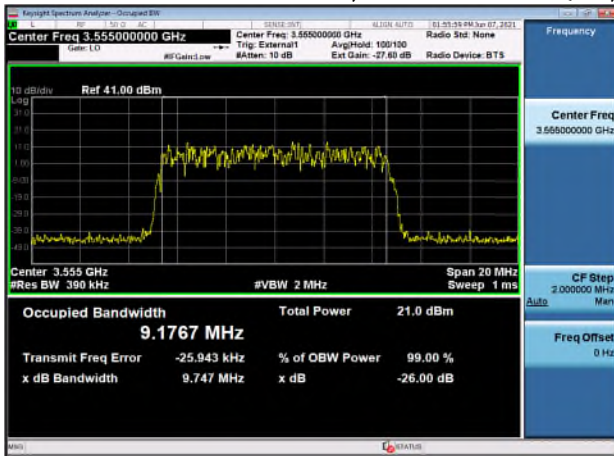

Dual Carrier Contiguous – 8-Beam 32T32R 20+20 MHz
Test Model 1.1, Modulation QPSK, Channel Frequency 3625+3645 MHz, TX8

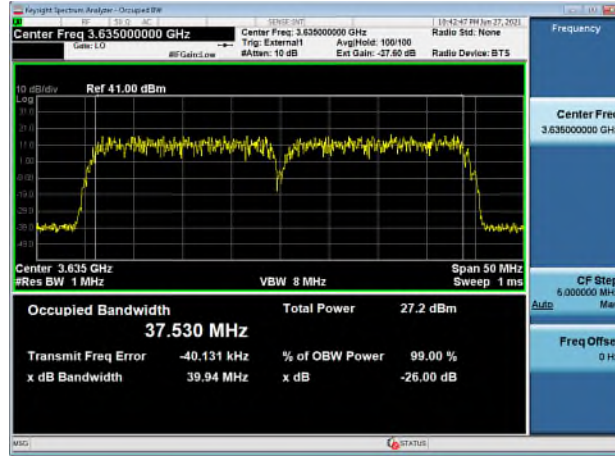

Dual Carrier Non-Contiguous – 8-Beam 32T32R 20+20 MHz
Test Model 3.1a, Modulation 256QAM, Channel Frequency 3560+3690 MHz, TX9

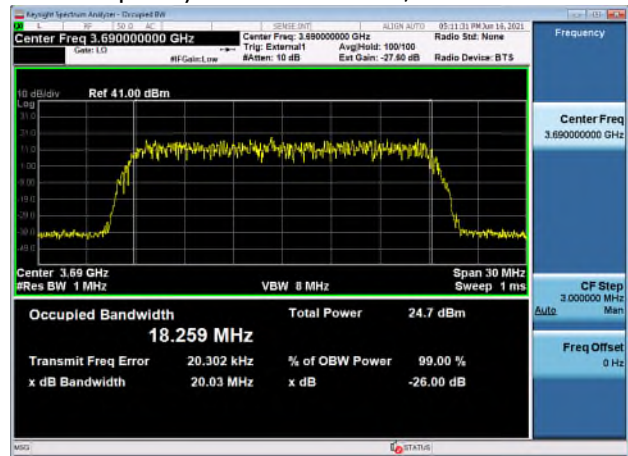
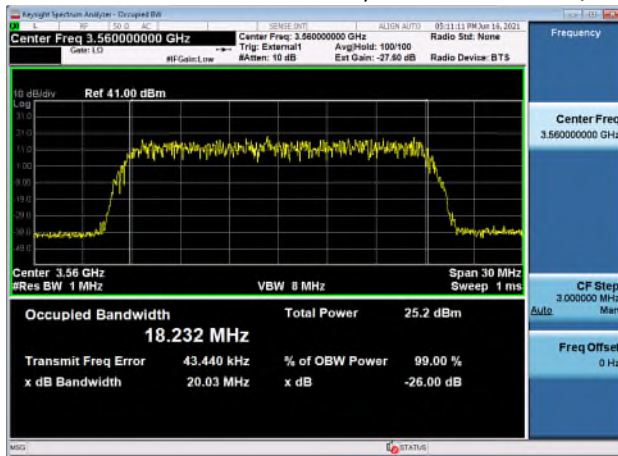

4.2 Edge of band Emissions

47CFR 96.41 (e)(1) (i) and KDB 940660 D01 Section 3.2 (b)(6) specified that the limits for the emissions outside the fundamental are as follows.

- within 0 MHz to 10 MHz above and below the assigned channel ≤ -13 dBm/MHz,
- greater than 10 MHz above and below the assigned channel ≤ -25 dBm/MHz,
- any emission below 3530 MHz and above 3720 MHz ≤ -40 dBm/MHz.

47CFR 96.41 (e)(3) and KDB 940660 D01 Section 3.2 (b)(6) specified stated that (i) Compliance with this provision is based on the use of measurement instrumentation employing a resolution bandwidth of 1 megahertz or greater. However, in the 1 megahertz bands immediately outside and adjacent to the licensee's authorized frequency channel, a resolution bandwidth of no less than one percent of the fundamental emission bandwidth may be employed. A narrower resolution bandwidth is permitted in all cases to improve measurement accuracy provided the measured power is integrated over the full reference bandwidth (*i.e.*, 1 MHz or 1 percent of emission bandwidth, as specified). The fundamental emission bandwidth is defined as the width of the signal between two points, one below the carrier center frequency and one above the carrier center frequency, outside of which all emissions are attenuated at least 26 dB below the transmitter power. (ii) When measuring unwanted emissions to demonstrate compliance with the limits, the CBSD and End User Device nominal carrier frequency/channel shall be adjusted as close to the licensee's authorized frequency block edges, both upper and lower, as the design permits. (iii) Compliance with emission limits shall be demonstrated using either average (RMS)-detected or peak-detected power measurement techniques.

KDB 940660 D01 Section 3.2 (b)(6) specified that measurements must be performed for low, mid, and high channels. It is acceptable to apply the procedures in Section 5.7 of ANSI C63.26-2015. When antenna-port conducted measurements are performed to demonstrate compliance to the applicable unwanted emission limits (Section 2.1051), a separate radiated measurement is required to detect spurious emissions that may be radiated directly from the cabinet, control circuits, power leads, or intermediate circuit elements under normal conditions of installation and operation (Section 2.1053). The Section 96.41(e) limits generally also apply to radiated unwanted emissions.

The Edge of Band emissions of the EUT at the external antenna connector (EAC) were measured using a Keysight MXA Signal Analyzer. The RF power level was continuously measured using a RF broadband power meter. The RF output from the EAC port to signal analyzer was reduced (to an amplitude usable by the signal analyzer) by using a calibrated attenuator and test coupler. The path attenuation was offset on the display and the signal for the carrier was adjusted to the corrected RF power level for the resolution bandwidth used for the transmit signal. All mask values were adjusted based upon the designated signal bandwidth and measurement bandwidths. The Top of Mask corresponds to the set rated power level as confirmed by the RF power meter.

4.2.1 Edge of Band Emissions - Plots.

All of the measurements met the requirements of Part 96.41(e)(1) and KDB 940660 D01 Section 3.2 (b)(6) when measured per Part 2.1049.

Single Carrier - 8-Beam 32T32R 10 MHz

Test Model 3.2, Modulation QPSK/16QAM, Channel Frequency 3555 MHz, TX15

Test Model 3.1, Modulation 64QAM, Channel Frequency 3625 MHz, TX3

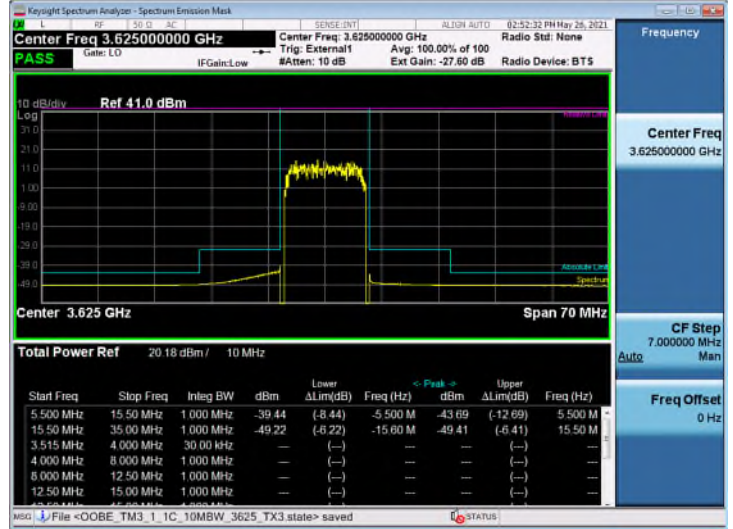
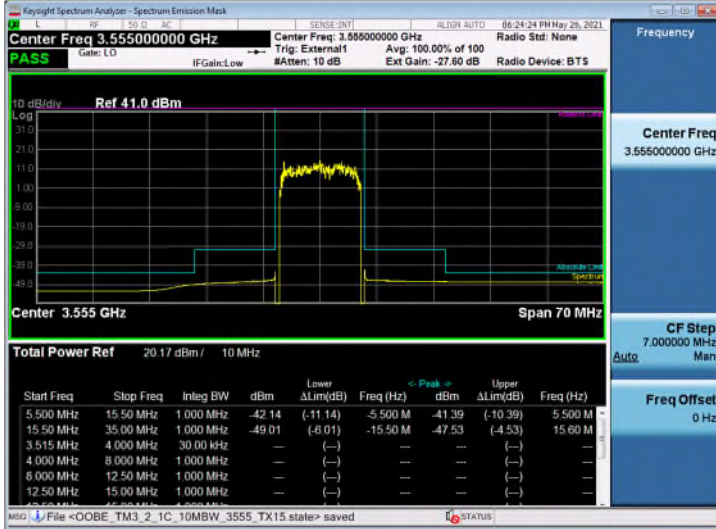

Test Model 3.1a, Modulation 256QAM, Channel Frequency 3695 MHz, TX12

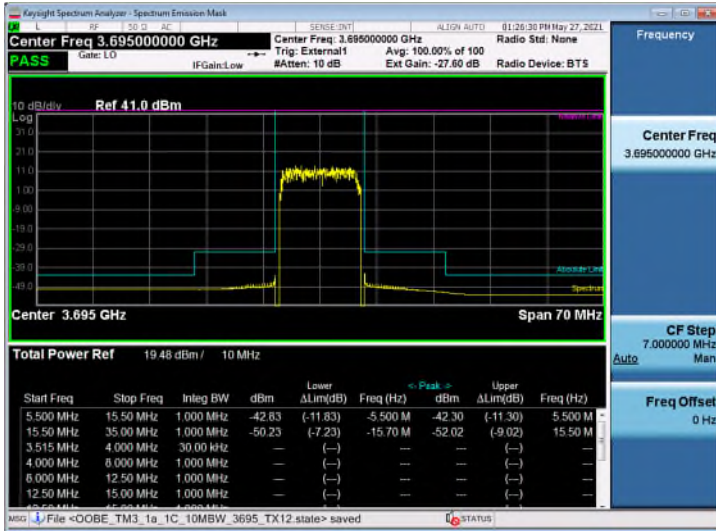

Single Carrier - 8-Beam 32T32R 20 MHz

Test Model 3.1, Modulation 64QAM, Channel Frequency 3560 MHz, TX3

Test Model 3.1a, Modulation 256QAM, Channel Frequency 3625 MHz, TX3

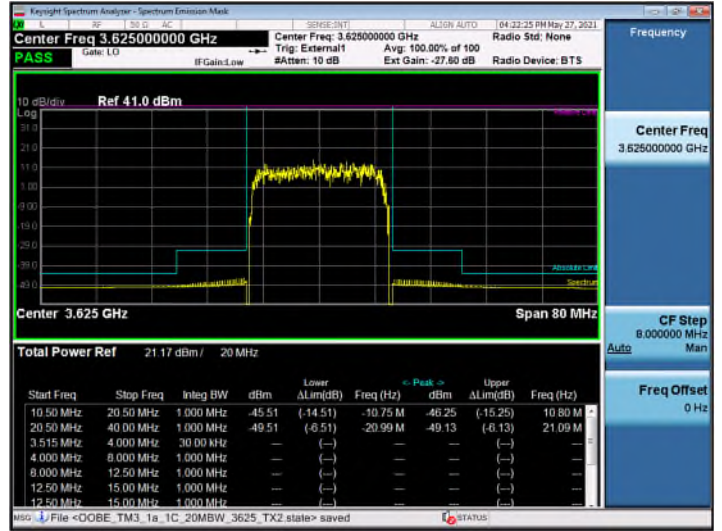
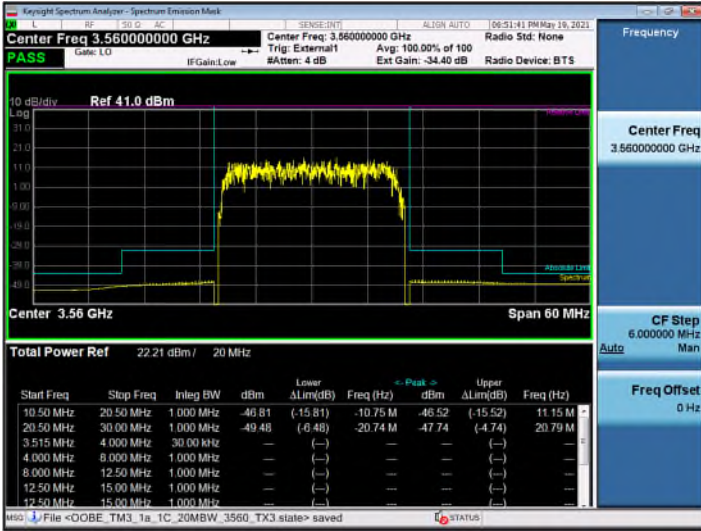

Test Model 3.1a, Modulation 256QAM, Channel Frequency 3690 MHz, TX2

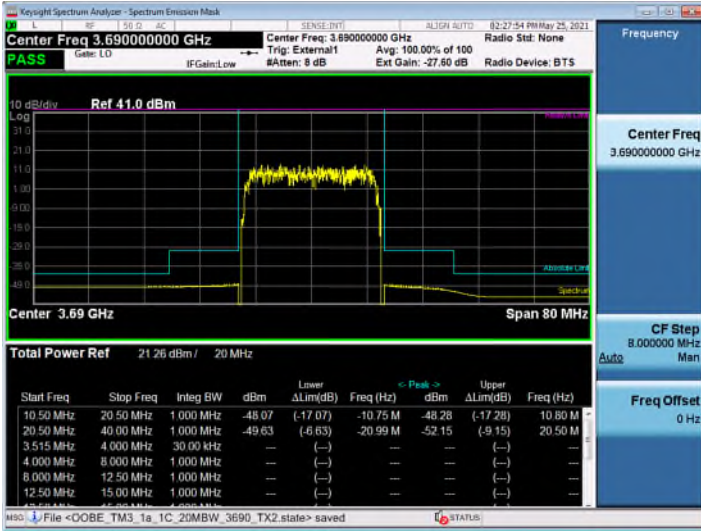

Dual Carrier Contiguous – 8-Beam 32T32R 10+20 MHz

Test Model 3.2, Modulation QPSK/16QAM, Channel Frequency 3555+3570 MHz, TX4

Test Model 3.2, Modulation QPSK/16QAM, Channel Frequency 3625+3640 MHz, TX3

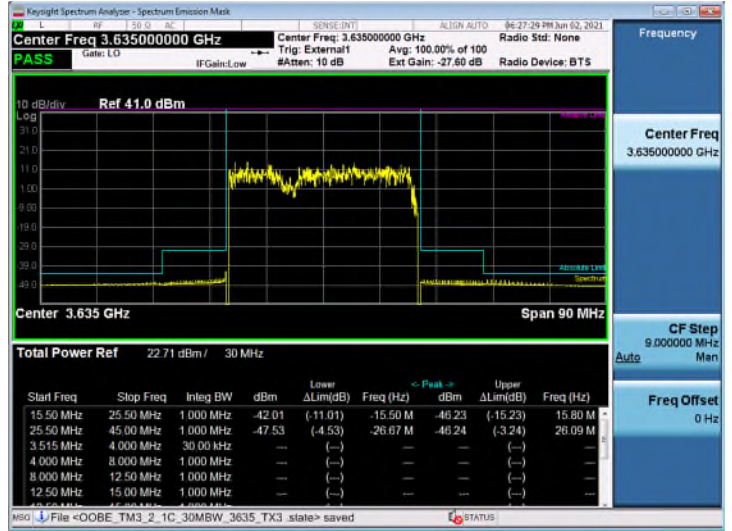
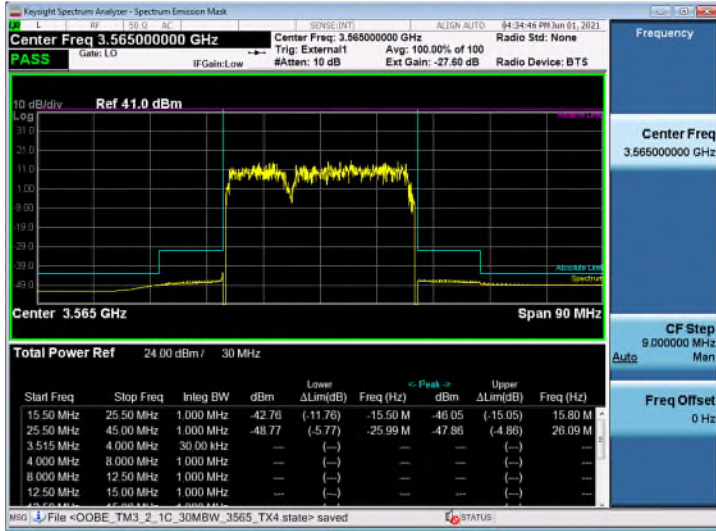

Test Model 3.1a, Modulation 256QAM, Channel Frequency 3675+3690 MHz, TX14

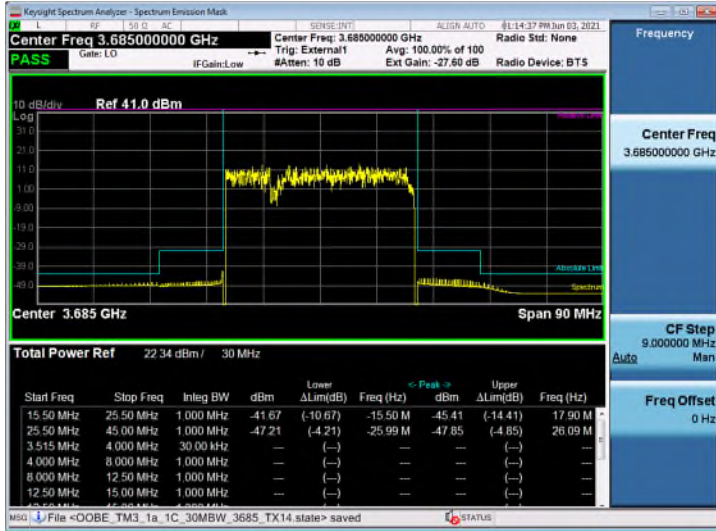

**Dual Carrier Non-Contiguous
 8-Beam 32T32R 10+20 MHz**

Test Model 3.1a, Modulation 256QAM, Channel Frequency 3555+3690 MHz, Center Frequency 3555 MHz, TX12

Test Model 3.1a, Modulation 256QAM, Channel Frequency 3555+3690 MHz, Center Frequency 3690 MHz, TX12

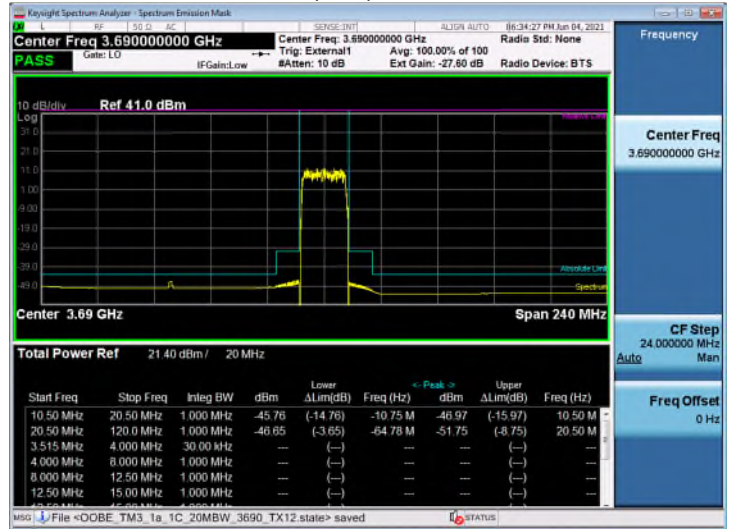
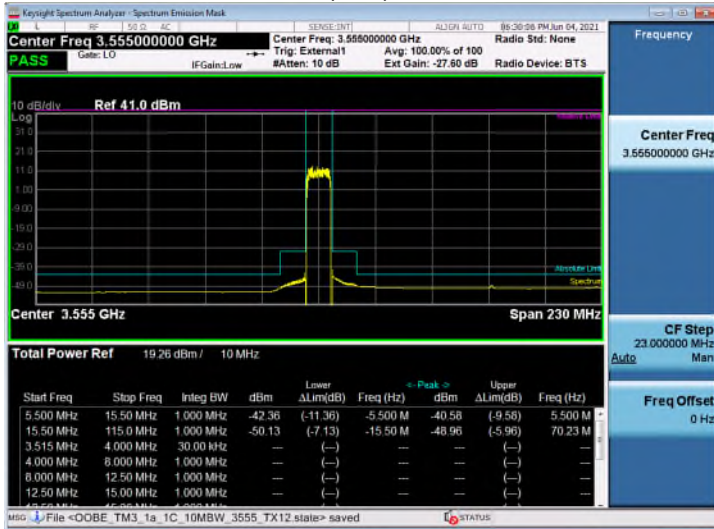

Test Model 3.1a, Modulation 256QAM, Channel Frequency 3555+3690 MHz, Center Frequency 3625MHz, TX12

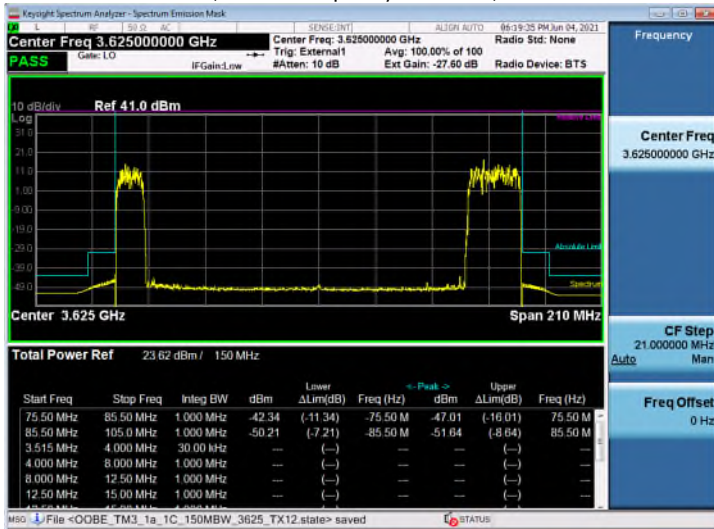

Dual Carrier Contiguous – 8-Beam 32T32R 20+20 MHz

Test Model 3.1, Modulation 64QAM, Channel Frequency 3560+3580 MHz, TX6

Test Model 3.2, Modulation QPSK/16QAM, Channel Frequency 3625+3645MHz, TX8

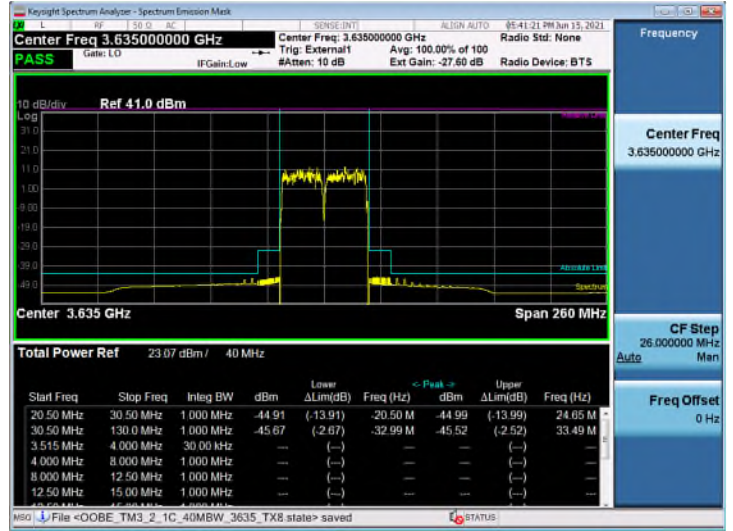
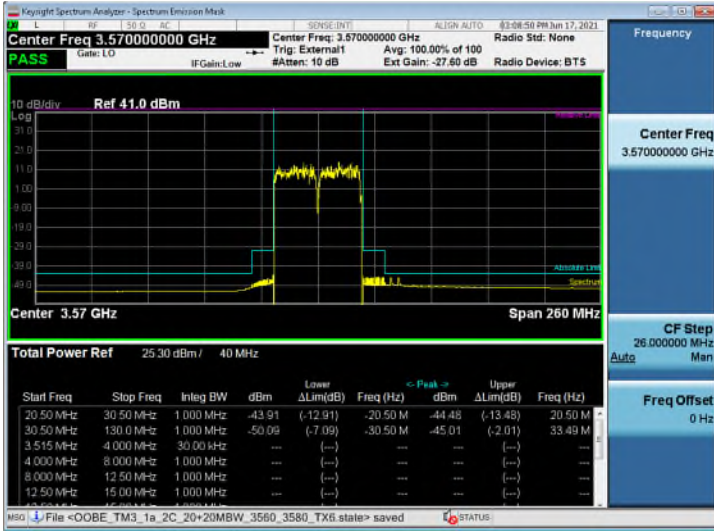

Test Model 3.1a, Modulation 256QAM, Channel Frequency 3670+3690 MHz, TX10



**Dual Carrier Non-Contiguous
 8-Beam 32T32R 20+20 MHz**

Test Model 3.1a, Modulation 256QAM, Channel Frequency 3560+3690 MHz, Center Frequency 3560 MHz, TX9

Test Model 3.1a, Modulation 256QAM, Channel Frequency 3560+3690 MHz, Center Frequency 3690 MHz, TX9

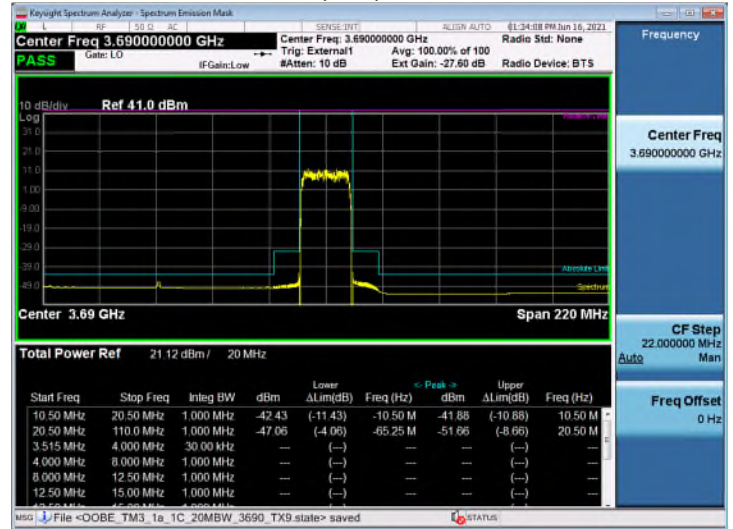
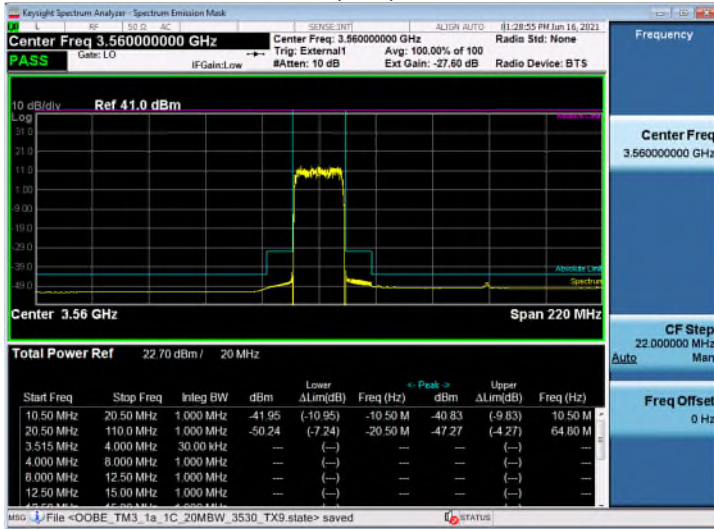

Test Model 3.1a, Modulation 256QAM, Channel Frequency 3560+3690 MHz, Center Frequency 3625MHz, TX9

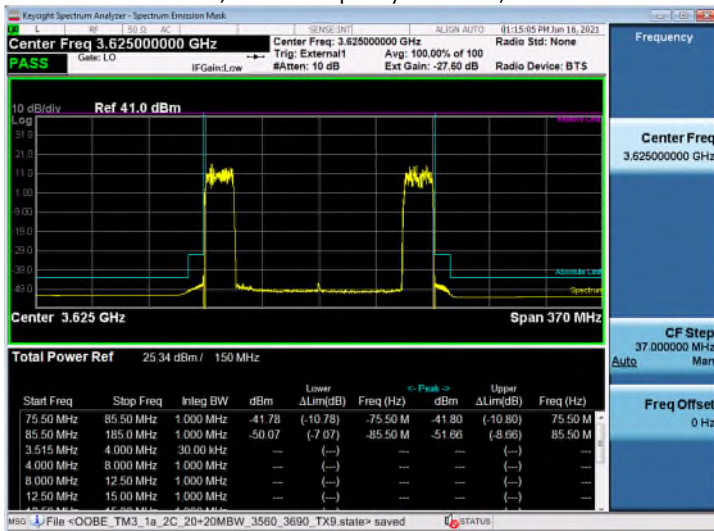

5. FCC Section 2.1051 - Spurious Emissions at Transmit Antenna Port

This test measures the emissions of spurious signals which may come from harmonic, parasitic, intermodulation and frequency conversion products and are outside the necessary bandwidth but excludes Edge-of-Band emissions.

5.1 Section 2.1051 Spurious Emissions at Antenna Terminals

Spurious Emissions at the antenna terminals were investigated per 47CFR Section 2.1057(a)(1) over the frequency range of 9 KHz to 38 GHz which is beyond the 10th harmonic of the carrier frequency. A test coupler and/or attenuator which incorporates a low intermod broadband RF attenuator was used to reduce the transceiver's amplitude to a level usable by the spectrum analyzer.

The spurious measurements were made using a PC based automated test system which controls either a MXA Signal Analyzer or a Rohde & Schwarz ESU-40 Test Receiver/ Spectrum Analyzer. These measurements are performed in compliance with ANSI C63.26 and our ISO17025 process. The measurement meets the ANSI C63.26 requirements in paragraphs 5.2.4.4.1 and 5.7 which requires that the number of points in the sweep be $> 2 \times \text{Span}/\text{RBW}$.

The required emission limitation specified in **47CFR 96.41 (e)** was applied to these tests. Based upon the criterion given in Section 96 of the Code, the required emission limit for emissions outside a licensee's frequency block is:

47CFR 96.41 (e)(2) Additional protection levels. Notwithstanding paragraph (d)(1) of this section, the conducted power of any emissions below 3530 MHz or above 3720 MHz shall not exceed $-40\text{dBm}/\text{MHz}$. In order to account for the spectral adding of identical signals from the primary and diversity ports, per KDB 662911 D01 Multiple Transmitter Output v01r01, the level needs be adjusted by $10\text{LOG}(n)$ where n = number of outputs.

The adjustment for $n=64 \rightarrow 10\text{LOG}(64) = 18.06 \text{ dB}$

Therefore, the limit for emissions $>1 \text{ MHz}$ outside a licensee's frequency block when measured with a RBW of 1 MHz is:

$-40 \text{ dBm} - 18.06 \text{ dB} = -58.06 \text{ dBm}$ for 64x MIMO

5.2 Spurious Emissions at Antenna Terminals Results

NOTE: Only plots with lowest margin in each frequency range are used in this report. The full suite of raw data resides at the MH, New Jersey location.

Tabular Data – Spurious Emissions at Antenna Terminals

# of Carriers	Test Model	Modulation	TX Port	Channel Frequency MHz	Signal BW MHz	Conducted Spurious Emissions Results Pass/ Fail
1	3.2	QPSK/16QAM	15	3555	10	Pass
1	3.1	64QAM	3	3625	10	Pass
1	3.1a	256QAM	12	3695	10	Pass
1	3.1	64QAM	3	3560	20	Pass
1	3.1a	256QAM	3	3625	20	Pass
1	3.1a	256QAM	2	3690	20	Pass
2 (Contiguous)	3.2	QPSK/16QAM	4	3555+3570	10+20	Pass
2 (Contiguous)	3.2	QPSK/16QAM	3	3625+3640	10+20	Pass
2 (Contiguous)	3.1a	256QAM	14	3675+3690	10+20	Pass
2 (Non-Contiguous)	3.1a	256QAM	12	3555+3690	10+20	Pass
2 (Contiguous)	3.1	256QAM	6	3560+3580	20+20	Pass
2 (Contiguous)	3.2	QPSK/16QAM	8	3625+3645	20+20	Pass
2 (Contiguous)	3.1a	256QAM	10	3670+3690	20+20	Pass
2 (Non-Contiguous)	3.1a	256QAM	9	3560+3690	20+20	Pass

9KHz – 150kHz

of Carriers Test Model Modulation TX Port Channel Frequency (MHz) Signal BW (MHz)
 2 (Contiguous) 3.1a 256QAM 14 3675+3690 10+20

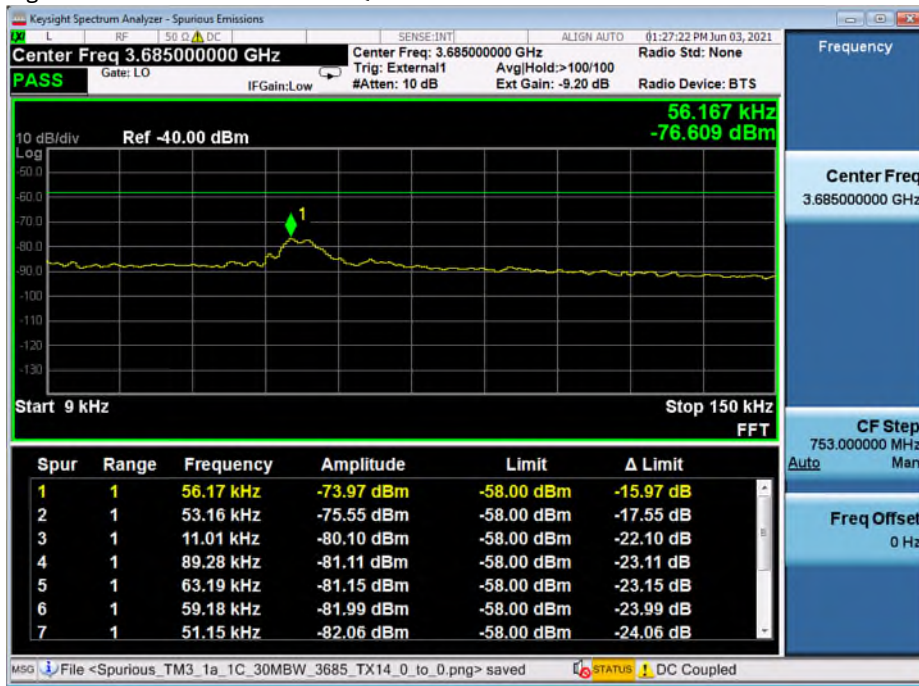

150kHz – 30MHz

of Carriers Test Model Modulation TX Port Channel Frequency (MHz) Signal BW (MHz)
 1 1.1 QPSK 3 3625 20

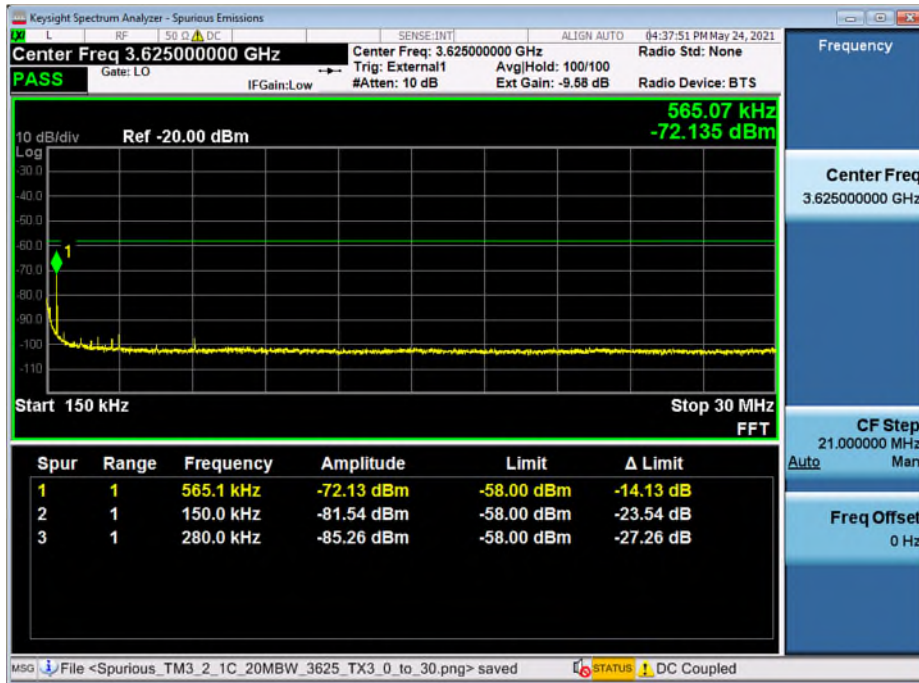

30MHz – 1GHz

of Carriers: 1 Test Model: 1.1 Modulation: QPSK TX Port: 3 Channel Frequency (MHz): 3625 Signal BW (MHz): 10

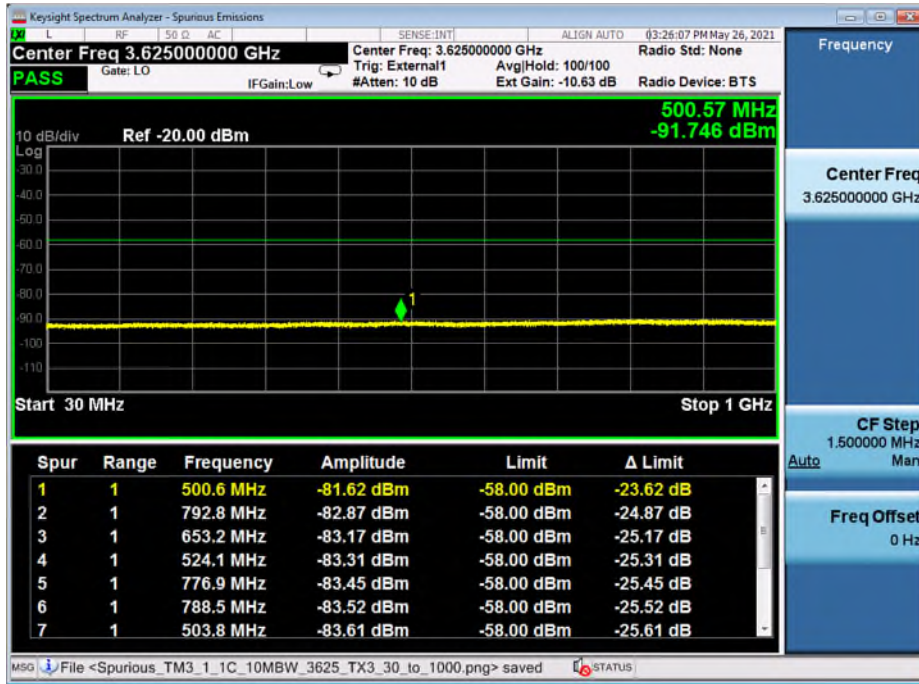

1GHz – 3.43GHz

of Carriers: 2 (Contiguous) Test Model: 1.1 Modulation: QPSK TX Port: 3 Channel Frequency (MHz): 3555+3570 Signal BW (MHz): 10+20

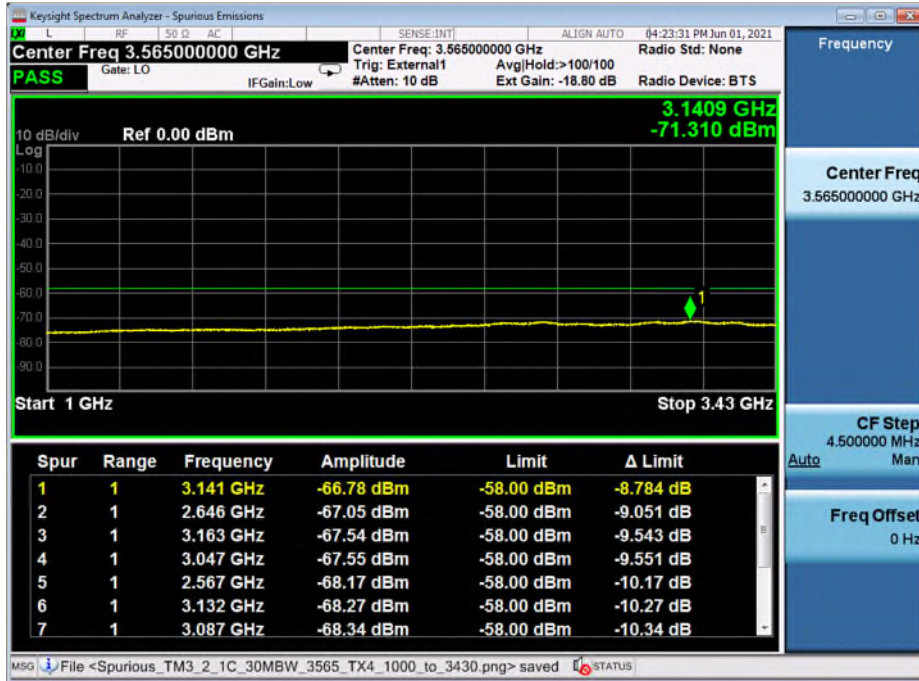

3.43GHz – 3.53GHz

of Carriers Test Model Modulation TX Port Channel Frequency (MHz) Signal BW (MHz)
 1 3.1 64QAM 3 3560 20

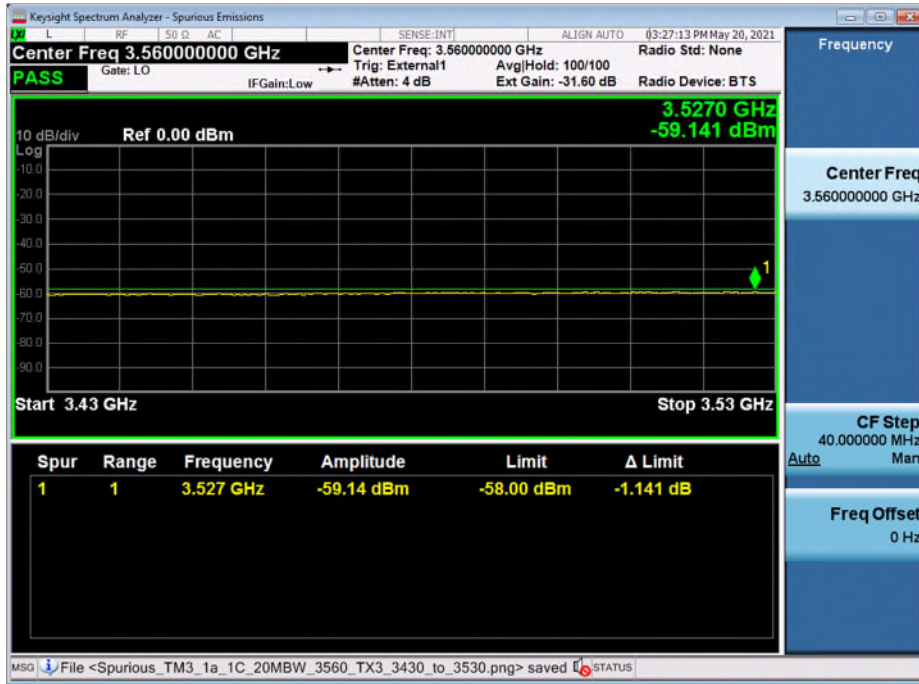

3.53GHz – 3.595GHz

of Carriers Test Model Modulation TX Port Channel Frequency (MHz) Signal BW (MHz)
 2 (Contiguous) 1.1 QPSK 3 3555+3570 10+20

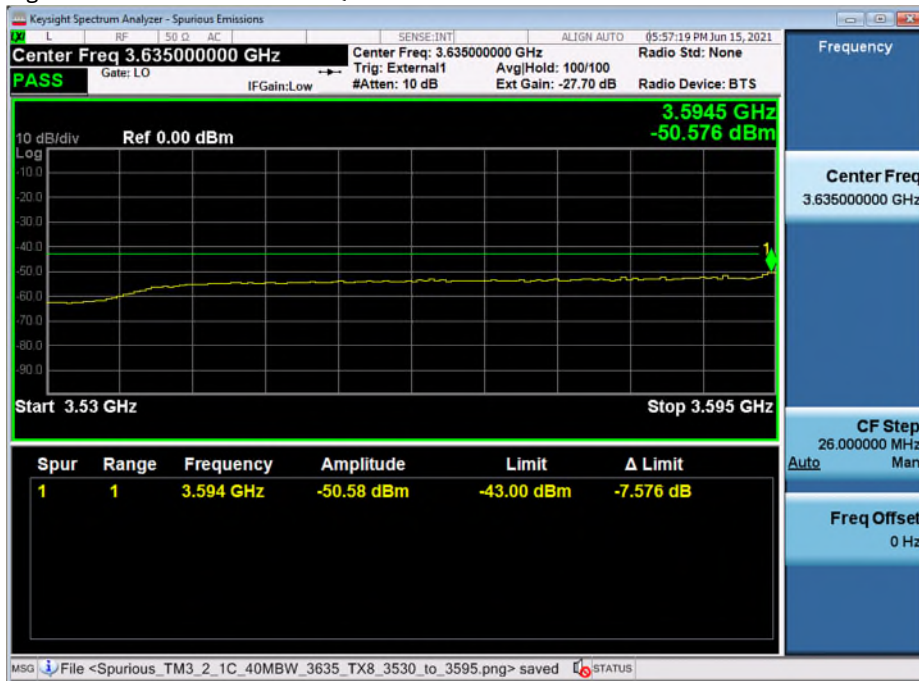

3.61GHz – 3.72GHz

of Carriers Test Model Modulation TX Port Channel Frequency (MHz) Signal BW (MHz)
 2 (Contiguous) 1.1 QPSK 6 3560+3580 20+20

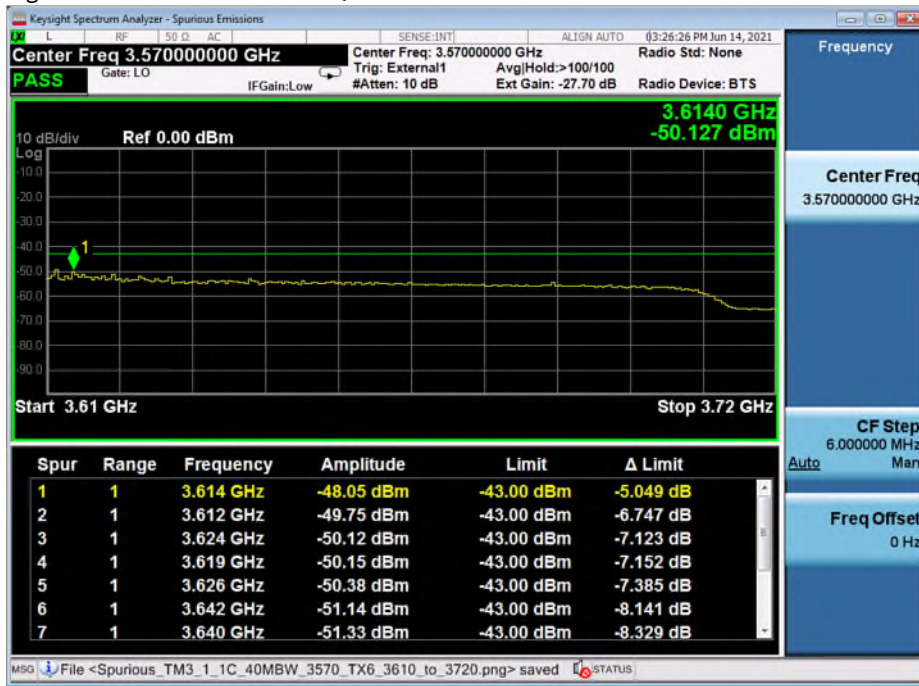

3.72GHz – 3.82GHz

of Carriers Test Model Modulation TX Port Channel Frequency (MHz) Signal BW (MHz)
 1 3.1 64QAM 3 3560 20



3.82GHz – 6GHz

of Carriers Test Model Modulation TX Port Channel Frequency (MHz) Signal BW (MHz)
 2 (Contiguous) 1.1 QPSK 3 3555+3570 10+20

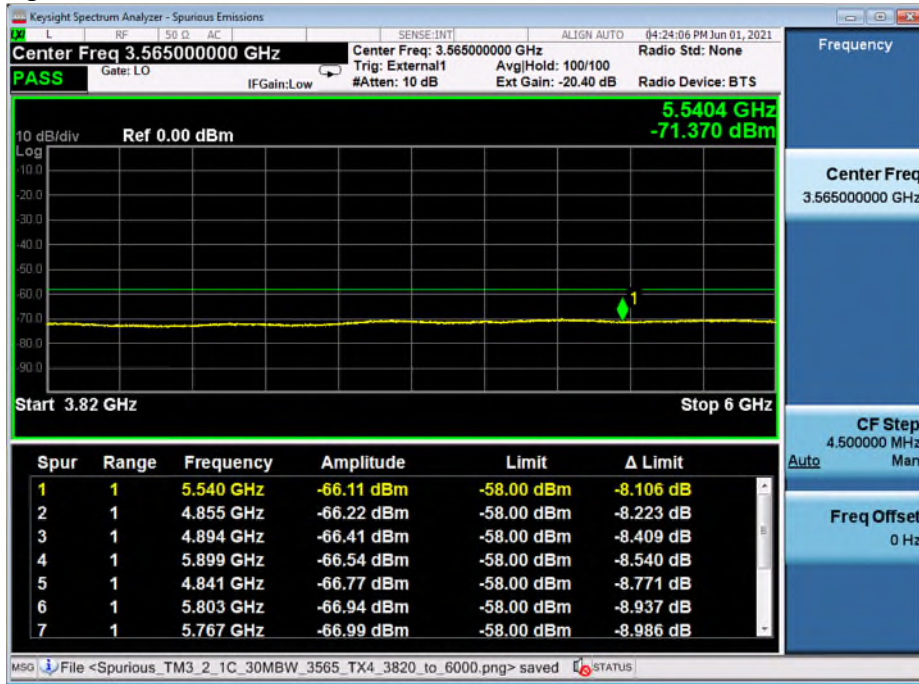

6GHz – 9GHz

of Carriers Test Model Modulation TX Port Channel Frequency (MHz) Signal BW (MHz)
 1 1.1 QPSK 3 3625 10

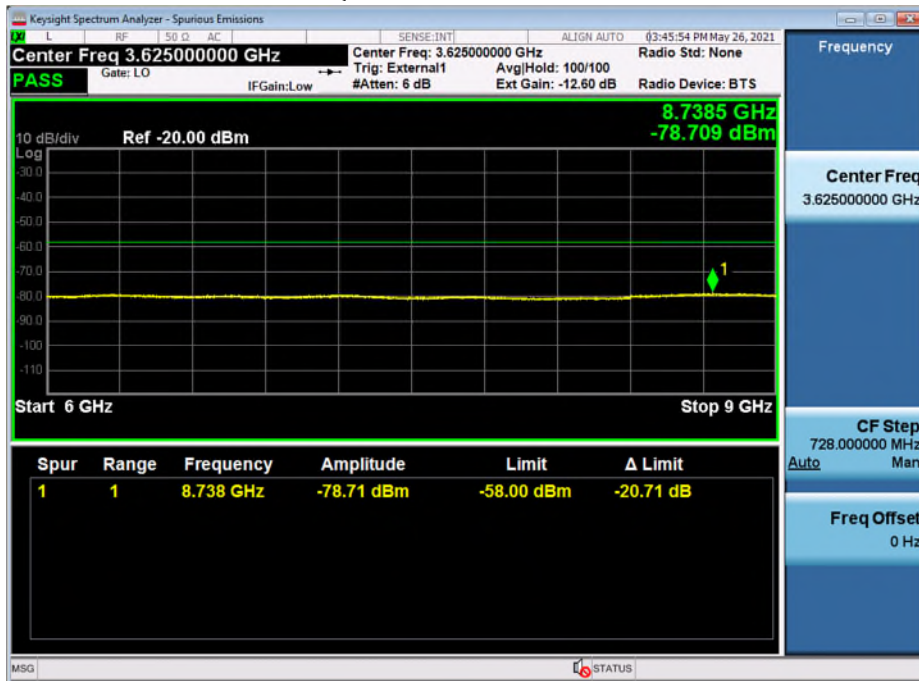

9GHz – 38.2GHz

# of Carriers	Test Model	Modulation	TX Port	Channel Frequency (MHz)	Signal BW (MHz)
2 (Contiguous)	3.1a	256QAM	14	3675+3690	10+20



6. Section 2.1053 - Measurement Required: Field Strength of Spurious Radiation

The field strength measurements of radiated spurious emissions were made in a FCC registered 3-meter semi-anechoic chamber AR-6, (FCC Registration Number: 395774) NVLAP Lab Code: 100275-0 and IC (Filing Number: 6933F-5) which is maintained by Nokia Bell Labs in Murray Hill, New Jersey.

6.1 Spurious Radiation and Radiated Emissions Requirements.

This product meets Parts 2,15 and 96 requirements. FCC Part 15 Class B require emissions to be below 54.5 dBuV/m at 3m.

47CFR 96.41 (e)(1) (i) and KDB 940660 D01 Section 3.2 (b)(6) specified that the limits for the emissions outside the fundamental are as follows.

- within 0 MHz to 10 MHz above and below the assigned channel ≤ -13 dBm/MHz,
- greater than 10 MHz above and below the assigned channel ≤ -25 dBm/MHz,
- any emission below 3530 MHz and above 3720 MHz ≤ -40 dBm/MHz.

Title 47CFR section 2.1053 contains the requirements for the levels of spurious radiation as a function of the EIRP of the unmodulated carrier. The reference level for the unmodulated carrier is calculated as the field produced by an isotropic radiator excited by the transmitter output power according to the following relation taken from Reference Data for Radio Engineers, page 27-7, 6th edition, IT&T Corp.

$$E = [(30 * EIRP)^{1/2}] / R$$

Where: E = Field Intensity in Volts/ meter R = Distance in meters = 3 m
P = Emission Power in Watts

Hence,

$$E \text{ (dB}\mu\text{V/m)} = \text{EIRP (dBm)} - 20 \log d \text{ (m)} + 104.77.$$

For EIRP = -13dBm/MHz, E = 82.2 dB μ V/m,

For EIRP = -25dBm/MHz, E = 70.2 dB μ V/m,

For EIRP = -40dBm/MHz, E = 55.2 dB μ V/m.

The field strength of radiated spurious emissions measured was determined by

$$E \text{ (dB}\mu\text{V/m)} = V_{\text{meas}} \text{ (dB}\mu\text{V)} + \text{Cable Loss (dB)} + \text{Antenna Factor (dBi/m)}.$$

Field strength measurements of radiated spurious emissions were made in the 3m semi-anechoic chamber, AR-6 as detailed above. The recommendations of ANSI C63.4 and ANSI C63.26 were followed for EUT testing setup, cabling, and measurement approach and procedures. All the measurement equipment used, including antennas, was calibrated in accordance with ISO 9001 process. The EUT setup diagram is given in the Figure 4.5.

Below 18GHz, FCC Part 15 Class B limit 54.5 dBuV/m was used which is worse than FCC Part 96 limit. Above 18GHz, the limit 55.2 dBuV/m was used.

6.2 Field Strength of Spurious Radiation Results:

This product meets Part 96 Requirements. For the Title 47CFR section 96.41(e) and 2.1053 test, the field strength of any spurious radiation, measured at 3m, is required to be less than 55.2dB μ V/meter. Emissions equal to or less than 35.2 dB μ V/meter are not reportable and may be verified using field strength measurements with broadband antennas.

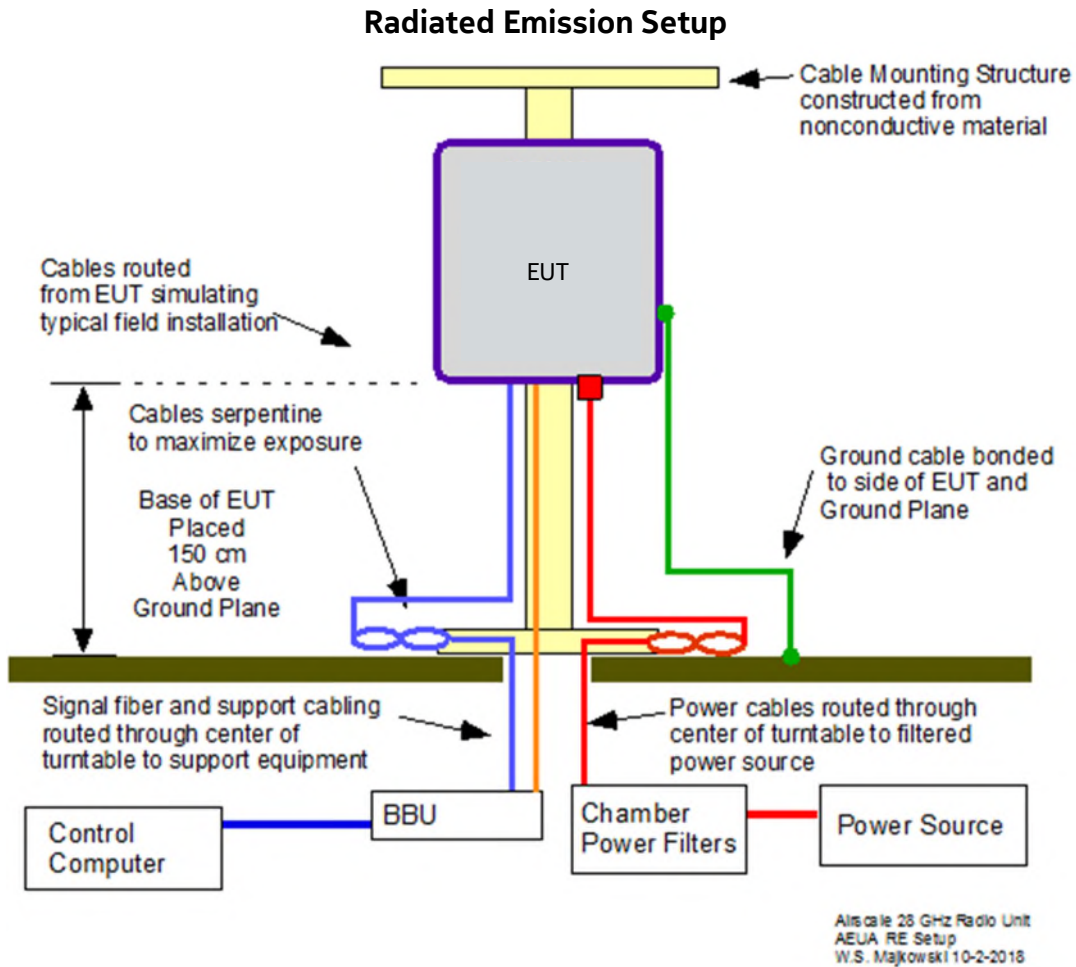

6.3 Transmitter Measurements of Radiated Spurious Emissions Plots RE 30MHz – 1GHz

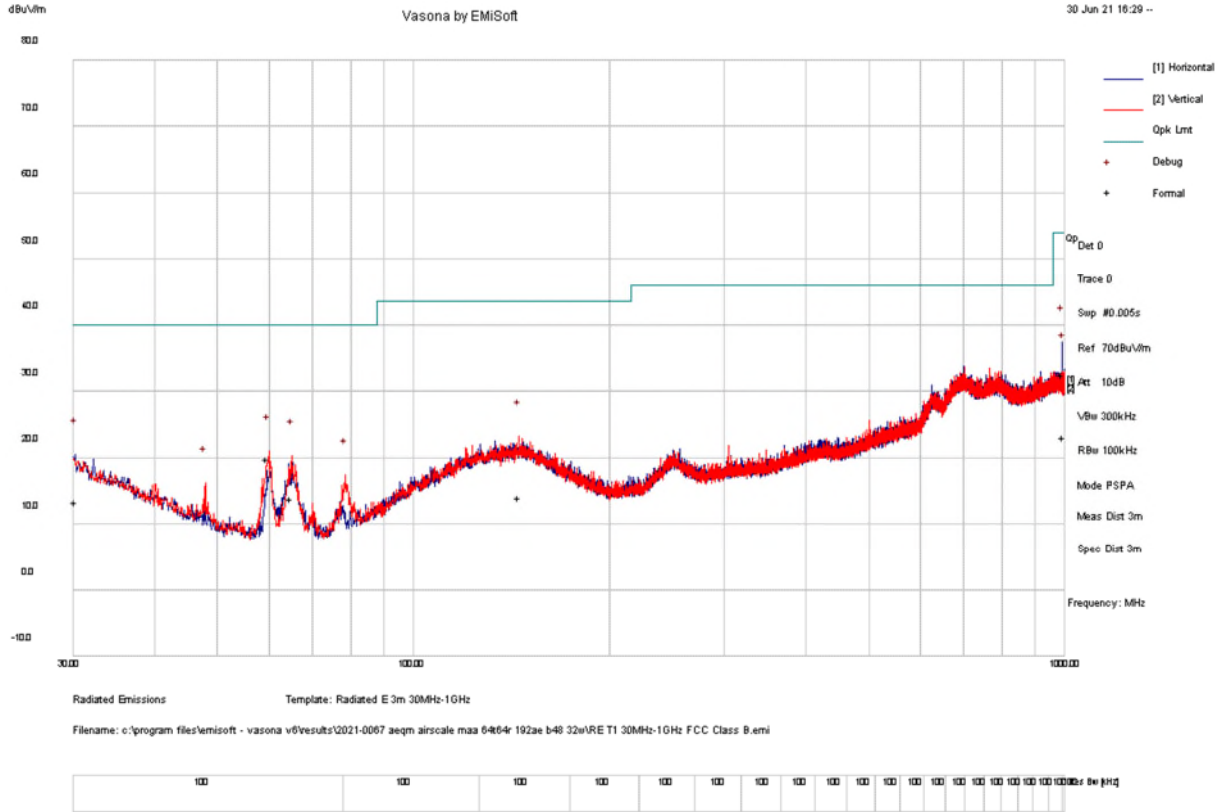

Test Information

Results Title	Radiated E 3m 30MHz-1GHz
File Name	RE T1 30MHz-1GHz FCC Class B.emi
Test Laboratory	MH-AR6, 24.7C, 52%RH, 996mB.
Test Engineer	GM
Test Software	Vasona by EMISoft, version 6.061
Equipment	Nokia
EUT Details	2021-0067 AEQM AirScale MAA 64T64R 192AE B48 32W, F1 3560MHz, TM3.1, 20MHz BW; F2 3580MHz, TM3.1, 20MHz BW Upper only. -48Vdc,
Configuration	FCC Pt.15 Class B. RE 30MHz- 1GHz, ESI E936, PA E507, Ant E766, RBW: Previews 100kHz / Formals 100KHz, VBW: 300KHz, Int. Att 10dB
Date	2021-07-01 09:42:25

Formal Data

Freq. (MHz)	Raw (dBuV)	Cable (dB)	Factor (dB)	Level (dBuV/m)	Emission Type	Pol (H/V)	Ht (cm)	Az (deg)	Limit (dBuV/m)	Margin (dB)	Pass/Fail	Comments
59.740	40.58	0.44	-21.06	19.96	QuasiMax	V	143	244	40.00	-20.04	Pass	
99.736	32.03	2.84	-2.32	32.54	QuasiMax	H	156	97	54.00	-21.46	Pass	
64.775	34.70	0.48	-21.25	13.92	QuasiMax	V	162	247	40.00	-26.08	Pass	
30.289	23.22	0.41	-10.09	13.54	QuasiMax	H	346	324	40.00	-26.46	Pass	
145.142	23.19	0.77	-9.78	14.19	QuasiMax	V	227	229	43.50	-29.31	Pass	

Freq. (MHz)	Raw (dBuV)	Cable (dB)	Factor (dB)	Level (dBuV/m)	Emission Type	Pol (H/V)	Ht (cm)	Az (deg)	Limit (dBuV/m)	Margin (dB)	Pass/Fail	Comments
997.675	22.67	2.85	-2.25	23.26	QuasiMax	H	162	62	54.00	-30.74	Pass	

Preview Data

Freq. (MHz)	Raw (dBuV)	Cable (dB)	Factor (dB)	Level (dBuV/m)	Emission Type	Pol (H/V)	Ht (cm)	Az (deg)	Limit (dBuV/m)	Margin (dB)	Pass/Fail	Comments
990.741483	36.86	2.84	-2.32	37.37	Debug	H	184	90	54.00	-16.63	Pass	
59.915832	41.72	0.44	-21.09	21.07	Debug	V	200	270	40.00	-18.93	Pass	
30.288577	30.20	0.41	-10.09	20.52	Debug	H	384	45	40.00	-19.48	Pass	
65.11022	41.11	0.48	-21.26	20.33	Debug	V	200	90	40.00	-19.67	Pass	
145.142285	32.21	0.77	-9.78	23.21	Debug	V	200	135	43.50	-20.29	Pass	
997.675351	32.68	2.85	-2.25	33.27	Debug	H	284	270	54.00	-20.73	Pass	
78.577154	36.86	0.51	-20.01	17.36	Debug	V	100	45	40.00	-22.64	Pass	
47.891784	34.48	0.36	-18.57	16.28	Debug	V	200	225	40.00	-23.72	Pass	

Note: Preview data was measured using a peak detector to identify frequencies of interest for formal measurement. Formal data consist of all frequencies in the preview list within 6 dB of specification limit or the top six frequencies. Failure in preview data does not necessarily constitute failure in formal data.

RE 1GHz – 10GHz

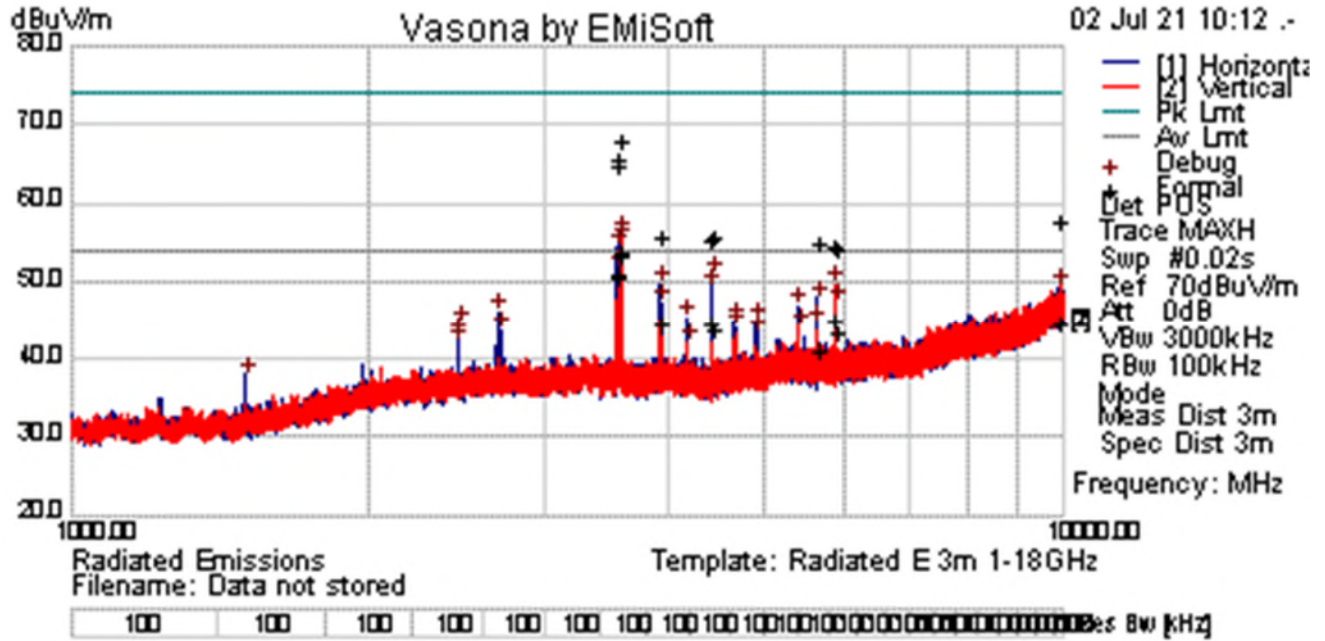

Test Information

Results Title	Radiated E 3m 1-18GHz
File Name	re02_1g_10g_formal.emi
Test Laboratory	MH-AR6, 24.6C, 53%RH, 993mB.
Test Engineer	GM
Test Software	Vasona by EMISoft, version 6.061
Equipment	Nokia
EUT Details	2021-0067 AEQM AirScale MAA 64T64R 192AE B48 32W, F1 3560MHz, TM3.1, 20MHz BW; F2 3580MHz, TM3.1, 20MHz BW Upper only. -48Vdc,
Configuration	Radiated Emissions 1GHz - 10GHz, GR-1089 / FCC Pt.15 Class B limit, Rcvr ESU EIH69, PA E376, Ant E1074, RBW: Previews 100KHz / Formals 1MHz, VBW: 3MHz,
Date	2021-07-02 10:13:35

Formal Data

Freq. (MHz)	Raw (dBuV)	Cable (dB)	Factor (dB)	Level (dBuV/m)	Emission Type	Pol (H/V)	Ht (cm)	Az (deg)	Limit (dBuV/m)	Margin (dB)	Pass/Fail	Comments
3588.506	48.78	5.00	0.18	53.96	AvgMax	V	275	6	54.00	-0.04	Pass	Carrier
3571.861	48.27	4.99	0.16	53.42	AvgMax	H	307	257	54.00	-0.58	Pass	Carrier
3567.650	46.15	4.98	0.15	51.28	AvgMax	H	305	261	54.00	-2.72	Pass	Carrier
3555.217	45.52	4.97	0.13	50.63	AvgMax	H	297	312	54.00	-3.37	Pass	Carrier
3588.506	63.06	5.00	0.18	68.23	PeakMax	V	275	6	74.00	-5.77	Pass	Carrier
3571.861	62.96	4.99	0.16	68.10	PeakMax	H	307	257	74.00	-5.90	Pass	Carrier
3567.650	60.60	4.98	0.15	65.74	PeakMax	H	305	261	74.00	-8.26	Pass	Carrier
5890.549	36.40	6.29	2.48	45.17	AvgMax	V	152	63	54.00	-8.83	Pass	
4415.985	38.25	5.57	1.11	44.93	AvgMax	H	176	74	54.00	-9.07	Pass	
3555.217	59.82	4.97	0.13	64.93	PeakMax	H	297	312	74.00	-9.07	Pass	
9945.739	28.52	11.51	4.79	44.82	AvgMax	V	353	228	54.00	-9.18	Pass	
3924.468	38.89	5.25	0.63	44.77	AvgMax	H	246	43	54.00	-9.23	Pass	

Freq. (MHz)	Raw (dBuV)	Cable (dB)	Factor (dB)	Level (dBuV/m)	Emission Type	Pol (H/V)	Ht (cm)	Az (deg)	Limit (dBuV/m)	Margin (dB)	Pass/Fail	Comments
4431.354	37.22	5.58	1.12	43.93	AvgMax	H	191	90	54.00	-10.07	Pass	
5905.918	34.89	6.30	2.50	43.69	AvgMax	V	160	61	54.00	-10.31	Pass	
5660.152	32.91	6.20	2.14	41.25	AvgMax	H	106	23	54.00	-12.75	Pass	
9945.739	41.67	11.51	4.79	57.97	PeakMax	V	353	228	74.00	-16.03	Pass	
3924.468	49.99	5.25	0.63	55.87	PeakMax	H	246	43	74.00	-18.13	Pass	
4431.354	49.10	5.58	1.12	55.80	PeakMax	H	191	90	74.00	-18.20	Pass	
4415.985	48.66	5.57	1.11	55.35	PeakMax	H	176	74	74.00	-18.65	Pass	
5660.152	46.76	6.20	2.14	55.10	PeakMax	H	106	23	74.00	-18.90	Pass	
5890.549	46.10	6.29	2.48	54.88	PeakMax	V	152	63	74.00	-19.12	Pass	
5905.918	45.45	6.30	2.50	54.25	PeakMax	V	160	61	74.00	-19.75	Pass	

Preview Data

Freq. (MHz)	Raw (dBuV)	Cable (dB)	Factor (dB)	Level (dBuV/m)	Emission Type	Pol (H/V)	Ht (cm)	Az (deg)	Limit (dBuV/m)	Margin (dB)	Pass/Fail	Comments
3588.50578	50.67	5.00	0.18	55.85	Debug	V	284	0	54.00	1.85	Fail	
3571.861375	50.07	4.99	0.16	55.21	Debug	H	300	270	54.00	1.21	Fail	
3555.21697	49.26	4.97	0.13	54.37	Debug	H	300	315	54.00	0.37	Fail	
3567.65014	46.53	4.98	0.15	51.67	Debug	H	300	270	54.00	-2.33	Pass	
4431.354385	44.19	5.58	1.12	50.89	Debug	H	200	90	54.00	-3.11	Pass	
5890.447045	40.77	6.29	2.48	49.54	Debug	V	184	315	54.00	-4.46	Pass	
3924.401905	43.66	5.25	0.63	49.54	Debug	H	200	0	54.00	-4.46	Pass	
4415.91319	42.78	5.57	1.11	49.47	Debug	H	200	90	54.00	-4.53	Pass	
9945.73855	33.08	11.51	4.79	49.38	Debug	V	384	90	54.00	-4.62	Pass	
5660.232865	39.45	6.20	2.14	47.79	Debug	H	100	0	54.00	-6.21	Pass	
5905.88824	38.60	6.30	2.50	47.40	Debug	V	184	315	54.00	-6.60	Pass	
3939.8431	41.38	5.26	0.65	47.29	Debug	H	300	45	54.00	-6.71	Pass	
5399.136295	39.04	6.09	1.76	46.89	Debug	H	100	270	54.00	-7.11	Pass	
2695.523425	42.57	4.27	-0.79	46.06	Debug	H	300	45	54.00	-7.94	Pass	
4170.257815	38.87	5.42	0.89	45.17	Debug	H	100	270	54.00	-8.83	Pass	
4907.62501	37.73	5.87	1.20	44.80	Debug	H	200	0	54.00	-9.20	Pass	
4661.568565	37.88	5.73	1.19	44.80	Debug	H	300	45	54.00	-9.20	Pass	
2465.309245	41.64	4.08	-0.96	44.76	Debug	H	200	315	54.00	-9.24	Pass	
5644.79167	36.14	6.19	2.11	44.44	Debug	H	100	0	54.00	-9.56	Pass	
5414.376955	36.36	6.10	1.78	44.24	Debug	V	184	45	54.00	-9.76	Pass	
4677.00976	37.13	5.73	1.19	44.05	Debug	H	300	45	54.00	-9.95	Pass	
2710.96462	40.12	4.28	-0.78	43.62	Debug	H	100	45	54.00	-10.38	Pass	
4922.86567	36.36	5.88	1.21	43.44	Debug	H	200	45	54.00	-10.56	Pass	
2449.86805	39.96	4.07	-1.01	43.03	Debug	H	200	315	54.00	-10.97	Pass	
2457.688915	39.08	4.08	-0.98	42.17	Debug	H	100	315	54.00	-11.83	Pass	
4185.69901	35.67	5.43	0.90	41.99	Debug	V	100	45	54.00	-12.01	Pass	
1499.73322	41.71	3.02	-6.71	38.02	Debug	H	200	0	54.00	-15.98	Pass	

Note: Preview data was measured using a peak detector to identify frequencies of interest for formal measurement. Formal data consist of all frequencies in the preview list within 6 dB of specification limit or the top six frequencies. Failure in preview data does not necessarily constitute failure in formal data.

RE 10GHz – 18GHz

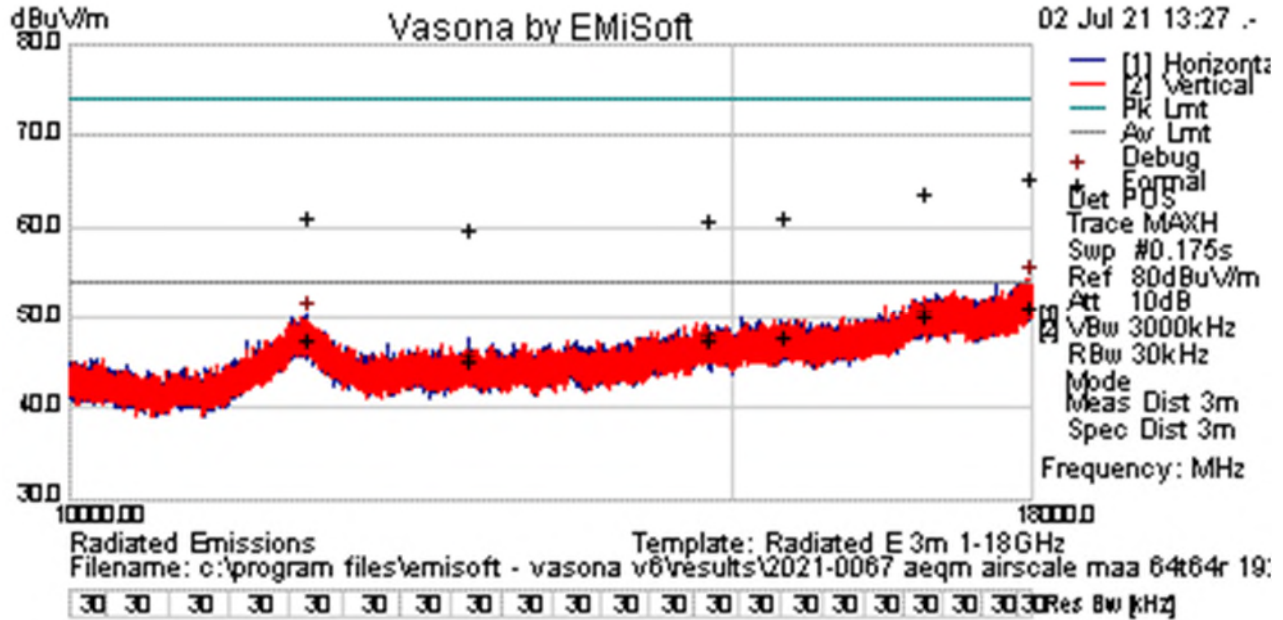

Test Information

Results Title	Radiated E 3m 1-18GHz
File Name	re03_10g_18g_formal.emi
Test Laboratory	MH-AR6, 24.6C, 53%RH, 993mB.
Test Engineer	NPA
Test Software	Vasona by EMISoft, version 6.061
Equipment	Nokia
EUT Details	2021-0067 AEQM AirScale MAA 64T64R 192AE B48 32W, F1 3560MHz, TM3.1, 20MHz BW; F2 3580MHz, TM3.1, 20MHz BW Upper only. -48Vdc,
Configuration	Radiated Emissions 10GHz - 18GHz, GR-1089 / FCC Pt.15 Class B limit, Rcvr ESU EIH69, PA E376, Ant E1074, RBW: Previews 30KHz / Formals 1MHz, VBW: 3MHz,
Date	2021-07-02 13:36:40

Formal Data

Freq. (MHz)	Raw (dBuV)	Cable (dB)	Factor (dB)	Level (dBuV/m)	Emission Type	Pol (H/V)	Ht (cm)	Az (deg)	Limit (dBuV/m)	Margin (dB)	Pass/Fail	Comments
17960.847	25.72	12.29	13.27	51.28	AvgMax	V	381	87	54.00	-2.72	Pass	
16858.139	26.57	11.36	12.44	50.38	AvgMax	V	185	350	54.00	-3.62	Pass	
15471.764	26.60	11.92	9.56	48.08	AvgMax	V	231	223	54.00	-5.92	Pass	
11555.360	26.42	14.69	6.55	47.66	AvgMax	H	346	281	54.00	-6.34	Pass	
14778.440	26.67	11.51	9.40	47.58	AvgMax	V	145	79	54.00	-6.42	Pass	
17960.847	39.89	12.29	13.27	65.45	PeakMax	V	381	87	74.00	-8.55	Pass	
12766.320	26.64	10.39	8.28	45.30	AvgMax	V	100	196	54.00	-8.70	Pass	
16858.139	39.98	11.36	12.44	63.78	PeakMax	V	185	350	74.00	-10.22	Pass	
15471.764	39.86	11.92	9.56	61.34	PeakMax	V	231	223	74.00	-12.66	Pass	
11555.360	39.86	14.69	6.55	61.11	PeakMax	H	346	281	74.00	-12.89	Pass	
14778.440	39.91	11.51	9.40	60.82	PeakMax	V	145	79	74.00	-13.18	Pass	
12766.320	41.13	10.39	8.28	59.79	PeakMax	V	100	196	74.00	-14.21	Pass	

Preview Data

Freq. (MHz)	Raw (dBuV)	Cable (dB)	Factor (dB)	Level (dBuV/m)	Emission Type	Pol (H/V)	Ht (cm)	Az (deg)	Limit (dBuV/m)	Margin (dB)	Pass/Fail	Comments
17960.847	28.86	12.29	13.27	54.42	Debug	V	184	315	54.00	0.42	Fail	
11555.360	29.07	14.69	6.55	50.31	Debug	H	200	90	54.00	-3.69	Pass	
16858.139	25.80	11.36	12.44	49.61	Debug	V	100	314	54.00	-4.39	Pass	
15471.764	25.14	11.92	9.56	46.62	Debug	V	100	314	54.00	-7.38	Pass	
14778.440	25.89	11.51	9.40	46.80	Debug	V	100	314	54.00	-7.20	Pass	
12766.320	25.93	10.39	8.28	44.60	Debug	V	100	314	54.00	-9.40	Pass	

Note: Preview data was measured using a peak detector to identify frequencies of interest for formal measurement. Formal data consist of all frequencies in the preview list within 6 dB of specification limit or the top six frequencies. Failure in preview data does not necessarily constitute failure in formal data.

RE 18GHz – 26.5GHz

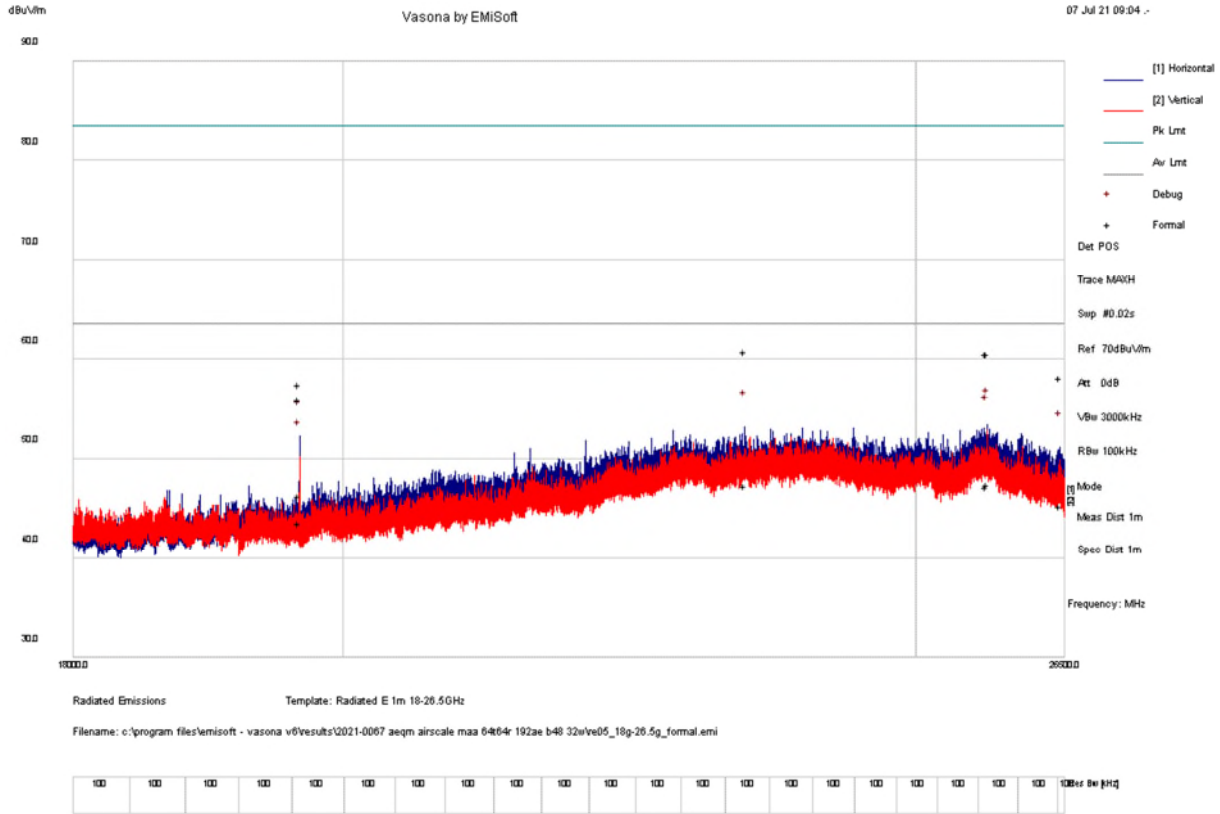

Test Information

Results Title	Radiated E 1m 18-26.5GHz
File Name	re05_18g-26.5g_formal.emi
Test Laboratory	MH-AR6, 24.5C, 53%RH, 997mB.
Test Engineer	GM
Test Software	Vasona by EMISoft, version 6.061
Equipment	Nokia
EUT Details	2021-0067 AEQM AirScale MAA 64T64R 192AE B48 32W, F1 3560MHz, TM3.1, 20MHz BW; F2 3580MHz, TM3.1, 20MHz BW Upper only. -48Vdc, AISG Cable
Configuration	Radiated Emissions 18GHz-26.5GHz, GR-1089 / FCC Pt.15 Class B limit, Rcvr ESU EIH69, PA E1387, Ant E1527, RBW: Previews 100KHz / Formals 1MHz, VBW: 3MHz,
Date	2021-07-07 10:09:22

Formal Data

Freq. (MHz)	Raw (dBuV)	Cable (dB)	Factor (dB)	Level (dBuV/m)	Emission Type	Pol (H/V)	Ht (cm)	Az (deg)	Limit (dBuV/m)	Margin (dB)	Pass/Fail	Comments
25712.977	36.31	16.61	-5.49	47.43	AvgMax	H	134	263	63.50	-16.07	Pass	
23389.779	36.95	17.01	-6.60	47.36	AvgMax	H	157	157	63.50	-16.14	Pass	
25707.624	36.09	16.61	-5.49	47.20	AvgMax	V	130	82	63.50	-16.30	Pass	
19660.755	42.50	12.14	-8.33	46.30	AvgMax	H	118	221	63.50	-17.20	Pass	
26449.450	35.44	15.02	-5.11	45.35	AvgMax	H	105	57	63.50	-18.15	Pass	
19660.776	39.79	12.14	-8.33	43.59	AvgMax	V	196	155	63.50	-19.91	Pass	

Freq. (MHz)	Raw (dBuV)	Cable (dB)	Factor (dB)	Level (dBuV/m)	Emission Type	Pol (H/V)	Ht (cm)	Az (deg)	Limit (dBuV/m)	Margin (dB)	Pass/Fail	Comments
23389.779	50.34	17.01	-6.60	60.75	PeakMax	H	157	157	83.50	-22.75	Pass	
25707.624	49.49	16.61	-5.49	60.60	PeakMax	V	130	82	83.50	-22.90	Pass	
25712.977	49.48	16.61	-5.49	60.60	PeakMax	H	134	263	83.50	-22.90	Pass	
26449.450	48.30	15.02	-5.11	58.21	PeakMax	H	105	57	83.50	-25.29	Pass	
19660.755	53.65	12.14	-8.33	57.45	PeakMax	H	118	221	83.50	-26.05	Pass	
19660.776	52.16	12.14	-8.33	55.96	PeakMax	V	196	155	83.50	-27.54	Pass	

Preview Data

Freq. (MHz)	Raw (dBuV)	Cable (dB)	Factor (dB)	Level (dBuV/m)	Emission Type	Pol (H/V)	Ht (cm)	Az (deg)	Limit (dBuV/m)	Margin (dB)	Pass/Fail	Comments
25712.977	42.25	16.61	-5.49	53.37	NoTune	H	100	154	63.50	-10.13	Pass	
23389.779	42.80	17.01	-6.60	53.21	NoTune	H	150	220	63.50	-10.29	Pass	
25707.624	41.63	16.61	-5.49	52.75	Debug	V	100	352	63.50	-10.75	Pass	
19660.755	48.44	12.14	-8.33	52.24	NoTune	H	100	220	63.50	-11.26	Pass	
26449.450	41.22	15.02	-5.11	51.13	NoTune	H	150	242	63.50	-12.37	Pass	
19660.776	46.39	12.14	-8.33	50.19	NoTune	V	100	352	63.50	-13.31	Pass	

Note: Preview data was measured using a peak detector to identify frequencies of interest for formal measurement. Formal data consist of all frequencies in the preview list within 6 dB of specification limit or the top six frequencies. Failure in preview data does not necessarily constitute failure in formal data.

RE 26.5 GHz – 40 GHz

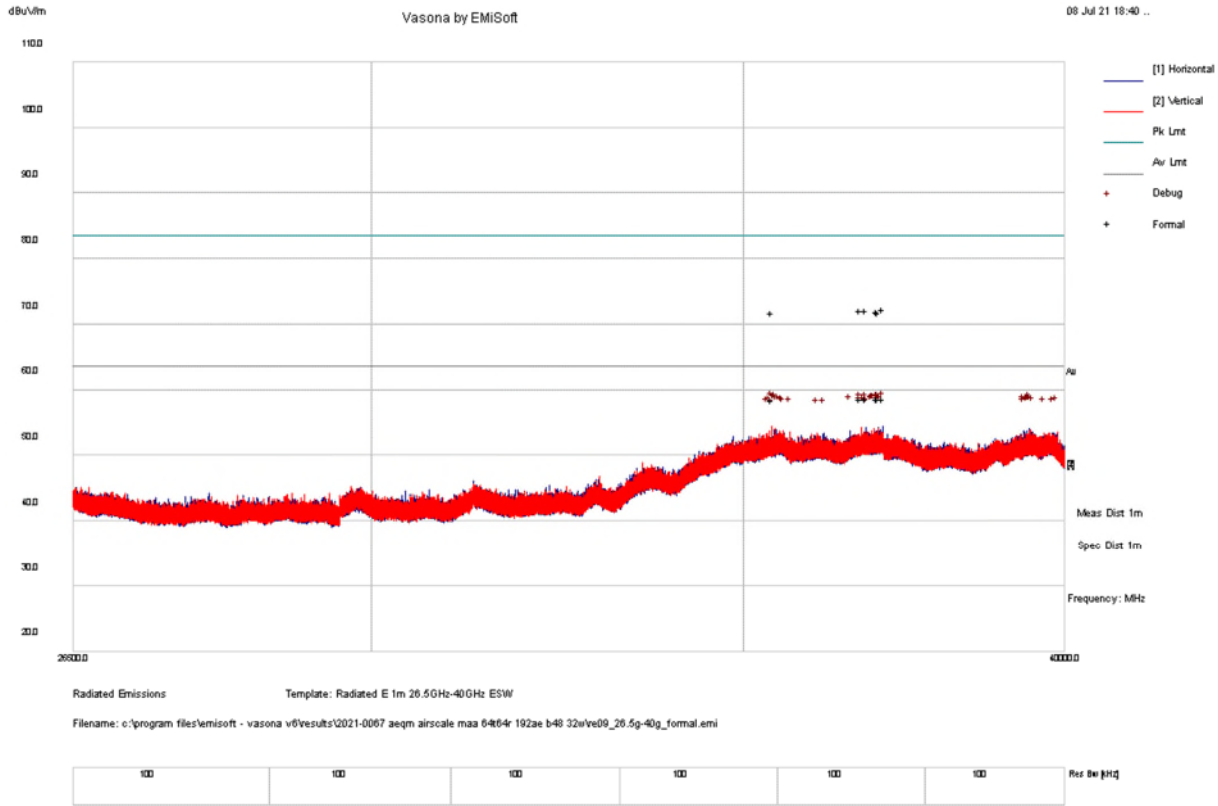

Test Information

Results Title	Radiated E 1m 26.5GHz-40GHz ESW
File Name	re09_26.5g-40g_formal.emi
Test Laboratory	MH-AR6, 23.8C, 62%RH, 990mB.
Test Engineer	GM
Test Software	Vasona by EMISoft, version 6.093
Equipment	Nokia
EUT Details	2021-0067 AEQM AirScale MAA 64T64R 192AE B48 32W, F1 3560MHz, TM3.1, 20MHz BW; F2 3580MHz, TM3.1, 20MHz BW Upper only. -48Vdc, AISG Cable
Configuration	Radiated Emissions: 26.5GHz-40GHz, GR-1089 / FCC Pt.15 Class B limit, Rcvr ESW E1511, Ant E526, RBW: Previews 100KHz / Formals 1MHz, VBW: 3MHz,
Date	2021-07-09 11:12:47

Formal Data

Freq. (MHz)	Raw (dBuV)	Cable (dB)	Factor (dB)	Level (dBuV/m)	Emission Type	Pol (H/V)	Ht (cm)	Az (deg)	Limit (dBuV/m)	Margin (dB)	Pass/Fail	Comments
37028.350	34.81	10.87	13.10	58.77	AvgMax	V	100	191	63.50	-4.73	Pass	
37015.375	34.80	10.87	13.11	58.77	AvgMax	H	127	257	63.50	-4.73	Pass	
37096.300	34.79	10.88	13.09	58.75	AvgMax	H	148	209	63.50	-4.75	Pass	
36836.500	34.76	10.83	13.15	58.74	AvgMax	H	122	30	63.50	-4.76	Pass	
36752.425	34.64	10.81	13.17	58.62	AvgMax	V	113	236	63.50	-4.88	Pass	
35420.350	35.06	10.49	12.95	58.51	AvgMax	V	175	293	63.50	-4.99	Pass	
37096.300	48.45	10.88	13.09	72.41	PeakMax	H	148	209	83.50	-11.09	Pass	
36836.500	48.27	10.83	13.15	72.25	PeakMax	H	122	30	83.50	-11.25	Pass	

Freq. (MHz)	Raw (dBuV)	Cable (dB)	Factor (dB)	Level (dBuV/m)	Emission Type	Pol (H/V)	Ht (cm)	Az (deg)	Limit (dBuV/m)	Margin (dB)	Pass/Fail	Comments
36752.425	48.19	10.81	13.17	72.17	PeakMax	V	113	236	83.50	-11.33	Pass	
37015.375	48.10	10.87	13.11	72.07	PeakMax	H	127	257	83.50	-11.43	Pass	
37028.350	47.95	10.87	13.10	71.92	PeakMax	V	100	191	83.50	-11.58	Pass	
35420.350	48.35	10.49	12.95	71.79	PeakMax	V	175	293	83.50	-11.71	Pass	

Preview Data

Freq. (MHz)	Raw (dBuV)	Cable (dB)	Factor (dB)	Level (dBuV/m)	Emission Type	Pol (H/V)	Ht (cm)	Az (deg)	Limit (dBuV/m)	Margin (dB)	Pass/Fail	Comments
37096.300	30.45	10.88	13.09	54.41	Debug	H	200	253	63.50	-9.09	Pass	
35420.350	30.88	10.49	12.95	54.32	Debug	V	100	319	63.50	-9.18	Pass	
37015.375	30.21	10.87	13.11	54.18	Debug	H	120	297	63.50	-9.32	Pass	
36836.500	30.17	10.83	13.15	54.14	Debug	H	200	264	63.50	-9.36	Pass	
36752.425	30.16	10.81	13.17	54.14	Debug	V	200	264	63.50	-9.36	Pass	
37028.350	30.13	10.87	13.10	54.10	Debug	V	140	264	63.50	-9.40	Pass	
35467.450	30.58	10.50	13.00	54.08	Debug	V	200	143	63.50	-9.42	Pass	
39417.625	28.13	11.38	14.55	54.07	Debug	H	160	330	63.50	-9.43	Pass	
36951.475	30.00	10.85	13.13	53.98	Debug	V	200	308	63.50	-9.52	Pass	
37023.325	29.98	10.87	13.10	53.95	Debug	H	160	99	63.50	-9.55	Pass	
35454.700	30.47	10.50	12.99	53.95	Debug	H	180	143	63.50	-9.55	Pass	
36946.300	29.94	10.85	13.13	53.92	Debug	H	200	341	63.50	-9.58	Pass	
37053.400	29.89	10.87	13.10	53.85	Debug	H	100	99	63.50	-9.65	Pass	
35484.925	30.32	10.50	13.02	53.84	Debug	H	200	231	63.50	-9.66	Pass	
39440.350	27.86	11.39	14.55	53.81	Debug	V	160	297	63.50	-9.69	Pass	
39407.725	27.86	11.38	14.56	53.79	Debug	H	140	77	63.50	-9.71	Pass	
39419.500	27.84	11.38	14.55	53.78	Debug	V	120	275	63.50	-9.72	Pass	
36591.400	29.71	10.77	13.29	53.78	Debug	H	200	132	63.50	-9.72	Pass	
36921.775	29.77	10.85	13.14	53.75	Debug	V	200	132	63.50	-9.75	Pass	
35532.025	30.19	10.51	13.03	53.73	Debug	V	160	99	63.50	-9.77	Pass	
39318.925	28.07	11.35	14.31	53.73	Debug	H	120	286	63.50	-9.77	Pass	
39384.400	27.83	11.37	14.51	53.71	Debug	H	180	264	63.50	-9.79	Pass	
35579.500	30.14	10.53	13.03	53.70	Debug	V	160	264	63.50	-9.80	Pass	
37003.975	29.67	10.86	13.11	53.65	Debug	V	160	198	63.50	-9.85	Pass	
36753.775	29.65	10.81	13.17	53.63	Debug	V	100	176	63.50	-9.87	Pass	
35387.050	30.20	10.48	12.93	53.62	Debug	V	120	308	63.50	-9.88	Pass	
39468.550	27.66	11.40	14.55	53.61	Debug	H	160	319	63.50	-9.89	Pass	
36807.400	29.60	10.82	13.15	53.57	Debug	V	120	352	63.50	-9.93	Pass	
39874.675	27.27	11.39	14.91	53.57	Debug	V	100	132	63.50	-9.93	Pass	
36856.525	29.49	10.83	13.15	53.47	Debug	V	200	209	63.50	-10.03	Pass	
35687.350	29.88	10.56	13.03	53.47	Debug	V	140	220	63.50	-10.03	Pass	
39334.375	27.74	11.35	14.36	53.45	Debug	H	180	286	63.50	-10.05	Pass	
39655.300	27.28	11.40	14.75	53.44	Debug	V	100	209	63.50	-10.06	Pass	
39818.275	27.03	11.39	15.01	53.43	Debug	H	180	198	63.50	-10.07	Pass	
35594.950	29.85	10.53	13.03	53.41	Debug	H	100	198	63.50	-10.09	Pass	
39807.475	26.97	11.39	15.03	53.39	Debug	H	160	143	63.50	-10.11	Pass	
35350.525	29.98	10.48	12.93	53.38	Debug	V	160	330	63.50	-10.12	Pass	
36094.000	29.38	10.67	13.26	53.31	Debug	V	120	110	63.50	-10.19	Pass	
35425.150	29.85	10.49	12.96	53.30	Debug	H	160	297	63.50	-10.20	Pass	
36198.700	29.36	10.69	13.23	53.27	Debug	H	120	44	63.50	-10.23	Pass	

Note: Preview data was measured using a peak detector to identify frequencies of interest for formal measurement. Formal data consist of all frequencies in the preview list within 6 dB of specification limit or the top six frequencies. Failure in preview data does not necessarily constitute failure in formal data.

Photographs

Radio Test

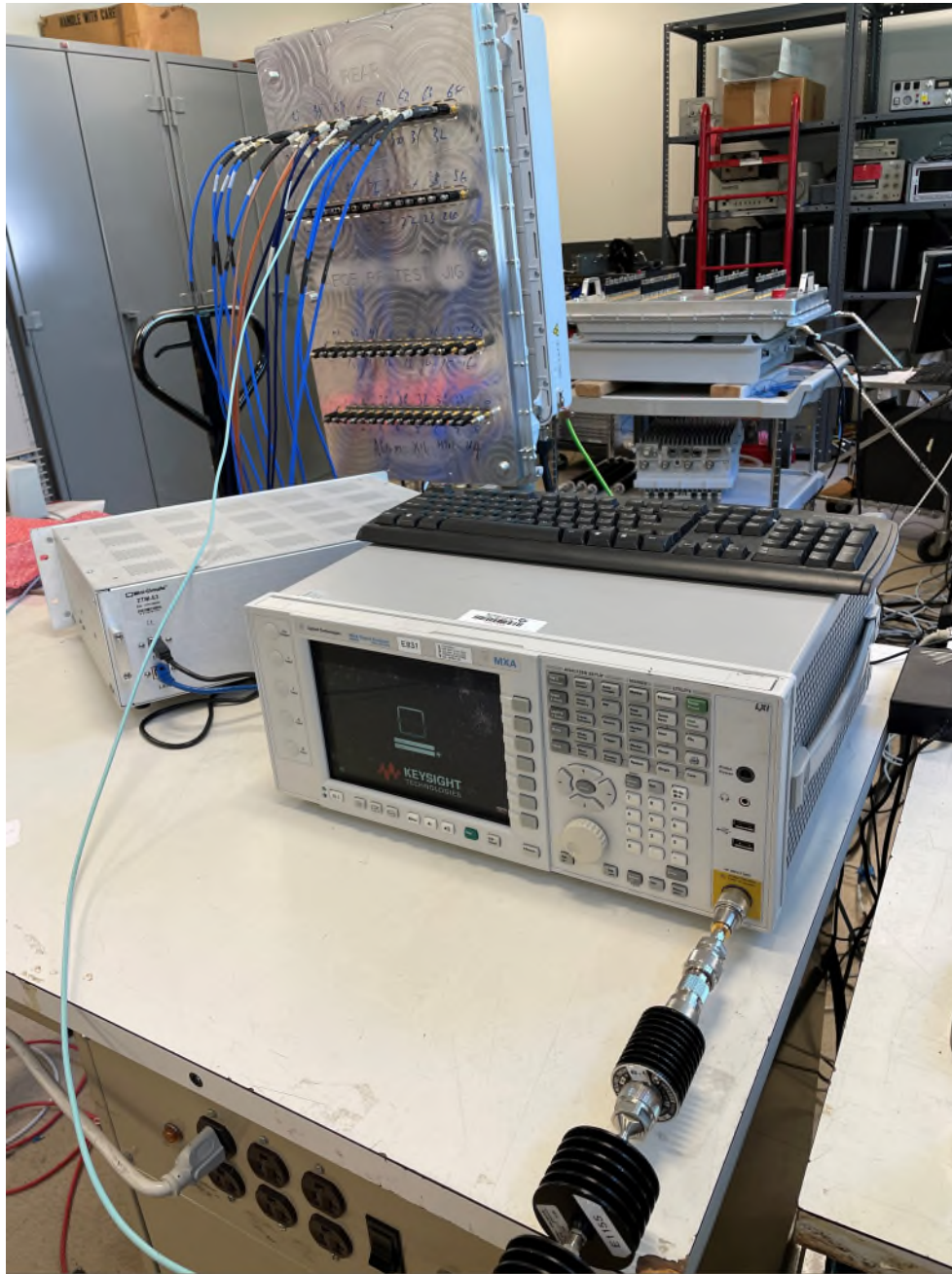

Radiated Emission Test

30MHz- 1GHz

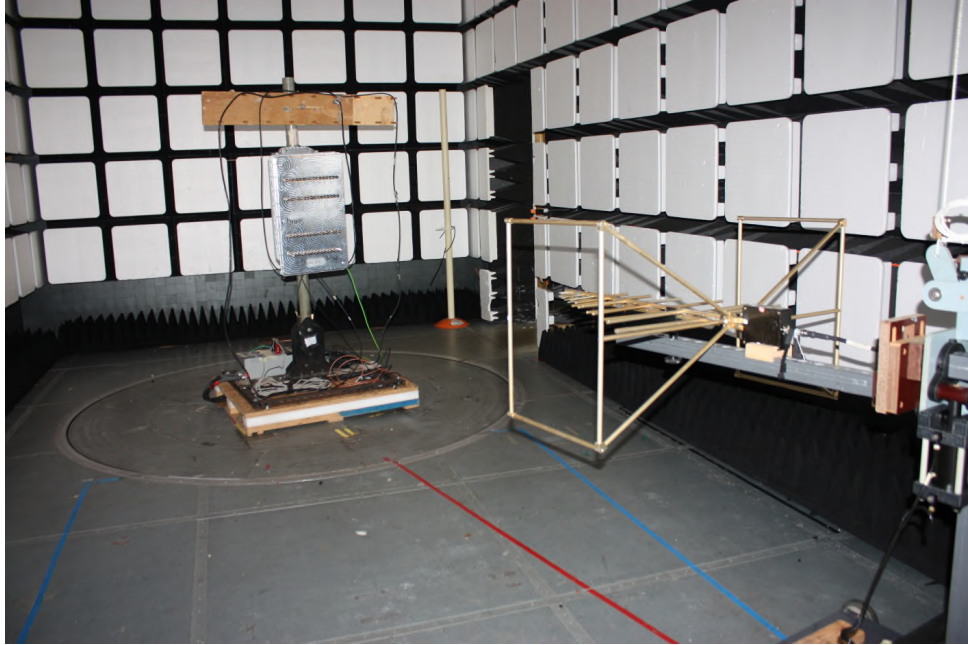

1GHz-18GHz

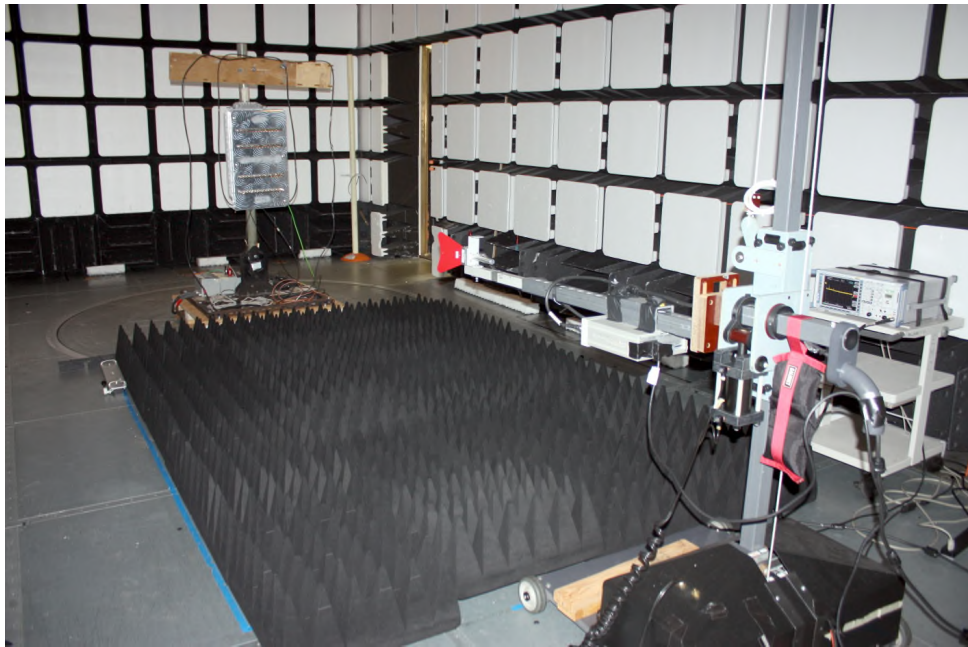

18GHz – 26.5GHz

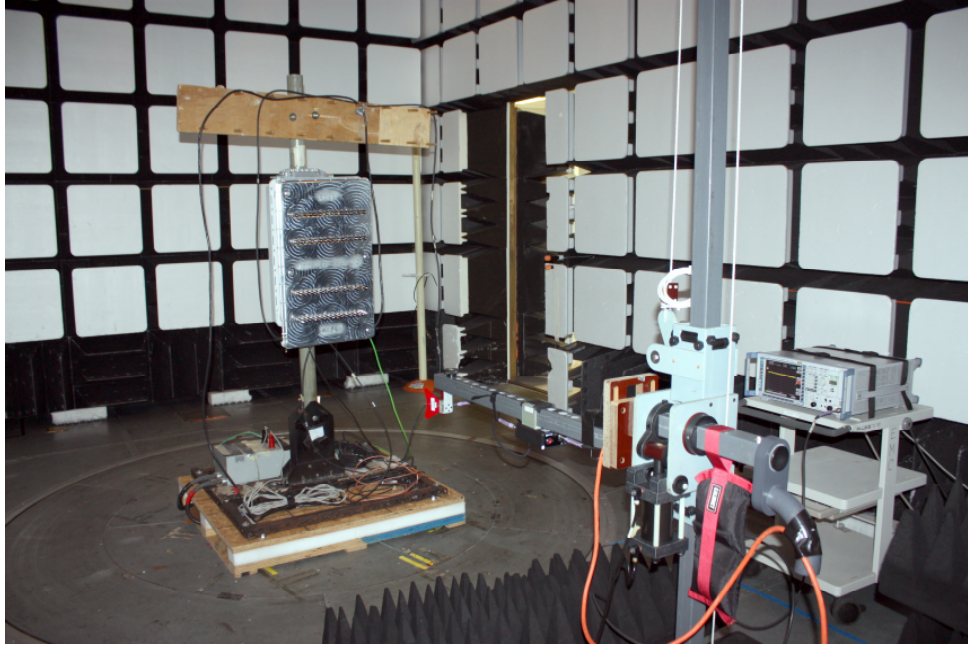

26.5GHz – 40GHz

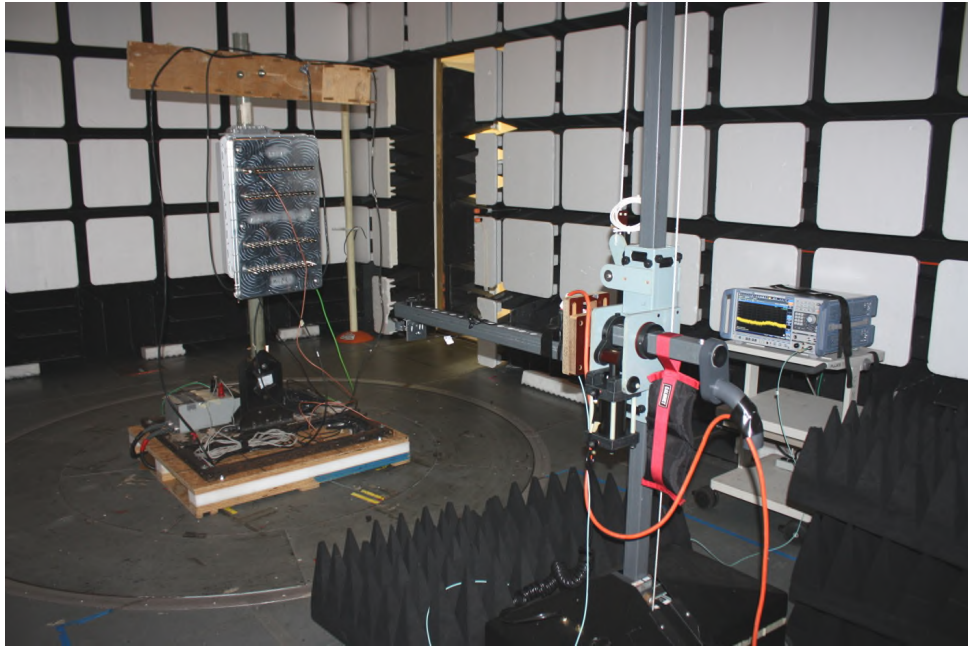

Test Equipment

Radio Test Equipment

Asset ID	Manufacturer	Type	Description	Model	Serial	Calibration Date	Calibration Due
E831	Agilent Technologies	MXA Signal Analyzer	20Hz-26.5GHz	N9020A	MY48011791	2020-06-16	2022-06-16
E896	Agilent Technologies	Network Analyzer	10 MHz - 40 GHz	N5230C	MY49000897	2021-03-03	2023-03-03
E1338	KeySight Technologies	MXA Signal Analyzer		N9020B	MY57430927	2019-11-14	2021-11-14
E1212	RLC Electronics Inc	Filter, High Pass	10 - 30 GHz, 2W, 5dB	F-19414	1444002	CNR-V	CNR-V
E1479	Reactel, Inc.	Filter, High Pass	DC - 4.3 GHz	11HS-X4.3 GS11	SN20-01	CNR-V	CNR-V
E1156	Weinschel	Attenuator	10dB 0.05GHz-26GHz 25W	74-10-12	1069	CNR-V	CNR-V
E1155	Weinschel	Attenuator	10dB 25Watt 0.05GHz - 26GHz	74-10-12	1068	CNR-V	CNR-V

Customer Provided Equipment

Manufacturer	Type	Description	Model	Serial	Calibration Date	Calibration Due
Weinschel	Attenuator	6dB 25Watt	35-6	AC8553	CNR-V	CNR-V

CNR-V: Calibration Not Required, Must Be Verified

Radiated Emission Test Equipment

Asset ID	Manufacturer	Type	Description	Model	Serial	Calibration Date	Calibration Due
E766	A.H. Systems Inc.	Biological Antenna	25 - 2000 MHz	SAS-521-2	457	2021-05-18	2023-05-18
E1074	ETS Lindgren	Horn Antenna	Double-Ridged Waveguide Horn 1-18 GHz	3117	00135194	2019-05-01	2021-08-01
E1120	Extech	Data Logger	Pressure Humidity Temp Data Logger	SD700	Q673552	2021-01-11	2023-01-11
E376	Hewlett Packard	Pre-Amplifier	Preamplifier 1-26.5 GHz	8449B	3008A01270	2020-10-21	2022-10-21
E1387	Miteq	Pre-Amplifier	18 GHz-40 GHz, 45dBm	TTA1840-35-HG	2034	2020-08-28	2022-08-28
EIH69	Rohde & Schwarz	Test Receiver	EMI 20Hz - 40GHz -155 dBm +30 dBm	ESU40	100247	2020-10-29	2022-10-29
E1511	Rohde & Schwarz	Test Receiver	EMI Test Receiver 2 Hz - 44 GHz	ESW44	101965	2021-04-07	2023-04-07
E507	Sonoma Instrument Co.	Amplifier	9KHz-1GHz	310	185794	2020-10-20	2022-10-20

7. FCC Section 2.1055 - Measurement of Frequency Stability

Frequency Stability testing was completed on AEQM Unit with Center Frequency 3560 MHz. Testing was performed from 6/4/2021 – 6/7/2021, which was located in the T-6 Thermal chamber of the Global Product Compliance Laboratory (GPCL) test facility located in Building 4, Room 4-280, Murray Hill, NJ, by Joe Bordonaro from GPCL.

The temperatures to which the UUT were subjected ranged from a high temperature of +50°C system ambient to a low temperature of -30°C system ambient with measurements recorded at +20°C, +50°C, and -30°C.

Frequency Stability performance was verified by measuring Frequency Tolerance using an MXA Signal Analyzer. Frequency Tolerance is a measurement of the difference between the actual transmit frequency and the assigned frequency (3560 MHz).

Frequency Block Tested: AEQM (CF = 3560MHz)

Baseline Measurement at +25°C

Transmit Frequency Deviation at +25°C at 100% of Nominal Voltage, -48VDC	
Time (minutes)	Transmit Carrier Deviation (Hz)
0	+3.8750
0.5	-13.902
1.0	+1.8302
1.5	-3.8023
2.0	+3.4776
2.5	-6.7544
3.0	-1.9865
FCC SPECIFICATION	3560 MHz (±0.05ppm) ±0.05ppm = ± 178Hz
FCC RESULT	PASS

Transmit Frequency Deviation at +50°C at 100% of Nominal Voltage, -48VDC	
Time (minutes)	Transmit Carrier Deviation (Hz)
0	-10.750
0.5	+14.759
1.0	-0.69670
1.5	-4.5439
2.0	+6.7892
2.5	+2.4771
3.0	+4.4456
FCC SPECIFICATION	3560 MHz (±0.05ppm) ±0.05ppm = ± 178Hz
FCC RESULT	PASS

Transmit Frequency Deviation at +40°C at 100% of Nominal Voltage, -48VDC	
Time (minutes)	Transmit Carrier Deviation (Hz)
0	+0.24684
0.5	-1.6141
1.0	+0.59917
1.5	-12.505
2.0	+4.8579
2.5	-8.3321
3.0	-1.2769
FCC SPECIFICATION	3560 MHz (±0.05ppm) ±0.05ppm = ± 178Hz
FCC RESULT	PASS

Transmit Frequency Deviation at +30°C at 100% of Nominal Voltage, -48VDC	
Time (minutes)	Transmit Carrier Deviation (Hz)
0	+4.1848
0.5	+16.636
1.0	-6.1450
1.5	+6.6178
2.0	+4.6371
2.5	-10.283
3.0	+4.9190
FCC SPECIFICATION	3560 MHz (±0.05ppm) ±0.05ppm = ± 178Hz
FCC RESULT	PASS

Transmit Frequency Deviation at +20°C at 100% of Nominal Voltage, -48VDC	
Time (minutes)	Transmit Carrier Deviation (Hz)
0	+3.4777
0.5	-3.0568
1.0	+4.3705
1.5	-0.16530
2.0	-10.218
2.5	-0.82249
3.0	-4.7172
FCC SPECIFICATION	3560 MHz (±0.05ppm) ±0.05ppm = ± 178Hz
FCC RESULT	PASS

Transmit Frequency Deviation at +10°C at 100% of Nominal Voltage, -48VDC	
Time (minutes)	Transmit Carrier Deviation (Hz)
0	+12.347
0.5	+1.4347
1.0	-17.583
1.5	+3.5924
2.0	10.104
2.5	+2.0754
3.0	-6.3512
FCC SPECIFICATION	3560 MHz (±0.05ppm) ±0.05ppm = ± 178Hz
FCC RESULT	PASS

Transmit Frequency Deviation at 0°C at 100% of Nominal Voltage, -48VDC	
Time (minutes)	Transmit Carrier Deviation (Hz)
0	+6.1104
0.5	-1.7525
1.0	-7.8115
1.5	+13.826
2.0	-14.378
2.5	+6.6687
3.0	-2.0080
FCC SPECIFICATION	3560 MHz (±0.05ppm) ±0.05ppm = ± 178Hz
FCC RESULT	PASS

Transmit Frequency Deviation at -10°C at 100% of Nominal Voltage, -48VDC	
Time (minutes)	Transmit Carrier Deviation (Hz)
0	-5.2349
0.5	+9.9507
1.0	+3.7016
1.5	+1.2450
2.0	+4.8887
2.5	-3.3121
3.0	+13.657
FCC SPECIFICATION	3560 MHz (±0.05ppm) ±0.05ppm = ± 178Hz
FCC RESULT	PASS

Transmit Frequency Deviation at -20°C at 100% of Nominal Voltage, -48VDC	
Time (minutes)	Transmit Carrier Deviation (Hz)
0	+7.5858
0.5	+2.5196
1.0	-1.6503
1.5	-19.487
2.0	+4.7748
2.5	-8.2757
3.0	+3.2537
FCC SPECIFICATION	3560 MHz (±0.05ppm) ±0.05ppm = ± 178Hz
FCC RESULT	PASS

Transmit Frequency Deviation at -30°C at 100% of Nominal Voltage, -48VDC	
Time (minutes)	Transmit Carrier Deviation (Hz)
0	+0.26955
0.5	+2.8445
1.0	-1.3958
1.5	-7.6142
2.0	+6.4045
2.5	+4.5395
3.0	-4.8253
FCC SPECIFICATION	3560 MHz (±0.05ppm) ±0.05ppm = ± 178Hz
FCC RESULT	PASS

Upon return to +25°C.

Transmit Frequency Deviation at +25°C at 100% of Nominal Voltage, -48VDC	
Time (minutes)	Transmit Carrier Deviation (Hz)
0	-4.4163
0.5	+6.9856
1.0	+3.5827
1.5	+6.7737
2.0	-1.5648
2.5	+ 6.0202
3.0	-4.4824
FCC SPECIFICATION	3560 MHz (±0.05ppm) ±0.05ppm = ± 178Hz
FCC RESULT	PASS

Transmit Frequency Deviation at +25°C at 103% of Nominal Voltage, -49.44VDC	
Time (minutes)	Transmit Carrier Deviation (Hz)
0	-1.1464
0.5	+9.8085
1.0	+19.991
1.5	+5.3323
2.0	+0.48917
2.5	+13.545
3.0	-9.5809
FCC SPECIFICATION	3560 MHz (±0.05ppm) ±0.05ppm = ± 178Hz
FCC RESULT	PASS

Transmit Frequency Deviation at +25°C at 106% of Nominal Voltage, -50.88VDC	
Time (minutes)	Transmit Carrier Deviation (Hz)
0	-2.4299
0.5	+1.5974
1.0	-0.79784
1.5	-5.1383
2.0	+3.4425
2.5	-3.4280
3.0	+5.5968
FCC SPECIFICATION	3560 MHz (±0.05ppm) ±0.05ppm = ± 178Hz
FCC RESULT	PASS

Transmit Frequency Deviation at +25°C at 109% of Nominal Voltage, -52.32VDC	
Time (minutes)	Transmit Carrier Deviation (Hz)
0	+9.7076
0.5	+3.6390
1.0	-3.7666
1.5	+10.642
2.0	-2.5427
2.5	-0.48523
3.0	-10.696
FCC SPECIFICATION	3560 MHz (±0.05ppm) ±0.05ppm = ± 178Hz
FCC RESULT	PASS

Transmit Frequency Deviation at +25°C at 112% of Nominal Voltage, -53.76VDC	
Time (minutes)	Transmit Carrier Deviation (Hz)
0	+4.2895
0.5	-1.8626
1.0	+13.894
1.5	-2.8591
2.0	+5.8917
2.5	+10.770
3.0	-6.5248
FCC SPECIFICATION	3560 MHz (±0.05ppm) ±0.05ppm = ± 178Hz
FCC RESULT	PASS

Transmit Frequency Deviation at +25°C at 115% of Nominal Voltage, -55.20VDC	
Time (minutes)	Transmit Carrier Deviation (Hz)
0	+2.6357
0.5	-5.4152
1.0	-0.59246
1.5	+3.2770
2.0	-9.0774
2.5	+2.6013
3.0	+15.475
FCC SPECIFICATION	3560 MHz (±0.05ppm) ±0.05ppm = ± 178Hz
FCC RESULT	PASS

Transmit Frequency Deviation at +25°C at 100% of Nominal Voltage, -48.0VDC	
Time (minutes)	Transmit Carrier Deviation (Hz)
0	+3.3582
0.5	-2.2634
1.0	+6.6301
1.5	-0.55364
2.0	-6.9080
2.5	-11.393
3.0	+5.8138
FCC SPECIFICATION	3560 MHz (±0.05ppm) ±0.05ppm = ± 178Hz
FCC RESULT	

Transmit Frequency Deviation at +25°C at -3% of Nominal Voltage, -46.56VDC	
Time (minutes)	Transmit Carrier Deviation (Hz)
0	+9.5083
0.5	+13.494
1.0	-0.41294
1.5	-6.7902
2.0	+4.6328
2.5	+2.0616
3.0	+4.9448
FCC SPECIFICATION	3560 MHz (±0.05ppm) ±0.05ppm = ± 178Hz
FCC RESULT	PASS

Transmit Frequency Deviation at +25°C at -6% of Nominal Voltage, -45.12VDC	
Time (minutes)	Transmit Carrier Deviation (Hz)
0	-17.856
0.5	+2.7755
1.0	-6.8828
1.5	+7.2832
2.0	+4.2438
2.5	+4.7231
3.0	+5.3656
FCC SPECIFICATION	3560 MHz (±0.05ppm) ±0.05ppm = ± 178Hz
FCC RESULT	PASS

Transmit Frequency Deviation at +25°C at -9% of Nominal Voltage, -43.68VDC	
Time (minutes)	Transmit Carrier Deviation (Hz)
0	+0.86277
0.5	-3.9744
1.0	+6.7785
1.5	+3.6722
2.0	-2.6485
2.5	+6.2182
3.0	+12.340
FCC SPECIFICATION	3560 MHz (±0.05ppm) ±0.05ppm = ± 178Hz
FCC RESULT	PASS

Transmit Frequency Deviation at +25°C at -12% of Nominal Voltage, -42.24VDC	
Time (minutes)	Transmit Carrier Deviation (Hz)
0	-6.4749
0.5	-2.9890
1.0	+8.6116
1.5	+3.8308
2.0	-4.4166
2.5	-3.7443
3.0	-18.172
FCC SPECIFICATION	3560 MHz (±0.05ppm) ±0.05ppm = ± 178Hz
FCC RESULT	PASS

Transmit Frequency Deviation at +25°C at -15% of Nominal Voltage, -40.80VDC	
Time (minutes)	Transmit Carrier Deviation (Hz)
0	-0.89076
0.5	-3.5690
1.0	+6.9530
1.5	+3.8680
2.0	-7.8853
2.5	+2.3236
3.0	+9.0061
FCC SPECIFICATION	3560 MHz (±0.05ppm) ±0.05ppm = ± 178Hz
FCC RESULT	PASS

Photographs

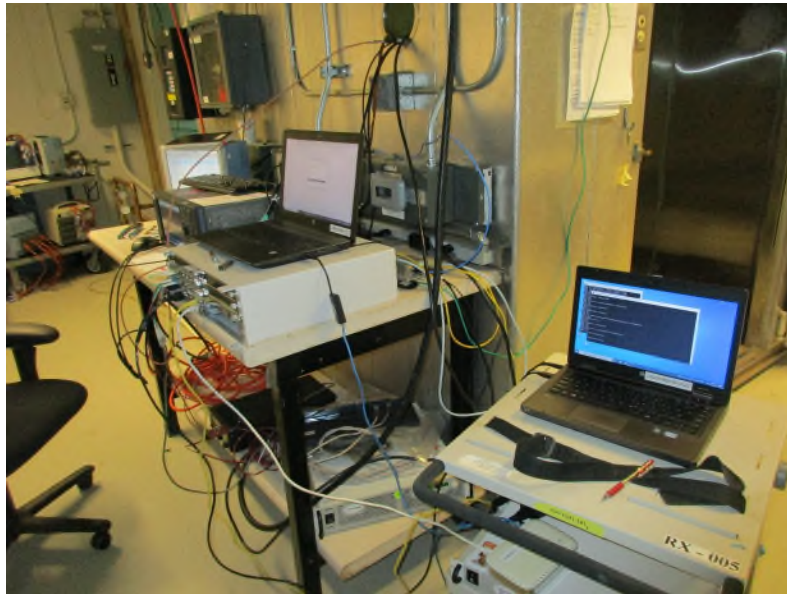

Test Equipment

Asset ID	Manufacturer	Type	Description	Model	Serial	Calibration Date	Calibration Due
E1338	KeySight Technologies	MXA Signal Analyzer		N9020B	MY57120303	2020-12-21	2022-12-21
TH530-T06	Thermotron	Controller		Thermotron 7800	8E62408	2019-09-18	2021-09-18
TH-T06	Thermotron	Thermal Chamber		N/A	28972	2019-09-13	2021-09-13
TH070	Vaisala	Transmitter	Humidity and Temperature	HMT330	J3330109	2019-12-04	2021-12-04
TH085	Yokogawa	Recorder		GP20	S5PB04190	2020-02-25	2022-02-25
TH149	Fluke	Multimeter	Digital Multimeter	87III	7519030337	2019-07-22	2021-07-22
N/A	TDK Lambda	Power Supply	DC Source	GEN 60-85-3P208	13N5110J	CNR	CNR

CNR – Calibration Not Required

Chamber Plots

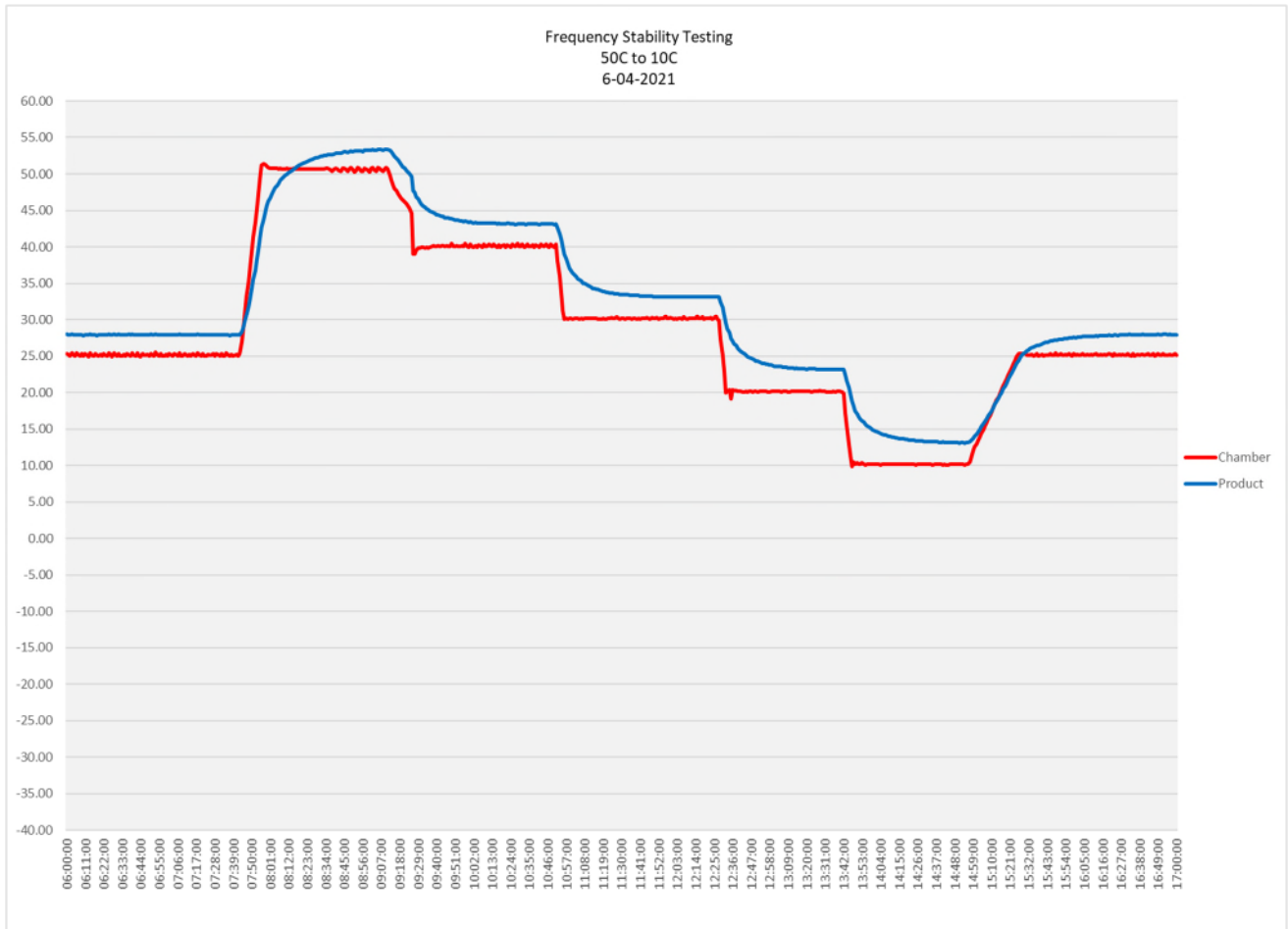

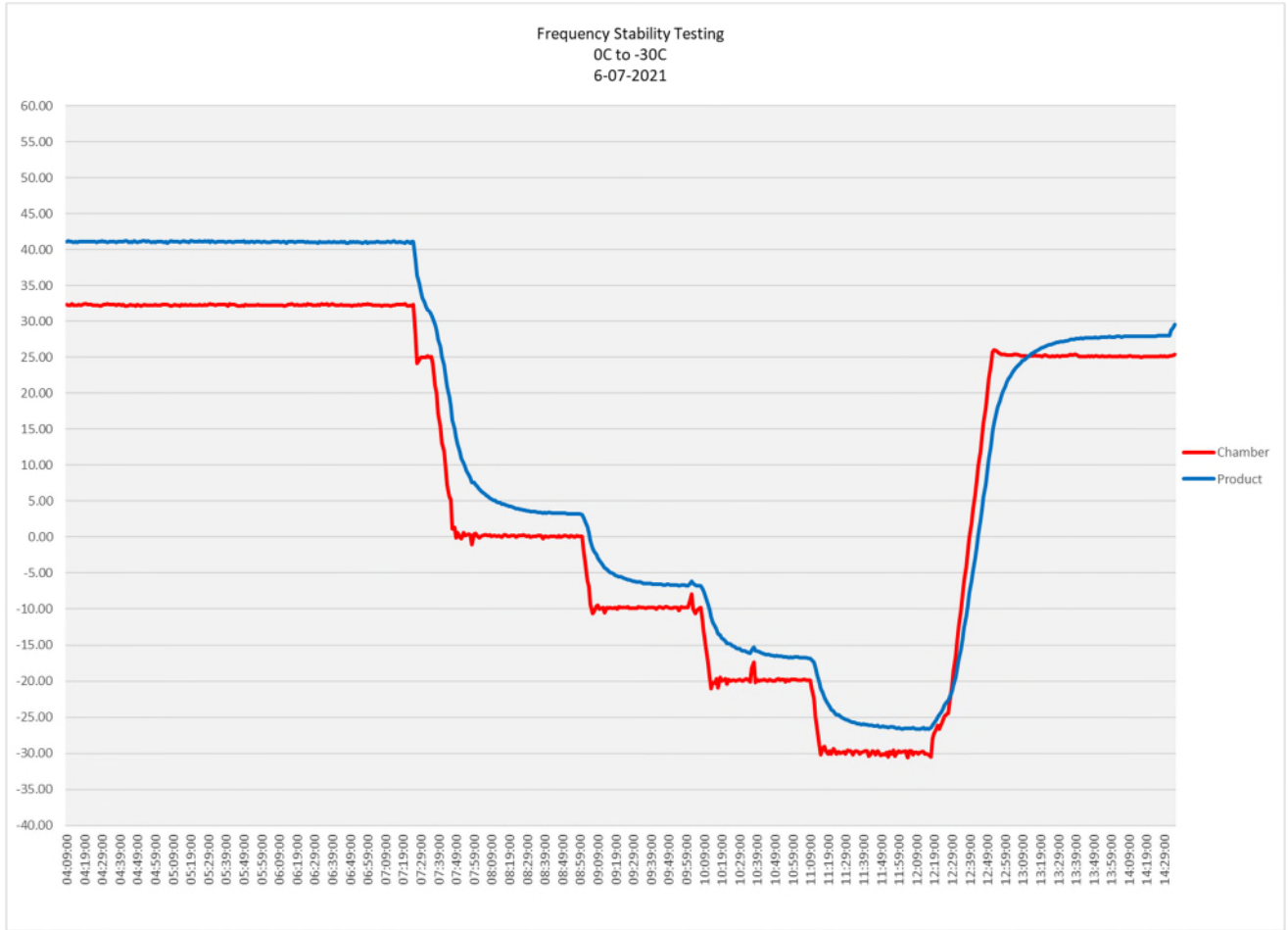

8. NVLAP Certificate of Accreditation

United States Department of Commerce
National Institute of Standards and Technology



Certificate of Accreditation to ISO/IEC 17025:2017

NVLAP LAB CODE: 100275-0

Nokia, Global Product Compliance Lab
Murray Hill, NJ

*is accredited by the National Voluntary Laboratory Accreditation Program for specific services,
listed on the Scope of Accreditation, for:*

Electromagnetic Compatibility & Telecommunications

*This laboratory is accredited in accordance with the recognized International Standard ISO/IEC 17025:2017.
This accreditation demonstrates technical competence for a defined scope and the operation of a laboratory quality
management system (refer to joint ISO-ILAC-IAF Communique dated January 2009).*

2020-09-25 through 2021-09-30

Effective Dates





For the National Voluntary Laboratory Accreditation Program