

EXHIBIT 5

**RF  
EXPOSURE  
REPORT**

## RF exposure compliance assessment

Massive MIMO Adaptive Antenna Products – AEHB/AEHC

FCC ID: VBNAEHC-01

---

Author	Kamil Bechta
Owner	Christophe Grangeat
Organization	MN 5G&SC Arch
Approver	Mikko Siira
Document Type	Final test report
Document ID	LPITPN2I4Q5L-1109616211-1041
Document location	<a href="https://teams.microsoft.com/_/files/General?threadId=19:199516ad8ed84ef78ed31c6252c0534d@thread.skype&amp;ctx=channel&amp;context=Products-RF-exposure-assessment&amp;rootfolder=%252Fsites%252FFMFProductManagement%252FShared%252FDocuments%252FGeneral%252FProducts-RF-exposure-assessment%252FAEHB_AEHC">https://teams.microsoft.com/_/files/General?threadId=19:199516ad8ed84ef78ed31c6252c0534d@thread.skype&amp;ctx=channel&amp;context=Products-RF-exposure-assessment&amp;rootfolder=%252Fsites%252FFMFProductManagement%252FShared%252FDocuments%252FGeneral%252FProducts-RF-exposure-assessment%252FAEHB_AEHC</a>

---

### Change History

Version	Status	Date	Author	Owner	Reviewed by	Reviewed date	Approver	Approval date	Description of changes
1.0	Final	08-05-2020	K. Bechta	C. Grangeat	C. Grangeat	11-05-2020	M. Siira	27-05-2020	

This material, including documentation and any related computer programs, is protected by copyright controlled by Nokia. All rights are reserved. Copying, including reproducing, storing, adapting or translating, any or all of this material requires the prior written consent of Nokia. This material also contains confidential information, which may not be disclosed to others without the prior written consent of Nokia.

## Contents

1	General content.....	5
2	References.....	5
2.1	Applicable RF exposure standards and regulations .....	5
2.2	Product and assessment method.....	6
3	RF exposure limits .....	6
4	Description of the equipment under test (EUT) .....	7
5	RF exposure assessment method.....	12
6	RF exposure computation results.....	13
6.1	Regions of application: EU/ICNIRP, Australia/NZ and US/related.....	13
6.2	Regions of application: Canada .....	17
7	Conclusion and installation recommendations.....	21

## List of Tables

Table 1 – Applicable RF exposure levels in n41 band expressed in power density .....	6
Table 2 – AEHB/AEHC product general technical characteristics.....	7
Table 3 - Reference system used in this report (from NGMN white paper [16]) .....	8
Table 4 – Antenna patterns for most boresight direction.....	9
Table 5 – Antenna patterns for max azimuth steering.....	10
Table 6 – Antenna patterns for max elevation steering.....	11
Table 7 – Antenna gain characteristics for various beam steering directions used during EMF evaluation .....	12
Table 8 - Validation of the antenna model at 2595 MHz.....	13
Table 9 – AEHB/AEHC RF exposure compliance distances based on the time-averaged maximum transmitted power of 339 W (corresponding to 320 W rated max transmitted power) for EU/ICNIRP, Australia/NZ and US/related .....	21
Table 10 - AEHB/AEHC RF exposure compliance distances based on the time-averaged maximum transmitted power of 339 W (corresponding to 320 W rated max transmitted power) for Canada .....	22

Table 11 – AEHB/AEHC RF exposure compliance distances based on the time-averaged actual maximum transmitted power of 85 W (corresponding to 320 W rated max transmitted power) for EU/ICNIRP, Australia/NZ and US/related.....22

Table 12 – AEHB/AEHC RF exposure compliance distances based on the time-averaged actual maximum transmitted power of 85 W (corresponding to 320 W rated max transmitted power) for Canada .....23

## List of Figures

Figure 1 – Shape of the compliance boundary used for the RF exposure compliance assessment (from [4])..... 12

Figure 2 – Top view of the power density for the time-averaged maximum transmitted power of 339 W and the beam oriented in azimuth = 0° & elevation = +6° (EU/ICNIRP, Australia/NZ and US/related)..... 14

Figure 3 – Top view of the power density for the time-averaged actual maximum transmitted power of 85 W and the beam oriented in azimuth = 0° & elevation = +6° (EU/ICNIRP, Australia/NZ and US/related) ..... 15

Figure 4 – Side view of the power density for the time-averaged maximum transmitted power of 339 W and the beam oriented in azimuth = -5° & elevation = +15° (EU/ICNIRP, Australia/NZ and US/related)..... 15

Figure 5 – Side view of the power density for the time-averaged actual maximum transmitted power of 85 W and the beam oriented in azimuth = -5° & elevation = +15° (EU/ICNIRP, Australia/NZ and US/related) ..... 16

Figure 6 – Top view of the power density for the time-averaged maximum transmitted power of 339 W and the beam oriented in azimuth = -51° & elevation = +4° (EU/ICNIRP, Australia/NZ and US/related)..... 16

Figure 7 – Top view of the power density for the time-averaged actual maximum transmitted power of 85 W and the beam oriented in azimuth = -51° & elevation = +4° (EU/ICNIRP, Australia/NZ and US/related) ..... 17

Figure 8 – Top view of the power density for the time-averaged maximum transmitted power of 339 W and the beam oriented in azimuth = 0° & elevation = +6° (Canada)..... 18

Figure 9 – Top view of the power density for the time-averaged actual maximum transmitted power of 85 W and the beam oriented in azimuth = 0° & elevation = +6° (Canada) ..... 19

Figure 10 – Side view of the power density for the time-averaged maximum transmitted power of 339 W and the beam oriented in azimuth = -5° & elevation = +15° (Canada) ..... 19

Figure 11 – Side view of the power density for the time-averaged actual maximum transmitted power of 85 W and the beam oriented in azimuth = -5° & elevation = +15° (Canada) .....20

Figure 12 – Top view of the power density for the time-averaged maximum transmitted power of 339 W and the beam oriented in azimuth = -51° & elevation = +4° (Canada) .....20

Figure 13 – Top view of the power density for the time-averaged actual maximum transmitted power of 85 W and the beam oriented in azimuth =  $-51^\circ$  & elevation =  $+4^\circ$  (Canada) .....21

## 1 General content

This test report is addressing human exposure to radiofrequency electromagnetic fields (RF-EMF) transmitted by the following massive MIMO Adaptive Antenna (MAA) Product (see §2.2):

- Nokia AEHB AirScale MAA 64T64R 192AE B41 320W
- Nokia AEHC AirScale MAA 64T64R 192AE B41 320W
  - FCC ID: VBNAEHC-01

It provides the RF exposure compliance boundaries for these products regarding both general population and occupational exposure. Outside of these compliance boundaries, human exposure to RF-EMF is below the limits defined by the US Federal Communications Commission (FCC), Canada Safety Code 6, Australia ARPANSA and European regulations (see §2.1 and 3).

## 2 References

### 2.1 Applicable RF exposure standards and regulations

- [1] EU 1999/519/EC, “Council Recommendation on the limitation of exposure of the general public to electromagnetic fields (0 Hz to 300 GHz)”, July 1999
- [2] EU 2013/35/EU, “Directive of the European Parliament and of the Council on the minimum health and safety requirements regarding the exposure of workers to the risks arising from physical agents (electromagnetic fields) (20th individual Directive within the meaning of Article 16(1) of Directive 89/391/EEC) and repealing Directive 2004/40/EC”, June 2013
- [3] EN 50385:2017, “Product standard to demonstrate the compliance of base station equipment with radiofrequency electromagnetic field exposure limits (110 MHz - 100 GHz), when placed on the market”, July 2017
- [4] IEC/EN 62232:2017, “Determination of RF field strength, power density and SAR in the vicinity of radiocommunication base stations for the purpose of evaluating human exposure”, September 2017.
- [5] AS/NZS 2772.2, "Radiofrequency fields Part 2: Principles and methods of measurement and computation-3 kHz to 300 GHz", 2016
- [6] ARPANSA “Maximum Exposure Levels to Radiofrequency Fields — 3 kHz to 300 GHz”, Radiation Protection Series Publication No. 3, 2016
- [7] Canada Safety Code 6, “Limits of Human Exposure to Radiofrequency Electromagnetic Energy in the Frequency Range from 3 kHz to 300 GHz”, June 2015

- [8] Canada RSS-102, “Radio Frequency (RF) Exposure Compliance of Radiocommunication Apparatus (All Frequency Bands)”, Issue 5, March 2015,
- [9] US FCC 47CFR 1.1310 “Radiofrequency radiation exposure limits”, August 1997.
- [10] US FCC OET Bulletin 65, “Evaluating Compliance with FCC Guidelines for Human Exposure to Radiofrequency Electromagnetic Fields and its supplements”, edition 97-01, August 1997.

## 2.2 Product and assessment method

- [11] Nokia, “Massive MIMO Adaptive Antenna Product Description” DN207523773, Issue 02, 16-04-2018.
- [12] Microwave Vision Group (MVG), “EMF Visual User Manual”, SEWB/EMF-VISUAL-UM.1/v2019.1.
- [13] Z. Altman, B. Begasse, C. Dale, A. Karwowski, J. Wiart, M. Wong and L. Gattoufi, “Efficient models for base station antennas for human exposure assessment”, IEEE Trans. Electromagnetic Compatibility, Nov 2002, vol.44, pp. 588-592.
- [14] P. Baracca, A. Weber, T. Wild and C. Grangeat, “A Statistical Approach for RF Exposure Compliance Boundary Assessment in Massive MIMO Systems”, WSA 2018, <https://arxiv.org/abs/1801.08351>.
- [15] IEC TR62669, “Case studies supporting the implementation of IEC 62232”, (106/463/CD, July 2018).
- [16] NGMN white paper, “Recommendation on Base Station Active Antenna System Standards”, to be published.

## 3 RF exposure limits

The applicable RF exposure limits are defined by [1] and [2] in Europe and ICNIRP countries, by [5] in Australia and New Zealand, by [7] in Canada and by [9] in the US and related countries such as Bolivia, Estonia, Mexico and Panama. The applicable power density limits are recalled in Table 1 for the frequency range applicable to the equipment under test.

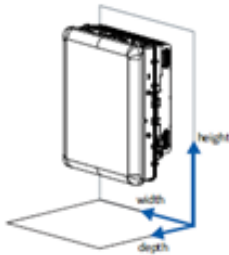

Table 1 – Applicable RF exposure levels in n41 band expressed in power density

Region of application	General Population/Uncontrolled Exposures	Occupational/Controlled Exposures
EU/ICNIRP, Australia/NZ, US/related	10 W/m <sup>2</sup>	50 W/m <sup>2</sup>
Canada	5.5 W/m <sup>2</sup>	32.2 W/m <sup>2</sup>

## 4 Description of the equipment under test (EUT)

The main technical characteristics of AEHB/AEHC product are reproduced in Table 2.

Table 2 – AEHB/AEHC product general technical characteristics

Product name	Nokia AEHB AirScale MAA 64T64R 192AE B41 320W Nokia AEHC AirScale MAA 64T64R 192AE B41 320W	
Model number	AEHB: 474698A AEHC: 475124A	
Certificate Identification	VBNAEHC-01	
Rated max Tx power	320 W	
Number of TXRX	64TX64RX	
Beamforming	Yes	
SW supported techno.	5G NR TDD	
Frequency range	AEHB: 2515 - 2675 MHz (3GPP sub-band B41) AEHC: 2496 - 2690 MHz (3GPP B41)	
Nb of antenna elements	12 (row) x 8 (column) x 2 (polarization)	
Gain	24 dBi	
EIRP	79 dBm	
Dynamic Horizontal steering range (HPBW)	±45° (3dB), ±60° (5dB)	
Vertical pre-tilt angle	+6°	
Max. vertical coverage angle (HPBW)	+12°/0° (upper SLS > 6dB)	
Dimensions	 <p>Height: 970 mm Depth: 150 mm Width: 545 mm</p>	
Technology duty cycle factor	75 %	
Transmitted power tolerance	1.5 dB	



The EMF Visual model used for the RF exposure assessment is derived from the model of the antenna array (pattern and gain) using the real beamforming weights (BFW) configured in the product. The EMF Visual model is validated with the product antenna model using the same BFW, pattern and gain. Table 4 to Table 7 include the comparison of the EMF Visual model and the product antenna model for beam configurations used for the assessment of the compliance boundary. Selected patterns ensure that maximum compliance distance, applicable to evaluated product, is obtained.

Azimuth and elevation angles indicated in this report are provided according to the reference system used in product data sheets (see Table 3), unless otherwise stated.

Table 3 - Reference system used in this report (from NGMN white paper [16])

<p>3D view Definition of azimuth <math>\varphi</math> and elevation <math>\theta</math></p>	
<p>Top view (horizontal cut) Definition of azimuth <math>\varphi</math></p>	
<p>Side view (vertical cut) Definition of elevation <math>\theta</math></p>	

Table 4 – Antenna patterns for most boresight direction

	Model for EMF evaluation	Product antenna model
Horizontal cut		
Vertical cut		
<p>NOTE: Angle references used in these graphs are derived from EMF Visual (left) and Planet Viewer (right), which may differ from product data sheet (see Table 3)</p>		

Table 5 – Antenna patterns for max azimuth steering

	Model for EMF evaluation	Product antenna model
Horizontal cut		
Vertical cut		
<p>NOTE: Angle references used in these graphs are derived from EMF Visual (left) and Planet Viewer (right), which may differ from product data sheet (see Table 3)</p>		

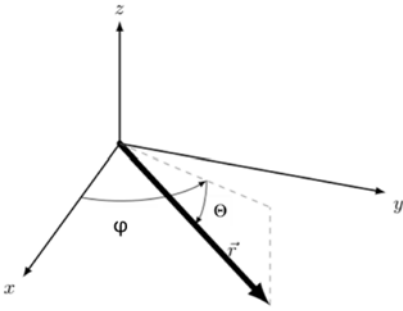
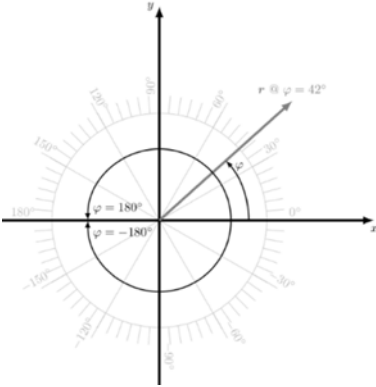
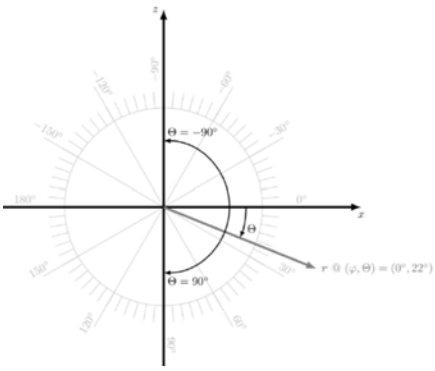
Table 6 – Antenna patterns for max elevation steering

	Model for EMF evaluation	Product antenna model
Horizontal cut		
Vertical cut		
<p>NOTE: Angle references used in these graphs are derived from EMF Visual (left) and Planet Viewer (right), which may differ from product data sheet (see Table 3)</p>		

Table 7 – Antenna gain characteristics for various beam steering directions used during EMF evaluation

	Azimuth	Elevation	Gain (dBi)
			2595 MHz
Boresight	0°	+6°	24.9
Max azimuth	-51°	+4°	20.7
Max elevation	-5°	+15°	22.9

The compliance boundary is defined by the box shape perimeter shown in Figure 4 of IEC 62232:2017 [4] and displayed in Figure 1. The distances  $D_f$ ,  $D_s$ ,  $D_{a,u}$  and  $D_{a,d}$  are taken from the nearest point of the antenna. For convenience, the distances  $D_{sc}$ ,  $D_{uc}$  and  $D_{dc}$  (respectively) taken from antenna center are also provided.

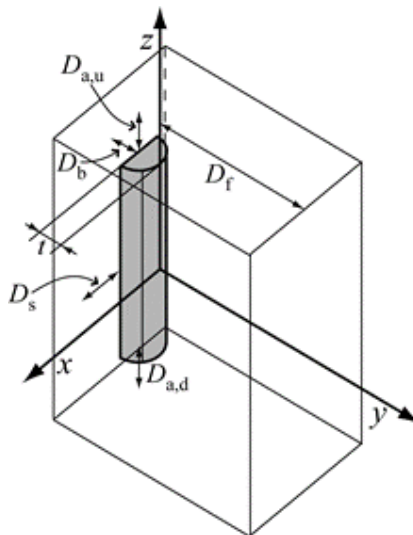

Figure 1 – Shape of the compliance boundary used for the RF exposure compliance assessment (from [4]).

## 5 RF exposure assessment method

RF exposure assessment is performed using the synthetic model computation method defined in B.4.4.1 of IEC 62232:2017. Calculations are performed with the “EMF Visual” software release OKTAL 2019 Version 4.0 (see [12] and [13]).

The validation of the model is performed in the configuration with the beam in front (azimuth = 0° and elevation = +6°). The validation results are provided in Table 8.

Table 8 - Validation of the antenna model at 2595 MHz

	Product model	EMF Visual model	Deviation
Gain	24.9 dBi	24.9 dBi	0.0 dB
Horizontal half-power beamwidth	14.0°	13.0°	1.0°
Vertical half-power beamwidth	8.0°	6.5°	1.5°

For each configuration, the directivity pattern is derived from the simulation model and the antenna gain is adjusted to match exactly the simulated values for accurate scaling.

The RF compliance distances are provided for the time-averaged maximum transmitted power of 339 W and, for information, the time-averaged actual maximum transmitted power of 85 W taking a 95<sup>th</sup> percentile approach as defined in [4], [14] and [15]. These values include a technology duty cycle factor of 75 % (see Table 2) for time averaging and a power tolerance of 1.5 dB due to electronic component dispersion and operational environmental conditions (temperature).

## 6 RF exposure computation results

### 6.1 Regions of application: EU/ICNIRP, Australia/NZ and US/related

The computed power density 3D distributions are displayed in Figure 2 to Figure 7 for RF exposure limits defined in [1], [2] for EU/ICNIRP countries, [5] for Australia/NZ and [9] for US/related countries.

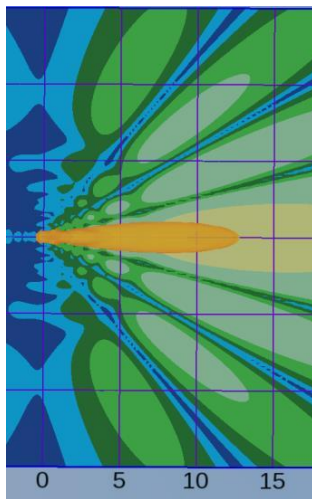
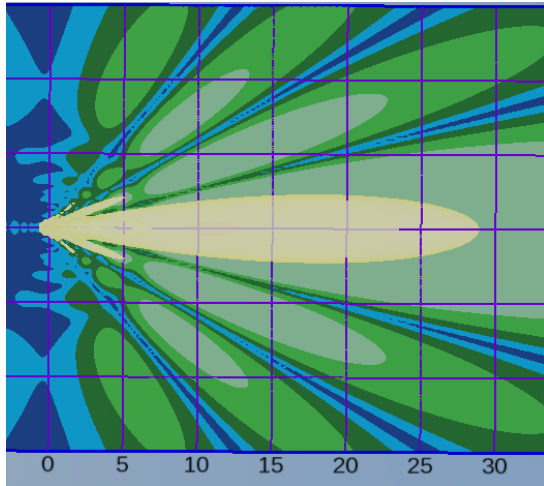

Grid: 5 m

10 W/m<sup>2</sup>  
General Population/Uncontrolled Exposures

50 W/m<sup>2</sup>  
Occupational/Controlled Exposures

Figure 2 – Top view of the power density for the time-averaged maximum transmitted power of 339 W and the beam oriented in azimuth = 0° & elevation = +6° (EU/ICNIRP, Australia/NZ and US/related)

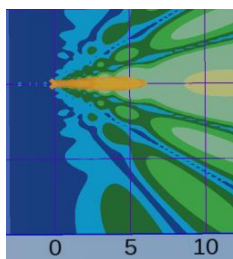
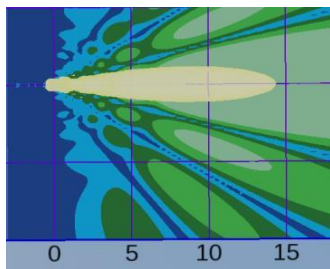

Grid: 5 m



Figure 3 – Top view of the power density for the time-averaged actual maximum transmitted power of 85 W and the beam oriented in azimuth = 0° & elevation = +6° (EU/ICNIRP, Australia/NZ and US/related)

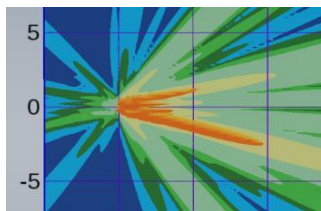
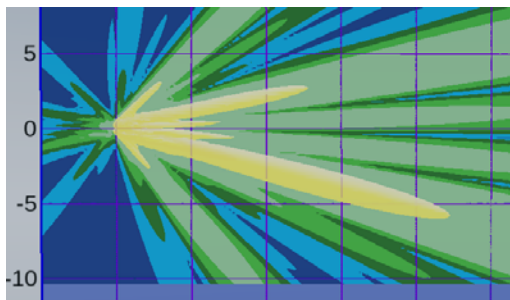

Grid: 5 m



Figure 4 – Side view of the power density for the time-averaged maximum transmitted power of 339 W and the beam oriented in azimuth = -5° & elevation = +15° (EU/ICNIRP, Australia/NZ and US/related)



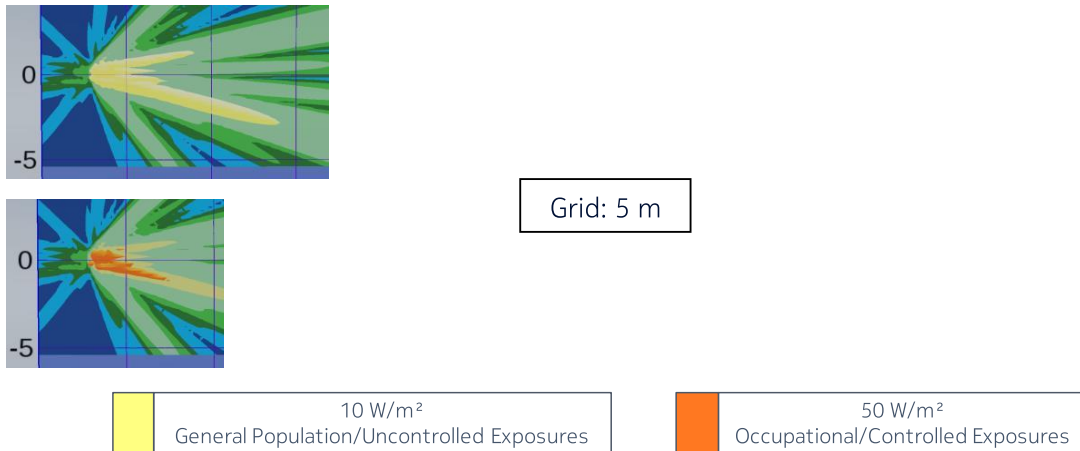

Figure 5 – Side view of the power density for the time-averaged actual maximum transmitted power of 85 W and the beam oriented in azimuth =  $-5^\circ$  & elevation =  $+15^\circ$  (EU/ICNIRP, Australia/NZ and US/related)

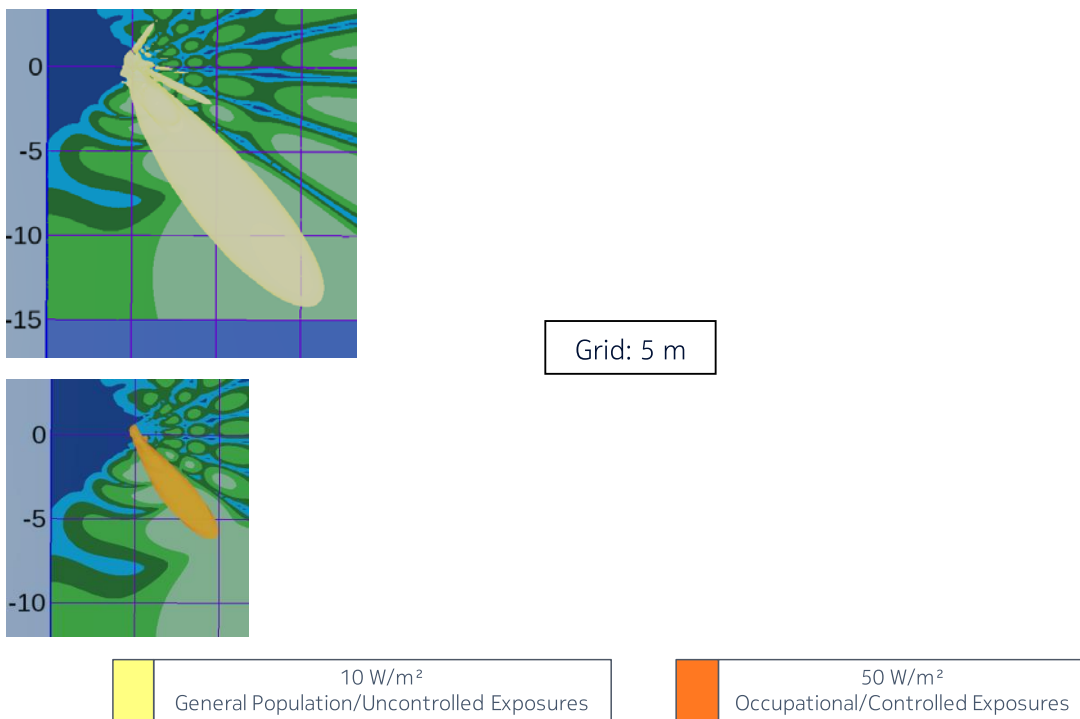

Figure 6 – Top view of the power density for the time-averaged maximum transmitted power of 339 W and the beam oriented in azimuth =  $-51^\circ$  & elevation =  $+4^\circ$  (EU/ICNIRP, Australia/NZ and US/related)

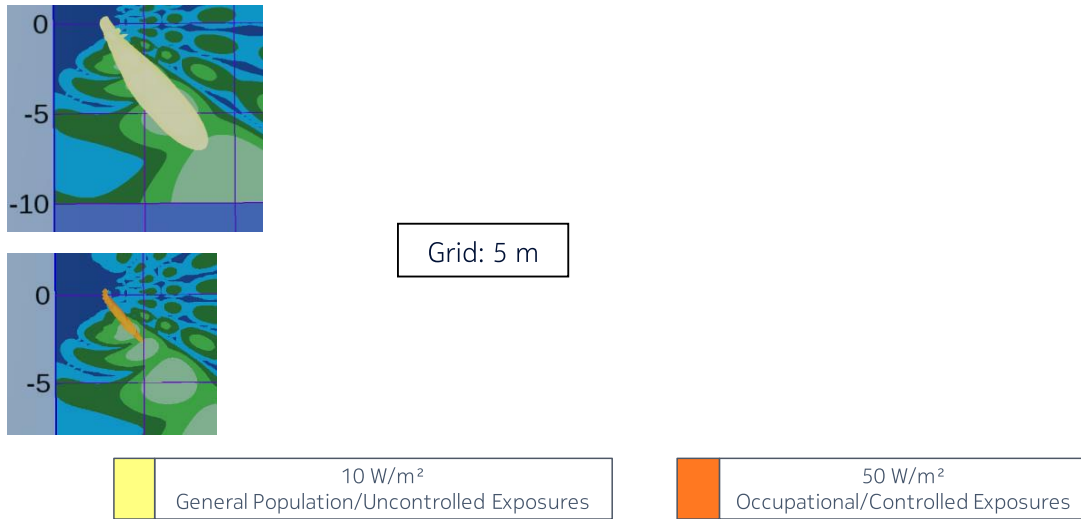

Figure 7 – Top view of the power density for the time-averaged actual maximum transmitted power of 85 W and the beam oriented in azimuth =  $-51^\circ$  & elevation =  $+4^\circ$  (EU/ICNIRP, Australia/NZ and US/related)

## 6.2 Regions of application: Canada

The computed power density distributions are displayed in Figure 8 to Figure 13 for RF exposure limits defined in [7] for Canada.

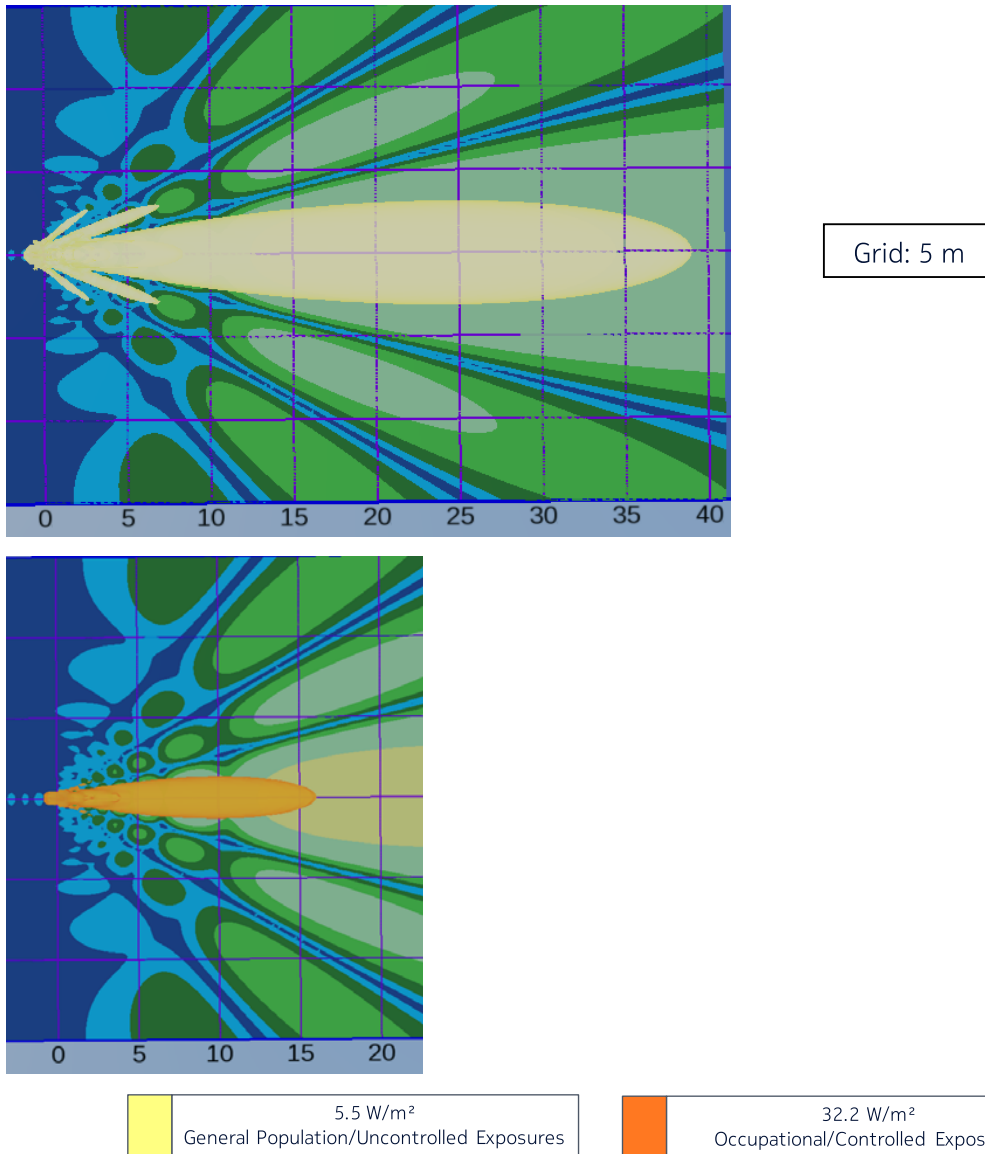
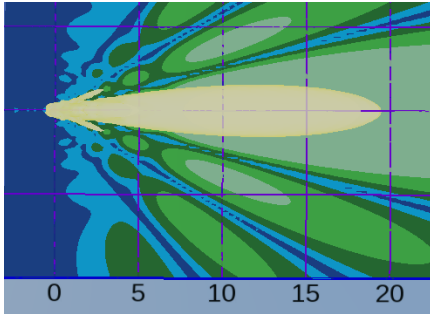

Figure 8 – Top view of the power density for the time-averaged maximum transmitted power of 339 W and the beam oriented in azimuth = 0° & elevation = +6° (Canada)



Grid: 5 m

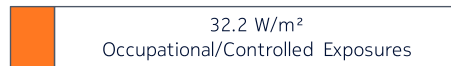
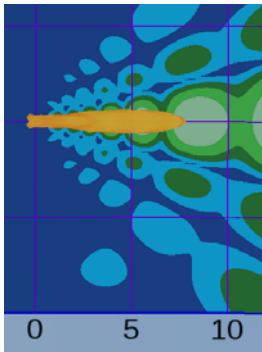
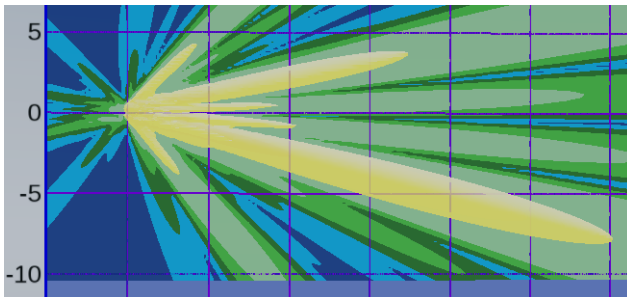

Figure 9 – Top view of the power density for the time-averaged actual maximum transmitted power of 85 W and the beam oriented in azimuth = 0° & elevation = +6° (Canada)



Grid: 5 m

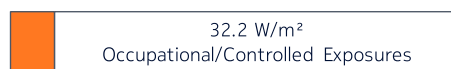
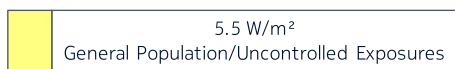
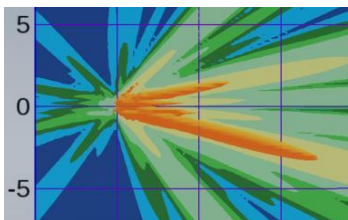

Figure 10 – Side view of the power density for the time-averaged maximum transmitted power of 339 W and the beam oriented in azimuth = -5° & elevation = +15° (Canada)

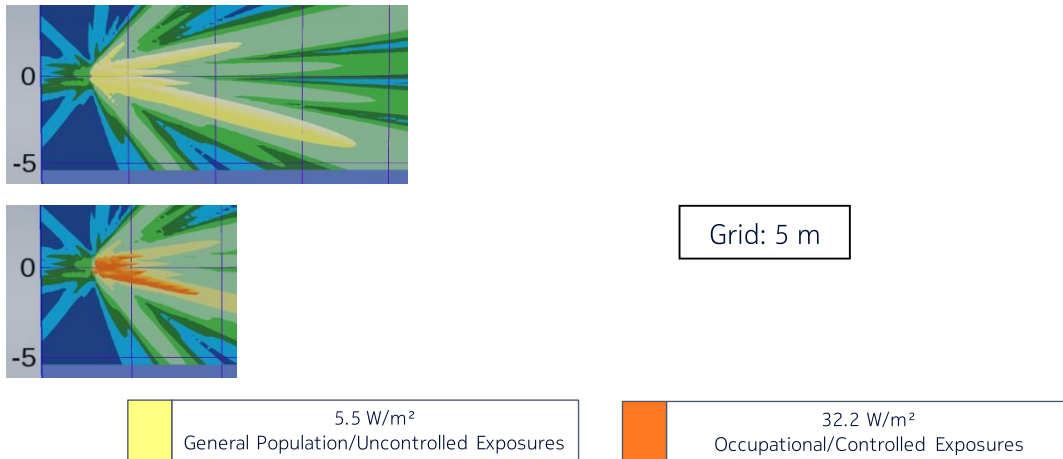

Figure 11 – Side view of the power density for the time-averaged actual maximum transmitted power of 85 W and the beam oriented in azimuth =  $-5^\circ$  & elevation =  $+15^\circ$  (Canada)

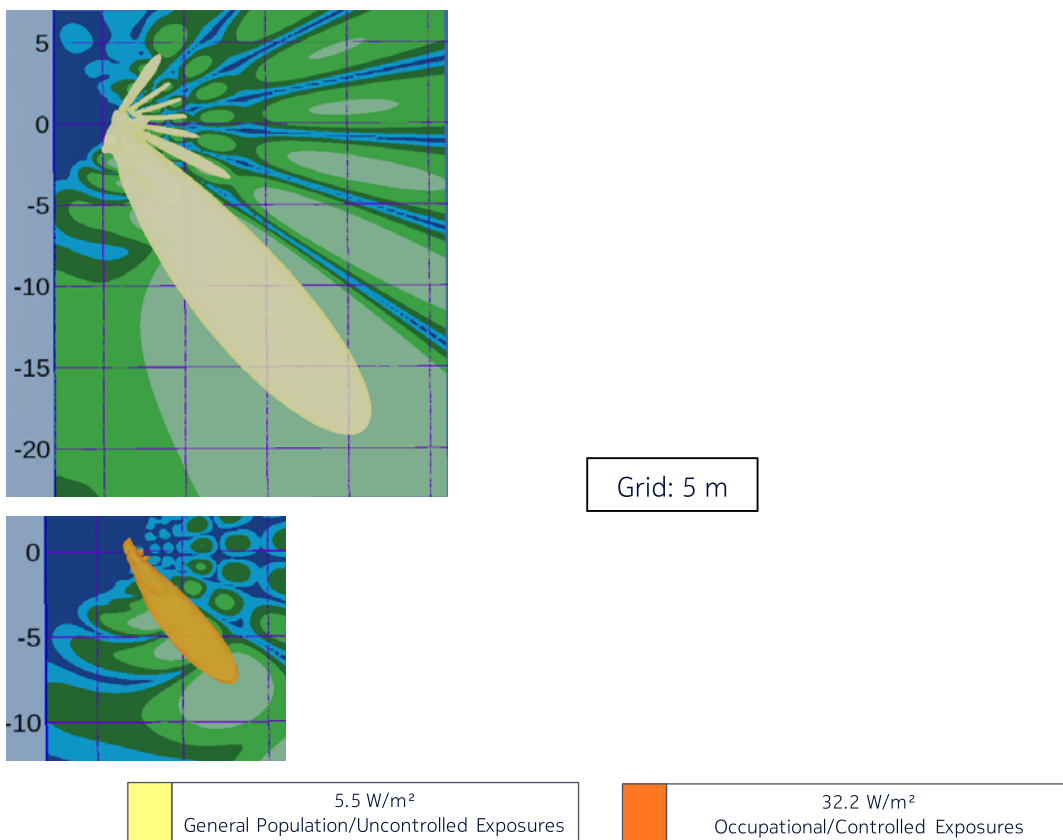

Figure 12 – Top view of the power density for the time-averaged maximum transmitted power of 339 W and the beam oriented in azimuth =  $-51^\circ$  & elevation =  $+4^\circ$  (Canada)

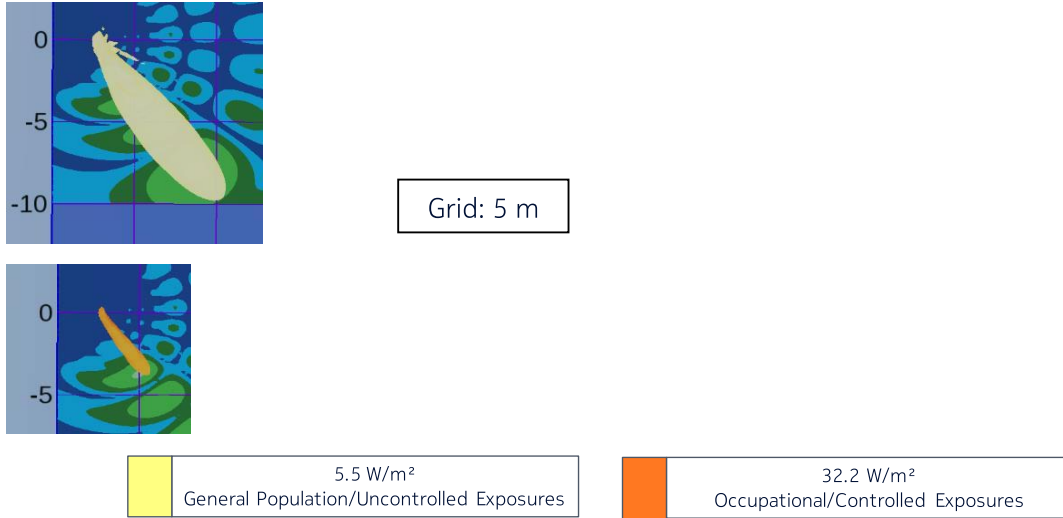

Figure 13 – Top view of the power density for the time-averaged actual maximum transmitted power of 85 W and the beam oriented in azimuth = -51° & elevation = +4° (Canada)

## 7 Conclusion and installation recommendations

The RF exposure compliance distances for the Nokia AEHB AirScale MAA 64T64R 192AE B41 320W and Nokia AEHC AirScale MAA 64T64R 192AE B41 320W products are summarized in Table 9 for EU/ICNIRP [1][2], Australia/NZ [5] and US/related [9] requirements and in Table 10 for Canada [7] requirements.

Table 9 – AEHB/AEHC RF exposure compliance distances based on the time-averaged maximum transmitted power of 339 W (corresponding to 320 W rated max transmitted power) for EU/ICNIRP, Australia/NZ and US/related

Region of application: EU/ICNIRP, Australia/NZ and US/related	General Population/Uncontrolled Exposures	Occupational/Controlled Exposures
RF-EMF power density exposure limits	10 W/m <sup>2</sup>	50 W/m <sup>2</sup>
Distance in front (Df)	29.0 m	13.0 m
Distance to the side (Ds)	14.3 m	6.3 m
Distance below and above (Da,d and Da,u)	5.6 m	2.1 m
Distance to the side (Dsc)	14.5 m	6.5 m
Distance below and above (Ddc and Duc)	6.0 m	2.5 m

Table 10 - AEHB/AEHC RF exposure compliance distances based on the time-averaged maximum transmitted power of 339 W (corresponding to 320 W rated max transmitted power) for Canada

Region of application: Canada	General Population/Uncontrolled Exposures	Occupational/Controlled Exposures
RF-EMF power density exposure limits	5.5 W/m <sup>2</sup>	32.2 W/m <sup>2</sup>
Distance in front (Df)	39.0 m	16.0 m
Distance to the side (Ds)	19.3 m	7.8 m
Distance below and above (Da,d and Da,u)	8.1 m	3.1 m
Distance to the side (Dsc)	19.5 m	8.0 m
Distance below and above (Ddc and Duc)	8.5 m	3.5 m

The RF exposure compliance distances based on the actual maximum transmitted power considering a 95<sup>th</sup> percentile approach are summarized in Table 11 and Table 12. These values are provided for information about the RF exposure levels that may be reached in operational conditions considering a time-averaging window of 6 minutes according to [4], [14] and [15].

Table 11 – AEHB/AEHC RF exposure compliance distances based on the time-averaged actual maximum transmitted power of 85 W (corresponding to 320 W rated max transmitted power) for EU/ICNIRP, Australia/NZ and US/related

For information in EU/ICNIRP, Australia/NZ and US/related countries based on IEC/EN 62232:2017 [4] and IEC TR62669 [15]	General Population/Uncontrolled Exposures	Occupational/Controlled Exposures
RF-EMF power density exposure limits	10 W/m <sup>2</sup>	50 W/m <sup>2</sup>
Distance in front (Df)	14.5 m	6.5 m
Distance to the side (Ds)	6.8 m	2.8 m
Distance below and above (Da,d and Da,u)	2.6 m	1.1 m
Distance to the side (Dsc)	7.0 m	3.0 m
Distance below and above (Ddc and Duc)	3.0 m	1.5 m

Table 12 – AEHB/AEHC RF exposure compliance distances based on the time-averaged actual maximum transmitted power of 85 W (corresponding to 320 W rated max transmitted power) for Canada

For information in Canada based on IEC/EN 62232:2017 [4] and IEC TR62669 [15]	General Population/Uncontrolled Exposures	Occupational/Controlled Exposures
RF-EMF power density exposure limits	5.5 W/m <sup>2</sup>	32.2 W/m <sup>2</sup>
Distance in front (Df)	19.5 m	8.0 m
Distance to the side (Ds)	9.8 m	3.8 m
Distance below and above (Da,d and Da,u)	3.6 m	1.1 m
Distance to the side (Dsc)	10.0 m	4.0 m
Distance below and above (Ddc and Duc)	4.0 m	1.5 m

Installation of the Nokia AEHB AirScale MAA 64T64R 192AE B41 320W and Nokia AEHC AirScale MAA 64T64R 192AE B41 320W products shall be performed in accordance with all applicable manufacturer's recommendations and national laws and regulations related to human exposure to radiofrequency fields. In particular:

- The operator or entity putting the equipment into service shall take the necessary measures to ensure that the general population cannot access the area within the general population/uncontrolled compliance boundary in the vicinity of the transmitting antennas (see Table 9 and Table 10).
- Depending on the site installation configuration, the operator or the entity putting the equipment into service determines the most suitable place to display the appropriate warning signs and any other necessary information or precautionary measures.
- Workers that are required to operate in the close proximity of the transmitting antennas connected to the equipment, for example installation and maintenance personnel, need to be informed about the potential risks of human exposure to RF fields and how to protect against them. They should strictly follow instructions provided by their employer. They should stand-off the occupational/controlled exposure compliance boundary defined in the vicinity of transmitting antennas (see Table 9 and Table 10). If it is necessary to operate within this compliance boundary, workers shall make sure that the transmitters contributing to exposure in this area are all switched off, or they must contact the relevant operator(s) to switch off emissions during operation period.

----- end of the test report -----