

Global Product Compliance Laboratory  
600-700 Mountain Avenue  
Room 5B-108  
Murray Hill, New Jersey 07974-0636 USA



**TESTING**  
NVLAP LAB CODE: 100275-0

## **RF Transmitter Certification Test Report (FCC ID: VBNA AHE-01)**

**Regulation:**

FCC Part 2 and 27

**Client:**

Nokia Mobility

**Product Evaluated:**

AirScale MAA 64T64R 128AE B41 120W AAHE mMIMO Full Band

**Report Number:**

TR-2018-0080-AAHE-FCC2-27

**Date Issued:**

July 16, 2018

This report shall not be reproduced, in whole or in part without the approval of Nokia Global Product Compliance Laboratory. This report must not be used by the recipient to claim product endorsement by NVLAP or any other agency of the U.S. Government.

# Table of Contents

<b>1. SYSTEM INFORMATION AND REQUIREMENTS .....</b>	<b>5</b>
1.1 INTRODUCTION .....	6
1.2 PURPOSE AND SCOPE.....	6
1.3 EUT DESCRIPTION.....	6
1.3.1 Test Requirements.....	6
1.4 REFERENCE DOCUMENTS, TEST SPECIFICATIONS & PROCEDURES.....	7
1.4.1 Test Specifications.....	7
1.4.2 Procedures .....	7
1.4.3 MEASUREMENT UNCERTAINTY .....	7
1.5 EXECUTIVE SUMMARY .....	8
<b>2. FCC SECTION 2.1046 - RF POWER OUTPUT .....</b>	<b>9</b>
2.1 RF POWER OUTPUT REQUIREMENTS.....	9
2.2 RF POWER OUTPUT MEASUREMENT .....	9
2.2.1 RF Antenna Port Measurement Setup.....	10
2.3 RF POWER DATA .....	11
2.3.1 RF Channel Power - Single Carrier (1C).....	11
2.3.2 RF Channel Power - Dual Carrier (2C).....	12
2.3.3 RF Channel Power - Triple Carrier (3C).....	13
2.4 PEAK-TO-AVERAGE POWER RATIO (PAPR) 47CFR 27.50 .....	14
2.4.1 PAPR - Single Carrier (1C) .....	14
2.4.2 PAPR - Dual Carrier (2C).....	17
2.4.3 PAPR - Triple Carrier (3C).....	20
<b>3. FCC SECTION 2.1047 - MODULATION CHARACTERISTICS .....</b>	<b>22</b>
3.1 MODULATION CHARACTERISTICS.....	22
3.1.1 Modulation - Single Carrier (1C) .....	22
3.1.2 Modulation - Dual Carrier (2C).....	25
3.1.3 Modulation - Triple Carrier (3C).....	27
<b>4. FCC SECTION 2.1049 – OCCUPIED BANDWIDTH.....</b>	<b>29</b>
4.1 OCCUPIED BANDWIDTH –(SIGNAL BANDWIDTH OBW - Si) .....	29
4.1.1 Signal Bandwidth OBW - Single Carrier (1C).....	30
4.1.2 Signal Bandwidth OBW - Dual Carrier (2C) .....	34
4.1.3 Signal Bandwidth OBW - Triple Carrier (3C).....	37
4.2 OCCUPIED BANDWIDTH/ EDGE OF BAND EMISSIONS (OBW-EDGE OF BAND).....	38
4.2.1 OBW-Edge of Band - Single Carrier (1C) .....	39
4.2.2 OBW-Edge of Band - Dual Carrier (2C).....	43
4.2.3 OBW-Edge of Band - Triple Carrier (3C).....	45
<b>5. FCC SECTION 2.1051 - SPURIOUS EMISSIONS AT TRANSMIT ANTENNA PORT.....</b>	<b>46</b>
5.1 MEASUREMENT OF SPURIOUS EMISSIONS AT TRANSMIT ANTENNA PORT .....	46
5.1.1 Antenna Port Spurious Emissions - Single Carrier (1C).....	47
5.1.2 Antenna Port Spurious Emissions - Dual Carrier (2C).....	49
5.1.3 Antenna Port Spurious Emissions - Triple Carrier (3C).....	52

- 6. FCC SECTION 2.1053 AND PART 15.109 ..... 53**
  - 6.1 SECTION 2.1053 FIELD STRENGTH OF SPURIOUS EMISSIONS ..... 53
  - 6.2 FIELD STRENGTH OF SPURIOUS EMISSIONS RESULTS:..... 53
- 7. FCC SECTION 2.1055 FREQUENCY STABILITY ..... 61**
  - 7.1 SECTION 2.1055 MEASUREMENT OF FREQUENCY STABILITY..... 61
    - 7.1.1 *Frequency Stability Test Article and Configuration*..... 61
    - 7.1.2 *Frequency Stability Test*..... 61
    - 7.1.3 *Frequency Stability Test process*..... 62
    - 7.1.4 *Frequency Stability Results:* ..... 62
    - 7.1.5 *Frequency Stability Data:*..... 62
- 8. TEST EQUIPMENT AND TEST SET-UP PHOTOGRAPHS..... 70**
  - 8.1 TEST SET-UP PHOTOGRAPHS ..... 70
  - 8.2 ANTENNA PORT TEST EQUIPMENT ..... 70
  - 8.3 RADIATED EMISSIONS TEST EQUIPMENT ..... 70
  - 8.4 FREQUENCY STABILITY TEST EQUIPMENT..... 71
- 9. NVLAP CERTIFICATE OF ACCREDITATION ..... 72**

**Revisions**

Date	Revision	Section	Change
07/06/2018	Initial		
07/16/2018	1	All	All except data plots.

*Nokia Global Product Compliance Laboratory represents to the client that testing was done in accordance with standard procedures as applicable, and that reported test results are accurate within generally accepted commercial ranges of accuracy in accordance with the scope of our NVLAP Accreditation. Nokia Global Product Compliance reports only apply to the specific samples tested. This report is the property of the client. This report shall not be reproduced except in full without the written approval of the Nokia Global Product Compliance Laboratory.*

*Nokia Global Product Compliance Laboratory is accredited with the US Department of Commerce National Institute of Standards and Technology's National Voluntary Laboratory Accreditation Program (NVLAP) for satisfactory compliance with criteria established in Title 15, Part 7 Code of Federal Regulations for offering test services for selected test methods in Electromagnetic Compatibility; Voluntary Control Council for Interference (VCCI), Japan; Australian Communications and Media Authority (ACMA). The laboratory is ISO 9001:2008 Certified.*

*Nokia Global Product Compliance Laboratory represents to the client that the laboratory's accreditation or any of its calibration or test reports in no way constitutes or implies product certification, approval, or endorsement by NVLAP, NIST, or any agency of the federal government.*

Prepared By:

Approved By:

Signed:  7/19/2018  
 Nilesh Patel Compliance Engineer

Signed:  7/19/2018  
 Technical Manager

Reviewed By:

Signed:  7/19/2018  
 Walter Steve Majkowski Compliance Engineer

## 1. System Information and Requirements

<b>Equipment Under Test (EUT):</b>	AirScale MAA 64T64R 128AE B41 120W AAHE
<b>Serial Number:</b>	(1P)- 474658A.101 (S) – 6Q181121986
<b>FCC ID:</b>	<b>VBNA AHE-01</b>
<b>Cell Name / Number</b>	GPCL Project Number:2018-0080
<b>Company:</b>	NOKIA SOLUTIONS AND NETWORKS 6000 Connection Drive Irving, TX 75039 USA
<b>Manufacturer:</b>	NOKIA SOLUTIONS AND NETWORKS
<b>Test Requirement(s):</b>	47 CFR FCC Part 2 and Part 27
<b>Measurement Procedure(s):</b>	ANSI C63.26-2015 FCC KDB 971168 D01, v03r01, April 2018 FCC KDB 662911 D01, v02r01, October 2013
<b>Frequency Band</b>	2630 – 2690 MHz
<b>Nominal Total Transmit Power</b>	120W for all ports
<b>Maximum Antenna Gain</b>	23.4 dBi
<b>Minimum Antenna Beamwidth</b>	9.2 degrees vertical, 12.7 degrees horizontal
<b>Test Date(s):</b>	May/June 2018
<b>Test Performed By:</b>	Nokia Global Product Compliance Laboratory 600-700 Mountain Ave. P.O. Box 636 Murray Hill, NJ 07974-0636 FCC Registration No/Designation No: 328881/US5302
<p>Nokia Global Product Compliance Laboratories is accredited by the National Voluntary Laboratory Accreditation Program (NVLAP®) for specific services, listed on the Scope of Accreditation, for: Electromagnetic Compatibility and Telecommunications. This laboratory is accredited in accordance with the recognized International Standard ISO/IEC 17025:2005. This accreditation demonstrates technical competence for a defined scope and the operation of a laboratory quality management system (refer to joint ISO-ILAC-IAF Communiqué dated January 2009). <b>NVLAP LAB CODE:</b> 100275-0.</p>	
<b>Product Engineer(s):</b>	Ron Remy
<b>Lead Engineer</b>	Steve Majkowski
<b>Test Engineer (s):</b>	Jaideep Yadav, Eugene Mitchell, Mike Soli
<p><b>Test Results:</b> The AAHE mMIMO - Full Band, <i>as tested</i> met the above listed requirements. Report copies and other information not contained in this report are held by either the product engineer or in an identified file at the Global Product Compliance Laboratory in New Providence, NJ.</p>	

### FCC Section 2.911(e) Certification of Technical Test Data

The technical test data presented in this report are accurate.

## 1.1 Introduction

This Conformity Assessment Report applies to the AAHE mMIMO – for the 2630-2690 MHz Band, hereinafter referred to as the Equipment Under Test (EUT).

## 1.2 Purpose and Scope

The purpose of this document is to provide the testing data required for qualifying the EUT in compliance with FCC Parts 2 and 27, measured in accordance with the procedures set out in Section 2.1033 (c) (14) of the Rules.

## 1.3 EUT Description

Nokia AirScale massive MIMO Adaptive Antenna deploys 64 transmit and 64 receive streams and 16-layer Massive MIMO. It incorporates Carrier Aggregation with broad range of customized variants to deliver up to five times more network capacity, high peak downlink throughput, significantly improved uplink, and greater coverage.

The use of Massive MIMO also enhances conventional beamforming, giving wider coverage and better indoor penetration.

With Massive MIMO, operators now have a powerful new tool to boost capacity using their existing spectrum.

### 1.3.1 Test Requirements

Each required measurement is listed below:

47 CFR FCC Sections	Description of Tests	Test Required
2.1046	RF Power Output	Yes
2.1047	Modulation Characteristics	Yes
2.1049	(a) Occupied Bandwidth	Yes
27.53(m)	(b) Out-of-Band Emissions	Yes
2.1051	Spurious Emissions at Antenna Terminals	Yes
27.53(m)		
2.1053	Field Strength of Spurious Radiation	Yes
27.53(m)		
2.1055	Measurement of Frequency Stability	Yes
27.54		

## 1.4 Reference Documents, Test Specifications & Procedures

A list of the applicable documents is provided herein.

### 1.4.1 Test Specifications

- Title 47 Code of Federal Regulations, Federal Communications Commission Part 2.
- Title 47 Code of Federal Regulations, Federal Communications Commission Part 27.

### 1.4.2 Procedures

1. FCC-IC-0B and FCC-IC-SE
2. ANSI C63.4 (2014), American National Standard for Methods of Measurement of Radio-Noise Emissions from Low Voltage Electrical and Electronic Equipment in the Range of 9kHz to 40 GHz.
3. ANSI C63.26-2015, American Nation Standard for Compliance Testing of Transmitters Used in Licensed Radio Services.
4. FCC KDB 971168 D01, Measurement Guidance for Certification of Licensed Digital Transmitters, April 2018, v03r01.
5. FCC KDB 662911D01, Emissions Testing of Transmitters with Multiple Outputs in the Same Band, October 2013, v02r01.

### 1.4.3 MEASUREMENT UNCERTAINTY

The results of the calculations to estimate uncertainties for the several test methods and standards are shown in the Table below. These are the worst-case values.

**Worst-Case Estimated Measurement Uncertainties**

Standard, Method or Procedure	Condition	Frequency MHz	Expanded Uncertainty (k=2)
a. Classical Emissions, (e.g., ANSI C63.4, CISPR 11, 14, 22, etc., using ESHS 30,	Conducted Emissions	0.009 - 30	±3.5 dB
	Radiated Emissions (AR-8 Semi-Anechoic Chamber)	30 MHz – 200MHz	±5.4 dB
		200 MHz – 1000 MHz	±4.7 dB
		1 GHz - 18 GHz	±3.3 dB

Antenna Port Test	Expanded Uncertainty (k=2), Amplitude
RF Power	± 1.4 dB
Occupied Bandwidth	± 2.2 dB
Conducted Spurious Emissions	± 2.8 dB

## 1.5 Executive Summary

Requirement	Description	Result
<b>47 CFR FCC Parts 2 and 27</b>		
2.1046 27.50(h), (i)	RF Power Output Peak to Average Power Ratio	COMPLIES
2.1047	Modulation Characteristics	COMPLIES
2.1049	Occupied Bandwidth (a) Emissions Signal Bandwidth (b) Occupied Bandwidth/ Edge of Band Emissions	COMPLIES
2.1051	Spurious Emissions at Antenna Terminals	COMPLIES
2.1053	Field Strength of Spurious Radiation	COMPLIES
2.1055	Measurement of Frequency Stability	COMPLIES

1. **COMPLIES** - Passed all applicable tests.
2. **N/A** – Not Applicable.
3. **NT** – Not Tested.



## 2. FCC Section 2.1046 - RF Power Output

### 2.1 RF Power Output Requirements

Per 47CFR 27.50(h)... The following power limits shall apply in the BRS and EBS:

(1) *Main, booster and base stations.* (i) The maximum EIRP of a main, booster or base station shall not exceed 33 dBW + 10log(X/Y) dBW, where X is the actual channel width in MHz and Y is either 6 MHz if prior to transition or the station is in the MBS following transition or 5.5 MHz if the station is in the LBS and UBS following transition, except as provided in paragraph (h)(1)(ii) of this section.

(ii) If a main or booster station sectorizes or otherwise uses one or more transmitting antennas with a non-omnidirectional horizontal plane radiation pattern, the maximum EIRP in dBW in a given direction shall be determined by the following formula:  $EIRP = 33 \text{ dBW} + 10 \log(X/Y) \text{ dBW} + 10 \log(360/\text{beamwidth}) \text{ dBW}$ , where X is the actual channel width in MHz, Y is either (i) 6 MHz if prior to transition or the station is in the MBS following transition or (ii) 5.5 MHz if the station is in the LBS and UBS following transition, and beamwidth is the total horizontal plane beamwidth of the individual transmitting antenna for the station or any sector measured at the half-power points.

The required Total Transmit Port power limits are derived from the EIRP Limits as follows:

From 27.50(h)(ii) ... and given a minimum beamwidth of 9.2 degrees and an antenna gain of 23.4 dBi:

$$EIRP \text{ Limit} = 33 \text{ dBW} + 10 \text{ LOG} (20/6) \text{ dBW} + 10 \text{ LOG} (360/9.2) \text{ dBW}$$

$$EIRP \text{ Limit} = 33 + 5.23 + 15.93 = 54.15 \text{ dBW EIRP}$$

therefore:

$$54.15 \text{ dBW EIRP} - 23.4 \text{ dBi antenna gain} = 30.75 \text{ dBW} = \text{Total Power limit at Antenna Port} = 1188 \text{ Watts}$$

The maximum power output is rated at 120W so the product clearly meets this criteria.

### 2.2 RF Power Output Measurement

This test is a measurement of the total RF power level transmitted at the antenna-transmitting terminal (J4), as shown in the accompanying test set-up diagram in paragraph 2.2.1.

Before the testing was started, the Base Station was given a sufficient “warm-up” period as required.

Power measurements were made using the Channel Power measurement feature of the Keysight MXA Signal Analyzer. Corrections for path loss were applied by using the worst case path attenuation for the frequency range of interest. These values were applied and are offset on the display. All parameters were adjusted based upon the designated signal bandwidth and measurement resolution bandwidth per transmit signal.

Power was measured on every port for all carrier configurations to determine the maximum power output.

NOTE: Only a sample of all the data taken has been used in this report. The full suite of raw data resides at the MH, New Jersey location.

### 2.2.1 RF Antenna Port Measurement Setup

The Test Setup depicted in the diagram below was used for the Measurement of RF Power, Modulation, PAR, Occupied Bandwidth, Edge of Band and Conducted Spurious Emissions

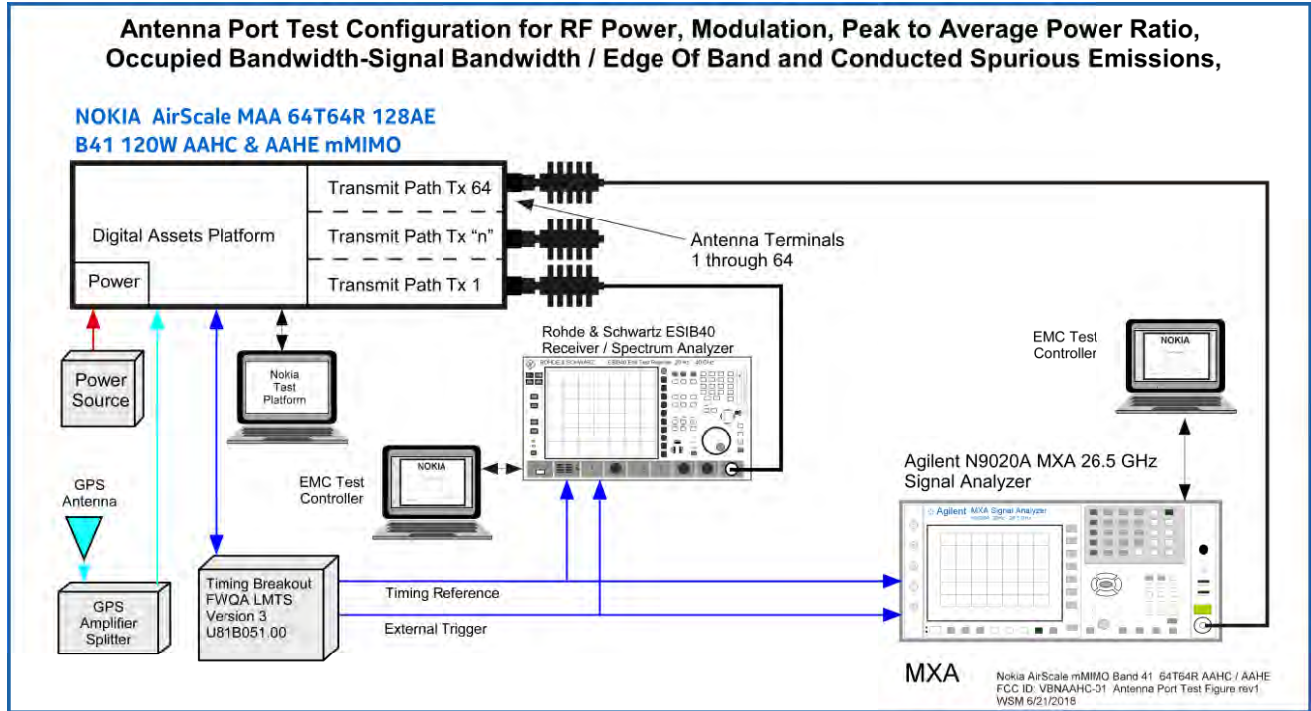

### 2.3 RF Power Data

RF Channel Power was measured for the Single, Dual and Three Carrier configurations.

#### 2.3.1 RF Channel Power - Single Carrier (1C)

Ch Power, AAHE mMIMO - B41, 1C, 28dBm, 20MBW, TM3.1A, 2640 MHz.

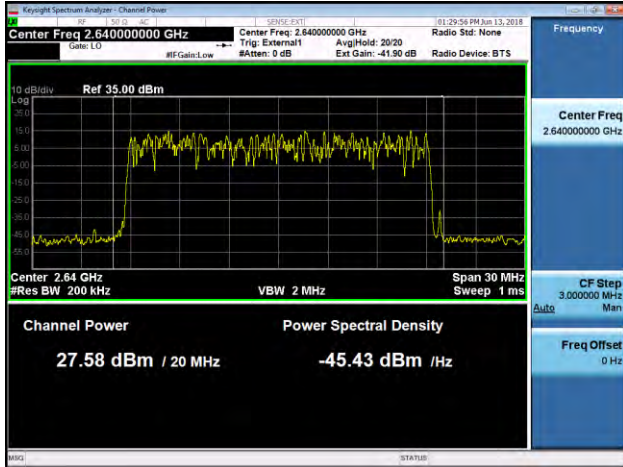

Ch Power, AAHE mMIMO - B41, 1C, 28dBm, 20MBW, TM3.2, 2660 MHz.

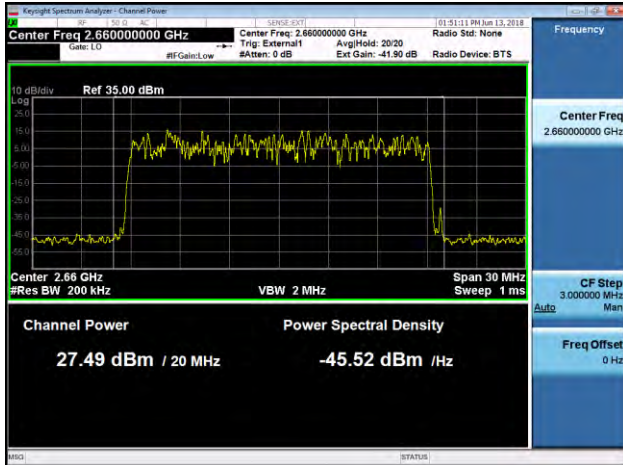

Ch Power, AAHE mMIMO - B41, 1C, 28dBm, 20MBW, TM3.1, 2680 MHz.

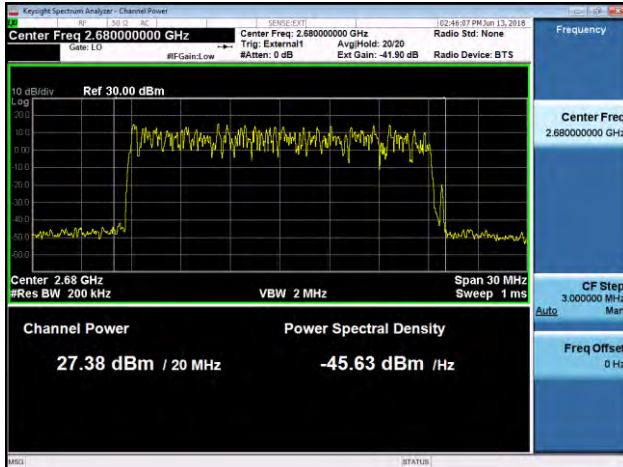

### 2.3.2 RF Channel Power - Dual Carrier (2C)

Ch Power, AAHE mMIMO - B41, 2C, 31dBm, 20MBW, TM3.2, 2640 and 2660 MHz.

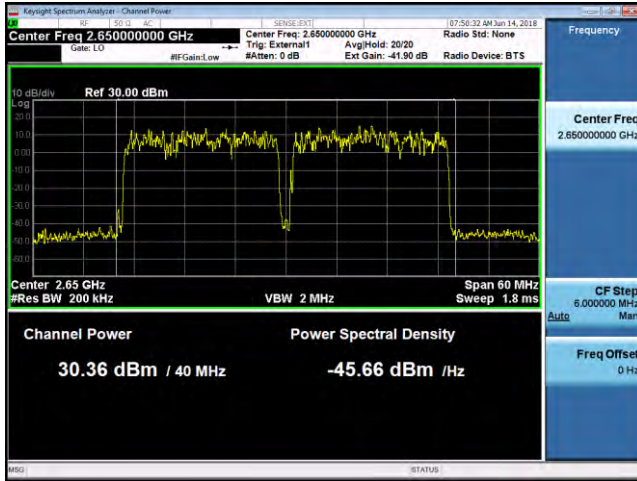

Ch Power, AAHE mMIMO - B41, 2C, 31dBm, 20MBW, TM3.2, 2660 and 2680 MHz.

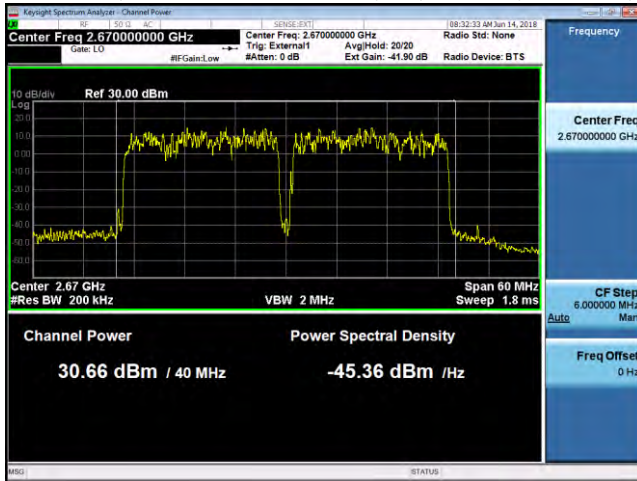

Ch Power, AAHE mMIMO - B41, 2C, 31dBm, 20MBW, TM3.2, 2640 and 2680 MHz.

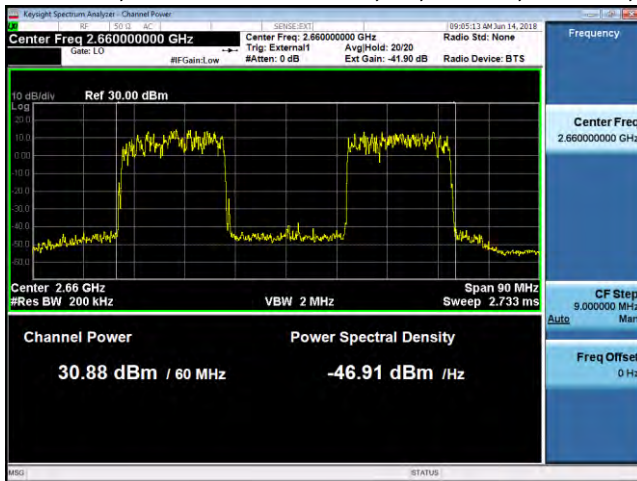

### 2.3.3 RF Channel Power - Triple Carrier (3C)

The highest power of the 64 ports measured was on port 54.

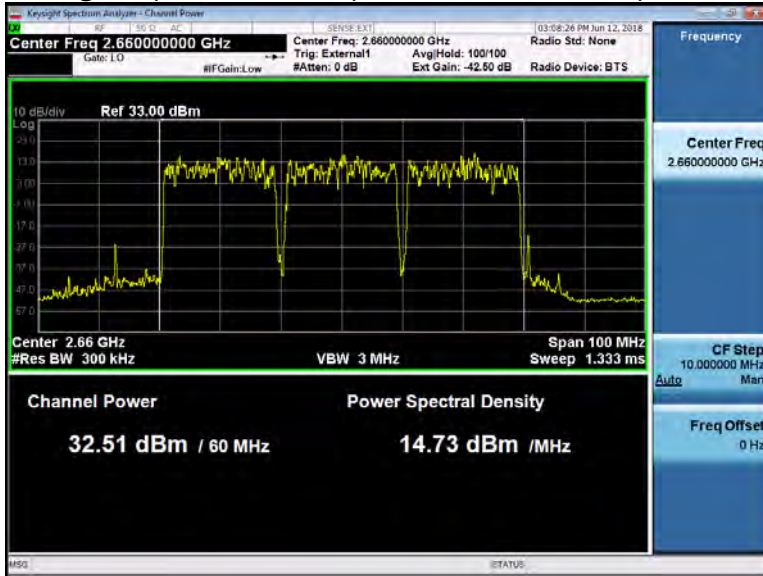

Ch Power, AAHE mMIMO - B41, 3C, 32.8dBm, 20MBW, TM3.2, 2640, 2660 and 2680 MHz.

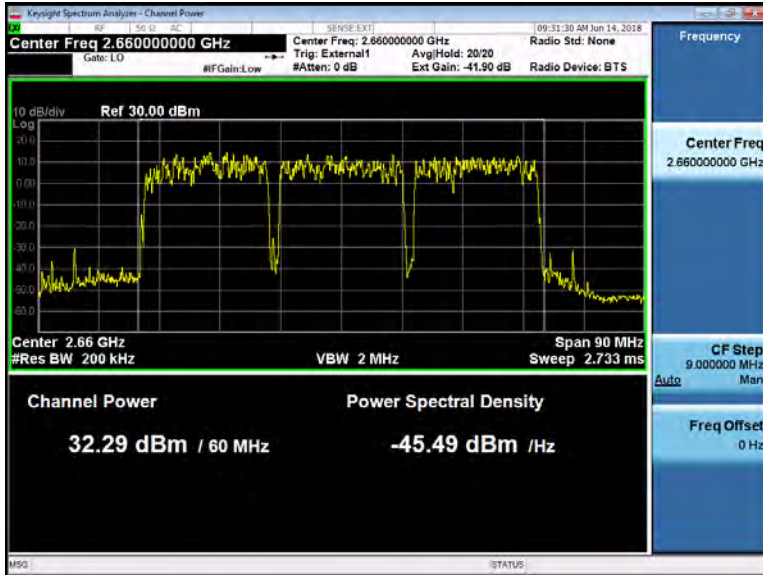



### 2.4 Peak-to-Average Power Ratio (PAPR) 47CFR 27.50

This measurement of the Peak-to-Average Power Ratio (PAPR) was performed using the Complementary Cumulative Distribution Function (CCDF) feature of a Keysight MXA Signal Analyzer. All the measured values were below the required 13dB limit at the required 0.1 percent of the time.

NOTE: Only a sample of all the data taken has been used in this report. The full suite of raw data resides at the MH, New Jersey location.

#### 2.4.1 PAPR - Single Carrier (1C)

PAR, AAHE mMIMO - B41, 1C, 28dBm, 20MBW, TM3.1A, 2640 MHz.

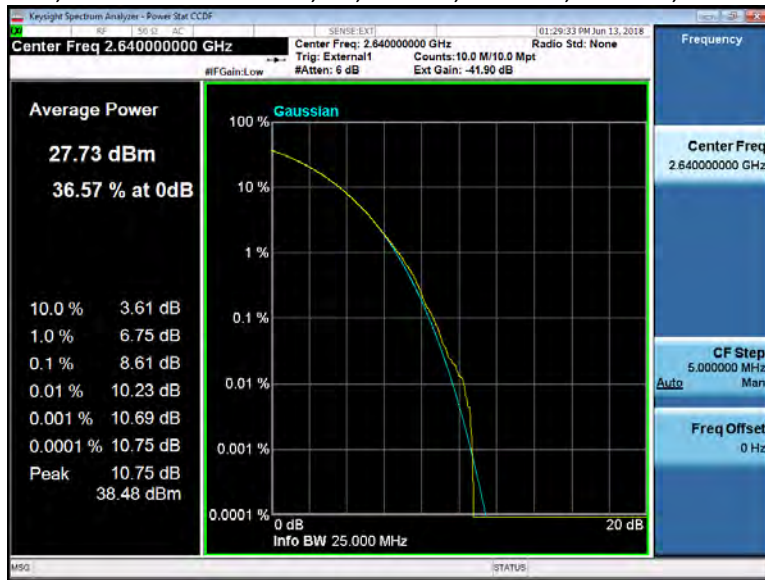

PAR, AAHE mMIMO - B41, 1C, 28dBm, 20MBW, TM3.1, 2640 MHz.

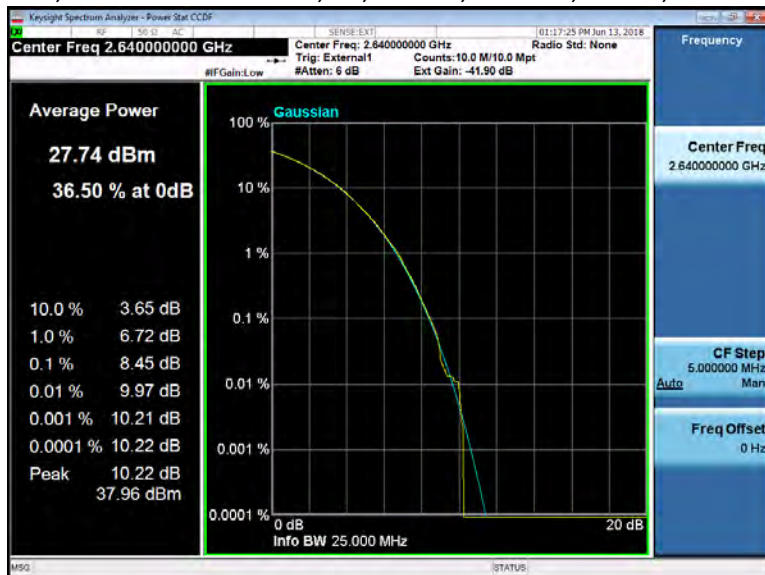

PAR, AAHE mMIMO - B41, 1C, 28dBm, 20MBW, TM3.2, 2640 MHz.

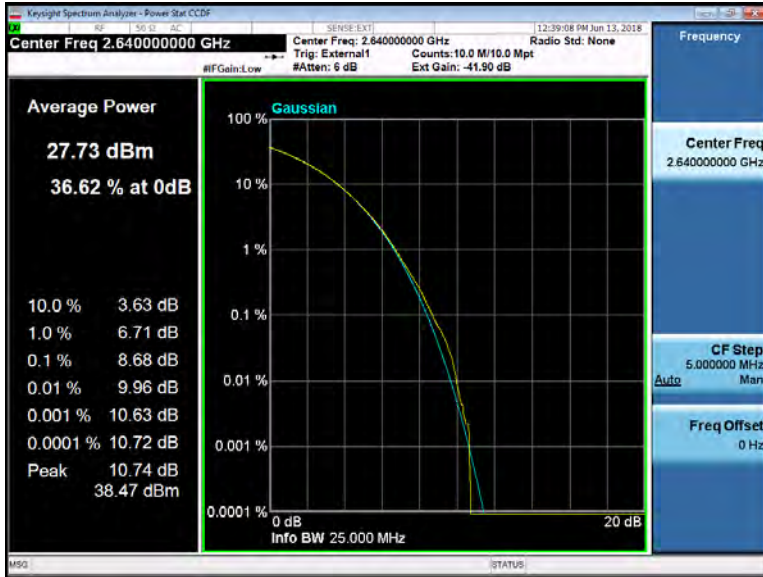

PAR, AAHE mMIMO - B41, 1C, 28dBm, 20MBW, TM3.2, 2660 MHz.

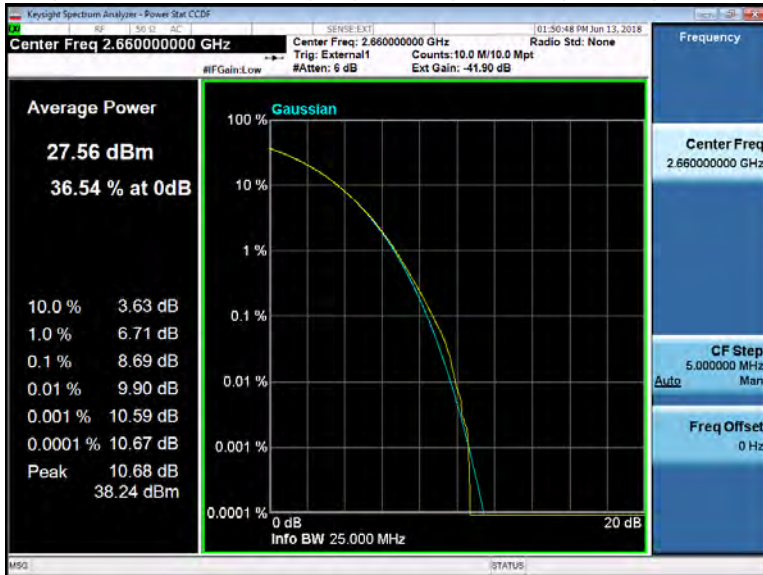

PAR, ASHC mMIMO - B41, 1C, 28dBm, 20MBW, TM3.1, 2680 MHz.

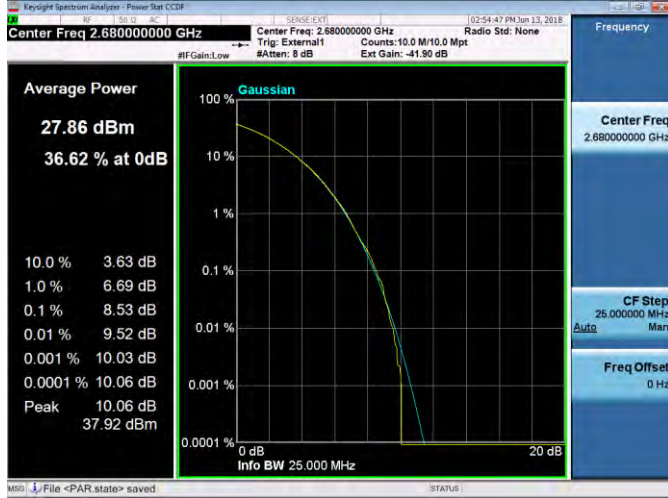

PAR, AAHE mMIMO - B41, 1C, 28dBm, 20MBW, TM3.1A, 2680 MHz.

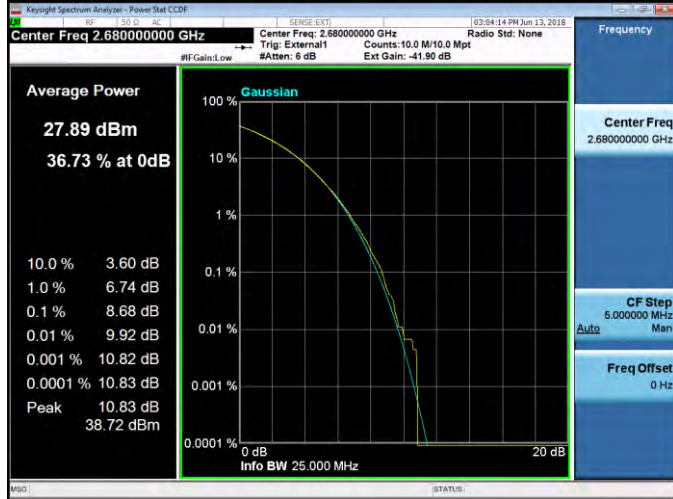

PAR, AAHE mMIMO - B41, 1C, 28dBm, 20MBW, TM3.2, 2680 MHz.

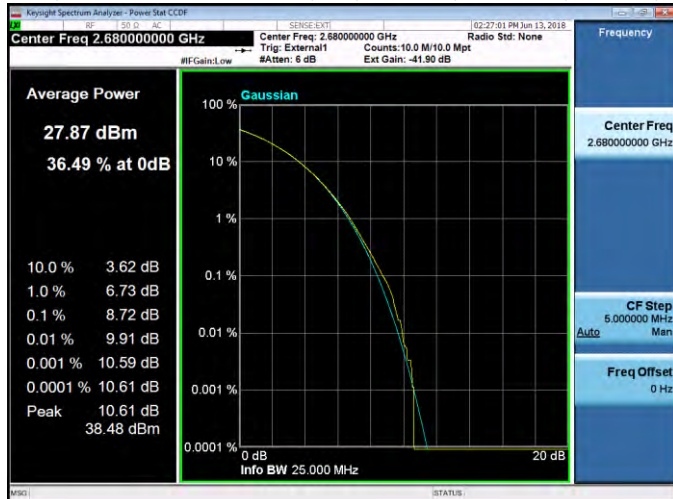



### 2.4.2 PAPR - Dual Carrier (2C)

PAR, AAHE mMIMO - B41, 2C, 31dBm, 20MBW, TM3.2, 2640 and 2660 MHz.

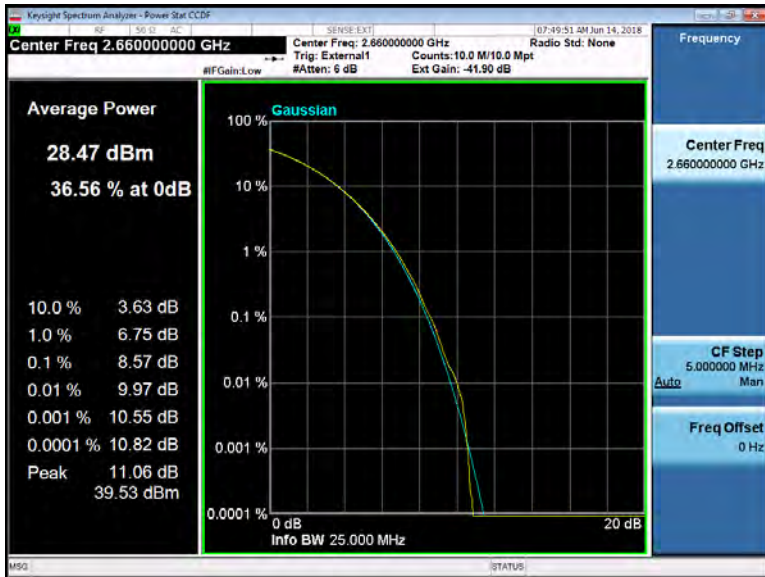
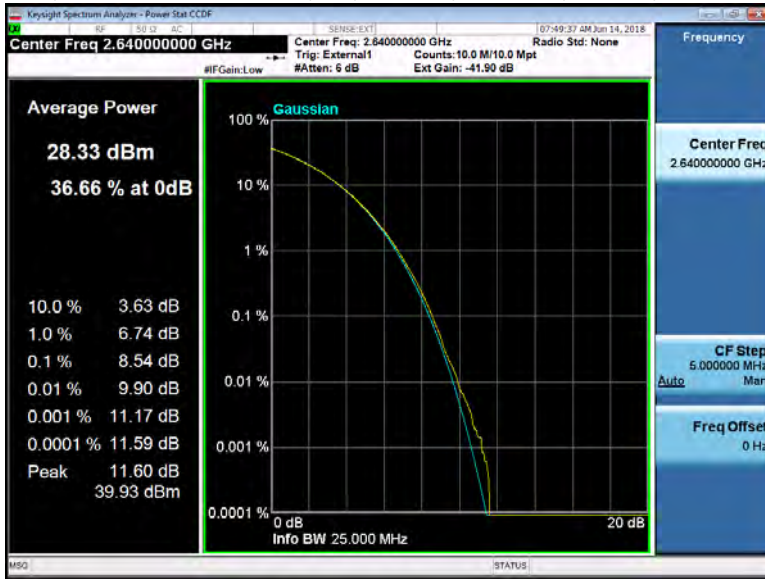

PAR, AAHE mMIMO - B41, 2C, 31dBm, 20MBW, TM3.2, 2660 and 2680 MHz.

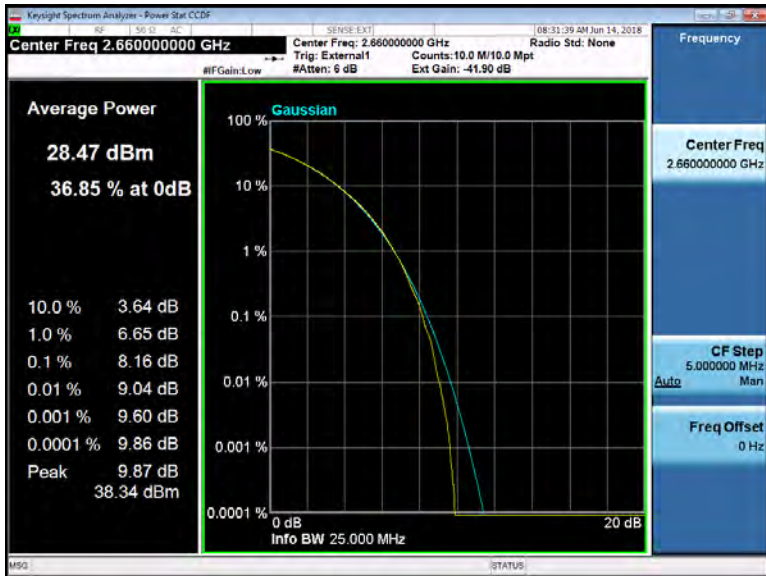
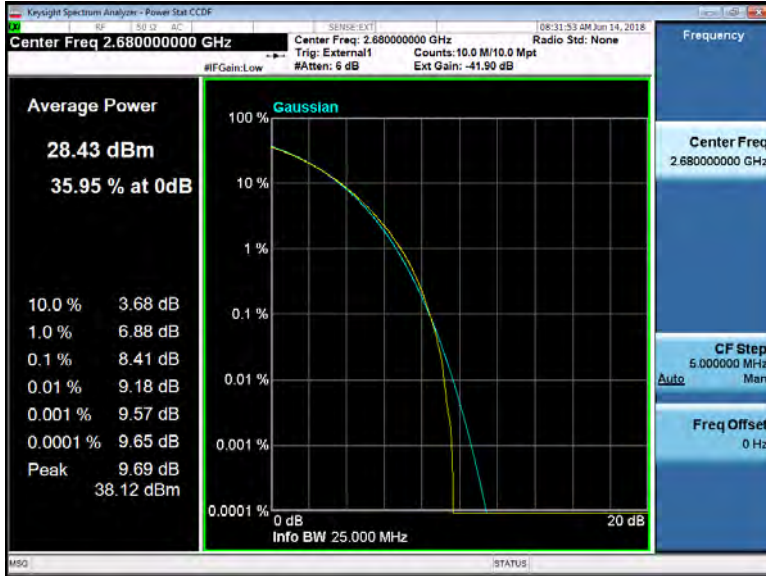

PAR, AAHE mMIMO - B41, 2C, 31dBm, 20MBW, TM3.2, 2640 and 2680 MHz.

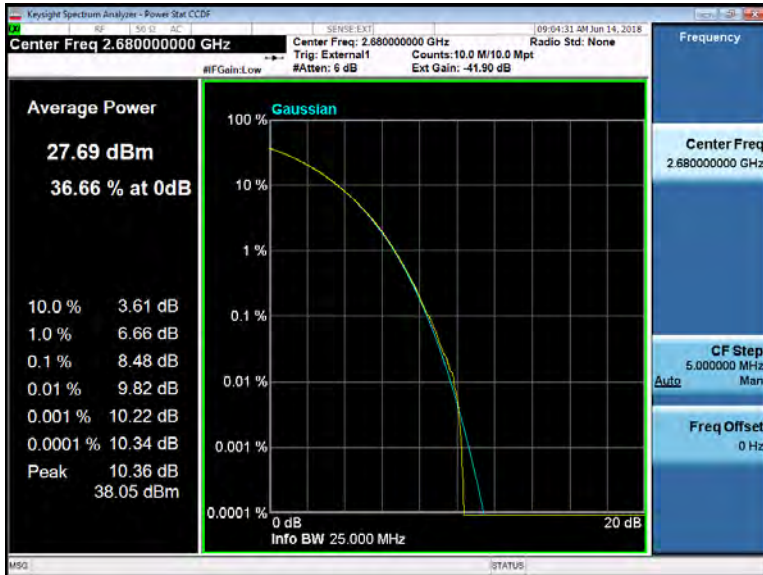
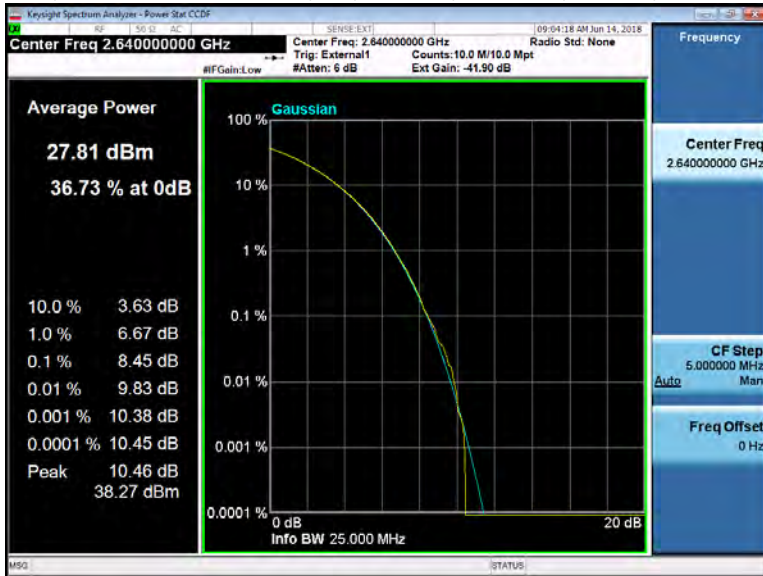

### 2.4.3 PAPR - Triple Carrier (3C)

PAR, AAHE mMIMO - B41, 3C, 32.8dBm, 20MBW, TM3.2, 2640, 2660 and 2660 MHz.

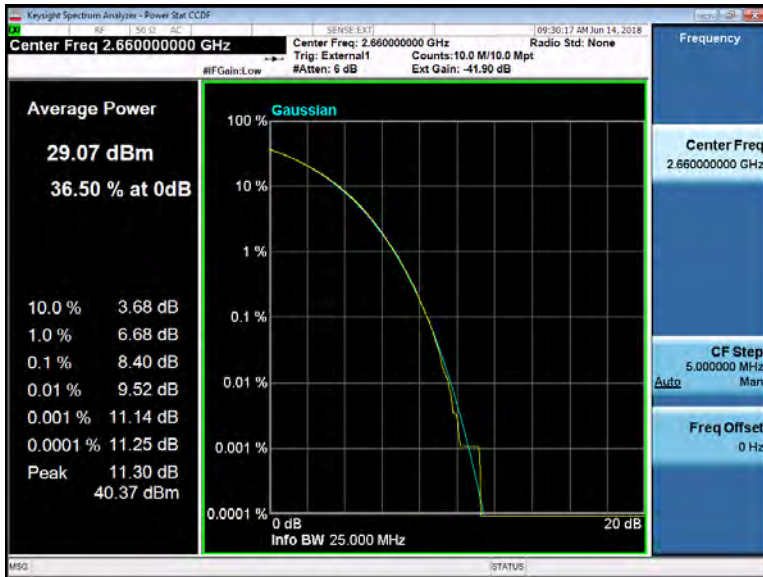
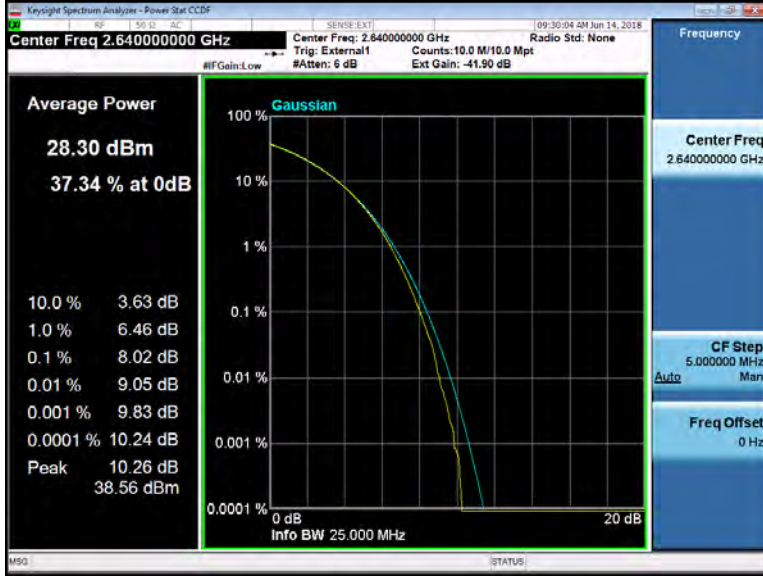

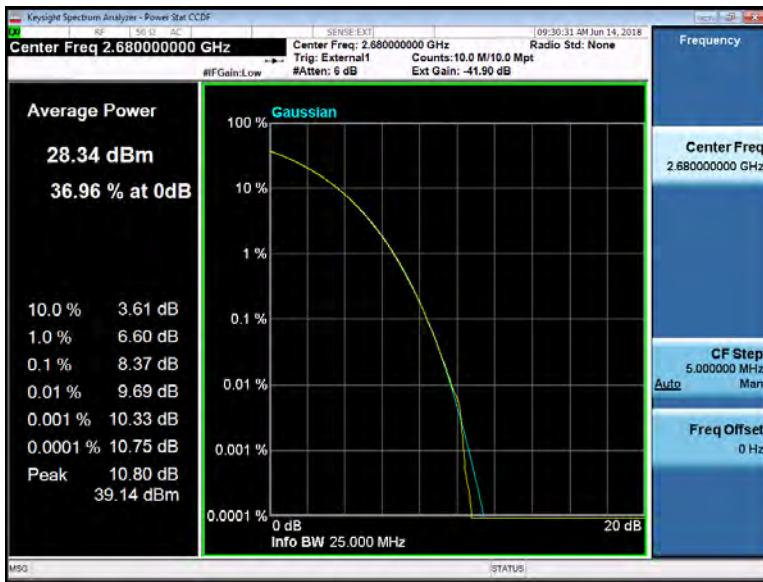



### 3. FCC Section 2.1047 - Modulation Characteristics

#### 3.1 Modulation Characteristics

The RF signal at the antenna port was demodulated and verified for correctness of the modulation signal used before each test was performed. For these products the operation with QPSK-16QAM, 64QAM and 256QAM modulation was evaluated and verified.

NOTE: Only a sample of all the data taken has been used in this report. The full suite of raw data resides at the MH, New Jersey location.

#### 3.1.1 Modulation - Single Carrier (1C)

AAHE mMIMO - B41, 1C, 28dBm, 20MBW, TM3.1A, 2640 MHz.

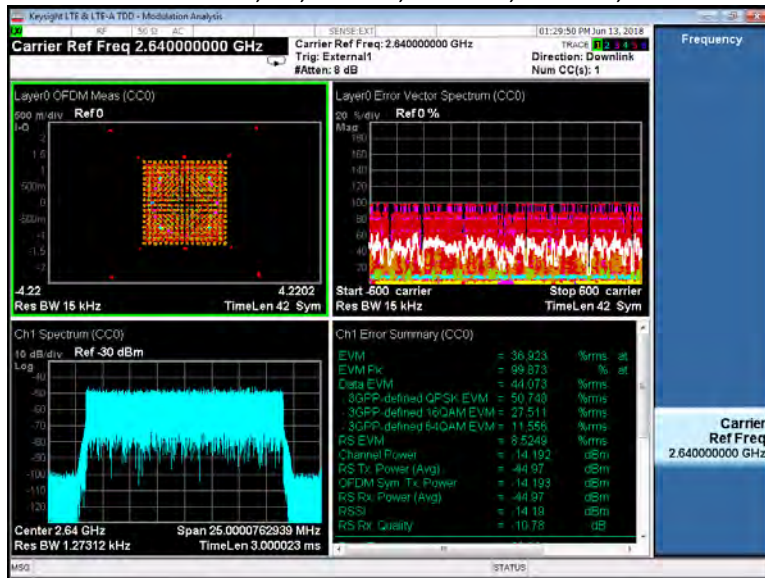

AAHE mMIMO - B41, 1C, 28dBm, 20MBW, TM3.1, 2640 MHz.

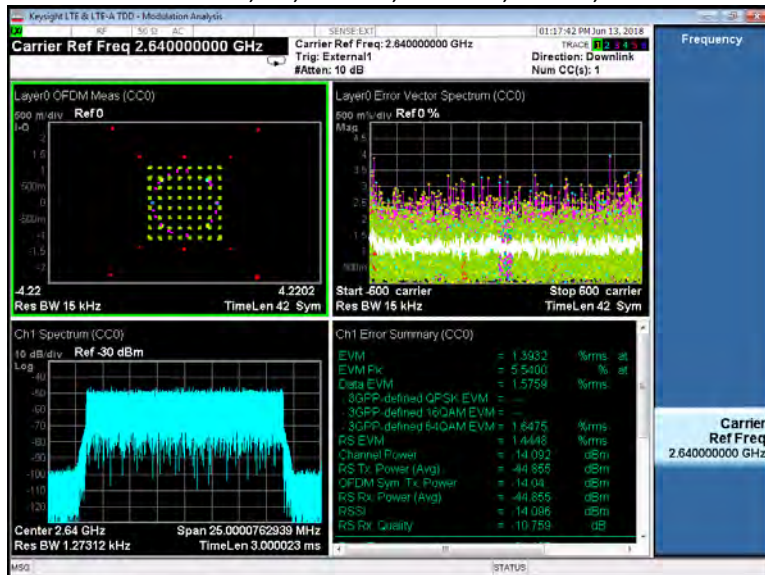

AHC mMIMO - B41, 1C, 28dBm, 20MBW, TM3.1, 2640 MHz.

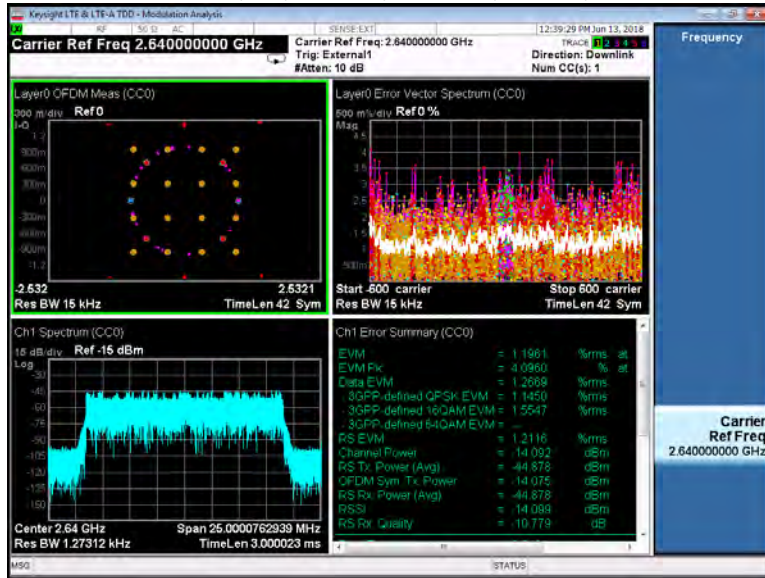

AHC mMIMO - B41, 1C, 28dBm, 20MBW, TM3.1, 2680 MHz.

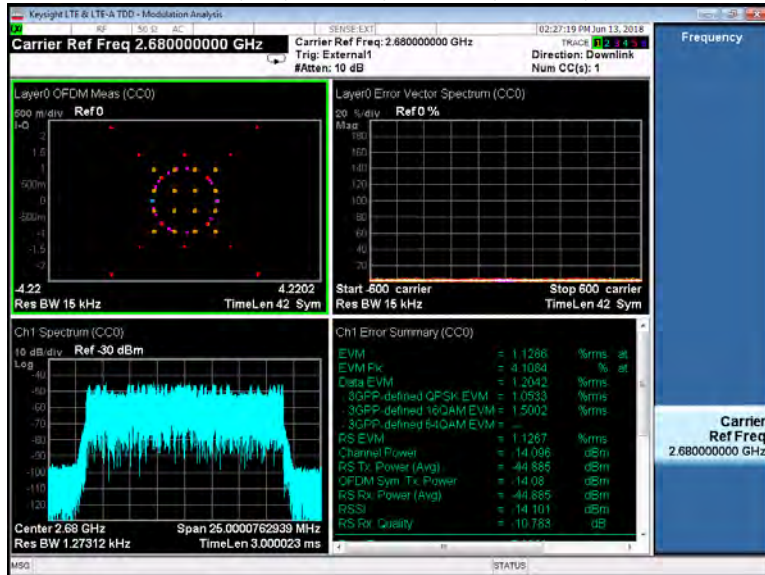

AAHE mMIMO - B41, 1C, 28dBm, 20MBW, TM3.1A, 2680 MHz.

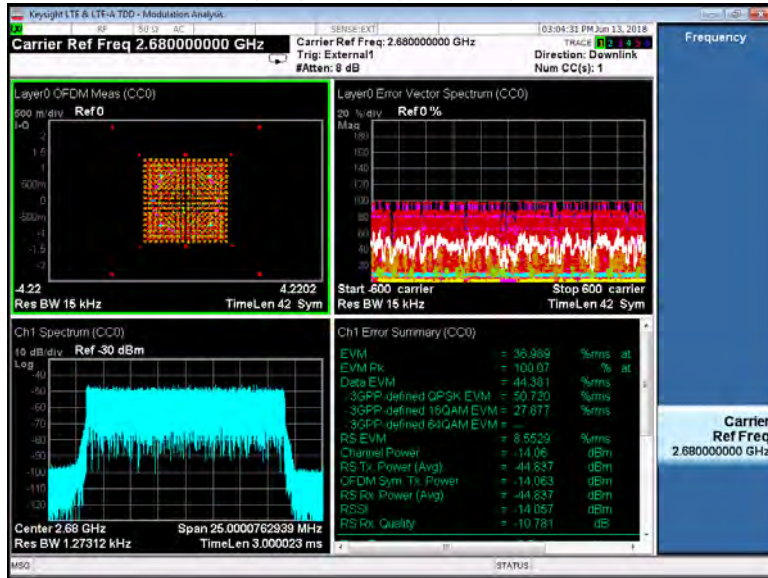

AAHE mMIMO - B41, 1C, 28dBm, 20MBW, TM3.1, 2680 MHz.

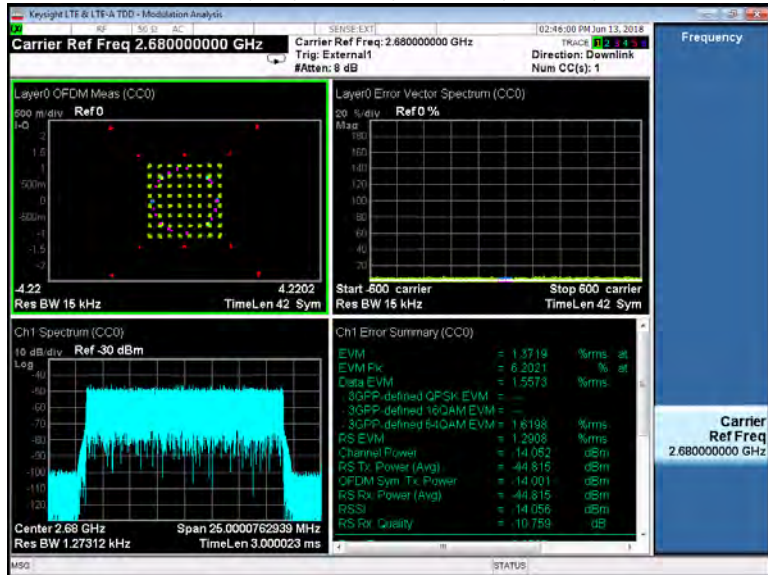



### 3.1.2 Modulation - Dual Carrier (2C)

AAHE mMIMO - B41, 2C, 31dBm, 20MBW, TM3.2, 2640 and 2660 MHz.

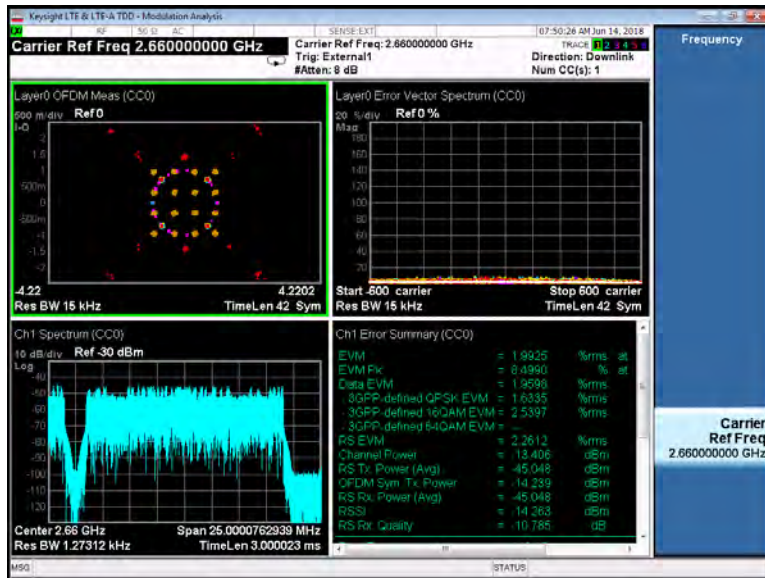
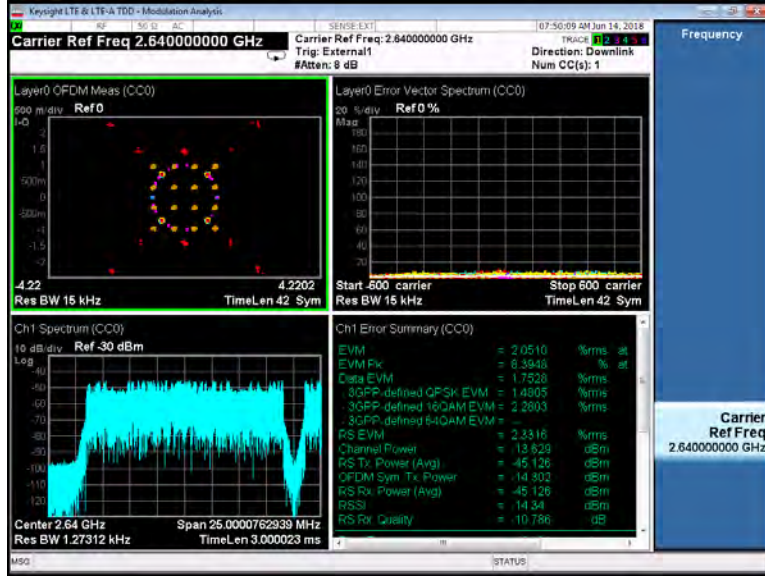

AAHE mMIMO - B41, 2C, 31dBm, 20MBW, TM3.2, 2660 and 2680 MHz.

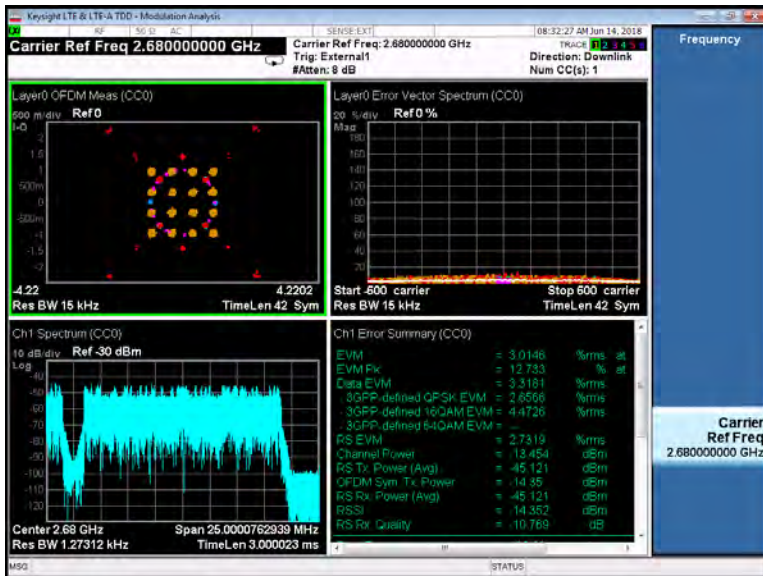
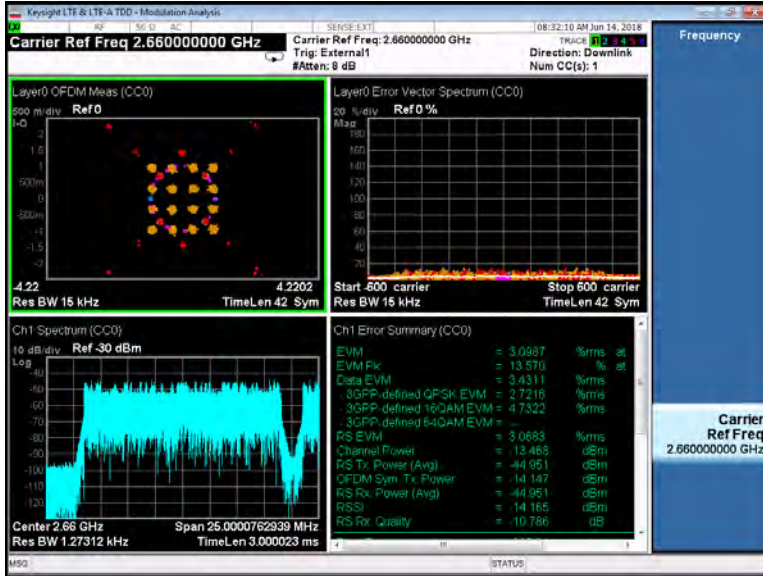

### 3.1.3 Modulation - Triple Carrier (3C)

AAHE mMIMO - B41, 3C, 32.8dBm, 20MBW, TM3.2, 2640, 2660 and 2660 MHz.

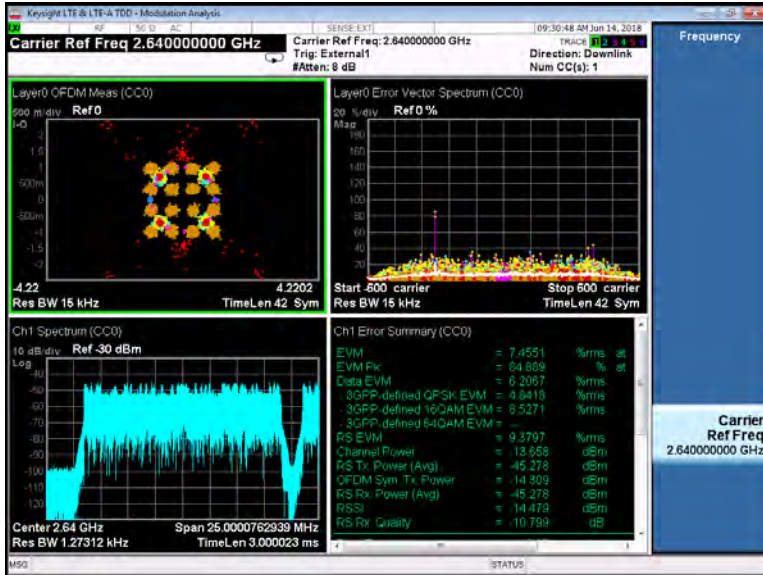
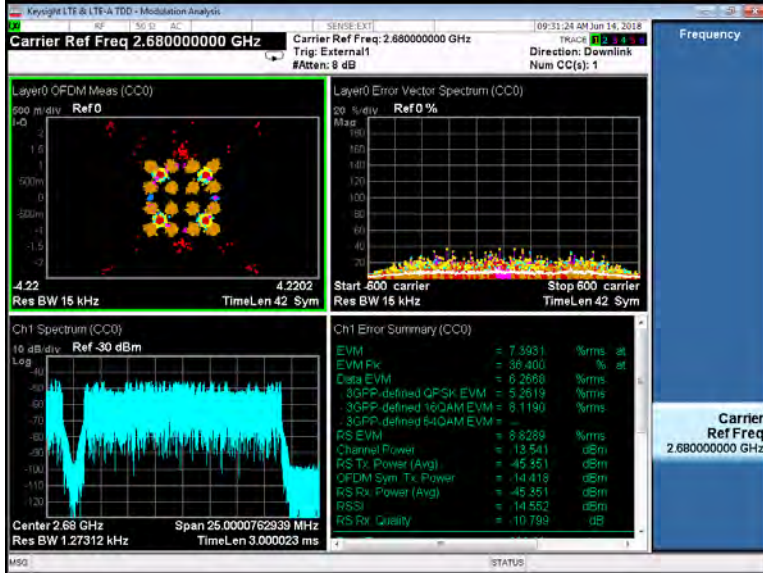

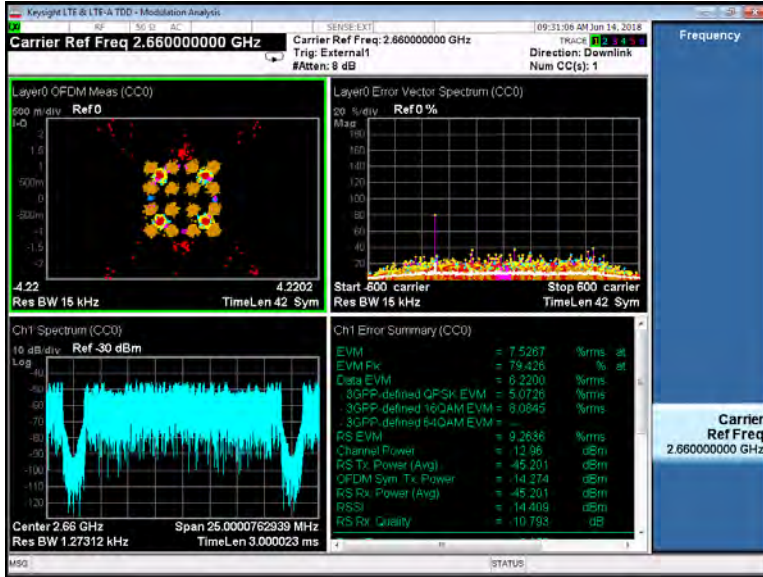

## 4. FCC Section 2.1049 – Occupied Bandwidth

### 4.1 Occupied Bandwidth –(Signal Bandwidth OBW - Si)

In 47CFR 2.1049 the FCC requires:

“The occupied bandwidth, that is the frequency bandwidth such that, below its lower and above its upper frequency limits, the mean powers radiated are each equal to 0.5 percent of the total mean power radiated by a given emission shall be measured under the following conditions as applicable.”

This required measurement is the 99% Occupied Bandwidth, also called the designated signal bandwidth and needs to be within the parameters of the products specified emissions designator. The -26 dB bandwidth values were also recorded.

During these measurements it is customary to measure the required Edge of Band emissions at the channel and block/band edges.

The product was measured to determine the Occupied Signal Bandwidth per Part 2.1049 when tested per ANSI C63.26, KDB 971168 D01, v03r01, and KDB 662911 D01, v02r01.

The RF output from the EAC port to spectrum analyzer was reduced (to an amplitude usable by the signal analyzer) by using a calibrated attenuator/ test coupler. Measurements were performed using a Keysight MXA Signal Analyzer.

Corrections for path loss were applied by using the worst case path attenuation for the frequency range of interest. These values were applied and are offset on the display. All parameters were adjusted based upon the designated signal bandwidth and measurement resolution bandwidth per transmit signal.

Specific Emissions Signal bandwidths were recorded for the one, two and three carrier configurations.

Sample Charts are below.

NOTE: Only a sample of all the data taken has been used in this report. The full suite of raw data resides at the MH, New Jersey location.



### 4.1.1 Signal Bandwidth OBW - Single Carrier (1C)

26dB and 99%, AAHE mMIMO - B41, 1C, 28dBm, 20MBW, TM3.1, 2640 MHz.

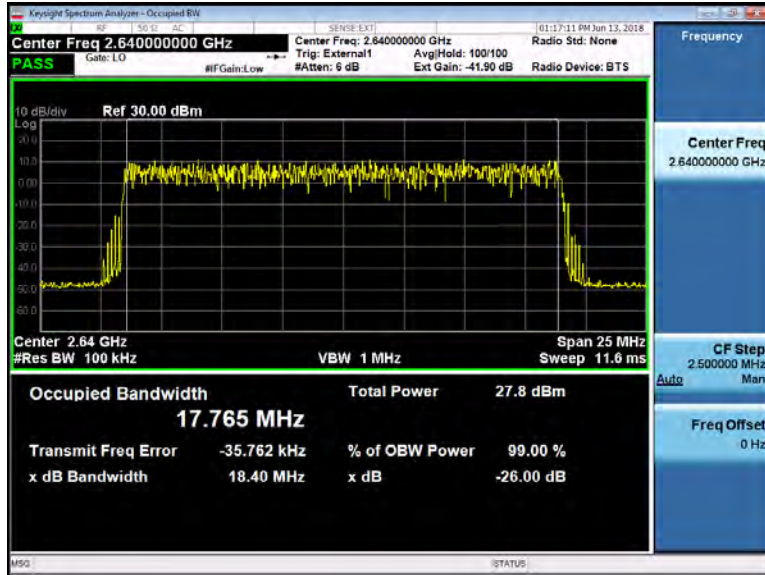

26dB and 99%, AAHE mMIMO - B41, 1C, 28dBm, 20MBW, TM3.1A, 2640 MHz.

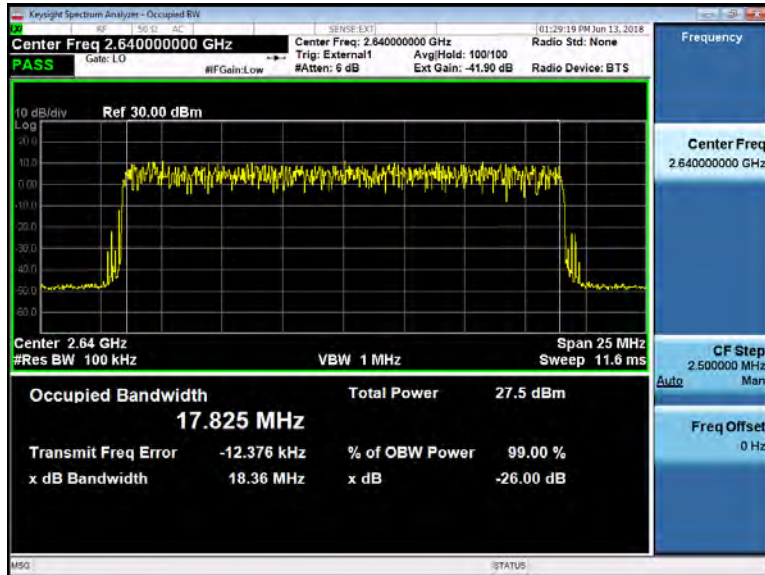

26dB and 99%, AAHE mMIMO - B41, 1C, 28dBm, 20MBW, TM3.2, 2640 MHz.

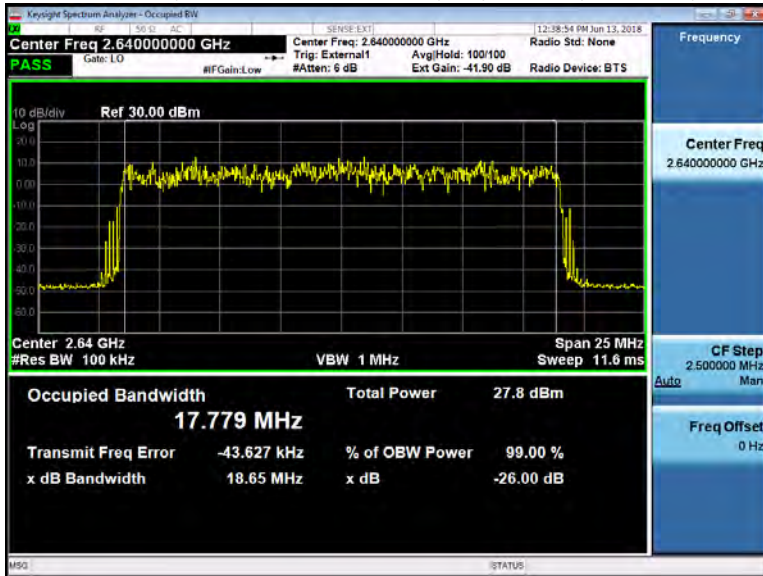

26dB and 99%, AAHE mMIMO - B41, 1C, 28dBm, 20MBW, TM3.2, 2660 MHz.

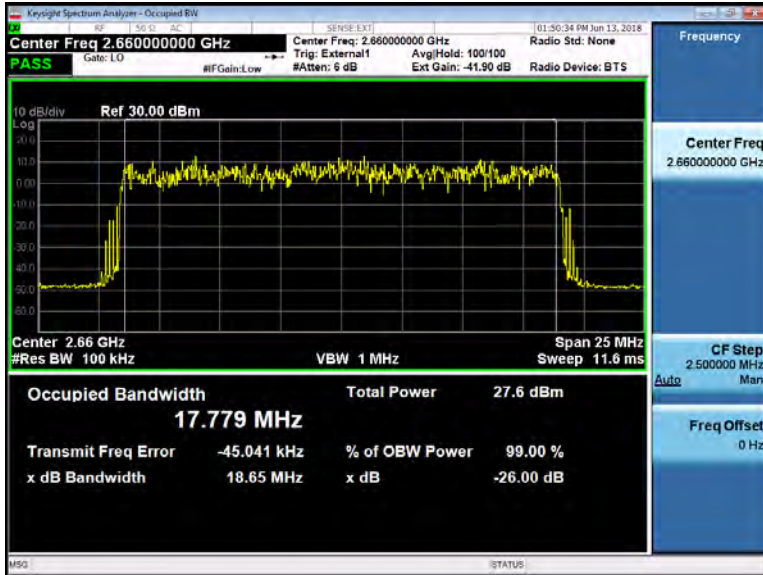

26dB and 99%, AAHE mMIMO - B41, 1C, 28dBm, 20MBW, TM3.1, 2680 MHz.

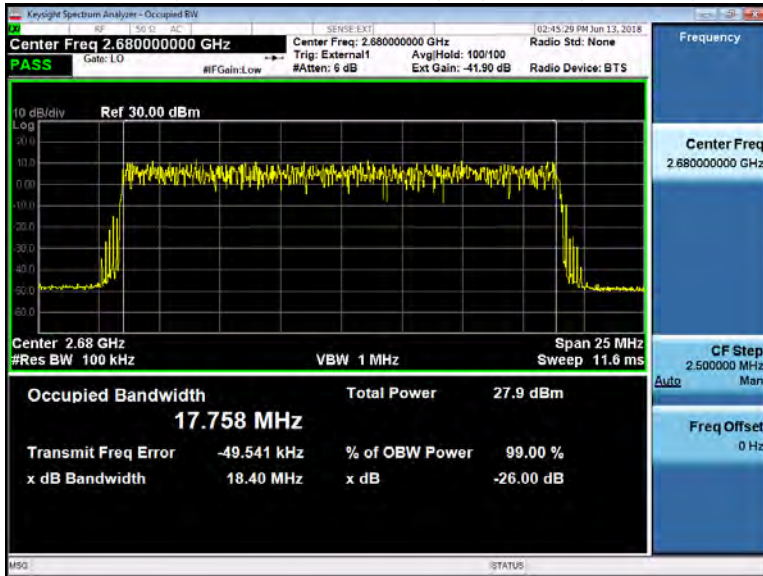

26dB and 99%, AAHE mMIMO - B41, 1C, 28dBm, 20MBW, TM3.1A, 2680 MHz.

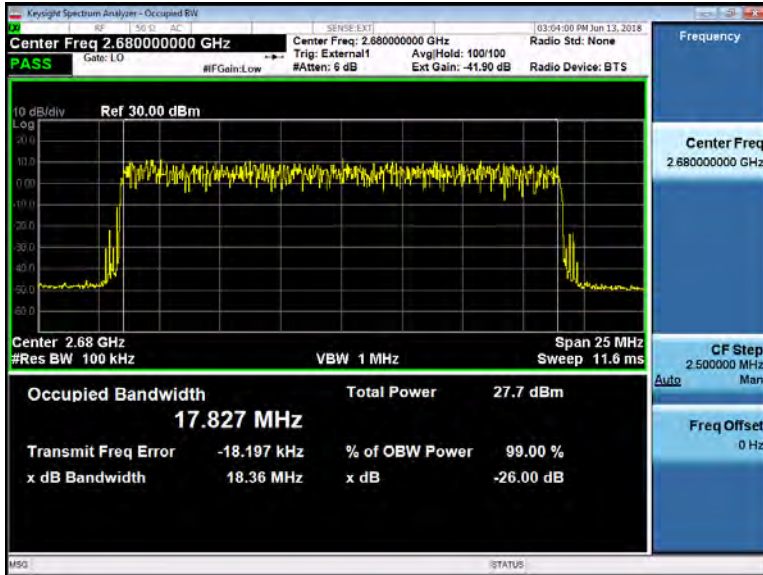



26dB and 99%, AAHE mMIMO - B41, 1C, 28dBm, 20MBW, TM3.2, 2680 MHz.

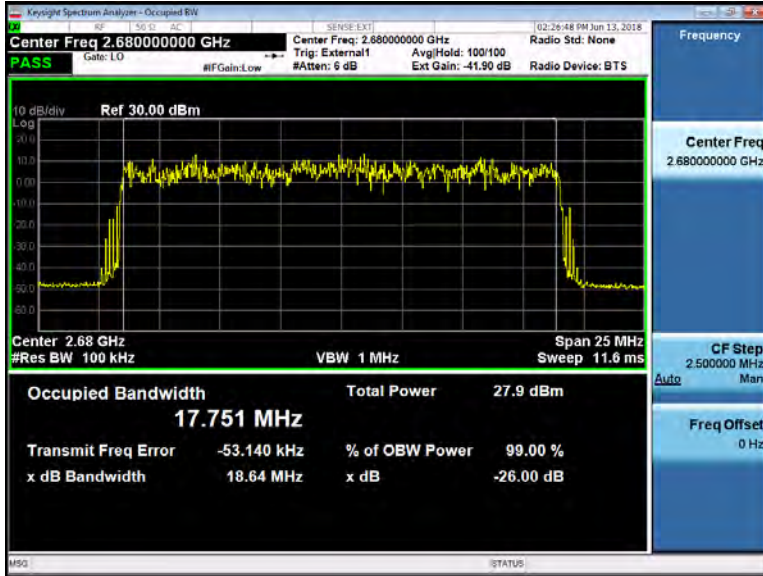

### 4.1.2 Signal Bandwidth OBW - Dual Carrier (2C)

26dB and 99%, AAHE mMIMO - B41, 2C, 31dBm, 20MBW, TM3.2, 2640 and 2660 MHz.

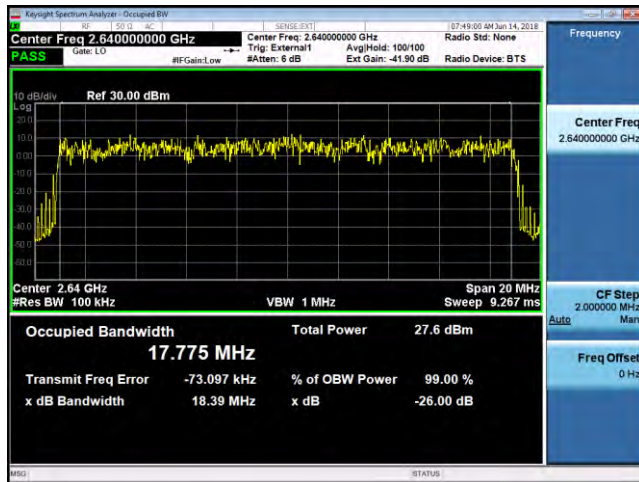
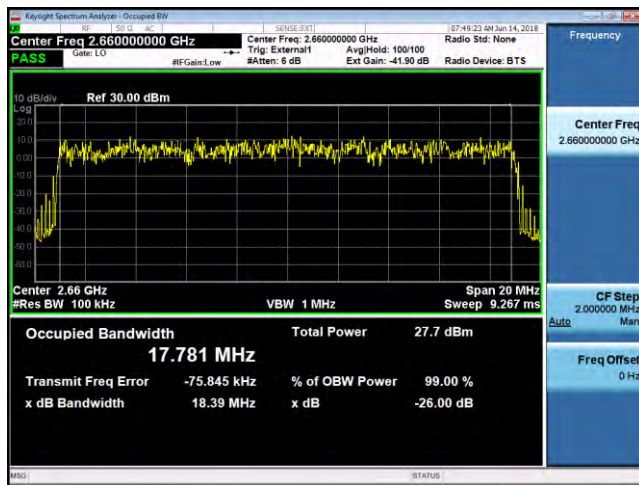
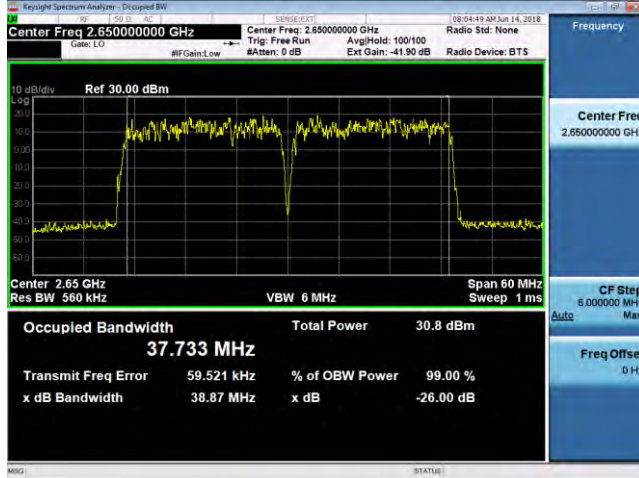

26dB and 99%, AAHE mMIMO - B41, 2C, 31dBm, 20MBW, TM3.2, 2660 and 2680 MHz.

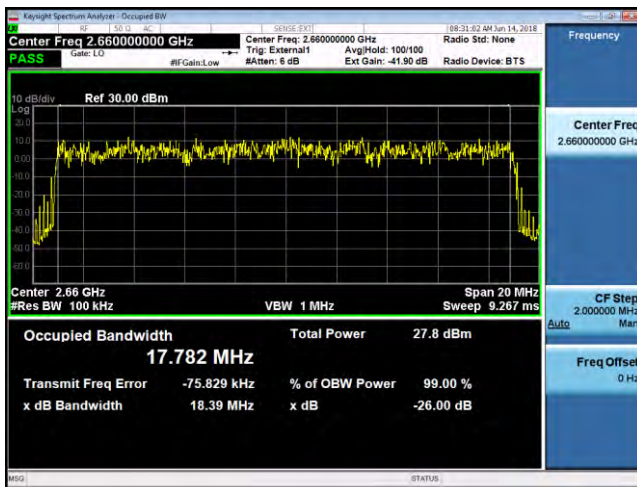
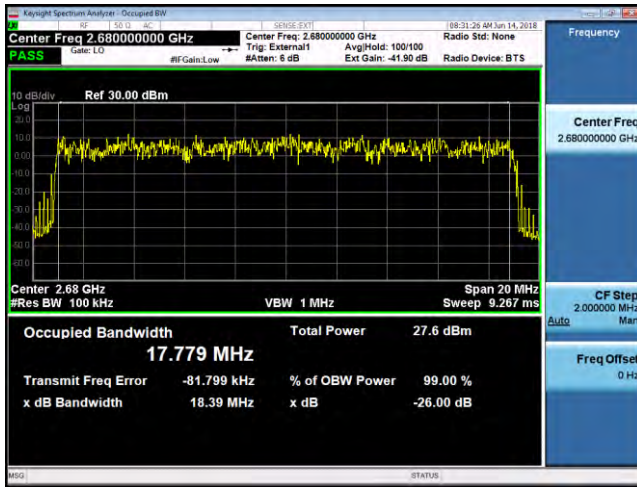
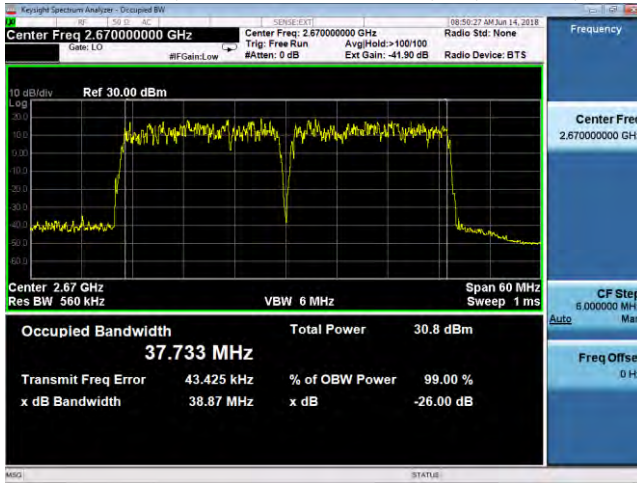

26dB and 99%, AAHE mMIMO - B41, 2C, 31dBm, 20MBW, TM3.2, 2640 and 2680 MHz.

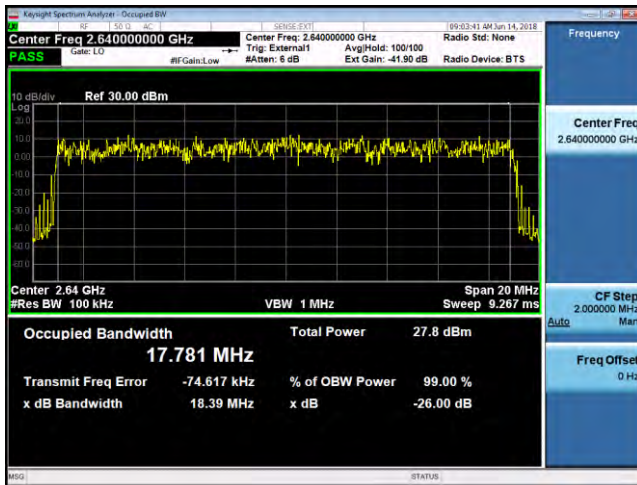
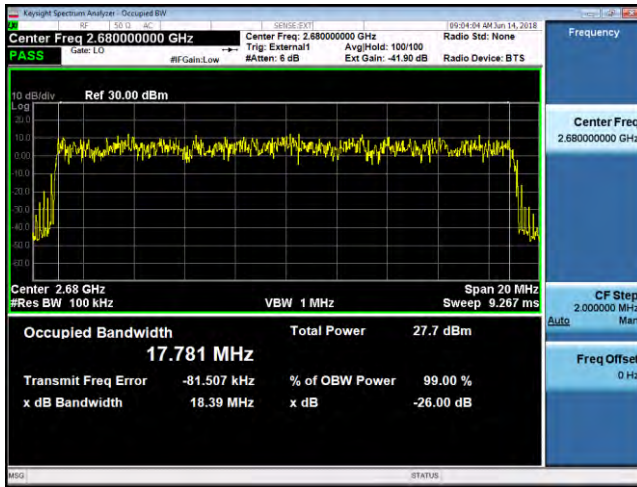
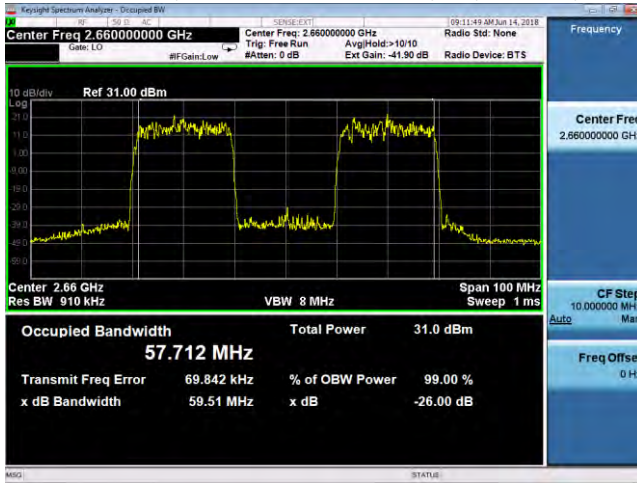



### 4.1.3 Signal Bandwidth OBW - Triple Carrier (3C)

26dB and 99%, AAHE mMIMO - B41, 3C, 32.8dBm, 20MBW, TM3.2, 2640, 2660 and 2660 MHz.

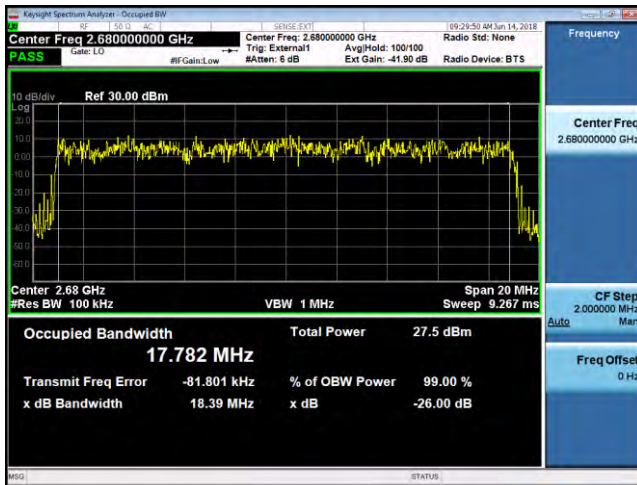
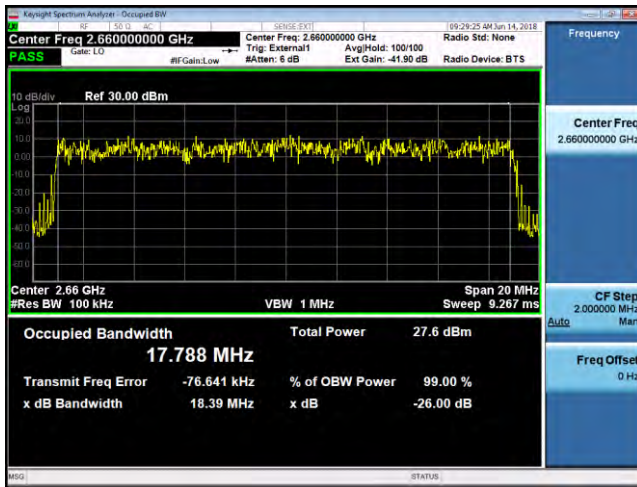
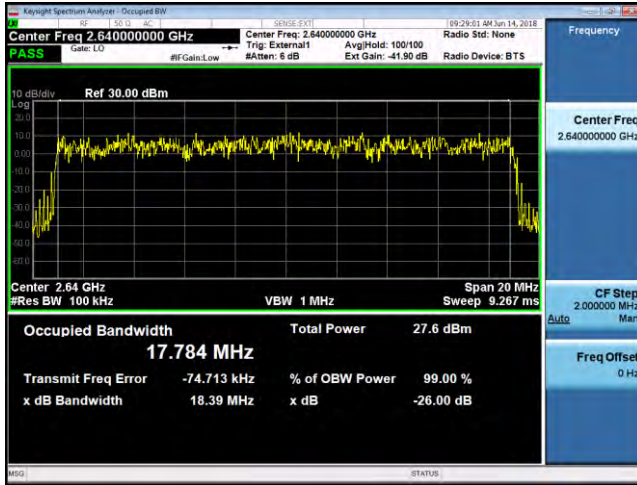

## 4.2 Occupied Bandwidth/ Edge of Band Emissions (OBW-Edge of Band)

The Occupied Bandwidth / Edge of Band emissions of the EUT at the external antenna connector (EAC) were measured to determine compliance with the limits of Part 27.53 when tested per ANSI C63.26, KDB 971168 D01, v03r01, and KDB 662911 D01, v02r01. The RF output from the EAC port to spectrum analyzer was reduced (to an amplitude usable by the signal analyzer) by using a calibrated attenuator/ test coupler. Measurements were performed using a Keysight MXA Signal Analyzer. The Block edge requirements as specified in 47CFR 27.53 were followed and are listed in Table 4.2 below:

Table 4.2 Mask values for OBW and Conducted Spurious measurements at various measurement bandwidths

Carrier Power		Signal Bandwidth	OBW Measurement RBW	Signal Offset Reference level		"n" x MIMO	MIMO Factor	1st MHz limit		Beyond the 1st MHz Limit	
W	dBm	MHz	MHz	dBc	dBm	integer	dB	dBm	dBc	dBm	dBc
1.875	32.73	20	0.1	-23.01	9.72	64	18.06	-34.07	-66.80	-41.06	-73.79
1.875	32.73	20	0.2	-20.00	12.73	64	18.06	-31.06	-63.79	-38.05	-70.78
1.875	32.73	20	1	-13.01	19.72	64	18.06	-24.07	-56.80	-31.06	-63.79

Corrections for path loss were applied by using the worst case path attenuation for the frequency range of interest. These values were applied and are offset on the display. All parameters were adjusted to the corrected RF power level for the resolution bandwidth used for the transmit signal. All mask values were adjusted based upon the designated signal bandwidth and measurement bandwidths. The mask values requirements as specified in 47CFR 27.53 were followed. These include the 10LOG(N) correction equal to 18.06 dB for 64x MIMO.

The Top of Mask corresponds to the set rated power level as confirmed by the RF Channel power. This allows confirmation that the measured trace is properly calibrated to the mask.

All emissions were within the parameters as required by Part 27.53 for compliance.  
 Sample Charts are below

NOTE: Only a sample of all the data taken has been used in this report. The full suite of raw data resides at the MH, New Jersey location.

### 4.2.1 OBW-Edge of Band - Single Carrier (1C)

Unwanted Emissions, AAHE mMIMO - B41, 1C, 28dBm, 20MBW, TM3.1, 2640 MHz.

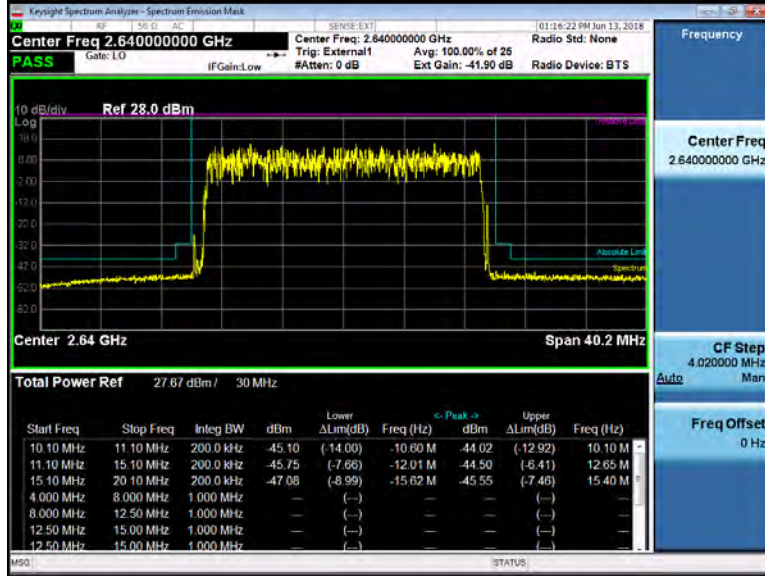

Unwanted Emissions, AAHE mMIMO - B41, 1C, 28dBm, 20MBW, TM3.1A, 2640 MHz.

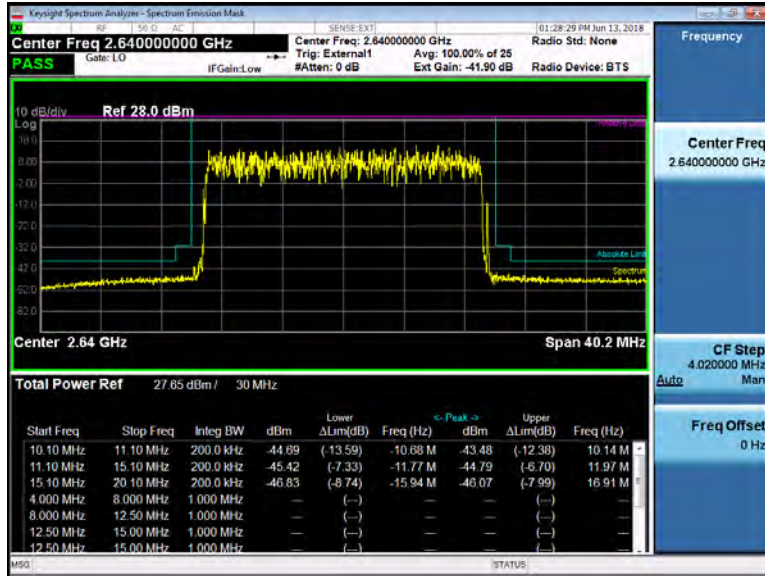

Unwanted Emissions, AAHE mMIMO - B41, 1C, 28dBm, 20MBW, TM3.2, 2640 MHz.

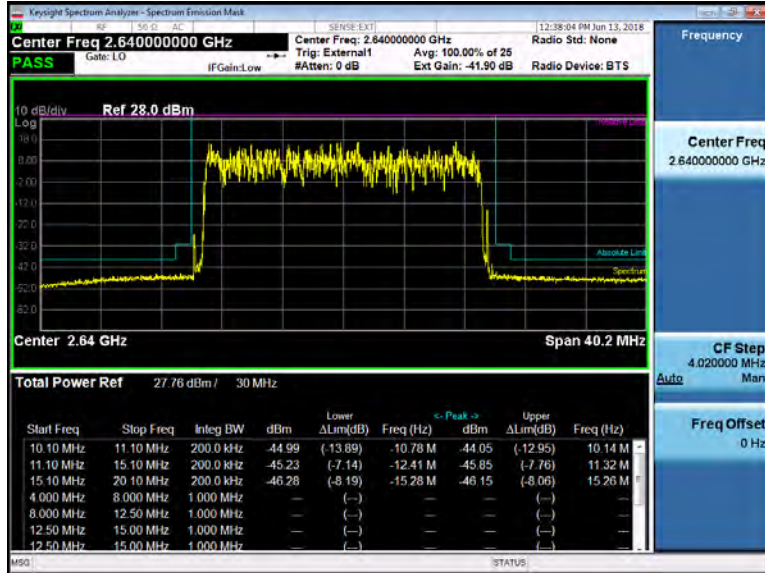

Unwanted Emissions, AAHE mMIMO - B41, 1C, 28dBm, 20MBW, TM3.2, 2660 MHz.

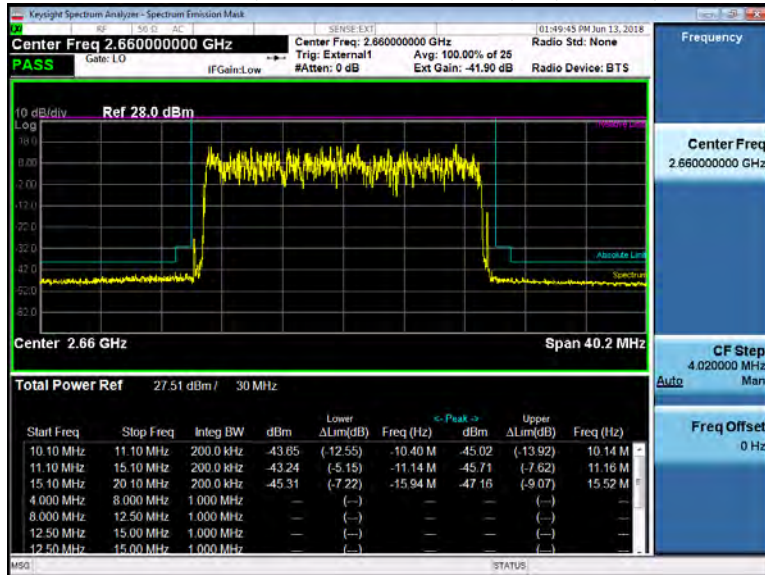



Unwanted Emissions, AAHE mMIMO - B41, 1C, 28dBm, 20MBW, TM3.1, 2680 MHz.

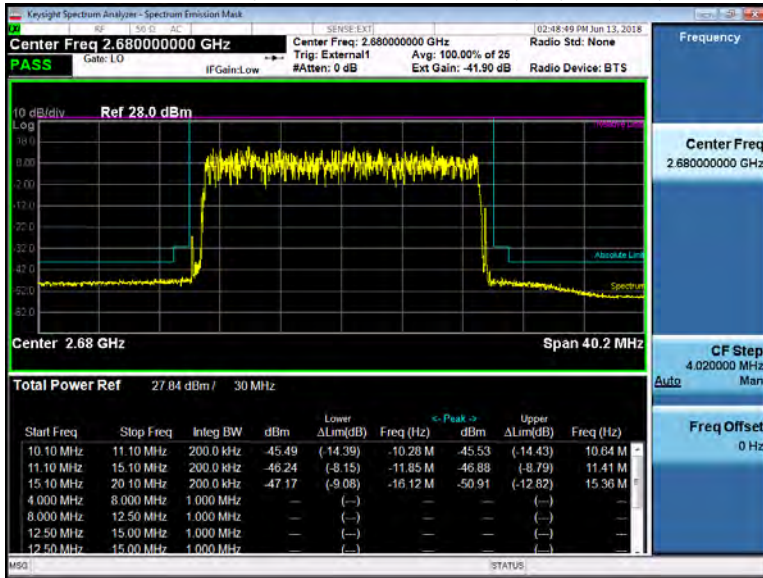

Unwanted Emissions, AAHE mMIMO - B41, 1C, 28dBm, 20MBW, TM3.1A, 2680 MHz.

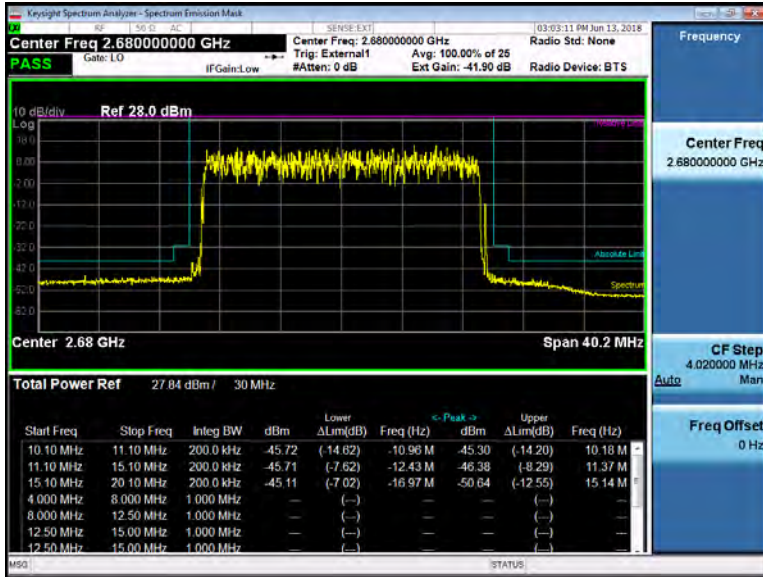

Unwanted Emissions, AAHE mMIMO - B41, 1C, 28dBm, 20MBW, TM3.2, 2680 MHz.

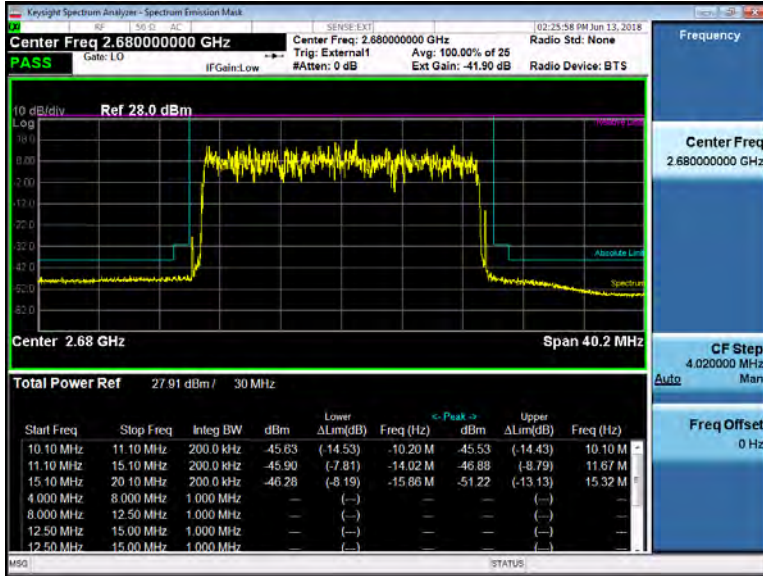

### 4.2.2 OBW-Edge of Band - Dual Carrier (2C)

Unwanted Emissions, AAHE mMIMO - B41, 2C, 31dBm, 20MBW, TM3.2, 2640 and 2660 MHz.

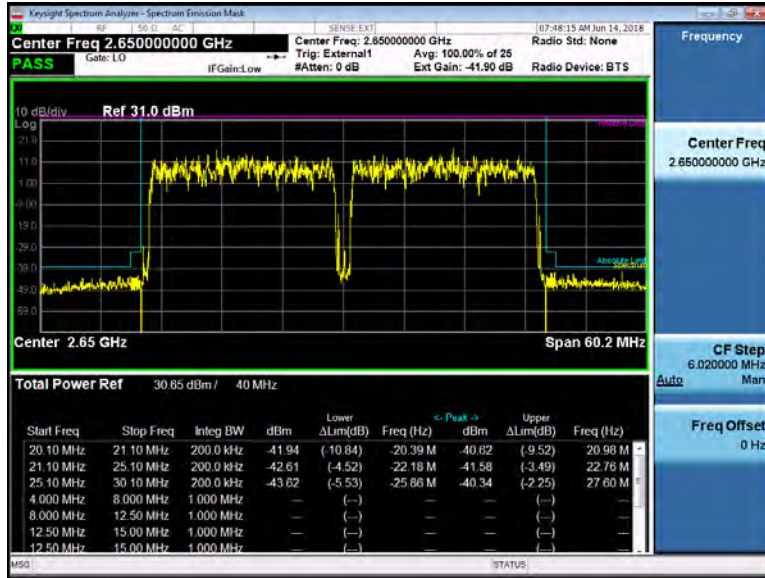

Unwanted Emissions, AAHE mMIMO - B41, 2C, 31dBm, 20MBW, TM3.2, 2660 and 2680 MHz.

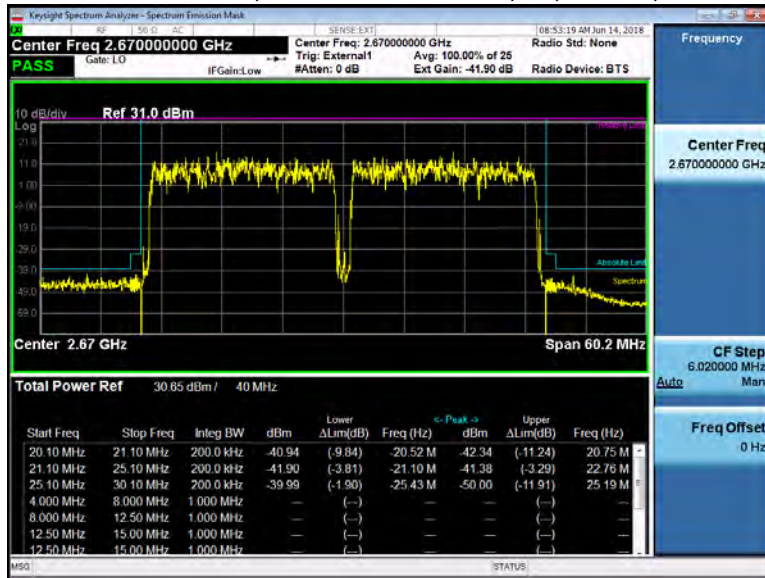

Unwanted Emissions, AAHE mMIMO - B41, 2C, 31dBm, 20MBW, TM3.2, 2640 and 2680 MHz.

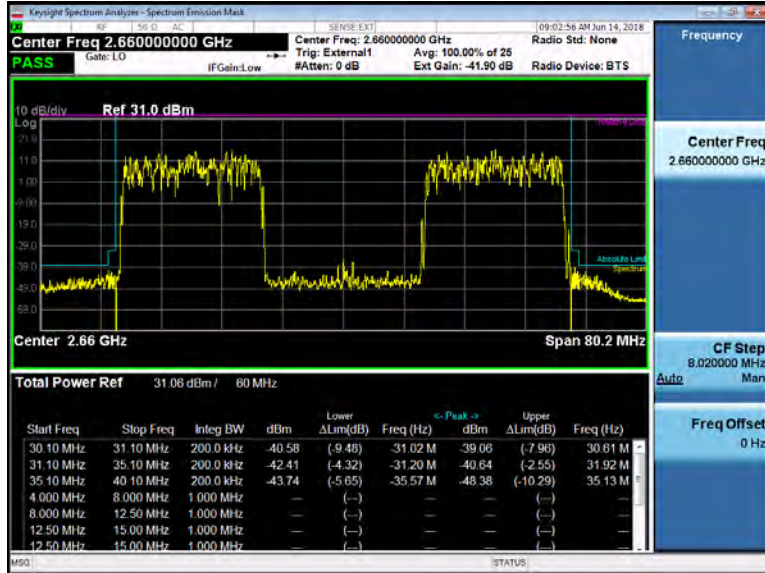

### 4.2.3 OBW-Edge of Band - Triple Carrier (3C)

Unwanted Emissions, AAHE mMIMO - B41, 3C, 32.8dBm, 20MBW, TM3.2, 2640, 2660 and 2660 MHz.

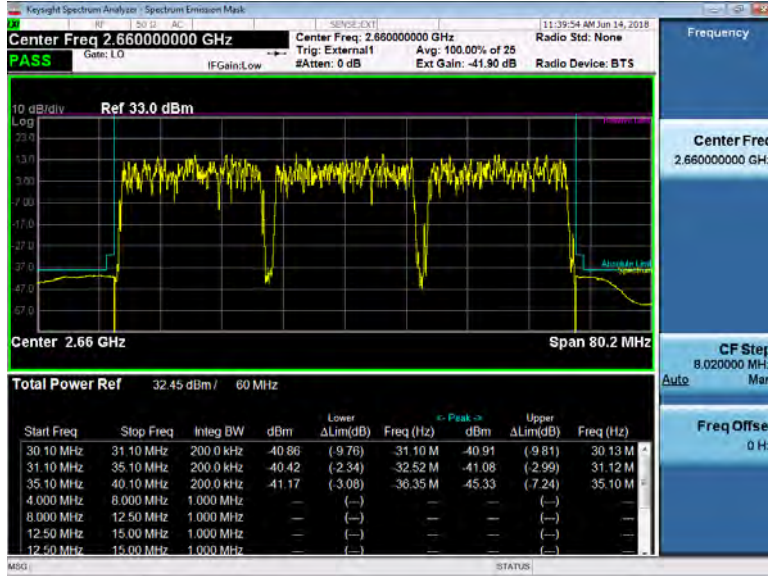

## 5. FCC Section 2.1051 - Spurious Emissions at Transmit Antenna Port

### 5.1 Measurement of Spurious Emissions at Transmit Antenna Port

The Spurious Emissions at the transmit-antenna terminals of the EUT (EAC) were measured to determine compliance with the limits of Part 27.53 when tested per ANSI C63.26, KDB 971168 D01, v03r01, and KDB 662911 D01, v02r01. The RF output from the EAC port to spectrum analyzer was reduced (to an amplitude usable by the signal analyzer) by using a calibrated attenuator/ test coupler. Measurements above 10 GHz incorporated a high pass filter to reduce path loss. Measurements were performed using a Keysight MXA Signal Analyzer. The Spurious Emissions requirements as specified in 47CFR 27.53 were followed. These include the 10LOG(N) correction equal to 18.06 dB for 64x MIMO.

The applicable per port limits are as follows

Corrections for path loss were applied by using the worst case path attenuation for the frequency range of interest. These values were applied and are offset on the display. All parameters were adjusted to the corrected RF power level for the resolution bandwidth used for the transmit signal.

The measured spurious emission levels were plotted for the frequency range of 10 MHz to 26.5 GHz. Data below documents performance up to 26.5 GHz.

All emissions were within the parameters as required by Part 27.53 for compliance.  
Sample Charts are below

NOTE: Only a sample of all the data taken has been used in this report. The full suite of raw data resides at the MH, New Jersey location.



### 5.1.1 Antenna Port Spurious Emissions - Single Carrier (1C)

Spurious Emissions, AAHE mMIMO - B41, 1C, 28dBm, 20MBW, TM3.1A, 2640 MHz.

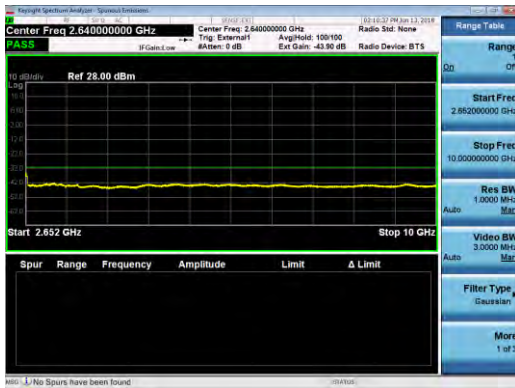
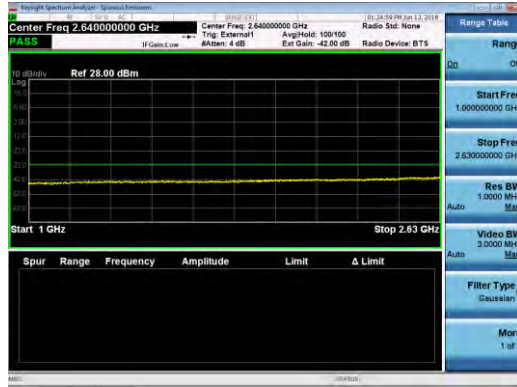
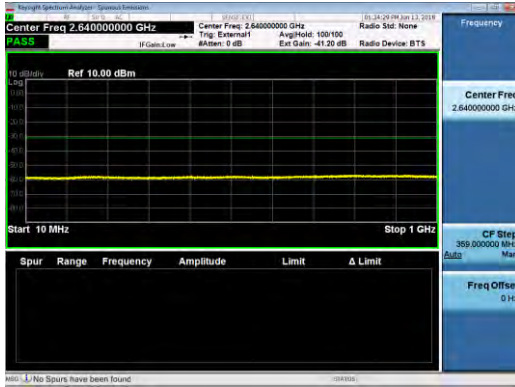

Spurious Emissions, ASHC mMIMO - B41, 1C, 28dBm, 20MBW, TM3.2, 2680 MHz.

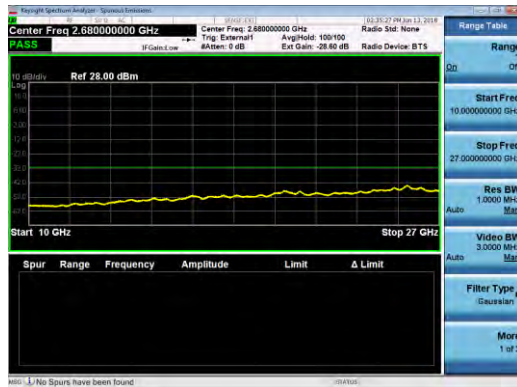
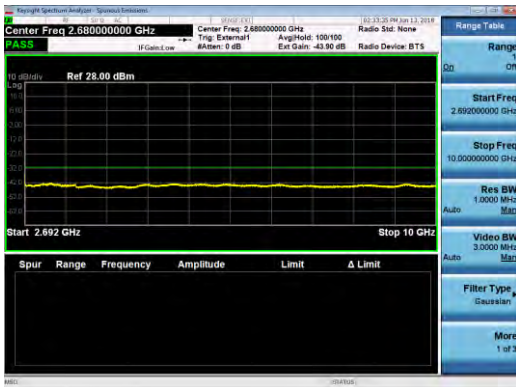
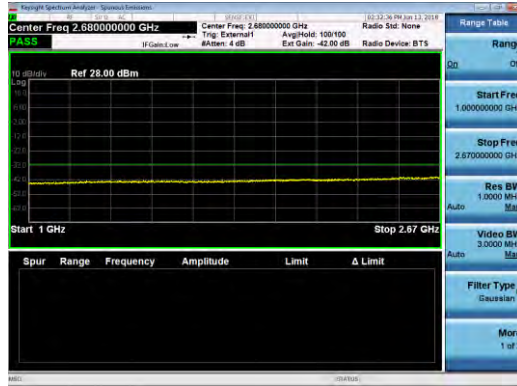
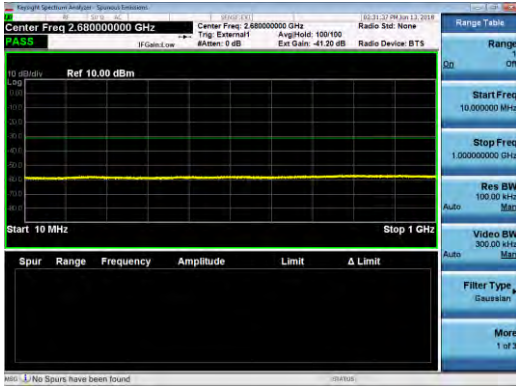

### 5.1.2 Antenna Port Spurious Emissions - Dual Carrier (2C)

Spurious Emissions, AAHE mMIMO - B41, 2C, 31dBm, 20MBW, TM3.2, 2640 and 2660 MHz.

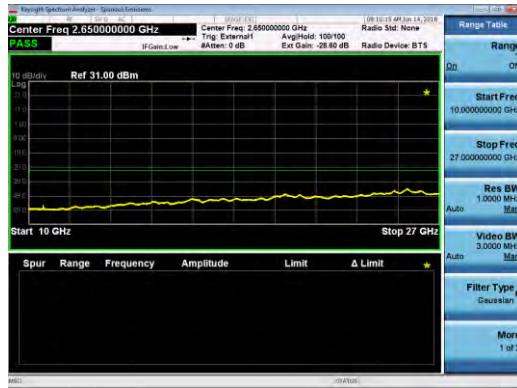
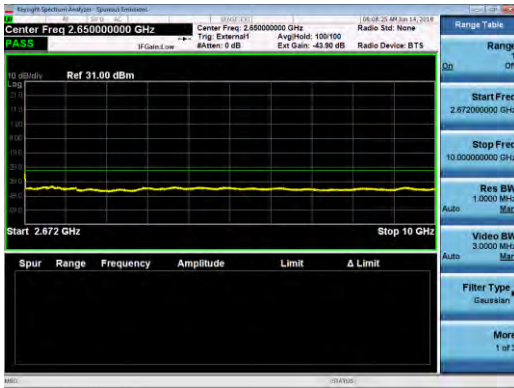
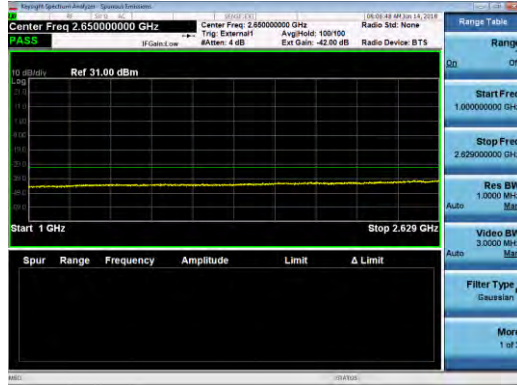
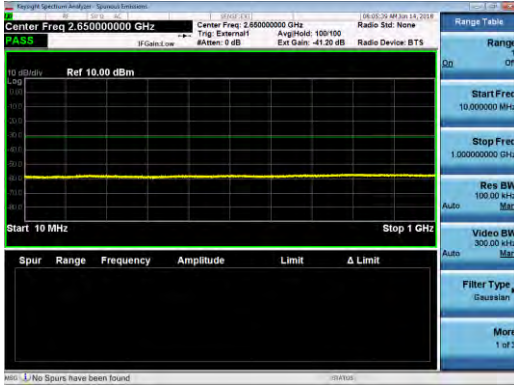

Spurious Emissions, AAHE mMIMO - B41, 2C, 31dBm, 20MBW, TM3.2, 2660 and 2680 MHz.

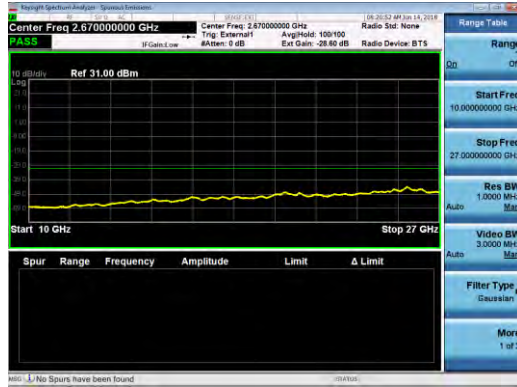
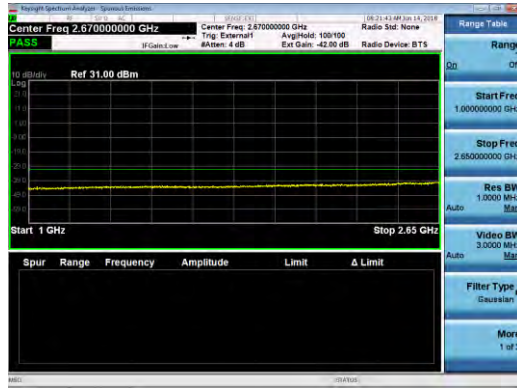
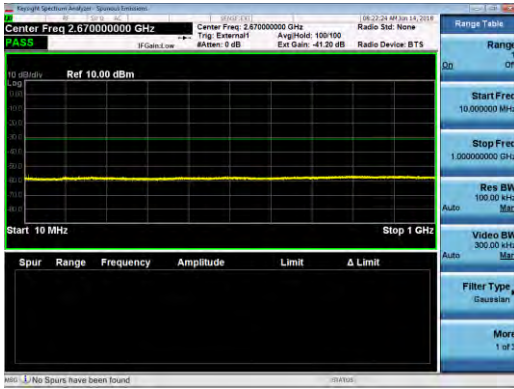

Spurious Emissions, AAHE mMIMO - B41, 2C, 31dBm, 20MBW, TM3.2, 2640 and 2680 MHz.

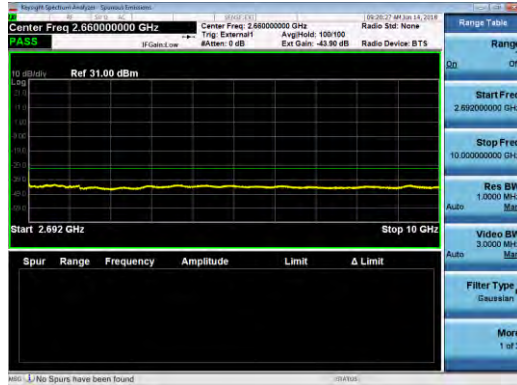
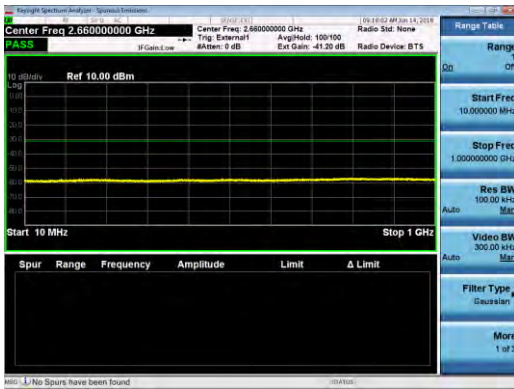



### 5.1.3 Antenna Port Spurious Emissions - Triple Carrier (3C)

Spurious Emissions, AAHE mMIMO - B41, 3C, 32.8dBm, 20MBW, TM3.2, 2640, 2660 and 2660 MHz.

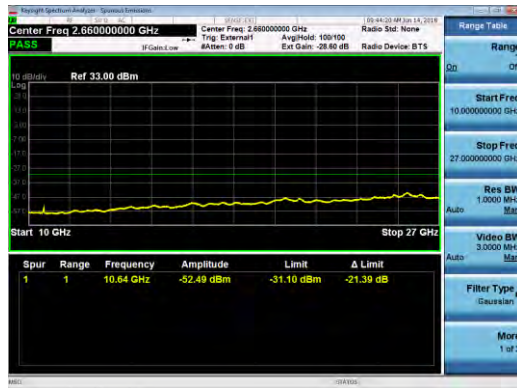
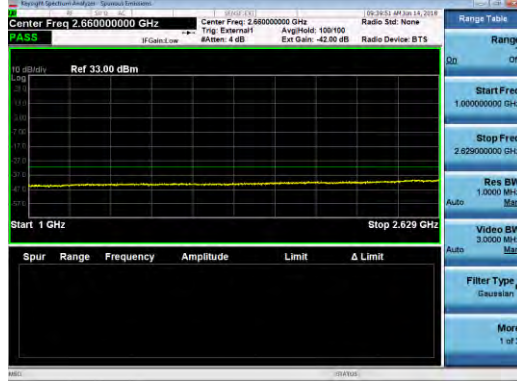
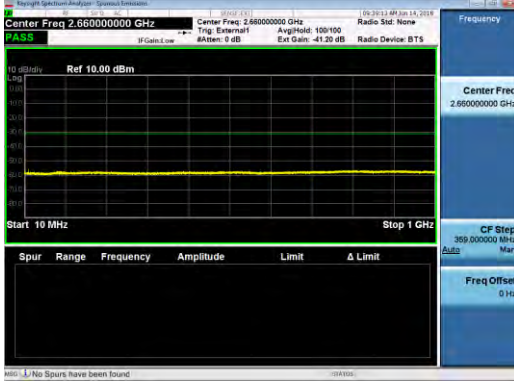

## 6. FCC Section 2.1053 and Part 15.109

### 6.1 Section 2.1053 Field Strength of Spurious Emissions

Field strength measurements of radiated spurious emissions were made in a 10m Semi-Anechoic Chamber the of Global Product Compliance Laboratories of Nokia Bell Labs in Murray Hill NJ. A complete description and full measurement data for the site is on file with the Commission (FCC File 328881).

The spectrum from 30 MHz to the tenth harmonic of the carrier, as high as 27 GHz depending upon the product, was searched for spurious radiation. Measurements were made using both horizontally and vertically polarized broadband antennas. Per FCC regulations, the comparison of out of band spurious emissions directly to the limit is appropriately made using the substitution method. However, when the emissions have sufficient margin below the specification limit, the use of field strength measurements for compliance determination is acceptable. For this case the evaluation of acceptable radiated field strength is as follows.

Sections 2.1053 and 27.53 contain the requirements for the levels of spurious radiation as a function of the level of the unmodulated carrier. The reference level for the unmodulated carrier is calculated as the field produced by an ideal dipole excited by the transmitter output power according to the following relation taken from Reference Data for Radio Engineers, page 676, 4<sup>th</sup> edition, IT&T Corp.

$$E = [(30 * P)^{1/2}] / R$$

$$20 \log (E * 10^6) - (43 + 10 \log P) = 82.23 \text{ dB}\mu\text{V/meter}$$

Where:

E = Field Intensity in Volts/meter

P = Transmitted Power in Watts

R = Measurement distance in meters = 3 m

The non-report compliance limit is 62.23 dB $\mu$ V/m for 64x64 MIMO

The FCC Part 15 Class B limit is 54 dB $\mu$ V/m above 1GHz.

The calculated emission levels were found by:

$$\text{Measured level (dB}\mu\text{V)} + \text{Cable Loss(dB)} + \text{Antenna Factor(dB)} = \text{Field Strength (dB}\mu\text{V/m)}$$

### 6.2 Field Strength of Spurious Emissions Results:

For compliance with 47CFR Parts 2 and 27, the field strength of any spurious radiation, measured at 3m, is required to be less than 82.23 dB $\mu$ V/meter @ 3m. Emissions equal to or less than 64.2 dB $\mu$ V/meter at 3m are not reportable and may be verified using field strength measurements and broadband antennas. Over the out of band spectrum investigated from 30 MHz to beyond the tenth harmonic of the carrier (up to 27 GHz), no spurious emissions above the limits were detected. A representative set of measurement scans are included below.

T14 Radiated Emissions 30M-200MHz FCC Class B

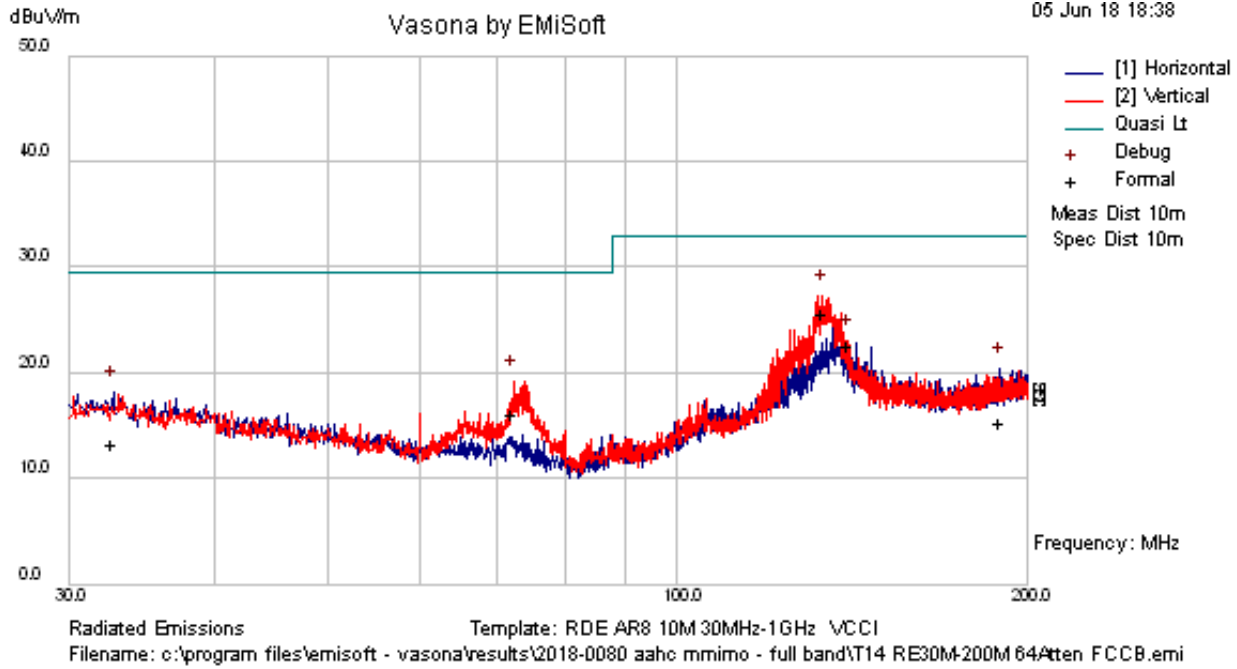

Results Title:	RDE AR8 3M 30MH-200 MHz BILOG
File Name:	c:\program files\emisoft - vasona\results\2018-0080 AAHE mmimo - full band\T14 RE30M-200M 64Atten FCCB.emi
Test Laboratory:	AR8 MH GPCL 23C, 43% RH 1000mB
Test Engineer:	JY / MJS
Test Software:	Vasona by EMISoft, version 2.161
Equipment:	Nokia
EUT Details:	2018-0080 60MHz Wide Band, AAHE mMIMO - Full Band, Powered by -48VDC, 20 Amps, Tx-2640MHz, 2660, 2680, all ETM3.2, 3C, 31.8dBm per port. All ports transmitting
Configuration:	Radiated Emissions FCC Part 15, RE 30MHz-200MHz, Bicon Antenna E051, Log-Periodic -E061, Sonoma Preamp E813, ESI-E936. Chamber lights off.
Date:	2018-06-05 18:38:13

FORMAL DATA

Freq. MHz	Raw dBuV	Cable dB	Factor dB	Level dBuV/m	Emission Type	Pol H/V	Ht cm	Az deg	Limit dBuV/m	Margin dB	Pass /Fail	Comments
133.385	35.61	6.97	-19.3	23.29	Quasi Max	V	110	268	33	-9.71	Pass	
140.379	32.46	7	-19.1	20.37	Quasi Max	V	111	292	33	-12.63	Pass	
72.2285	30.75	6.66	-23.7	13.74	Quasi Max	V	244	197	29.5	-15.76	Pass	
32.6934	23.42	6.49	-18.9	11.03	Quasi Max	H	151	180	29.5	-18.47	Pass	
189.631	24.26	7.18	-18.4	13.05	Quasi Max	H	235	277	33	-19.95	Pass	

PREVIEW DATA

Freq. MHz	Raw dBuV	Cable dB	Factor dB	Level dBuV/m	Emission Type	Pol H/V	Ht cm	Az deg	Limit dBuV/m	Margin dB	Pass /Fail	Comments
133.407	39.5	6.97	-19.3	27.18	Preview	V	100	270	33	-5.82	Pass	
140.333	35.04	7	-19.1	22.94	Preview	V	100	270	33	-10.06	Pass	
72.2285	36.15	6.66	-23.7	19.14	Preview	V	190	180	29.5	-10.36	Pass	
32.6934	30.46	6.49	-18.9	18.07	Preview	H	200	270	29.5	-11.43	Pass	
189.631	31.52	7.18	-18.4	20.31	Preview	H	100	0	33	-12.69	Pass	

Note: Preview data was measured using a peak detector to identify frequencies of interest for formal measurement. Formal data consist of all frequencies in the preview list within 6 dB of specification limit or the top six frequencies. Failure in preview data does not necessarily constitute failure in formal data.

T12 Radiated Emissions 200M-1 GHz 1C FCC Class B

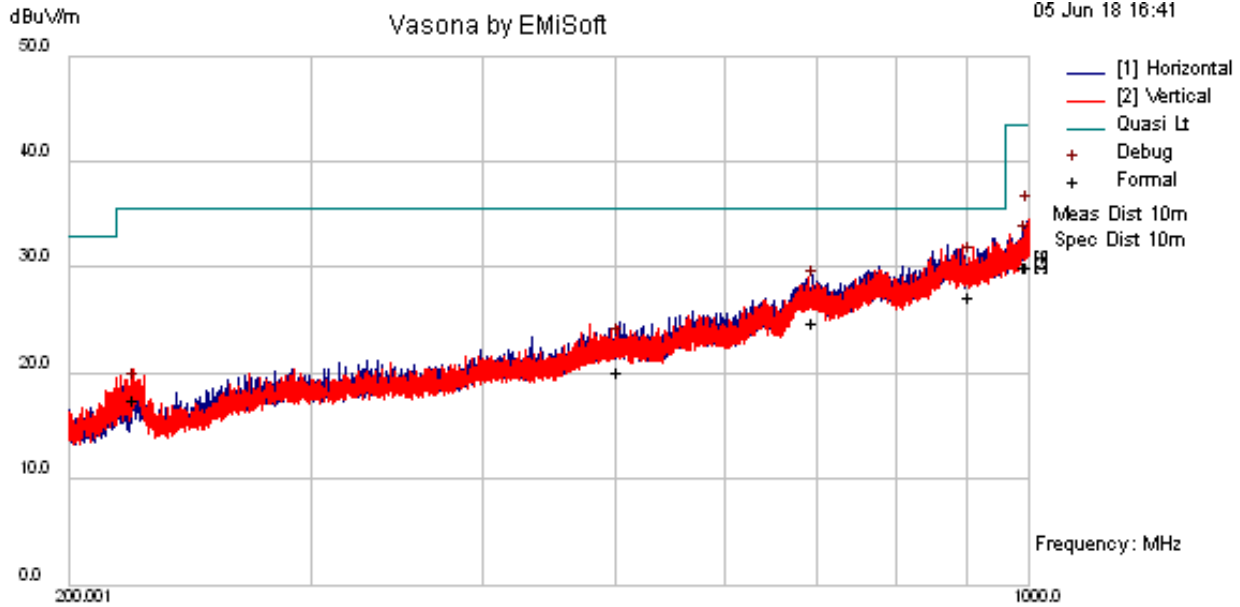

Radiated Emissions Template: RDE AR8 10M 30MHz-1GHz VCCI  
 Filename: c:\program files\emisoft - vasona\results\2018-0080 aahe mmimo - full band\T12 RE200M-1G 64Atten FCCB 10M.emi

Results Title:	RDE AR8 3M 200 MHz-1GHz BILOG
File Name:	c:\program files\emisoft - vasona\results\2018-0080 aahe mmimo - full band\T12 RE200M-1G 64Atten FCCB 10M.emi
Test Laboratory:	AR8 MH GPCL 23C, 43% RH 1000mB
Test Engineer:	JY / MJS
Test Software:	Vasona by EMISoft, version 2.161
Equipment:	Nokia
EUT Details:	2018-0080 60MHz Wide Band, AAHE mMIMO - Full Band, Powered by -48VDC, 20 Amps, Tx-2640MHz, 2660, 2680, all ETM3.2, 3C, 31.8dBm per port. All ports transmitting, 64 attenuators.
Configuration:	Radiated Emissions FCC Part 15, Class B 200MHz-1GHz, Log Periodic Ant E061, 6dB Pad-E1130, Sonoma Preamp E813, ESI-E936. 10dB internal Attenuation, chamber lights off
Date:	2018-06-05 16:41:53

FORMAL DATA

Freq. MHz	Raw dBuV	Cable dB	Factor dB	Level dBuV/m	Emission Type	Pol H/V	Ht cm	Az deg	Limit dBuV/m	Margin dB	Pass /Fail	Comments
906.49	24.52	9.2	-8.86	24.87	Quasi Max	V	334	119	35.6	-10.73	Pass	
697.88	24.52	8.45	-10.4	22.55	Quasi Max	H	228	166	35.6	-13.05	Pass	
999.078	24.61	9.44	-6.2	27.84	Quasi Max	V	156	201	43.5	-15.66	Pass	
995.985	24.69	9.43	-6.4	27.72	Quasi Max	H	188	115	43.5	-15.78	Pass	
502.16	23.99	7.87	-14	17.88	Quasi Max	V	261	182	35.6	-17.72	Pass	
222.953	28.24	7.3	-20.4	15.16	Quasi Max	H	175	220	35.6	-20.44	Pass	

PREVIEW DATA

Freq. MHz	Raw dBuV	Cable dB	Factor dB	Level dBuV/m	Emission Type	Pol H/V	Ht cm	Az deg	Limit dBuV/m	Margin dB	Pass /Fail	Comments
999.078	31.41	9.44	-6.2	34.65	Preview	V	390	90	43.5	-8.85	Pass	
906.49	29.38	9.2	-8.86	29.73	Debug	V	100	317	35.6	-5.87	Pass	
502.16	28.23	7.87	-14	22.12	Debug	V	100	317	35.6	-13.48	Pass	
222.953	31.04	7.3	-20.4	17.96	Debug	H	100	317	35.6	-17.64	Pass	
995.985	28.87	9.43	-6.4	31.9	Debug	H	100	317	43.5	-11.6	Pass	
697.88	29.61	8.45	-10.4	27.64	Debug	H	100	317	35.6	-7.96	Pass	

Note: Preview data was measured using a peak detector to identify frequencies of interest for formal measurement. Formal data consist of all frequencies in the preview list within 6 dB of specification limit or the top six frequencies. Failure in preview data does not necessarily constitute failure in formal data.

T16 Radiated Emissions 1GHz-4.5GHz FCC B

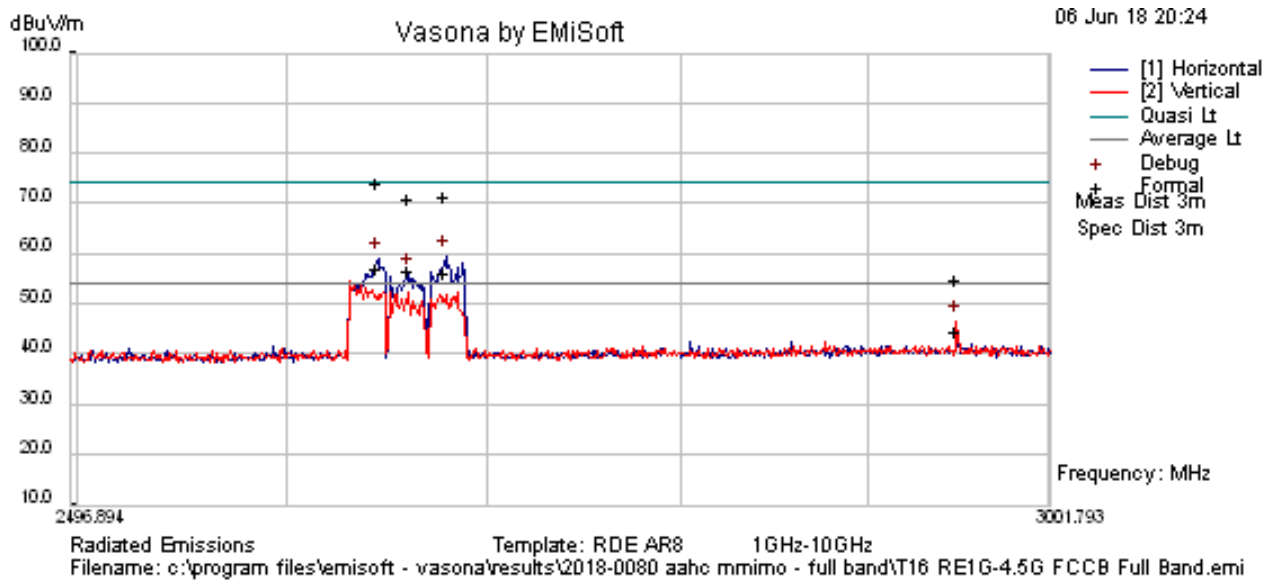
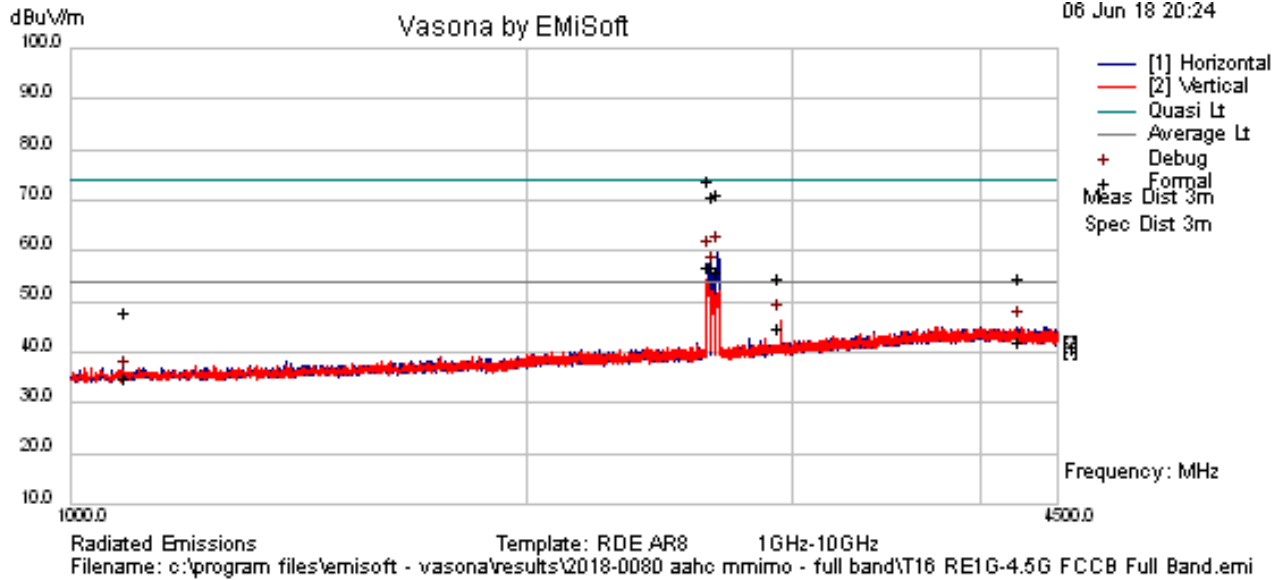

Results Title:	RDE AR8 1GHz-4.5 GHz
File Name:	c:\program files\emisoft - vasona\results\2018-0080 aahe mmimo - full band\T16 RE1G-4.5G FCCB Full Band.emi
Test Laboratory:	AR8 MH GPCL 23C, 43% RH 1000mB
Test Engineer:	MJS
Test Software:	Vasona by EMISoft, version 2.161
Equipment:	Nokia
EUT Details:	2018-0080 60MHz Wide Band, AAHE mMIMO - Full Band, Powered by -48VDC, 20 Amps, Tx-2640MHz, 2660, 2680, all ETM3.2, 3C, 31.8dBm per port. All ports transmitting
Configuration:	Powered by -48VDC, 20 Amps, Tx-2593MHz, 256QAM, 1C, 28dBm per port. All ports transmitting. Radiated Emissions FCC Part 15, RE 1GHz-4.5GHz, Horn Antenna E444, 6dB pad-E1132, HP Preamp E376, ESI-1G-E1190. Preview RBW: 30kHz / 1M Formals. VBW: 1 MHz. 10dB internal Attenuation.
Date:	2018-06-06 20:24:53



**FORMAL DATA**

Freq. MHz	Raw dBuV	Cable dB	Factor dB	Level dBuV/m	Emission Type	Pol H/V	Ht cm	Az deg	Limit dBuV/m	Margin dB	Pass /Fail	Comments
2645.27	49.55	9.1	-5.05	53.6	Average	H	200	45	54	-0.4	Pass	
2660.54	49.06	9.12	-4.99	53.18	Average	H	100	295	54	-0.82	Pass	
2679.03	48.45	9.13	-4.93	52.65	Average	H	100	319	54	-1.35	Pass	
2645.27	66.29	9.1	-5.05	70.35	Peak	H	200	45	74	-3.65	Pass	
2679.03	63.75	9.13	-4.93	67.96	Peak	H	100	319	74	-6.04	Pass	
2660.54	63.12	9.12	-4.99	67.24	Peak	H	100	295	74	-6.76	Pass	
2949.12	35.7	9.4	-4.03	41.08	Average	V	303	182	54	-12.92	Pass	
4247.69	29.44	10.18	-0.95	38.67	Average	V	282	289	54	-15.33	Pass	
1088.7	34.01	8.69	-11.1	31.58	Average	V	113	85	54	-22.42	Pass	
4247.69	42.06	10.18	-0.95	51.29	Peak	V	282	289	74	-22.71	Pass	
2949.12	45.79	9.4	-4.03	51.17	Peak	V	303	182	74	-22.83	Pass	
1088.7	47.08	8.69	-11.1	44.65	Peak	V	113	85	74	-29.35	Pass	

**PREVIEW DATA**

Freq. MHz	Raw dBuV	Cable dB	Factor dB	Level dBuV/m	Emission Type	Pol H/V	Ht cm	Az deg	Limit dBuV/m	Margin dB	Pass /Fail	Comments
2679.03	55.35	9.13	-4.93	59.55	Preview	H	100	315	54	5.55	Fail	Tx exempt
2645.27	54.93	9.1	-5.05	58.98	Preview	H	200	45	54	4.98	Fail	Tx exempt
2660.54	51.59	9.12	-4.99	55.72	Preview	H	100	225	54	1.72	Fail	Tx exempt
2949.09	41.01	9.4	-4.03	46.38	Preview	V	100	180	54	-7.62	Pass	
4247.69	35.8	10.18	-0.95	45.03	Preview	V	390	90	54	-8.97	Pass	
1088.7	37.44	8.69	-11.1	35.01	Debug	V	100	317	54	-18.99	Pass	

Note: Preview data was measured using a peak detector to identify frequencies of interest for formal measurement. Formal data consist of all frequencies in the preview list within 6 dB of specification limit or the top six frequencies. Failure in preview data does not necessarily constitute failure in formal data.

T15 Radiated Emissions 4.5GHz -18GHz FCC B

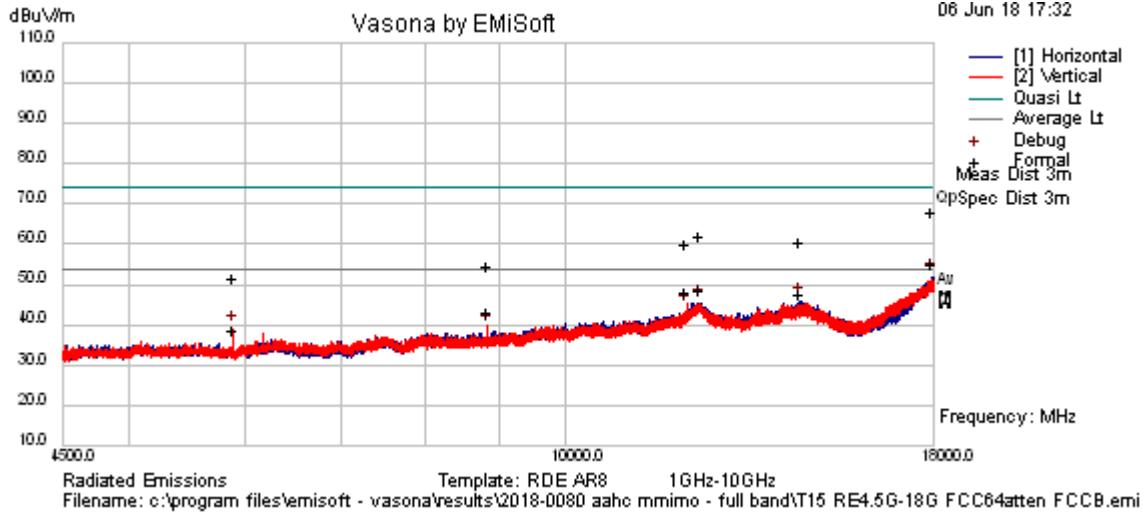

<b>Results Title:</b>	RDE AR8 4.5GHz-18GHz
<b>File Name:</b>	c:\program files\emisoft - vasona\results\2018-0080 aahe mmimo - full band\T15 RE4.5G-18G FCC64atten FCCB.emi
<b>Test Laboratory:</b>	AR8 MH GPCL 23C, 43% RH 1000mB
<b>Test Engineer:</b>	MJS
<b>Test Software:</b>	Vasona by EMISoft, version 2.161
<b>Equipment:</b>	Nokia
<b>EUT Details:</b>	2018-0080 60MHz Wide Band, AAHE mMIMO - Full Band, Powered by -48VDC, 20 Amps, Tx-2640MHz, 2660, 2680, all ETM3.2, 3C, 31.8dBm per port. All ports transmitting
<b>Configuration:</b>	Powered by -48VDC, 20 Amps, Tx-2593MHz, 256QAM, 1C, 28dBm per port. All ports transmitting. Radiated Emissions FCC Part 15, RE 4.5GHz-18GHz, Horn Antenna E444, HPF-E1208, HP Preamp E376, ESI-1G-E1190. Preview RBW: 30kHz / 1M Formals. VBW: 1 MHz . 0dB internal Attenuation.
<b>Date:</b>	2018-06-06 17:32:23

FORMAL DATA

Freq. MHz	Raw dBuV	Cable dB	Factor dB	Level dBuV/m	Emission Type	Pol H/V	Ht cm	Az deg	Limit dBuV/m	Margin dB	Pass /Fail	Comments
17986.3	21.21	13	17.22	51.43	Average	H	338	29	54	-2.57	Pass	
12420.4	27.48	9.41	7.72	44.62	Average	H	305	41	54	-9.38	Pass	
12134.8	27.17	9.35	7.81	44.34	Average	V	295	151	54	-9.66	Pass	
17986.3	33.78	13	17.22	64	Peak	H	338	29	74	-10	Pass	
14557.6	21.82	10.63	11.28	43.73	Average	H	307	80	54	-10.27	Pass	
8847.37	27.23	7.65	4.22	39.1	Average	V	242	238	54	-14.9	Pass	
12420.4	40.84	9.41	7.72	57.98	Peak	H	305	41	74	-16.02	Pass	
14557.6	34.88	10.63	11.28	56.8	Peak	H	307	80	74	-17.2	Pass	
12134.8	39.2	9.35	7.81	56.36	Peak	V	295	151	74	-17.64	Pass	
5898.25	27.84	5.85	1.34	35.04	Average	V	282	298	54	-18.96	Pass	
8847.37	38.82	7.65	4.22	50.7	Peak	V	242	238	74	-23.3	Pass	
5898.25	40.57	5.85	1.34	47.77	Peak	V	282	298	74	-26.23	Pass	

PREVIEW DATA

Freq. MHz	Raw dBuV	Cable dB	Factor dB	Level dBuV/m	Emission Type	Pol H/V	Ht cm	Az deg	Limit dBuV/m	Margin dB	Pass /Fail	Comments
17986.3	21.68	13	17.22	51.89	Preview	H	390	0	54	-2.11	Pass	
14557.6	24.04	10.63	11.28	45.96	Preview	H	100	315	54	-8.04	Pass	
12420.4	28.34	9.41	7.72	45.47	Preview	H	200	90	54	-8.53	Pass	
5898.04	31.66	5.85	1.34	38.86	Preview	V	190	135	54	-15.14	Pass	
8847.98	26.86	7.65	4.22	38.73	Debug	V	100	317	54	-15.27	Pass	
12134.8	26.56	9.35	7.81	43.73	Debug	V	100	317	54	-10.27	Pass	

Note: Preview data was measured using a peak detector to identify frequencies of interest for formal measurement. Formal data consist of all frequencies in the preview list within 6 dB of specification limit or the top six frequencies. Failure in preview data does not necessarily constitute failure in formal data.

T17 Radiated Emissions 18GHz-26.5GHz FCC Class B limits

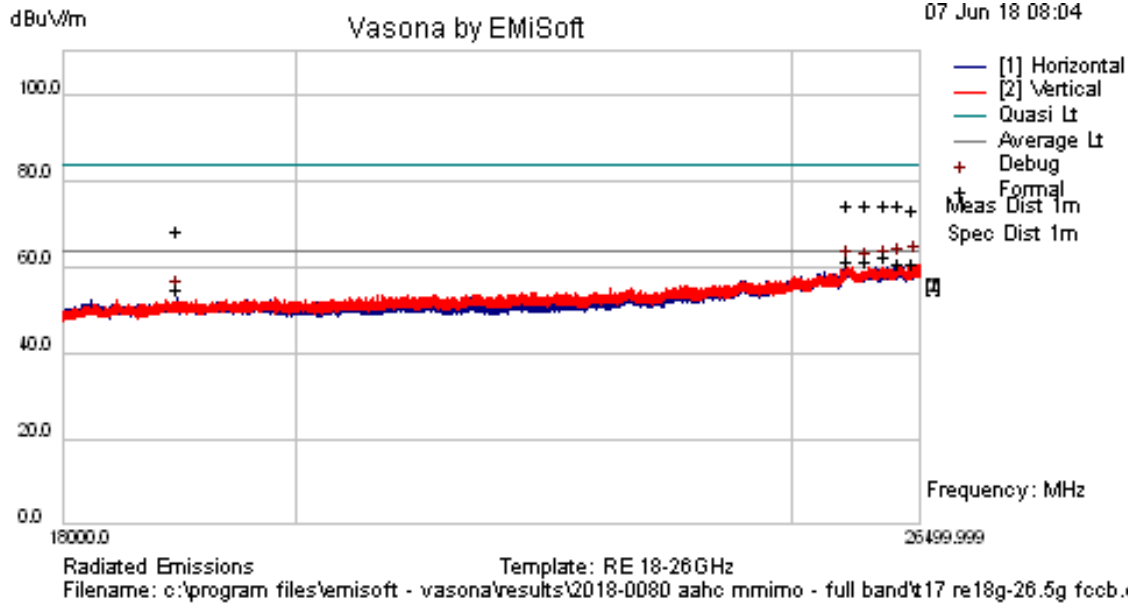

Results Title:	RE 18-26GHz
File Name:	c:\program files\emisoft - vasona\results\2018-0080 aahe mmimo - full band\t17 re18g-26.5g fccb.e
Test Laboratory:	AR8 MH GPCL 23C, 43% RH 1000mB
Test Engineer:	MJS
Test Software:	Vasona by EMIsoft, version 2.161
Equipment:	Nokia
EUT Details:	2018-0080 60MHz Wide Band, AAHE mMIMO - Full Band, Powered by -48VDC, 20 Amps, Tx-2640MHz, 2660, 2680, all ETM3.2, 3C, 31.8dBm per port. All ports transmitting
Configuration:	Powered by -48VDC, 20 Amps, Tx-2593MHz, 256QAM, 1C, 28dBm per port. All ports transmitting. Radiated Emissions FCC Part 15, RE 18GHz-26.5GHz, Horn Antenna E513, HP Preamp E376, ESI-1G-E1190. Preview RBW: 30kHz / 1M Formals. VBW: 1 MHz. 10dB internal Attenuation.
Date:	2018-06-07 08:04:34

FORMAL DATA

Freq. MHz	Raw dBuV	Cable dB	Factor dB	Level dBuV/m	Emission Type	Pol H/V	Ht cm	Az deg	Limit dBuV/m	Margin dB	Pass /Fail	Comments
26102.5	27.11	10.23	20.68	58.01	Average	H	120	226	63.5	-5.49	Pass	
25650.2	27.36	10.07	19.55	56.98	Average	H	141	211	63.5	-6.52	Pass	
25884.4	26.51	10.16	20.19	56.85	Average	V	119	154	63.5	-6.65	Pass	
26251.3	25.34	10.28	20.93	56.55	Average	V	139	65	63.5	-6.95	Pass	
26432.6	24.61	10.35	21.24	56.19	Average	V	131	197	63.5	-7.31	Pass	
18956.5	26.71	8.11	15.6	50.42	Average	H	105	251	63.5	-13.08	Pass	
26102.5	39.31	10.23	20.68	70.22	Peak	H	120	226	83.5	-13.28	Pass	
26251.3	38.82	10.28	20.93	70.04	Peak	V	139	65	83.5	-13.46	Pass	
25650.2	40.3	10.07	19.55	69.92	Peak	H	141	211	83.5	-13.58	Pass	
25884.4	39.55	10.16	20.19	69.89	Peak	V	119	154	83.5	-13.61	Pass	
26432.6	37.11	10.35	21.24	68.69	Peak	V	131	197	83.5	-14.81	Pass	
18956.5	40.43	8.11	15.6	64.14	Peak	H	105	251	83.5	-19.36	Pass	

PREVIEW DATA

Freq. MHz	Raw dBuV	Cable dB	Factor dB	Level dBuV/m	Emission Type	Pol H/V	Ht cm	Az deg	Limit dBuV/m	Margin dB	Pass /Fail	Comments
26435.2	28.98	10.35	21.24	60.56	Preview	V	250	88	63.5	-2.94	Pass	
26251.3	29.12	10.28	20.93	60.33	Debug	V	100	354	63.5	-3.17	Pass	
25650.2	30.21	10.07	19.55	59.83	Debug	H	100	354	63.5	-3.67	Pass	
26102.5	28.75	10.23	20.68	59.66	Debug	H	100	354	63.5	-3.84	Pass	
25884.4	28.92	10.16	20.19	59.26	Debug	V	100	354	63.5	-4.24	Pass	
18956.5	28.83	8.11	15.6	52.54	Debug	H	100	354	63.5	-10.96	Pass	

Note: Preview data was measured using a peak detector to identify frequencies of interest for formal measurement. Formal data consist of all frequencies in the preview list within 6 dB of specification limit or the top six frequencies. Failure in preview data does not necessarily constitute failure in formal data.

T17a Radiated Emissions 26.5G-30GHz FCC Class B limits

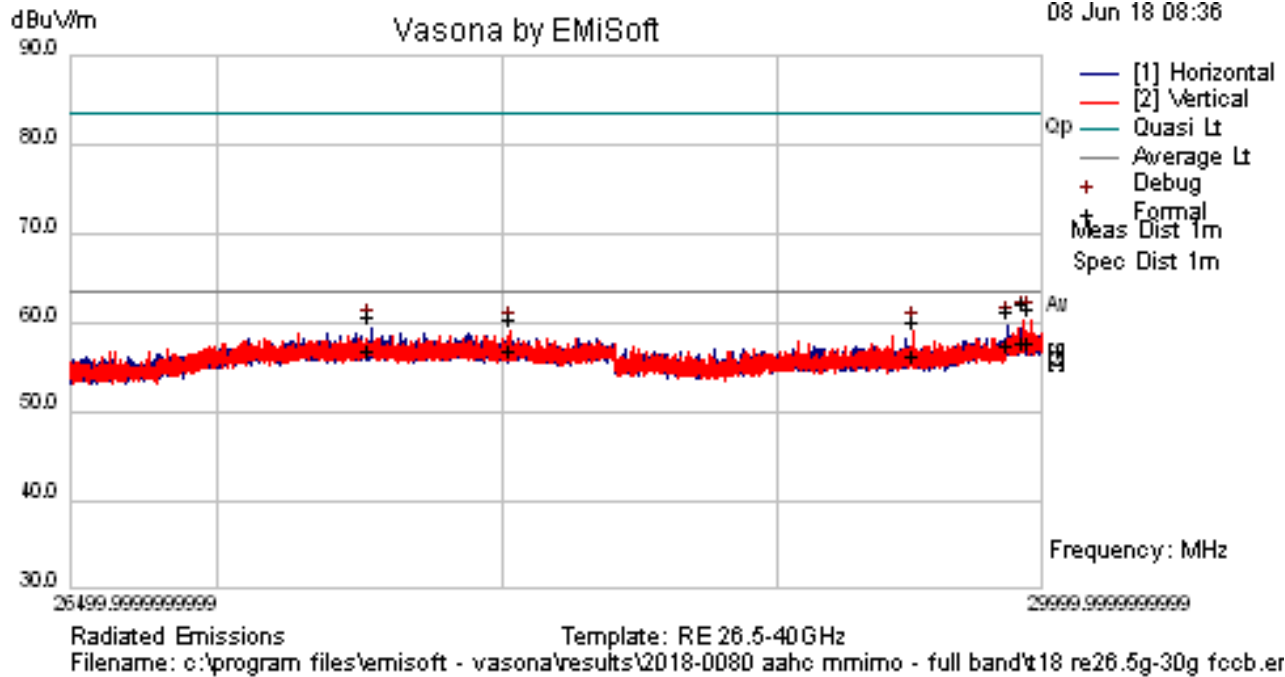

Results Title:	RE 26.5-30GHz
File Name:	c:\program files\emisoft - vasona\results\2018-0080 aahe mmimo - full band\t18 re26.5g-30g fccb.emi
Test Laboratory:	AR8 MH GPCL 23C, 43% RH 1000mB
Test Engineer:	MJS / JY
Test Software:	Vasona by EMISoft, version 2.161
Equipment:	Nokia
EUT Details:	2018-0080 60MHz Wide Band, AAHE mMIMO - Full Band, Powered by -48VDC, 20 Amps, Tx-2640MHz, 2660, 2680, all ETM3.2, 3C, 31.8dBm per port. All ports transmitting
Configuration:	Powered by -48VDC, 20 Amps, Tx-2593MHz, 256QAM, 1C, 28dBm per port. All ports transmitting. Radiated Emissions FCC Part 15, RE 26.5GHz-30GHz, Horn Antenna E526 ESU-E954. Preview RBW: 100kHz / 1M Formals. VBW: 1 MHz. 0dB internal Attenuation.
Date:	2018-06-08 08:36:21

FORMAL DATA

Freq. MHz	Raw dBuV	Cable dB	Factor dB	Level dBuV/m	Emission Type	Pol H/V	Ht cm	Az deg	Limit dBuV/m	Margin dB	Pass /Fail	Comments
29925.6	32.93	0	22.65	55.58	Average	V	198	342	63.5	-7.92	Pass	
29954.3	32.89	0	22.69	55.57	Average	V	209	332	63.5	-7.93	Pass	
29871.7	32.61	0	22.57	55.18	Average	H	124	255	63.5	-8.32	Pass	
27533.6	34.63	0	19.93	54.57	Average	H	175	273	63.5	-8.93	Pass	
28028.5	34.1	0	20.42	54.52	Average	V	173	160	63.5	-8.98	Pass	
29510	31.99	0	22.07	54.06	Average	V	212	72	63.5	-9.44	Pass	
29925.6	37.35	0	22.65	59.99	Peak	V	198	342	83.5	-23.51	Pass	
29954.3	36.48	0	22.69	59.17	Peak	V	209	332	83.5	-24.33	Pass	
29871.7	36.35	0	22.57	58.93	Peak	H	124	255	83.5	-24.57	Pass	
27533.6	38.52	0	19.93	58.46	Peak	H	175	273	83.5	-25.04	Pass	
28028.5	37.73	0	20.42	58.15	Peak	V	173	160	83.5	-25.35	Pass	
29510	35.78	0	22.07	57.86	Peak	V	212	72	83.5	-25.64	Pass	

PREVIEW DATA

Freq. MHz	Raw dBuV	Cable dB	Factor dB	Level dBuV/m	Emission Type	Pol H/V	Ht cm	Az deg	Limit dBuV/m	Margin dB	Pass /Fail	Comments
29925.6	37.54	0	22.65	60.19	Preview	V	125	154	63.5	-3.31	Pass	
29954.3	37.4	0	22.69	60.09	Debug	V	100	354	63.5	-3.41	Pass	
29510	36.98	0	22.07	59.05	Debug	V	100	354	63.5	-4.45	Pass	
28028.5	38.55	0	20.42	58.97	Debug	V	100	354	63.5	-4.53	Pass	
27533.6	39.31	0	19.93	59.24	Debug	H	100	354	63.5	-4.26	Pass	
29871.7	37.12	0	22.57	59.69	Debug	H	100	354	63.5	-3.81	Pass	

Note: Preview data was measured using a peak detector to identify frequencies of interest for formal measurement. Formal data consist of all frequencies in the preview list within 6 dB of specification limit or the top six frequencies. Failure in preview data does not necessarily constitute failure in formal data.

## 7. FCC Section 2.1055 Frequency Stability

### 7.1 Section 2.1055 Measurement of Frequency Stability

This measurement evaluates the frequency difference between the actual transmit carrier frequency and the specified transmit frequency assignment. Only the portion of the transmitter system containing the frequency determining and stabilizing circuitry need be put in an environmental chamber and subjected to the temperature variation test per FCC Section 2.1055 and RSS-133. The unit which provides baseband signals, such as BBU (baseband unit), can be located outside the chamber if it is a separated unit.

#### 7.1.1 Frequency Stability Test Article and Configuration

The unit under test is identified as follows: AirScale MAA 64T64R 128AE B41 120W AAHE , PN: 474658A.101, SN: 6Q181121986. - FCC ID: VBNAHE-01

#### 7.1.2 Frequency Stability Test

Frequency Stability Testing was performed on the Nokia AAHE AirScale MAA 64T64R 2600 B41 120W, PN: 474658A.101, SN: 6Q181121986., FCC ID: VBNAHE-01.

The testing was performed on the B41 AAHE from 05/30/2018 through 06/01/2018. The product was configured per Figure 6.1.2 and tested in the T-11 Thermal chamber of the GPCL test facility located in Bldg. 4, Room 4-280, Murray Hill, NJ. Testing was witnessed by Joe Bordonaro from GPCL. The UUT was subjected to a range of temperature from ambient to +50°C to -30°C and back to ambient. Frequency Stability performance was verified by measuring Frequency Tolerance at EAC using an MXA Signal Analyzer. Frequency Tolerance is a measurement of the difference between the actual transmit frequency and the assigned frequency (2660 MHz). The system level Frequency Stability testing of the UUT yielded results in compliance with established design criteria.

FIGURE 7.1.2 Frequency Stability Test Set-Up

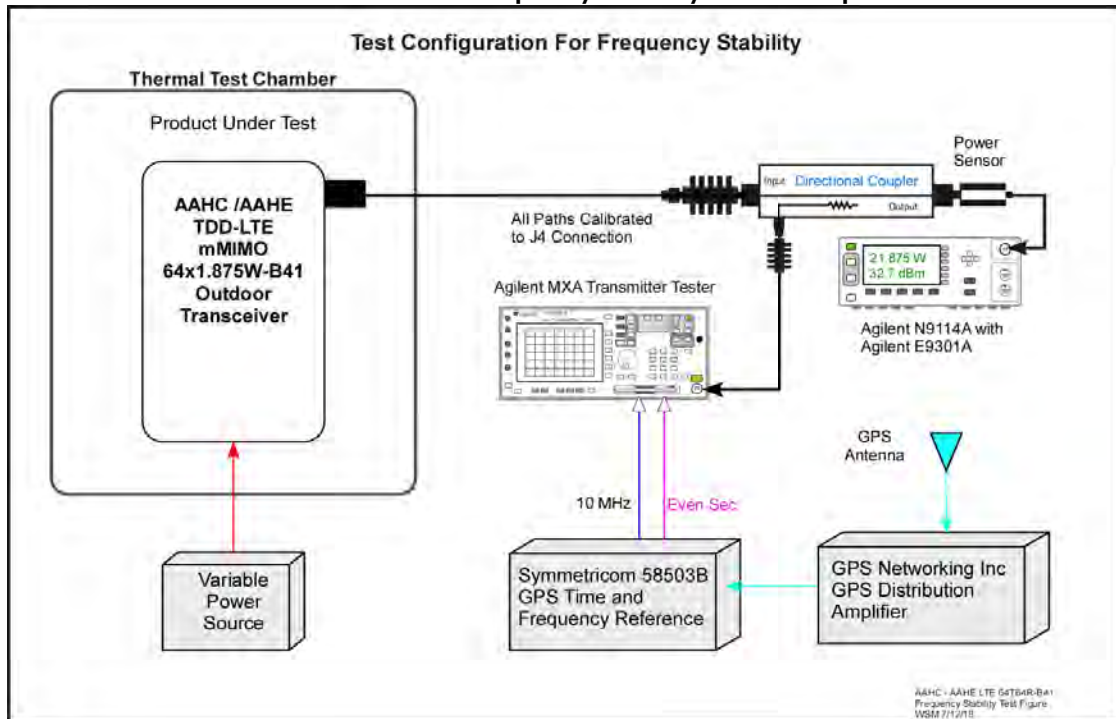



**7.1.3 Frequency Stability Test process**

- a) Set the power supply to nominal Voltage.
- b) Record the frequency at ~25°C.
- c) Raise EUT operating temperature to 50°C.
- d) Record the frequency difference.
- e) Repeat step d) at each 10°C step down to -30°C. Result will be 10 readings and take temperature readings to establish thermal stability at each point.

Upon return to +25°C.

- f) At ambient, vary voltage to +15% and -15% of nominal and record frequency difference. Result will be 12 readings for each voltage (nominal, ~+ 3%, ~+6%, ~+9%, ~+12%, +15%, and nominal, ~- 3%, ~-6%, ~-9%, ~-12%, -15%).

**7.1.4 Frequency Stability Results:**

The worst case Frequency Stability over temperature and voltage was **+9.848 Hz** which is **+0.0037 ppm**. This is within the +/- 0.05ppm desired performance required for LTE operation under 3GPP and FCC requirements.

**7.1.5 Frequency Stability Data:**

The frequency data below documents performance of the AAHE AirScale MAA 64T64R 128AE B41 120W RRH When operated at a center frequency of 2660 MHz.

Process Step:

1. (a)Set the power supply to nominal Voltage. (b) Record the frequency at ~25°C. (c)Raise EUT operating temperature to 50°C. (d)Record the frequency difference. (e) Repeat step (d) at each 10°C step down to -30°C. Result will be 10 readings and take temperature readings to establish thermal stability at each point.

Baseline Measurement at +25°C

<b>Transmit Frequency Deviation at +25°C at 100% of Nominal Voltage, -48VDC</b>	
Time (minutes)	Transmit Carrier Deviation (Hz)
0	1.007
0.5	2.147
1.0	3.124
1.5	0.947
2.0	1.901
2.5	9.527
3.0	6.322
FCC SPECIFICATION	±2660 MHz (±0.05ppm) ±0.05ppm = ±133 Hz
FCC RESULT	PASS

<b>Transmit Frequency Deviation at +50°C at 100% of Nominal Voltage, -48VDC</b>	
Time (minutes)	Transmit Carrier Deviation (Hz)
0	6.481
0.5	1.955
1.0	5.293
1.5	1.631
2.0	2.088
2.5	3.546
3.0	2.644
FCC SPECIFICATION	±2660 MHz (±0.05ppm) ±0.05ppm = ±133 Hz
FCC RESULT	PASS

<b>Transmit Frequency Deviation at +40°C at 100% of Nominal Voltage, -48VDC</b>	
Time (minutes)	Transmit Carrier Deviation (Hz)
0	6.904
0.5	1.417
1.0	2.015
1.5	4.912
2.0	5.805
2.5	1.909
3.0	1.899
FCC SPECIFICATION	±2660 MHz (±0.05ppm) ±0.05ppm = ±133 Hz
FCC RESULT	PASS

<b>Transmit Frequency Deviation at +30°C at 100% of Nominal Voltage, -48VDC</b>	
Time (minutes)	Transmit Carrier Deviation (Hz)
0	8.785
0.5	-2.145
1.0	2.042
1.5	3.926
2.0	1.057
2.5	2.244
3.0	3.816
FCC SPECIFICATION	±2660 MHz (±0.05ppm) ±0.05ppm = ±133 Hz
FCC RESULT	PASS

<b>Transmit Frequency Deviation at +20°C at 100% of Nominal Voltage, -48VDC</b>	
Time (minutes)	Transmit Carrier Deviation (Hz)
0	0.317
0.5	1.415
1.0	1.365
1.5	2.860
2.0	5.196
2.5	1.004
3.0	3.491
FCC SPECIFICATION	±2660 MHz (±0.05ppm) ±0.05ppm = ±133 Hz
FCC RESULT	PASS

<b>Transmit Frequency Deviation at +10°C at 100% of Nominal Voltage, -48VDC</b>	
Time (minutes)	Transmit Carrier Deviation (Hz)
0	1.538
0.5	4.086
1.0	0.645
1.5	5.605
2.0	1.405
2.5	7.069
3.0	3.726
FCC SPECIFICATION	±2660 MHz (±0.05ppm) ±0.05ppm = ±133 Hz
FCC RESULT	PASS

<b>Transmit Frequency Deviation at 0°C at 100% of Nominal Voltage, -48VDC</b>	
Time (minutes)	Transmit Carrier Deviation (Hz)
0	3.366
0.5	8.544
1.0	3.062
1.5	1.104
2.0	7.008
2.5	4.726
3.0	0.798
FCC SPECIFICATION	±2660 MHz (±0.05ppm) ±0.05ppm = ±133 Hz
FCC RESULT	PASS

<b>Transmit Frequency Deviation at -10°C at 100% of Nominal Voltage, -48VDC</b>	
Time (minutes)	Transmit Carrier Deviation (Hz)
0	1.389
0.5	0.556
1.0	7.021
1.5	0.990
2.0	1.441
2.5	6.253
3.0	2.706
FCC SPECIFICATION	±2660 MHz (±0.05ppm) ±0.05ppm = ±133 Hz
FCC RESULT	PASS

<b>Transmit Frequency Deviation at -20°C at 100% of Nominal Voltage, -48VDC</b>	
Time (minutes)	Transmit Carrier Deviation (Hz)
0	9.358
0.5	4.682
1.0	8.814
1.5	4.295
2.0	1.936
2.5	2.804
3.0	0.921
FCC SPECIFICATION	±2660 MHz (±0.05ppm) ±0.05ppm = ±133 Hz
FCC RESULT	PASS

<b>Transmit Frequency Deviation at -30°C at 100% of Nominal Voltage, -48VDC</b>	
Time (minutes)	Transmit Carrier Deviation (Hz)
0	1.093
0.5	1.066
1.0	5.820
1.5	2.997
2.0	0.896
2.5	2.211
3.0	1.576
FCC SPECIFICATION	±2660 MHz (±0.05ppm) ±0.05ppm = ±133 Hz
FCC RESULT	PASS

Upon return to +25°C.

1. At ambient, vary voltage to +15% and -15% of nominal and record frequency difference. Result will be 12 readings for each voltage (nominal, ~+ 3%, ~+6%, ~+9%, ~+12%, +15%, and nominal, ~- 3%, ~-6%, ~-9%, ~-12%, -15%).

<b>Transmit Frequency Deviation at +25°C at 100% of Nominal Voltage, -48VDC</b>	
Time (minutes)	Transmit Carrier Deviation (Hz)
0	4.326
0.5	3.131
1.0	9.157
1.5	1.139
2.0	1.746
2.5	5.143
3.0	8.120
FCC SPECIFICATION	±2660 MHz (±0.05ppm) ±0.05ppm = ±133 Hz
FCC RESULT	PASS

<b>Transmit Frequency Deviation at +25°C at 103% of Nominal Voltage, -49.44VDC</b>	
Time (minutes)	Transmit Carrier Deviation (Hz)
0	3.112
0.5	9.763
1.0	2.194
1.5	3.096
2.0	5.449
2.5	8.343
3.0	1.038
FCC SPECIFICATION	±2660 MHz (±0.05ppm) ±0.05ppm = ±133 Hz
FCC RESULT	PASS

<b>Transmit Frequency Deviation at +25°C at 106% of Nominal Voltage, -50.88VDC</b>	
Time (minutes)	Transmit Carrier Deviation (Hz)
0	5.213
0.5	4.137
1.0	6.821
1.5	1.697
2.0	2.200
2.5	4.097
3.0	3.662
FCC SPECIFICATION	±2660 MHz (±0.05ppm) ±0.05ppm = ±133 Hz
FCC RESULT	PASS

<b>Transmit Frequency Deviation at +25°C at 109% of Nominal Voltage, -52.32VDC</b>	
Time (minutes)	Transmit Carrier Deviation (Hz)
0	5.072
0.5	1.836
1.0	3.334
1.5	4.027
2.0	2.628
2.5	3.992
3.0	1.757
FCC SPECIFICATION	±2660 MHz (±0.05ppm) ±0.05ppm = ±133 Hz
FCC RESULT	PASS

<b>Transmit Frequency Deviation at +25°C at 112% of Nominal Voltage, -53.76VDC</b>	
Time (minutes)	Transmit Carrier Deviation (Hz)
0	5.567
0.5	3.555
1.0	7.082
1.5	2.460
2.0	3.713
2.5	1.455
3.0	1.946
FCC SPECIFICATION	±2660 MHz (±0.05ppm) ±0.05ppm = ±133 Hz
FCC RESULT	PASS

<b>Transmit Frequency Deviation at +25°C at 115% of Nominal Voltage, -55.20VDC</b>	
Time (minutes)	Transmit Carrier Deviation (Hz)
0	3.549
0.5	1.806
1.0	2.542
1.5	5.395
2.0	1.806
2.5	3.404
3.0	3.358
FCC SPECIFICATION	±2660 MHz (±0.05ppm) ±0.05ppm = ±133 Hz
FCC RESULT	PASS



<b>Transmit Frequency Deviation at +25°C at 100% of Nominal Voltage, -48.0VDC</b>	
Time (minutes)	Transmit Carrier Deviation (Hz)
0	3.670
0.5	1.322
1.0	4.047
1.5	5.903
2.0	6.180
2.5	1.937
3.0	7.931
FCC SPECIFICATION	±2660 MHz (±0.05ppm) ±0.05ppm = ±133 Hz
FCC RESULT	PASS

<b>Transmit Frequency Deviation at +25°C at -3% of Nominal Voltage, -46.56VDC</b>	
Time (minutes)	Transmit Carrier Deviation (Hz)
0	2.407
0.5	8.165
1.0	9.848
1.5	1.466
2.0	3.417
2.5	3.913
3.0	1.725
FCC SPECIFICATION	±2660 MHz (±0.05ppm) ±0.05ppm = ±133 Hz
FCC RESULT	PASS

<b>Transmit Frequency Deviation at +25°C at -6% of Nominal Voltage, -45.12VDC</b>	
Time (minutes)	Transmit Carrier Deviation (Hz)
0	3.482
0.5	5.644
1.0	1.170
1.5	7.234
2.0	2.682
2.5	5.189
3.0	2.887
FCC SPECIFICATION	±2660 MHz (±0.05ppm) ±0.05ppm = ±133 Hz
FCC RESULT	PASS

<b>Transmit Frequency Deviation at +25°C at -9% of Nominal Voltage, -43.68VDC</b>	
Time (minutes)	Transmit Carrier Deviation (Hz)
0	4.621
0.5	1.509
1.0	7.805
1.5	1.462
2.0	3.727
2.5	1.907
3.0	1.321
FCC SPECIFICATION	±2660 MHz (±0.05ppm) ±0.05ppm = ±133 Hz
FCC RESULT	PASS

<b>Transmit Frequency Deviation at +25°C at -12% of Nominal Voltage, -42.24VDC</b>	
Time (minutes)	Transmit Carrier Deviation (Hz)
0	8.291
0.5	2.510
1.0	4.556
1.5	1.377
2.0	6.528
2.5	1.482
3.0	1.455
FCC SPECIFICATION	±2660 MHz (±0.05ppm) ±0.05ppm = ±133 Hz
FCC RESULT	PASS

<b>Transmit Frequency Deviation at +25°C at -15% of Nominal Voltage, -40.80VDC</b>	
Time (minutes)	Transmit Carrier Deviation (Hz)
0	4.926
0.5	2.817
1.0	5.991
1.5	2.097
2.0	3.682
2.5	1.691
3.0	4.370
FCC SPECIFICATION	±2660 MHz (±0.05ppm) ±0.05ppm = ±133 Hz
FCC RESULT	PASS

## 8. Test Equipment and Test Set-up Photographs

### 8.1 Test Set-up Photographs

The Test Setup photographs are supplied in the filing documents as a separate exhibit

### 8.2 Antenna Port Test Equipment

The following Test Equipment was used to perform Antenna Port testing.

Manufacturer	Type	Description	Model	Serial	Calibration Date	Calibration Due	Calibration Type	Status
Agilent Technologies	MXA Signal Analyzer	20Hz-26.5GHz	N9020A	MY48011791	2018-02-15	2020-02-15	Requires Calibration	Active
Hewlett Packard	High Pass Filter	3.5 GHz	84300-80038	006			Calibration Not Required, Must Be Verified	Active
Weinschel	Attenuator	10dB 25Watt 0.05GHz - 26GHz	74-10-12	1068			Calibration Not Required, Must Be Verified	Active
Weinschel	Attenuator	30dB 25W 0.05GHz-26GHz	74-30-12	1065			Calibration Not Required, Must Be Verified	Active

### 8.3 Radiated Emissions Test Equipment

The following Test Equipment was used to perform Radiated Emissions testing

Manufacturer	Type	Description	Model	Serial	Calibration Date	Calibration Due	Calibration Type	Status
ETS Lindgren	Horn Antenna	Double-Ridged Waveguide Horn 1-18 GHz	3117	00135198	2017-06-09	2019-06-09	Requires Calibration	Active
ETS Lindgren	Multi-Device Controller		2090	00078509			Calibration Not Required	Active
Hewlett Packard	HP-IB Extender		37204	3212U31136			Calibration Not Required	Active
Hewlett Packard	HP-IB Extender		37204A	3212U27554			Calibration Not Required	Active
Hewlett Packard	Pre-Amplifier	Preamplifier 1-26.5 GHz	8449B	3008A01270	2018-01-17	2019-01-17	Requires Calibration	Active
RLC Electronics Inc	High Pass Filter	2.5GHz to 26GHz High Pass Filter	F-19391	1440-001			Calibration Not Required, Must Be Verified	Active
A.H. Systems Inc.	Horn Antenna	Ridged Horn 26.5 GHz - 40 GHz	SAS-200/573	137	2017-10-04	2019-10-04	Requires Calibration	Active
EMC Test Systems	Horn Antenna	Double Ridged Horn 18-40 GHz	3116	2539	2017-06-16	2019-06-16	Requires Calibration	Active
EMCO	Biconical Antenna		3109	2187	2016-12-01	2018-12-01	Requires Calibration	Active
EMCO	Log Periodic Antenna		3146	2082	2017-05-24	2019-05-24	Requires Calibration	Active
Rohde & Schwarz	Test Receiver	EMI (20Hz to 40 GHz)-150 +30dBm	ESIB40	100119	2017-11-06	2019-11-06	Requires Calibration	Active
Sonoma Instrument Co.	Amplifier	9kHz-1GHz	310N	186750	2016-07-27	2018-07-27	Requires Calibration	Active
Weinschel	Attenuator	6dB	2/6	CD2545	2017-03-03	2019-03-03	Requires Calibration	Active

## 8.4 Frequency Stability Test Equipment

The following Test Equipment was used to perform Frequency Stability testing.

Manufacturer	Instrument Type	Model	Serial Number	Cal Date	Cal Due Date
Agilent	MXA Signal Analyzer	N9020A	MY49060086	12/07/2016	12/07/2018
Agilent	Power Meter	E4419B	MY40511034	01/10/2018	01/10/2020
Agilent	Power Sensor	E9301A	MY52280001	02/08/2017	02/08/2019
Agilent	MY52280001	E9301A	MY52280011	02/08/2017	02/08/2019
Hewlett Packard	Multimeter	HP 971A	JP35001820	06/08/2017	06/08/2019
Yokogawa	Thermal Logger	MV2000	12W942552	06/02/2017	06/02/2019
Symmetricon	GPS Receiver	58503B	KR93200773	No Cal Req.	No Cal Req.
TDK-Lambda	Power supply	GEN60-85-3P208	13N5112J	No Cal Req.	No Cal Req.

## 9. NVLAP Certificate of Accreditation

