



# TEST REPORT

**FCC-ID:VBA-EF26ULWFO, IC: 7098A-EF26ULWFO**  
For

Ningbo EverFlourish Smart Technology Corp., Ltd

WI-FI Smart Socket

Model No. : 26UL-WFO, MTS5401

Trade Name : Everflourish, MYTS, GE

Prepared for : Ningbo EverFlourish Smart Technology Corp., Ltd  
Address : 77 Wuxiang East Road, Yinzhou, Ningbo, 315111, China

Prepared by : Shenzhen Alpha Product Testing Co., Ltd.  
Address : Building i, No.2, Lixin Road, Fuyong Street, Bao'an District, Shenzhen,  
: Guangdong, China

Report No. : T1881075 03

Date of Receipt : July 11, 2018

Date of Test : July 11, 2018 - July 17, 2018

Date of Report : July 17, 2018

Version Number : REV0

## TABLE OF CONTENT

Description	Page
1.1 Description of Device (EUT) -----	5
1.2 Description of Test Facility -----	5
<b>2 EMC Equipment List-----</b>	<b>6</b>
<b>3 Test Procedure-----</b>	<b>7</b>
<b>4 Summary of Measurement-----</b>	<b>8</b>
4.1 Summary of test result -----	8
4.2 Test connection -----	8
4.3 Assistant equipment used for test -----	9
4.4 Test mode -----	9
4.5 Channel list-----	9
4.6 Test Conditions -----	9
4.7 Measurement Uncertainty (95% confidence levels, k=2) -----	10
<b>5 Spurious Emission-----</b>	<b>11</b>
5.1 Radiation Emission -----	11
5.1.1 Radiation Emission Limits(15.209) & RSS-247 Section 5.5 -----	11
5.1.2 Test Setup-----	11
5.1.3 Test Procedure-----	13
5.1.4 Test Equipment Setting For emission test Result -----	14
5.1.5 Test Condition -----	14
5.1.6 Test Result-----	14
<b>6 POWER LINE CONDUCTED EMISSION -----</b>	<b>26</b>
6.1 Conducted Emission Limits(15.207) & IC RSS Gen -----	26
6.2 Test Setup-----	26
6.3 Test Procedure-----	27
6.4 Test Results -----	27
<b>7 Band Edge Check -----</b>	<b>30</b>
7.1 Test limit-----	30
7.2 Test Procedure-----	30
7.3 Test Setup-----	30
7.4 Test Result-----	30
<b>8 Test setup photo-----</b>	<b>37</b>
8.1 Photos of Radiated emission -----	37
8.2 Photos of Conducted Emission test-----	38
<b>9 Photographs of EUT-----</b>	<b>39</b>



**Revision History**

Revision	Issue Date	Revisions	Revised By
00	July 17,2018	Initial released Issue	Simple Guan

# 1 General Information

## 1.1 Description of Device (EUT)

Trade Name : Everflourish, MYTS, GE  
EUT : WI-FI Smart Socket

Model No. : 26UL-WFO, MTS5401  
DIFF. : Only the Model No. difference between these products, this report test model is 26UL-WFO.

Antenna Type : Integrated antenna :2dBi

Operation : IEEE 802.11b/g: 2412MHz-2462MHz  
Frequency : IEEE 802.11n HT20: 2412MHz-2462MHz  
Channel number : IEEE 802.11b/g:11Channels  
: IEEE 802.11n HT20: 11 Channels  
: IEEE 802.11b: DSSS(CCK,DQPSK,DBPSK)

Modulation type : IEEE 802.11g: OFDM(64QAM, 16QAM, QPSK, BPSK)  
: IEEE 802.11n :OFDM(64QAM, 16QAM, QPSK, BPSK)

Power Supply : AC 120V/60Hz  
Ratings: : 125V~ 60Hz

Hardware Version : /  
Software Version : /

## 1.2 Description of Test Facility

Shenzhen Alpha Product Testing Co., Ltd.  
Building i, No.2, Lixin Road, Fuyong Street, Bao'an District,  
518103, Shenzhen, Guangdong, China

June 21, 2018 File on Federal Communication Commission  
Registration Number: 293961

July 25, 2017 Certificated by IC  
Registration Number: 12135A

## 2 EMC Equipment List

Equipment	Manufacturer	Model No.	Serial No.	Cal. Date	Due to day
Bilog Antenna	SCHWARZBECK	VULB 9168	9168-438	2016.09.30	2018.09.29
Test Receiver	ROHDE&SCHWARZ	ESCI	101165	2017.09.22	2018.09.21
Spectrum analyzer	Agilent	E4407B	MY49510055	2017.09.22	2018.09.21
Horn Antenna	SCHWARZBECK	BBHA 9120 D	BBHA 9120 D(1201)	2016.09.30	2018.09.29
Filter	KANGMAI	ZLPF-LDC- 1000-1959	1209002075	2017.09.22	2018.09.21
Filter	WAINWRIGHT	WHKX2.80 /18 G- 12SS	SN1	2017.09.22	2018.09.21
RF Cable	Resenberger	Cable 4	N/A	2017.09.22	2018.09.21
CMU200	ROHDE&SCHWARZ	CMU200	116785	2017.09.22	2018.09.21
Signal Analyzer	Agilent	N9020A	MY499100060	2017.09.22	2018.09.21
vector Signal Generator	Agilent	N5182A	MY49060042	2017.09.22	2018.09.21
vector Signal Generator	Agilent	E4438C	US44271917	2017.09.22	2018.09.21
Amplifier	HP	HP8347A	2834A00455	2017.09.22	2018.09.21
Amplifier	Teseq	LNA6901	72718	2017.09.22	2018.09.21
Amplifier	Agilent	8449B	3008A02664	2017.09.22	2018.09.21
Filter	WAINWRIGHT	WHKX1.0G /15G- 10SS	SN40	2017.09.22	2018.09.21
Test Receiver	ROHDE&SCHWARZ	ESR	1316.3003K03- 102082-Wa	2017.09.22	2018.09.21
Bilog Antenna	SCHWARZBECK	VULB 9168	9168-438	2017.09.22	2018.09.21
9*6*6 anechoic chamber	CHENYU	9*6*6	N/A	2016.7.21	2020.7.20
RF Cable	Resenberger	Cable 1	N/A	2017.09.22	2018.09.21
RF Cable	Resenberger	Cable 2	N/A	2017.09.22	2018.09.21
RF Cable	Resenberger	Cable 3	N/A	2017.09.22	2018.09.21
Power Sensor	Power Radio	RPR3006W	15100041SNO91	2017.09.22	2018.09.21
Power Sensor	Power Radio	RPR3006W	15100041SNO92	2017.09.22	2018.09.21
L.I.S.N.	SCHWARZBECK	NSLK8126	8126-466	2017.09.22	2018.09.21
L.I.S.N.	ROHDE&SCHWARZ	ENV216	101043	2017.09.22	2018.09.21
20dB Attenuator	ICPROBING	IATS1	82347	2017.09.22	2018.09.21

### 3 Test Procedure

**POWER LINE CONDUCTED INTERFERENCE:** The test procedure used was ANSI Standard ANSI C63.10:2013 using a 50 u H LISN. Both Lines were observed. The bandwidth of the receiver was 10kHz with an appropriate sweep speed. The ambient temperature of the EUT was 25°C with a humidity of 58%.

**RADIATION INTERFERENCE:** The test procedure used was ANSI Standard ANSI C63.10:2013 using a ANRITSU spectrum analyzer with a pre-selector. The analyzer was calibrated in dB above a micro volt at the output of the antenna. The resolution bandwidth was 100kHz and the video bandwidth was 300 kHz up to 1 GHz and 1 MHz with a video BW of 3MHz above 1 GHz. The ambient temperature of the EUT was 25°C with a humidity of 58%.

**FORMULA OF CONVERSION FACTORS:** The Field Strength at 3m was established by adding the meter reading of the spectrum analyzer (which is set to read in units of dBuV) to the antenna correction factor supplied by the antenna manufacturer and cable loss. The antenna correction factors and cable loss are stated in terms of dB. The gain of the Pre-selector was accounted for in the Spectrum Analyzer Meter Reading.

Example:

Freq (MHz) METER READING + ACF + CABLE = FS

33.20 dBuV + 10.36 dB + 0.9 dB= 44.46 dBuV/m @ 3m

**ANSI STANDARD ANSI C63.10:2013 10.1.7 MEASUREMENT PROCEDURES:** The EUT was placed on a table 80 cm high and with dimensions of 1m by 1.5m. The EUT was placed in the center of the table (1.5m side). The table used for radiated measurements is capable of continuous rotation. When an emission was found, the table was rotated to produce the maximum signal strength. At this point, the antenna was raised and lowered from 1m to 4m. The antenna was placed in both the horizontal and vertical planes. The situation was similar for the conducted measurement except that the table did not rotate. The EUT was setup as described in ANSI Standard ANSI C63.10:2013 10.1.7 with the EUT 40 cm from the vertical ground wall.

## 4 Summary of Measurement

### 4.1 Summary of test result

Test Item	Test Requirement	Standards Paragraph	Result
Spurious Emission	FCC PART 15 : 2016 & IC RSS-247	Section 15.247&15.209 & RSS-247 Section 5.5	Compliance
Conduction Emission	FCC PART 15 : 2016 & IC RSS Gen	Section 15.207 &7.2.4	Compliance
Band Edge	FCC PART 15 : 2016 & IC RSS-247	Section 15.247 & Section 5.5 RSS-247 ISSUE 2	Compliance

Note 1: This report due to Class II change if FCC-ID and IC, the only change is PCB Layout (not contains with RF module)

Note 2: The EUT has been tested as an independent unit, and continual transmitting in maximum power.

### 4.2 Test connection





### 4.3 Assistant equipment used for test

Description	:	Lamp
Manufacturer	:	N/A
Model No.	:	N/A

### 4.4 Test mode

Dutycycle :100%			
Keeping TX			
Mode	data rate (Mbps)(see Note)	Channel	Frequency (MHz)
IEEE 802.11b	1	Low :CH1	2412
	1	Middle: CH6	2437
	1	High: CH11	2462
IEEE 802.11g	6	Low :CH1	2412
	6	Middle: CH6	2437
	6	High: CH11	2462
IEEE 802.11 n/HT20	6.5	Low :CH1	2412
	6.5	Middle: CH6	2437
	6.5	High: CH11	2462
Note: According exploratory test, EUT will have maximum output power in those data rate. so those data rate were used for all test.			

### 4.5 Channel list

For IEEE 802.11b/g and IEEE 802.11n/HT20 with 2.4G					
Channel	Frequency (MHz)	Channel	Frequency (MHz)	Channel	Frequency (MHz)
CH1	2412	CH5	2432	CH9	2452
CH2	2417	CH6	2437	CH10	2457
CH3	2422	CH7	2442	CH11	2462
CH4	2427	CH8	2447		

### 4.6 Test Conditions

Temperature range	21-25°C
Humidity range	40-75%
Pressure range	86-106kPa

## 4.7 Measurement Uncertainty (95% confidence levels, k=2)

Item	MU	Remark
Uncertainty for Power point Conducted Emissions Test	2.74dB	
Uncertainty for Radiation Emission test in 3m chamber (30MHz to 1GHz)	3.77dB	Polarize: V
	3.80dB	Polarize: H
Uncertainty for Radiation Emission test in 3m chamber (1GHz to 25GHz)	4.16dB	Polarize: H
	4.13dB	Polarize: V
Uncertainty for radio frequency	$5.4 \times 10^{-8}$	
Uncertainty for conducted RF Power	0.37dB	
Uncertainty for temperature	0.2°C	
Uncertainty for humidity	1%	
Uncertainty for DC and low frequency voltages	0.06%	

## 5 Spurious Emission

### 5.1 Radiation Emission

#### 5.1.1 Radiation Emission Limits(15.209) & RSS-247 Section 5.5

Frequencies (MHz)	Field Strength (micovolts/meter)	Measurement Distance (meters)
0.009~0.490	2400/F(KHz)	300
0.490~1.705	24000/F(KHz)	30
1.705~30.0	30	30
30~88	100	3
88~216	150	3
216~960	200	3
Above 960	500	3

Harmonic emissions limits comply with below 54 dBuV/m at 3m. Other emissions radiated outside of the specified frequency bands, except for harmonics, shall be attenuated by at least 50 dB below the level of the fundamental or comply with the radiated emissions limits specified in section 15.209(a) limit in the table below has to be followed.

**NOTE:**

- a) The tighter limit applies at the band edges.
- b) Emission Level(dB uV/m)=20log Emission Level(Uv/m)

#### 5.1.2 Test Setup

See the next page

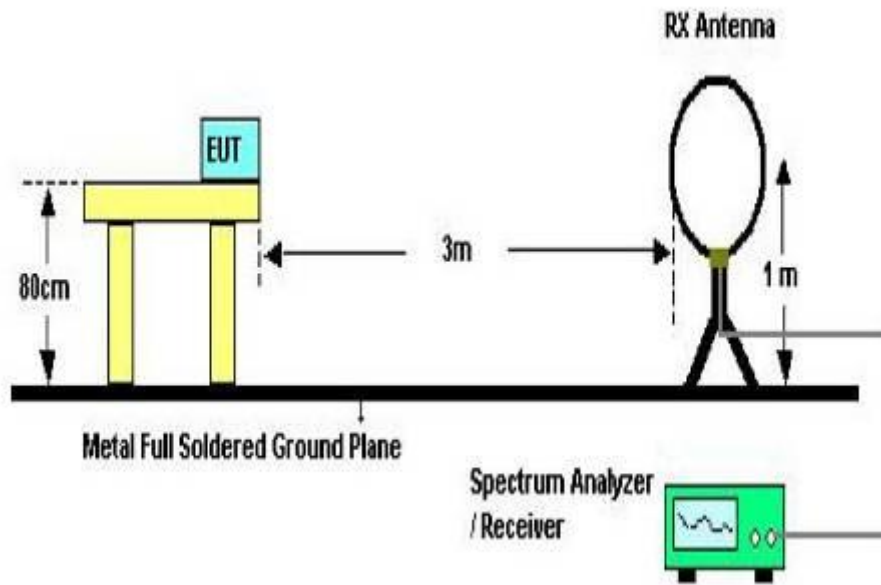

Below 30MHz Test Setup

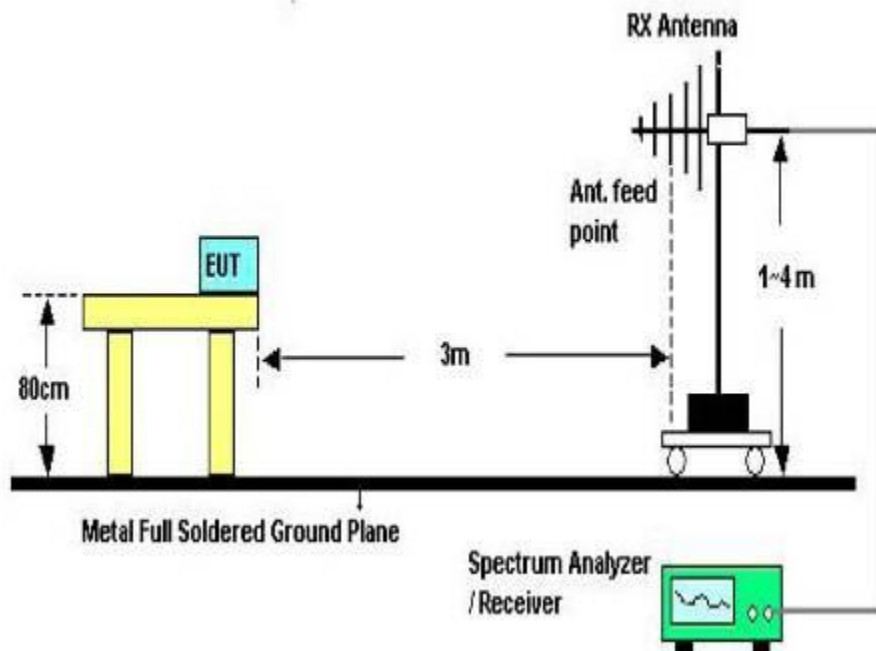

Above 30MHz Test Setup

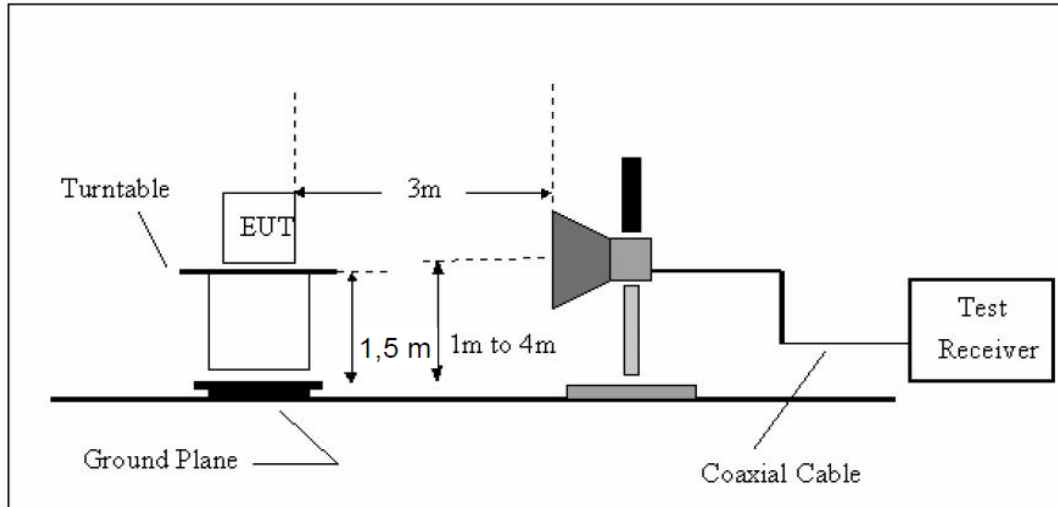

Above 1GHz Test Setup

### 5.1.3 Test Procedure

- a) The measuring distance of 3m shall be used for measurements at frequency up to 1GHz and above 1GHz, The EUT was placed on a rotating 0.8 m high above ground, The table was rotated 360 degrees to determine the position of the highest radiation
- b) The Test antenna shall vary between 1m and 4m, Both Horizontal and Vertical antenna are set of make measurement.
- c) The initial step in collecting conducted emission data is a spectrum analyzer Peak detector mode pre-scanning the measurement frequency range. Significant Peaks are then marked. and then Qusia Peak Detector mode premeasured
- d) If Peak value comply with QP limit Below 1GHz. The EUT deemed to comply with QP limit. But the Peak value and average value both need to comply with applicable limit above 1GHz.
- e) For the actual test configuration, please see the test setup photo.

#### 5.1.4 Test Equipment Setting For emission test Result

9KHz~150KHz	RBW 200Hz	VBW1KHz
150KHz~30MHz	RBW 9KHz	VBW 30KHz
30MHz~1GHz	RBW 120KHz	VBW 300KHz
Above 1GHz	RBW 1MHz	VBW 3MHz

#### 5.1.5 Test Condition

Continual Transmitting in maximum power.

#### 5.1.6 Test Result

We have scanned the 9KHz from 25GHz to the EUT.  
Detailed information please see the following page.

From 9KHz to 30MHz:      Conclusion: PASS

Note: The amplitude of spurious emissions which are attenuated by more than 20dB below the permissible value has no need to be reported.

Site LAB  
 Limit: FCC Part15 Class B Radiation  
 EUT: WIFI Smart Socket  
 M/N: 26UL-WFO  
 Mode: TX B 2412MHz  
 Note:  
 Engineer Signature:

Polarization: **Horizontal**  
 Power: AC 120V/60Hz  
 Distance: 3m

Temperature: 23.9  
 Humidity: 46 %

**Radiated Emission Measurement**

File :WIFI Smart Socket 26UL-W Data :#3 Date: 2018/7/12 Time: 16:52:47

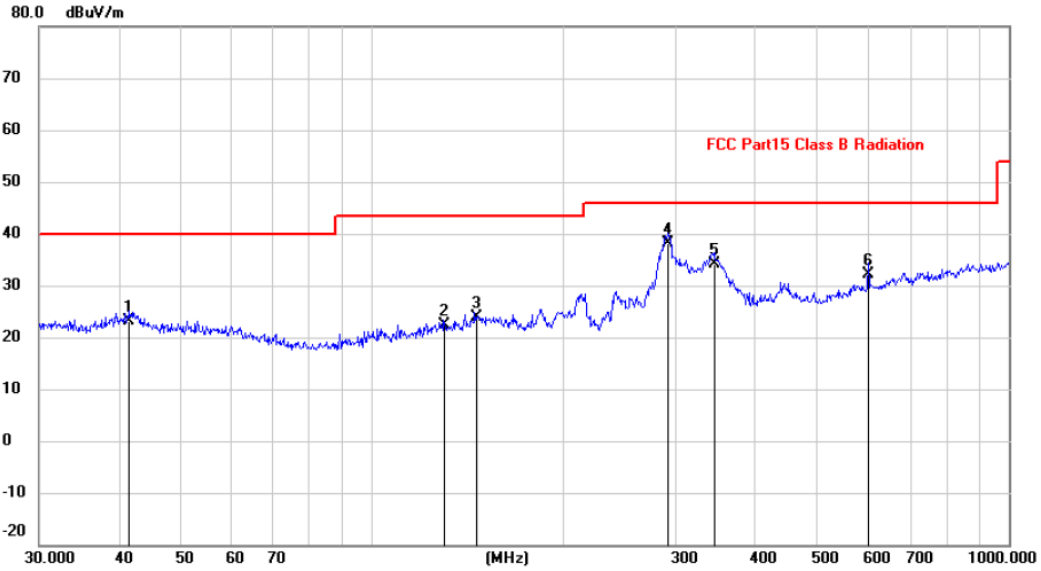

No.	Mk.	Freq.	Reading Level	Correct Factor	Measurement	Limit	Margin	Antenna Height	Table Degree	
		MHz	dBuV	dB	dBuV/m	dBuV/m	dB	cm	degree	Comment
1		41.5670	8.89	14.12	23.01	40.00	-16.99	QP		
2		129.9226	9.17	13.23	22.40	43.50	-21.10	QP		
3		145.3506	9.63	14.22	23.85	43.50	-19.65	QP		
4	*	292.0583	24.82	13.20	38.02	46.00	-7.98	QP		
5		344.3855	19.82	14.43	34.25	46.00	-11.75	QP		
6		601.4265	12.60	19.41	32.01	46.00	-13.99	QP		

Note:1. \*:Maximum data; x:Over limit; !:over margin.

2.Measurement=Reading Level+Correct Factor; Correct Factor=Antenna Factor+Cable Loss.

Site LAB  
 Limit: FCC Part15 Class B Radiation  
 EUT: WIFI Smart Socket  
 M/N: 26UL-WFO  
 Mode: TX B 2412MHz  
 Note:  
 Engineer Signature:

Polarization: *Vertical*  
 Power: AC 120V/60Hz  
 Distance: 3m

Temperature: 23.9  
 Humidity: 46 %

**Radiated Emission Measurement**

File :WIFI Smart Socket 26UL-W Data :#4 Date: 2018/7/12 Time: 16:54:51

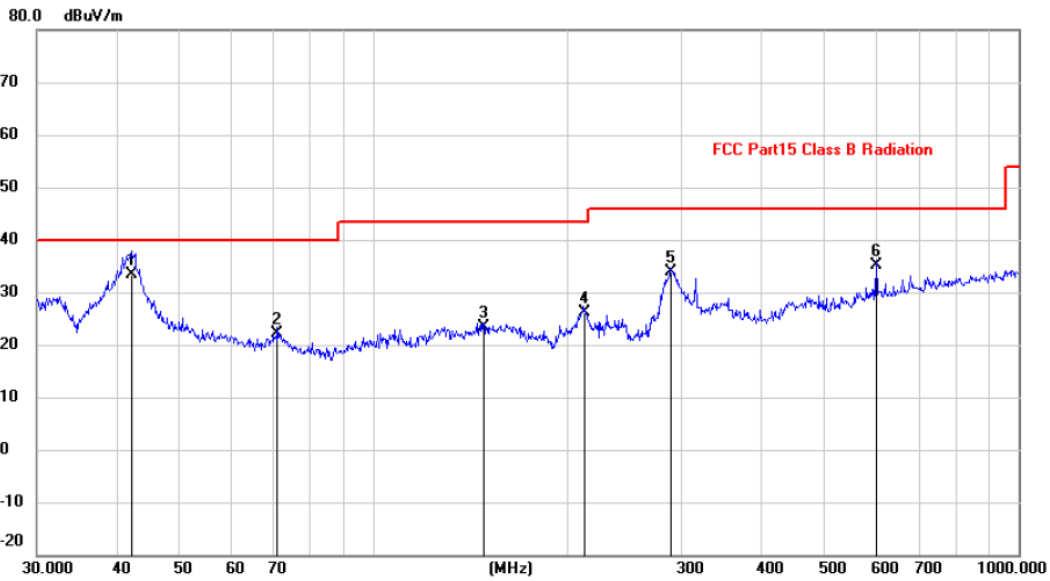

No.	Mk.	Freq.	Reading Level	Correct Factor	Measurement	Limit	Margin	Antenna Height	Table Degree	
		MHz	dBuV	dB	dBuV/m	dBuV/m	dB	cm	degree	Comment
1	*	42.0617	19.24	14.11	33.35	40.00	-6.65	QP	100	360
2		70.8315	11.31	10.74	22.05	40.00	-17.95	QP		
3		147.9214	8.88	14.40	23.28	43.50	-20.22	QP		
4		212.2695	15.24	10.83	26.07	43.50	-17.43	QP		
5		289.0021	20.74	13.11	33.85	46.00	-12.15	QP		
6		601.4265	15.60	19.41	35.01	46.00	-10.99	QP		

Note:1. \*:Maximum data; x:Over limit; !:over margin.  
 2.Measurement=Reading Level+Correct Factor; Correct Factor=Antenna Factor+Cable Loss.

Remark: All modes and channels have been tested and only worst data of 802.11b, 2412MHz is listed in this report.



From 1G-25GHz

<b>EUT</b>	WI-FI Smart Socket	<b>Model Name</b>	26UL-WFO
<b>Temperature</b>	26°C	<b>Relative Humidity</b>	56%
<b>Pressure</b>	960hPa	<b>Test voltage</b>	AC 120V/60Hz
<b>Test Mode</b>	TX Low		

IEEE 802.11b

Freq. (MHz)	Ant. Pol H/V	Peak Reading (dBuV)	AV Reading (dBuV)	Ant. / CL CF (dB)	Actual Fs		Peak Limit (dBuV/m)	AV Limit (dBuV/m)	Margin (dB)	Remark
					Peak (dBuV/m)	AV (dBuV/m)				
1103	V	46.04	---	-11.24	34.80	---	74	54	39.20	Peak
4824	V	38.59	---	0.64	39.23	---	74	54	34.77	Peak
N/A										

<b>EUT</b>	WI-FI Smart Socket	<b>Model Name</b>	26UL-WFO
<b>Temperature</b>	26°C	<b>Relative Humidity</b>	56%
<b>Pressure</b>	960hPa	<b>Test voltage</b>	AC 120V/60Hz
<b>Test Mode</b>	TX Low		

Freq. (MHz)	Ant. Pol H/V	Peak Reading (dBuV)	AV Reading (dBuV)	Ant. / CL CF (dB)	Actual Fs		Peak Limit (dBuV/m)	AV Limit (dBuV/m)	Margin (dB)	Remark
					Peak (dBuV/m)	AV (dBuV/m)				
1103	H	44.96	---	-11.24	33.72	---	74	54	40.28	Peak
4824	H	37.45	---	0.64	38.09	---	74	54	35.91	Peak
N/A										

**Notes:** AV Means AV detector test data, Peak Means Peak detector test data.

Emissions attenuated more than 20 dB below the permissible value are not reported.

<b>EUT</b>	WI-FI Smart Socket	<b>Model Name</b>	26UL-WFO
<b>Temperature</b>	26°C	<b>Relative Humidity</b>	56%
<b>Pressure</b>	960hPa	<b>Test voltage</b>	AC 120V/60Hz
<b>Test Mode</b>	TX Mid		

Freq. (MHz)	Ant. Pol H/V	Peak Reading (dBuV)	AV Reading (dBuV)	Ant. / CL CF (dB)	Actual Fs		Peak Limit (dBuV/m)	AV Limit (dBuV/m)	Margin (dB)	Remark
					Peak (dBuV/m)	AV (dBuV/m)				
1103	V	45.00	---	-11.24	33.76	---	74	54	40.24	Peak
4874	V	38.79	---	0.76	39.55	---	74	54	34.45	Peak

<b>EUT</b>	WI-FI Smart Socket	<b>Model Name</b>	26UL-WFO
<b>Temperature</b>	26°C	<b>Relative Humidity</b>	56%
<b>Pressure</b>	960hPa	<b>Test voltage</b>	AC 120V/60Hz
<b>Test Mode</b>	TX Mid		

Freq. (MHz)	Ant. Pol H/V	Peak Reading (dBuV)	AV Reading (dBuV)	Ant. / CL CF (dB)	Actual Fs		Peak Limit (dBuV/m)	AV Limit (dBuV/m)	Margin (dB)	Remark
					Peak (dBuV/m)	AV (dBuV/m)				
1103	H	45.67	---	-11.24	34.43	---	74	54	39.57	Peak
4874	H	39.25	---	0.76	40.01	---	74	54	33.99	Peak

**Notes:** AV Means AV detector test data, Peak Means Peak detector test data.

Emissions attenuated more than 20 dB below the permissible value are not reported.

<b>EUT</b>	WI-FI Smart Socket	<b>Model Name</b>	26UL-WFO
<b>Temperature</b>	26°C	<b>Relative Humidity</b>	56%
<b>Pressure</b>	960hPa	<b>Test voltage</b>	AC 120V/60Hz
<b>Test Mode</b>	TX High		

Freq. (MHz)	Ant. Pol H/V	Peak Reading (dBuV)	AV Reading (dBuV)	Ant. / CL CF (dB)	Actual Fs		Peak Limit (dBuV/m)	AV Limit (dBuV/m)	Margin (dB)	Remark
					Peak (dBuV/m)	AV (dBuV/m)				
1103	V	44.44	---	-11.24	33.20	---	74	54	40.80	Peak
4924	V	37.37	---	0.87	38.24	---	74	54	35.76	Peak

<b>EUT</b>	WI-FI Smart Socket	<b>Model Name</b>	26UL-WFO
<b>Temperature</b>	26°C	<b>Relative Humidity</b>	56%
<b>Pressure</b>	960hPa	<b>Test voltage</b>	AC 120V/60Hz
<b>Test Mode</b>	TX High		

Freq. (MHz)	Ant. Pol H/V	Peak Reading (dBuV)	AV Reading (dBuV)	Ant. / CL CF (dB)	Actual Fs		Peak Limit (dBuV/m)	AV Limit (dBuV/m)	Margin (dB)	Remark
					Peak (dBuV/m)	AV (dBuV/m)				
1103	H	44.45	---	-11.24	33.21	---	74	54	40.79	Peak
4924	H	36.39	---	0.87	37.26	---	74	54	36.74	Peak

**Notes:** AV Means AV detector test data, Peak Means Peak detector test data.

Emissions attenuated more than 20 dB below the permissible value are not reported.

IEEE 802.11 g:

<b>EUT</b>	WI-FI Smart Socket	<b>Model Name</b>	26UL-WFO
<b>Temperature</b>	26°C	<b>Relative Humidity</b>	56%
<b>Pressure</b>	960hPa	<b>Test voltage</b>	AC 120V/60Hz
<b>Test Mode</b>	TX Low		

Freq. (MHz)	Ant. Pol H/V	Peak Reading (dBuV)	AV Reading (dBuV)	Ant. / CL CF (dB)	Actual Fs		Peak Limit (dBuV/m)	AV Limit (dBuV/m)	Margin (dB)	Remark
					Peak (dBuV/m)	AV (dBuV/m)				
1145	V	45.62	---	-11.24	34.38	---	74	54	39.62	Peak
2586	V	46.18	---	-7.13	39.05	---	74	54	34.95	Peak
3062	V	45.10	---	-5.74	39.36	---	74	54	34.64	Peak
4824	V	42.31	---	0.64	42.95	---	74	54	31.05	Peak
N/A										

<b>EUT</b>	WI-FI Smart Socket	<b>Model Name</b>	26UL-WFO
<b>Temperature</b>	26°C	<b>Relative Humidity</b>	56%
<b>Pressure</b>	960hPa	<b>Test voltage</b>	AC 120V/60Hz
<b>Test Mode</b>	TX Low		

Freq. (MHz)	Ant. Pol H/V	Peak Reading (dBuV)	AV Reading (dBuV)	Ant. / CL CF (dB)	Actual Fs		Peak Limit (dBuV/m)	AV Limit (dBuV/m)	Margin (dB)	Remark
					Peak (dBuV/m)	AV (dBuV/m)				
1294	H	44.63	---	-10.96	33.67	---	74	54	40.33	Peak
2038	H	44.43	---	-8.58	35.85	---	74	54	38.15	Peak
3483	H	44.02	---	-4.95	39.07	---	74	54	34.93	Peak
4824	H	41.79	---	0.64	42.43	---	74	54	31.57	Peak
N/A										

**Notes:** AV Means AV detector test data, Peak Means Peak detector test data.

Emissions attenuated more than 20 dB below the permissible value are not reported.

<b>EUT</b>	WI-FI Smart Socket	<b>Model Name</b>	26UL-WFO
<b>Temperature</b>	26°C	<b>Relative Humidity</b>	56%
<b>Pressure</b>	960hPa	<b>Test voltage</b>	AC 120V/60Hz
<b>Test Mode</b>	TX Mid		

Freq. (MHz)	Ant. Pol H/V	Peak Reading (dBuV)	AV Reading (dBuV)	Ant. / CL CF (dB)	Actual Fs		Peak Limit (dBuV/m)	AV Limit (dBuV/m)	Margin (dB)	Remark
					Peak (dBuV/m)	AV (dBuV/m)				
1374	V	43.96	---	-10.43	33.53	---	74	54	40.47	Peak
2589	V	45.19	---	-7.13	38.06	---	74	54	35.94	Peak
3365	V	44.59	---	-5.18	39.41	---	74	54	34.59	Peak
4874	V	42.69	---	0.76	43.45	---	74	54	30.55	Peak

<b>EUT</b>	WI-FI Smart Socket	<b>Model Name</b>	26UL-WFO
<b>Temperature</b>	26°C	<b>Relative Humidity</b>	56%
<b>Pressure</b>	960hPa	<b>Test voltage</b>	AC 120V/60Hz
<b>Test Mode</b>	TX Mid		

Freq. (MHz)	Ant. Pol H/V	Peak Reading (dBuV)	AV Reading (dBuV)	Ant. / CL CF (dB)	Actual Fs		Peak Limit (dBuV/m)	AV Limit (dBuV/m)	Margin (dB)	Remark
					Peak (dBuV/m)	AV (dBuV/m)				
1321	H	44.54	---	-10.84	33.70	---	74	54	40.30	Peak
2314	H	45.35	---	-7.46	37.89	---	74	54	36.11	Peak
3577	H	44.02	---	-4.76	39.26	---	74	54	34.74	Peak
4874	H	41.32	---	0.76	42.08	---	74	54	31.92	Peak

**Notes:** AV Means AV detector test data, Peak Means Peak detector test data.

Emissions attenuated more than 20 dB below the permissible value are not reported.

<b>EUT</b>	WI-FI Smart Socket	<b>Model Name</b>	26UL-WFO
<b>Temperature</b>	26°C	<b>Relative Humidity</b>	56%
<b>Pressure</b>	960hPa	<b>Test voltage</b>	AC 120V/60Hz
<b>Test Mode</b>	TX High		

Freq. (MHz)	Ant. Pol H/V	Peak Reading (dBuV)	AV Reading (dBuV)	Ant. / CL CF (dB)	Actual Fs		Peak Limit (dBuV/m)	AV Limit (dBuV/m)	Margin (dB)	Remark
					Peak (dBuV/m)	AV (dBuV/m)				
1302	V	45.40	---	-10.84	34.56	---	74	54	39.44	Peak
2982	V	44.70	---	-5.86	38.84	---	74	54	35.16	Peak
3831	V	44.12	---	-3.96	40.16	---	74	54	33.84	Peak
4924	V	40.30	---	0.87	41.17	---	74	54	32.83	Peak

<b>EUT</b>	WI-FI Smart Socket	<b>Model Name</b>	26UL-WFO
<b>Temperature</b>	26°C	<b>Relative Humidity</b>	56%
<b>Pressure</b>	960hPa	<b>Test voltage</b>	AC 120V/60Hz
<b>Test Mode</b>	TX High		

Freq. (MHz)	Ant. Pol H/V	Peak Reading (dBuV)	AV Reading (dBuV)	Ant. / CL CF (dB)	Actual Fs		Peak Limit (dBuV/m)	AV Limit (dBuV/m)	Margin (dB)	Remark
					Peak (dBuV/m)	AV (dBuV/m)				
1446	H	44.08	---	-10.29	33.79	---	74	54	40.21	Peak
2198	H	45.15	---	-8.24	36.91	---	74	54	37.09	Peak
3905	H	44.81	---	-3.68	41.13	---	74	54	32.87	Peak
4924	H	41.75	---	0.87	42.62	---	74	54	31.38	Peak

**Notes:** AV Means AV detector test data, Peak Means Peak detector test data.

Emissions attenuated more than 20 dB below the permissible value are not reported.

## IEEE 802.11n/HT20 with 2.4G

<b>EUT</b>	WI-FI Smart Socket	<b>Model Name</b>	26UL-WFO
<b>Temperature</b>	26°C	<b>Relative Humidity</b>	56%
<b>Pressure</b>	960hPa	<b>Test voltage</b>	AC 120V/60Hz
<b>Test Mode</b>	TX Low		

Freq. (MHz)	Ant. Pol H/V	Peak Reading (dBuV)	AV Reading (dBuV)	Ant. / CL CF (dB)	Actual Fs		Peak Limit (dBuV/m)	AV Limit (dBuV/m)	Margin (dB)	Remark
					Peak (dBuV/m)	AV (dBuV/m)				
1492	V	45.45	---	-10.27	35.18	---	74	54	38.82	Peak
2671	V	45.45	---	-6.94	38.51	---	74	54	35.49	Peak
3948	V	44.68	---	-3.68	41.00	---	74	54	33.00	Peak
4824	V	40.44	---	0.64	41.08	---	74	54	32.92	Peak
N/A										

<b>EUT</b>	WI-FI Smart Socket	<b>Model Name</b>	26UL-WFO
<b>Temperature</b>	26°C	<b>Relative Humidity</b>	56%
<b>Pressure</b>	960hPa	<b>Test voltage</b>	AC 120V/60Hz
<b>Test Mode</b>	TX Low		

Freq. (MHz)	Ant. Pol H/V	Peak Reading (dBuV)	AV Reading (dBuV)	Ant. / CL CF (dB)	Actual Fs		Peak Limit (dBuV/m)	AV Limit (dBuV/m)	Margin (dB)	Remark
					Peak (dBuV/m)	AV (dBuV/m)				
1451	H	44.46	---	-10.27	34.19	---	74	54	39.81	Peak
2839	H	44.92	---	-6.17	38.75	---	74	54	35.25	Peak
3607	H	43.38	---	-4.52	38.86	---	74	54	35.14	Peak
4824	H	41.81	---	0.64	42.45	---	74	54	31.55	Peak
N/A										

**Notes:** AV Means AV detector test data, Peak Means Peak detector test data.

Emissions attenuated more than 20 dB below the permissible value are not reported.

<b>EUT</b>	WI-FI Smart Socket	<b>Model Name</b>	26UL-WFO
<b>Temperature</b>	26°C	<b>Relative Humidity</b>	56%
<b>Pressure</b>	960hPa	<b>Test voltage</b>	AC 120V/60Hz
<b>Test Mode</b>	TX Mid		

Freq. (MHz)	Ant. Pol H/V	Peak Reading (dBuV)	AV Reading (dBuV)	Ant. / CL CF (dB)	Actual Fs		Peak Limit (dBuV/m)	AV Limit (dBuV/m)	Margin (dB)	Remark
					Peak (dBuV/m)	AV (dBuV/m)				
1262	V	44.64	---	-10.96	33.68	---	74	54	40.32	Peak
2013	V	44.63	---	-8.58	36.05	---	74	54	37.95	Peak
3798	V	43.20	---	-4.07	39.13	---	74	54	34.87	Peak
4874	V	40.08	---	0.76	40.84	---	74	54	33.16	Peak

<b>EUT</b>	WI-FI Smart Socket	<b>Model Name</b>	26UL-WFO
<b>Temperature</b>	26°C	<b>Relative Humidity</b>	56%
<b>Pressure</b>	960hPa	<b>Test voltage</b>	AC 120V/60Hz
<b>Test Mode</b>	TX Mid		

Freq. (MHz)	Ant. Pol H/V	Peak Reading (dBuV)	AV Reading (dBuV)	Ant. / CL CF (dB)	Actual Fs		Peak Limit (dBuV/m)	AV Limit (dBuV/m)	Margin (dB)	Remark
					Peak (dBuV/m)	AV (dBuV/m)				
1511	H	44.89	---	-10.14	34.75	---	74	54	39.25	Peak
2353	H	45.36	---	-7.59	37.77	---	74	54	36.23	Peak
3266	H	43.52	---	-5.39	38.13	---	74	54	35.87	Peak
4874	H	40.95	---	0.76	41.71	---	74	54	32.29	Peak

**Notes:** AV Means AV detector test data, Peak Means Peak detector test data.

Emissions attenuated more than 20 dB below the permissible value are not reported.



<b>EUT</b>	WI-FI Smart Socket	<b>Model Name</b>	26UL-WFO
<b>Temperature</b>	26°C	<b>Relative Humidity</b>	56%
<b>Pressure</b>	960hPa	<b>Test voltage</b>	AC 120V/60Hz
<b>Test Mode</b>	TX High		

Freq. (MHz)	Ant. Pol H/V	Peak Reading (dBuV)	AV Reading (dBuV)	Ant. / CL CF (dB)	Actual Fs		Peak Limit (dBuV/m)	AV Limit (dBuV/m)	Margin (dB)	Remark
					Peak (dBuV/m)	AV (dBuV/m)				
1477	V	45.00	---	-10.27	34.73	---	74	54	39.27	Peak
2703	V	45.15	---	-6.43	38.72	---	74	54	35.28	Peak
3561	V	45.14	---	-4.76	40.38	---	74	54	33.62	Peak
4924	V	41.53	---	0.87	42.40	---	74	54	31.60	Peak

<b>EUT</b>	WI-FI Smart Socket	<b>Model Name</b>	26UL-WFO
<b>Temperature</b>	26°C	<b>Relative Humidity</b>	56%
<b>Pressure</b>	960hPa	<b>Test voltage</b>	AC 120V/60Hz
<b>Test Mode</b>	TX High		

Freq. (MHz)	Ant. Pol H/V	Peak Reading (dBuV)	AV Reading (dBuV)	Ant. / CL CF (dB)	Actual Fs		Peak Limit (dBuV/m)	AV Limit (dBuV/m)	Margin (dB)	Remark
					Peak (dBuV/m)	AV (dBuV/m)				
1503	H	43.21	---	-10.14	33.07	---	74	54	40.93	Peak
3588	H	45.06	---	-4.96	40.10	---	74	54	33.90	Peak
4153	H	43.37	---	-2.48	40.89	---	74	54	33.11	Peak
4924	H	39.62	---	0.87	40.49	---	74	54	33.51	Peak

**Notes:** AV Means AV detector test data, Peak Means Peak detector test data.

Emissions attenuated more than 20 dB below the permissible value are not reported.

## 6 POWER LINE CONDUCTED EMISSION

### 6.1 Conducted Emission Limits(15.207) & IC RSS Gen

Frequency MHz	Limits dB( $\mu$ V)	
	Quasi-peak Level	Average Level
0.15 -0.50	66 -56*	56 - 46*
0.50 -5.00	56	46
5.00 -30.00	60	50

Notes: 1. \*Decreasing linearly with logarithm of frequency.

2. The lower limit shall apply at the transition frequencies.

3.The limit decreases in line with the logarithm of the frequency in the rang of 0.15 to 0.50 MHz.

### 6.2 Test Setup

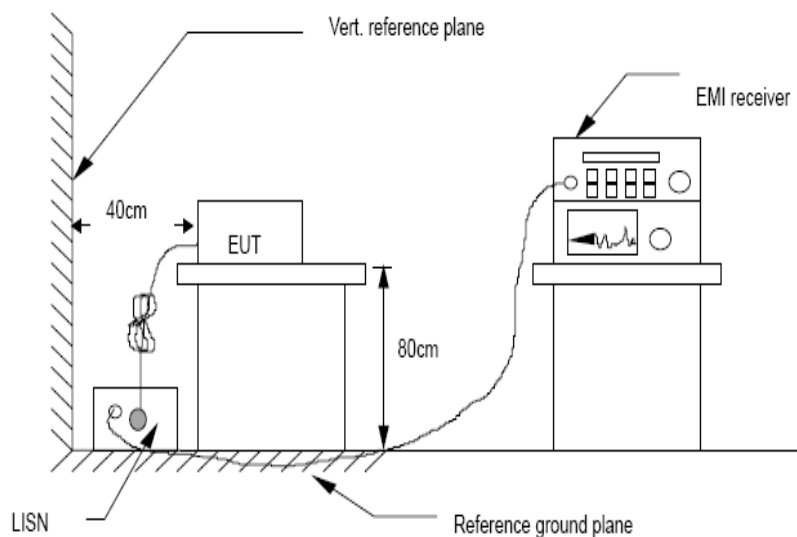

### 6.3 Test Procedure

The EUT is put on the plane 0.8m high above the ground by insulating support and is connected to the power mains through a line impedance stabilization network (L.I.S.N.). This provides a 50ohm coupling impedance for the EUT system. Please refer the block diagram of the test setup and photographs. Both sides of AC lines are checked to find out the maximum conducted emission. In order to find the maximum emission levels, the relative positions of equipment and all of the interface cables shall be changed according to ANSI C63.10:2013 on Conducted Emission Measurement. The bandwidth of test receiver is set at 9 kHz.

### 6.4 Test Results

Worse case is reported only

**PASS**

Detailed information please see the following page.

Site LAB Phase: **N** Temperature: 24.9  
 Limit: FCC Part 15 CLASS B QP Power: AC 120V/60Hz Humidity: 47 %  
 EUT: WIFI Smart Socket  
 M/N: 26UL-WFO  
 Mode: WiFi B 2412MHz  
 Note:  
 Engineer Signature:

**Conducted Emission Measurement**

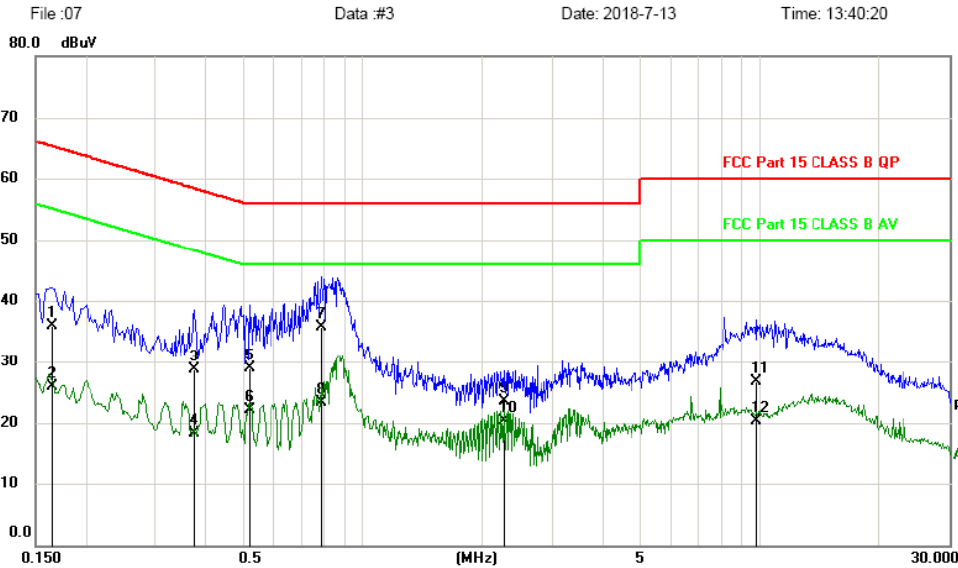

No.	Mk.	Freq. MHz	Reading Level dBuV	Correct Factor dB	Measure- ment dBuV	Limit dBuV	Margin dB	Detector	Comment
1		0.1650	26.11	9.73	35.84	65.21	-29.37	QP	
2		0.1650	16.12	9.73	25.85	55.21	-29.36	AVG	
3		0.3780	18.99	9.77	28.76	58.32	-29.56	QP	
4		0.3780	8.59	9.77	18.36	48.32	-29.96	AVG	
5		0.5190	19.15	9.79	28.94	56.00	-27.06	QP	
6		0.5190	12.34	9.79	22.13	46.00	-23.87	AVG	
7	*	0.7890	25.93	9.81	35.74	56.00	-20.26	QP	
8		0.7890	13.40	9.81	23.21	46.00	-22.79	AVG	
9		2.2680	13.50	9.96	23.46	56.00	-32.54	QP	
10		2.2680	10.25	9.96	20.21	46.00	-25.79	AVG	
11		9.8190	16.38	10.33	26.71	60.00	-33.29	QP	
12		9.8190	9.98	10.33	20.31	50.00	-29.69	AVG	

\*:Maximum data x:Over limit !:over margin

Note: Measurement=Reading Level+Correc Factor. Factor=(LISN or ISN or PLC or Current Probe)Factor+Cable

Site LAB  
 Limit: FCC Part 15 CLASS B QP  
 EUT: WIFI Smart Socket  
 M/N: 26UL-WFO  
 Mode: WiFi B 2412MHz  
 Note:  
 Engineer Signature:

Phase: **L1**  
 Power: AC 120V/60Hz

Temperature: 24.9  
 Humidity: 47 %

**Conducted Emission Measurement**

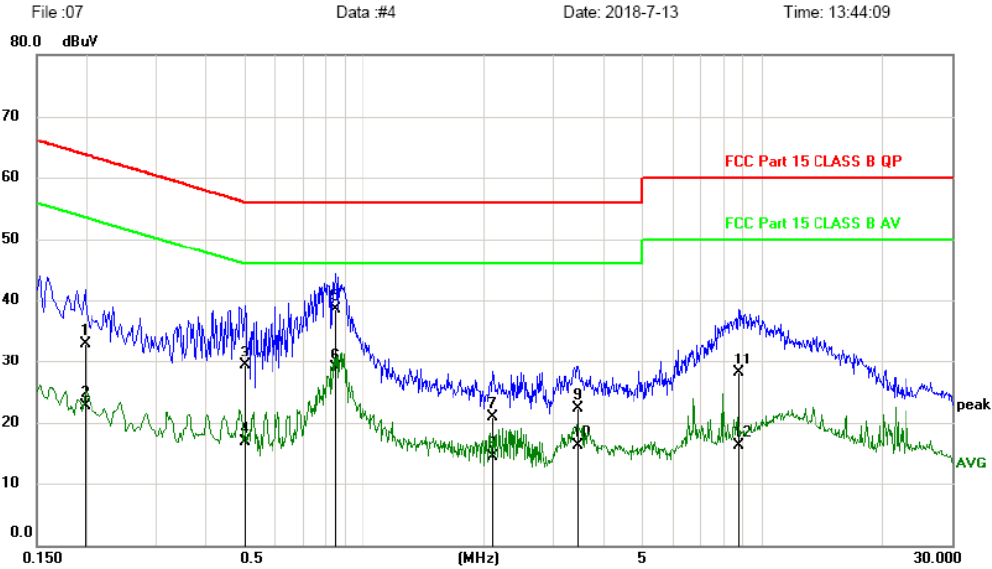

No.	Mk.	Freq. MHz	Reading Level dBuV	Correct Factor dB	Measure- ment dBuV	Limit dBuV	Margin dB	Detector	Comment
1		0.1980	23.16	9.74	32.90	63.69	-30.79	QP	
2		0.1980	12.98	9.74	22.72	53.69	-30.97	AVG	
3		0.5010	19.45	9.78	29.23	56.00	-26.77	QP	
4		0.5010	7.12	9.78	16.90	46.00	-29.10	AVG	
5		0.8460	28.69	9.82	38.51	56.00	-17.49	QP	
6	*	0.8460	19.14	9.82	28.96	46.00	-17.04	AVG	
7		2.1060	10.93	9.93	20.86	56.00	-35.14	QP	
8		2.1060	4.64	9.93	14.57	46.00	-31.43	AVG	
9		3.4380	12.20	10.08	22.28	56.00	-33.72	QP	
10		3.4380	6.29	10.08	16.37	46.00	-29.63	AVG	
11		8.7299	17.84	10.31	28.15	60.00	-31.85	QP	
12		8.7299	5.99	10.31	16.30	50.00	-33.70	AVG	

\*:Maximum data    x:Over limit    !:over margin

Note: Measurement=Reading Level+Correc Factor.    Factor=(LISN or ISN or PLC or Current Probe)Factor+Cable

Remark: All modes and channels have been tested and only worst data of 802.11b, 2412MHz is listed in this report.

## 7 Band Edge Check

### 7.1 Test limit

Please refer section 15.247 & RSS-247 Section 5.5

All the lower and upper band-edges emissions appearing within 2310MHz to 2390MHz and 2483.5MHz to 2500MHz restricted frequency bands shall not exceed the limits shown in 15.209, all the other emissions outside operation frequency band 2400MHz to 2483.5MHz and 5725MHz to 5850MHz shall be at least 20dB below the fundamental emissions, or comply with 15.209 limits.

### 7.2 Test Procedure

12.2.1 Put the EUT on a 0.8m high table, power on the EUT. Emissions were scanned and measured rotating the EUT to 360 degrees, Find the maximum Emission

12.2.2 Check the spurious emissions out of band.

12.2.3 RBW 1MHz ,VBW 3MHz ,peak detector for peak value , RBW 1MHz ,VBW 3MHz , RMS detector for AV value.

### 7.3 Test Setup

Same as 5.2.2.

### 7.4 Test Result

PASS.

Detailed information please see the following page.

Radiated Method:  
IEEE 802.11b CH LOW

Band Edge Test result								
Test mode: TX Low								
Antenna polarity: Vertical								
Freq (MHz)	Read Level (dBUV/m)	Antenna Factor (dB/m)	Cable loss(dB)	Amp Factor (dB)	Result (dBUV/m)	Limit (dBUV/m)	Margin (dB)	Remark
2390	40.66	27.62	3.92	34.97	37.23	74	36.77	<b>PK</b>
2390	--	27.62	3.92	34.97	--	54	--	AV
Antenna Polarity: Horizontal								
2390	41.45	27.62	3.92	34.97	38.02	74	35.98	<b>PK</b>
2390	--	27.62	3.92	34.97	--	54	--	AV
Note:								
1, Spectrum Set for PK measure: RBW=1MHz, VBW=1MHz, Sweep time=Auto, Detector: PK								
2, Spectrum Set for AV measure: RBW=1MHz, VBW=3MHz, Sweep time=Auto, Detector: RMS								
3, Result = Read level + Antenna factor + cable loss-Amp factor								
4, All the other emissions not reported were too low to read and deemed to comply with FCC limit.								

IEEE 802.11b CH High

Band Edge Test result								
Test mode: TX High								
Antenna polarity: Vertical								
Freq (MHz)	Read Level (dBuV/m)	Antenna Factor (dB/m)	Cable loss(dB)	Amp Factor (dB)	Result (dBuV/m)	Limit (dBuV/m)	Margin (dB)	Remark
2483.5	41.95	27.89	4	34.97	38.87	74	35.13	<b>PK</b>
2483.5	--	27.89	4	34.97	--	54	--	AV
Antenna Polarity: Horizontal								
2483.5	46.58	27.89	4	34.97	43.50	74	30.50	<b>PK</b>
2483.5	--	27.89	4	34.97	--	54	--	AV
Note: 1, Spectrum Set for PK measure: RBW=1MHz, VBW=1MHz, Sweep time=Auto, Detector: PK 2, Spectrum Set for AV measure: RBW=1MHz, VBW=3MHz, Sweep time=Auto, Detector: RMS 3, Result = Read level + Antenna factor + cable loss-Amp factor 4, All the other emissions not reported were too low to read and deemed to comply with FCC limit.								



## IEEE 802.11g CH LOW

Band Edge Test result								
Test mode: TX Low								
Antenna polarity: Vertical								
Freq (MHz)	Read Level (dBuV/m)	Antenna Factor (dB/m)	Cable loss(dB)	Amp Factor (dB)	Result (dBuV/m)	Limit (dBuV/m)	Margin (dB)	Remark
2390	40.89	27.62	3.92	34.97	37.46	74	36.54	<b>PK</b>
2390	--	27.62	3.92	34.97	--	54	--	AV
Antenna Polarity: Horizontal								
2390	43.15	27.62	3.92	34.97	39.72	74	34.28	<b>PK</b>
2390	--	27.62	3.92	34.97	--	54	--	AV
Note:								
1, Spectrum Set for PK measure: RBW=1MHz, VBW=1MHz, Sweep time=Auto, Detector: PK								
2, Spectrum Set for AV measure: RBW=1MHz, VBW=3MHz, Sweep time=Auto, Detector: RMS								
3, Result = Read level + Antenna factor + cable loss-Amp factor								
4, All the other emissions not reported were too low to read and deemed to comply with FCC limit.								

IEEE 802.11g CH High

Band Edge Test result								
Test mode: TX High								
Antenna polarity: Vertical								
Freq (MHz)	Read Level (dBuV/m)	Antenna Factor (dB/m)	Cable loss(dB)	Amp Factor (dB)	Result (dBuV/m)	Limit (dBuV/m)	Margin (dB)	Remark
2483.5	44.33	27.89	4	34.97	41.25	74	32.75	<b>PK</b>
2483.5		--	--	--	--	54	--	AV
Antenna Polarity: Horizontal								
2483.5	46.74	27.89	4	34.97	43.66	74	30.34	<b>PK</b>
2483.5		--	--	--	--	54	--	AV
Note:								
1, Spectrum Set for PK measure: RBW=1MHz, VBW=1MHz, Sweep time=Auto, Detector: PK								
2, Spectrum Set for AV measure: RBW=1MHz, VBW=3MHz, Sweep time=Auto, Detector: RMS								
3, Result = Read level + Antenna factor + cable loss-Amp factor								
4, All the other emissions not reported were too low to read and deemed to comply with FCC limit.								

IEEE 802.11n HT20 CH Low

Band Edge Test result								
Test mode: TX Low								
Antenna polarity: Vertical								
Freq (MHz)	Read Level (dBuV/m)	Antenna Factor (dB/m)	Cable loss(dB)	Amp Factor (dB)	Result (dBuV/m)	Limit (dBuV/m)	Margin (dB)	Remark
2390	40.45	27.62	3.92	34.97	37.02	74	36.98	<b>PK</b>
2390	--	27.62	3.92	34.97	--	54	--	AV
Antenna Polarity: Horizontal								
2390	41.76	27.62	3.92	34.97	38.33	74	35.67	<b>PK</b>
2390	--	27.62	3.92	34.97	--	54	--	AV
Note:								
1, Spectrum Set for PK measure: RBW=1MHz, VBW=1MHz, Sweep time=Auto, Detector: PK								
2, Spectrum Set for AV measure: RBW=1MHz, VBW=3MHz, Sweep time=Auto, Detector: RMS								
3, Result = Read level + Antenna factor + cable loss-Amp factor								
4, All the other emissions not reported were too low to read and deemed to comply with FCC limit.								

IEEE 802.11n HT20 CH High

Band Edge Test result								
Test mode: TX High								
Antenna polarity: Vertical								
Freq (MHz)	Read Level (dBuV/m)	Antenna Factor (dB/m)	Cable loss(dB)	Amp Factor (dB)	Result (dBuV/m)	Limit (dBuV/m)	Margin (dB)	Remark
2483.5	43.89	27.89	4	34.97	40.81	74	33.19	PK
2483.5		--	--	--	--	54	--	AV
Antenna Polarity: Horizontal								
2483.5	45.98	27.89	4	34.97	42.90	74	31.10	PK
2483.5		--	--	--	--	54	--	AV
Note:								
1, Spectrum Set for PK measure: RBW=1MHz, VBW=1MHz, Sweep time=Auto, Detector: PK								
2, Spectrum Set for AV measure: RBW=1MHz, VBW=3MHz, Sweep time=Auto, Detector: RMS								
3, Result = Read level + Antenna factor + cable loss-Amp factor								
4, All the other emissions not reported were too low to read and deemed to comply with FCC limit.								

## 8 Test setup photo

### 8.1 Photos of Radiated emission

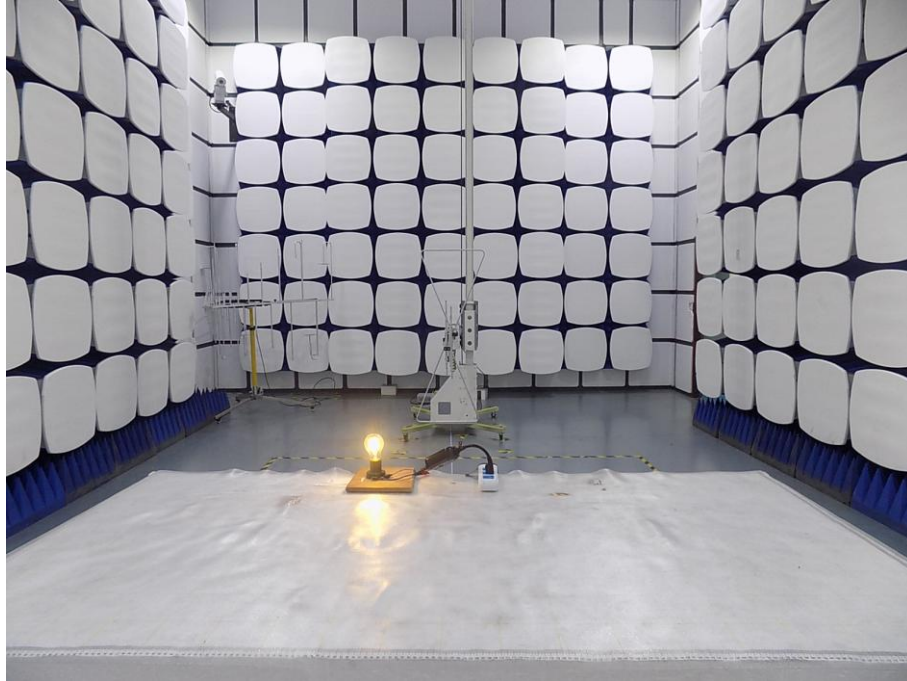

8.2 Photos of Conducted Emission test



## 9 Photographs of EUT









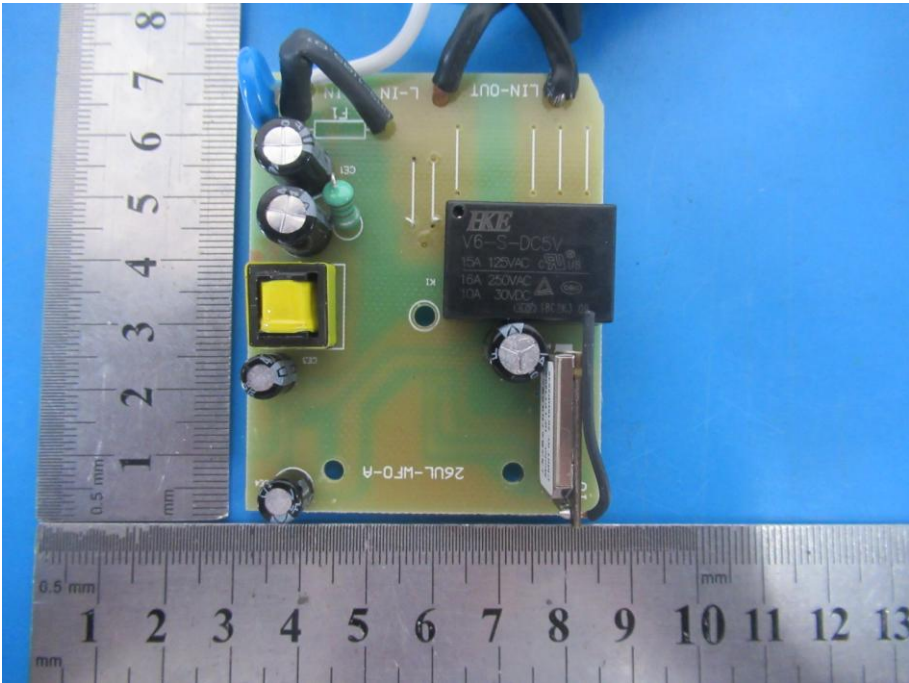

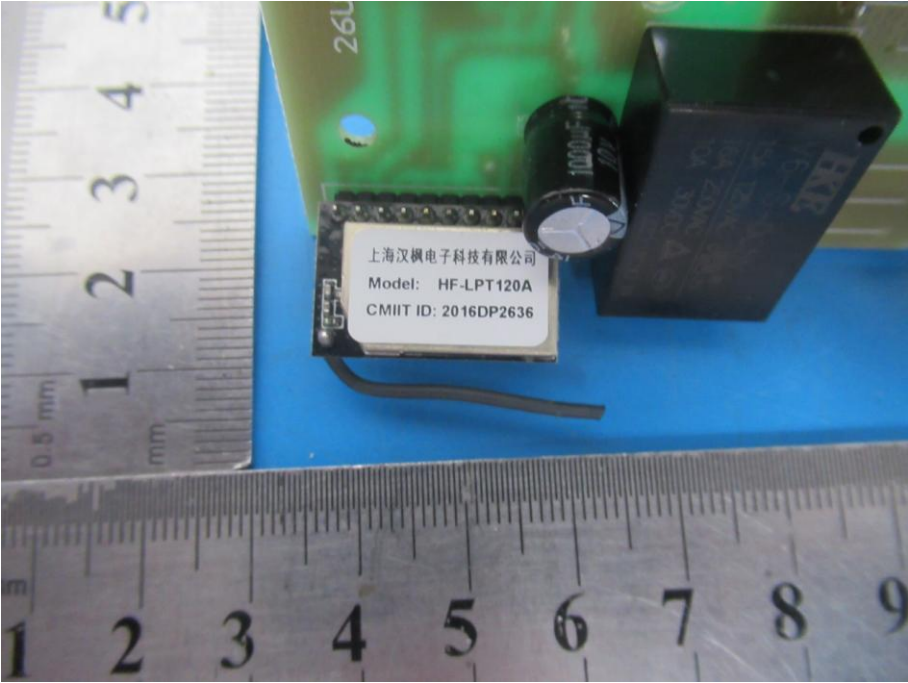
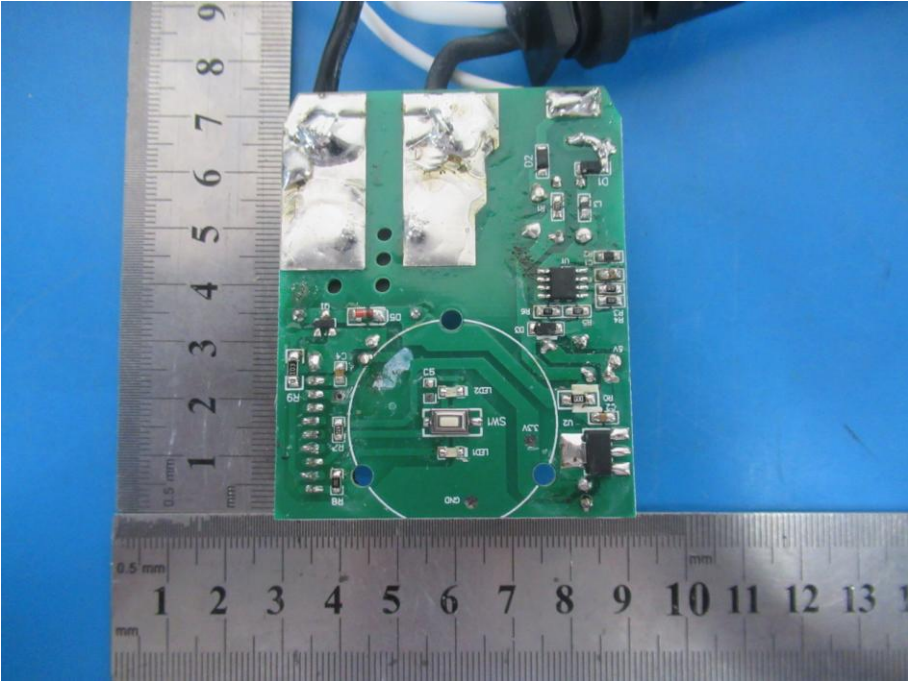

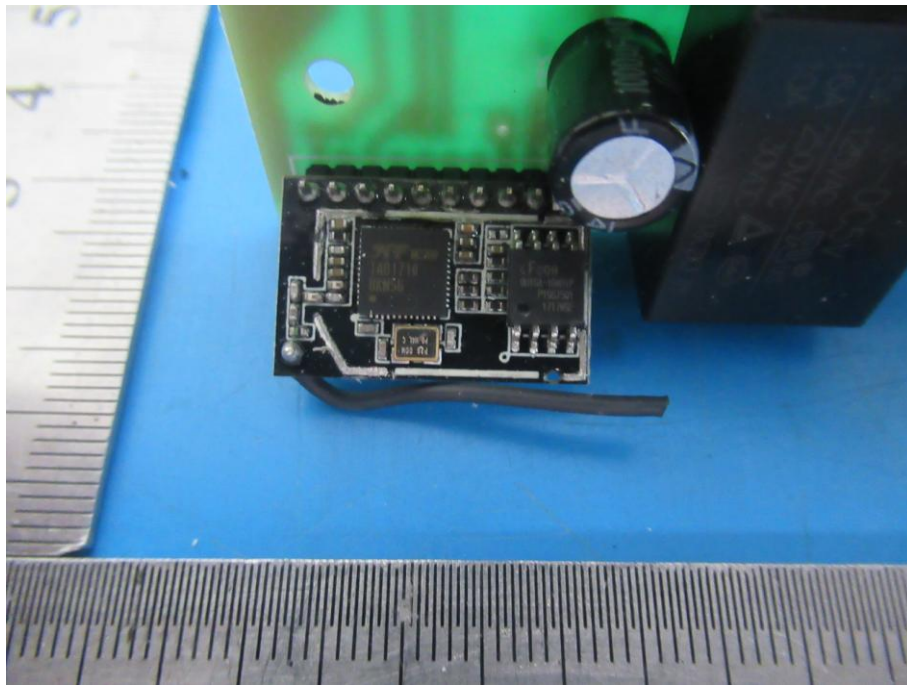
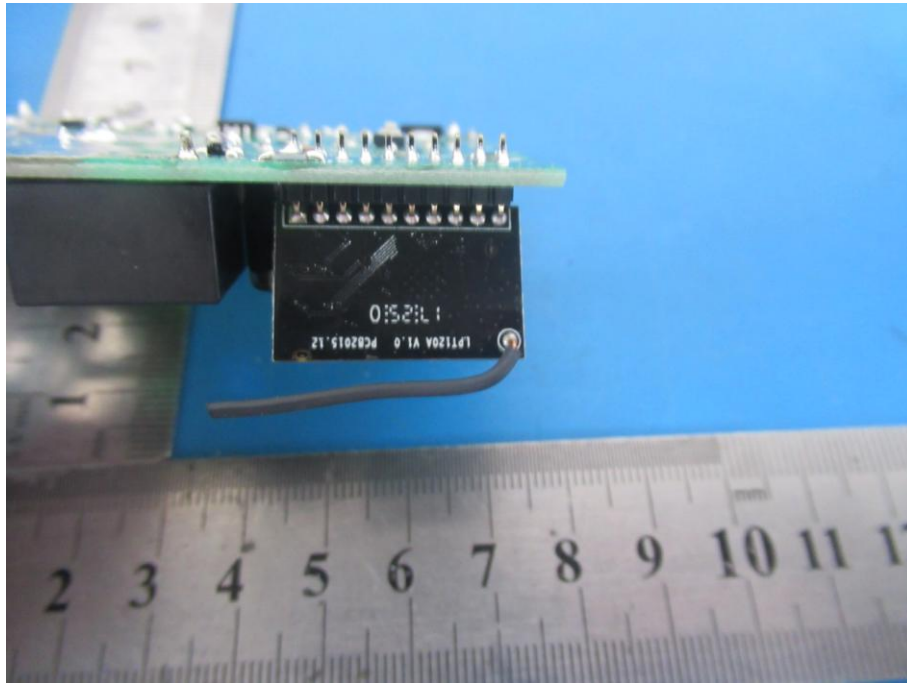

-----END OF THE REPORT-----