

# RADIO PERFORMANCE TEST REPORT

**Test Report No.** : OT-237-RWD-063

**Reception No.** : 2306001881

**Applicant** : SEGI LIMITED

**Address** : Unit J2, 4/F, Block 1, Kinho Industrial Building, 14-24 Au Pui Wan Street, Shatin,  
New Territories, HONGKONG, China

**Manufacturer** : SEGI R&D LIMITED

**Address** : C-709, Bupyeong Woolim lions valley, 283, Bupyeong-daero, Bupyeong-gu, Incheon,  
Republic of Korea

**Type of Equipment** : Dash cam

**FCC ID.** : VA5CLC345-XC

**Model Name** : DR-XC

**Multiple Model Name** : N/A

**Serial number** : N/A

**Total page of Report** : 33 pages (including this page)

**Date of Incoming** : June 26, 2023

**Date of issue** : July 28, 2023

## SUMMARY

The equipment complies with the regulation; *FCC PART 15 SUBPART C Section 15.247*

This test report only contains the result of a single test of the sample supplied for the examination.

It is not a generally valid assessment of the features of the respective products of the mass-production.

This report is not correlated with the "KS Q ISO/IEC 17025 and KOLAS accreditation" of Korean Laboratory Accreditation Scheme.





Tested by  
Myeong-Hwa, Jang / Sr. Engineer  
ONETECH Corp.

Reviewed by  
Tae-Ho, Kim / Chief Engineer  
ONETECH Corp.

Approved by  
Jae-Ho, Lee / Chief Engineer  
ONETECH Corp.

It should not be reproduced except in full, without the written approval of ONETECH Corp.

OTC-TRF-RF-001(0)

## CONTENTS

**PAGE**

<b>1. VERIFICATION OF COMPLIANCE .....</b>	<b>5</b>
<b>2. TEST SUMMARY.....</b>	<b>6</b>
<b>2.1 TEST ITEMS AND RESULTS .....</b>	<b>6</b>
<b>2.2 ADDITIONS, DEVIATIONS, EXCLUSIONS FROM STANDARDS.....</b>	<b>6</b>
<b>2.3 RELATED SUBMITTAL(S) / GRANT(S) .....</b>	<b>6</b>
<b>2.4 PURPOSE OF THE TEST .....</b>	<b>6</b>
<b>2.5 TEST METHODOLOGY.....</b>	<b>6</b>
<b>2.6 TEST FACILITY.....</b>	<b>6</b>
<b>3. GENERAL INFORMATION.....</b>	<b>7</b>
<b>3.1 PRODUCT DESCRIPTION.....</b>	<b>7</b>
<b>3.2 ALTERNATIVE TYPE(S)/MODEL(S); ALSO COVERED BY THIS TEST REPORT.....</b>	<b>7</b>
<b>4. EUT MODIFICATIONS.....</b>	<b>7</b>
<b>5. SYSTEM TEST CONFIGURATION .....</b>	<b>8</b>
<b>5.1 JUSTIFICATION.....</b>	<b>8</b>
<b>5.2 PERIPHERAL EQUIPMENT .....</b>	<b>8</b>
<b>5.3 MODE OF OPERATION DURING THE TEST .....</b>	<b>9</b>
<b>5.4 CONFIGURATION OF TEST SYSTEM.....</b>	<b>11</b>
<b>6. PRELIMINARY TEST .....</b>	<b>11</b>
<b>6.1 AC POWER LINE CONDUCTED EMISSIONS TESTS.....</b>	<b>11</b>
<b>6.2 GENERAL RADIATED EMISSIONS TESTS .....</b>	<b>11</b>
<b>7. MINIMUM 6 DB BANDWIDTH.....</b>	<b>12</b>
<b>7.1 OPERATING ENVIRONMENT .....</b>	<b>12</b>
<b>7.2 TEST SET-UP .....</b>	<b>12</b>
<b>7.3 TEST DATE .....</b>	<b>12</b>
<b>7.4 TEST DATA FOR 1 MBPS .....</b>	<b>13</b>
<b>8. MAXIMUM PEAK OUTPUT POWER.....</b>	<b>15</b>
<b>8.1 OPERATING ENVIRONMENT .....</b>	<b>15</b>
<b>8.2 TEST SET-UP .....</b>	<b>15</b>
<b>8.3 TEST DATE .....</b>	<b>15</b>
<b>8.4 TEST DATA FOR 1 MBPS .....</b>	<b>16</b>
<b>9. 100 KHZ BANDWIDTH OUTSIDE THE FREQUENCY BAND.....</b>	<b>18</b>
<b>9.1 OPERATING ENVIRONMENT .....</b>	<b>18</b>

9.2 TEST SET-UP FOR CONDUCTED MEASUREMENT .....	18
9.3 TEST SET-UP FOR RADIATED MEASUREMENT.....	18
9.4 TEST DATE .....	18
9.5 TEST DATA FOR CONDUCTED EMISSION .....	19
9.5.1 Test data for 1 Mbps .....	19
9.6 TEST DATA FOR RADIATED EMISSION .....	24
9.6.1 Radiated Emission which fall in the Restricted Band.....	24
9.6.2 Spurious & Harmonic Radiated Emission.....	25
10. PEAK POWER SPECTRAL DENSITY .....	26
10.1 OPERATING ENVIRONMENT .....	26
10.2 TEST SET-UP .....	26
10.3 TEST DATE .....	26
10.4 TEST DATA FOR 1 MBPS .....	27
11. RADIATED EMISSION TEST .....	29
11.1 OPERATING ENVIRONMENT .....	29
11.2 TEST SET-UP .....	29
11.3 TEST DATE .....	30
11.4 TEST DATA FOR 30 MHZ ~ 1 GHZ.....	31
11.4.1 Test data for Transmitting Mode.....	31
11.5 TEST DATA FOR BELOW 30 MHZ .....	32
11.6 TEST DATA FOR ABOVE 1 GHZ .....	32
12. LIST OF TEST EQUIPMENT .....	33

**Revision History**

Rev. No.	Issue Report No.	Issued Date	Revisions	Section Affected
0	OT-237-RWD-063	July 28, 2023	Initial Release	All

### 1. VERIFICATION OF COMPLIANCE

Applicant : SEGI LIMITED  
 Address : Unit J2, 4/F, Block 1, Kinho Industrial Building, 14-24 Au Pui Wan Street, Shatin, New Territories,  
 HONGKONG, China  
 Contact Person : Youngil Chang / President  
 Telephone No. : +85-2-2682-6432  
 FCC ID : VA5CLC345-XC  
 Model Name : DR-XC  
 Brand Name : N/A  
 Serial Number : N/A  
 Date : July 28, 2023

EQUIPMENT CLASS	DTS – DIGITAL TRNSMISSION SYSTEM
E.U.T. DESCRIPTION	Dash cam
THIS REPORT CONCERNS	Original Grant
MEASUREMENT PROCEDURES	ANSI C63.10: 2013
TYPE OF EQUIPMENT TESTED	Pre-Production
KIND OF EQUIPMENT AUTHORIZATION REQUESTED	Certification
EQUIPMENT WILL BE OPERATED UNDER FCC RULES PART(S)	FCC PART 15 SUBPART C Section 15.247 KDB 558074 D01 15.247 Meas Guidance v05r02
Modifications on the Equipment to Achieve Compliance	None
Final Test was Conducted On	3 m, Semi Anechoic Chamber

-. The above equipment was tested by ONETECH Corp. for compliance with the requirement set forth in the FCC Rules and Regulations. This said equipment in the configuration described in this report, shows the maximum emission levels emanating from equipment are within the compliance requirements.

## 2. TEST SUMMARY

### 2.1 Test items and results

SECTION	TEST ITEMS	RESULTS
15.247 (a) (2)	Minimum 6 dB Bandwidth	Met the Limit / PASS
15.247 (b) (3)	Maximum Peak Conducted Output Power	Met the Limit / PASS
15.247 (d)	100 kHz Bandwidth Outside the Frequency Band	Met the Limit / PASS
15.247 (d)	Radiated Emission which fall in the Restricted Band	Met the Limit / PASS
15.247 (e)	Peak Power Spectral Density	Met the Limit / PASS
15.209	Radiated Emission Limits	Met the Limit / PASS
15.207	Conducted Limits	N/A (See Note)
15.203	Antenna Requirement	Met requirement / PASS

Note: This test is not performed because the EUT is operated by DC Power.

### 2.2 Additions, deviations, exclusions from standards

No additions, deviations or exclusions have been made from standard.

### 2.3 Related Submittal(s) / Grant(s)

Original submittal only

### 2.4 Purpose of the test

To determine whether the equipment under test fulfills the requirements of the regulation stated in FCC PART 15 SUBPART C Section 15.247.

### 2.5 Test Methodology

Both conducted and radiated testing was performed according to the procedures in ANSI C63.10: 2013. Radiated testing was performed at a distance of 3 m from EUT to the antenna.

### 2.6 Test Facility

The Onetech Corp. has been designated to perform equipment testing in compliance with ISO/IEC 17025.

The Electromagnetic compatibility measurement facilities are located at 43-14, Jinsaegol-gil, Chowol-eup, Gwangju-si, Gyeonggi-do, 12735, Korea.

-. Site Filing:

VCCI (Voluntary Control Council for Interference) – Registration No. R-20122/ C-14617/ G-10666/ T-11842

ISED (Innovation, Science and Economic Development Canada) – Registration No. Site# 3736A-3

KOLAS (Korea Laboratory Accreditation Scheme) - Accreditation NO. KT085

FCC (Federal Communications Commission) - Accreditation No. KR0013

RRA (Radio Research Agency) – Designation No. KR0013

### 3. GENERAL INFORMATION

#### 3.1 Product Description

The SEGI LIMITED, Model DR-XC (referred to as the EUT in this report) is a Dash cam. The product specification described herein was obtained from product data sheet or user’s manual.

DEVICE TYPE	Dash cam	
Temperature Range	-20 °C ~ 70 °C	
OPERATING FREQUENCY	Bluetooth LE	2 402 MHz ~ 2 480 MHz
	WLAN 2.4 GHz	2 412 MHz ~ 2 472 MHz (802.11b/g/n(HT20))
		2 422 MHz ~ 2 462 MHz (802.11n(HT40))
MODULATION TYPE	Bluetooth LE	GFSK for 1 Mbps
	WLAN 2.4 GHz	802.11b: DSSS Modulation(DBPSK/DQPSK/CCK) 802.11g/n(HT20)/n(HT40): OFDM Modulation(BPSK/QPSK/16QAM/64QAM)
RF OUTPUT POWER	Bluetooth LE	0.06 dBm
	WLAN 2.4 GHz	12.44 dBm(802.11b) 6.92 dBm(802.11g) 7.12 dBm(802.11n_HT20) 7.01 dBm(802.11n_HT40)
ANTENNA TYPE	Chip Antenna	
ANTENNA GAIN	1.69 dBi	
List of each Osc. or crystal Freq.(Freq. >= 1 MHz)	8 MHz, 24 MHz, 38.4 MHz	

#### 3.2 Alternative type(s)/model(s); also covered by this test report.

-. None

#### 4. EUT MODIFICATIONS

-. None

## 5. SYSTEM TEST CONFIGURATION

### 5.1 Justification

This device was configured for testing in a typical way as a normal customer is supposed to be used. During the test, the following components were installed inside of the EUT.

DEVICE TYPE	MANUFACTURER	MODEL/PART NUMBER	FCC ID
Main Board	N/A	N/A	N/A
Antenna	N/A	N/A	N/A
Module	Quectel Wireless Solutions Co., Ltd	EG95-NAXD	XMR202008EG95NAXD

### 5.2 Peripheral equipment

Defined as equipment needed for correct operation of the EUT, but not considered as tested:

Model	Manufacturer	Description	Connected to
DR-XC	SEGI R&D LIMITED	Dash cam (EUT)	-
GP-4303D	LG Precision Co.,Ltd	DC Power Supply (DC 30 V 3 A)	-
Ideapad320	LENOVO	NoteBook	EUT



### 5.3 Mode of operation during the test

For the testing, software used to control the EUT for staying in continuous transmitting is programmed.

For final testing, the EUT was set at 2 402 MHz, 2 440 MHz, and 2 480 MHz to get a maximum emission levels from the EUT. The EUT was moved throughout the XY, XZ, and YZ planes and the worst case is “XY” axis, but the worst data was recorded in this report.

#### -. Channel List (Bluetooth LE)

Channel	Frequency[MHz]	Channel	Frequency[MHz]	Channel	Frequency[MHz]
0	2 402.00	14	2 430.00	28	2 458.00
1	2 404.00	15	2 432.00	29	2 460.00
2	2 406.00	16	2 434.00	30	2 462.00
3	2 408.00	17	2 436.00	31	2 464.00
4	2 410.00	18	2 438.00	32	2 466.00
5	2 412.00	19	2 440.00	33	2 468.00
6	2 414.00	20	2 442.00	34	2 470.00
7	2 416.00	21	2 444.00	35	2 472.00
8	2 418.00	22	2 446.00	36	2 474.00
9	2 420.00	23	2 448.00	37	2 476.00
10	2 422.00	24	2 450.00	38	2 478.00
11	2 424.00	25	2 452.00	39	2 480.00
12	2 426.00	26	2 454.00		
13	2 428.00	27	2 456.00		

- Duty Cycle

Mode	Tx On Time [ ms ]	Tx Off Time [ ms ]	Duty Cycle [ % ]	Correction Factor [ dB ]
Bluetooth LE_1 Mbps	0.395	0.626	63.08%	2.00

Note – Duty Cycle : (Tx On Time / (Tx On Time + Tx Off Time)) \* 100

Correction Factor : 10 \* Log(1 / (Duty Cycle / 100))

- Test Plot

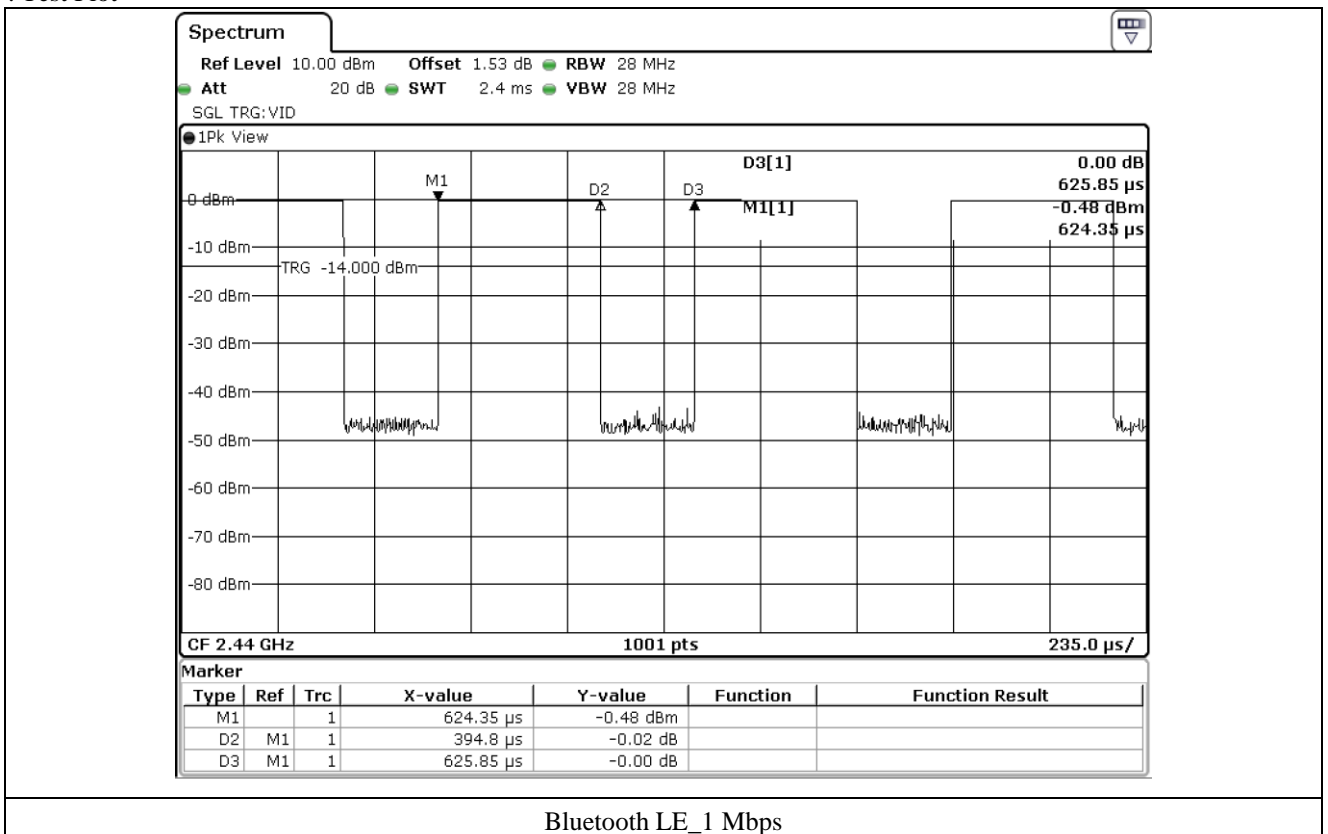

**5.4 Configuration of Test System**

**Line Conducted Test:** It is not need to test this requirement, because the EUT shall be operated by DC Power.

**Radiated Emission Test:** Preliminary radiated emissions test were conducted using the procedure in ANSI C63.10: 2013 to determine the worse operating conditions. Final radiated emission tests were conducted at 3 meter Semi Anechoic Chamber.

The turntable was rotated through 360 degrees and the EUT was tested by positioned three orthogonal planes to obtain the highest reading on the field strength meter. Once maximum reading was determined, the search antenna was raised and lowered in both vertical and horizontal polarization.

**5.5 Antenna Requirement**

For intentional device, according to section 15.203, an intentional radiator shall be designed to ensure that no antenna other than that furnished by the responsible party shall be used with the device.

**Antenna Construction:**

The antenna of the EUT is a Chip Antenna on the main Board in the EUT, so that it cannot be replaced by the user.

**6. PRELIMINARY TEST**

**6.1 AC Power line Conducted Emissions Tests**

During Preliminary Test, the following operating mode was investigated.

Operation Mode	The Worse operating condition (Please check one only)
It is not need to test this requirement, because the power of the EUT is supplied by DC Power.	

**6.2 General Radiated Emissions Tests**

During Preliminary Test, the following operating mode was investigated.

Operation Mode	The Worse operating condition (Please check one only)
Transmitting Mode	X

## 7. MINIMUM 6 dB BANDWIDTH

### 7.1 Operating environment

Temperature : 24 °C

Relative humidity : 53 % R.H.

### 7.2 Test set-up

The antenna output of the EUT was connected to the spectrum analyzer. The resolution bandwidth is set to 100 kHz, and peak detection was used. The 6 dB bandwidth is defined as the total spectrum over which the power is higher than the peak power minus 6 dB.

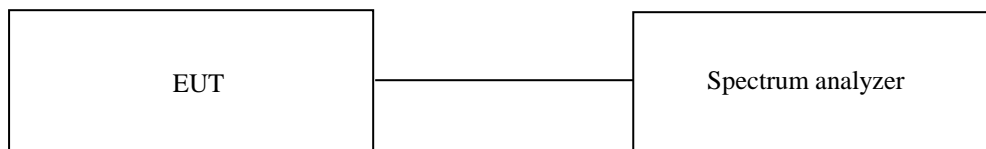

### 7.3 Test Date

July 05, 2023 ~ July 13, 2023

**7.4 Test data for 1 Mbps**

CHANNEL	FREQUENCY(MHz)	MEASURED VALUE (kHz)	LIMIT (kHz)	MARGIN (kHz)
Low	2 402.00	654.30	500.00	154.30
Middle	2 440.00	654.30	500.00	154.30
High	2 480.00	654.30	500.00	154.30

Remark. Margin = Measured Value - Limit

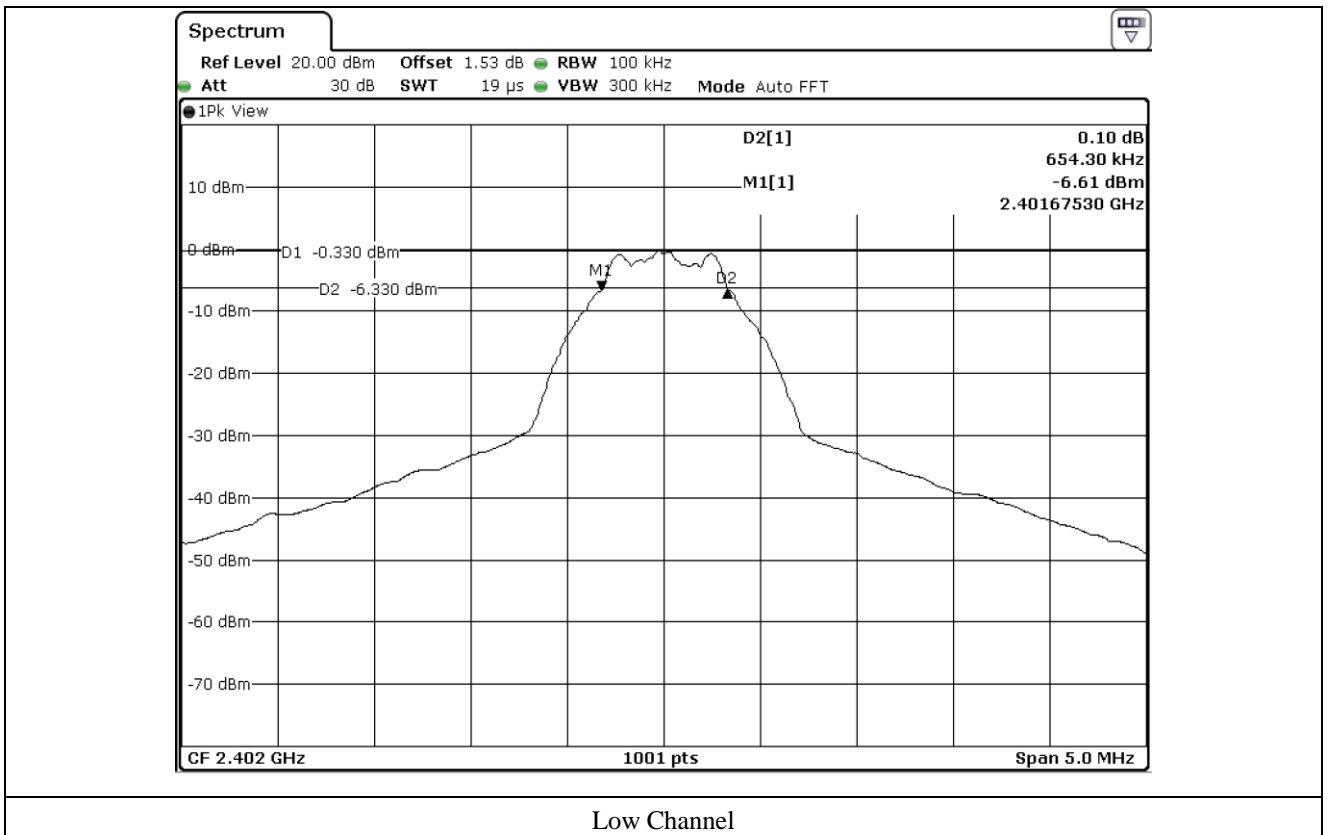

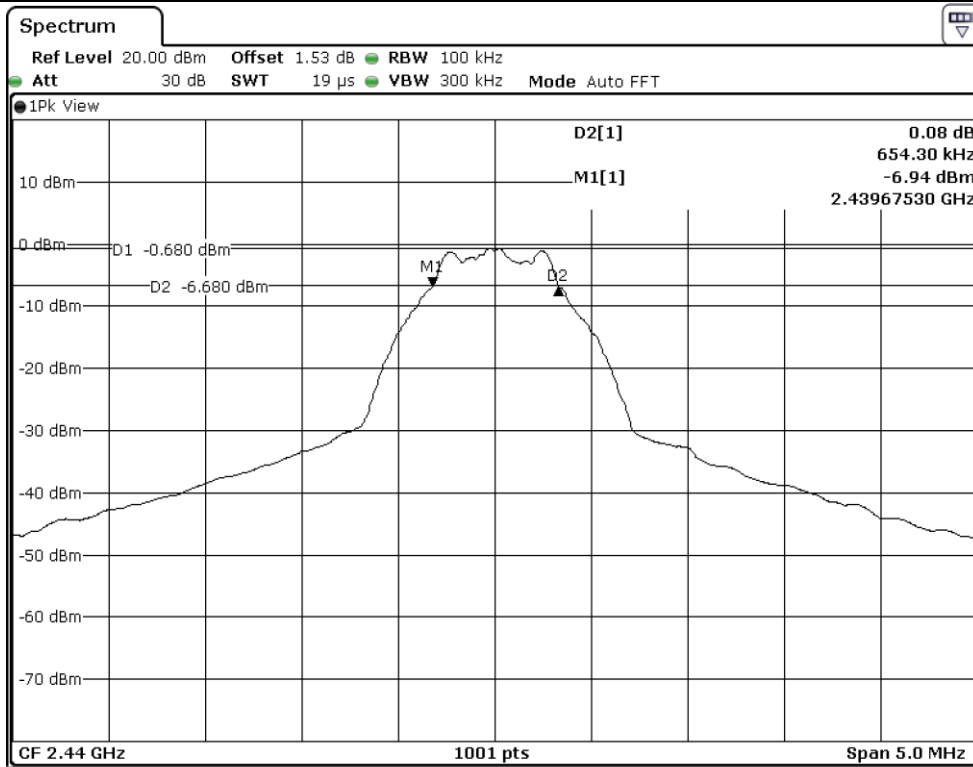

Middle Channel

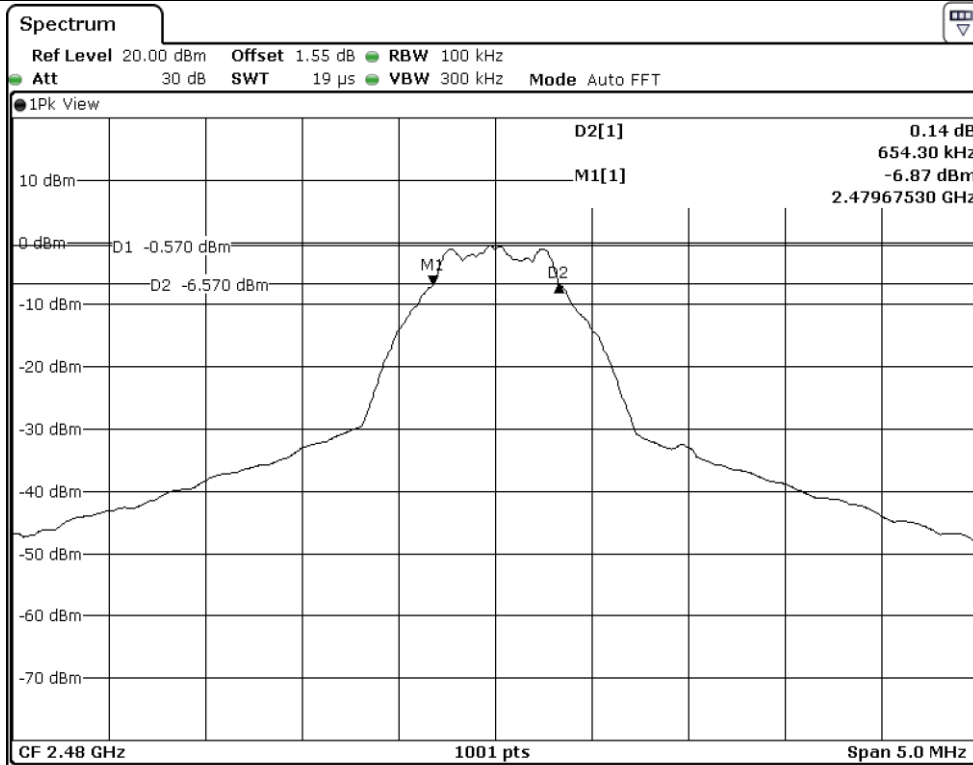

High Channel

## 8. MAXIMUM PEAK OUTPUT POWER

### 8.1 Operating environment

Temperature : 24 °C

Relative humidity : 53 % R.H.

### 8.2 Test set-up

The antenna output of the EUT was connected to the spectrum analyzer.

The resolution bandwidth is set to  $\geq$  DTS Bandwidth, the video bandwidth is set to 3 times the resolution bandwidth.

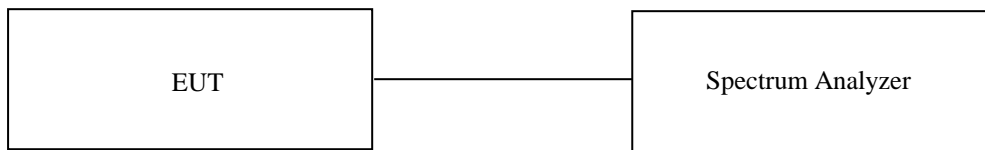

### 8.3 Test Date

July 05, 2023 ~ July 13, 2023

### 8.4 Test data for 1 Mbps

- Test Result : Pass

CHANNEL	FREQUENCY (MHz)	MEASURED VALUE (dBm)	LIMIT (dBm)	MARGIN (dB)
LOW	2 402.00	0.06	30.00	29.94
MIDDLE	2 440.00	-0.30	30.00	30.30
HIGH	2 480.00	-0.20	30.00	30.20

Remark. Margin = Limit – Measured Value (=Receiver Reading + Cable Loss)

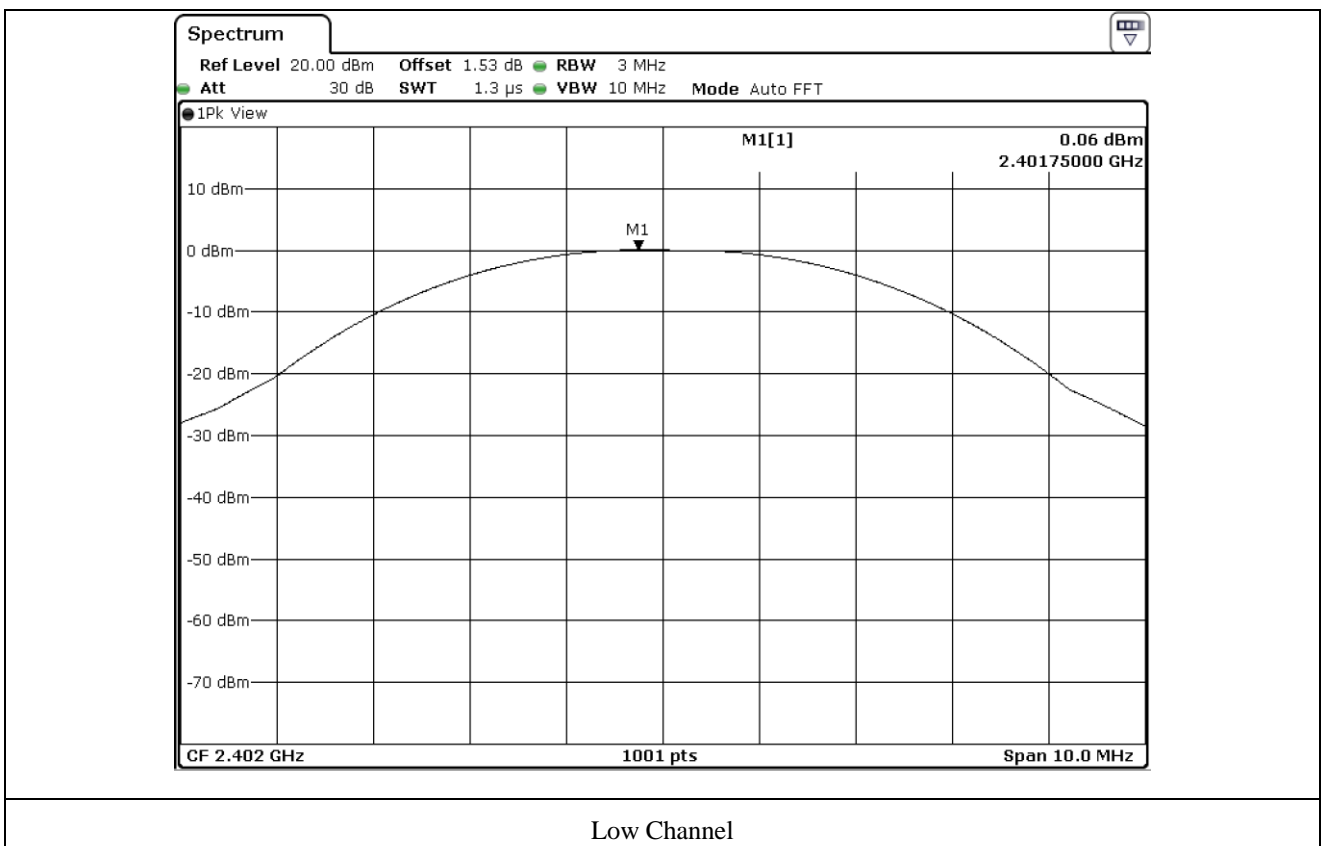

Low Channel



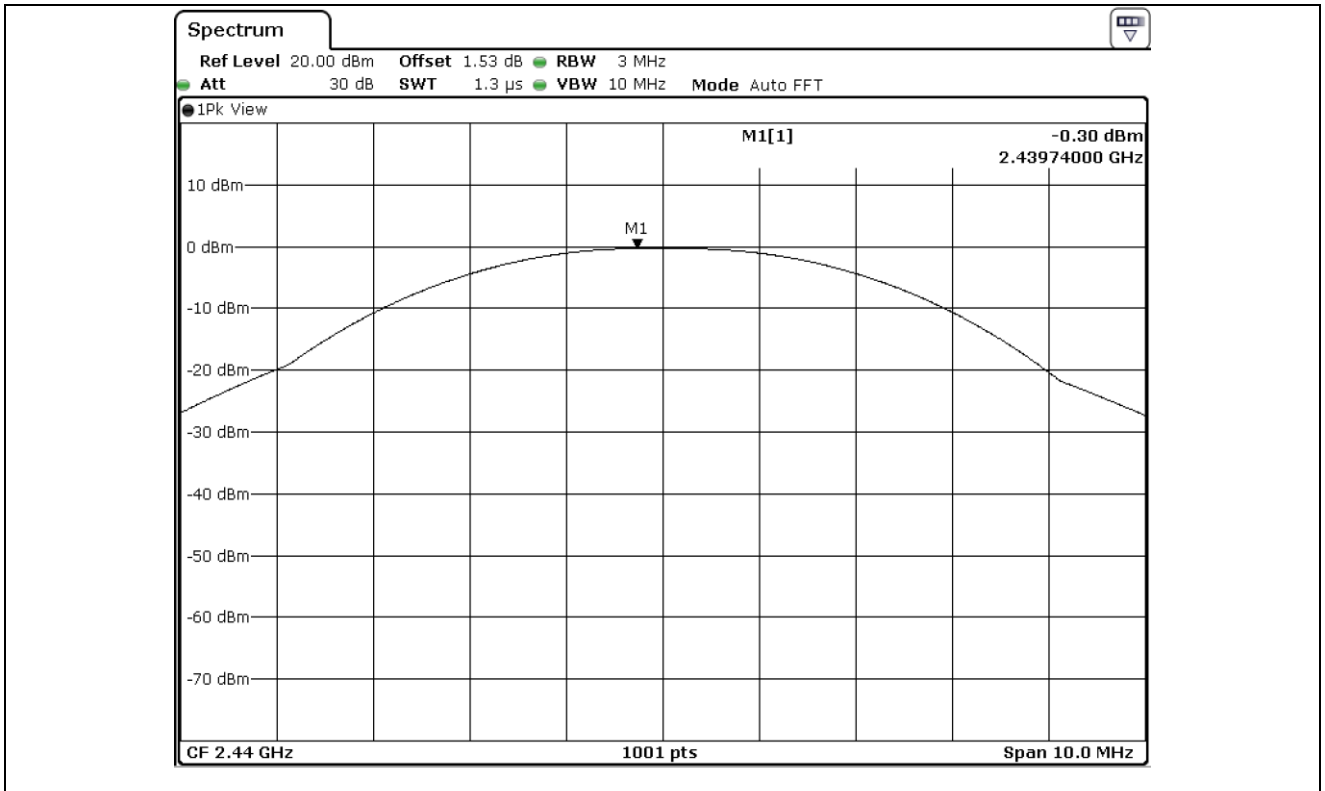

Middle Channel

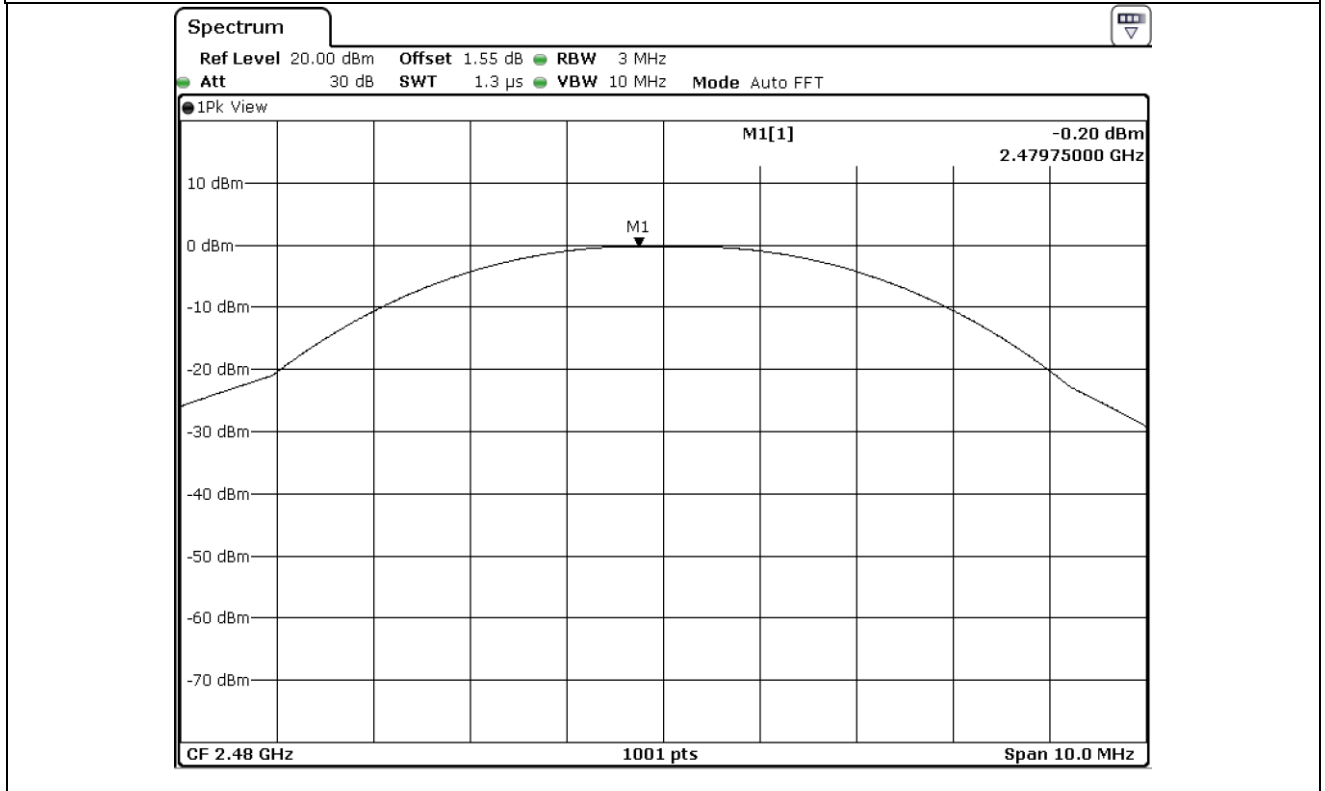

High Channel

## 9. 100 kHz BANDWIDTH OUTSIDE THE FREQUENCY BAND

### 9.1 Operating environment

Temperature : 24 °C

Relative humidity : 53 % R.H.

### 9.2 Test set-up for conducted measurement

The antenna output of the EUT was connected to the spectrum analyzer. The resolution bandwidth is set to 100 kHz, the video bandwidth is set to 3 times the resolution bandwidth and peak detection was used.

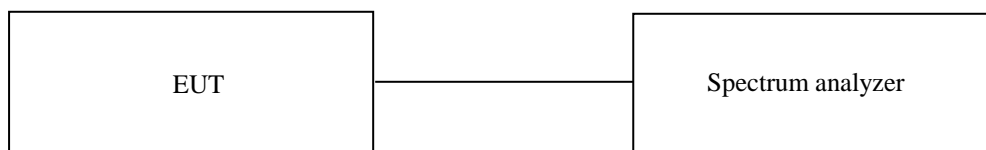

### 9.3 Test set-up for radiated measurement

The radiated emissions measurements were performed on the 3 m semi anechoic chamber. The EUT was placed on turntable approximately 1.5 m above the ground plane.

The frequency spectrum from 30 MHz to 26.5 GHz was scanned and maximum emission levels at each frequency recorded. The system was rotated 360°, and the antenna was varied in the height between 1.0 m and 4.0 m in order to determine the maximum emission levels. This procedure was performed for horizontal and vertical polarization of the receiving antenna.

### 9.4 Test Date

July 05, 2023 ~ July 13, 2023

9.5 Test data for conducted emission

9.5.1 Test data for 1 Mbps

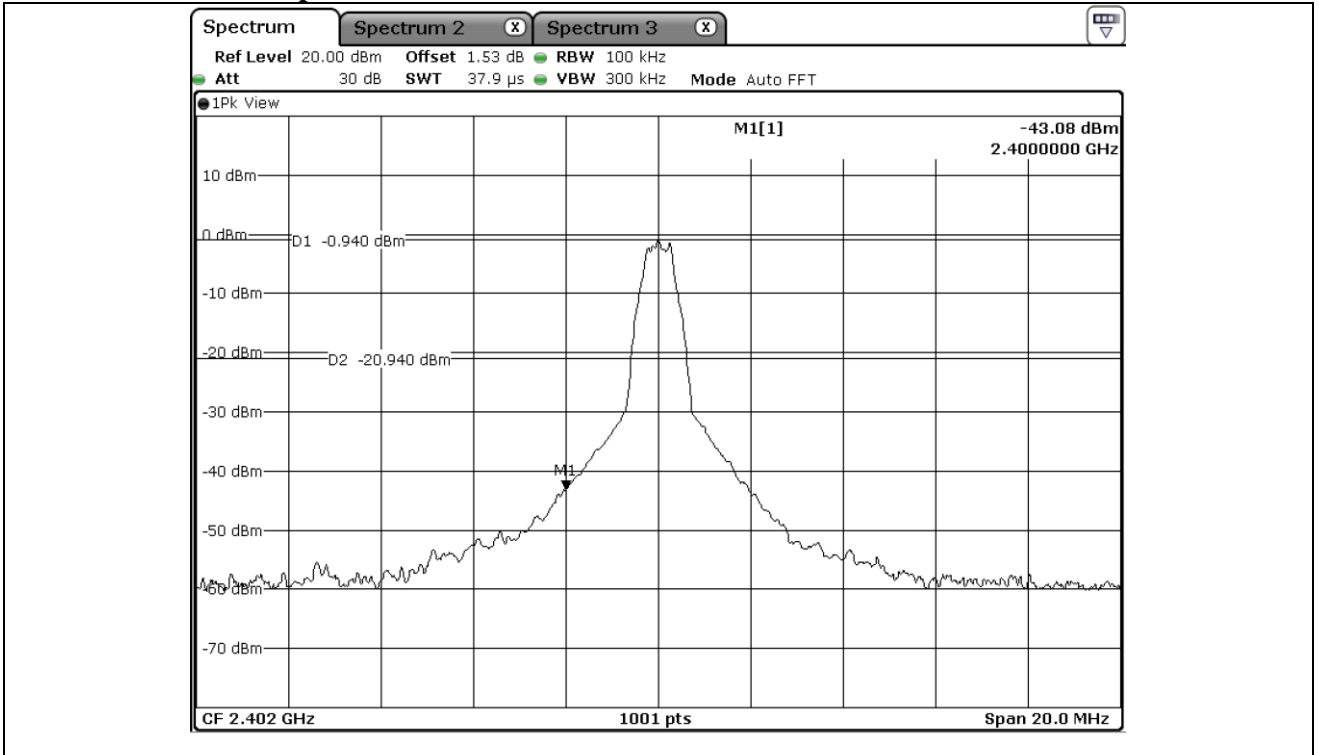

Low Channel

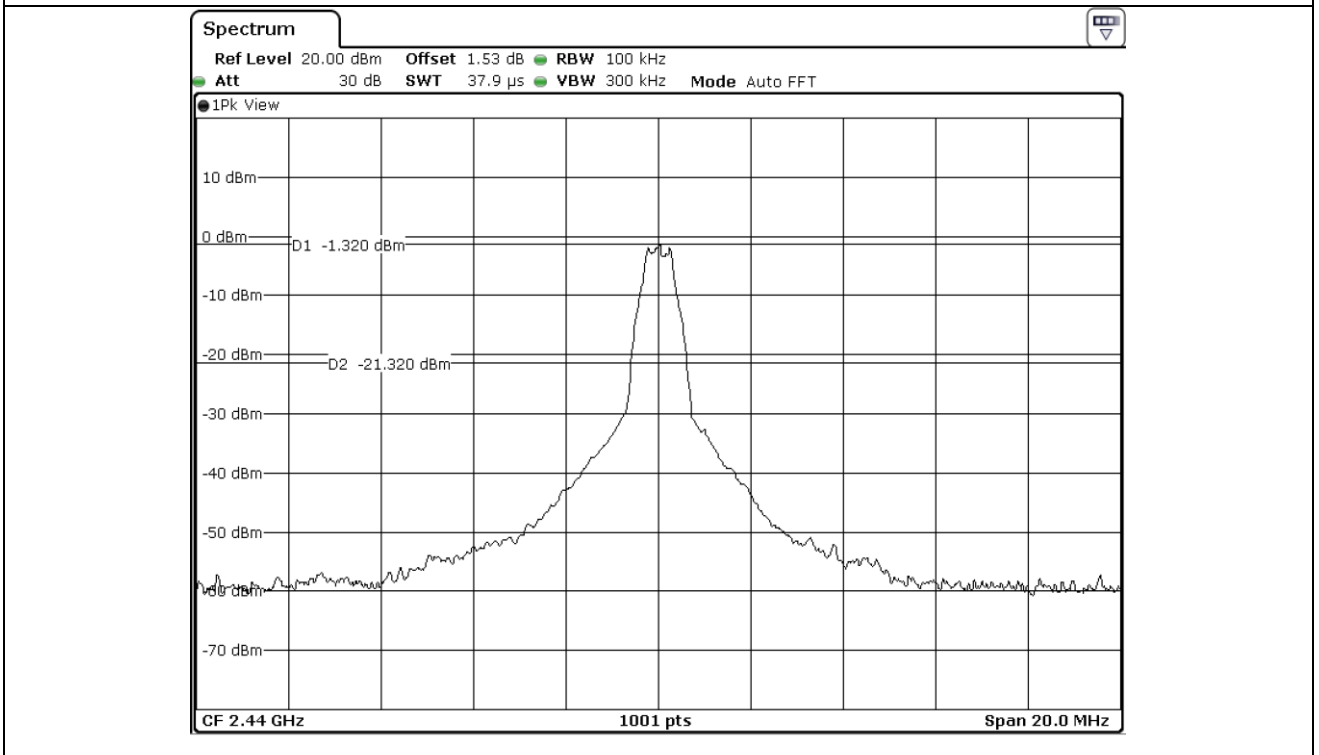

Middle Channel

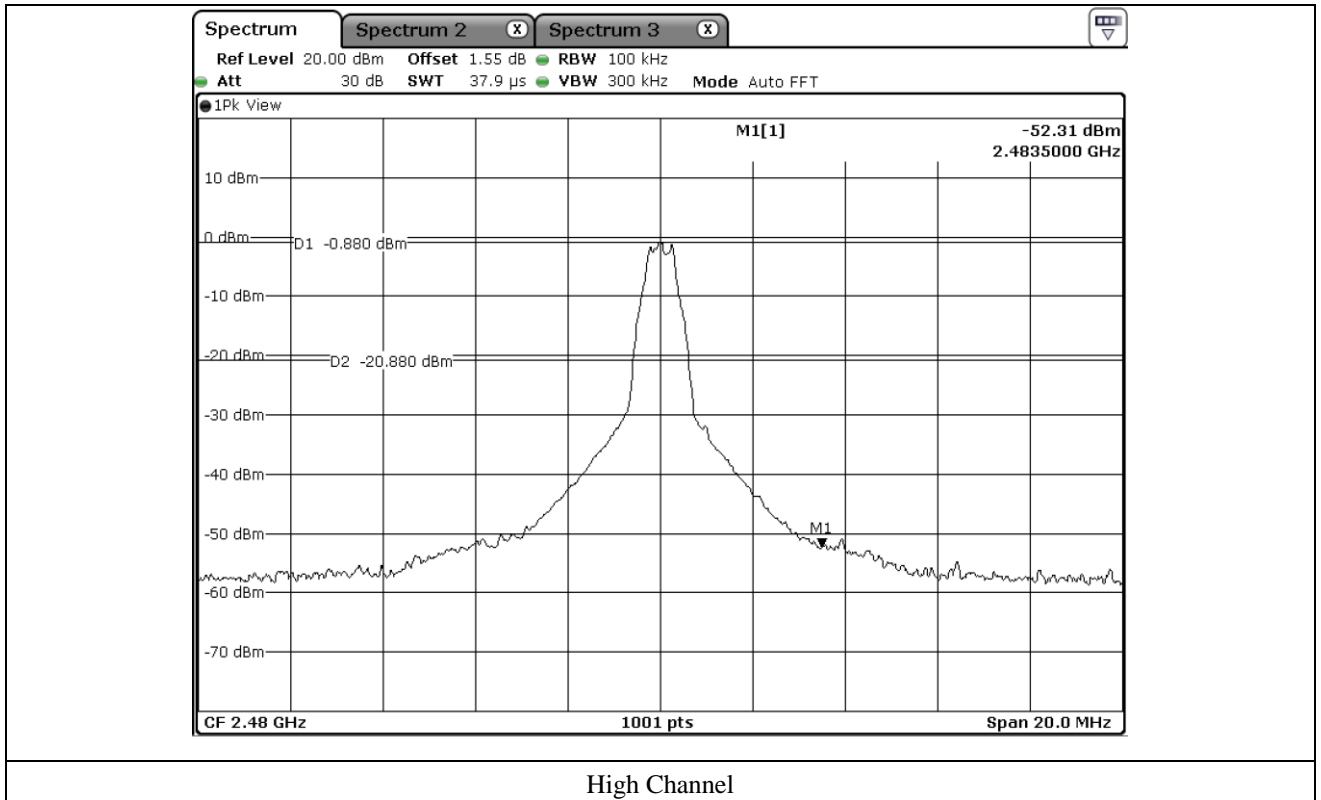

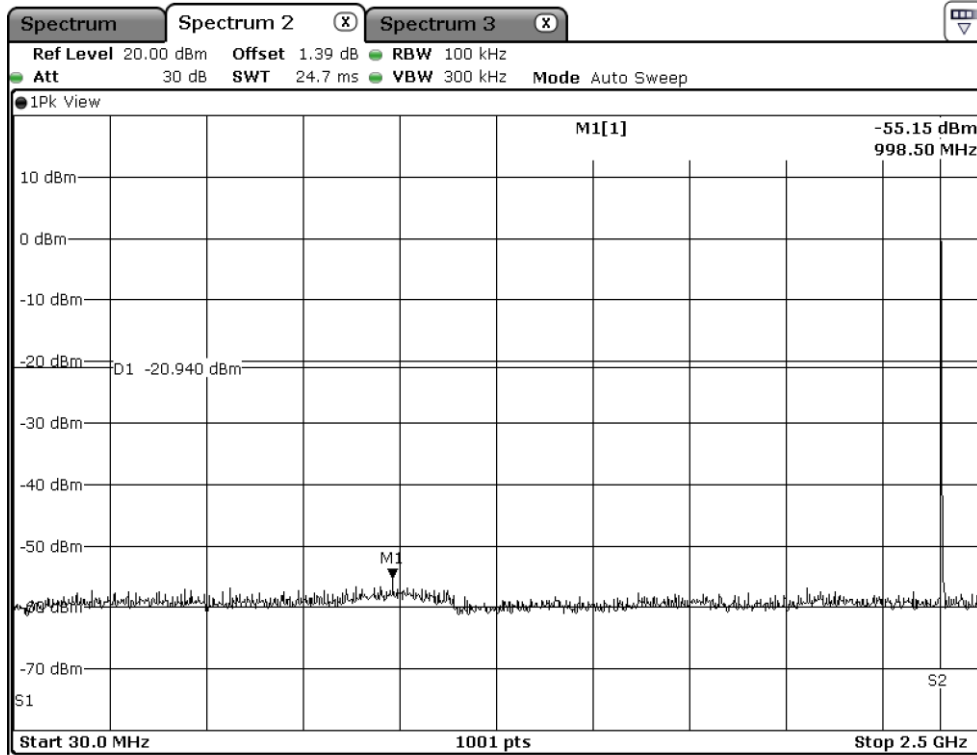

Low Channel

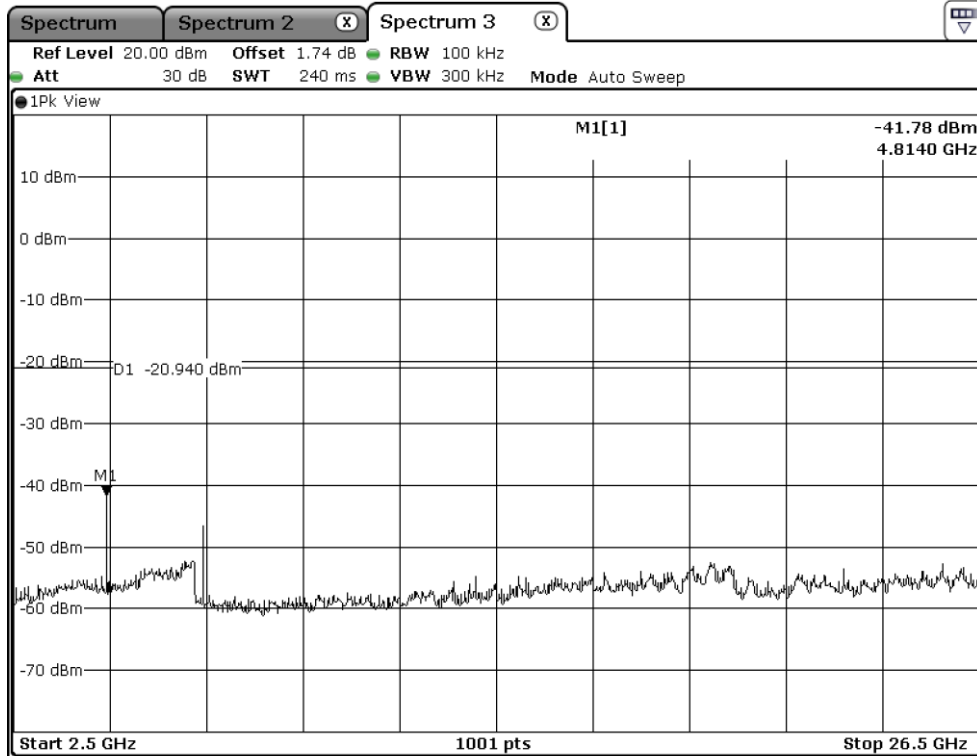

Low Channel

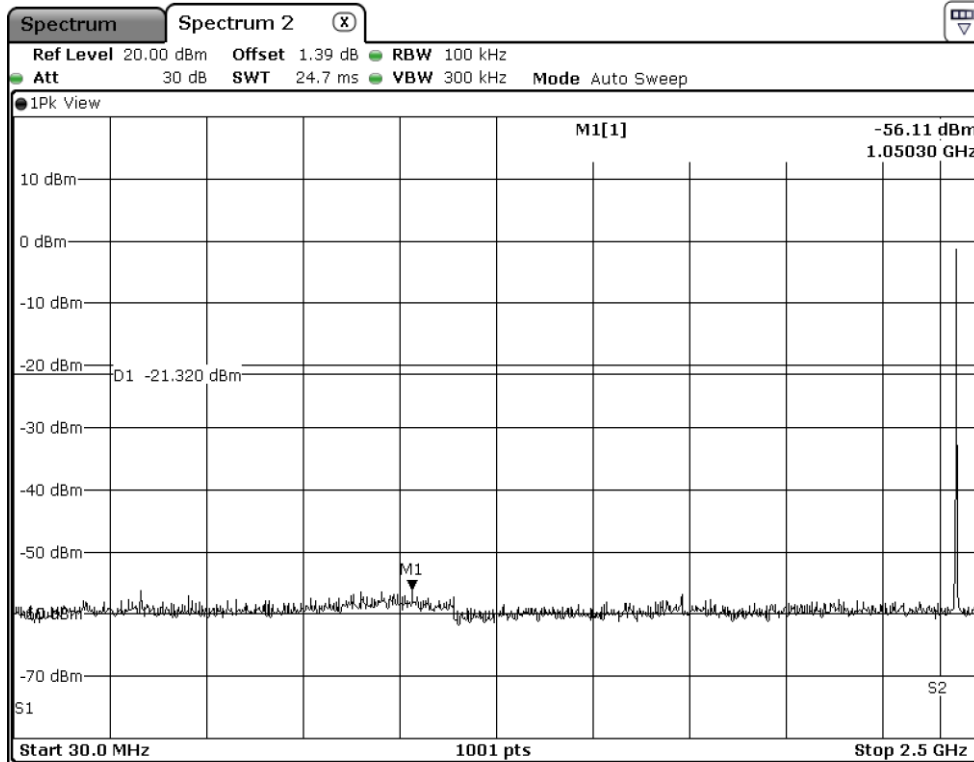

Middle Channel

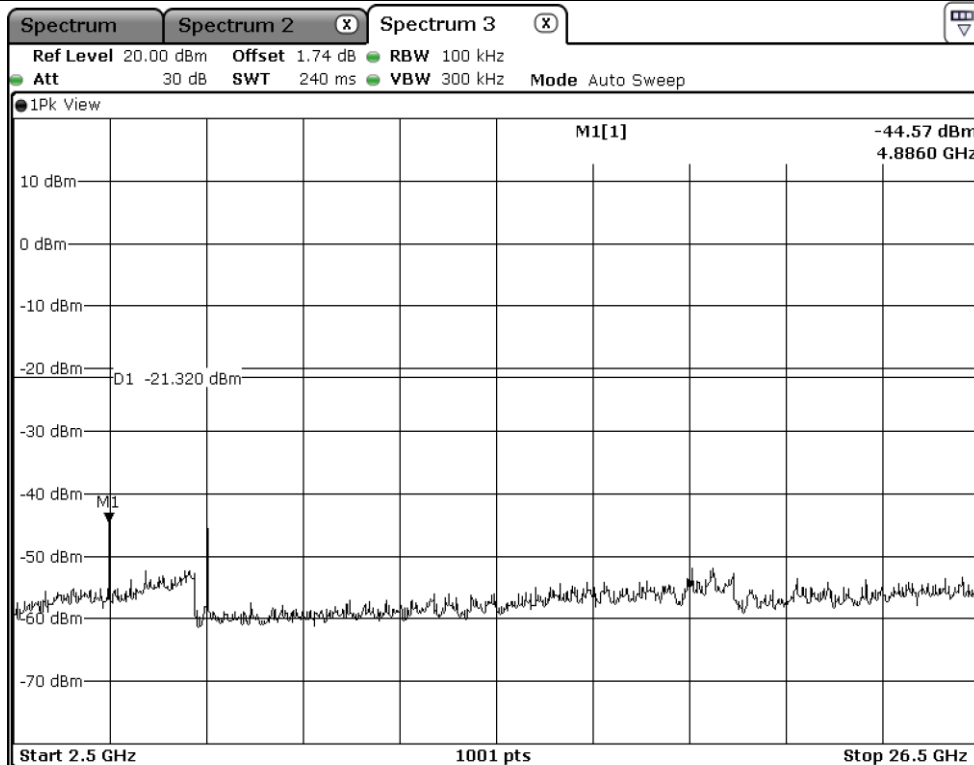

Middle Channel

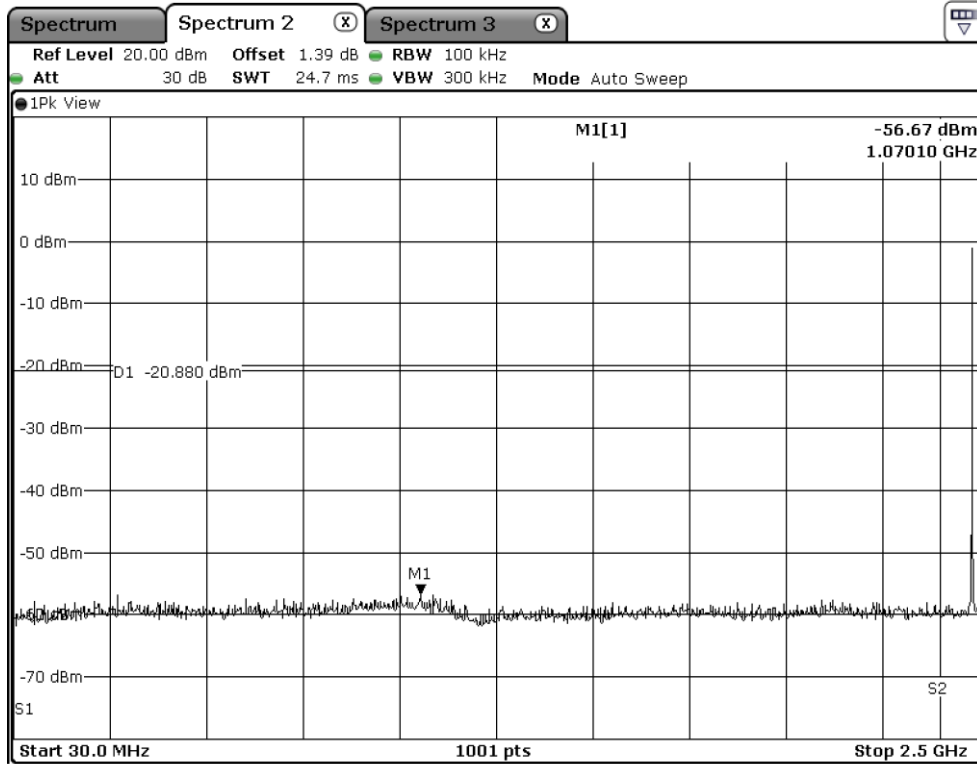

High Channel

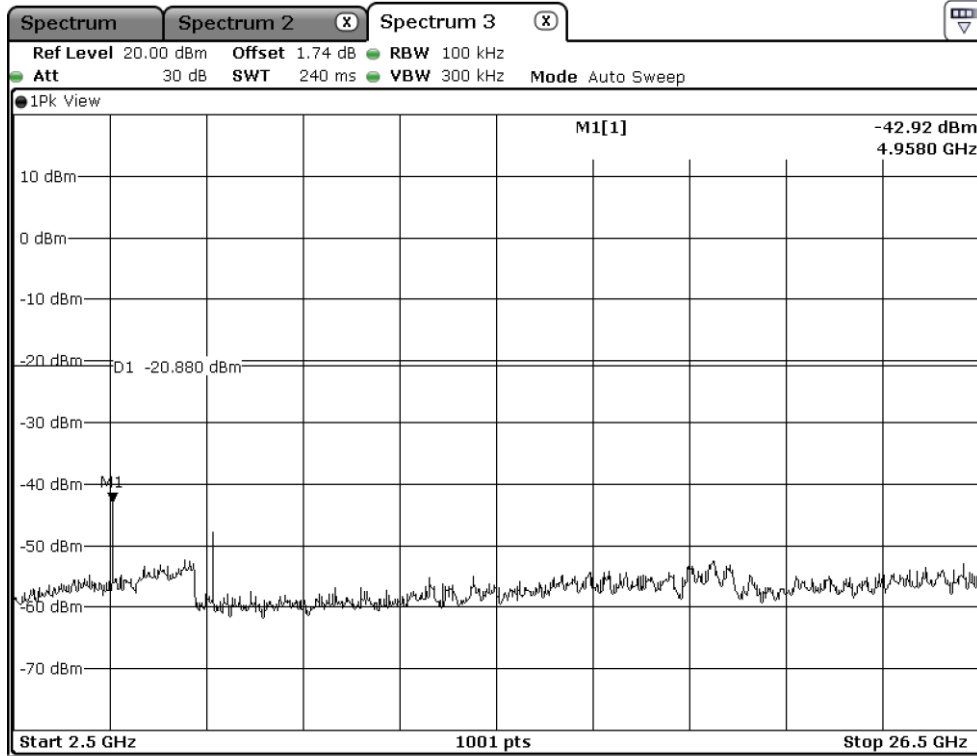

High Channel

**9.6 Test data for radiated emission**

**9.6.1 Radiated Emission which fall in the Restricted Band**

**9.6.1.1 Test data for 1 Mbps**

- Resolution bandwidth : 1 MHz and Peak Detector for Peak Mode  
1 MHz and RMS Detector for Average Mode
- Video bandwidth : 3 MHz for Peak and Average Mode
- Measurement distance : 3 m
- Duty Cycle : 63.08 %
- Result : PASSED

Frequency (MHz)	Reading (dBμV)	Detector Mode	Ant. Pol. (H/V)	Ant. Factor	Cable Loss	AMP Gain	ATT (dB)	Duty Factor (dB)	Total (dBμV/m)	Limits (dBμV/m)	Margin (dB)
<b>Test Data for Low Channel</b>											
2 312.44	53.15	Peak	H	27.75	6.60	44.98	9.95	-	52.47	74.00	21.53
2 330.36	40.91	Average	H	27.54	6.59	44.97	9.95	2.00	42.02	54.00	11.98
2 365.01	54.32	Peak	V	27.33	6.77	44.95	9.95	-	53.42	74.00	20.58
2 326.04	40.91	Average	V	27.59	6.59	44.97	9.95	2.00	42.07	54.00	11.93
<b>Test Data for High Channel</b>											
2 483.93	56.54	Peak	H	27.43	6.94	44.91	9.95	-	55.95	74.00	18.05
2 483.65	41.77	Average	H	27.43	6.94	44.91	9.95	2.00	43.18	54.00	10.82
2 483.71	54.77	Peak	V	27.43	6.94	44.91	9.95	-	54.18	74.00	19.82
2 498.99	41.43	Average	V	27.40	6.91	44.90	9.95	2.00	42.79	54.00	11.21

Remark: “H”: Horizontal, “V”: Vertical

Margin (dB) = Limits (dBμV/m) - Total Level (dBμV/m)

Total Level = Reading + Antenna Factor + Cable Loss – AMP Gain



### 9.6.2 Spurious & Harmonic Radiated Emission

#### 9.6.2.1 Test data for 1 Mbps

- Resolution bandwidth : 1 MHz for Peak and Average Mode for the emissions fall in restricted band,  
1 MHz for Peak Mode for the emissions outside restricted band
- Video bandwidth : 3 MHz for Peak and Average Mode
- Frequency range : 1 GHz ~ 26.5 GHz
- Measurement distance : 3 m
- Duty Cycle : 63.08 %
- Result : PASSED

Frequency (MHz)	Reading (dBμV)	Detector Mode	Ant. Pol. (H/V)	Ant. Factor	Cable Loss	AMP Gain	Duty Factor (dB)	Total (dBμV/m)	Limits (dBμV/m)	Margin (dB)
4 805.45	50.21	Peak	H	31.29	11.15	44.66	-	47.99	74.00	26.01
4 804.22	37.99	Average	H	31.29	11.15	44.66	2.00	37.77	54.00	16.23
4 803.64	51.84	Peak	V	31.29	11.15	44.66	-	49.62	74.00	24.38
4 804.06	41.07	Average	V	31.29	11.15	44.66	2.00	40.85	54.00	13.15
4 880.36	49.72	Peak	H	31.26	11.15	44.68	-	47.45	74.00	26.55
4 880.01	38.27	Average	H	31.26	11.15	44.68	2.00	38.00	54.00	16.00
4 879.60	52.00	Peak	V	31.26	11.15	44.68	-	49.73	74.00	24.27
4 879.91	42.03	Average	V	31.26	11.15	44.68	2.00	41.76	54.00	12.24
4 960.18	49.22	Peak	H	31.46	11.35	44.69	-	47.34	74.00	26.66
4 959.97	38.51	Average	H	31.46	11.35	44.69	2.00	38.63	54.00	15.37
4 959.70	52.49	Peak	V	31.46	11.35	44.69	-	50.61	74.00	23.39
4 960.14	43.28	Average	V	31.46	11.35	44.69	2.00	43.40	54.00	10.60

Remark: “H”: Horizontal, “V”: Vertical

$$\text{Margin (dB)} = \text{Limits (dB}\mu\text{V/m)} - \text{Total Level (dB}\mu\text{V/m)}$$

$$\text{Total Level} = \text{Reading} + \text{Antenna Factor} + \text{Cable Loss} - \text{AMP Gain}$$

## 10. PEAK POWER SPECTRAL DENSITY

### 10.1 Operating environment

Temperature : 24 °C

Relative humidity : 53 % R.H.

### 10.2 Test set-up

The antenna output of the EUT was connected to the spectrum analyzer.

The resolution bandwidth is set to  $3 \text{ kHz} \leq \text{RBW} \leq 100 \text{ kHz}$ , the video bandwidth is set to 3 times the resolution bandwidth.

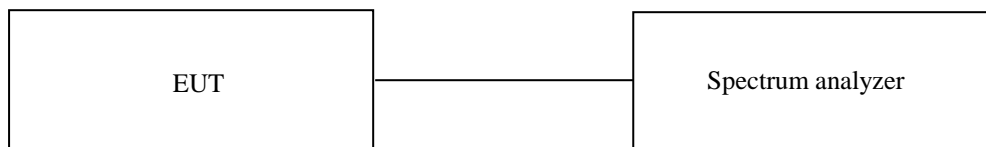

### 10.3 Test Date

July 05, 2023 ~ July 13, 2023

### 10.4 Test data for 1 Mbps

- Test Result : Pass

- Operating Condition : Continuous transmitting mode

CHANNEL	FREQUENCY(MHz)	MEASURED VALUE (dBm)	LIMIT (dBm)	MARGIN (dB)
Low	2 402.00	-14.78	8.00	22.78
Middle	2 440.00	-15.12	8.00	23.12
High	2 480.00	-15.02	8.00	23.02

Remark. Margin = Limit – Measured value

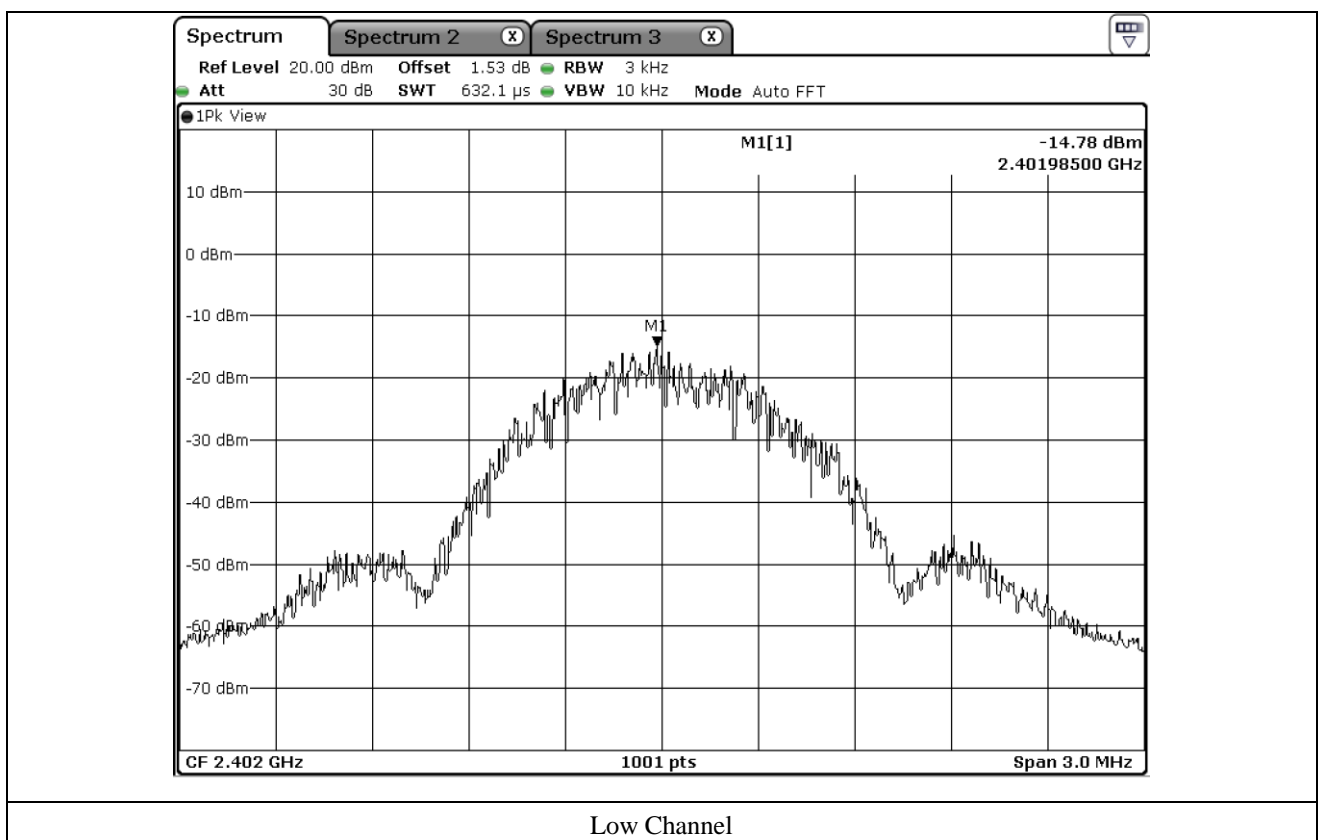

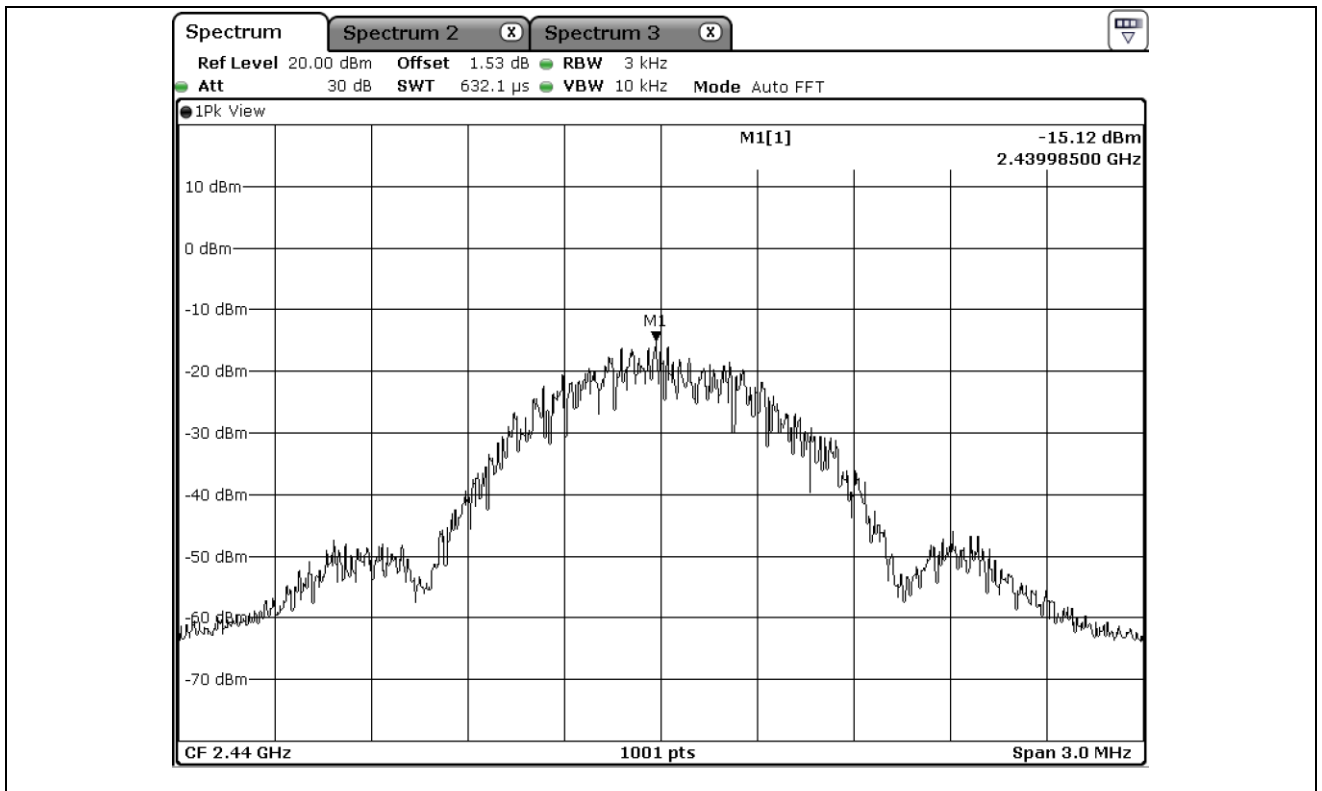

Middle Channel

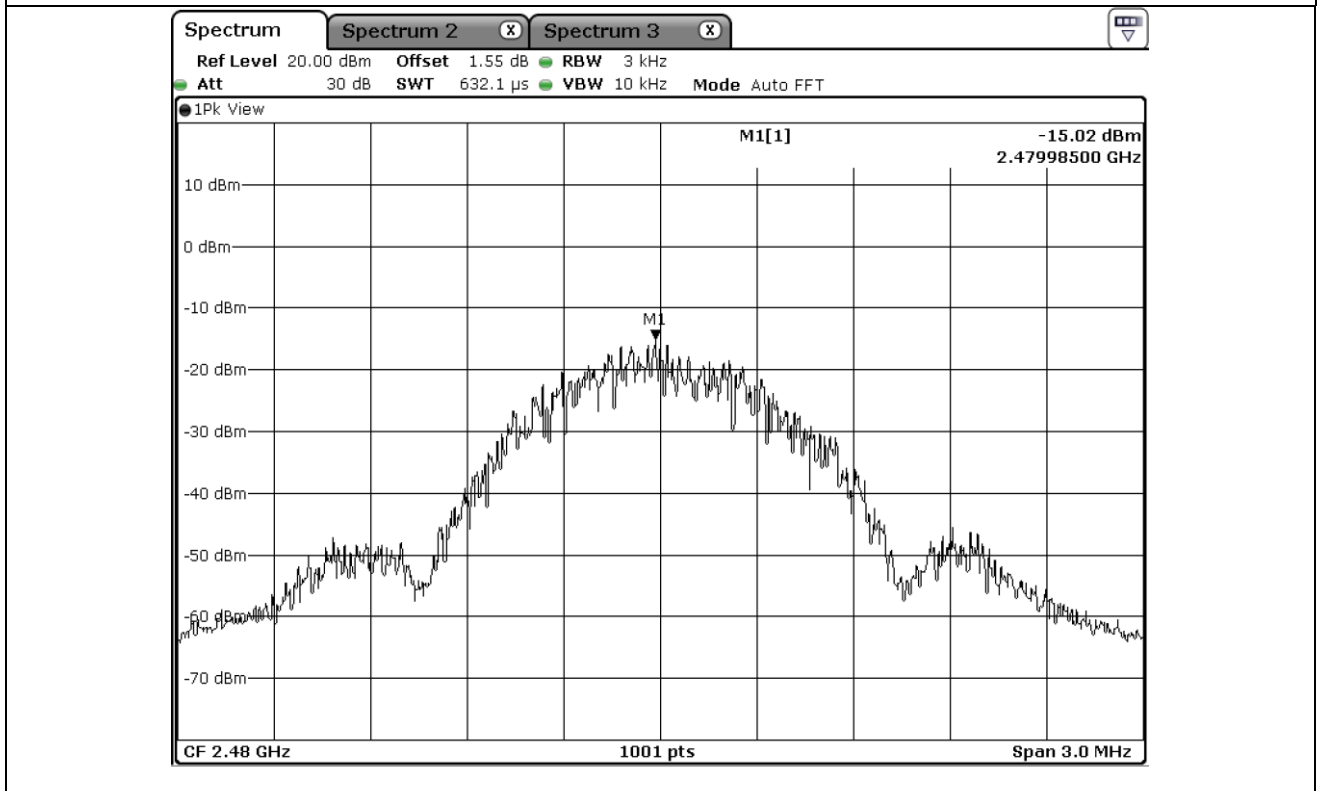

High Channel

## 11. RADIATED EMISSION TEST

### 11.1 Operating environment

Temperature : 24 °C  
 Relative humidity : 53 % R.H.

### 11.2 Test set-up

The radiated emissions measurements were on the 3 m semi anechoic chamber. The EUT and other support equipment were placed on a non-conductive turntable above the ground plane. The interconnecting cables from outside test site were inserted into ferrite clamps at the point where the cables reach the turntable.

The frequency spectrum from 30 MHz to 26.5 GHz was scanned and emission levels maximized at each frequency recorded. The system was rotated 360°, and the antenna was varied in height between 1.0 m and 4.0 m in order to determine the maximum emission levels. This procedure was performed for both horizontal and vertical polarization of the receiving antenna.

#### - Test Configuration

1. Below 30 MHz

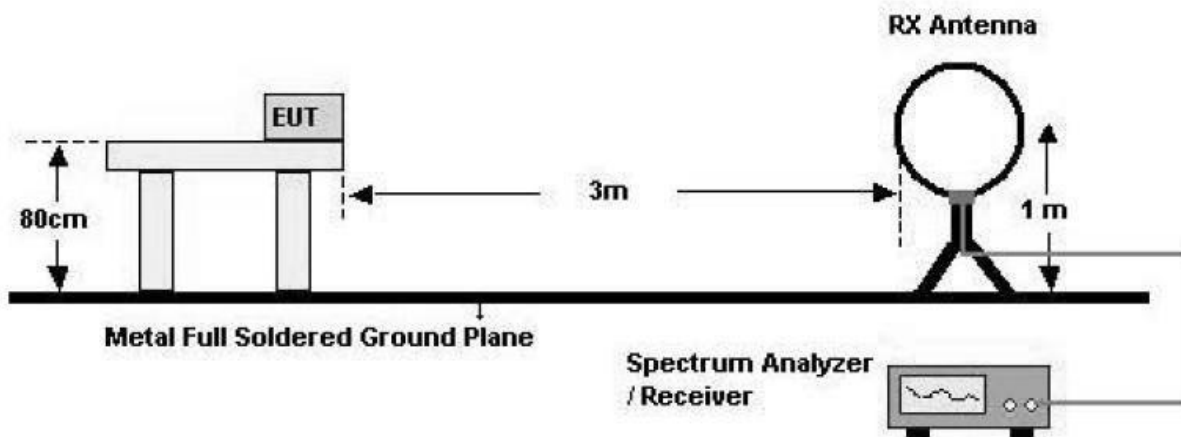

2. 30 MHz - 1 GHz

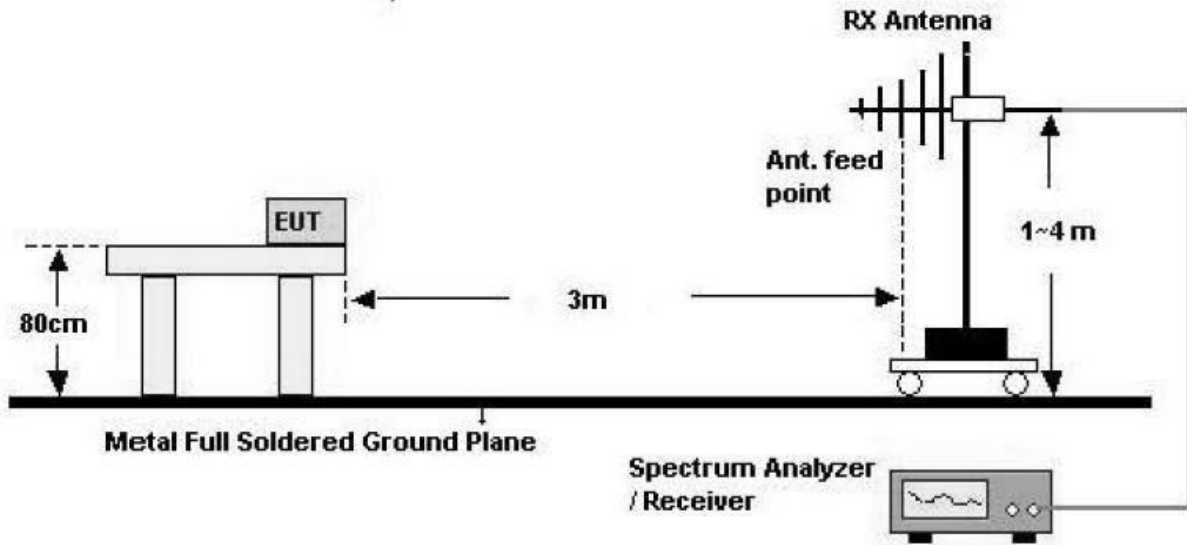

3. Above 1 GHz

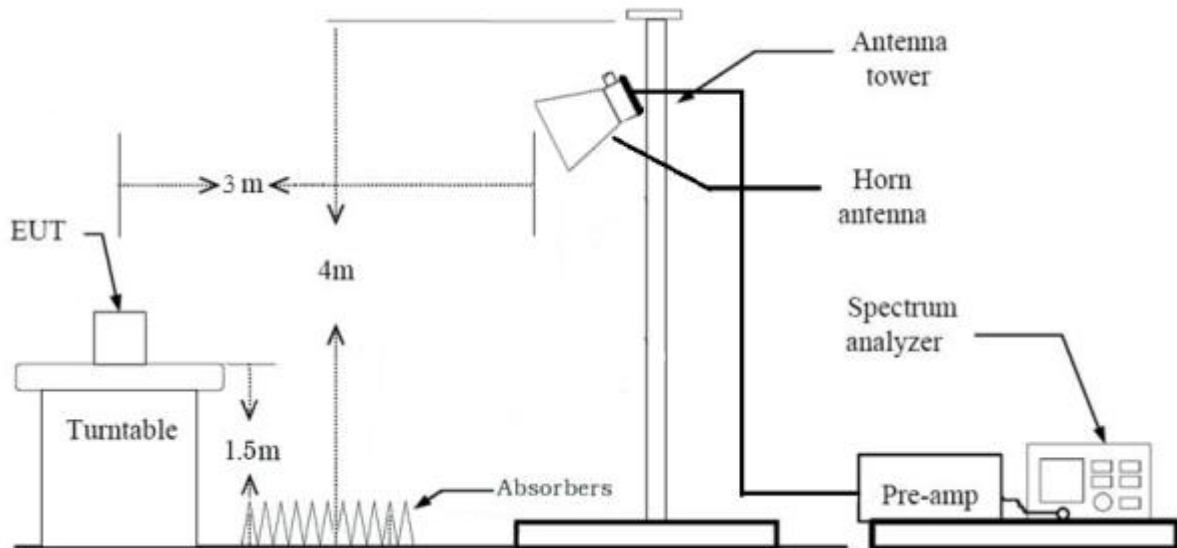

**11.3 Test Date**

July 05, 2023 ~ July 13, 2023

11.4 Test data for 30 MHz ~ 1 GHz

11.4.1 Test data for Transmitting Mode

Humidity Level : 52 % R.H. Temperature: 24 °C

Limits apply to : FCC CFR 47, PART 15, SUBPART C, SECTION 15.247

Result : PASSED

EUT : Dash cam

Detector : CISPR Quasi-Peak (6 dB Bandwidth: 120 kHz)

LIMIT : FCC Part15 Subpart.B Class B (3m)  
MARGIN: 5 dB

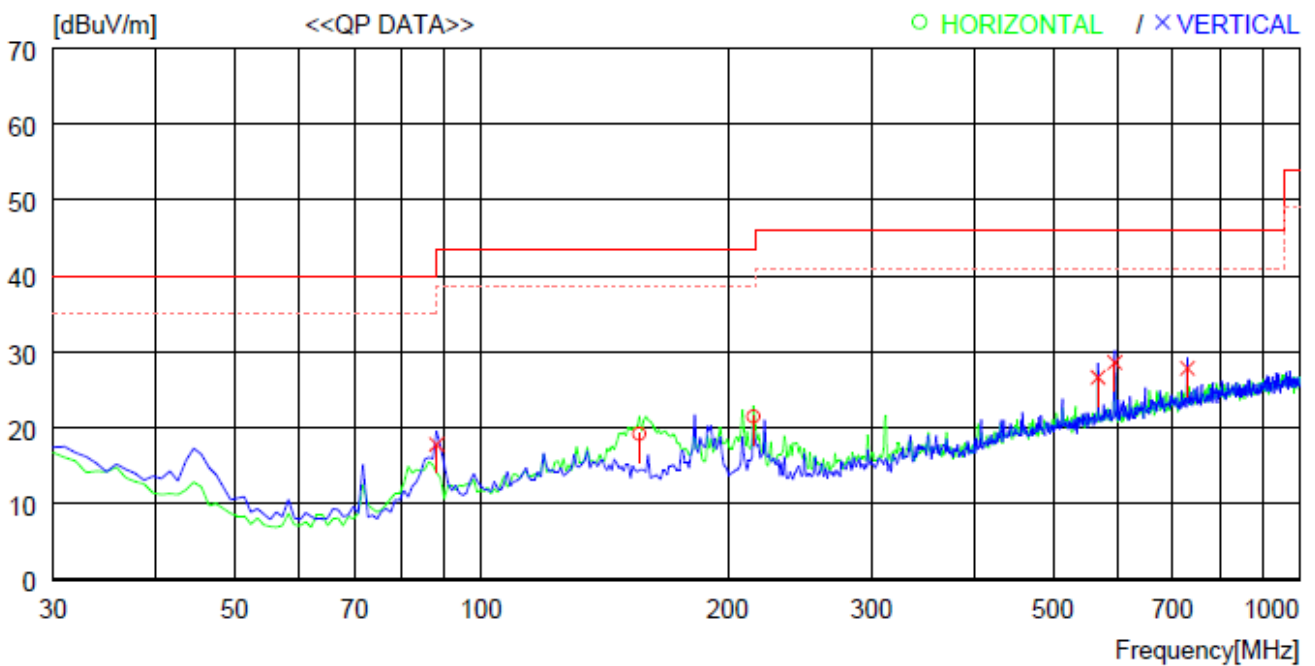

No.	FREQ [MHz]	READING QP [dBuV]	ANT FACTOR [dB]	LOSS [dB]	GAIN [dB]	RESULT [dBuV/m]	LIMIT [dBuV/m]	MARGIN [dB]	ANTENNA [cm]	TABLE [DEG]
----- Horizontal -----										
1	156.100	31.6	18.3	2.4	33.1	19.2	43.5	24.3	300	69
2	215.270	35.8	16.1	2.8	33.2	21.5	43.5	22.0	200	359
----- Vertical -----										
3	88.200	35.4	13.6	1.9	33.1	17.8	43.5	25.7	100	5
4	567.379	31.2	23.9	4.7	33.2	26.6	46.0	19.4	100	157
5	594.538	32.8	24.2	4.8	33.2	28.6	46.0	17.4	100	165
6	729.364	29.9	25.8	5.4	33.3	27.8	46.0	18.2	100	359

**11.5 Test data for Below 30 MHz**

- Resolution bandwidth : 200 Hz (from 9 kHz to 0.15 MHz), 9 kHz (from 0.15 MHz to 30 MHz)
- Frequency range : 9 kHz ~ 30 MHz
- Measurement distance : 3 m
- Operating mode : Transmitting mode

Frequency (MHz)	Reading (dBμV)	Ant. Pol. (H/V)	Ant. Height (m)	Angle (°)	Ant. Factor (dB/m)	Cable Loss	Emission Level(dBμV/m)	Limits (dBμV/m)	Margin (dB)
Emission from the EUT more than 20 dB below the limit in each frequency range.									

**11.6 Test data for above 1 GHz**

- Resolution bandwidth : 1 MHz for Peak and Average Mode for the emissions fall in restricted band,  
1 MHz for Peak Mode for the emissions outside restricted band
- Video bandwidth : 3 MHz for Peak and Average Mode
- Frequency range : 1 GHz ~ 26.5 GHz
- Measurement distance : 3 m
- Operating mode : Transmitting mode

Frequency (MHz)	Reading (dBμV)	Ant. Pol. (H/V)	Ant. Height (m)	Angle (°)	Ant. Factor (dB/m)	Cable Loss	Emission Level(dBμV/m)	Limits (dBμV/m)	Margin (dB)
Emission from the EUT more than 20 dB below the limit in each frequency range.									



## 12. LIST OF TEST EQUIPMENT

Model Number	Manufacturer	Description	Serial Number	Last Cal.(Interval)
FSV30	Rohde & Schwarz	Signal Analyzer	101199	Jan. 16, 2023 (1Y)
SMB100A	Rohde & Schwarz	Signal Generator	177648	Jan. 18, 2023 (1Y)
GP-4303D	LG Precision Co.,Ltd	DC Power Supply	5071069	Jan. 04, 2023 (1Y)
ESR	Rohde & Schwarz	EMI Test Receiver	101470	Oct. 18, 2023 (1Y)
HPF 3GHz	Rohde & Schwarz	High Pass Filter ( 1-3 GHz )	N/A	Jan. 17, 2023 (1Y)
10 dB Attenuator	Rohde & Schwarz	10 dB Attenuator	14100882-3	Jul. 14, 2022 (1Y)
310N	Sonoma Instrument	Pre-Amplifier	312544	Mar. 14, 2023 (1Y)
SCU18	Rohde & Schwarz	Pre-Amplifier	102266	Jul. 12, 2022 (1Y)
SCU40A	Rohde & Schwarz	Signal Conditioning unit	100436	Jan. 18, 2023 (1Y)
FMZB 1513	Schwarzbeck	Loop Antenna	1513-235	Mar. 24, 2022 (2Y)
HLP-2008	TDK	Hybrid Antenna	131316	Mar. 07, 2022 (2Y)
BBHA9120D	Schwarzbeck	Horn Antenna	9120D-1366	Jun. 22, 2023 (1Y)
BBHA9170	Schwarzbeck	Horn Antenna	BBHA9170178	Jan. 04, 2023 (1Y)
DT2000-2t	Innco System	Turn Table	N/A	N/A
CO3000	Innco System	Controller	1026/40960617/P	N/A
MA-4640-XPET	Innco System	Antenna Master	MA4640/652/43100318/P	N/A