

OWNER'S MANUAL

8+
ASST
#94130



1:16 SCALE RACING SERIES

CONTROLLER



BATTERIES NOT INCLUDED

VEHICLE



BATTERIES NOT INCLUDED

Important! Carefully read the Owners Manual before play!





PRECAUTION



WARNING! CHOKING HAZARD

Small parts. Not for Children under 3 years.



Only operate the product and its accessories when fully assembled and in accordance with this manual!

- Do not use this vehicle in water, mud, or sand.
- This product and its accessories are not suitable for children under the age of 36 months, because of small parts that can be swallowed.
- Intended for children age 8 and older.
- Adult supervision strongly recommended.
- Drive your vehicle in a safe area away from people, pets, cars, etc.
- Do not drive on streets or after dark.
- Do not touch or try to pick up the vehicle when it is in motion. Wait until it has stopped completely.
- Keep hair, fingers, face and loose clothing away from front and rear wheels while the vehicle is switched on or while the transmitter is operating.
- Do not drive the vehicle toward walls or other hard objects.
- Be a responsible operator!
- Do not drop or give impact to the product and its accessories.
- Check if a near transmitter produces interference or signals with the same frequency. In such a case, move to another location or try again after a while.
- Never attempt to disassemble or modify the product or its accessories.
- Regularly inspect the antennas for cracks or breaks. Do not bend the transmitter antenna. Do not use the transmitter if the antenna is broken.

BATTERIES



IMPORTANT BATTERY SAFETY INFORMATION

CAUTION: TO AVOID BATTERY LEAKAGE:



NOTE: BATTERIES MUST BE RECYCLED OR DISPOSED PROPERLY.

Contact your local area office of solid waste management or other appropriate local agency for information.

- Make sure the batteries are inserted with correct polarity and follow the toy and battery manufacturer's instructions.
- Use only battery type(s) recommended.
- Do not attempt to short-circuit, charge, disassemble or heat batteries.
- Do not dispose of batteries in fire or make them wet.
- Do not mix or use new and old batteries together.
- Do not mix or use different types of batteries together.
- Non-rechargeable batteries are not to be recharged because of the danger of eruption.
- Remove rechargeable batteries from the product before charging.
- Rechargeable batteries are only to be charged under adult supervision and follow the battery and charger manufacturer's instructions.
- Battery replacement should be done in presence of an adult.
- Remove batteries from the product for storage. Batteries may be hot.
- After use, be sure to turn the switch off.
- Remove weak or exhausted batteries from the product.
- Dispose batteries safely and properly, according to your local requirements.



STRONG BATTERY MEANS OPTIMUM PERFORMANCE

Save the battery by turning off vehicle when not in use.



ANTENNA ASSEMBLY

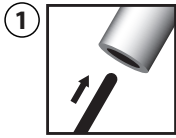

1 Insert antenna wire from product into tube

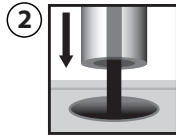

2 Slide tube down antenna wire and into hole in product

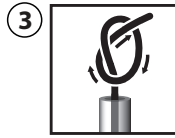

3 Tie knot with any remaining antenna wire (Do not pull wire tight)

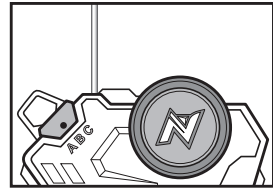

BATTERY INSTALLATION

TRANSMITTER

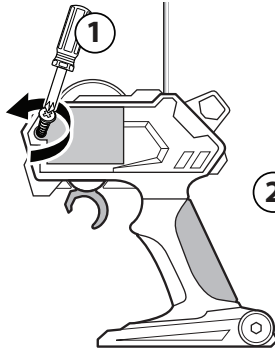

1. To remove battery lid, loosen screw to open.
2. Slide open the battery lid in the direction as shown in the figure, while lightly pressing its center.
3. Insert 1.5V (AAA/LR03) batteries x3 with the polarity (+/-) as shown on the bottom of battery compartment. Replace the battery lid, following the removal procedure in reverse.

NOTE: There is no on/off switch on the Transmitter. Moving the sticks turns it on automatically.

VEHICLE

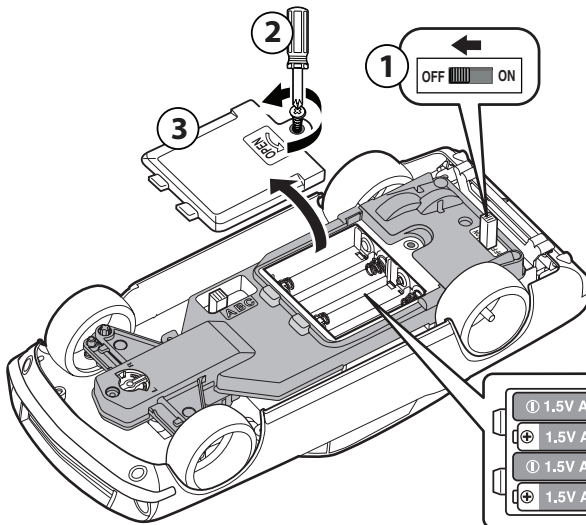

1. Turn off vehicle.
2. Loosen screw to open battery lid.
3. Remove battery lid.
4. Insert 1.5V (AA/LR6) batteries x4 into battery compartment with correct polarity (+/-). Place battery lid back in position and lock properly.

NOTE: For best performance, always use alkaline batteries only. To remove the batteries, reverse the installation procedure.



SELECT SAME BAND ON TRANSMITTER AND VEHICLE

NOTE: 3 channels for 27MHz frequency, allows up to 3 cars to race at once.

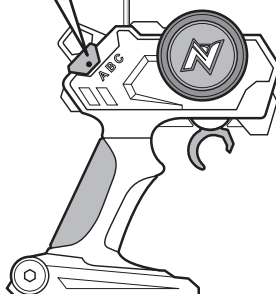
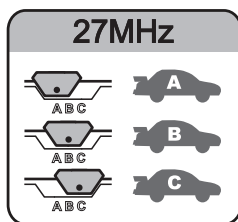
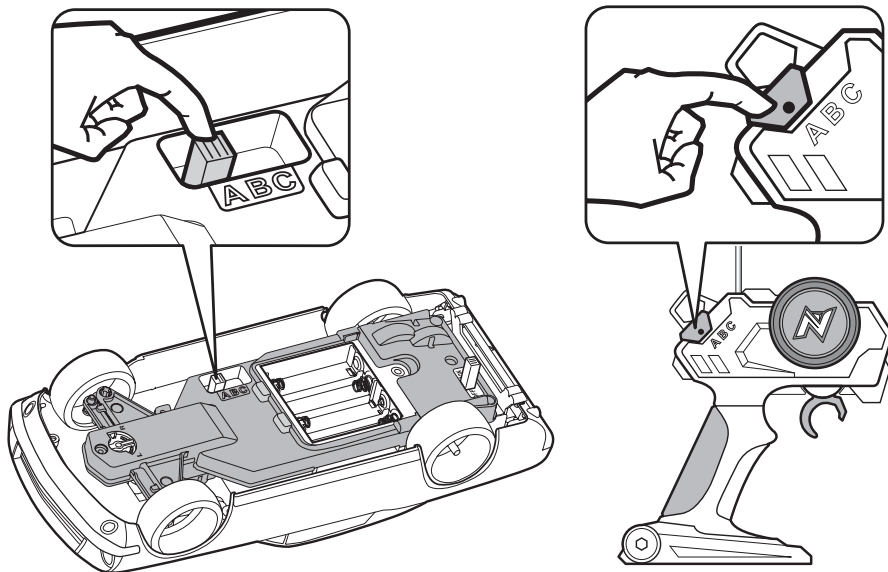



OPERATING R/C VEHICLE

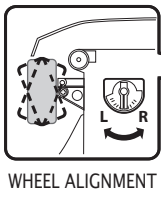

WHEEL ALIGNMENT

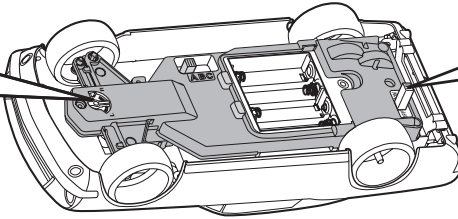

TURN VEHICLE POWER ON

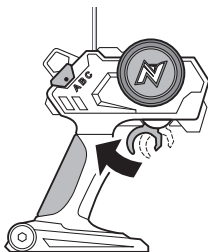

FORWARD

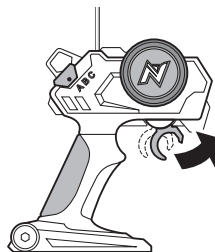
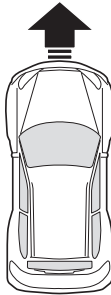

BACKWARDS

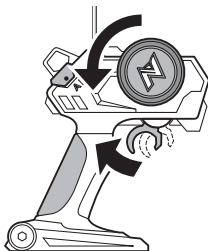
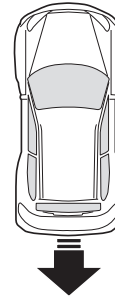

LEFT TURN - FORWARD
(At the same time)

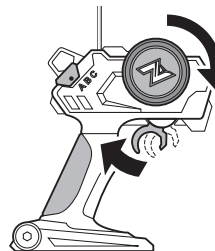
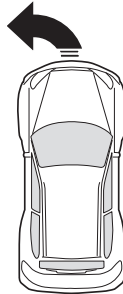

RIGHT TURN - FORWARD
(At the same time)

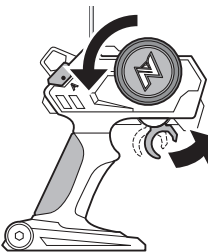
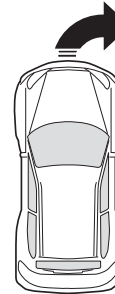

LEFT TURN - BACKWARD
(At the same time)

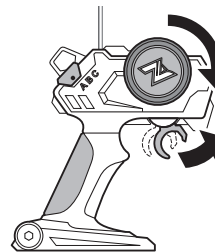
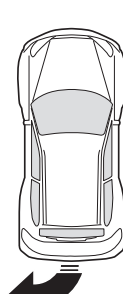

RIGHT TURN - BACKWARD
(At the same time)

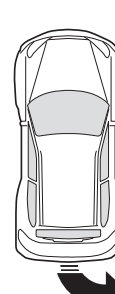

NOTE: After play, always turn vehicle off. Remove batteries from controller and R/C vehicle when not in use or when storing. Leakage may occur and cause damage if left for a long period of time.



TROUBLESHOOTING AND CARE FOR R/C VEHICLE

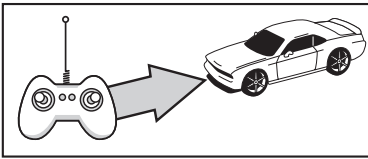

LIMITED RADIO CONTROL RANGE
While R/C vehicle may be visible at a distance, full operational control may be lost. Hold controller high in the air and direct vehicle back.

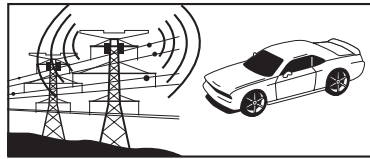

INTERFERENCE
Other radio signals may cause loss of control. Remove vehicle from an area of interference.

<p>R/C VEHICLE DOES NOT MOVE</p>	<ul style="list-style-type: none"> • Are the + and - contacts correctly matched in the controller? • Are the metal contact tabs touching, rusty or dirty in controller? • Are there batteries in the vehicle and controller? • Is the power switch turned to play? • Are the batteries weak or out of power?
<p>R/C VEHICLE MOVES BY ITSELF</p>	<ul style="list-style-type: none"> • There is radio interference in the area. • Another R/C vehicle with the same frequency is close by.
<p>R/C VEHICLE RUNS SLOWLY</p>	<ul style="list-style-type: none"> • There is radio interference in the area. • Another R/C vehicle with the same frequency is close by. • Are the batteries weak or out of power?
<p>PERFORMANCE DROP, INCONSISTENT MOVEMENT OR FAILS TO RUN</p>	<p>Check batteries. If necessary, recharge battery pack and/or replace the batteries in the R/C vehicle and controller with new alkaline batteries.</p>

TREAT YOUR R/C VEHICLE WELL

Radio waves control the R/C vehicle. Care for your vehicle and it will provide hours of fun!
Avoid heat, sand and high impact crashes!

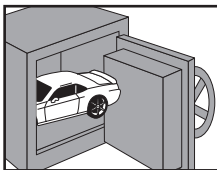

Store in safe place.

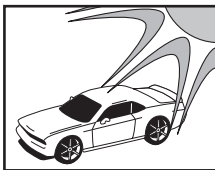

No direct sunlight.



No rain or water.

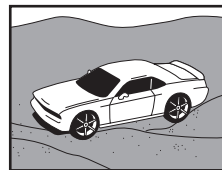

No sand or dust.

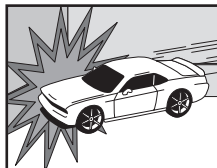

No Collisions.

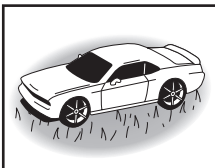

R/C vehicle may get stuck on carpet or grass.

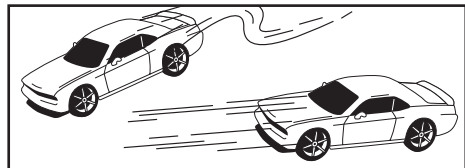

Avoid running 2 vehicles with the same radio control frequencies.



CLEANING AND MAINTAINING

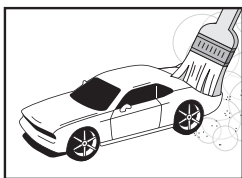

Brush areas where dirt and dust get trapped.

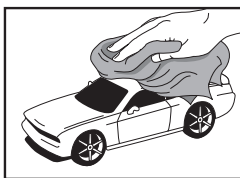

Wipe body off with a soft rag or tact cloth.



Do not clean vehicle with chemicals or water.

FEDERAL COMMUNICATIONS COMMISSION COMPLIANCE

NOTE:

This device complies with Part 15 of the FCC Rules. Operation is subject to the following two conditions:

(1) this device may not cause harmful interference, and

(2) this device must accept any interference received, including interference that may cause undesired operation.

Warning: Changes or modifications to this unit not expressly approved by the party responsible for compliance could void the user's authority to operate the equipment. NOTE: This equipment has been tested and found to comply with the limits for a Class B digital device, pursuant to Part 15 of the FCC Rules. These limits are designed to provide reasonable protection against harmful interference in a residential installation. This equipment generates, uses and can radiate radio frequency energy and, if not installed and used in accordance with the instructions, may cause harmful interference to radio communications. However, there is no guarantee that interference will not occur in a particular installation. If this equipment does cause harmful interference to radio or television reception, which can be determined by turning the equipment off and on, the user is encouraged to try to correct the interference by one or more of the following measures:

- Reorient or relocate the receiving antenna.
- Increase the separation between the equipment and receiver.
- Connect the equipment into an outlet on a circuit different from that to which the receiver is connected.
- Consult the dealer or an experienced radio/TV technician for help.

MANUFACTURER'S NOTE

"Modifications not authorized by the manufacturer may void users authority to operate the device."

ATTENTION PARENTS

This toy and all accessories need to be periodically examined for potential hazards and any potentially hazardous parts be repaired or replaced.

www.toystate.com

www.NikkoRC.com

For questions, e-mail our Consumer Service Dept. at consumerservice@toystate.com

Or Call 1-877-473-8015



WARNING:
Not suitable for children under 36 months due to small parts. Choking hazard.



MADE IN SHENZHEN, CHINA
TOY STATE INTERNATIONAL LIMITED
66 MODY ROAD, KOWLOON, HONG KONG

IN THE INTEREST OF BETTER QUALITY AND VALUE, WE ARE CONSTANTLY IMPROVING AND UPDATING OUR PRODUCTS. CONSEQUENTLY, PICTURES IN THIS INSTRUCTION SHEET MAY SOMETIMES DIFFER FROM THE MODEL ENCLOSED.



www.toystate.com

