

MODEL NO:94121 RX

RX Schematic

PAGE NO:1 OF 1

APPLICANT: TOY STATE INDUSTRIAL LTD

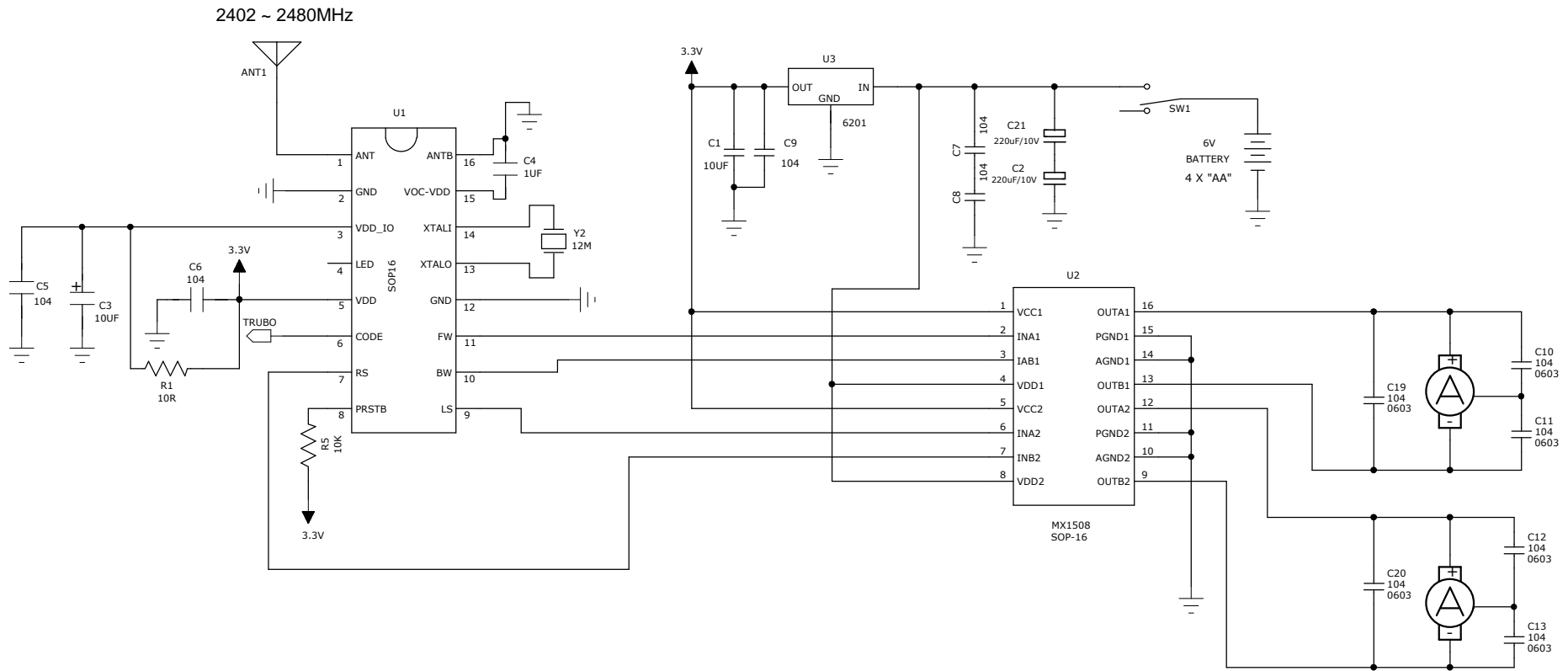

COMPANY: TOY STATE INDUSTRIAL LTD	
MODEL: 94121	
VER:	
DWN. Tom	DATE: 2016.01.20
CHK. wang	DATE: 2016.01.20
APP. xiao	DATE: 2016.01.20