



A D T

# FCC TEST REPORT (Part 90 Subpart Z)

**REPORT NO.:** RF120314E03

**MODEL NO.:** US330-3.8, US330, US330-3.8-FLF-81,  
US330-3.8-FLF -81RT, US330-3.8-FLF -81F

**FCC ID:** V8YFWA1FUS38000W

**RECEIVED:** Mar. 14, 2011

**TESTED:** Apr. 17, 2012

**ISSUED:** July 04, 2012

**APPLICANT:** Accton Wireless Broadband Corp.

**ADDRESS:** 3F, No. 1 Creation Rd. III, Science-based Industrial  
Park Hsinchu 30077, Taiwan, R.O.C.

**ISSUED BY:** Bureau Veritas Consumer Products Services (H.K.)  
Ltd., Taoyuan Branch Hsin Chu Laboratory

**LAB ADDRESS :** No. 81-1, Lu Liao Keng, 9th Ling,Wu Lung Tsuen,  
Chiung Lin Hsiang, Hsin Chu Hsien 307, Taiwan,  
R.O.C.

This test report consists of 129 pages in total. It may be duplicated completely for legal use with the approval of the applicant. It should not be reproduced except in full, without the written approval of our laboratory. The client should not use it to claim product certification, approval, or endorsement by TAF or any government agencies. The test results in the report only apply to the tested sample.





## TABLE OF CONTENTS

RELEASE CONTROL RECORD .....	4
1 CERTIFICATION .....	5
2 SUMMARY OF TEST RESULTS .....	6
2.1 MEASUREMENT UNCERTAINTY .....	6
3 GENERAL INFORMATION .....	7
3.1 GENERAL DESCRIPTION OF EUT .....	7
3.2 DESCRIPTION OF TEST MODES .....	8
3.2.1 TEST MODE APPLICABILITY AND TESTED CHANNEL DETAIL .....	9
3.3 GENERAL DESCRIPTION OF APPLIED STANDARDS .....	12
3.4 DESCRIPTION OF SUPPORT UNITS .....	13
3.4.1 CONFIGURATION OF SYSTEM UNDER TEST .....	13
4 TEST TYPES AND RESULTS .....	14
4.1 OUTPUT POWER AND POWER DENSITY MEASUREMENT .....	14
4.1.1 LIMITS OF OUTPUT POWER AND POWER DENSITY .....	14
4.1.2 TEST INSTRUMENTS .....	14
4.1.3 TEST PROCEDURES .....	15
4.1.4 TEST SETUP .....	16
4.1.5 EUT OPERATING CONDITIONS .....	16
4.1.6 TEST RESULTS .....	17
4.2 FREQUENCY STABILITY MEASUREMENT .....	67
4.2.1 LIMITS OF FREQUENCY STABILITY MEASUREMENT .....	67
4.2.2 TEST INSTRUMENTS .....	67
4.2.3 TEST PROCEDURE .....	68
4.2.4 TEST SETUP .....	68
4.2.5 EUT OPERATING CONDITIONS .....	68
4.2.6 TEST RESULTS .....	69
4.3 EMISSION BANDWIDTH MEASUREMENT .....	70
4.3.1 LIMITS OF EMISSION BANDWIDTH MEASUREMENT .....	70
4.3.2 TEST INSTRUMENTS .....	70
4.3.3 TEST PROCEDURE .....	70
4.3.4 TEST SETUP .....	70
4.3.5 EUT OPERATING CONDITIONS .....	70
4.3.6 TEST RESULTS .....	71
4.4 EMISSION MASKS .....	81
4.4.1 LIMITS OF EMISSION MASKS .....	81
4.4.2 TEST INSTRUMENTS .....	81
4.4.3 TEST SETUP .....	81
4.4.4 TEST PROCEDURES .....	82
4.4.5 EUT OPERATING CONDITION .....	82



A D T

4.4.6	TEST RESULTS .....	83
4.5	CONDUCTED SPURIOUS EMISSIONS .....	95
4.5.1	LIMITS OF CONDUCTED SPURIOUS EMISSIONS MEASUREMENT .....	95
4.5.2	TEST INSTRUMENTS .....	95
4.5.3	TEST PROCEDURE .....	96
4.5.4	TEST SETUP .....	96
4.5.5	EUT OPERATING CONDITIONS .....	96
4.5.6	TEST RESULTS .....	97
4.6	RADIATED EMISSION MEASUREMENT (BELOW 1GHz) .....	115
4.6.1	LIMITS OF RADIATED EMISSION MEASUREMENT .....	115
4.6.2	TEST INSTRUMENTS .....	116
4.6.3	TEST PROCEDURES .....	117
4.6.4	DEVIATION FROM TEST STANDARD .....	117
4.6.5	TEST SETUP .....	118
4.6.6	EUT OPERATING CONDITIONS .....	118
4.6.7	TEST RESULTS .....	119
4.7	RADIATED EMISSION MEASUREMENT (ABOVE 1GHz) .....	121
4.7.1	LIMITS OF RADIATED EMISSION MEASUREMENT .....	121
4.7.2	TEST INSTRUMENTS .....	121
4.7.3	TEST PROCEDURES .....	121
4.7.4	DEVIATION FROM TEST STANDARD .....	121
4.7.5	TEST SETUP .....	121
4.7.6	EUT OPERATING CONDITIONS .....	121
4.7.7	TEST RESULTS .....	122
5	PHOTOGRAPHS OF THE TEST CONFIGURATION .....	128
6	INFORMATION ON THE TESTING LABORATORIES .....	129



A D T

## RELEASE CONTROL RECORD

ISSUE NO.	REASON FOR CHANGE	DATE ISSUED
RF120314E03	Original release	July 04, 2012



# 1 CERTIFICATION

**PRODUCT:** WiMAX 802.16e USB Adapter

**BRAND:** AWB, the BlueZone

**MODEL:** US330-3.8, US330, US330-3.8-FLF-81,  
US330-3.8-FLF -81RT, US330-3.8-FLF -81F

**TEST SAMPLE:** R&D SAMPLE

**APPLICANT:** Accton Wireless Broadband Corp.

**TESTED:** Apr. 17, 2012

**TEST STANDARDS:** FCC Part 90, Subpart Z

The above equipment (Model No.: US330-3.8) has been tested by **Bureau Veritas Consumer Products Services (H.K.) Ltd., Taoyuan Branch**, and found compliance with the requirement of the above standards. The test record, data evaluation & Equipment Under Test (EUT) configurations represented herein are true and accurate accounts of the measurements of the sample's EMC characteristics under the conditions specified in this report.

**PREPARED BY** :  , **DATE:** July 04, 2012  
( Claire Kuan, Specialist )

**APPROVED BY** :  , **DATE:** July 04, 2012  
( May Chen, Deputy Manager )

## 2 SUMMARY OF TEST RESULTS

The EUT has been tested according to the following specifications:

STANDARD SECTION	TEST TYPE	RESULT	REMARK
FCC Part 2& Part 90			
2.1046 90.1321	Maximum Output Power	PASS	Meet the requirement of limit.
2.1055 90.213	Frequency Stability	PASS	Meet the requirement of limit.
2.1049 90.1323	Emission Bandwidth	PASS	Meet the requirement of limit.
90.210	Emission masks	PASS	Meet the requirement of limit.
2.1051 90.1323	Conducted Spurious Emissions	PASS	Meet the requirement of limit.
2.1053 90.1323	Radiated Spurious Emissions	PASS	Meet the requirement of limit.

### 2.1 MEASUREMENT UNCERTAINTY

Where relevant, the following measurement uncertainty levels have been estimated for tests performed on the EUT as specified in CISPR 16-4-2:

MEASUREMENT	FREQUENCY	UNCERTAINTY
Radiated emissions	30MHz ~ 1000MHz	4.89 dB
	1GHz ~ 18GHz	2.49 dB
	18GHz ~ 40GHz	2.70 dB

This uncertainty represents an expanded uncertainty expressed at approximately the 95% confidence level using a coverage factor of  $k = 2$ .



A D T

### 3 GENERAL INFORMATION

#### 3.1 GENERAL DESCRIPTION OF EUT

<b>PRODUCT</b>	WiMAX 802.16e USB Adapter
<b>MODEL NO.</b>	US330-3.8, US330, US330-3.8-FLF-81, US330-3.8-FLF -81RT, US330-3.8-FLF -81F
<b>POWER SUPPLY</b>	DC 5V from host equipment
<b>MODULATION TYPE</b>	Up-Link : QPSK-1/2,-3/4, 16QAM-1/2,-3/4 Down-Link : QPSK-1/2,-3/4, 16QAM-1/2,-3/4 64QAM-1/2,-3/4, -2/3, 5/6
<b>MODULATION TECHNOLOGY</b>	OFDMA
<b>MULTIPLE ACCESS METHOD</b>	TDMA
<b>OPERATING FREQUENCY</b>	5MHz: 3652.5 ~ 3672.5MHz 10MHz: 3655 ~ 3670MHz
<b>CHANNEL BANDWIDTH</b>	5MHz, 10MHz
<b>MAX. EIRP POWER</b>	24.54dBm
<b>EMISSION DESIGNATOR</b>	5M51W7D 10M4W7D
<b>ANTENNA TYPE</b>	Please see note
<b>DATA CABLE</b>	NA
<b>I/O PORTS</b>	Refer to user's manual
<b>ACCESSORY DEVICES</b>	NA

**NOTE:**

1. The EUT has two brand names and five model names which are identical to each other in all aspects except for the following table:

Brand	Model Name	Description
AWB, the BlueZone	US330-3.8	For marketing to separate difference models
	US330	
	US330-3.8-FLF-81	
	US330-3.8-FLF -81RT	
	US330-3.8-FLF -81F	

From the above models, model: **US330-3.8** was selected as representative model for the test and its data was recorded in this report.



A D T

2. There is one antenna provided to this EUT, please refer to the following table:

Antenna Type	Antenna Connector	Antenna Gain (dBi) Include cable loss	Frequency range (MHz)
Printed	NA	2	3300~3800

3. The EUT incorporates a MIMO function for WiMAX. Physically, the EUT provides two completed transmit and two receivers.
4. EUT can supports different UL / DL ratio, max transmit ratio is up to 18 (UL): 29 (DL). After pretesting of output power and spurious emission, 18 (UL): 29 (DL) was found to be worst case and was selected for the final test configuration.
5. The above EUT information was declared by manufacturer and for more detailed features description please refers to the manufacturer's specifications or User's Manual.

### 3.2 DESCRIPTION OF TEST MODES

Three channels had been tested for each channel bandwidth.

<b>CHANNEL BANDWIDTH: 5MHz</b>
<b>Low channel (L):</b> 3652.5MHz
<b>Middle channel (M):</b> 3662.5MHz
<b>High channel (H):</b> 3672.5MHz
<b>CHANNEL BANDWIDTH: 10MHz</b>
<b>Low channel (L):</b> 3655MHz
<b>Middle channel (M):</b> 3662.5MHz
<b>High channel (H):</b> 3670MHz



### 3.2.1 TEST MODE APPLICABILITY AND TESTED CHANNEL DETAIL

EUT CONFIGURE MODE	APPLICABLE TO							DESCRIPTION
	OP	FS	EB	EM	CSE	RE<1G	RE≥1G	
-	√	√	√	√	√	√	√	-

Where **OP**: Output power **FS**: Frequency stability  
**EB**: Emission bandwidth **EM**: Emission masks  
**CSE**: Conducted spurious emissions **RE<1G**: Radiated emission below 1GHz  
**RE≥1G**: Radiated emission above 1GHz **NOTE**: "-": Means no effect.

#### **OUTPUT POWER MEASUREMENT:**

- Pre-Scan has been conducted to determine the worst-case mode from all possible combinations between available modulations, coding rate and antenna ports (if EUT with antenna diversity architecture).
- Following channel(s) was (were) selected for the final test as listed below.

TESTED CHANNEL	MODULATION TECHNOLOGY	CHANNEL BANDWIDTH	MODULATION TYPE	CODING RATE
L, M, H	OFDMA	5MHz	QPSK	1/2
L, M, H	OFDMA	10MHz	QPSK	1/2

#### **FREQUENCY STABILITY MEASUREMENT:**

- Pre-Scan has been conducted to determine the worst-case mode from all possible combinations between available modulations, coding rate, and antenna ports (if EUT with antenna diversity architecture).
- Following channel(s) was (were) selected for the final test as listed below.

TESTED CHANNEL	MODULATION TECHNOLOGY	CHANNEL BANDWIDTH	MODULATION TYPE
M	OFDMA	5MHz	Unmodulation



A D T

**EMISSION BANDWIDTH MEASUREMENT:**

- Pre-Scan has been conducted to determine the worst-case mode from all possible combinations between available modulations, coding rate, and antenna ports (if EUT with antenna diversity architecture).
- Following channel(s) was (were) selected for the final test as listed below.

TESTED CHANNEL	MODULATION TECHNOLOGY	CHANNEL BANDWIDTH	MODULATION TYPE	CODING RATE
L, M, H	OFDMA	5MHz	QPSK	1/2
L, M, H	OFDMA	5MHz	QPSK	3/4
L, M, H	OFDMA	5MHz	16QAM	1/2
L, M, H	OFDMA	5MHz	16QAM	3/4
L, M, H	OFDMA	10MHz	QPSK	1/2
L, M, H	OFDMA	10MHz	QPSK	3/4
L, M, H	OFDMA	10MHz	16QAM	1/2
L, M, H	OFDMA	10MHz	16QAM	3/4

**EMISSION MASKS MEASUREMENT:**

- Pre-Scan has been conducted to determine the worst-case mode from all possible combinations between available modulations, coding rate, and antenna ports (if EUT with antenna diversity architecture).
- Following channel(s) was (were) selected for the final test as listed below.

TESTED CHANNEL	MODULATION TECHNOLOGY	CHANNEL BANDWIDTH	MODULATION TYPE	CODING RATE
L, M, H	OFDMA	5MHz	QPSK	1/2
L, M, H	OFDMA	10MHz	QPSK	1/2

**CONDUCTED SPURIOUS EMISSIONS MEASUREMENT:**

- Pre-Scan has been conducted to determine the worst-case mode from all possible combinations between available modulations, coding rate, and antenna ports (if EUT with antenna diversity architecture).
- Following channel(s) was (were) selected for the final test as listed below.

TESTED CHANNEL	MODULATION TECHNOLOGY	CHANNEL BANDWIDTH	MODULATION TYPE	CODING RATE
L, M, H	OFDMA	5MHz	QPSK	1/2
L, M, H	OFDMA	10MHz	QPSK	1/2

**RADIATED EMISSION MEASUREMENT (BELOW 1 GHz):**

- Pre-Scan has been conducted to determine the worst-case mode from all possible combinations between available modulations, coding rate and antenna ports (if EUT with antenna diversity architecture).
- Following channel(s) was (were) selected for the final test as listed below.

TESTED CHANNEL	MODULATION TECHNOLOGY	CHANNEL BANDWIDTH	MODULATION TYPE	CODING RATE
H	OFDMA	5MHz	QPSK	1/2
L	OFDMA	10MHz	QPSK	1/2

**RADIATED EMISSION MEASUREMENT (ABOVE 1 GHz):**

- Pre-Scan has been conducted to determine the worst-case mode from all possible combinations between available modulations, coding rate and antenna ports (if EUT with antenna diversity architecture).
- Following channel(s) was (were) selected for the final test as listed below.

TESTED CHANNEL	MODULATION TECHNOLOGY	CHANNEL BANDWIDTH	MODULATION TYPE	CODING RATE
L, M, H	OFDMA	5MHz	QPSK	1/2
L, M, H	OFDMA	10MHz	QPSK	1/2

**TEST CONDITION:**

APPLICABLE TO	ENVIRONMENTAL CONDITIONS	INPUT POWER (SYSTEM)	TESTED BY
OP	25deg°C, 60%RH	120Vac, 60Hz	Rex Huang
FS	25deg°C, 60%RH	120Vac, 60Hz	Rex Huang
EB	25deg°C, 60%RH	120Vac, 60Hz	Rex Huang
EM	25deg°C, 60%RH	120Vac, 60Hz	Rex Huang
CSE	25deg°C, 60%RH	120Vac, 60Hz	Rex Huang
RE < 1G	25deg°C, 60%RH	120Vac, 60Hz	Robert Cheng
RE ≥ 1G	25deg°C, 60%RH	120Vac, 60Hz	Robert Cheng

### **3.3 GENERAL DESCRIPTION OF APPLIED STANDARDS**

The EUT is a RF product. According to the specifications of the manufacturer, it must comply with the requirements of the following standards:

**FCC 47 CFR Part 2**

**FCC 47 CFR Part 90**

**965270 D01 Pwr Meas Part 90 Z Equipment v01**

**ANSI/TIA/EIA-603-C-2004**

All test items have been performed and recorded as per the above standards.

**NOTE:** The EUT has been verified to comply with the requirements of FCC Part 15, Subpart B, Class B (DoC). The test report has been issued separately.

### 3.4 DESCRIPTION OF SUPPORT UNITS

The EUT has been tested as an independent unit together with other necessary accessories or support units. The following support units or accessories were used to form a representative test configuration during the tests.

NO.	PRODUCT	BRAND	MODEL NO.	SERIAL NO.	FCC ID
1	NOTEBOOK COMPUTER	DELL	PP32LA	FSLB32S	FCC DoC
2	iPod shuffle	Apple	MC749TA/A	CC4DMFJUJDFDM	NA

NO.	SIGNAL CABLE DESCRIPTION OF THE ABOVE SUPPORT UNITS
1	NA
2	USB cable (0.1m)

**NOTE:** All power cords of the above support units are non shielded (1.8m).

#### 3.4.1 CONFIGURATION OF SYSTEM UNDER TEST

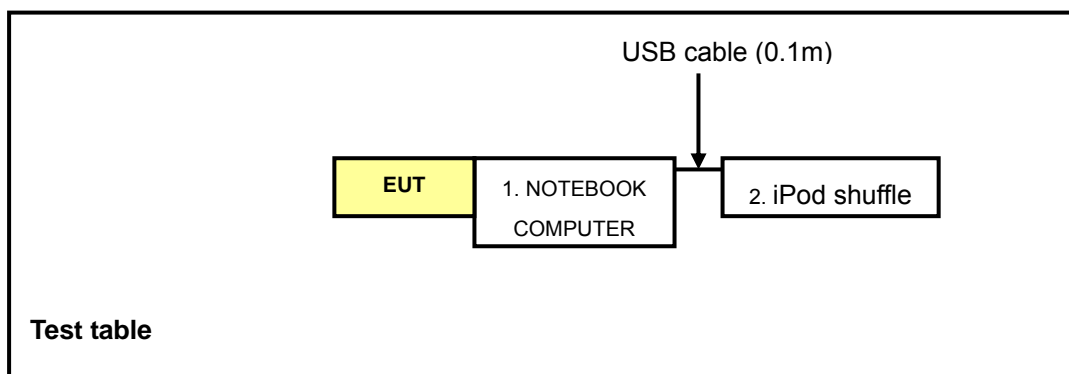



## 4 TEST TYPES AND RESULTS

### 4.1 OUTPUT POWER AND POWER DENSITY MEASUREMENT

#### 4.1.1 LIMITS OF OUTPUT POWER AND POWER DENSITY

PER FCC PART 90.1321

#### BASE AND FIXED STATIONS

Base and fixed stations are limited to 25 Watts/25 MHz equivalent isotropical radiated power (EIRP). In any event, the peak EIRP power density shall not exceed 1 Watt in any one-megahertz slice of spectrum.

#### MOBILE AND PORTABLE STATIONS

Mobile and portable stations are limited to 1 Watt/25 MHz EIRP. In any event, the peak EIRP density shall not exceed 40 milliWatts in any one-megahertz slice of spectrum.

#### 4.1.2 TEST INSTRUMENTS

DESCRIPTION & MANUFACTURER	MODEL NO.	SERIAL NO.	DATE OF CALIBRATION	DUE DATE OF CALIBRATION
AGILENT SPECTRUM ANALYZER	E4446A	MY46180622	Apr. 25, 2011	Apr. 24, 2012
SUHNER RF cable	SUCOFLEX 104	222684/4	Jan. 26, 2012	Jan. 25, 2013
JFW 10dB attenuation	50HF-010-SMA	NA	NA	NA

#### NOTE:

1. The calibration interval of the above test instruments is 12 months and the calibrations are traceable to NML/ROC and NIST/USA.
2. Tested date: Apr. 17, 2012



### 4.1.3 TEST PROCEDURES

#### **OUTPUT POWER**

1. Connect the EUT transmitter output to the spectrum analyzer via coaxial cable while ensuring proper impedance matching.
2. Tune the analyzer to the nominal center frequency of the emission bandwidth (EBW).
3. Set the span to twice the nominal EBW (span = 2 x EBW).
4. Set the resolution bandwidth (RBW) to approximately 1% of EBW.
5. Set the video bandwidth (VBW) to  $\geq 3 \times$  RBW.
6. Select the average power (RMS) display detector.
7. Set the number of measurement points to  $\geq 1001$ .
8. Use auto-coupled sweep time.
9. Perform measurement over an interval of time when the transmission is continuous and at its maximum power level.
10. Utilize trace averaging over 100 traces in the power averaging mode.
11. Use the Band/Channel Power function to determine the integrated power over the full EBW.
12. Record the band power level.
13. Adjust the recorded level by applying appropriate correction factors for the measurement set-up.
14. Determine the EIRP by adding the effective antenna gain to the adjusted power level.

#### **POWER DENSITY**

1. Connect the transmitter to the spectrum analyzer via coaxial cable while ensuring proper impedance matching.
2. Tune the analyzer to the nominal center frequency of the emission bandwidth (EBW).
3. Set the span to twice the nominal EBW (span = 2 x EBW).
4. Set the resolution bandwidth (RBW) to 1 MHz.
5. Set the video bandwidth (VBW) to 3MHz.
6. Select the average power (RMS) display detector.
7. Set the number of measurement points to  $\geq 1001$ .
8. Use auto-coupled sweep time.
9. Perform the measurement over an interval of time when the transmission is continuous and at its maximum power level.
10. Utilize trace averaging over 100 traces in the power averaging mode.
11. Find the maximum trace amplitude (peak search) and record.
12. Adjust the recorded level by applying appropriate correction factors for the measurement set-up.
13. Determine the EIRP by adding the effective antenna gain to the adjusted power level.

#### 4.1.4 TEST SETUP

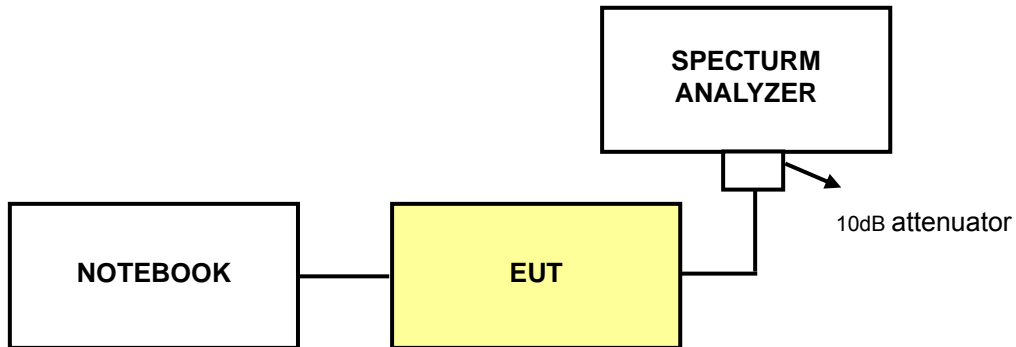

#### 4.1.5 EUT OPERATING CONDITIONS

- a. Placed the EUT on the testing table.
- b. Prepared one notebook system outside of testing area to act as a communication partners.
- c. The communication partner connected with EUT and run a test program (Telnet Past Tx command.txt) to enable EUT under transmission condition continuously at specific channel frequency.



#### 4.1.6 TEST RESULTS

##### For QPSK-1/2

##### CHANNEL BANDWIDTH: 5MHz

CONDUCTED POWER					
CHANNEL	FREQUENCY (MHz)	CONDUCTED POWER (dBm)		TOTAL POWER (mW)	TOTAL POWER (dBm)
		CHAIN 0	CHAIN 1		
Low	3652.5	15.79	15.63	74.49	18.72
Middle	3662.5	16.10	16.50	85.406	19.31
High	3672.5	16.08	16.19	82.142	19.15

EIRP POWER							
CHANNEL	FREQUENCY (MHz)	EIRP (dBm)		ANTENNA GAIN (dBi)	TOTAL POWER (mW)	TOTAL POWER (dBm)	Limit (dBm)
		CHAIN 0	CHAIN 1				
Low	3652.5	17.79	17.63	2	118.06	20.72	23.01
Middle	3662.5	18.10	18.50	2	135.36	21.31	23.01
High	3672.5	18.08	18.19	2	130.19	21.15	23.01

**NOTE:**

1. EIRP = Conducted power + Antenna Gain
2. Chain 0: RF output port 0 , Chain 1: RF output port 1.



A D T

CONDUCTED POWER DENSITY						
TX chain	Channel Number	Freq. (MHz)	PSD (dBm/MHz)	10 * log(N=2) (dB)	Total PSD (dBm/MHz)	PSD Limit (dBm/MHz)
0	Low	3652.5	10.29	3.01	13.30	14.02
	Middle	3662.5	10.18	3.01	13.19	14.02
	High	3672.5	10.46	3.01	13.47	14.02
1	Low	3652.5	10.51	3.01	13.52	14.02
	Middle	3662.5	10.65	3.01	13.66	14.02
	High	3672.5	10.63	3.01	13.64	14.02

EIRP POWER DENSITY						
TX chain	Channel Number	Freq. (MHz)	PSD (dBm/MHz)	10 * log(N=2) (dB)	Total PSD (dBm/MHz)	PSD Limit (dBm/MHz)
0	Low	3652.5	12.29	3.01	15.30	16.02
	Middle	3662.5	12.18	3.01	15.19	16.02
	High	3672.5	12.46	3.01	15.47	16.02
1	Low	3652.5	12.51	3.01	15.52	16.02
	Middle	3662.5	12.65	3.01	15.66	16.02
	High	3672.5	12.63	3.01	15.64	16.02

**NOTE:**

- 1.EIRP density = Conducted power density + Antenna Gain
2. Chain 0: RF output port 0 , Chain 1: RF output port 1.



A D T

## OUTPUT POWER

### CHAIN 0

### LOW CHANNEL

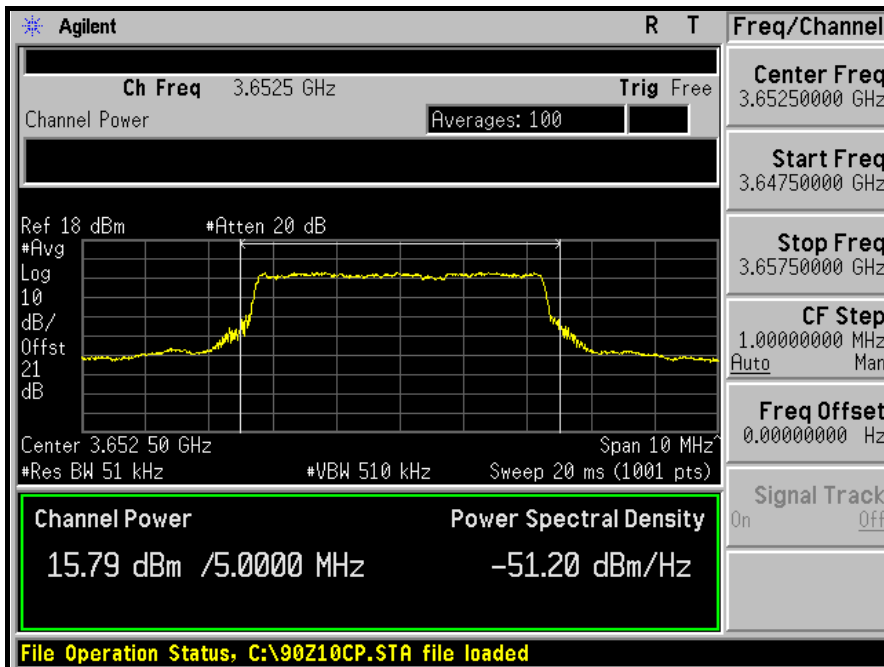

### MIDDLE CHANNEL

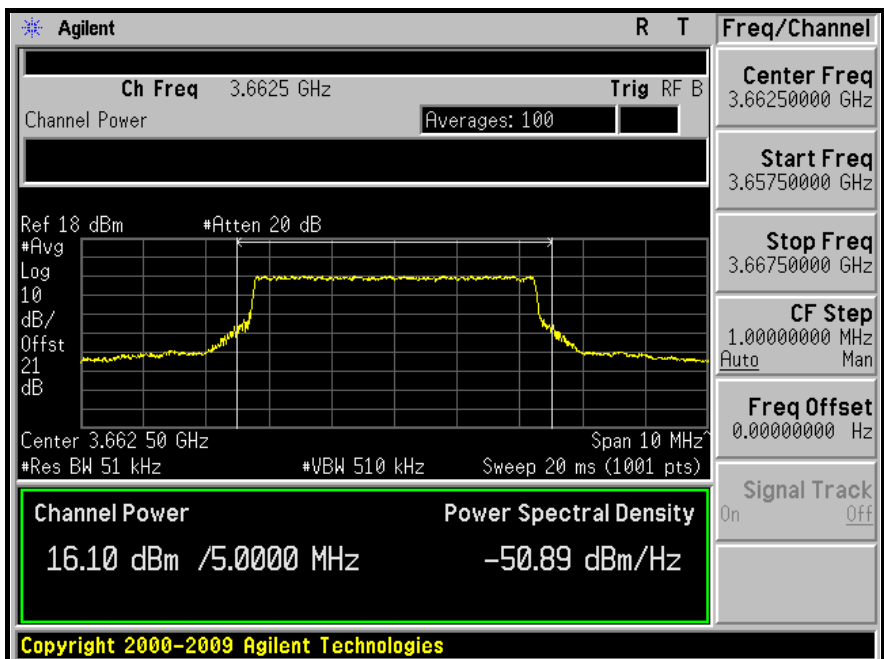



A D T

### HIGH CHANNEL

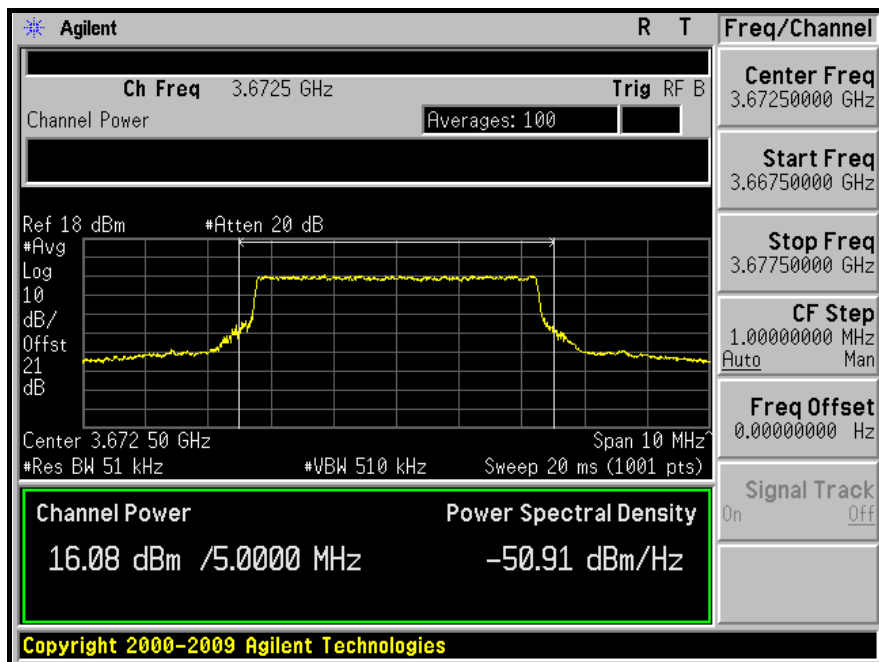



A D T

### CHAIN 1 LOW CHANNEL

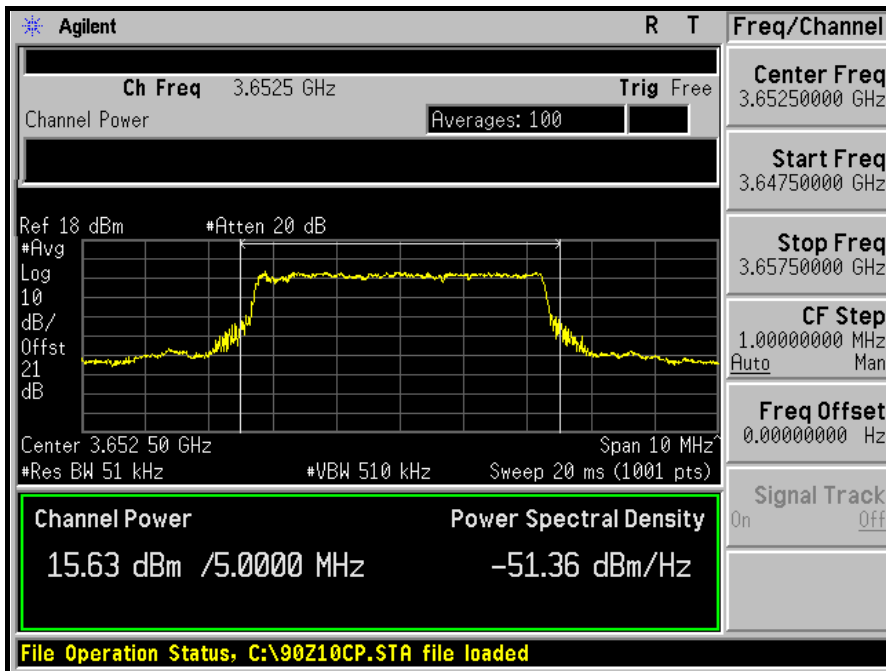

### MIDDLE CHANNEL

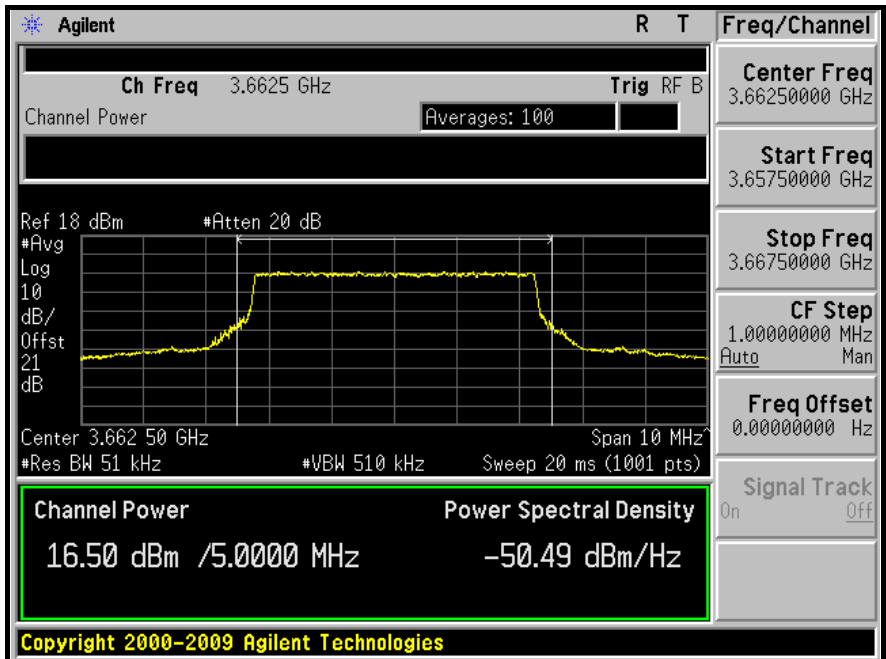



A D T

### HIGH CHANNEL

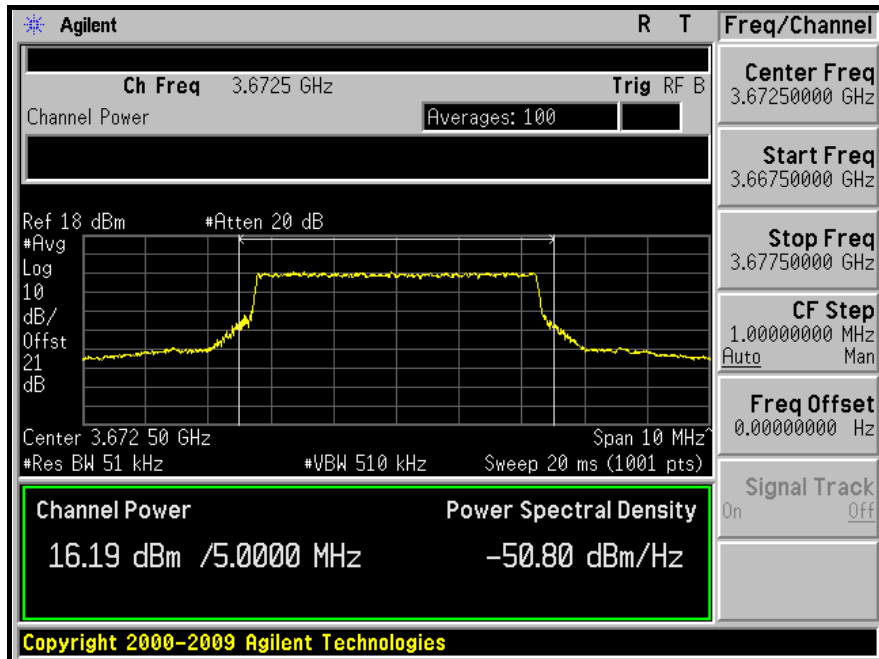



A D T

## POWER DENSITY

CHAIN 0

LOW CHANNEL

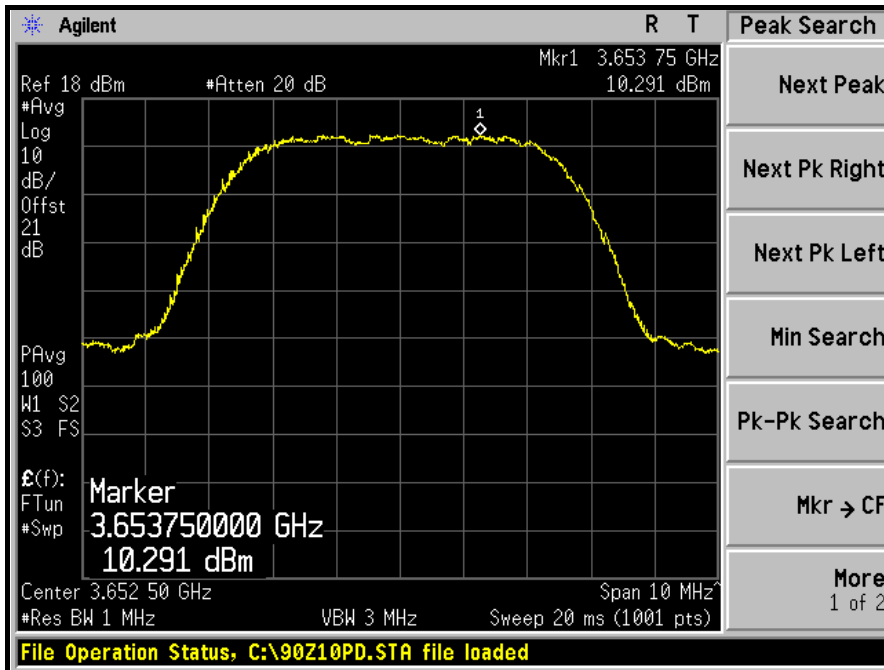

MIDDLE CHANNEL

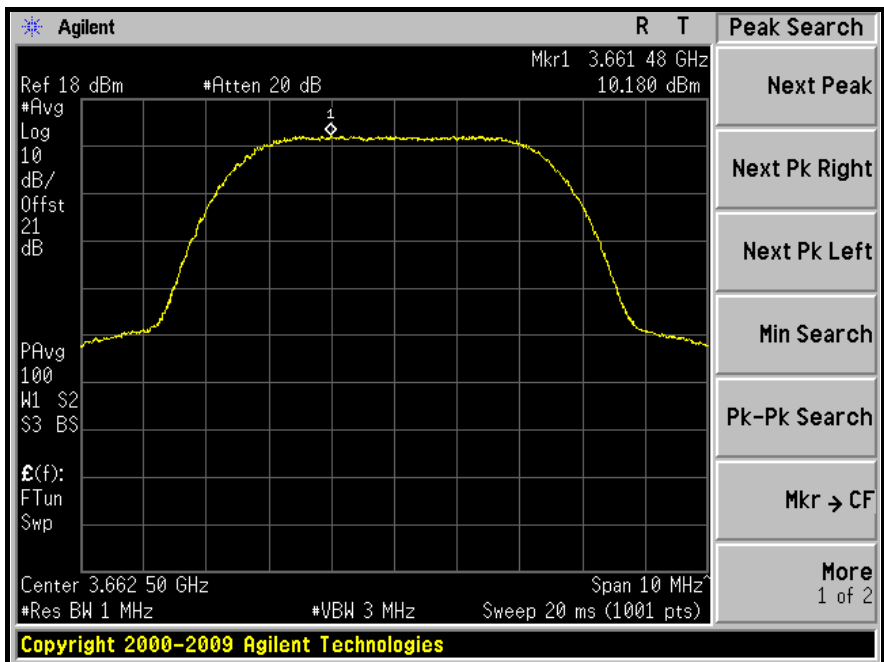



A D T

### HIGH CHANNEL

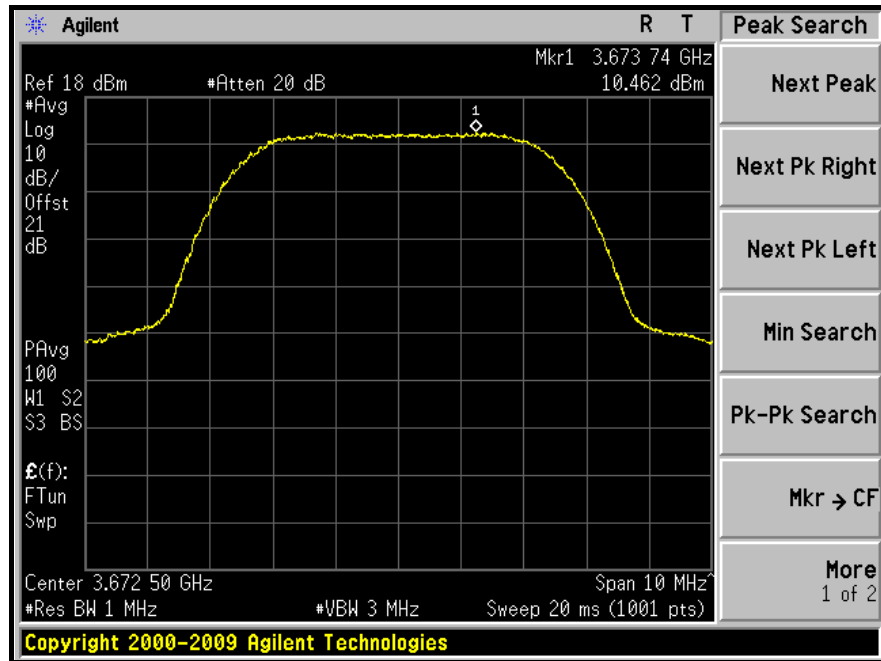





A D T

### CHAIN 1 LOW CHANNEL

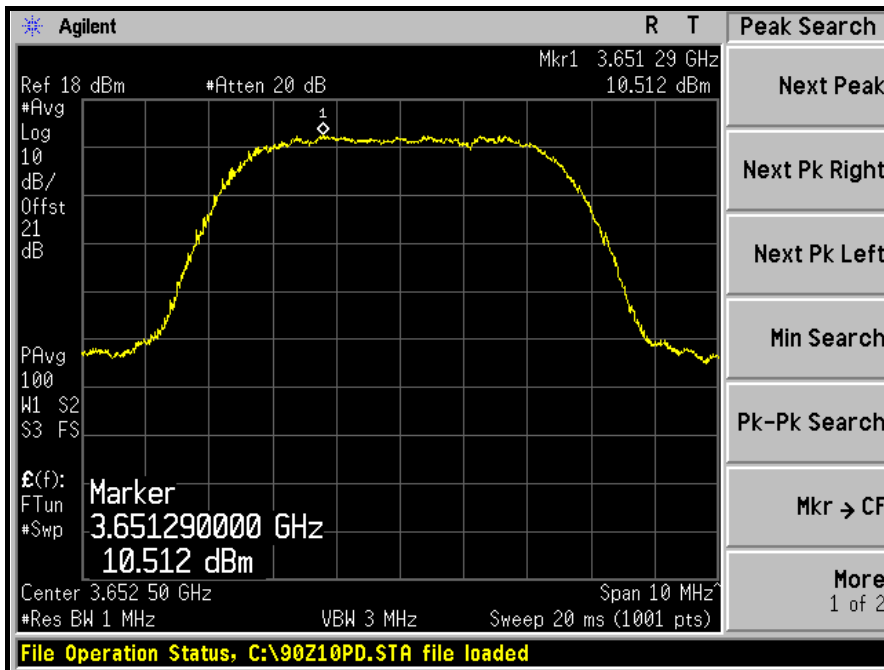

### MIDDLE CHANNEL

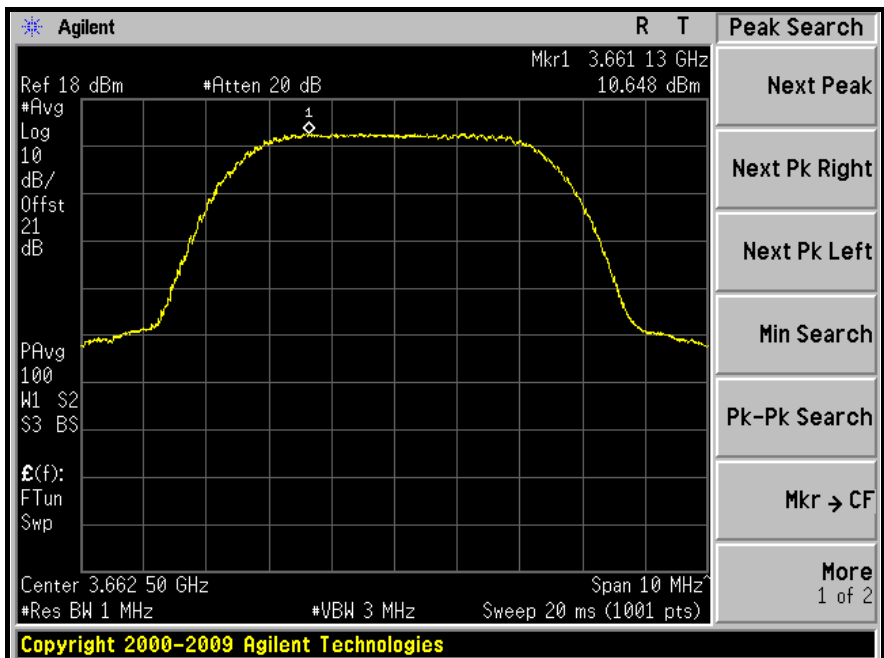



A D T

### HIGH CHANNEL

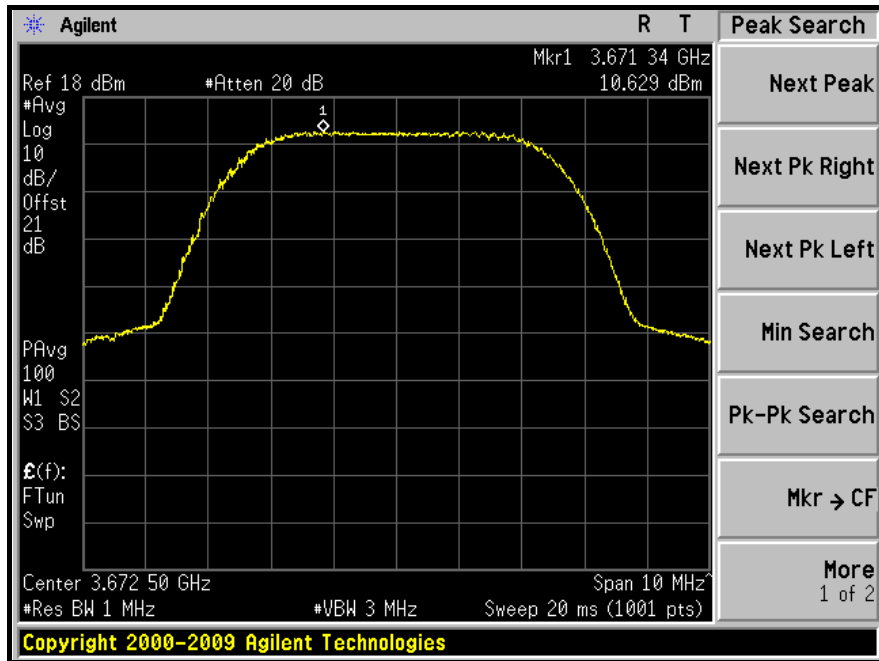



A D T

**CHANNEL BANDWIDTH: 10MHz**

CONDUCTED POWER					
CHANNEL	FREQUENCY (MHz)	CONDUCTED POWER (dBm)		TOTAL POWER (mW)	TOTAL POWER (dBm)
		CHAIN 0	CHAIN 1		
Low	3655	19.68	19.14	174.93	22.43
Middle	3662.5	19.50	19.56	179.49	22.54
High	3670	18.77	19.18	158.13	21.99

EIRP POWER							
CHANNEL	FREQUENCY (MHz)	EIRP (dBm)		ANTENNA GAIN (dBi)	TOTAL POWER (mW)	TOTAL POWER (dBm)	Limit (dBm)
		CHAIN 0	CHAIN 1				
Low	3655	21.68	21.14	2	277.25	24.43	26.02
Middle	3662.5	21.50	21.56	2	284.47	24.54	26.02
High	3670	20.77	21.18	2	250.62	23.99	26.02

**NOTE:**

1. EIRP = Conducted power + Antenna Gain
2. Chain 0: RF output port 0 , Chain 1: RF output port 1.

CONDUCTED POWER DENSITY						
TX chain	Channel Number	Freq. (MHz)	PSD (dBm/MHz)	10 * log(N=2) (dB)	Total PSD (dBm/MHz)	PSD Limit (dBm/MHz)
0	Low	3655	10.76	3.01	13.77	14.02
	Middle	3662.5	10.79	3.01	13.80	14.02
	High	3670	10.32	3.01	13.33	14.02
1	Low	3655	10.49	3.01	13.50	14.02
	Middle	3662.5	10.94	3.01	13.95	14.02
	High	3670	10.69	3.01	13.70	14.02

EIRP POWER DENSITY						
TX chain	Channel Number	Freq. (MHz)	PSD (dBm/MHz)	10 * log(N=2) (dB)	Total PSD (dBm/MHz)	PSD Limit (dBm/MHz)
0	Low	3655	12.76	3.01	15.77	16.02
	Middle	3662.5	12.79	3.01	15.80	16.02
	High	3670	12.32	3.01	15.33	16.02
1	Low	3655	12.49	3.01	15.50	16.02
	Middle	3662.5	12.94	3.01	15.95	16.02
	High	3670	12.69	3.01	15.70	16.02

**NOTE:**

1. EIRP density = Conducted power density + Antenna Gain
2. Chain 0: RF output port 0 , Chain 1: RF output port 1.



A D T

## OUTPUT POWER

### CHAIN 0

### LOW CHANNEL

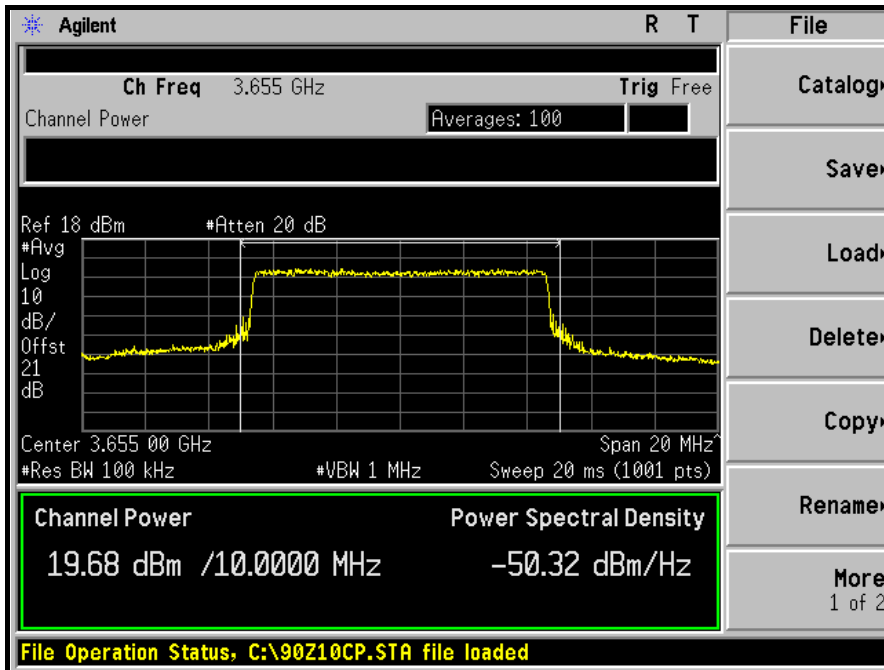

### MIDDLE CHANNEL

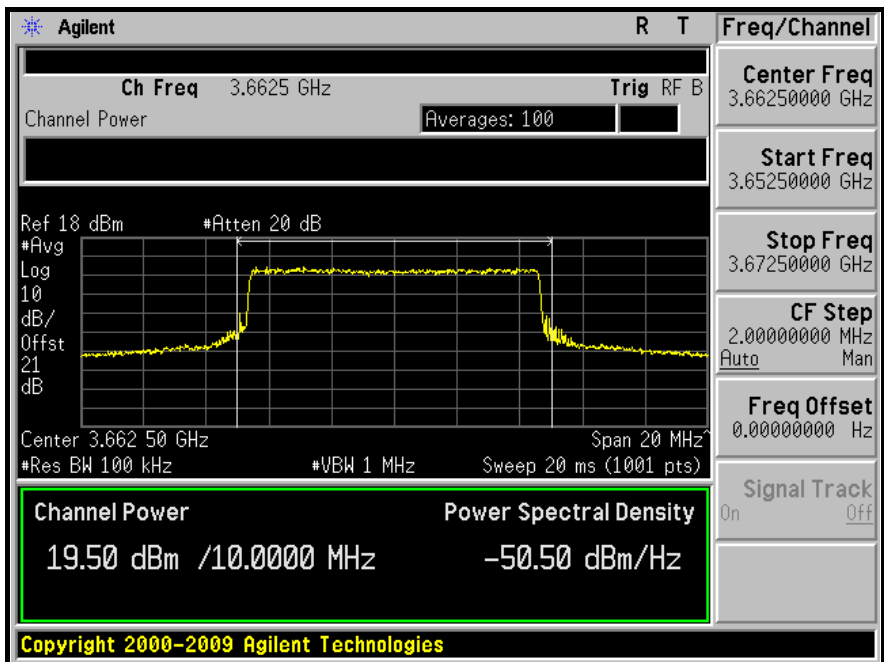



A D T

### HIGH CHANNEL

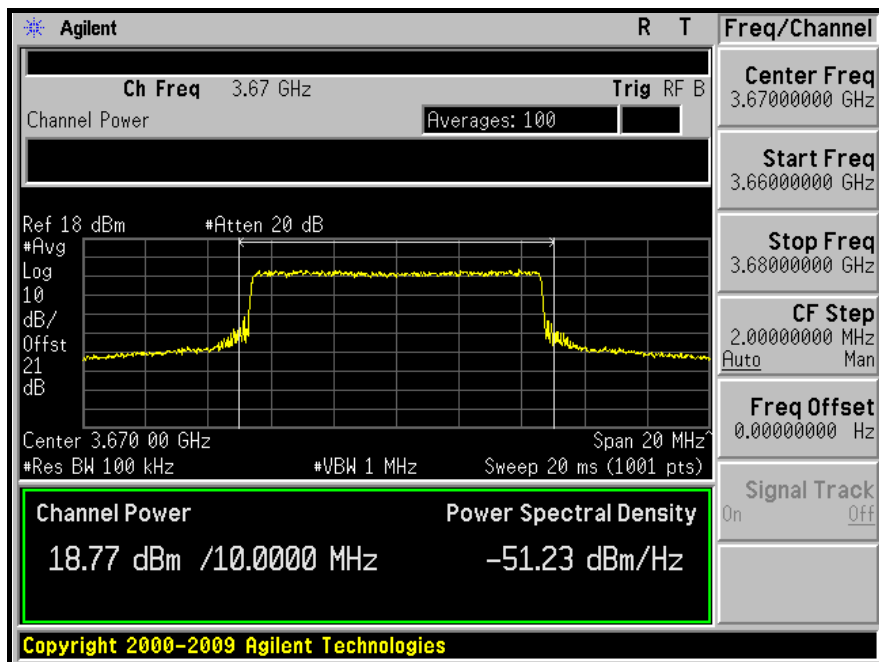



A D T

### CHAIN 1 LOW CHANNEL

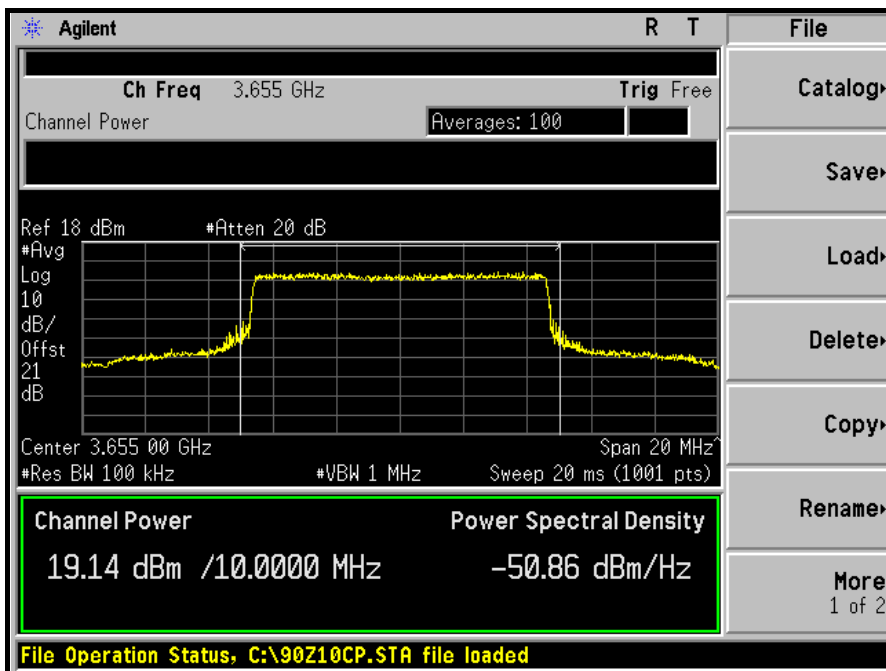

### MIDDLE CHANNEL

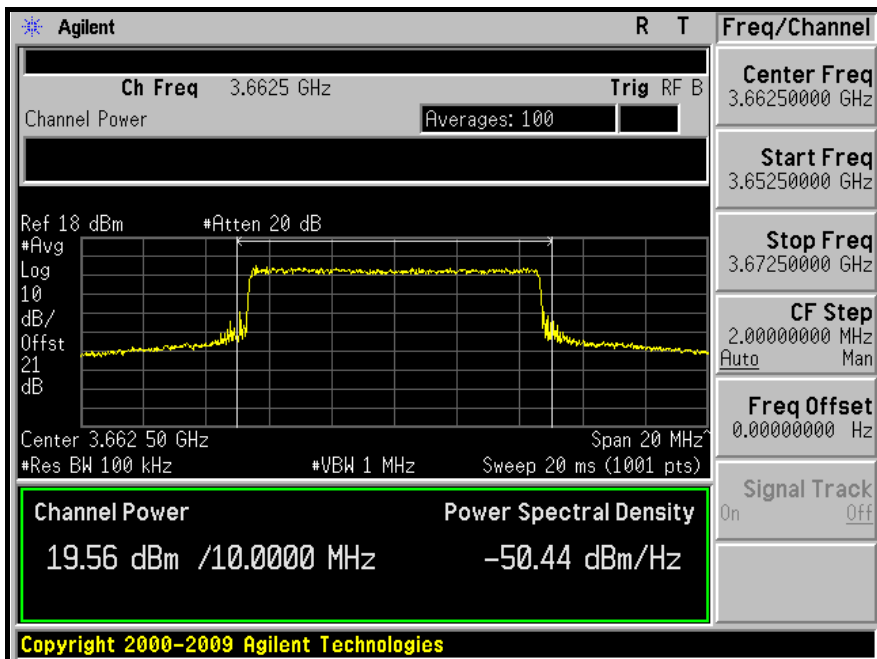



A D T

### HIGH CHANNEL

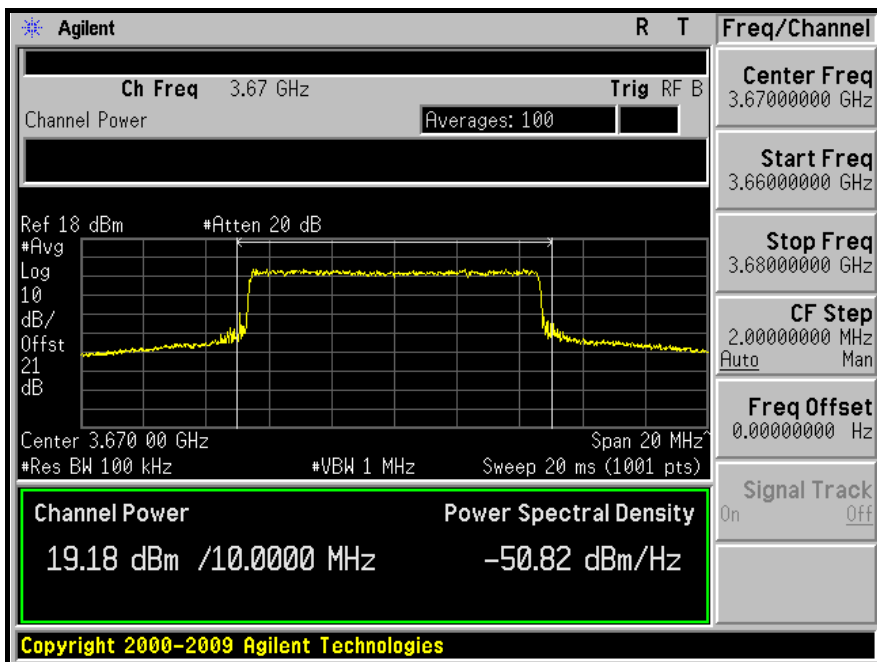





A D T

## POWER DENSITY

CHAIN 0

LOW CHANNEL

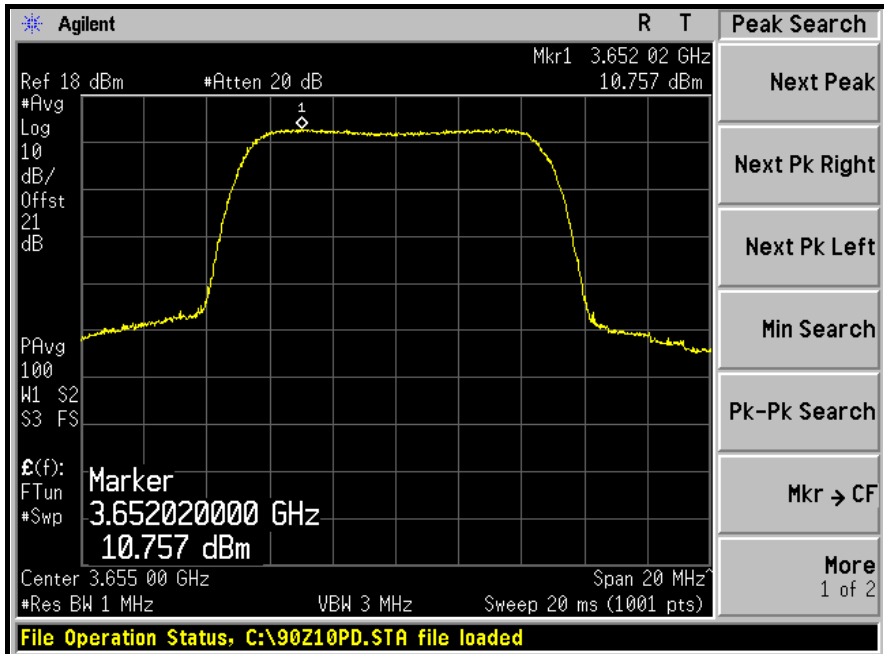

MIDDLE CHANNEL

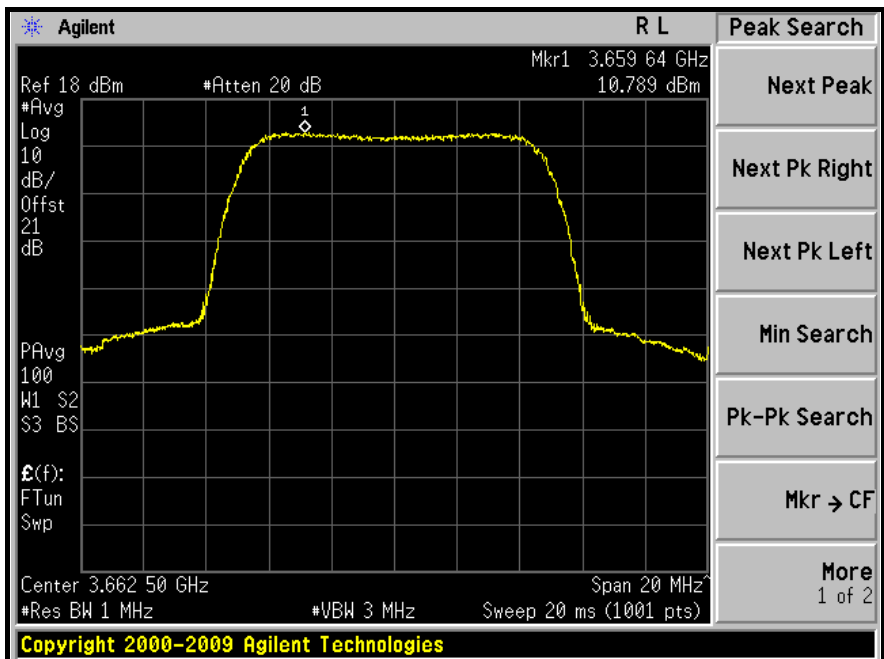



A D T

## HIGH CHANNEL

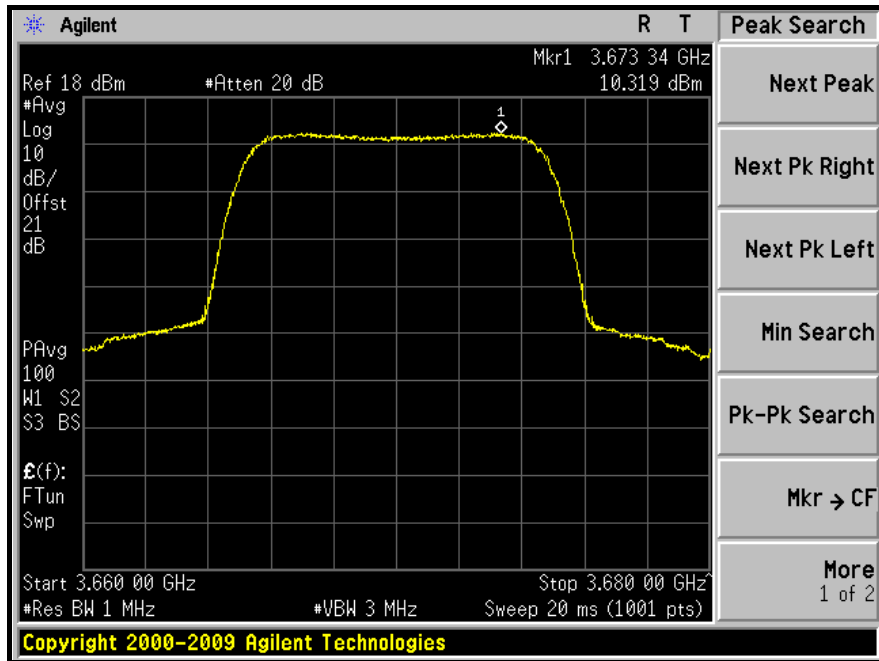



A D T

### CHAIN 1 LOW CHANNEL

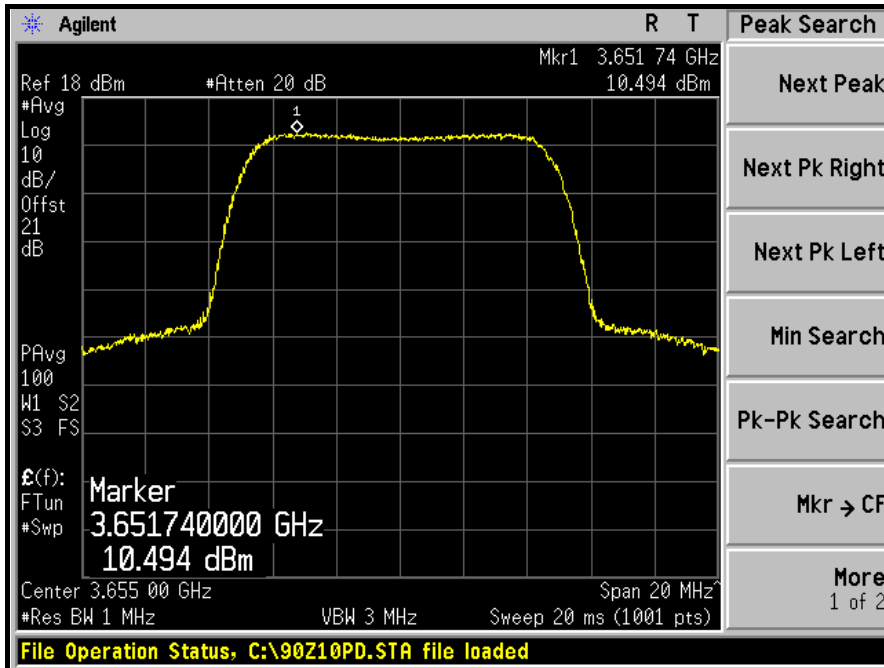

### MIDDLE CHANNEL

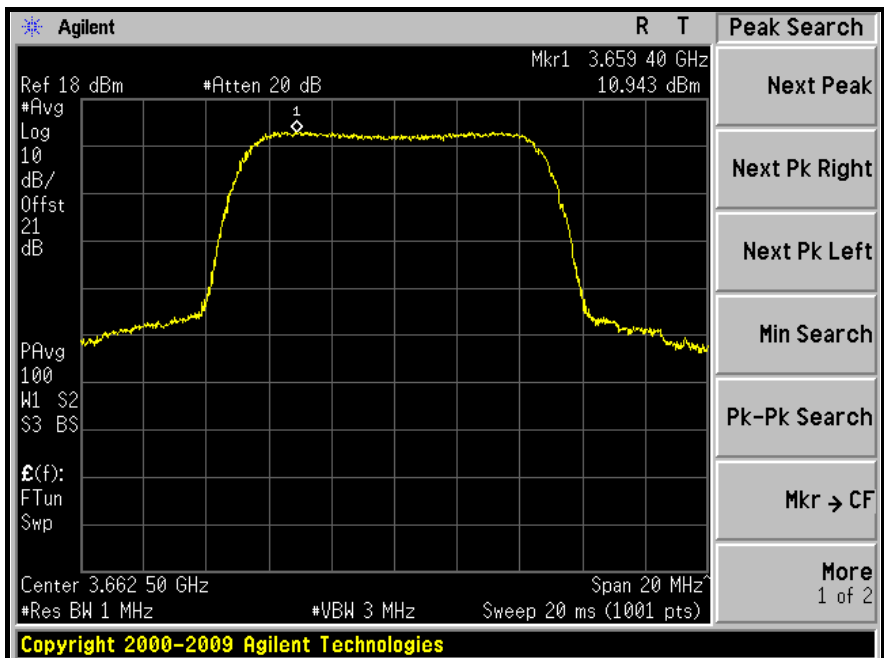



A D T

### HIGH CHANNEL

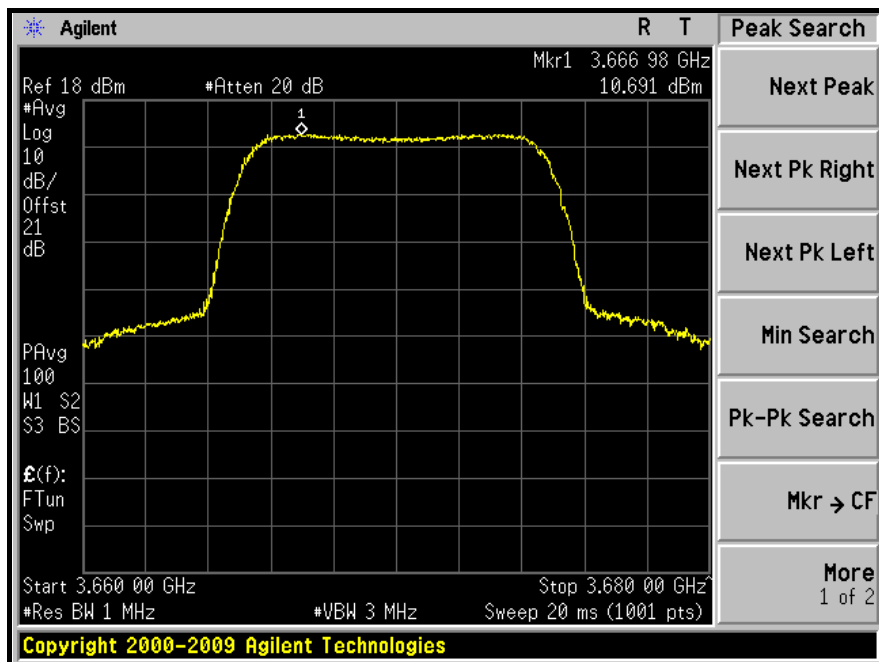



A D T

## For QPSK-3/4

CHANNEL BANDWIDTH: 5MHz

CONDUCTED POWER					
CHANNEL	FREQUENCY (MHz)	CONDUCTED POWER (dBm)		TOTAL POWER (mW)	TOTAL POWER (dBm)
		CHAIN 0	CHAIN 1		
Low	3652.5	15.67	15.37	71.333	18.53
Middle	3662.5	15.86	16.28	81.01	19.09
High	3672.5	16.09	16.05	80.916	19.08

EIRP POWER							
CHANNEL	FREQUENCY (MHz)	EIRP (dBm)		ANTENNA GAIN (dBi)	TOTAL POWER (mW)	TOTAL POWER (dBm)	Limit (dBm)
		CHAIN 0	CHAIN 1				
Low	3652.5	17.67	17.37	2	113.06	20.53	23.01
Middle	3662.5	17.86	18.28	2	128.39	21.09	23.01
High	3672.5	18.09	18.05	2	128.24	21.08	23.01

### NOTE:

1. EIRP = Conducted power + Antenna Gain
2. Chain 0: RF output port 0 , Chain 1: RF output port 1.



A D T

## OUTPUT POWER

### CHAIN 0

### LOW CHANNEL

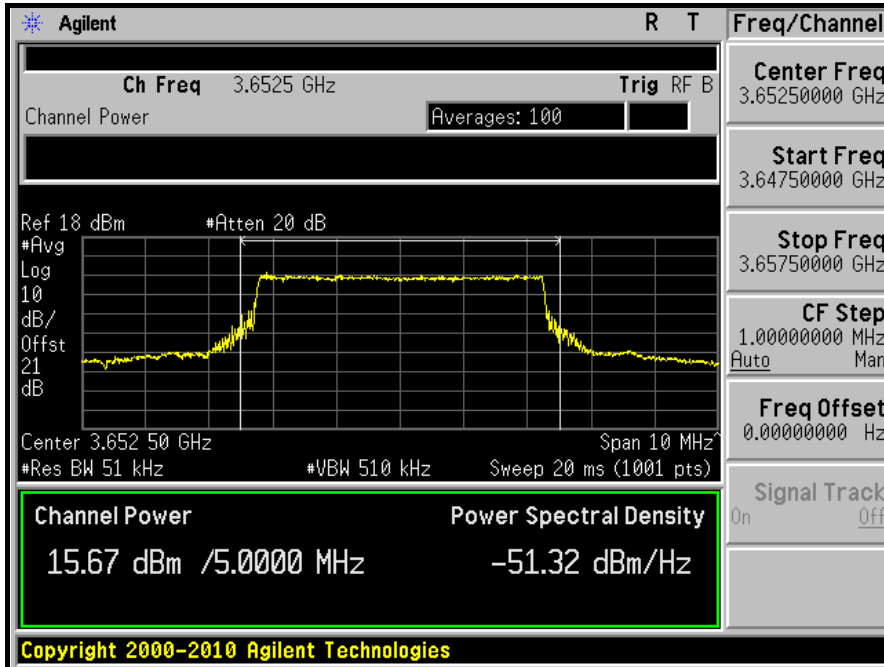

### MIDDLE CHANNEL

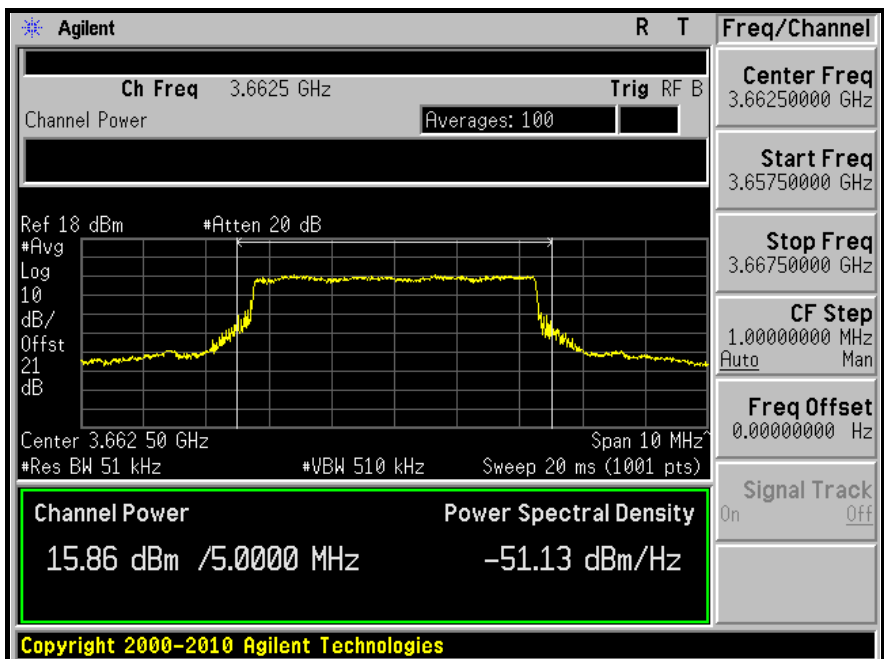



A D T

### HIGH CHANNEL

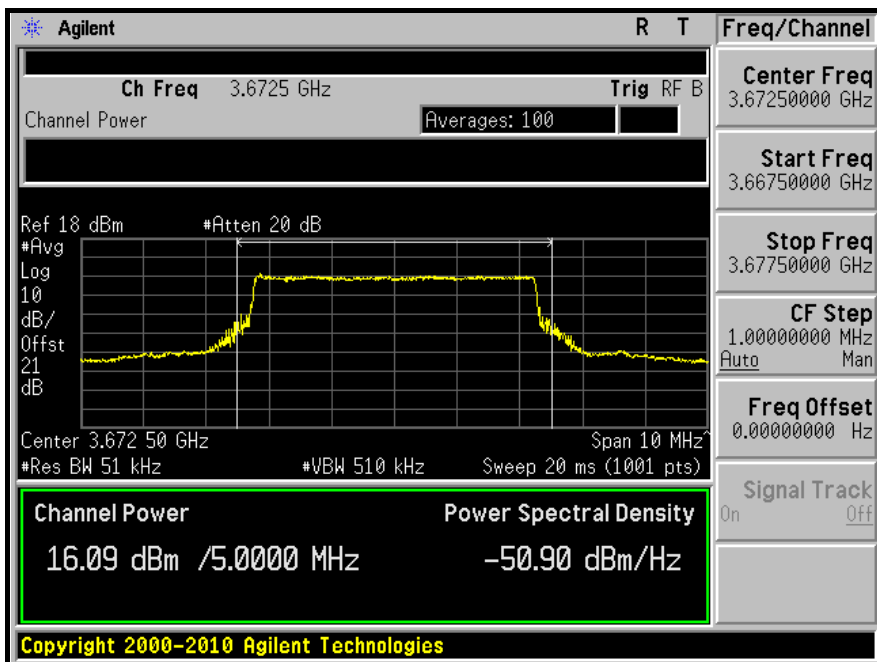



A D T

### CHAIN 1 LOW CHANNEL

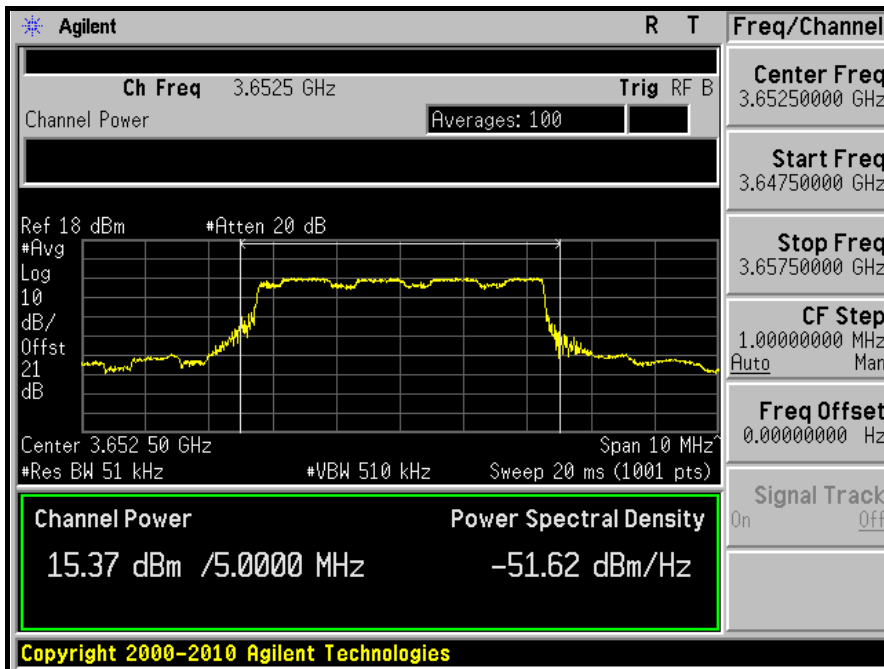

### MIDDLE CHANNEL

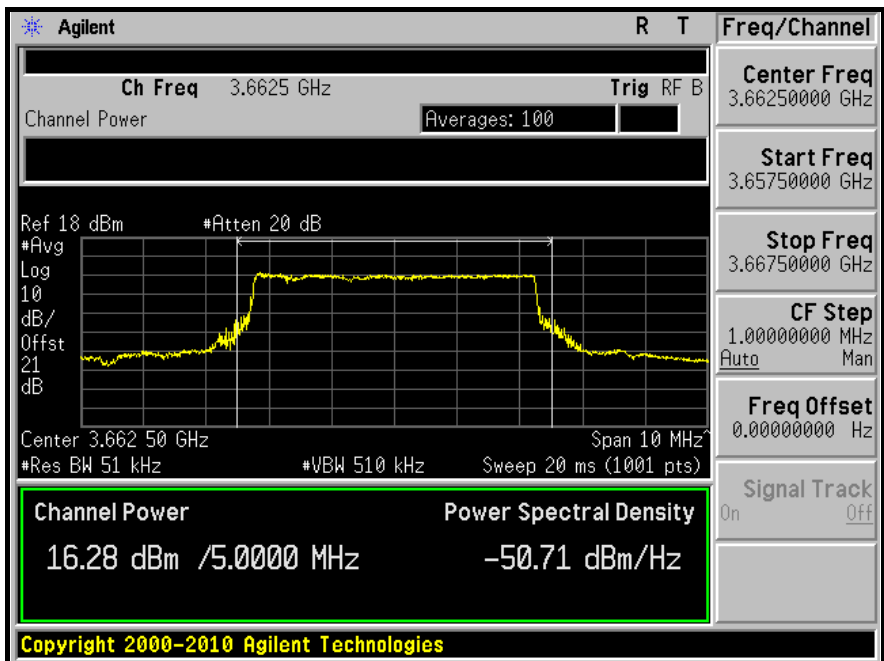





A D T

### HIGH CHANNEL

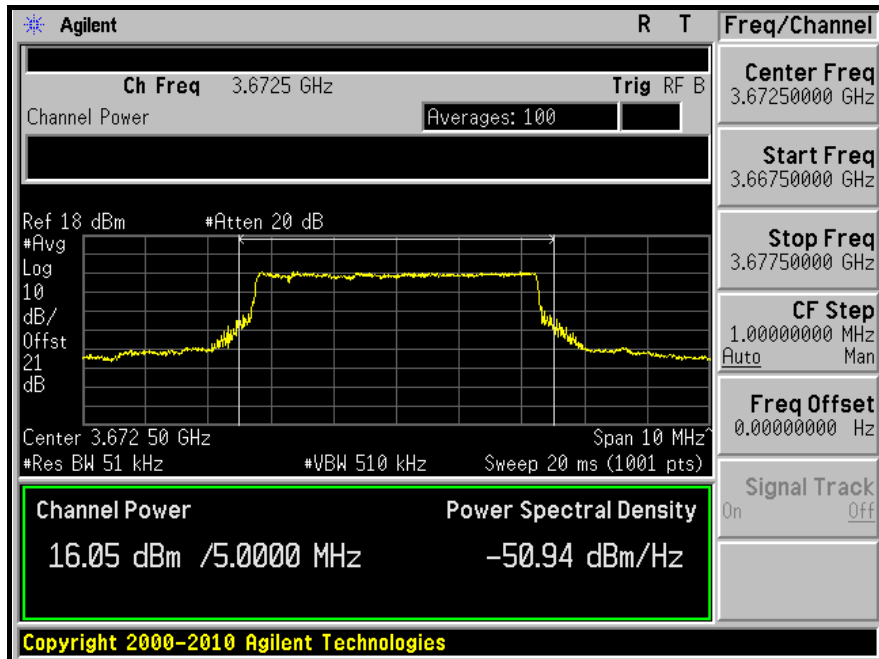



A D T

**CHANNEL BANDWIDTH: 10MHz**

CONDUCTED POWER					
CHANNEL	FREQUENCY (MHz)	CONDUCTED POWER (dBm)		TOTAL POWER (mW)	TOTAL POWER (dBm)
		CHAIN 0	CHAIN 1		
Low	3655	19.35	18.97	164.99	22.17
Middle	3662.5	19.16	18.93	160.58	22.06
High	3670	18.80	18.99	155.11	21.91

EIRP POWER							
CHANNEL	FREQUENCY (MHz)	EIRP (dBm)		ANTENNA GAIN (dBi)	TOTAL POWER (mW)	TOTAL POWER (dBm)	Limit (dBm)
		CHAIN 0	CHAIN 1				
Low	3655	21.35	20.97	2	261.48	24.17	26.02
Middle	3662.5	21.16	20.93	2	254.5	24.06	26.02
High	3670	20.80	20.99	2	245.83	23.91	26.02

**NOTE:**

1. EIRP = Conducted power + Antenna Gain
2. Chain 0: RF output port 0 , Chain 1: RF output port 1.



A D T

## OUTPUT POWER

### CHAIN 0

### LOW CHANNEL

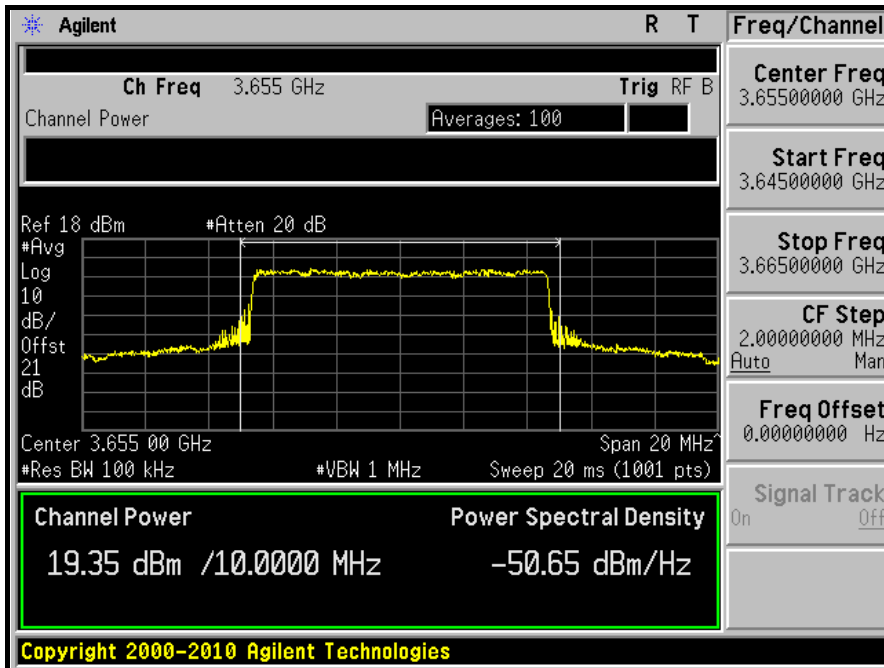

### MIDDLE CHANNEL

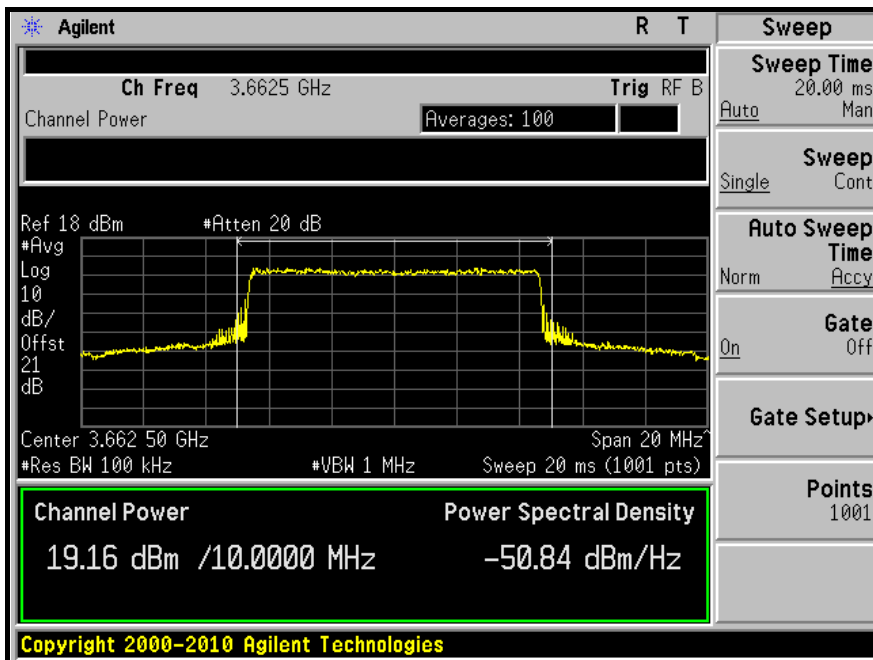



A D T

### HIGH CHANNEL

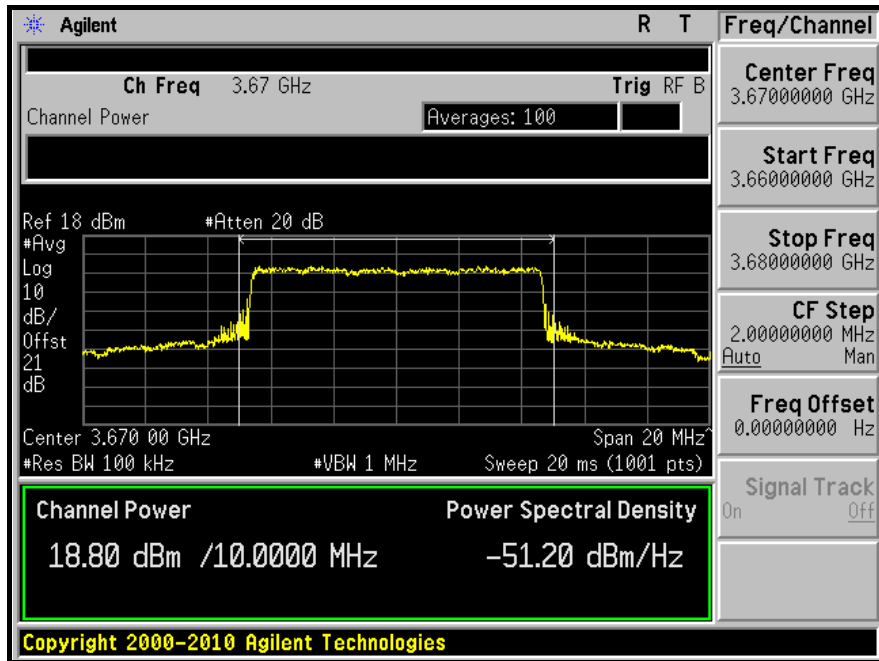



A D T

### CHAIN 1 LOW CHANNEL

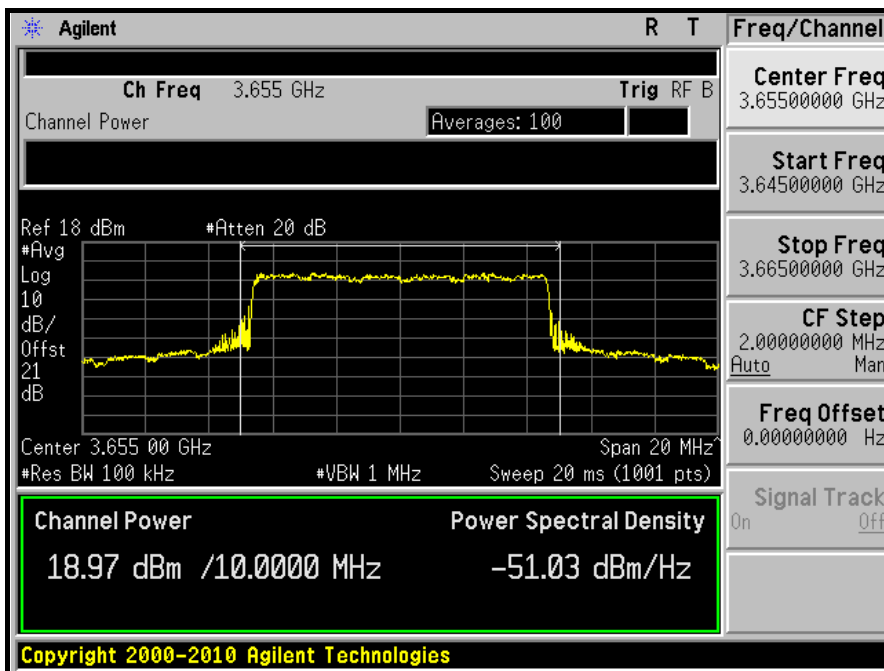

### MIDDLE CHANNEL

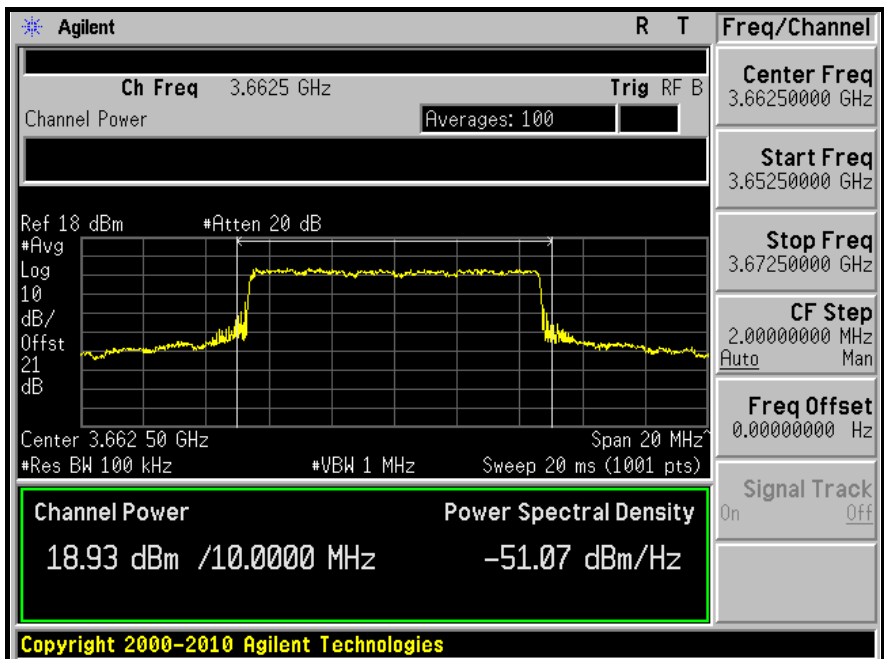



A D T

### HIGH CHANNEL

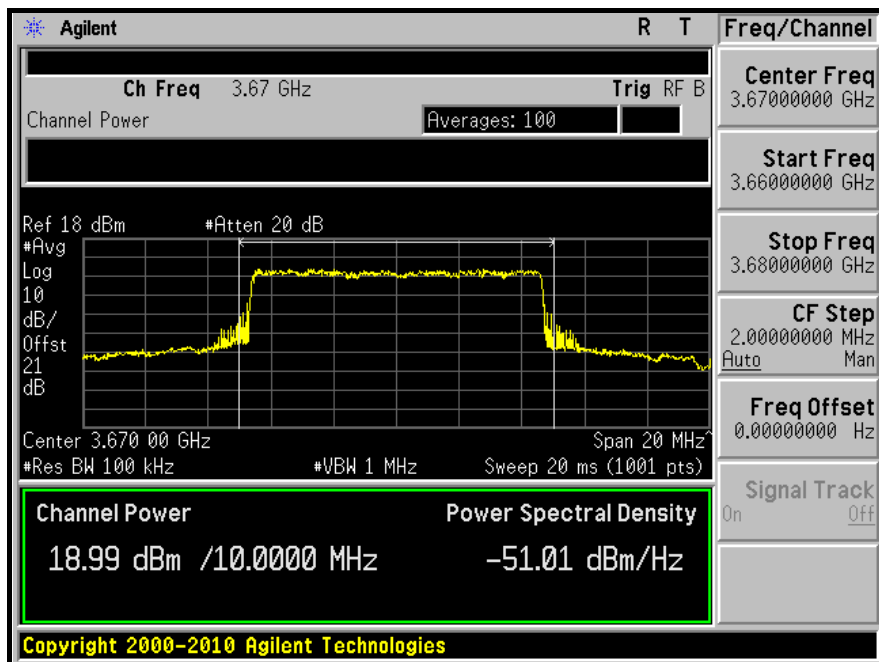



A D T

## For 16QAM-1/2

CHANNEL BANDWIDTH: 5MHz

CONDUCTED POWER					
CHANNEL	FREQUENCY (MHz)	CONDUCTED POWER (dBm)		TOTAL POWER (mW)	TOTAL POWER (dBm)
		CHAIN 0	CHAIN 1		
Low	3652.5	15.48	15.42	70.152	18.46
Middle	3662.5	15.81	16.25	80.277	19.05
High	3672.5	16.04	16.05	80.451	19.06

EIRP POWER							
CHANNEL	FREQUENCY (MHz)	EIRP (dBm)		ANTENNA GAIN (dBi)	TOTAL POWER (mW)	TOTAL POWER (dBm)	Limit (dBm)
		CHAIN 0	CHAIN 1				
Low	3652.5	17.48	17.42	2	111.18	20.46	23.01
Middle	3662.5	17.81	18.25	2	127.23	21.05	23.01
High	3672.5	18.04	18.05	2	127.51	21.06	23.01

### NOTE:

1. EIRP = Conducted power + Antenna Gain
2. Chain 0: RF output port 0 , Chain 1: RF output port 1.



A D T

## OUTPUT POWER

### CHAIN 0

### LOW CHANNEL

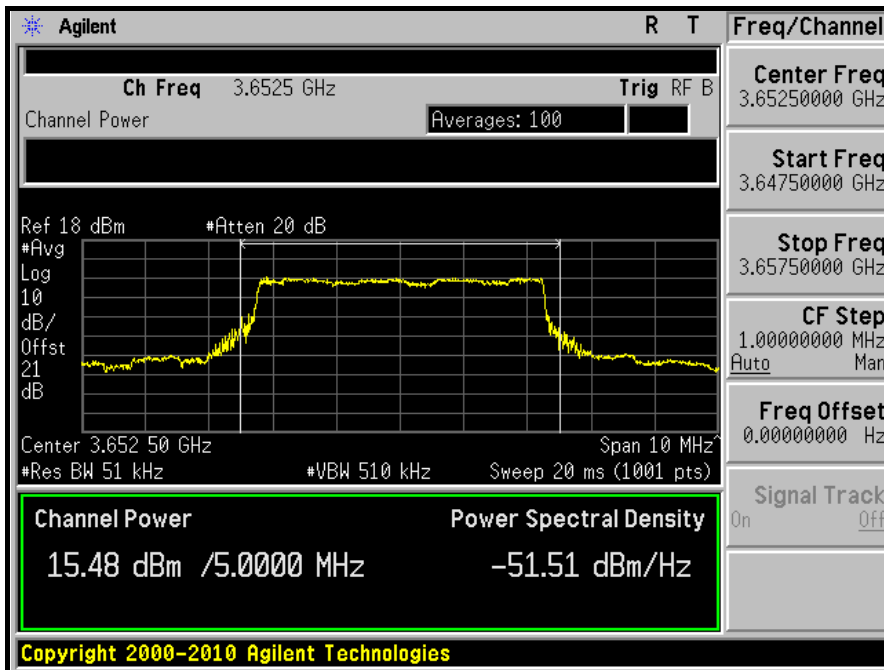

### MIDDLE CHANNEL

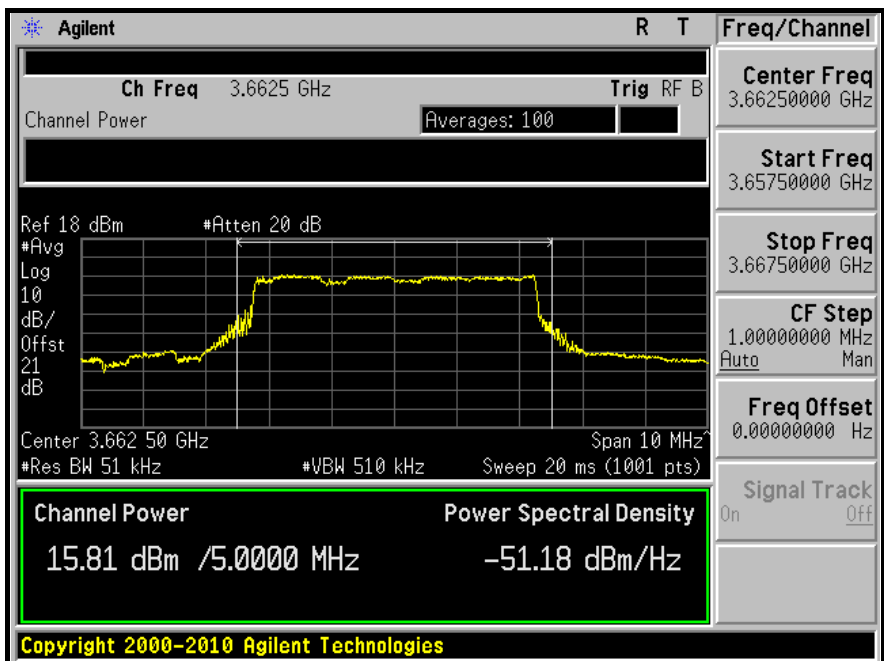





A D T

### HIGH CHANNEL

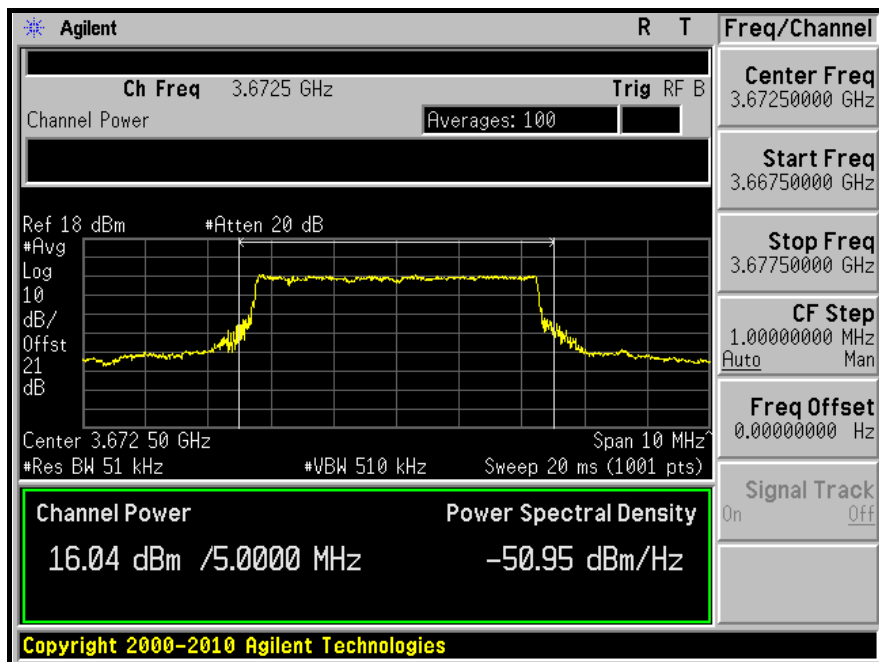



A D T

### CHAIN 1 LOW CHANNEL

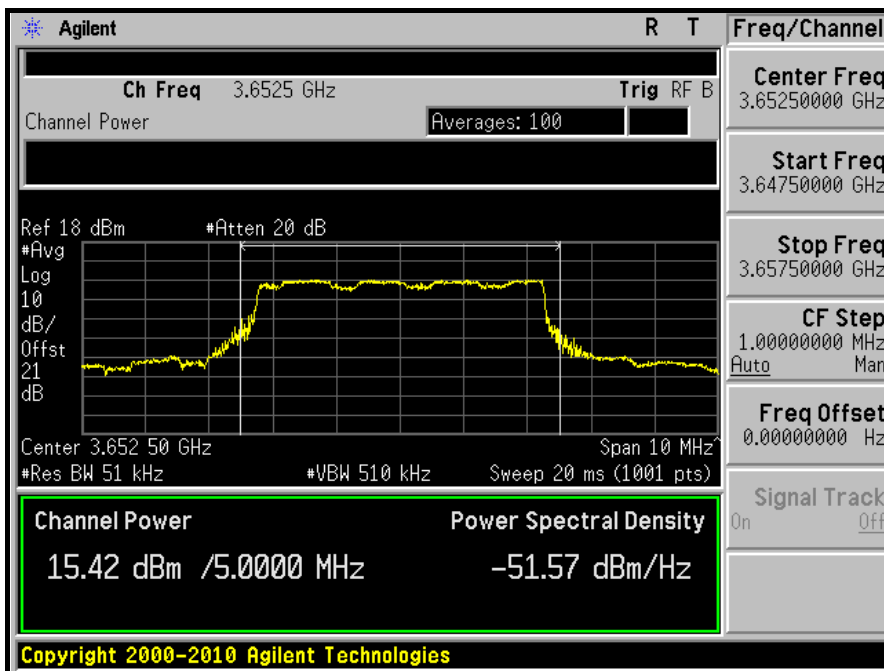

### MIDDLE CHANNEL

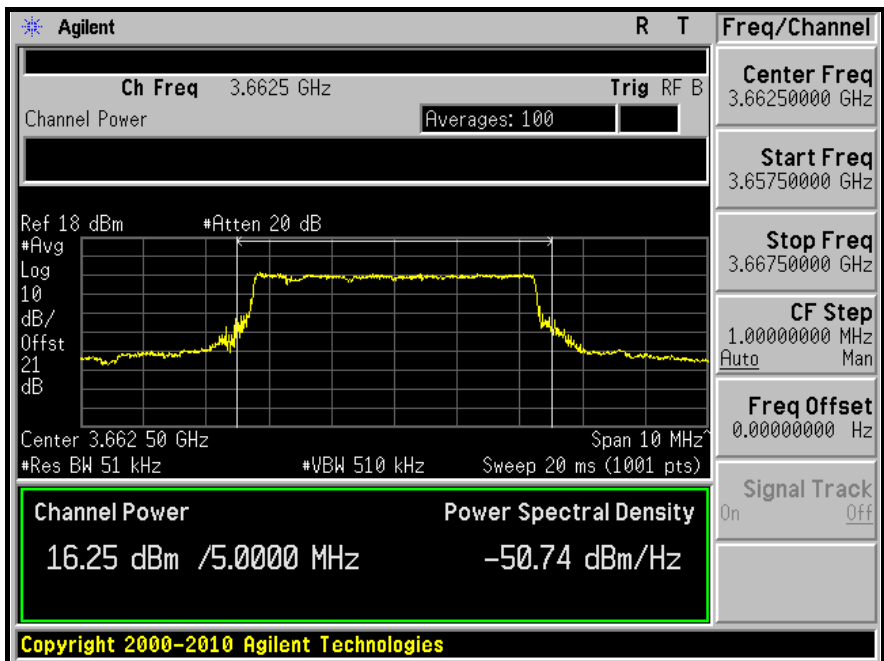



A D T

### HIGH CHANNEL

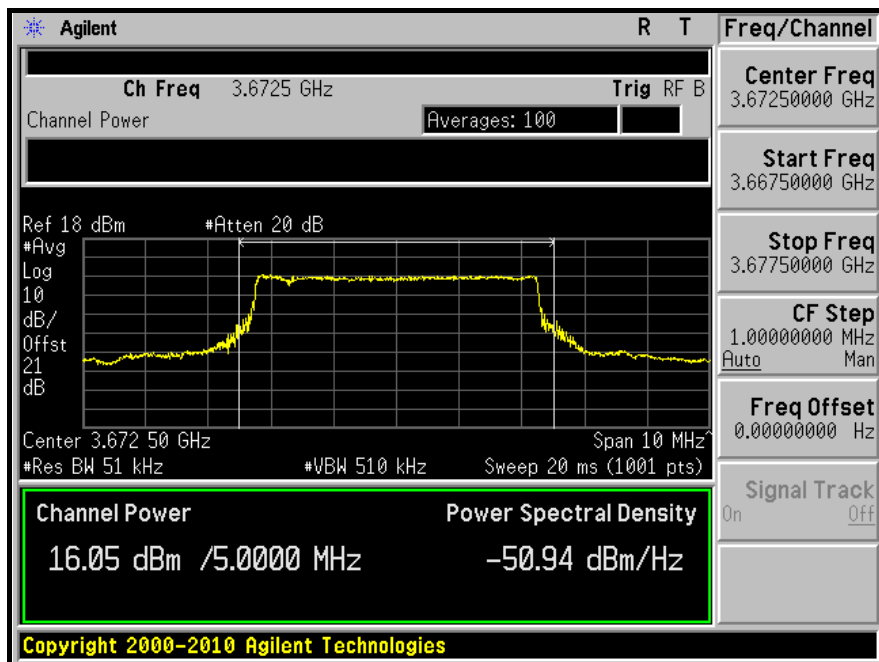



A D T

**CHANNEL BANDWIDTH: 10MHz**

CONDUCTED POWER					
CHANNEL	FREQUENCY (MHz)	CONDUCTED POWER (dBm)		TOTAL POWER (mW)	TOTAL POWER (dBm)
		CHAIN 0	CHAIN 1		
Low	3655	19.31	19.16	167.72	22.25
Middle	3662.5	19.34	19.00	165.33	22.18
High	3670	18.87	18.94	155.43	21.92

EIRP POWER							
CHANNEL	FREQUENCY (MHz)	EIRP (dBm)		ANTENNA GAIN (dBi)	TOTAL POWER (mW)	TOTAL POWER (dBm)	Limit (dBm)
		CHAIN 0	CHAIN 1				
Low	3655	21.31	21.16	2	265.82	24.25	26.02
Middle	3662.5	21.34	21.00	2	262.04	24.18	26.02
High	3670	20.87	20.94	2	246.35	23.92	26.02

**NOTE:**

1. EIRP = Conducted power + Antenna Gain
2. Chain 0: RF output port 0 , Chain 1: RF output port 1.



A D T

## OUTPUT POWER

### CHAIN 0

### LOW CHANNEL

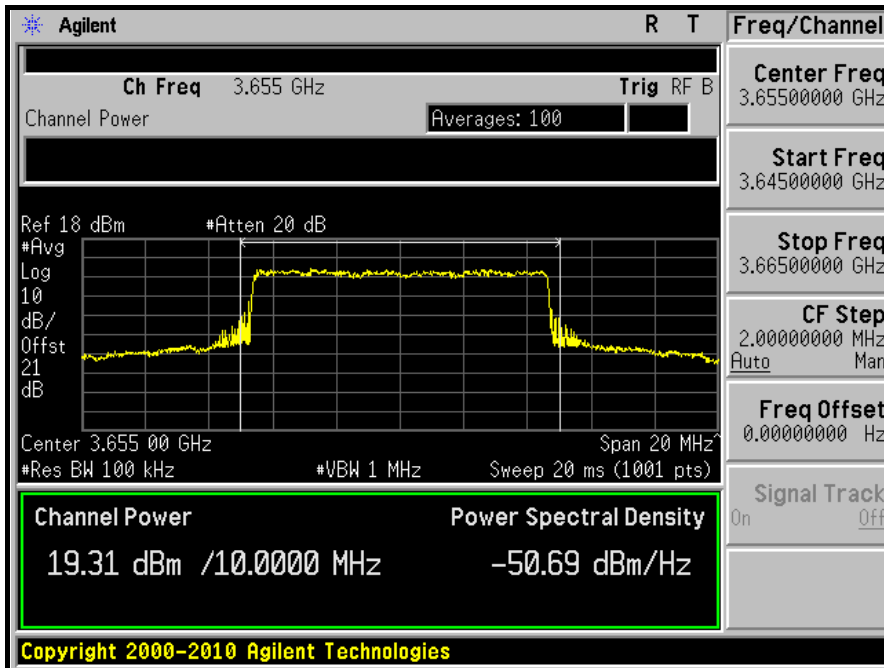

### MIDDLE CHANNEL

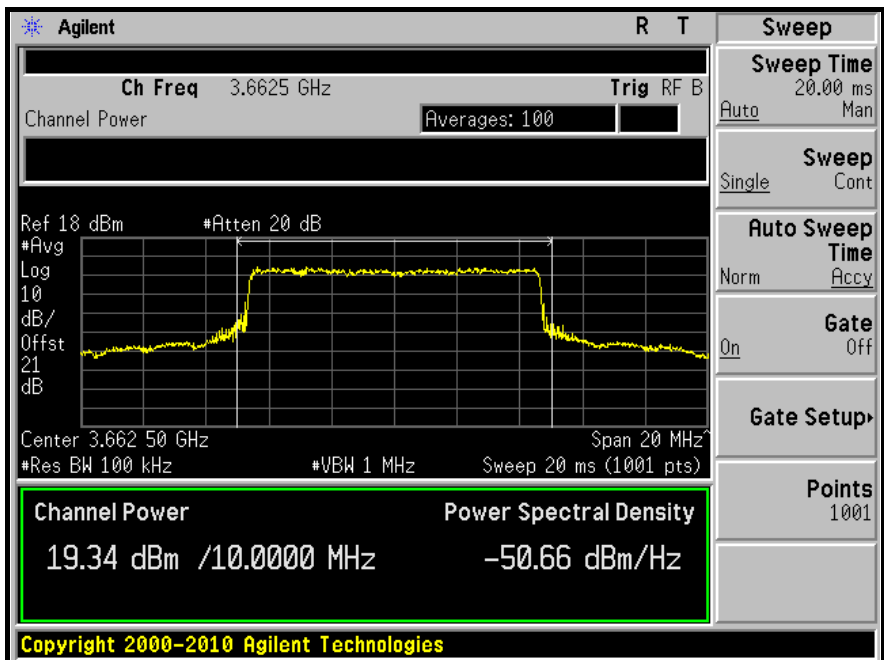



A D T

### HIGH CHANNEL

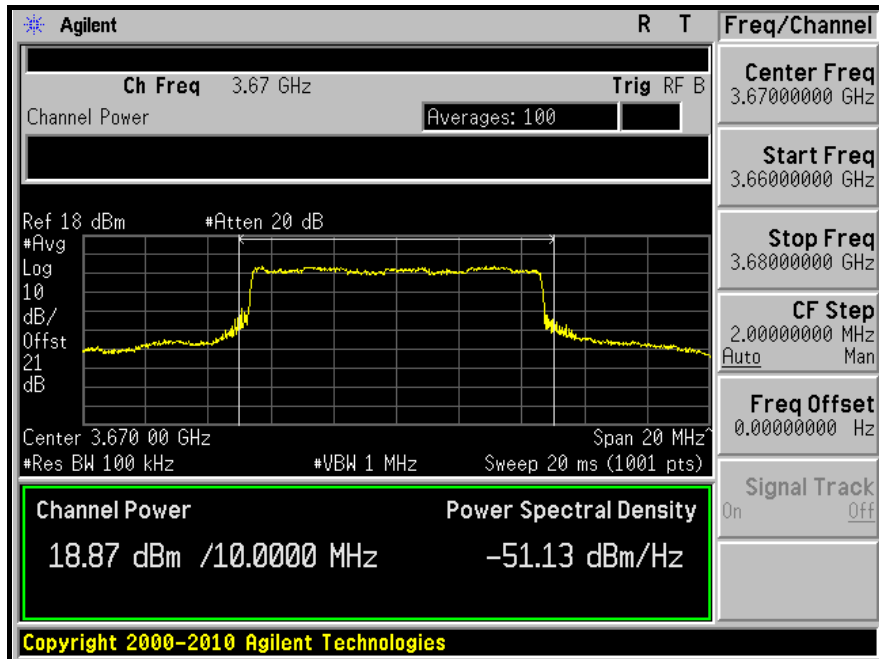



A D T

### CHAIN 1 LOW CHANNEL

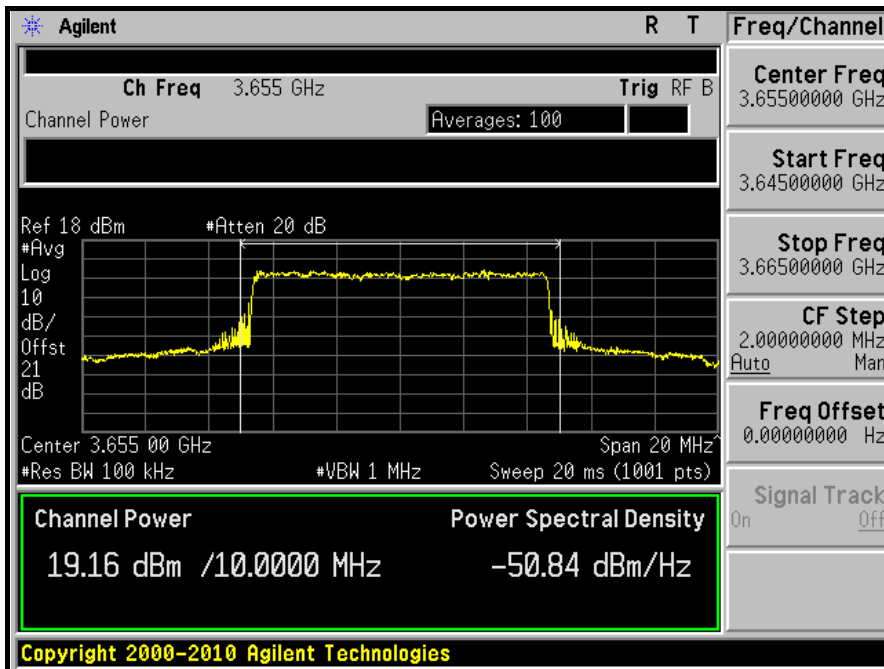

### MIDDLE CHANNEL

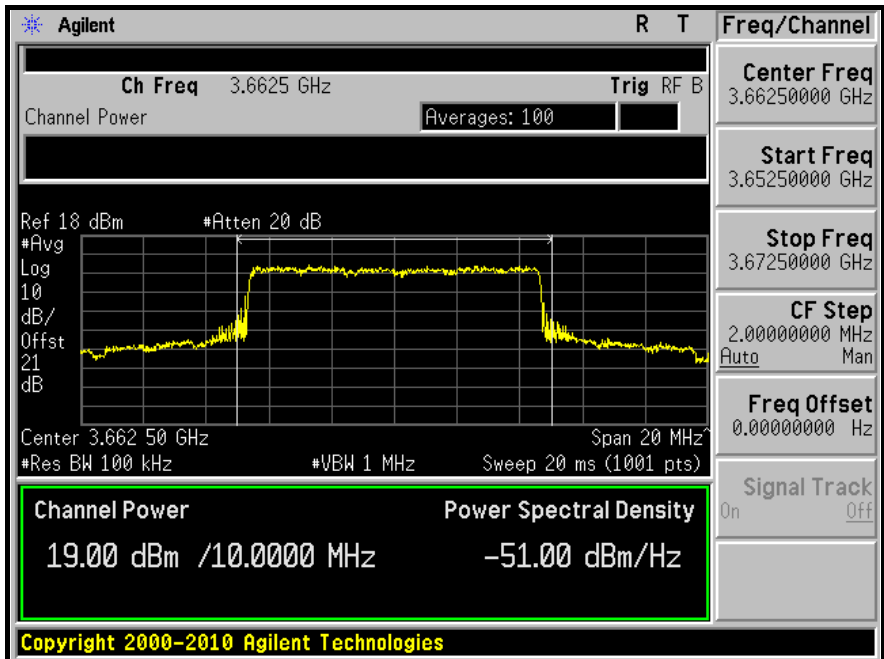



A D T

## HIGH CHANNEL

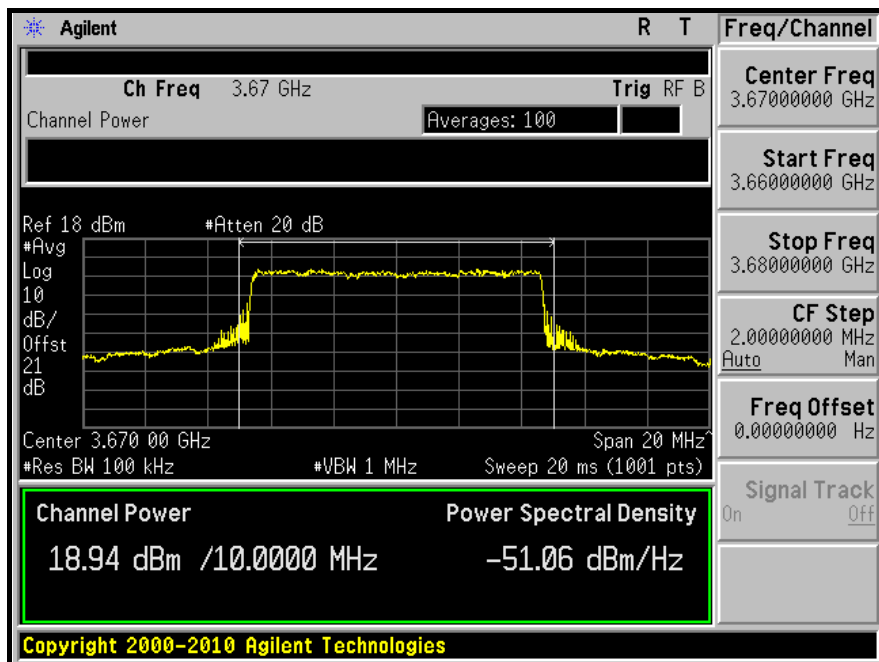





A D T

## For 16QAM-3/4

CHANNEL BANDWIDTH: 5MHz

CONDUCTED POWER					
CHANNEL	FREQUENCY (MHz)	CONDUCTED POWER (dBm)		TOTAL POWER (mW)	TOTAL POWER (dBm)
		CHAIN 0	CHAIN 1		
Low	3652.5	15.42	15.36	69.19	18.40
Middle	3662.5	15.77	16.32	80.612	19.06
High	3672.5	16.02	15.99	79.713	19.02

EIRP POWER							
CHANNEL	FREQUENCY (MHz)	EIRP (dBm)		ANTENNA GAIN (dBi)	TOTAL POWER (mW)	TOTAL POWER (dBm)	Limit (dBm)
		CHAIN 0	CHAIN 1				
Low	3652.5	17.42	17.36	2	109.66	20.40	23.01
Middle	3662.5	17.77	18.32	2	127.76	21.06	23.01
High	3672.5	18.02	17.99	2	126.34	21.02	23.01

### NOTE:

1. EIRP = Conducted power + Antenna Gain
2. Chain 0: RF output port 0 , Chain 1: RF output port 1.



A D T

## OUTPUT POWER

### CHAIN 0

### LOW CHANNEL

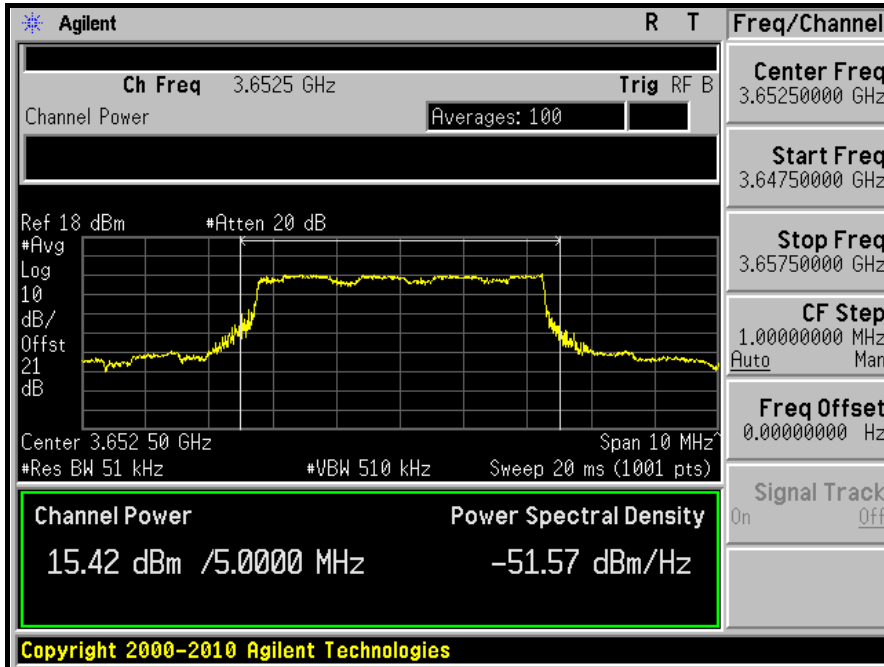

### MIDDLE CHANNEL

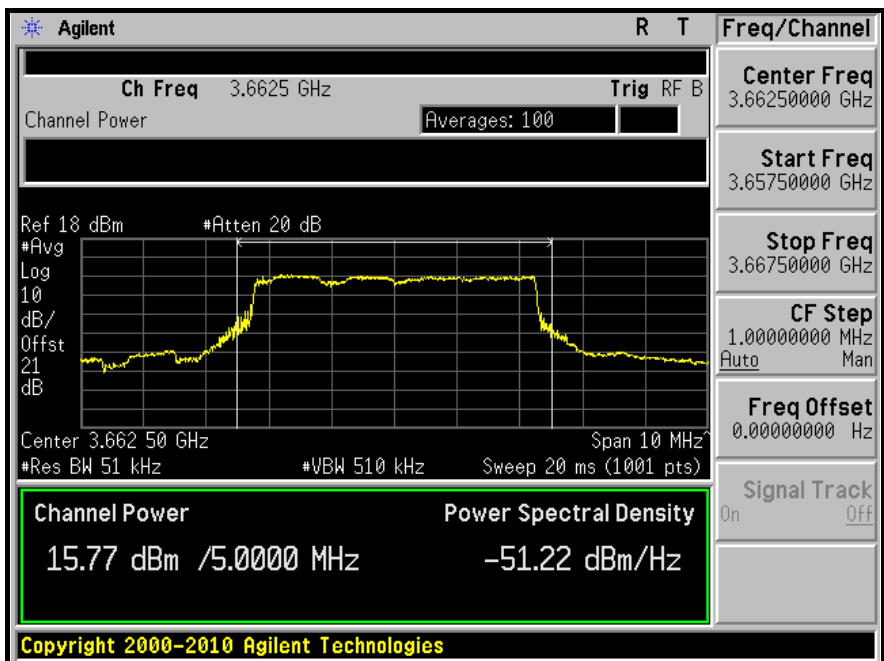



A D T

### HIGH CHANNEL

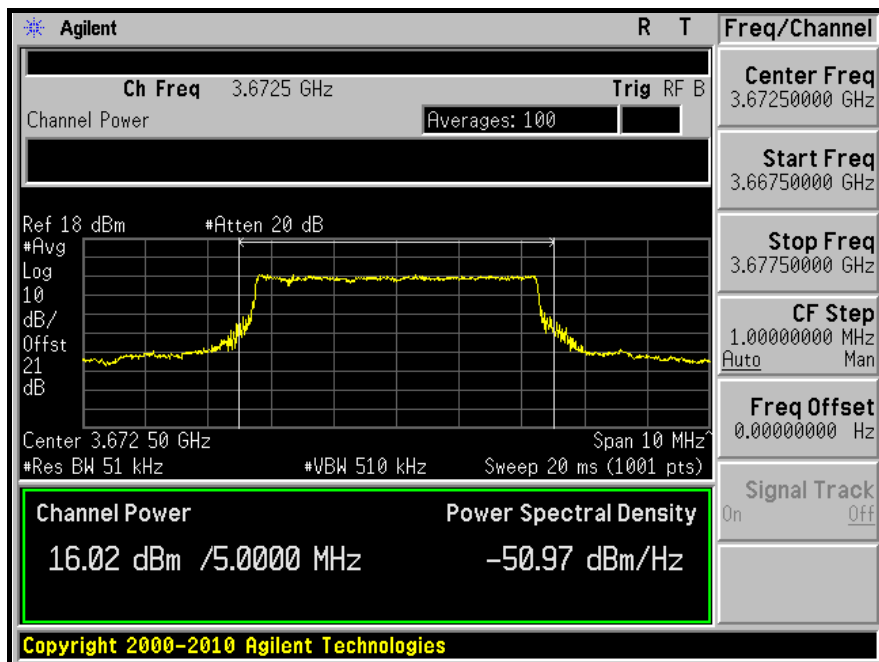



A D T

### CHAIN 1 LOW CHANNEL

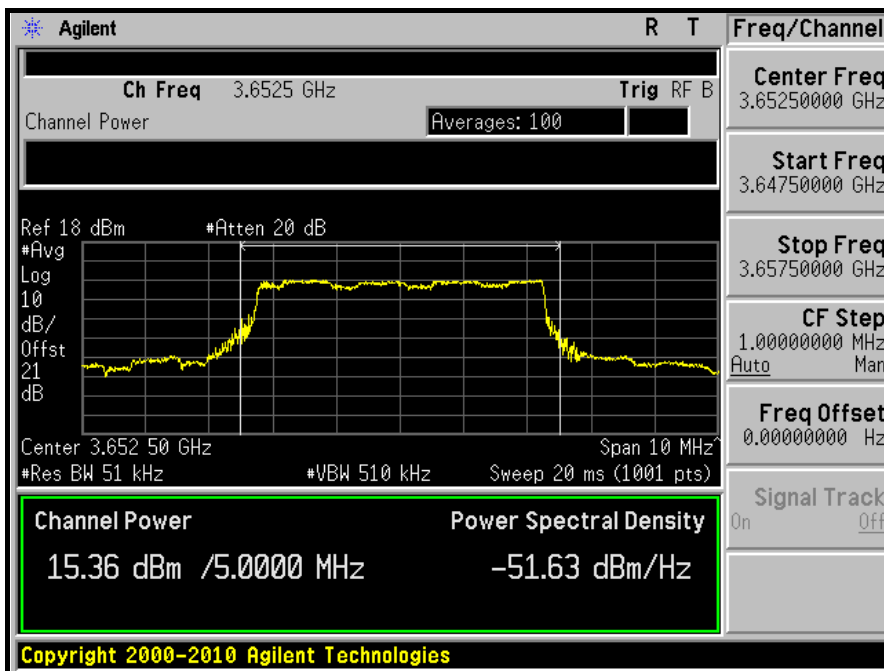

### MIDDLE CHANNEL

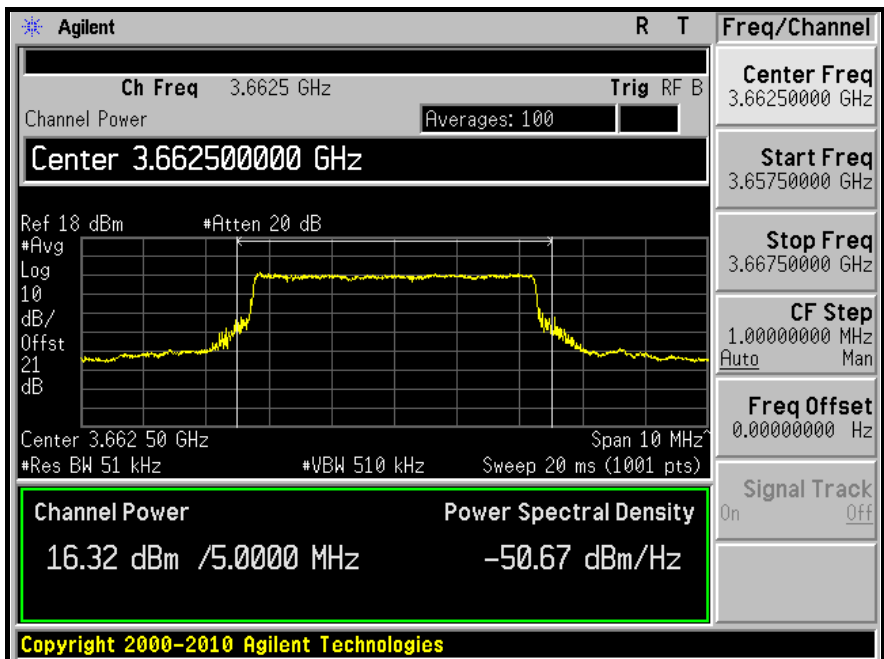



A D T

### HIGH CHANNEL

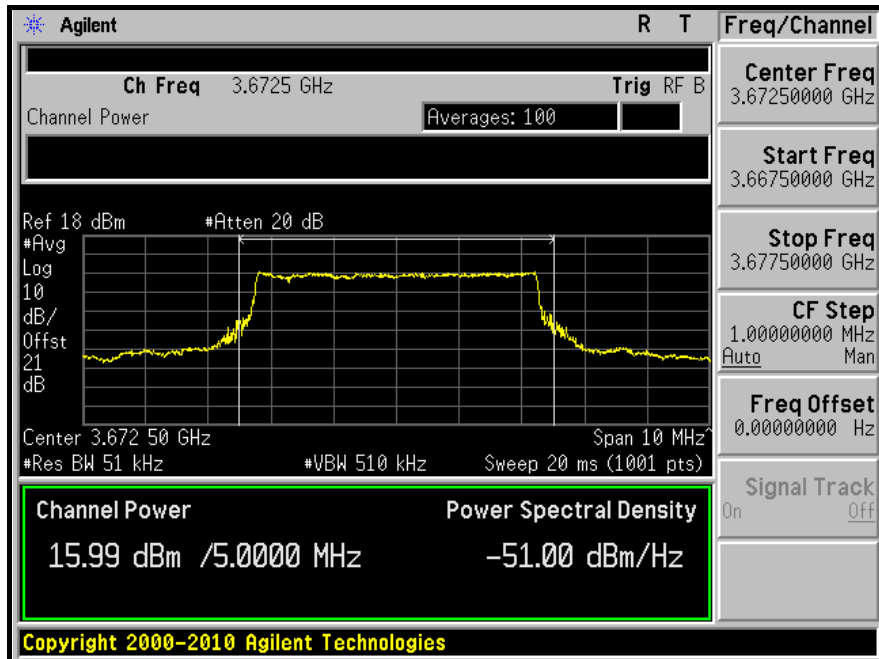



A D T

**CHANNEL BANDWIDTH: 10MHz**

CONDUCTED POWER					
CHANNEL	FREQUENCY (MHz)	CONDUCTED POWER (dBm)		TOTAL POWER (mW)	TOTAL POWER (dBm)
		CHAIN 0	CHAIN 1		
Low	3655	19.54	19.19	172.94	22.38
Middle	3662.5	19.33	19.17	168.31	22.26
High	3670	18.71	19.10	155.59	21.92

EIRP POWER							
CHANNEL	FREQUENCY (MHz)	EIRP (dBm)		ANTENNA GAIN (dBi)	TOTAL POWER (mW)	TOTAL POWER (dBm)	Limit (dBm)
		CHAIN 0	CHAIN 1				
Low	3655	21.54	21.19	2	274.08	24.38	26.02
Middle	3662.5	21.33	21.17	2	266.75	24.26	26.02
High	3670	20.71	21.10	2	246.59	23.92	26.02

**NOTE:**

1. EIRP = Conducted power + Antenna Gain
2. Chain 0: RF output port 0 , Chain 1: RF output port 1.



A D T

## OUTPUT POWER

### CHAIN 0

### LOW CHANNEL

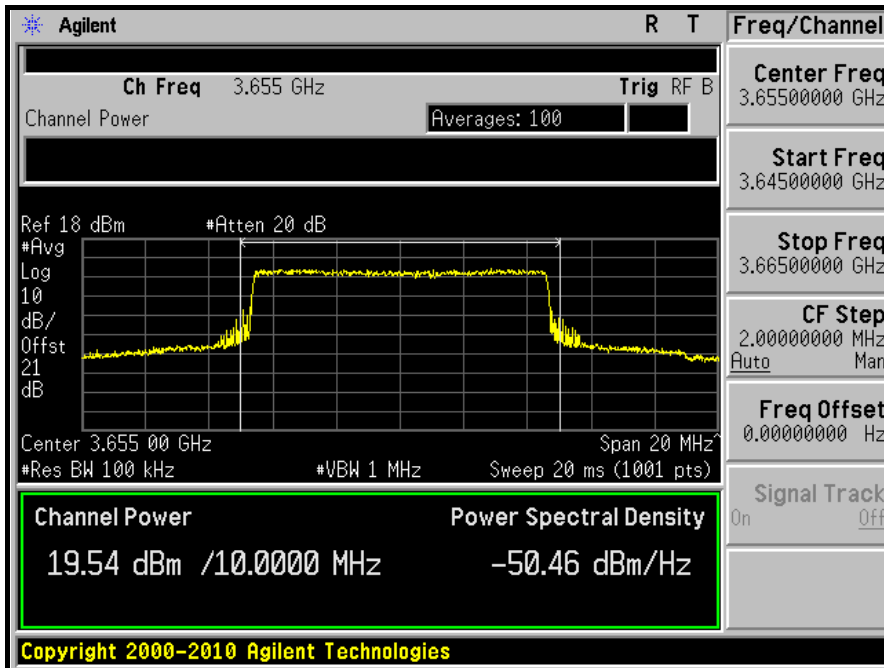

### MIDDLE CHANNEL

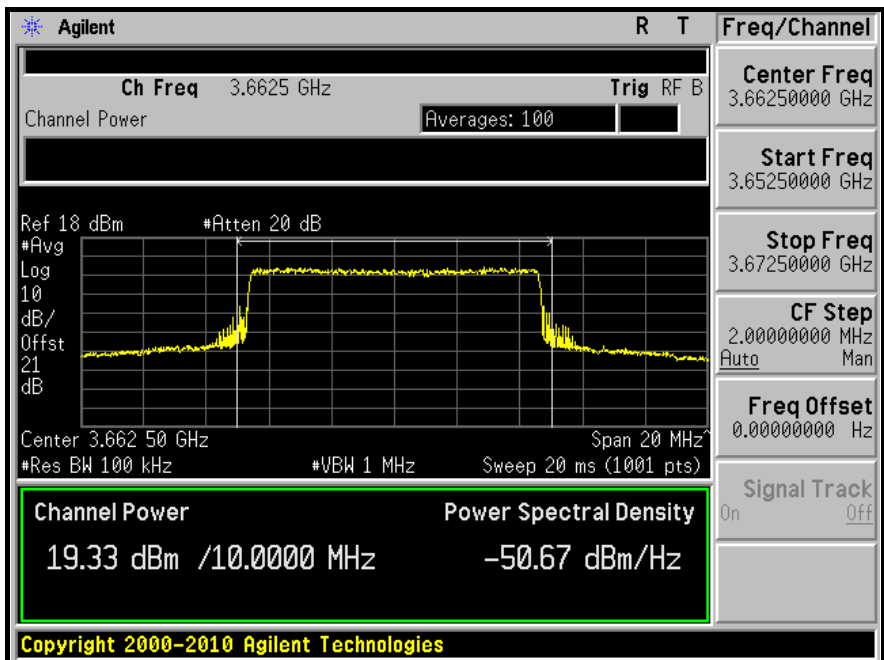



A D T

## HIGH CHANNEL

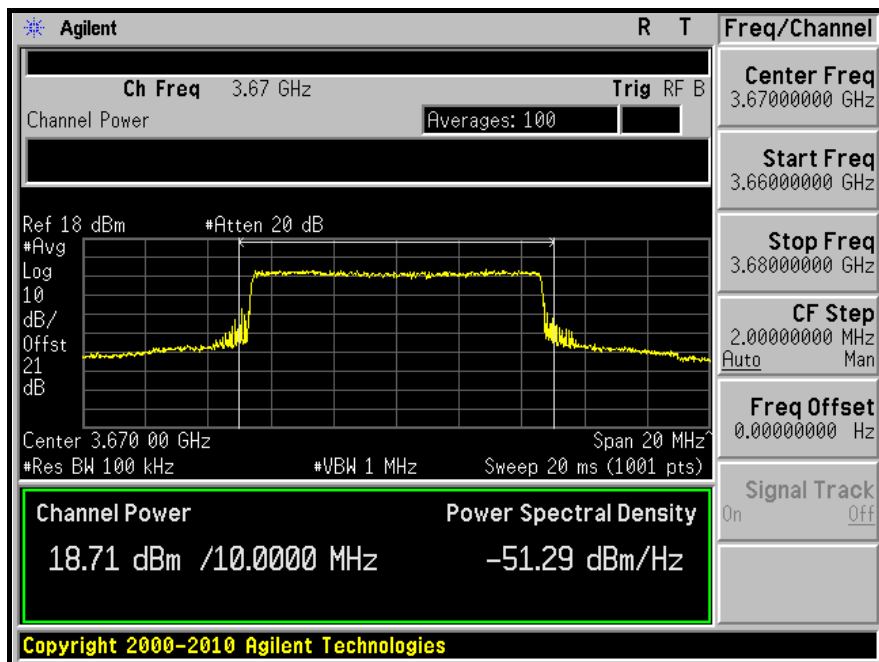





A D T

### CHAIN 1 LOW CHANNEL

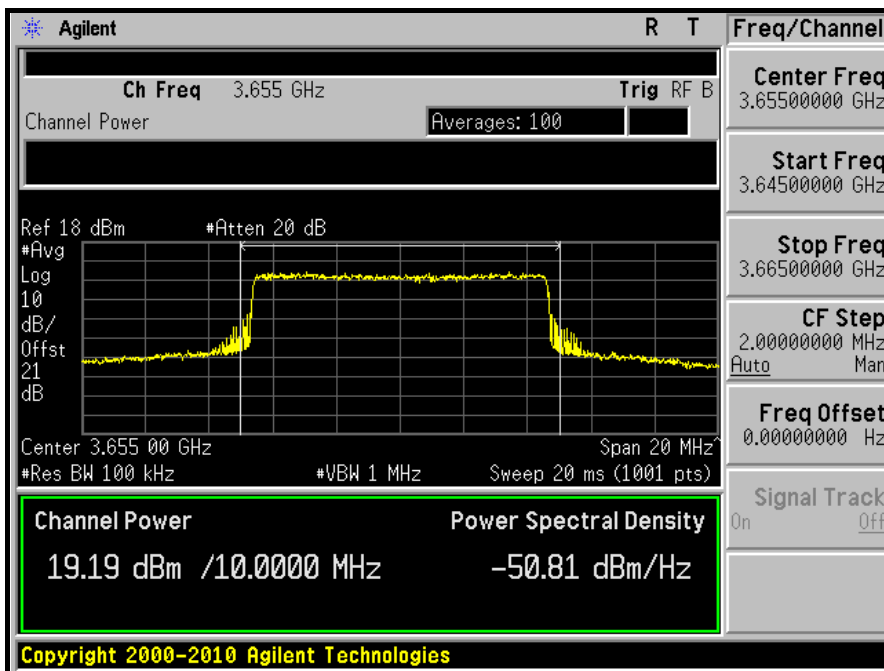

### MIDDLE CHANNEL

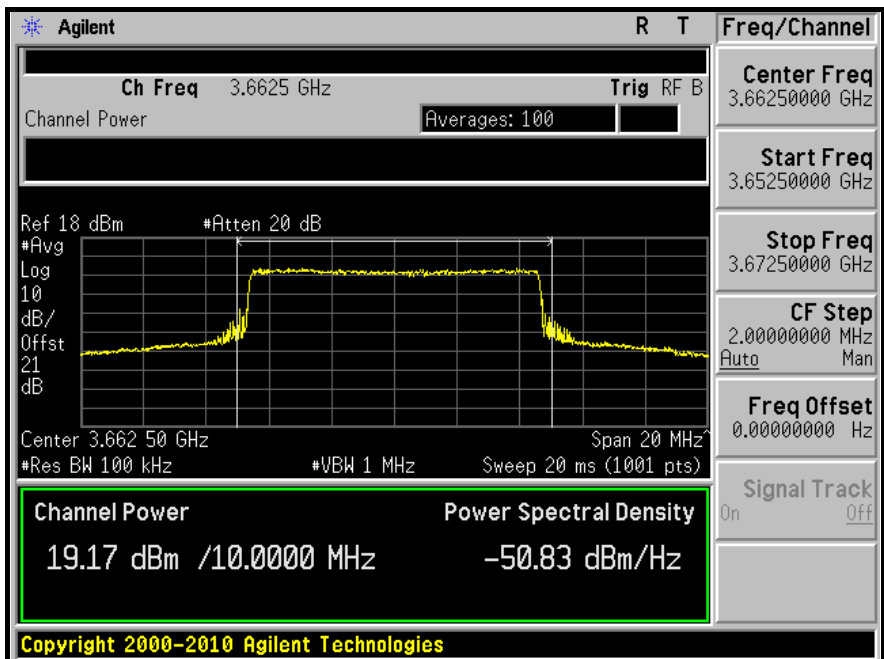



A D T

### HIGH CHANNEL

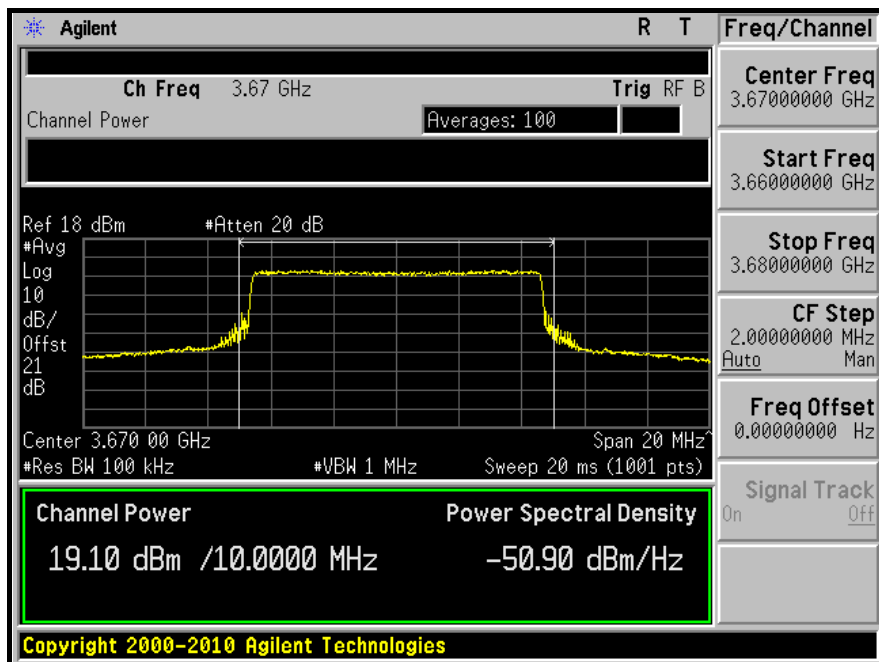

## 4.2 FREQUENCY STABILITY MEASUREMENT

### 4.2.1 LIMITS OF FREQUENCY STABILITY MEASUREMENT

According to the FCC part 2.1055 shall be tested the frequency stability. The rule is defined that” The frequency stability shall be sufficient to ensure that the fundamental emission stays within the authorized frequency block.” The test extreme voltage is according to the 2.1055(d)(1) Vary primary supply voltage from 85 to 115 percent of the nominal value for other than hand carried battery equipment and the extreme temperature rule is comply with specification of EUT -30°C ~ 50°C.

### 4.2.2 TEST INSTRUMENTS

DESCRIPTION & MANUFACTURER	MODEL NO.	SERIAL NO.	DATE OF CALIBRATION	DUE DATE OF CALIBRATION
AGILENT SPECTRUM ANALYZER	E4446A	MY46180622	Apr. 25, 2011	Apr. 24, 2012
SUHNER RF cable	SUCOFLEX 104	222684/4	Jan. 26, 2012	Jan. 25, 2013
JFW 10dB attenuation	50HF-010-SMA	NA	NA	NA
OVEN	MHU-225AU	911033	Dec. 12, 2011	Dec. 11, 2012
Electronics AC Power Source	6502	1140503	NA	NA

**NOTE:**

1. The calibration interval of the above test instruments is 12 months and the calibrations are traceable to NML/ROC and NIST/USA.
2. Tested date: Apr. 17, 2012

#### 4.2.3 TEST PROCEDURE

- a. Power must be removed when changing from one temperature to another or one voltage to another voltage. Power warm up is at least 15 min and power applied should perform before recording frequency error.
- b. EUT is connected the external power supply to control the AC input power. The various Volts from the minimum 102 Volts to 138 Volts. Each step shall be record the frequency error rate.
- c. The temperature range step is 10 degrees in this test items. All temperature levels shall be hold the  $\pm 0.5^{\circ}\text{C}$  during the measurement testing.
- d. The each temperature step shall be at least 0.5 hours, consider the EUT could be test under the stability condition.

#### 4.2.4 TEST SETUP

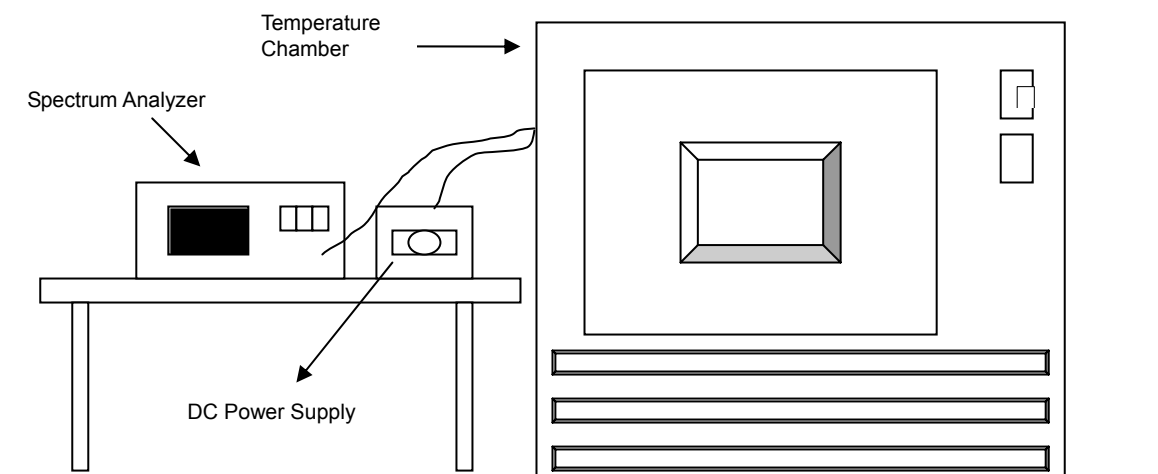

#### 4.2.5 EUT OPERATING CONDITIONS

The EUT connected to the notebook. Use software to control the EUT channel and transmit a single tone.



#### 4.2.6 TEST RESULTS

AFC FREQUENCY ERROR VS. VOLTAGE								
VOLTAGE (Volts)	0Minutes		2Minutes		5Minutes		10Minutes	
	FREQUENCY (MHz)	PPM (%)	FREQUENCY (MHz)	PPM (%)	FREQUENCY (MHz)	PPM (%)	FREQUENCY (MHz)	PPM (%)
138	3662.5218	5.9522	3662.525	6.8259	3662.5213	5.8157	3662.5238	6.4983
120	3662.5212	5.7884	3662.524	6.5529	3662.522	6.0068	3662.5247	6.7440
102	3662.5204	5.5700	3662.5246	6.7167	3662.5213	5.8157	3662.5251	6.8532

AFC FREQUENCY ERROR VS. TEMP								
TEMP (°C)	0Minutes		2Minutes		5Minutes		10Minutes	
	FREQUENCY (MHz)	PPM (%)	FREQUENCY (MHz)	PPM (%)	FREQUENCY (MHz)	PPM (%)	FREQUENCY (MHz)	PPM (%)
50	3662.4991	-0.2457	3662.4974	-0.7099	3662.5026	0.7099	3662.4982	-0.4915
40	3662.4982	-0.4915	3662.5011	0.3003	3662.4991	-0.2457	3662.4963	-1.0102
30	3662.4849	-4.1229	3662.4821	-4.8874	3662.4834	-4.5324	3662.4815	-5.0512
20	3662.5212	5.7884	3662.524	6.5529	3662.522	6.0068	3662.5247	6.7440
10	3662.4879	-3.3038	3662.4917	-2.2662	3662.4963	-1.0102	3662.4998	-0.0546
0	3662.4896	-2.8396	3662.4886	-3.1126	3662.4914	-2.3481	3662.4963	-1.0102
-10	3662.4855	-3.9590	3662.4907	-2.5392	3662.4912	-2.4027	3662.4956	-1.2014
-20	3662.4992	-0.2184	3662.4989	-0.3003	3662.4974	-0.7099	3662.4999	-0.0273
-30	3662.4968	-0.8737	3662.4996	-0.1092	3662.5045	1.2287	3662.5018	0.4915

### 4.3 EMISSION BANDWIDTH MEASUREMENT

#### 4.3.1 LIMITS OF EMISSION BANDWIDTH MEASUREMENT

According to FCC 90.1323 specified that emission bandwidth is defined as the width of the signal between two points, one below the carrier center frequency and one above the carrier center frequency, outside of which all emissions are attenuated at least 26dB below the transmitter power.

#### 4.3.2 TEST INSTRUMENTS

DESCRIPTION & MANUFACTURER	MODEL NO.	SERIAL NO.	DATE OF CALIBRATION	DUE DATE OF CALIBRATION
AGILENT SPECTRUM ANALYZER	E4446A	MY46180622	Apr. 25, 2011	Apr. 24, 2012
SUHNER RF cable	SUCOFLEX 104	222684/4	Jan. 26, 2012	Jan. 25, 2013
JFW 10dB attenuation	50HF-010-SMA	NA	NA	NA

**NOTE:**

1. The calibration interval of the above test instruments is 12 months and the calibrations are traceable to NML/ROC and NIST/USA.
2. Tested date: Apr. 17, 2012

#### 4.3.3 TEST PROCEDURE

The transmitter output was connected to the spectrum analyzer through an attenuator. The bandwidth of the fundamental frequency was measured by spectrum analyzer with RBW = 51kHz (5MHz bandwidth), 100kHz (10MHz bandwidth), VBW = 150kHz (5MHz bandwidth), 300kHz (10MHz bandwidth). The emission bandwidth is defined as the width of the signal between two points, one below the carrier center frequency and one above the carrier center frequency, outside of which all emissions are attenuated at least 26 dB below the transmitter power.

#### 4.3.4 TEST SETUP

Same as 4.1.4

#### 4.3.5 EUT OPERATING CONDITIONS

Same as 4.1.5



### 4.3.6 TEST RESULTS

#### CHANNEL BANDWIDTH: 5MHz QPSK 1/2

CHANNEL	-26dBc BANDWIDTH (MHz)	
	CHAIN 0	CHAIN 1
Low	5.49	5.51
Middle	5.28	5.34
High	5.39	5.36

#### QPSK 3/4

CHANNEL	-26dBc BANDWIDTH (MHz)	
	CHAIN 0	CHAIN 1
Low	5.36	5.44
Middle	5.21	5.23
High	5.23	5.25

#### 16QAM 1/2

CHANNEL	-26dBc BANDWIDTH (MHz)	
	CHAIN 0	CHAIN 1
Low	5.25	5.39
Middle	5.24	5.28
High	5.28	5.27

#### 16QAM 3/4

CHANNEL	-26dBc BANDWIDTH (MHz)	
	CHAIN 0	CHAIN 1
Low	5.34	5.43
Middle	5.21	5.26
High	5.32	5.23



A D T

### CHAIN 0 LOW CHANNEL

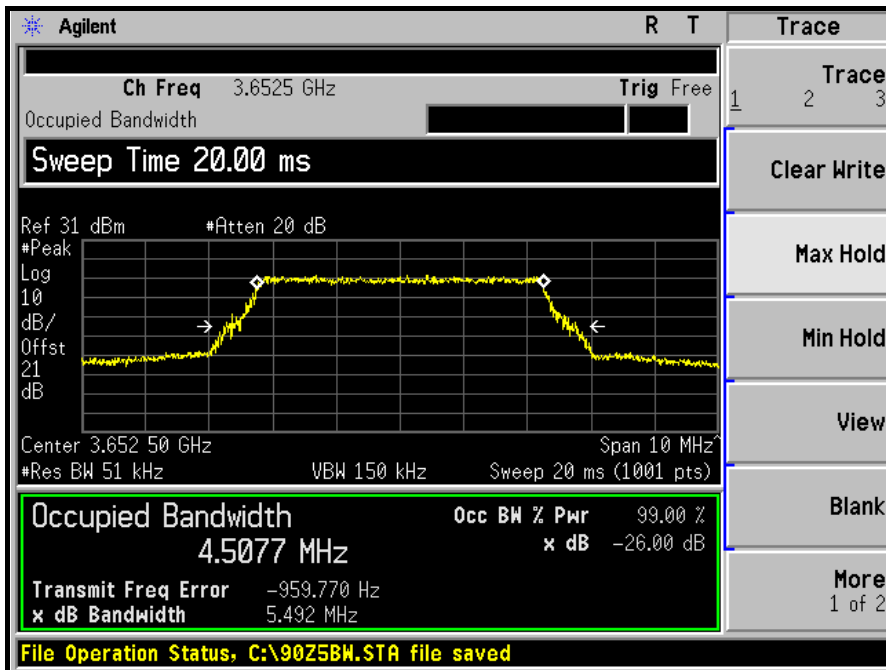

### MIDDLE CHANNEL

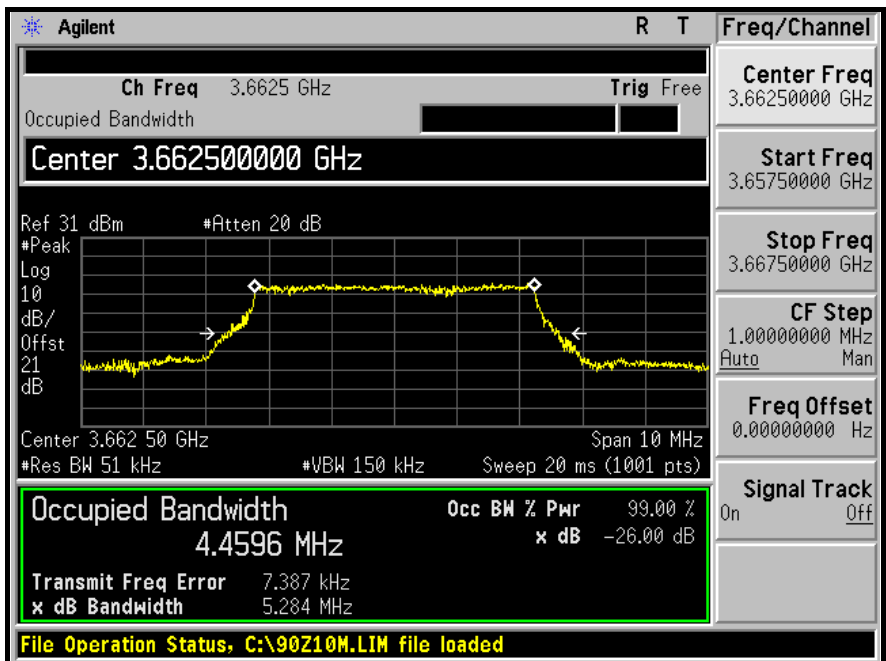





A D T

### HIGH CHANNEL

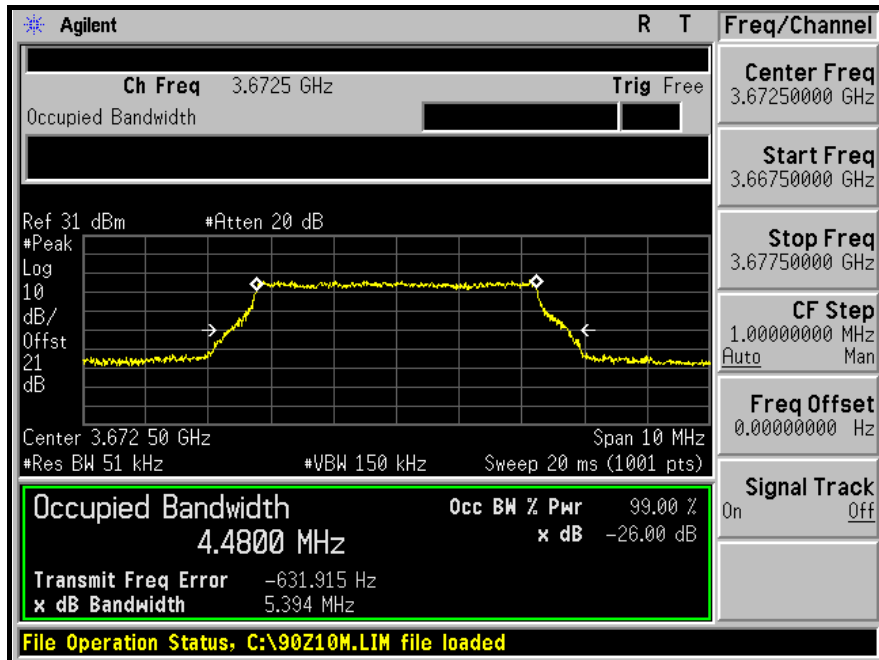



A D T

### CHAIN 1 LOW CHANNEL

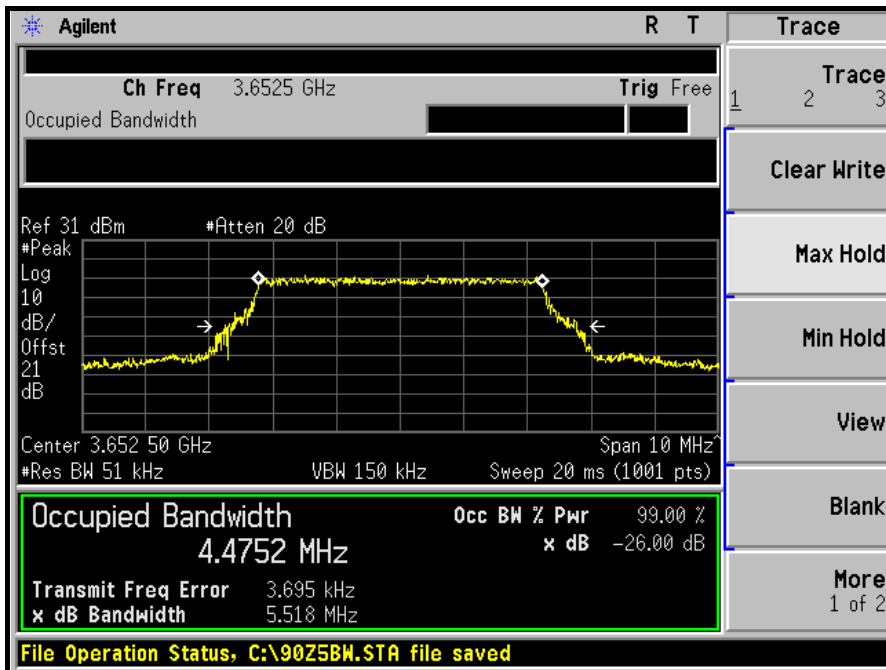

### MIDDLE CHANNEL

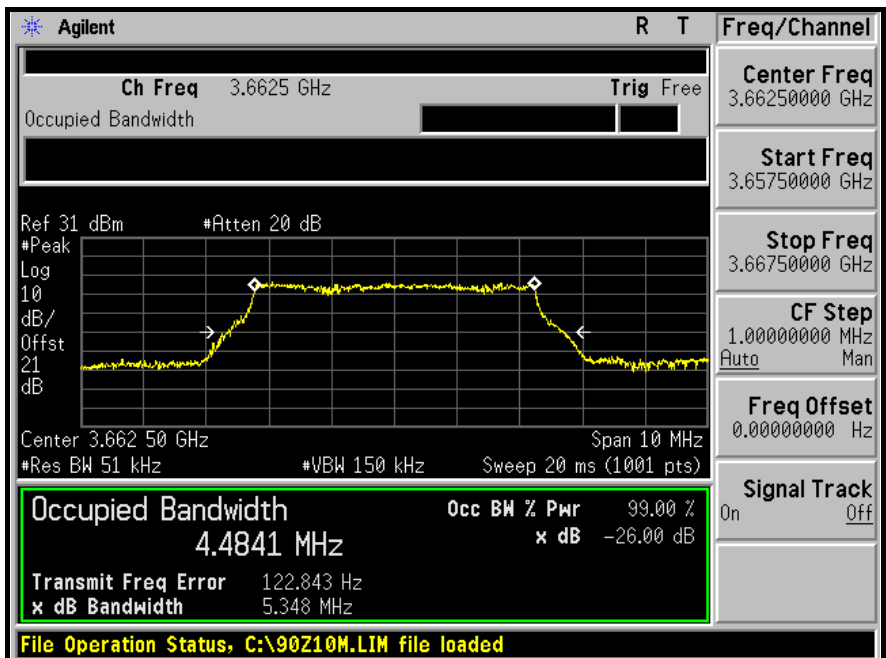



A D T

### HIGH CHANNEL

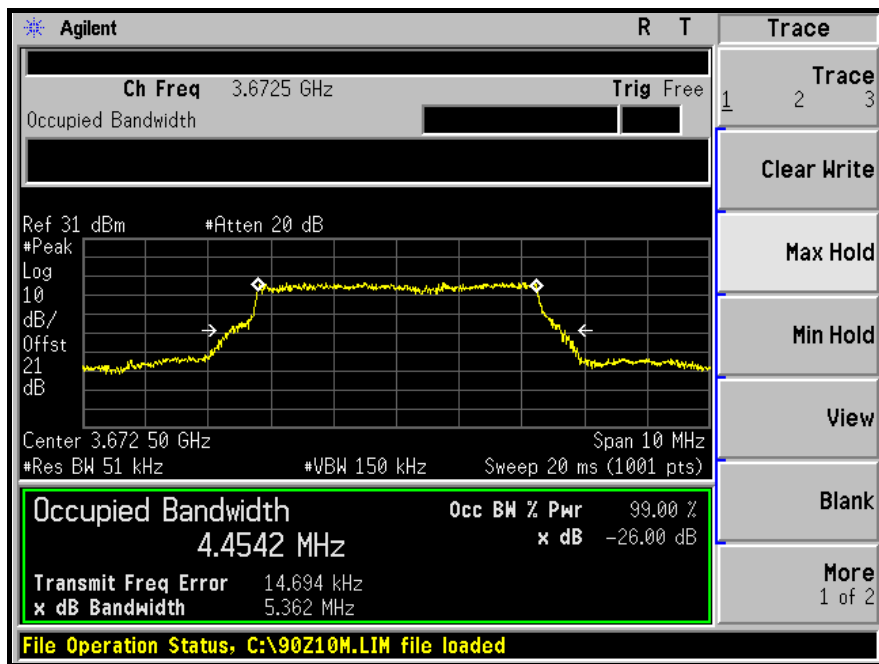



A D T

**CHANNEL BANDWIDTH: 10MHz**

**QPSK 1/2**

CHANNEL	-26dBc BANDWIDTH (MHz)	
	CHAIN 0	CHAIN 1
Low	10.25	10.35
Middle	10.32	10.33
High	10.22	10.31

**QPSK 3/4**

CHANNEL	-26dBc BANDWIDTH (MHz)	
	CHAIN 0	CHAIN 1
Low	10.16	10.26
Middle	10.25	10.28
High	10.17	10.24

**16QAM 1/2**

CHANNEL	-26dBc BANDWIDTH (MHz)	
	CHAIN 0	CHAIN 1
Low	10.21	10.24
Middle	10.26	10.26
High	10.14	10.26

**16QAM 3/4**

CHANNEL	-26dBc BANDWIDTH (MHz)	
	CHAIN 0	CHAIN 1
Low	10.16	10.20
Middle	10.25	10.27
High	10.16	10.25



A D T

### CHAIN 0 LOW CHANNEL

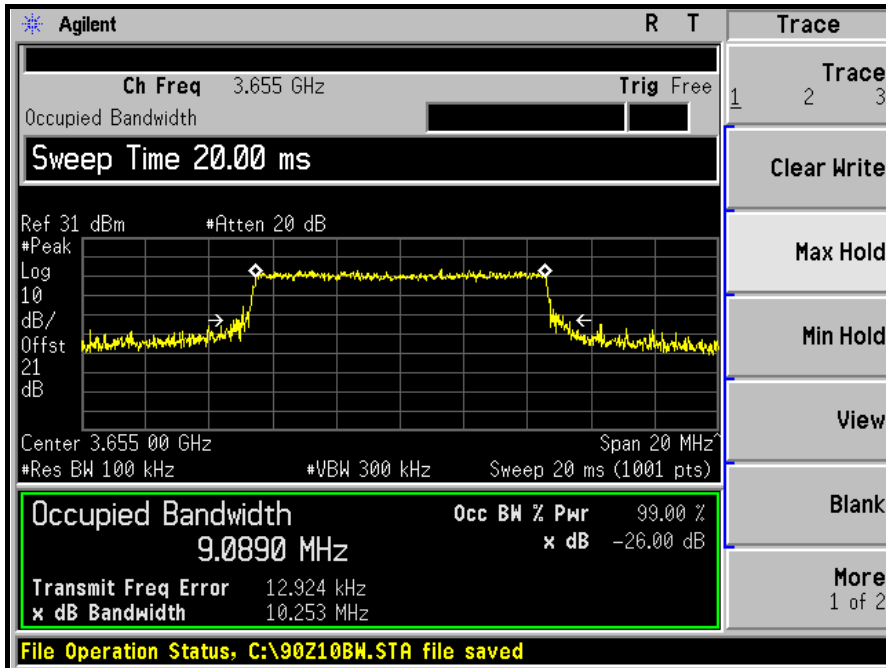

### MIDDLE CHANNEL

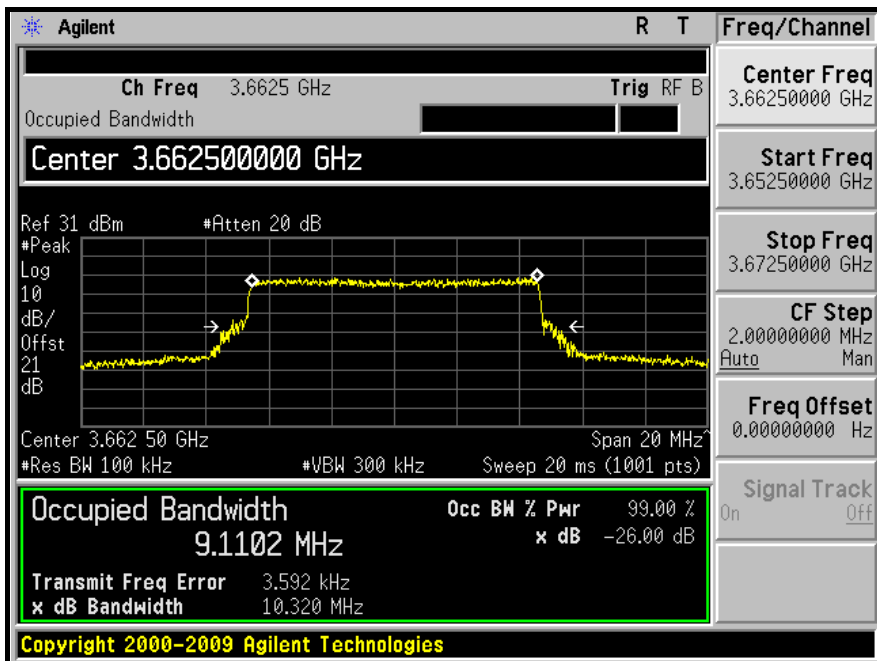



A D T

### HIGH CHANNEL

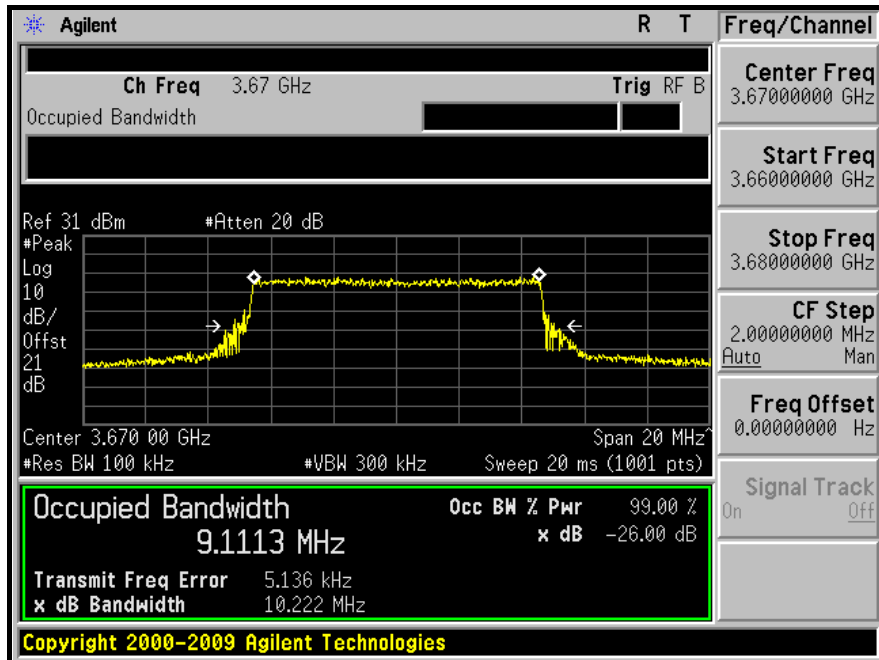



A D T

### CHAIN 1 LOW CHANNEL

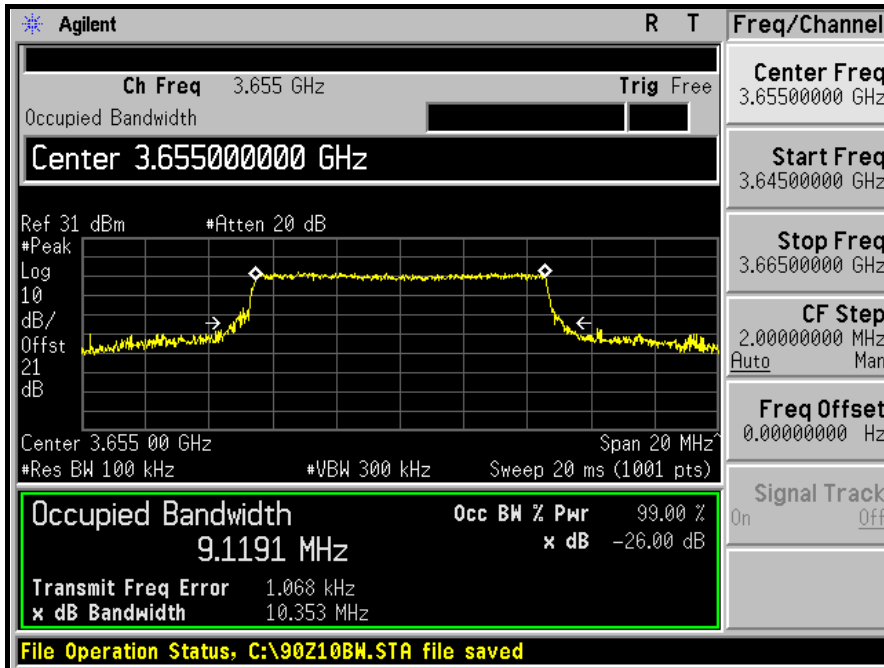

### MIDDLE CHANNEL

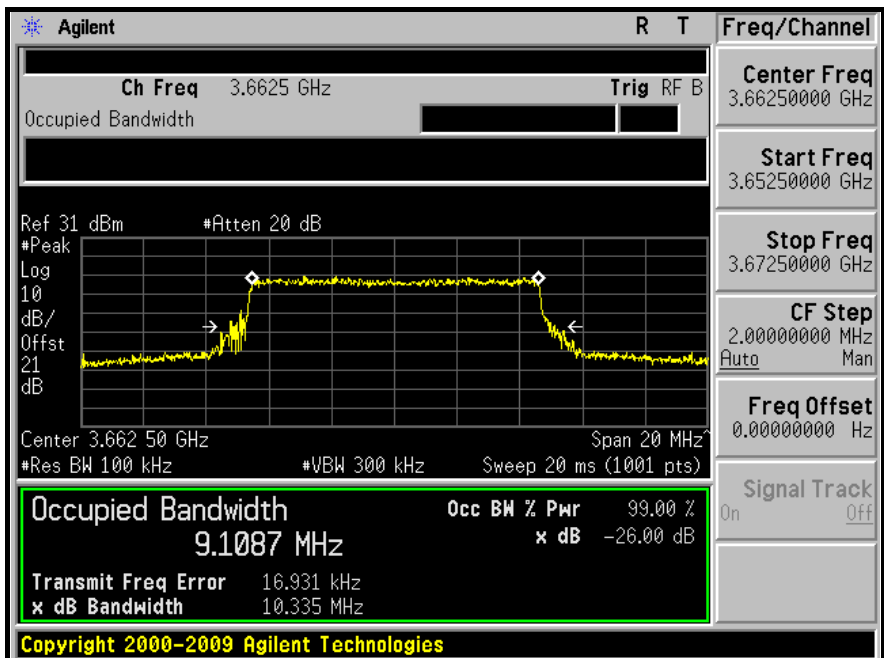



A D T

### HIGH CHANNEL

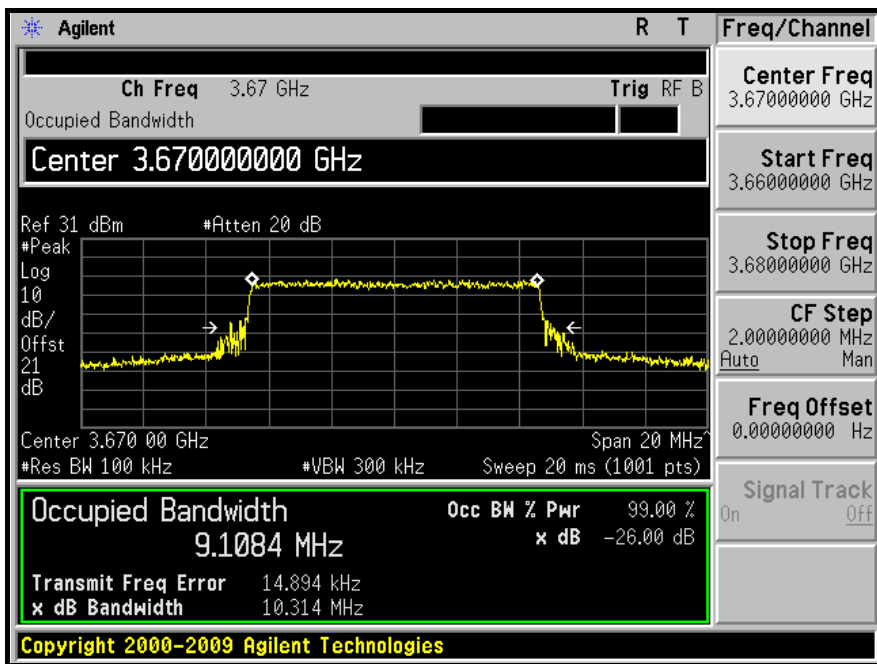



## 4.4 EMISSION MASKS

### 4.4.1 LIMITS OF EMISSION MASKS

For transmitters that are equipped with an audio low-pass filter, the power of any emission must be attenuated below the unmodulated carrier power (P) as follows:

- (1) On any frequency removed from the assigned frequency by more than 50 percent, but not more than 100 percent of the authorized bandwidth: At least 25 dB.
- (2) On any frequency removed from the assigned frequency by more than 100 percent, but not more than 250 percent of the authorized bandwidth: At least 35 dB.
- (3) On any frequency removed from the assigned frequency by more than 250 percent of the authorized bandwidth: At least  $43 + 10\log (P)$  dB.

### 4.4.2 TEST INSTRUMENTS

DESCRIPTION & MANUFACTURER	MODEL NO.	SERIAL NO.	DATE OF CALIBRATION	DUE DATE OF CALIBRATION
AGILENT SPECTRUM ANALYZER	E4446A	MY46180622	Apr. 25, 2011	Apr. 24, 2012
SUHNER RF cable	SUCOFLEX 104	222684/4	Jan. 26, 2012	Jan. 25, 2013
JFW 10dB attenuation	50HF-010-SMA	NA	NA	NA

**NOTE:**

1. The calibration interval of the above test instruments is 12 months and the calibrations are traceable to NML/ROC and NIST/USA.
2. Tested date: Apr. 17, 2012

### 4.4.3 TEST SETUP

Same as 4.1.4

#### 4.4.4 TEST PROCEDURES

- a. The bandwidth of the fundamental frequency was measured by spectrum analyzer with RBW = 51kHz (5MHz bandwidth), 100kHz (10MHz bandwidth), VBW = 150kHz (5MHz bandwidth), 300kHz (10MHz bandwidth).
- b. Set EUT to transmit signal at un-modulation mode to get reference level,  $R_L$ .
- c. According  $R_L$  and Channel bandwidth to define Emission Mask range.
- d. Set EUT to transmit signal at modulation mode to check signal can comply with Emission Mask or not.

#### 4.4.5 EUT OPERATING CONDITION

Same as 4.1.5



A D T

#### 4.4.6 TEST RESULTS

**CHANNEL BANDWIDTH: 5MHz**

**CHAIN 0**

**LOW CHANNEL**

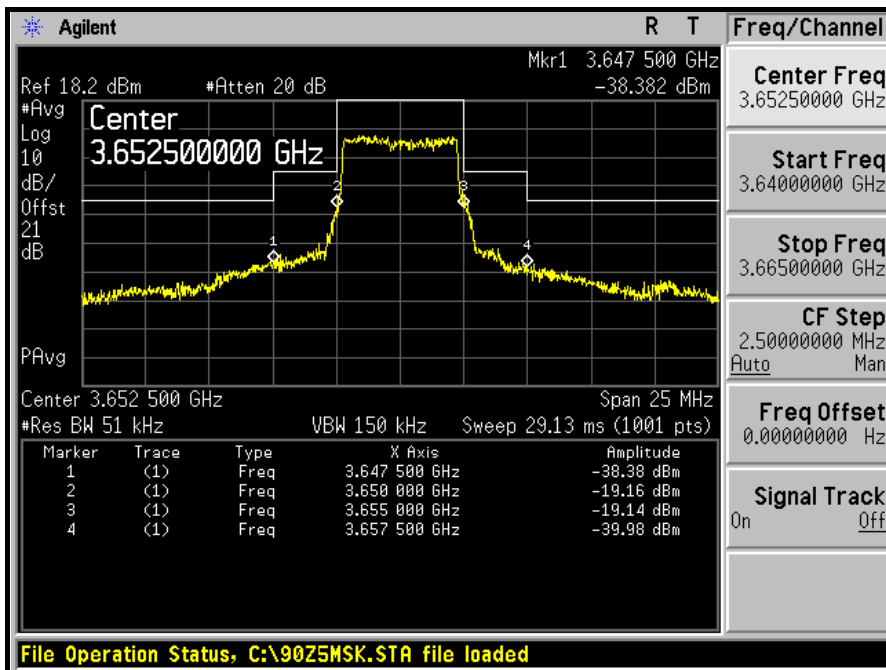
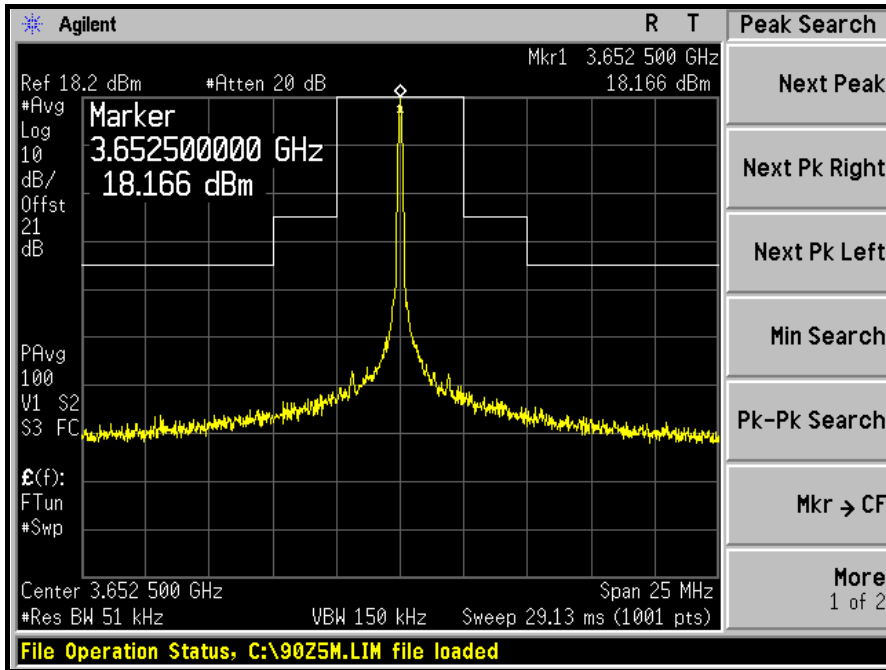



A D T

MIDDLE CHANNEL

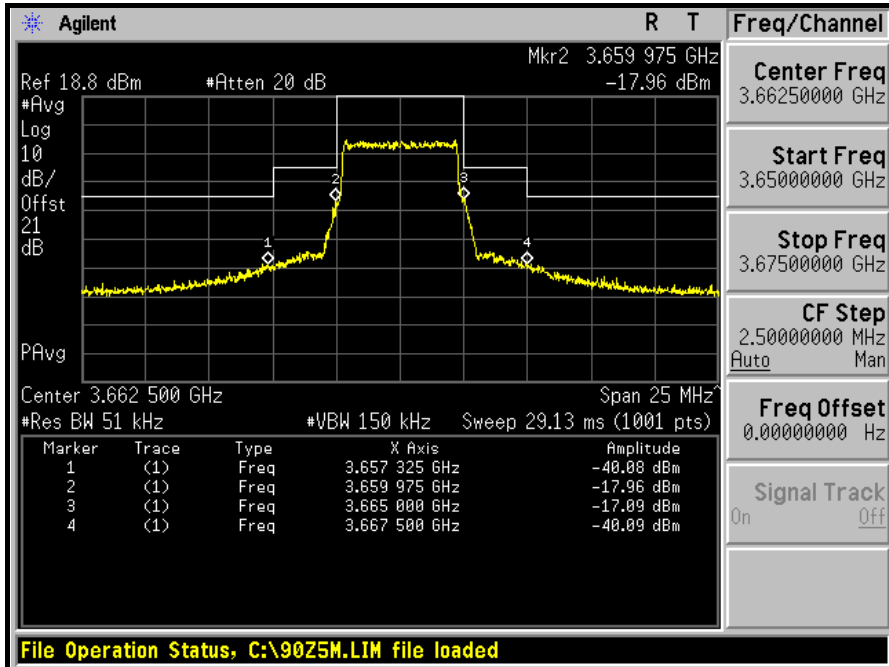
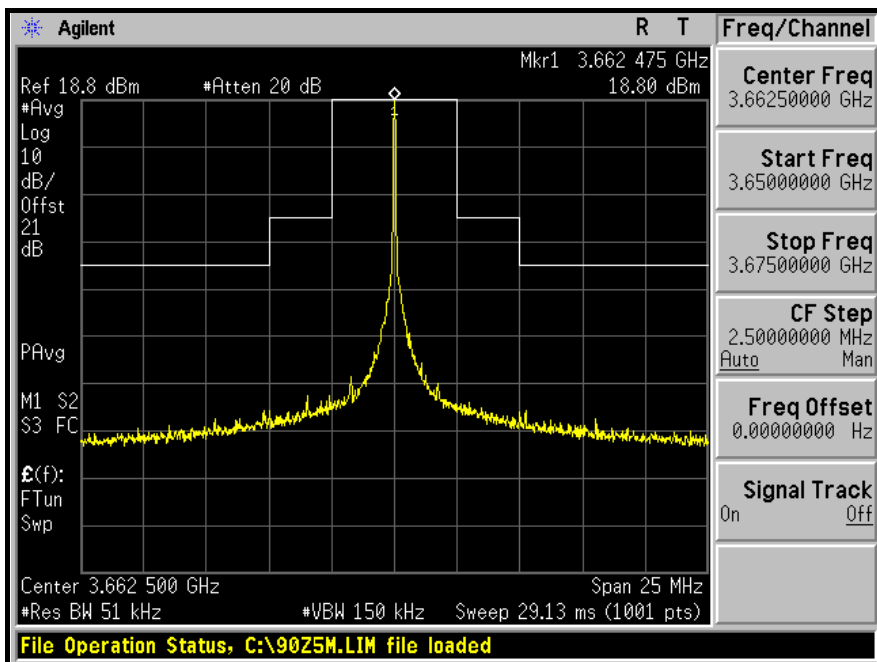



A D T

### HIGH CHANNEL

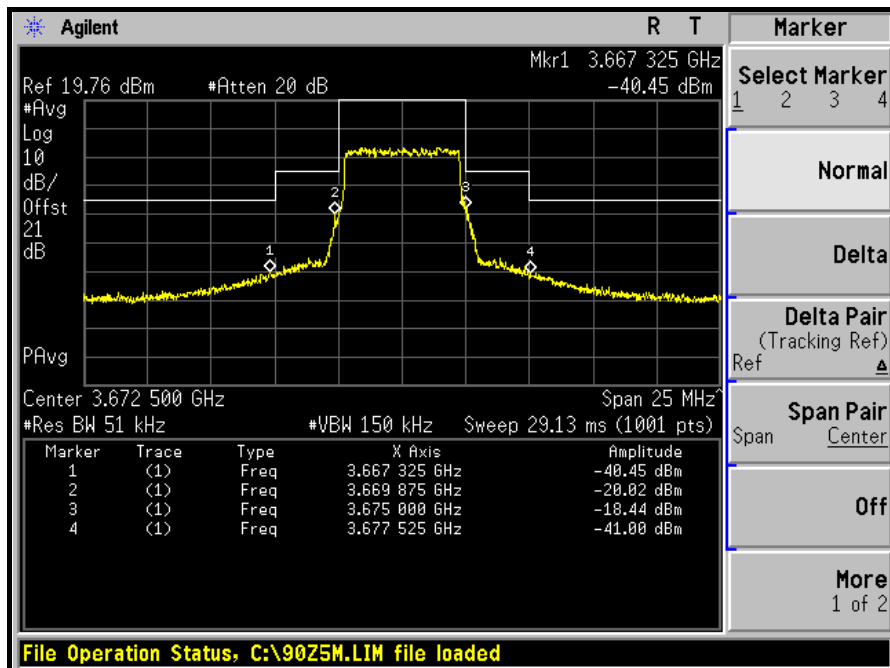
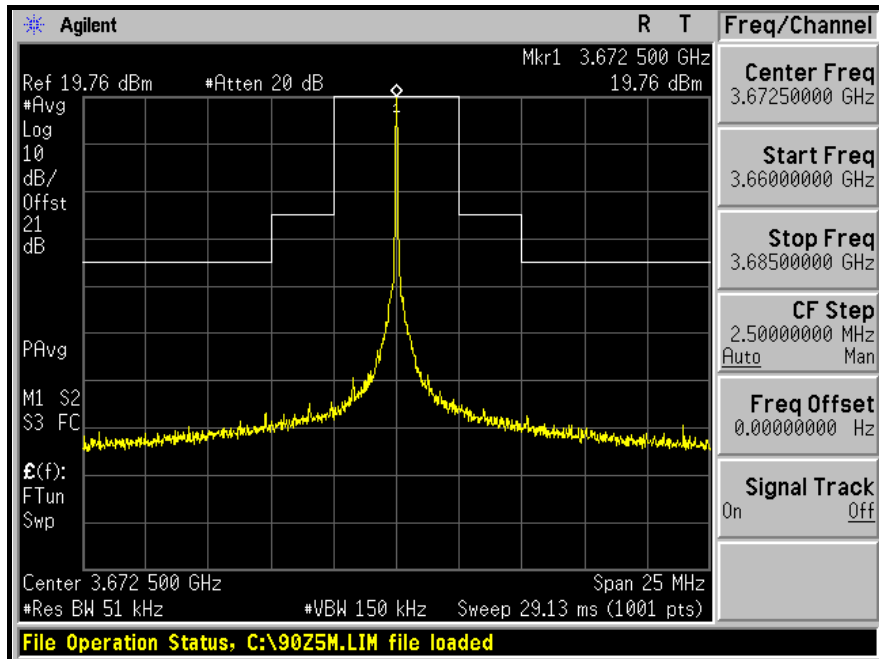



A D T

**CHAIN 1**  
**LOW CHANNEL**

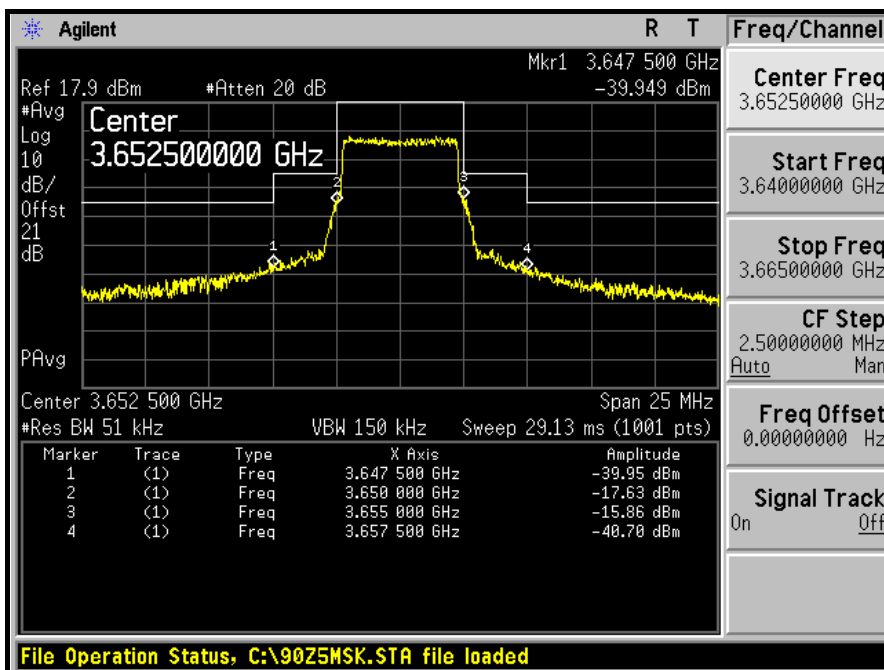
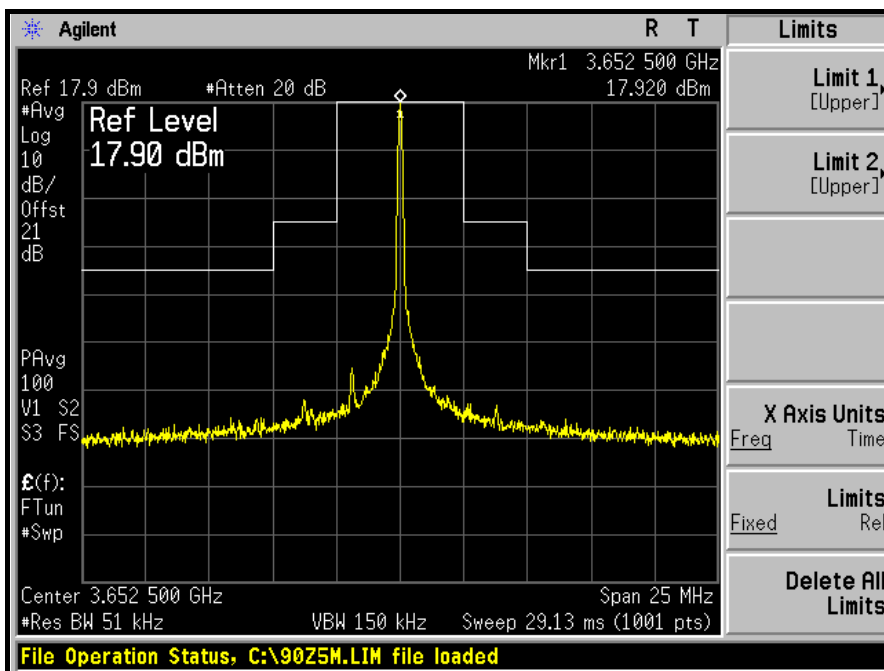



A D T

MIDDLE CHANNEL

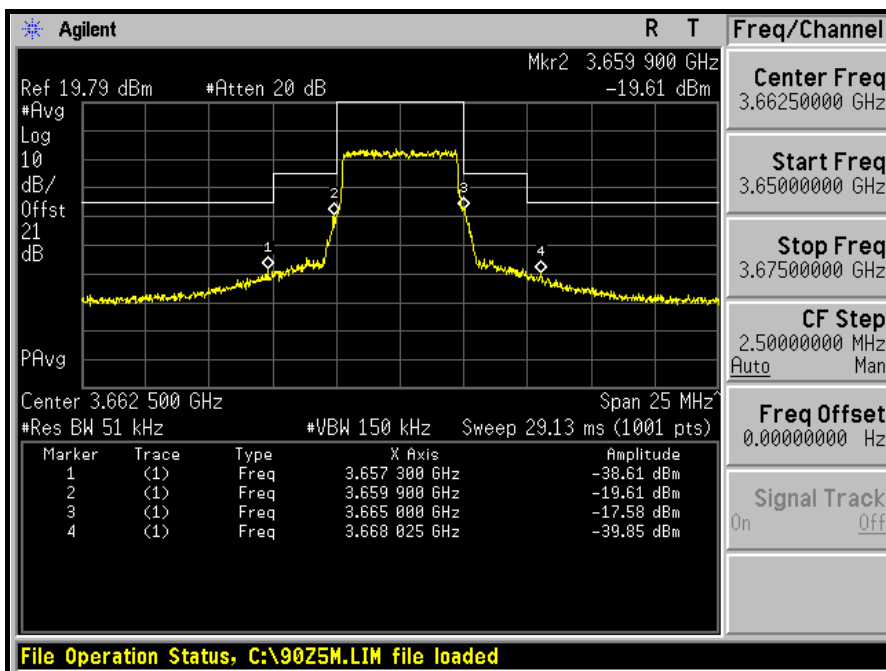
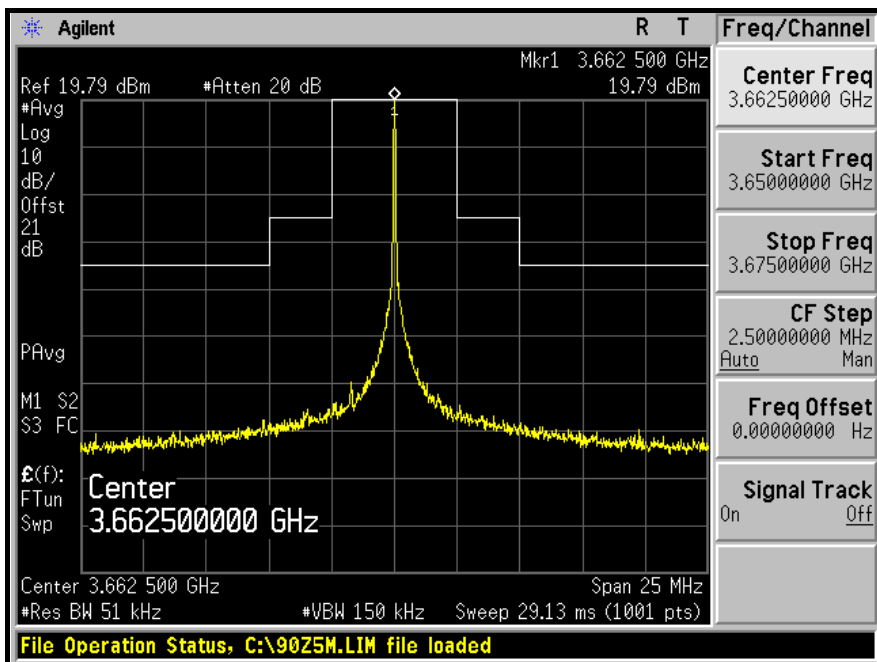



A D T

### HIGH CHANNEL

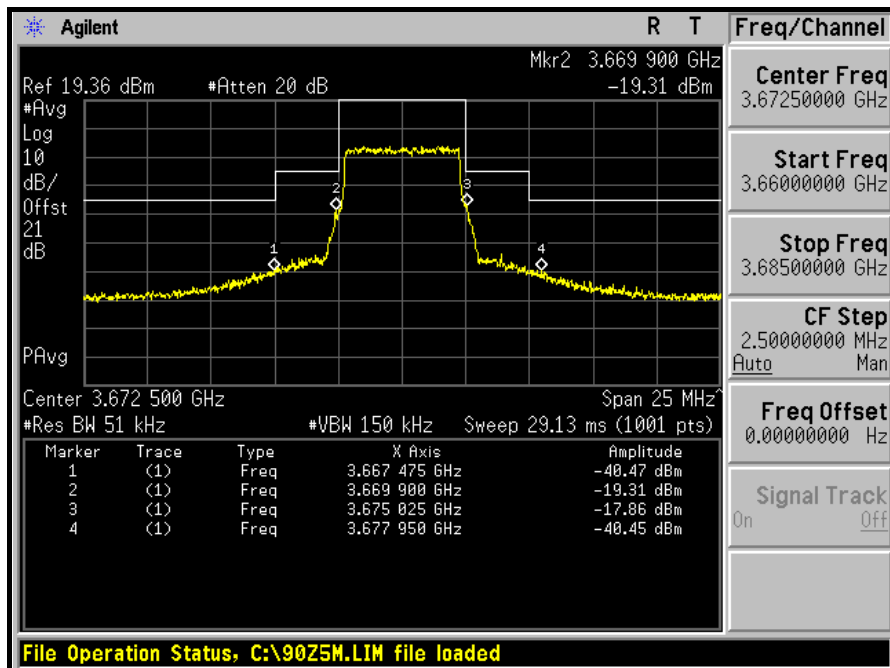
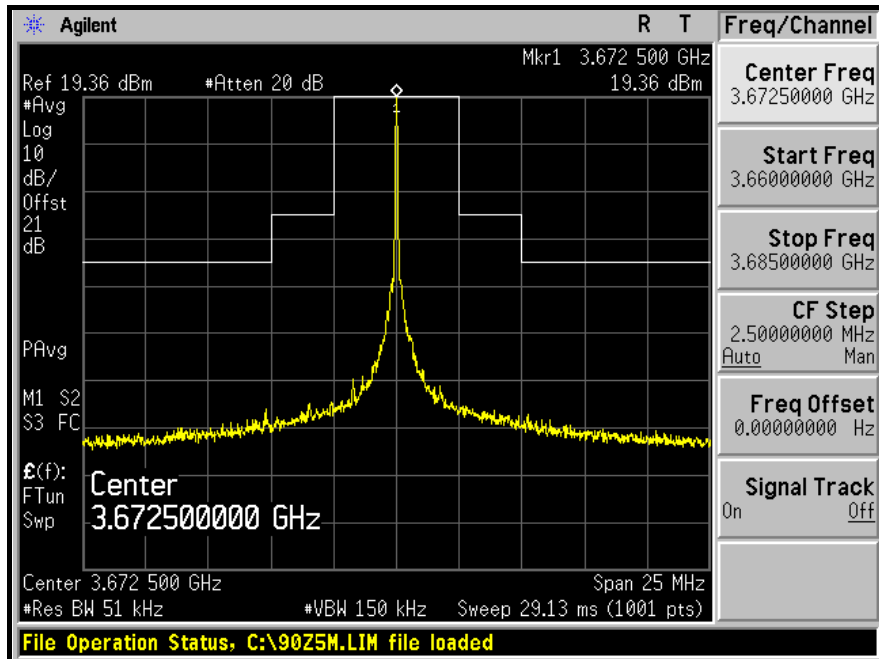





A D T

**CHANNEL BANDWIDTH: 10MHz**

**CHAIN 0**

**LOW CHANNEL**

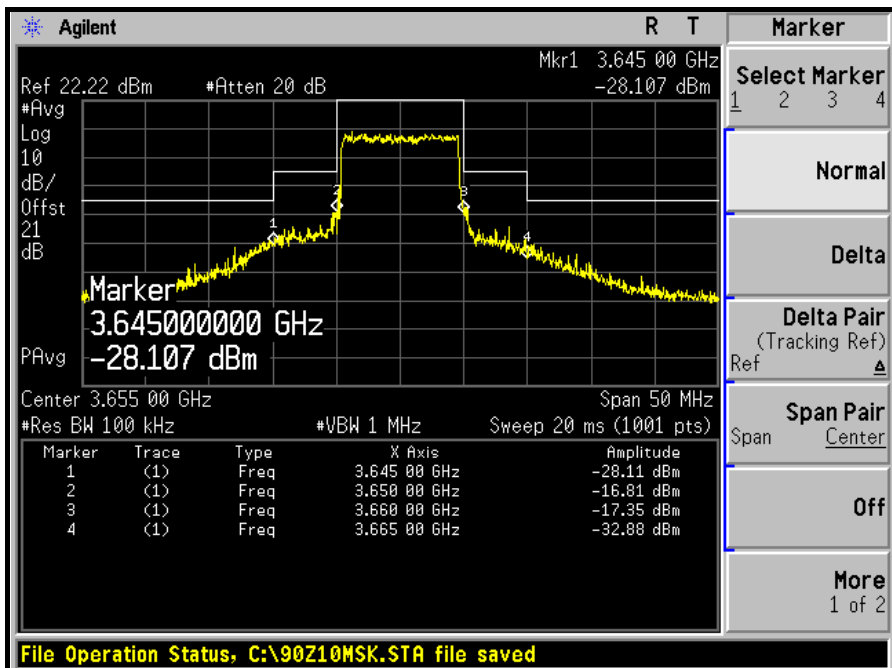
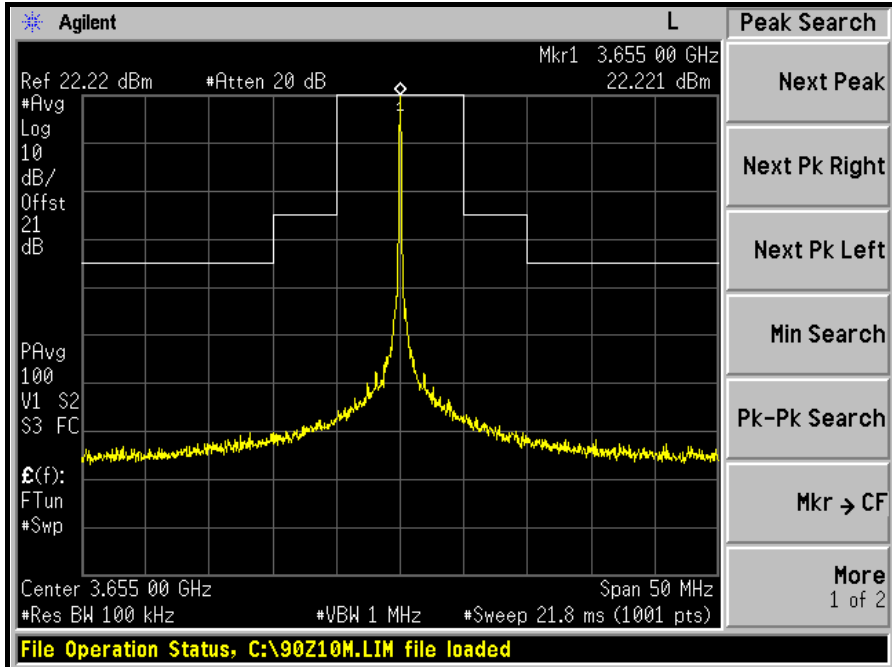



A D T

MIDDLE CHANNEL

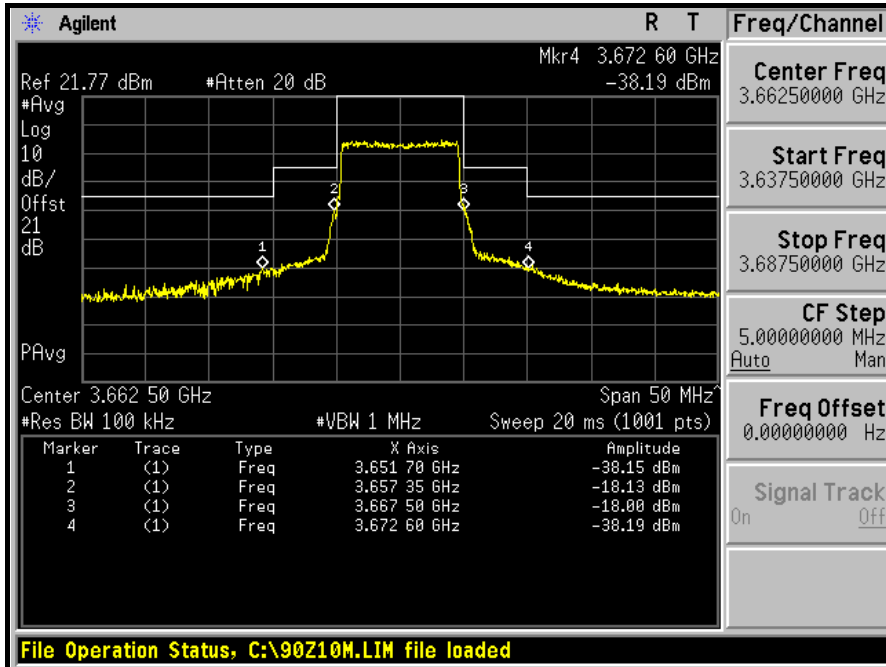
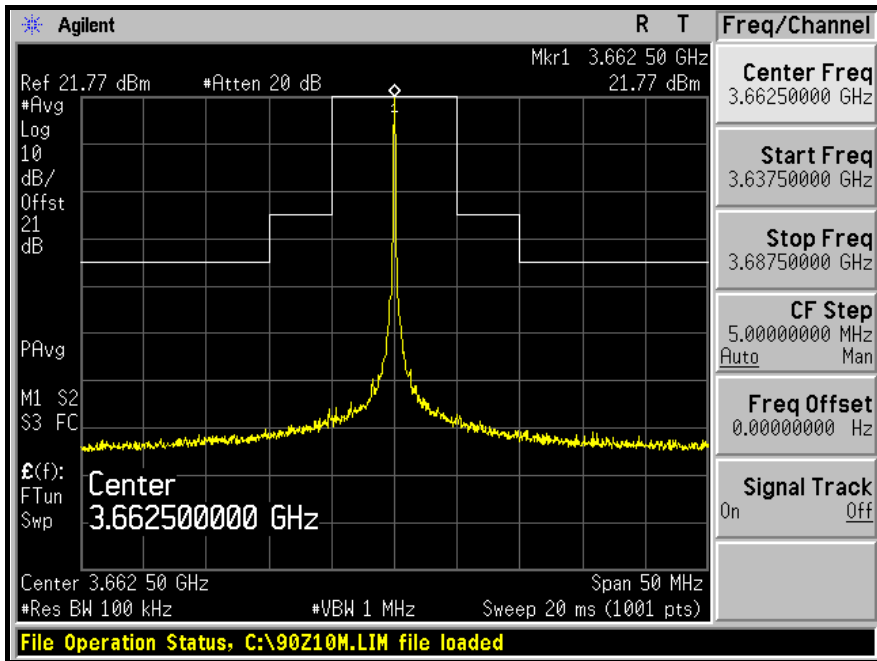



A D T

### HIGH CHANNEL

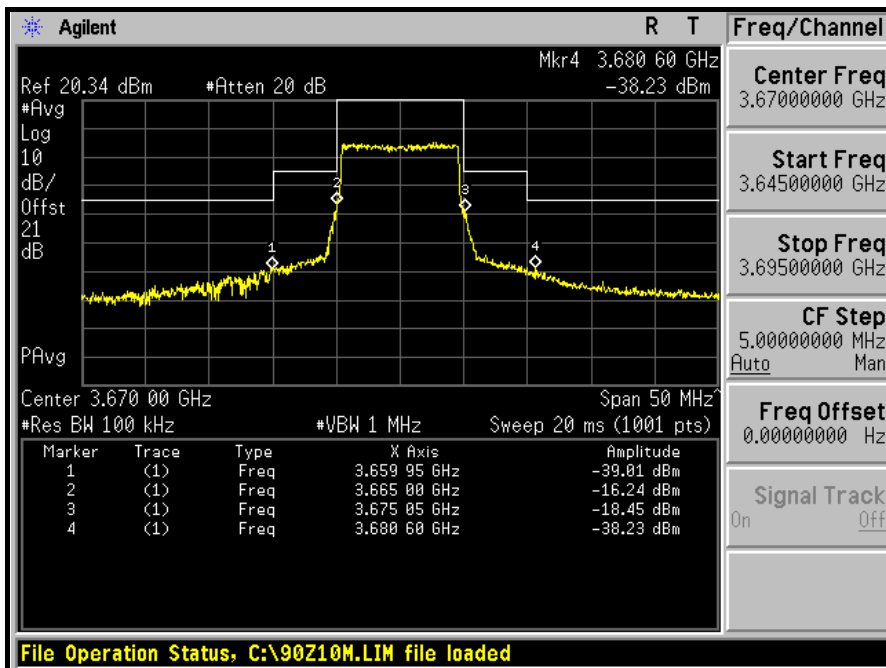
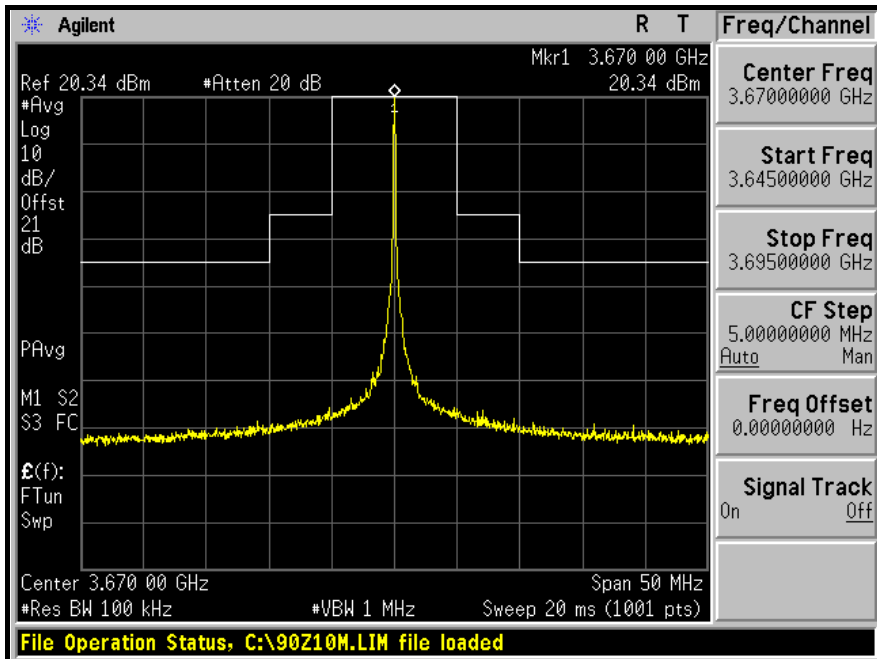



A D T

**CHAIN 1**  
**LOW CHANNEL**

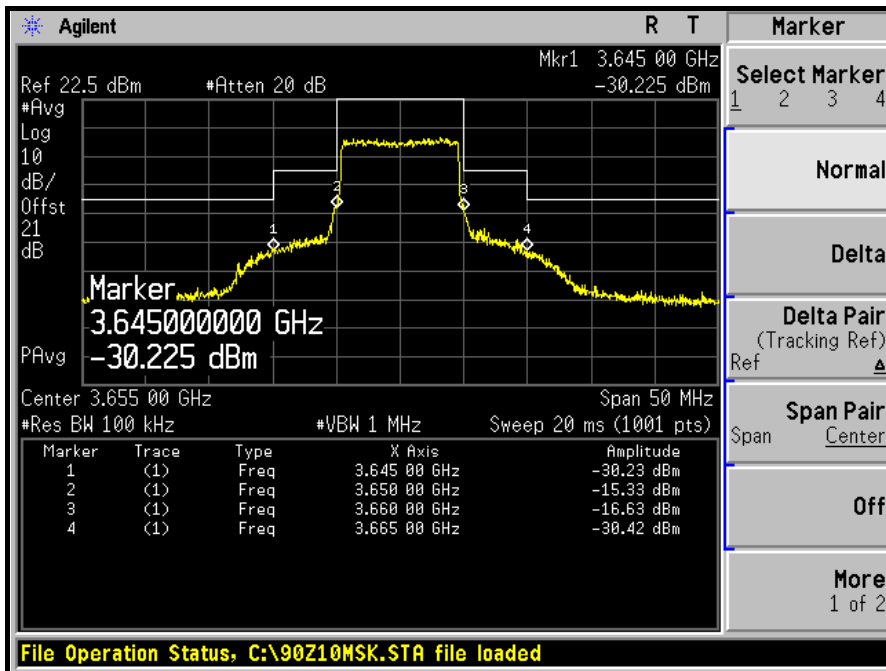
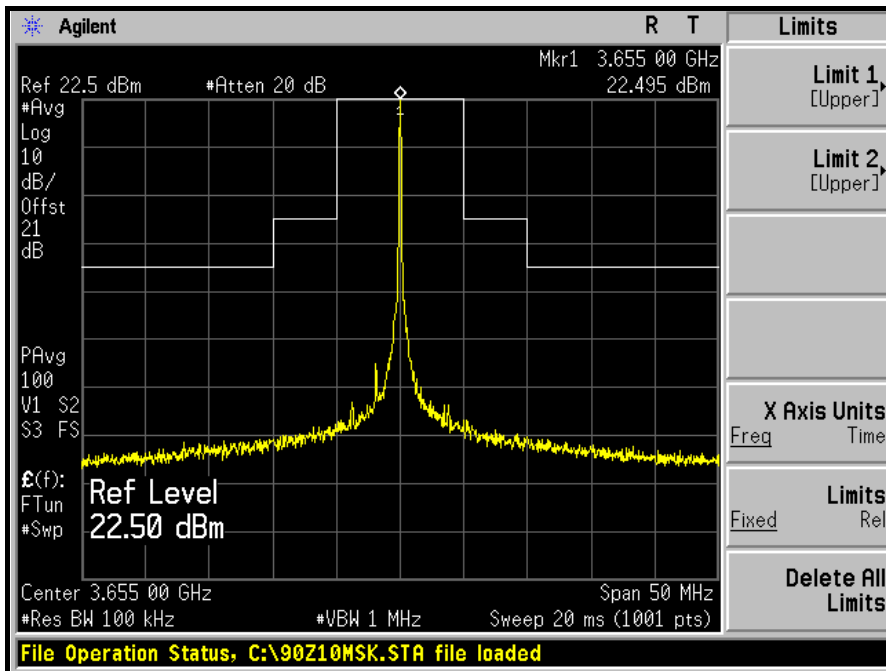



A D T

### MIDDLE CHANNEL

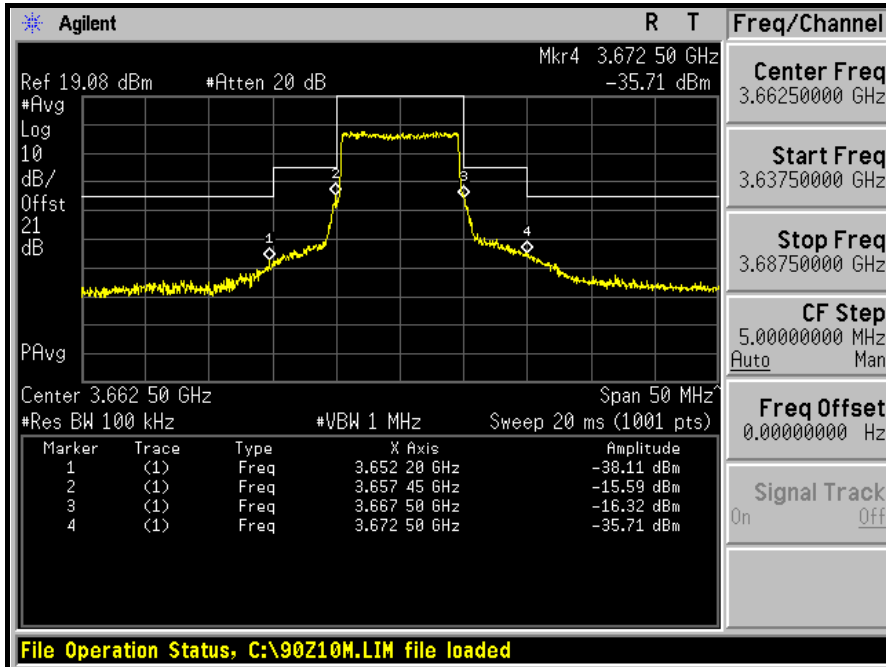
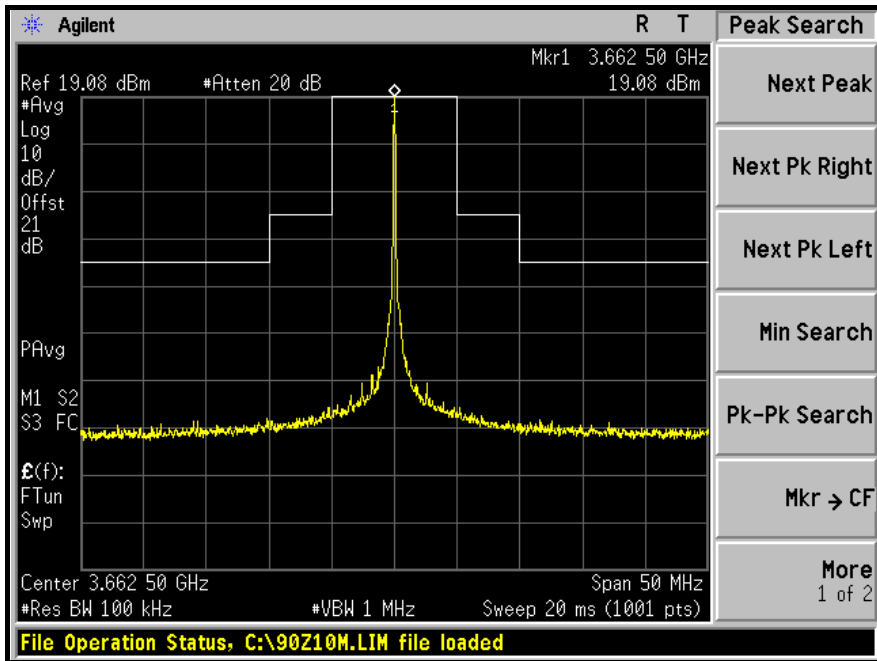



A D T

### HIGH CHANNEL

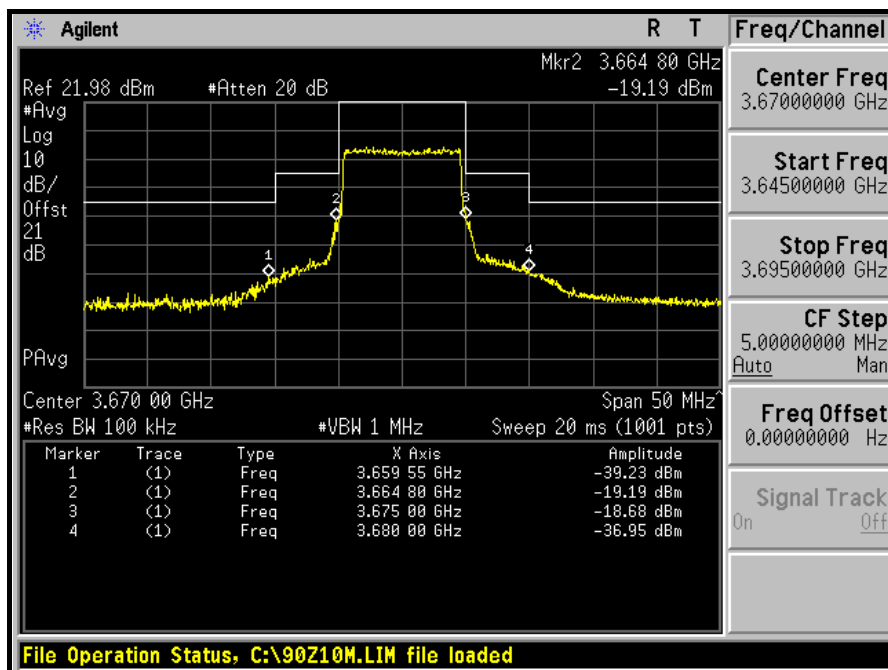
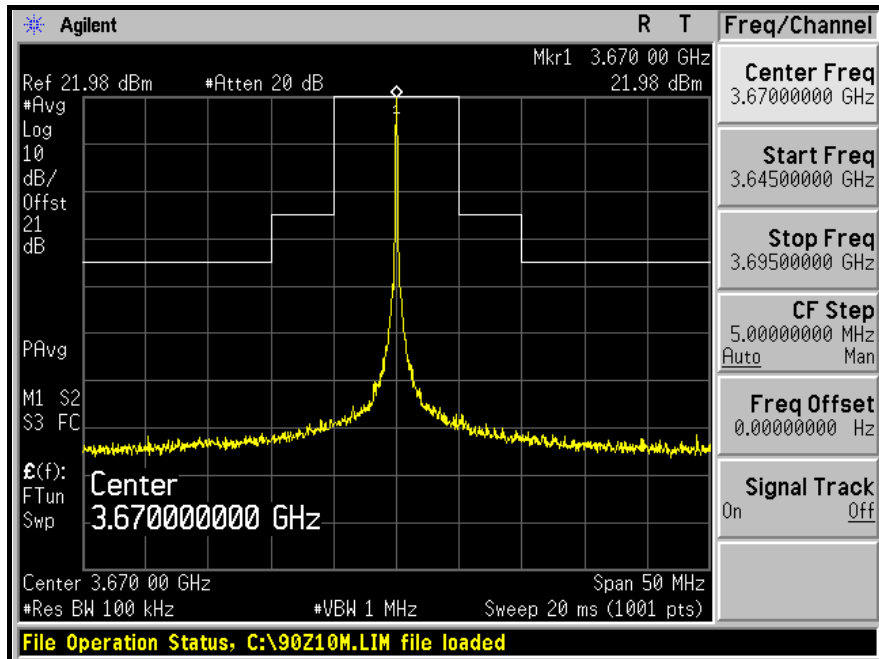



## 4.5 CONDUCTED SPURIOUS EMISSIONS

### 4.5.1 LIMITS OF CONDUCTED SPURIOUS EMISSIONS MEASUREMENT

According to FCC 90.1323 specified that the power of any emission outside a licensee's frequency band(s) of operation shall be attenuated below the transmitter power (P) within the licensed band(s) of operation, measured in Watts, by at least  $43 + 10 \log (P)$  dB. The limit of emission equal to  $-13\text{dBm}$  Compliance with this provision is based on the use of measurement instrumentation employing a resolution bandwidth of 1 MHz or less, but at least one percent of the emission bandwidth of the fundamental emission of the transmitter, provided the measured energy is integrated over a 1 MHz bandwidth

### 4.5.2 TEST INSTRUMENTS

DESCRIPTION & MANUFACTURER	MODEL NO.	SERIAL NO.	DATE OF CALIBRATION	DUE DATE OF CALIBRATION
AGILENT SPECTRUM ANALYZER	E4446A	MY46180622	Apr. 25, 2011	Apr. 24, 2012
SUHNER RF cable	SUCOFLEX 104	222684/4	Jan. 26, 2012	Jan. 25, 2013
JFW 10dB attenuation	50HF-010-SMA	NA	NA	NA

**NOTE:**

1. The calibration interval of the above test instruments is 12 months and the calibrations are traceable to NML/ROC and NIST/USA.
2. Tested date: Apr. 17, 2012

#### 4.5.3 TEST PROCEDURE

- a. All measurements were done at 3 channels: low, middle and high operational frequency range.
- b. When the spectrum scanned from 30MHz to 5GHz, it shall be connected to the 10dB pad attenuated the carried frequency. The spectrum set RB = 1MHz, VB = 3MHz.
- c. When the spectrum scanned from 5GHz to 40GHz, it shall be connected to the high pass filter attenuated the carried frequency. The spectrum set RB = 1MHz, VB = 3MHz.

#### 4.5.4 TEST SETUP

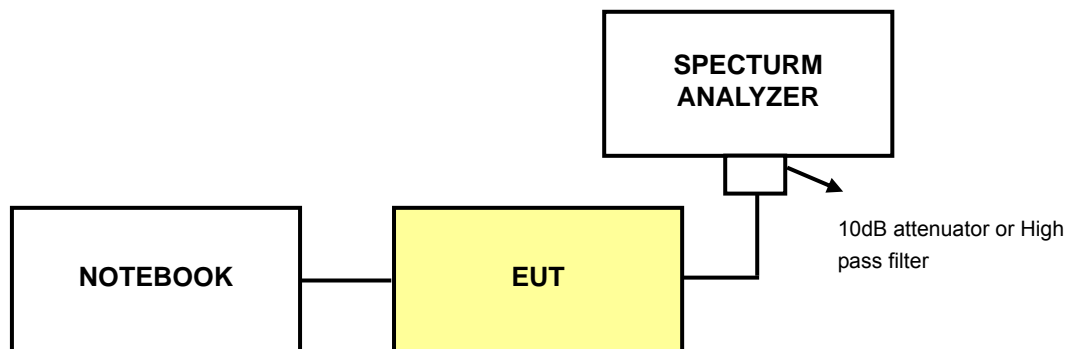

#### 4.5.5 EUT OPERATING CONDITIONS

Same as 4.1.5





A D T

## 4.5.6 TEST RESULTS

### CHANNEL BANDWIDTH: 5MHz

LOW CHANNEL: 30MHz ~ 1GHz:

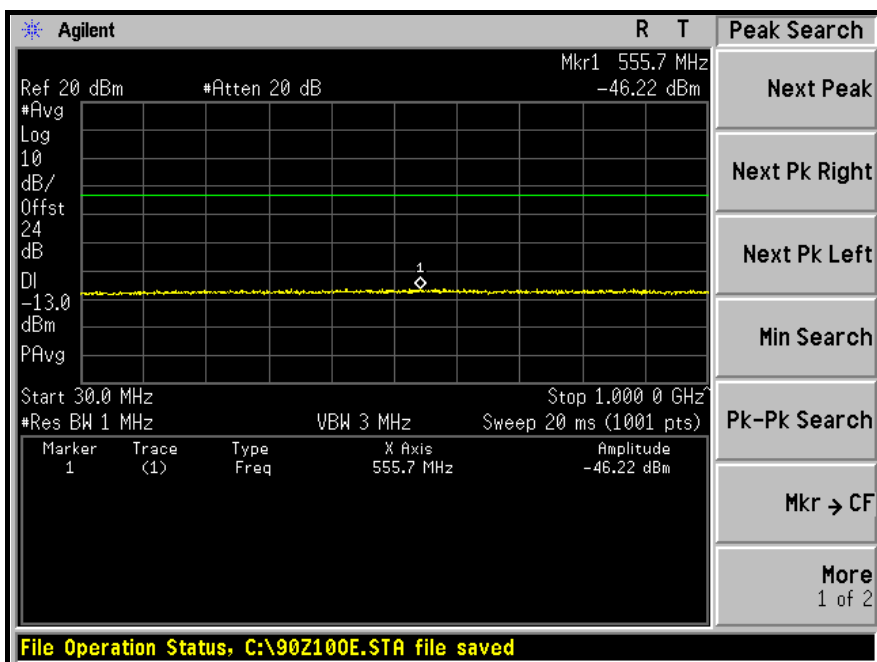

1GHz ~ 5GHz:

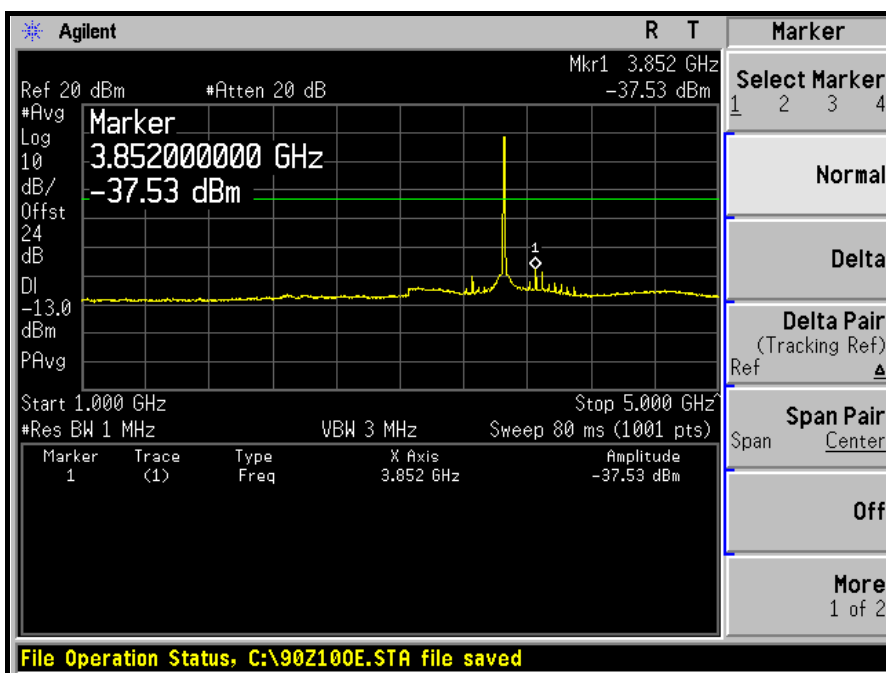



A D T

5GHz ~ 10GHz:

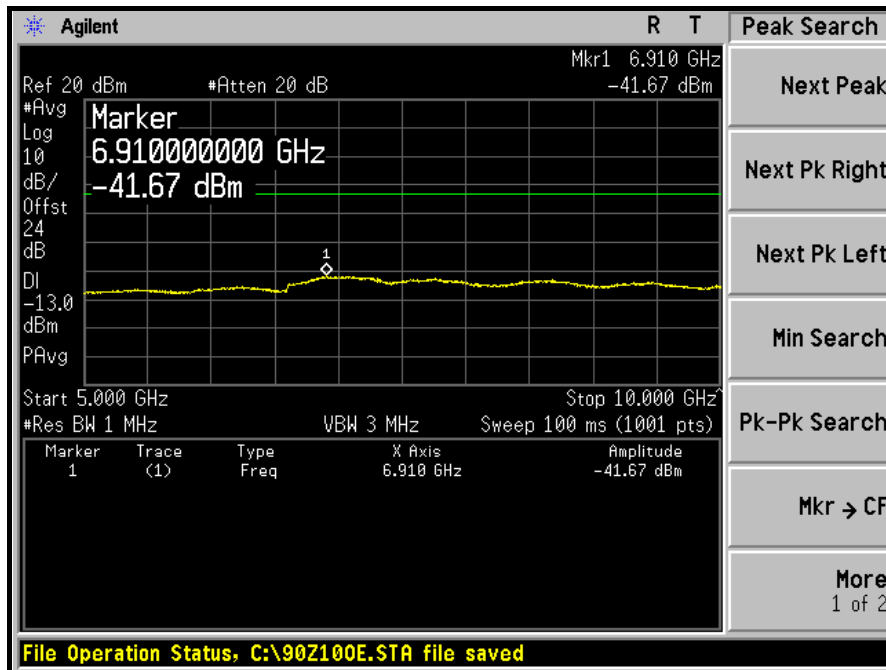

10GHz ~ 20GHz:

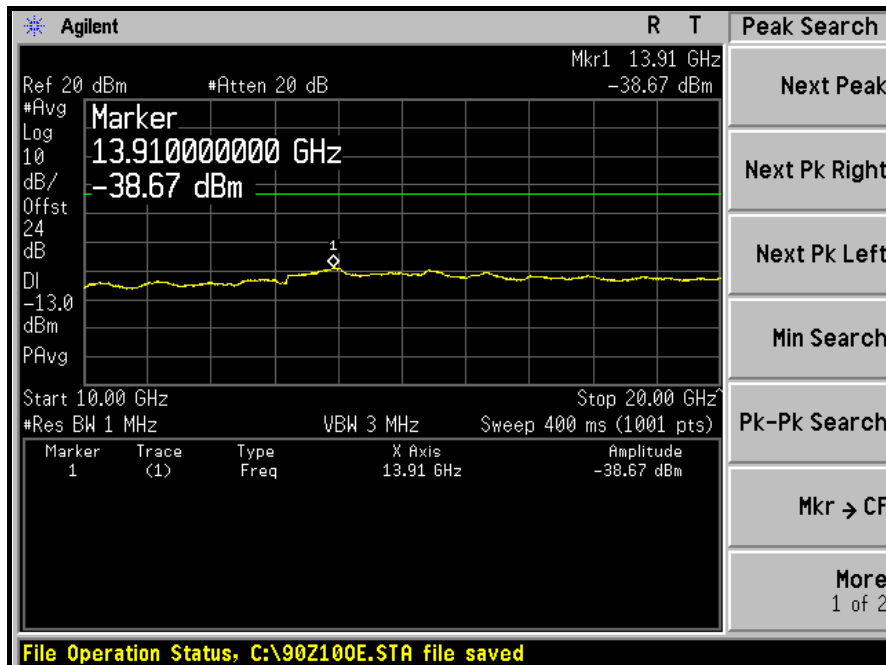



A D T

20GHz ~ 30GHz:

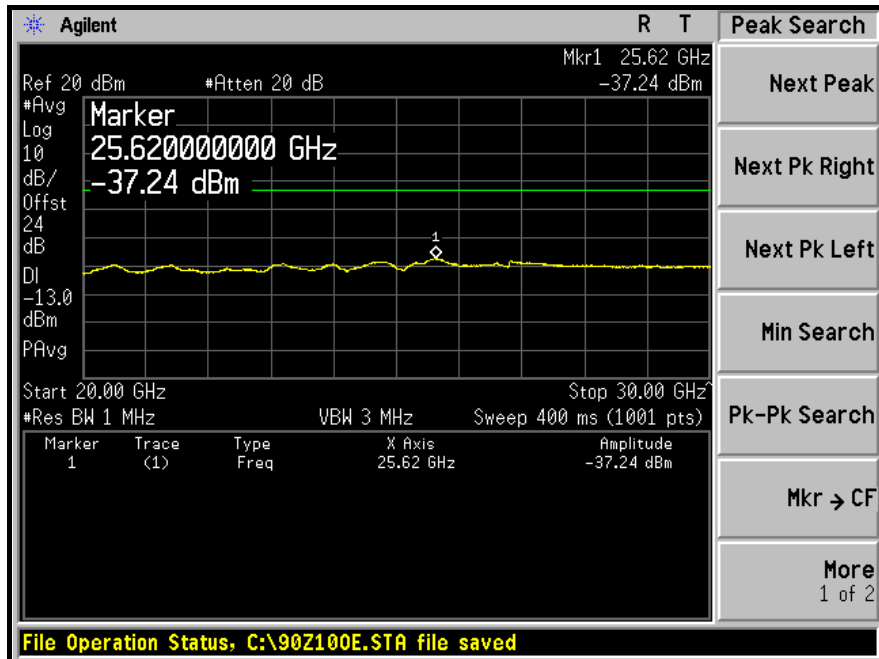

30GHz ~ 40GHz:

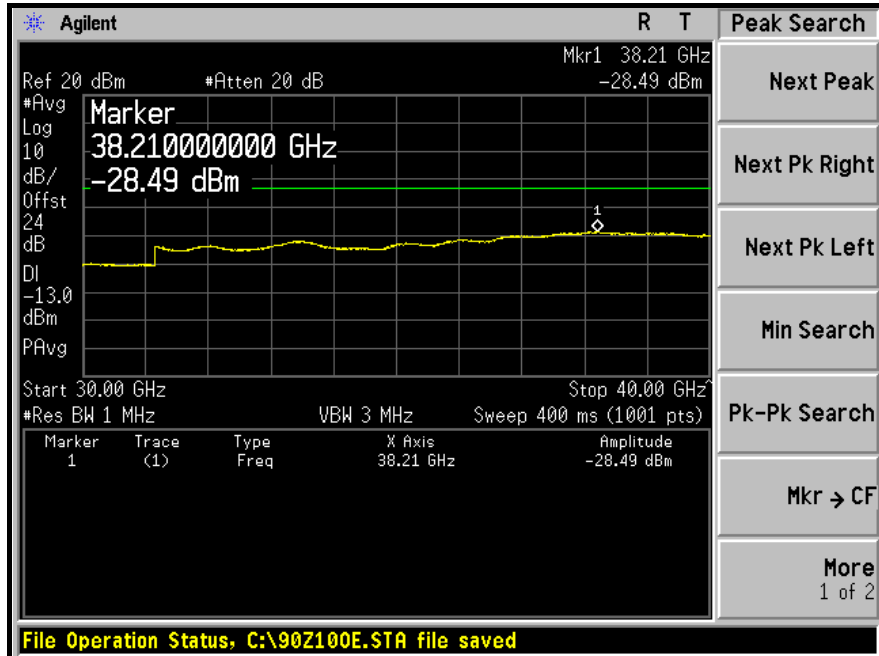



A D T

### MIDDLE CHANNEL: 30MHz ~ 1GHz:

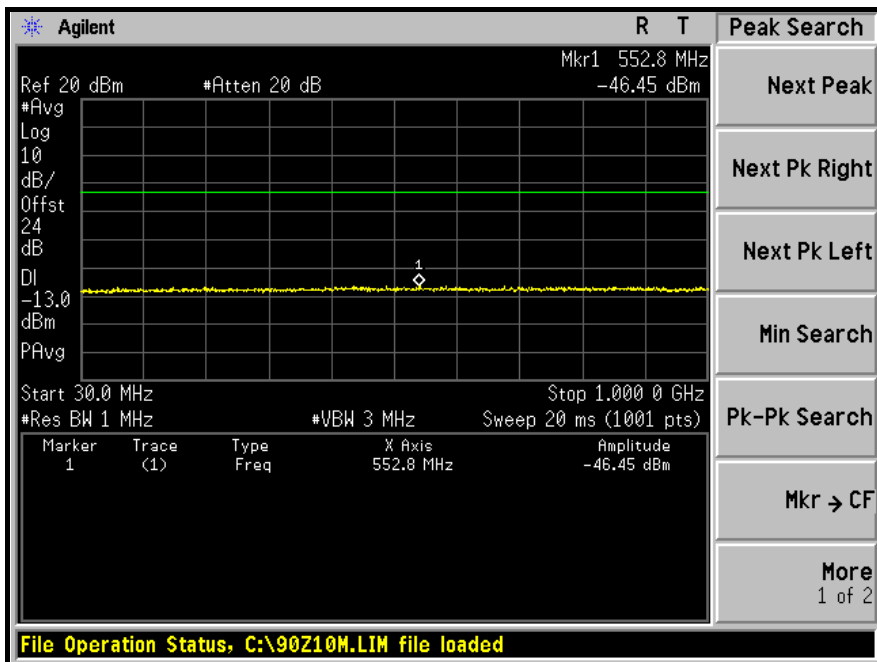

### 1GHz ~ 5GHz:

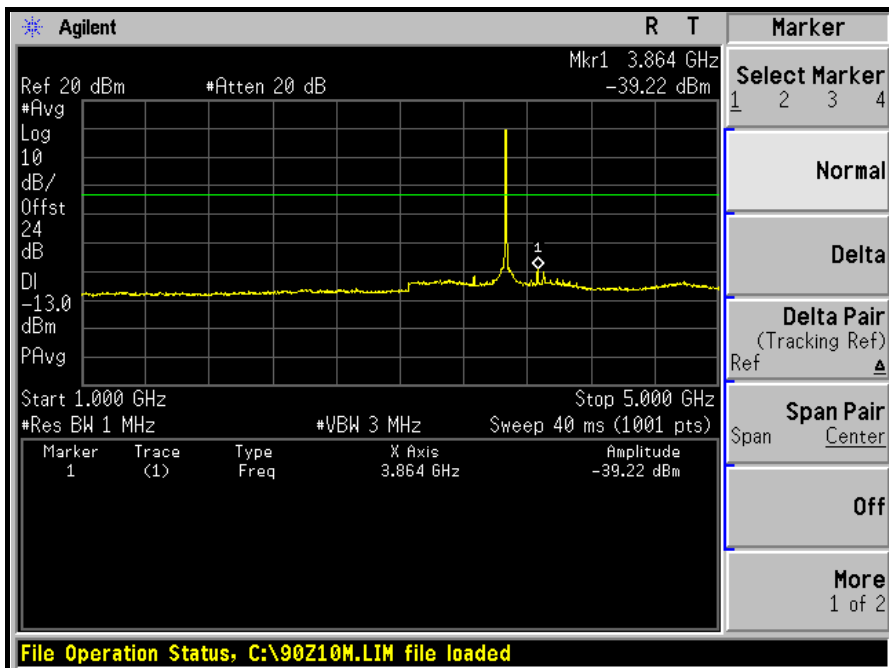



A D T

5GHz ~ 10GHz:

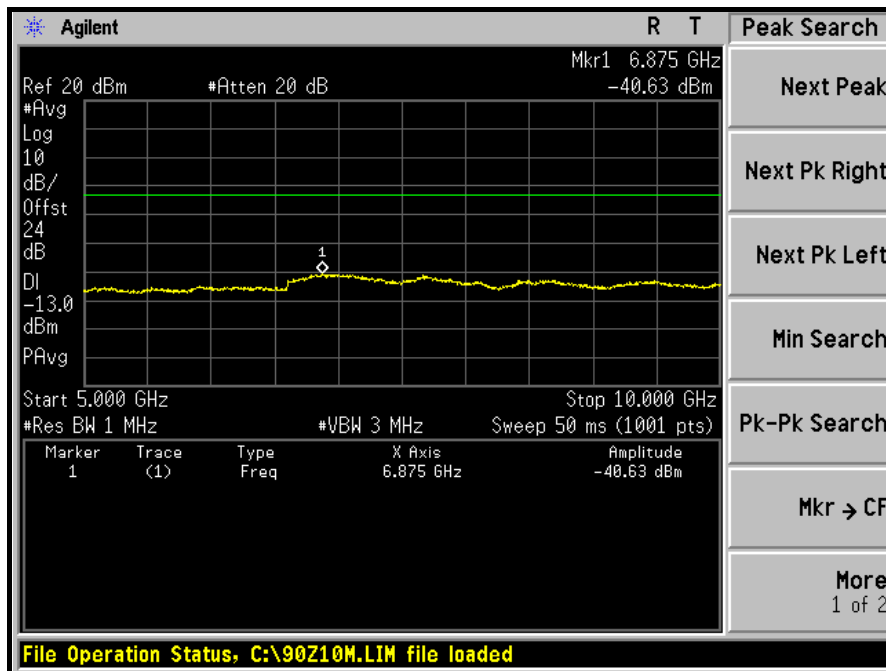

10GHz ~ 20GHz:

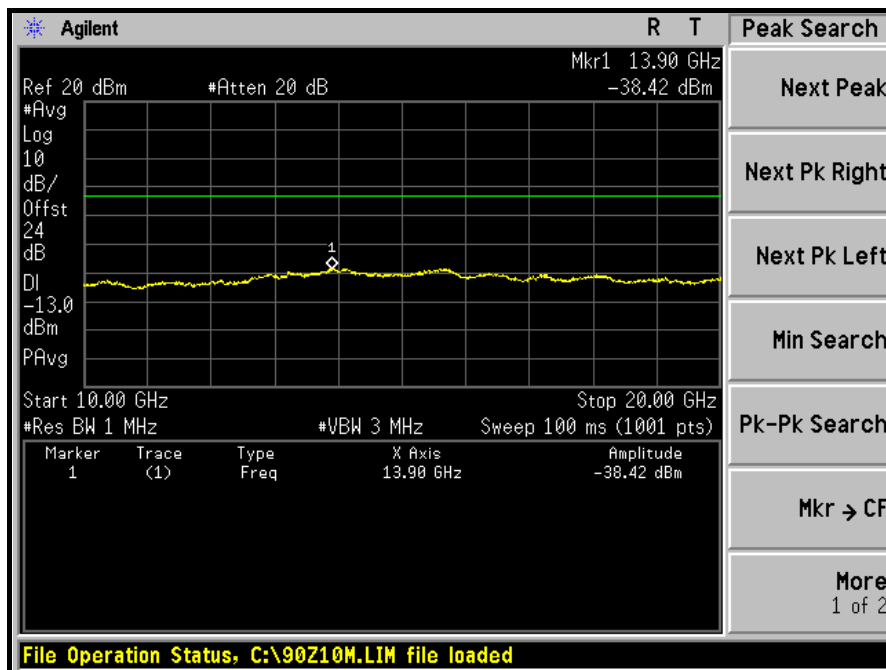



A D T

20GHz ~ 30GHz:

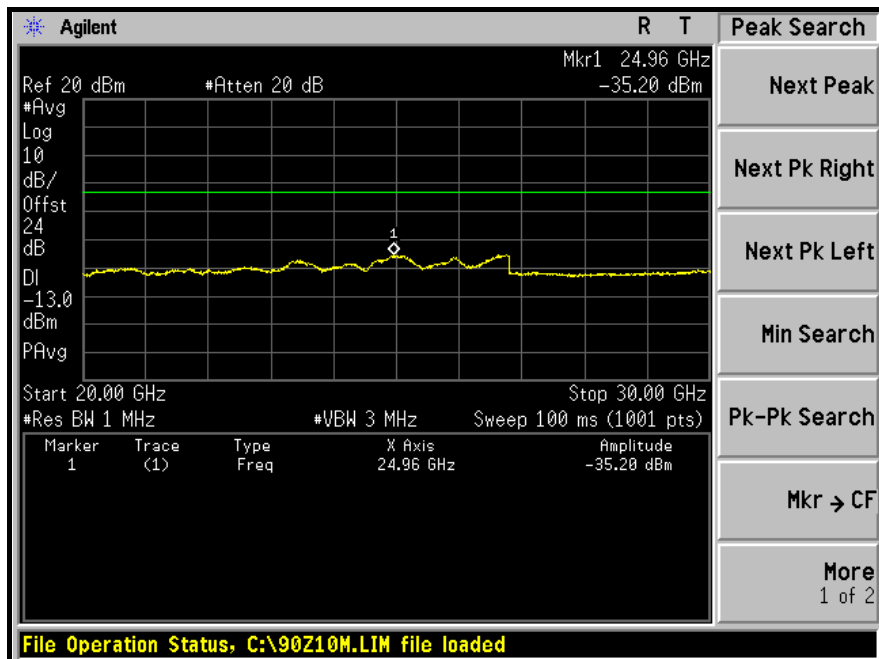

30GHz ~ 40GHz:

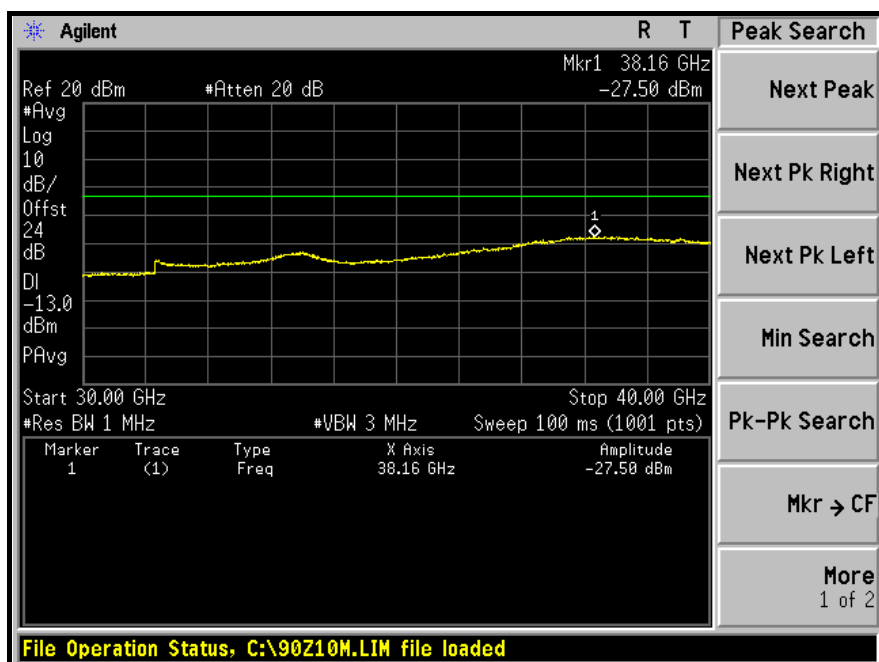



A D T

**HIGH CHANNEL: 30MHz ~ 1GHz:**

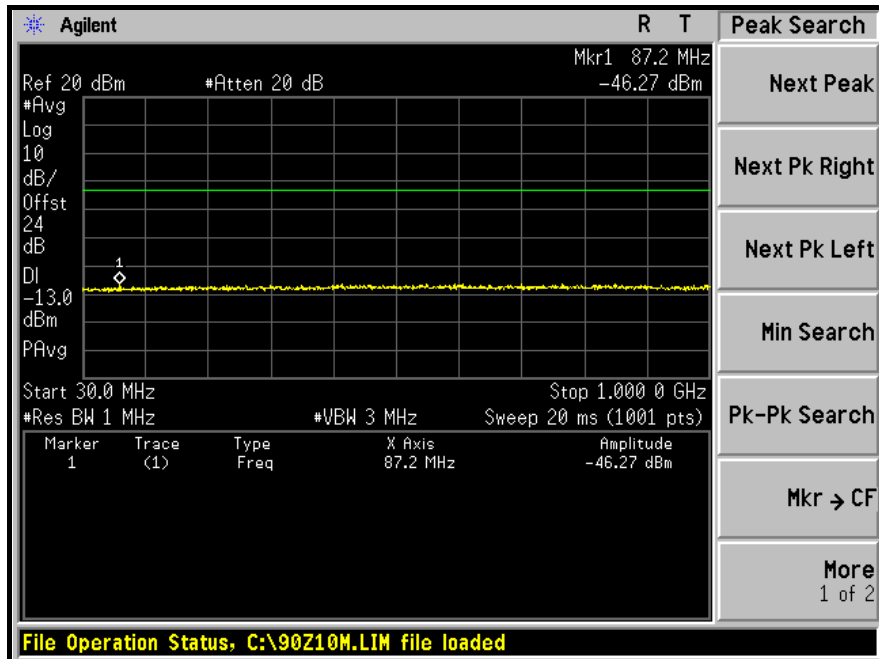

**1GHz ~ 5GHz:**

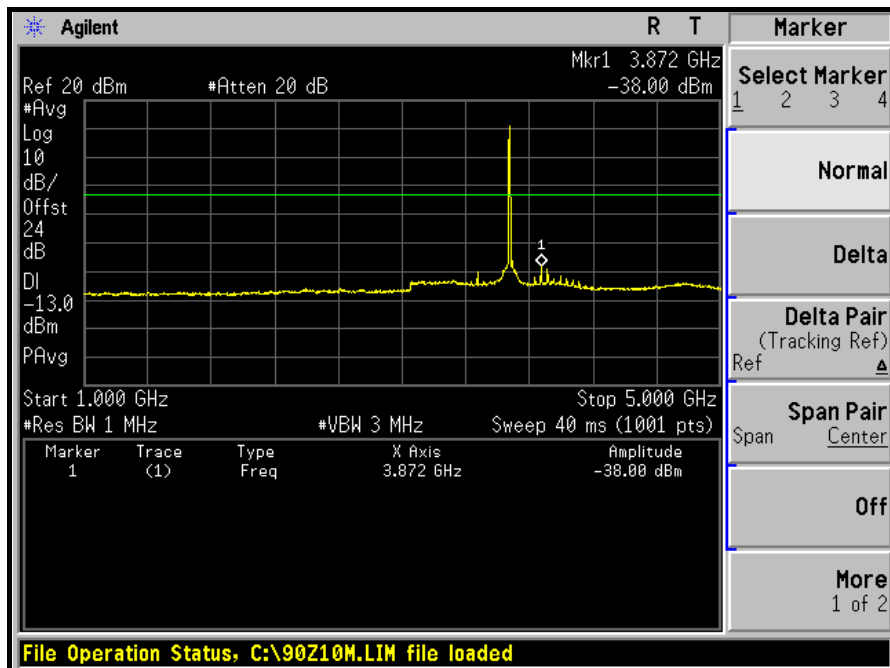



A D T

5GHz ~ 10GHz:

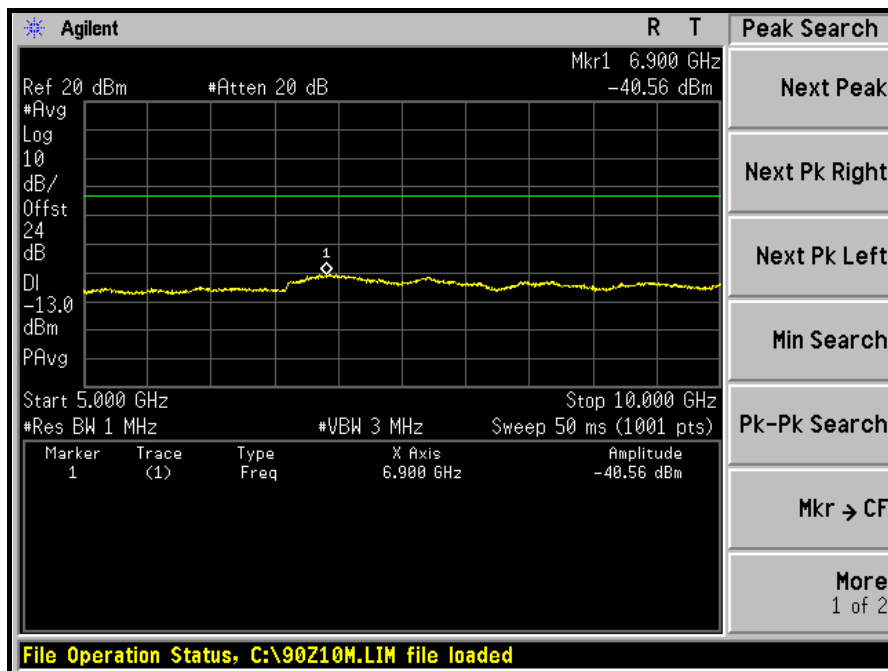

10GHz ~ 20GHz:

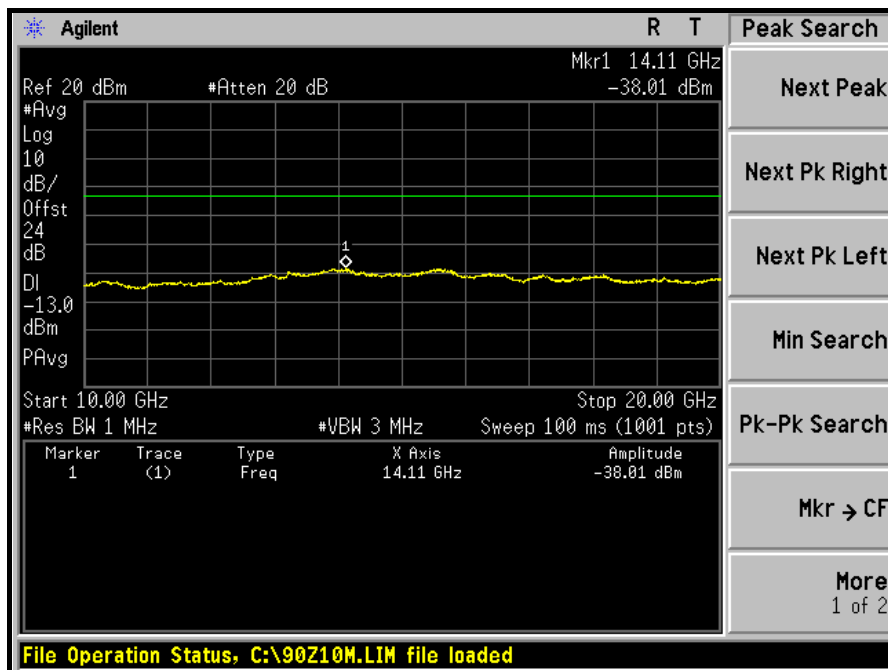





A D T

20GHz ~ 30GHz:

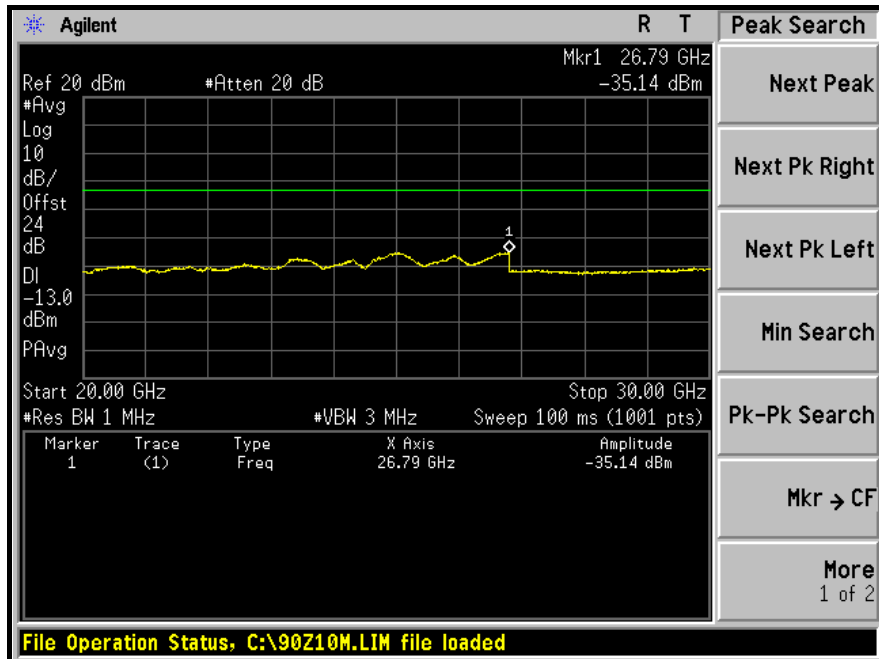

30GHz ~ 40GHz:

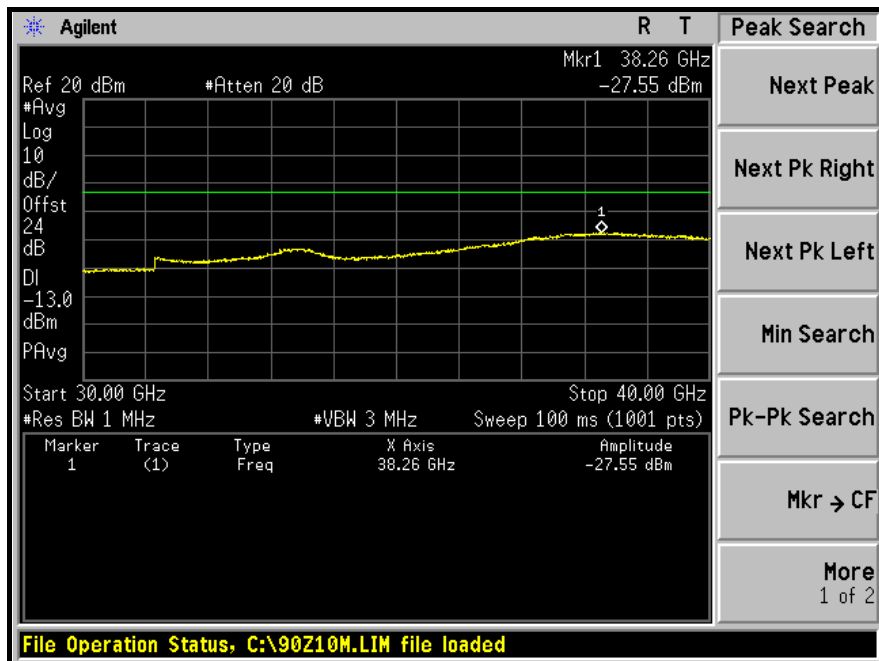



A D T

### CHANNEL BANDWIDTH: 10MHz

#### LOW CHANNEL: 30MHz ~ 1GHz:

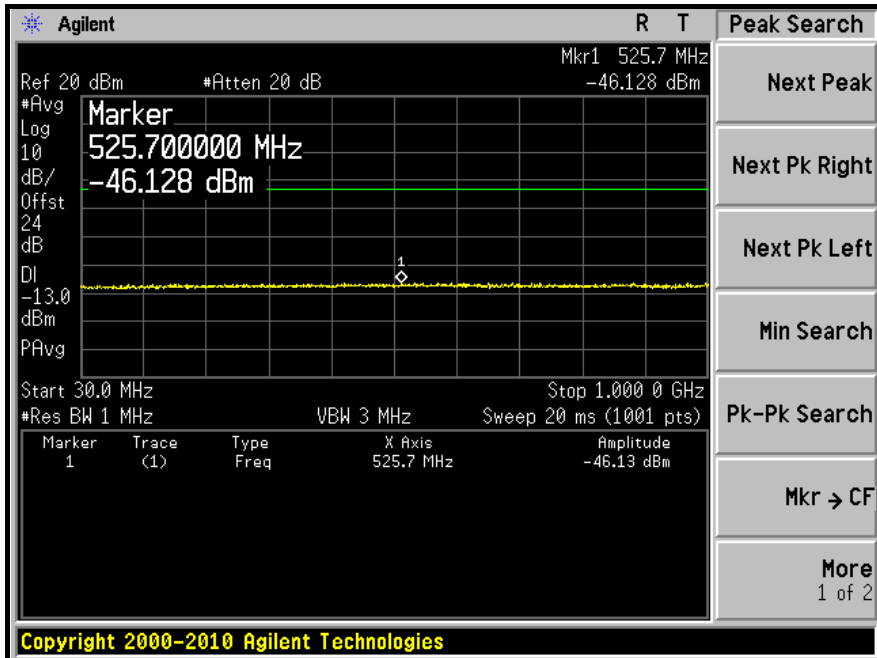

#### 1GHz ~ 5GHz:

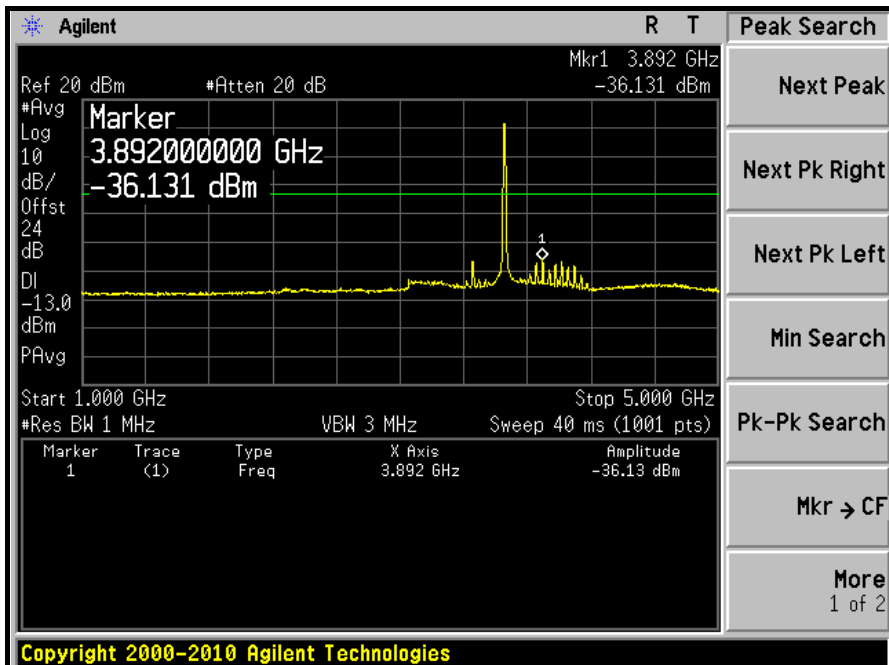



A D T

5GHz ~ 10GHz:

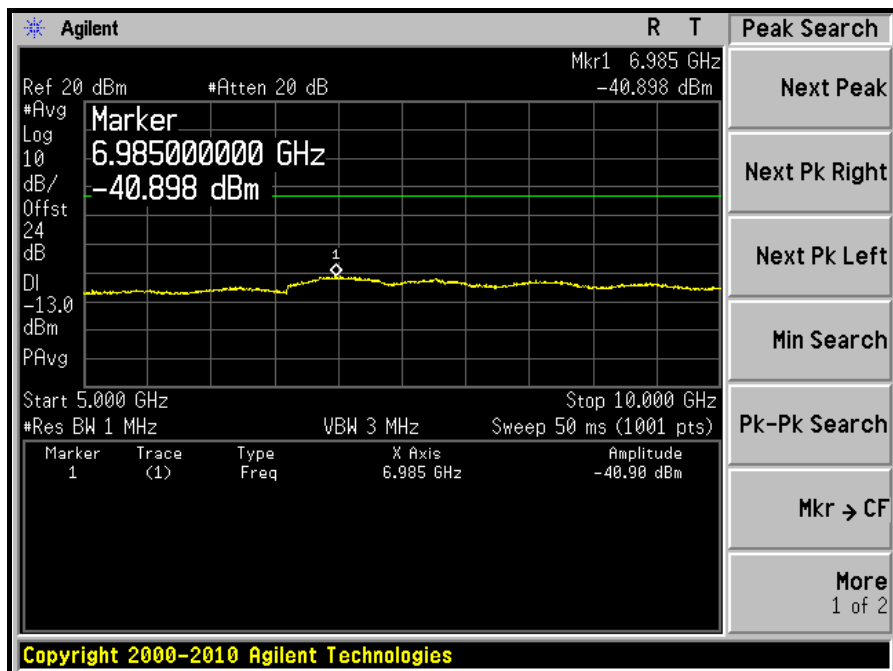

10GHz ~ 20GHz:

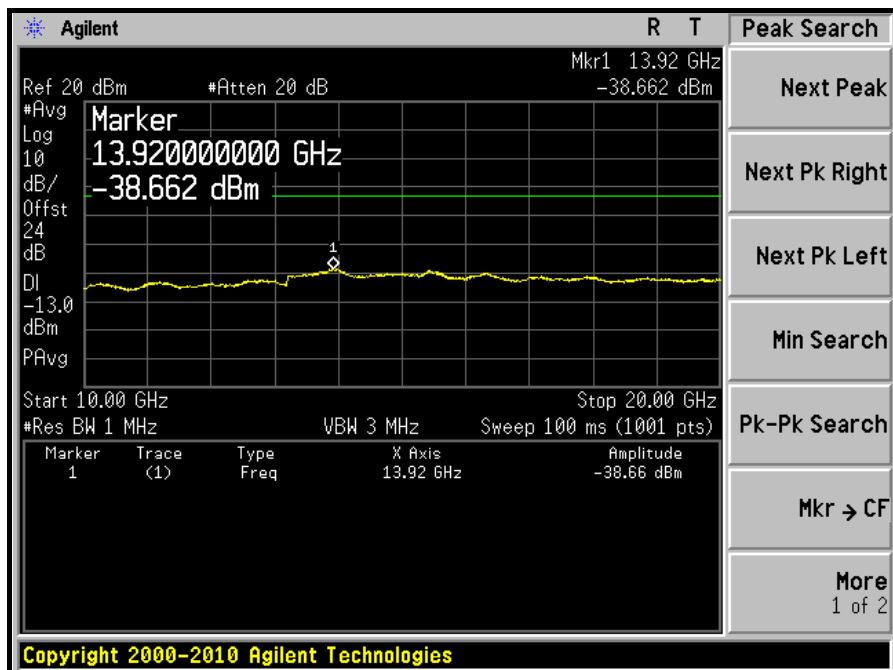



A D T

20GHz ~ 30GHz:

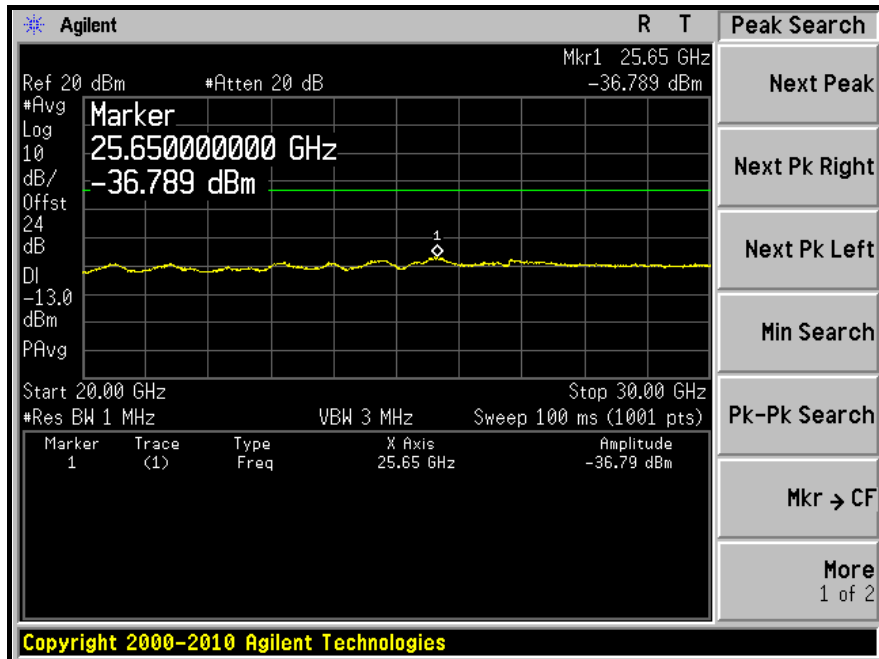

30GHz ~ 40GHz:

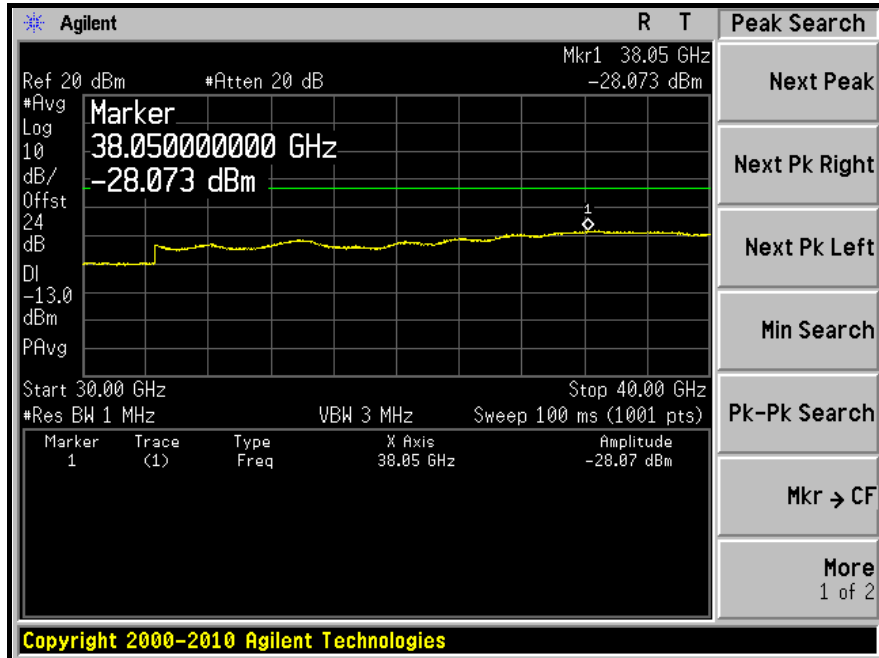



A D T

### MIDDLE CHANNEL: 30MHz ~ 1GHz:

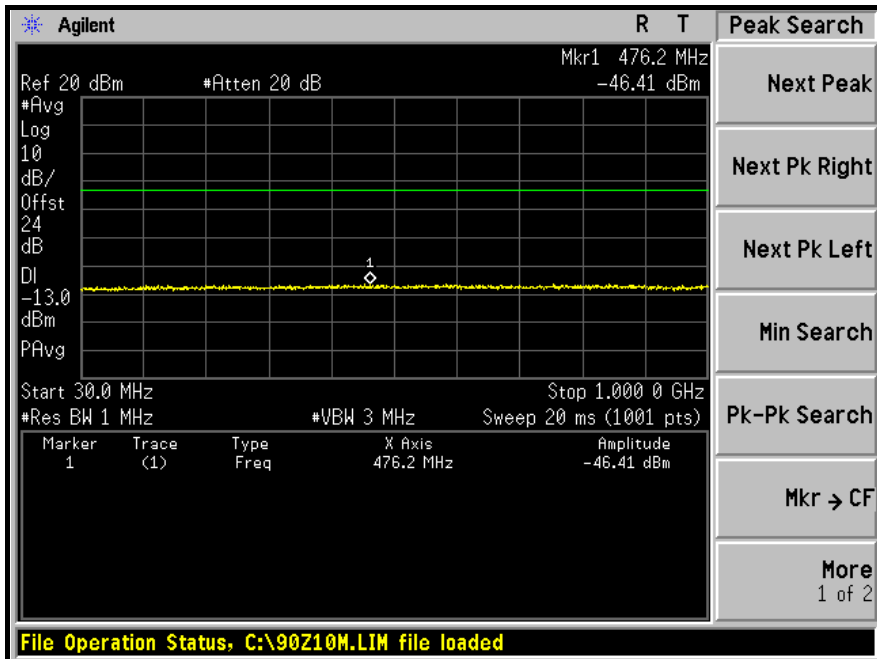

### 1GHz ~ 5GHz:

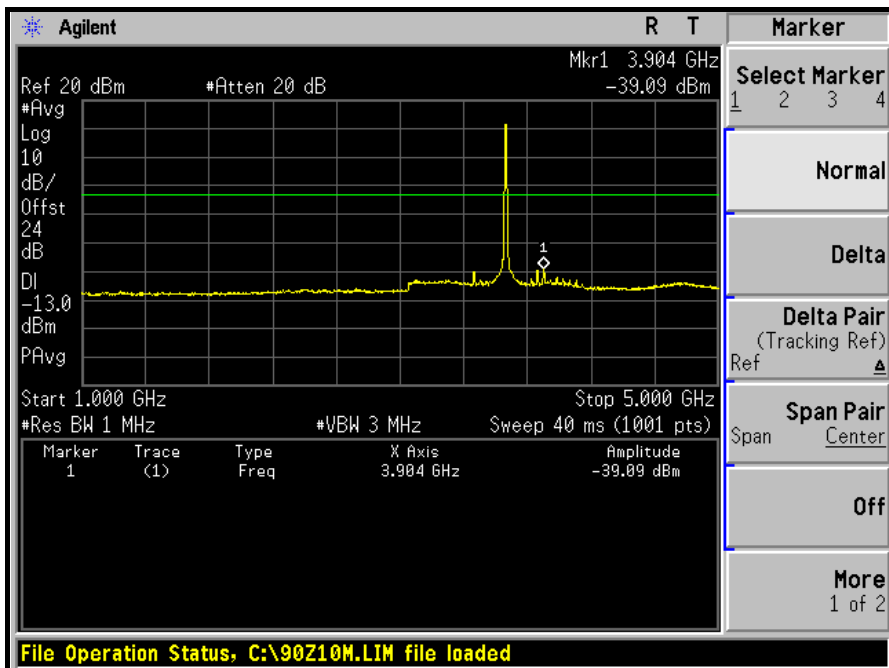



A D T

5GHz ~ 10GHz:

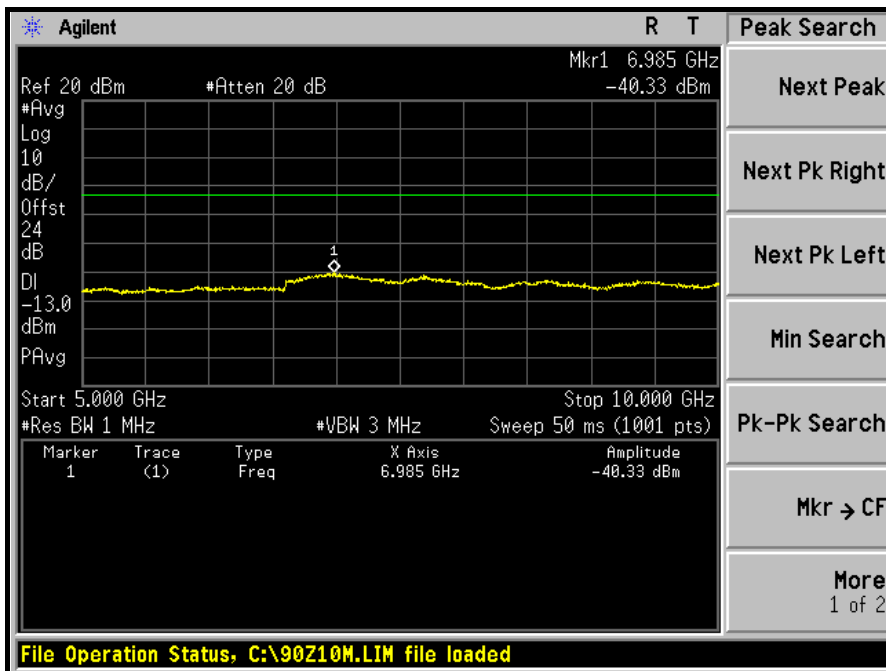

10GHz ~ 20GHz:

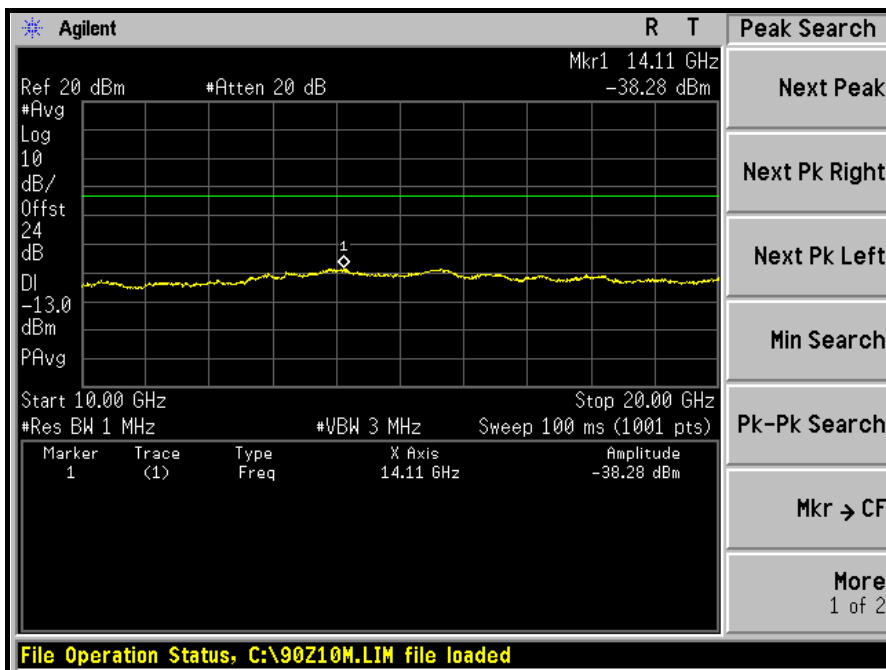



A D T

20GHz ~ 30GHz:

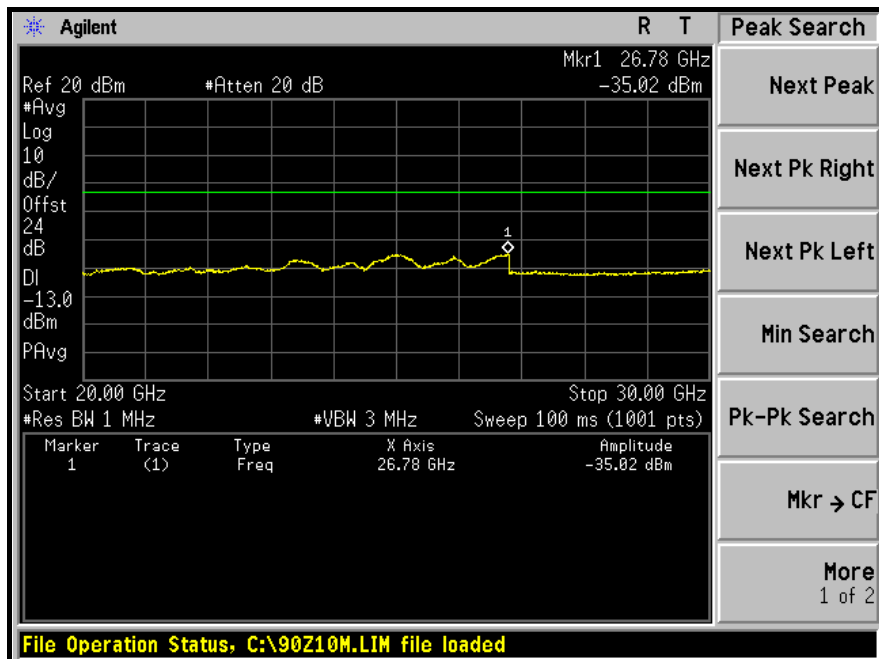

30GHz ~ 40GHz:

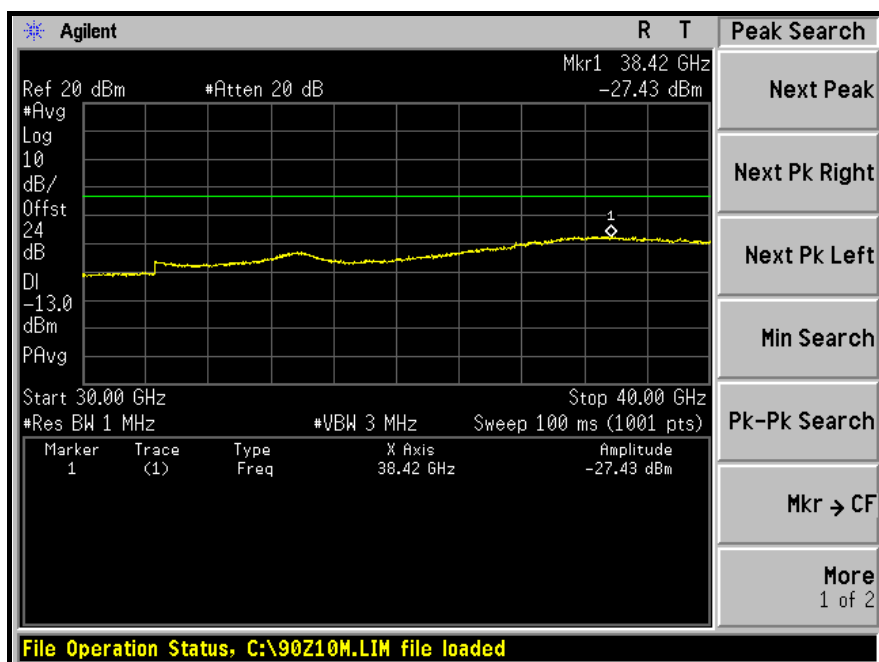



A D T

HIGH CHANNEL: 30MHz ~ 1GHz:

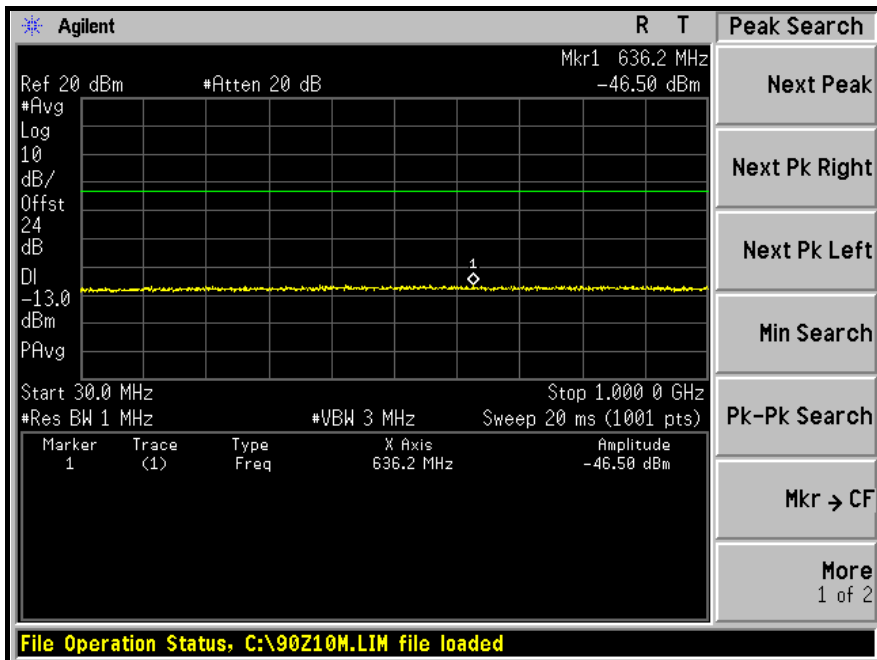

1GHz ~ 5GHz:

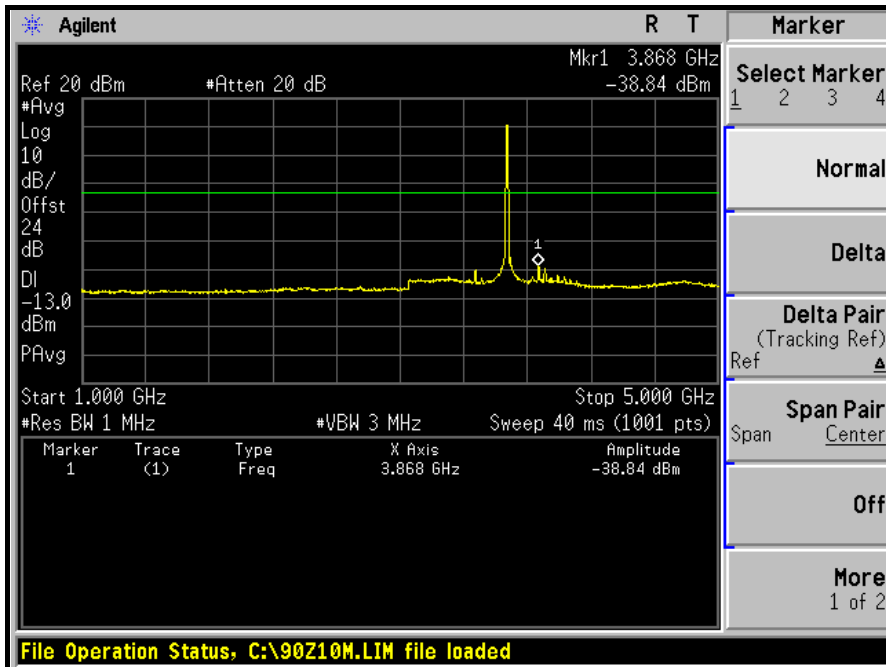





A D T

5GHz ~ 10GHz:

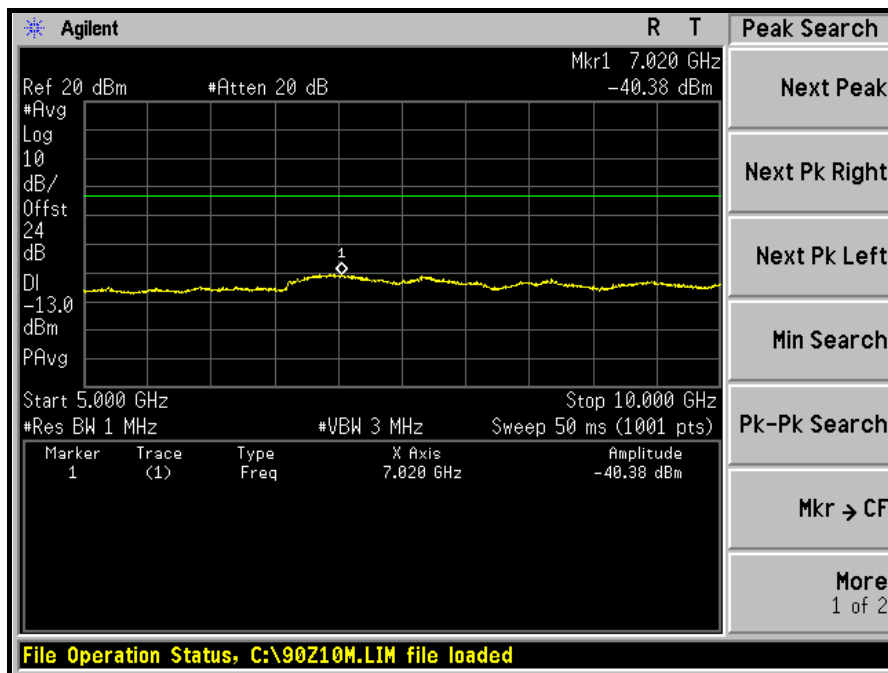

10GHz ~ 20GHz:

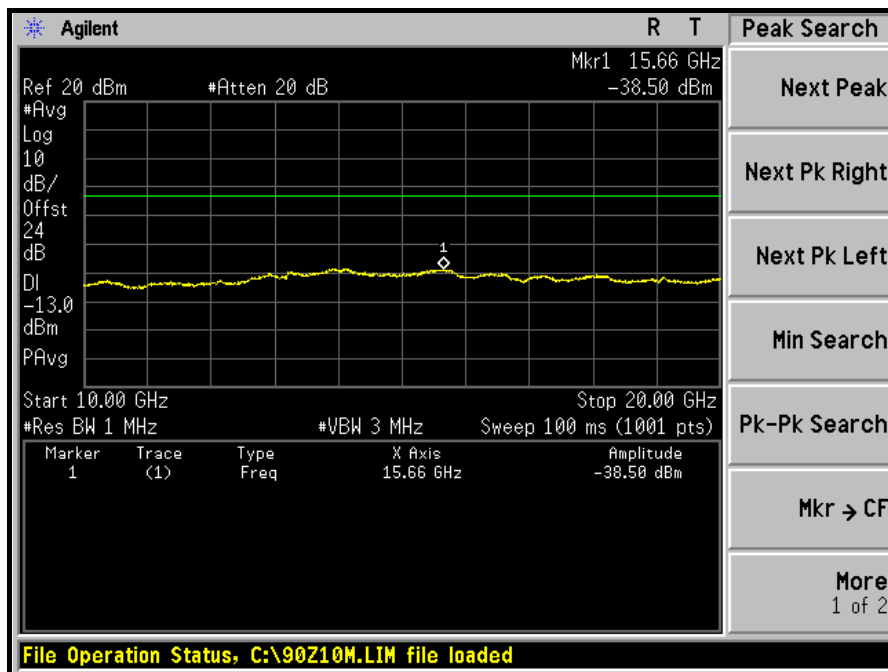



A D T

20GHz ~ 30GHz:

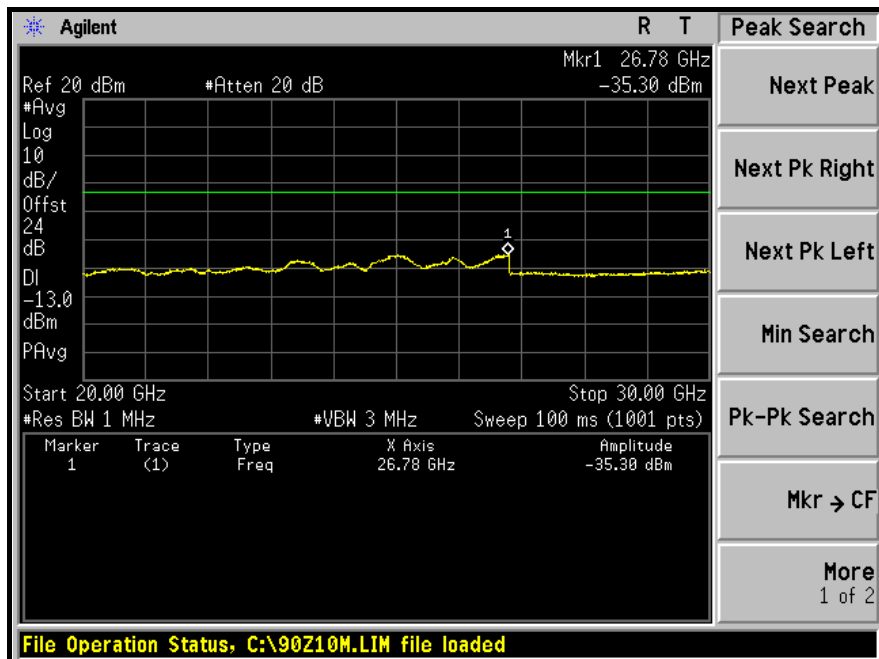

30GHz ~ 40GHz:

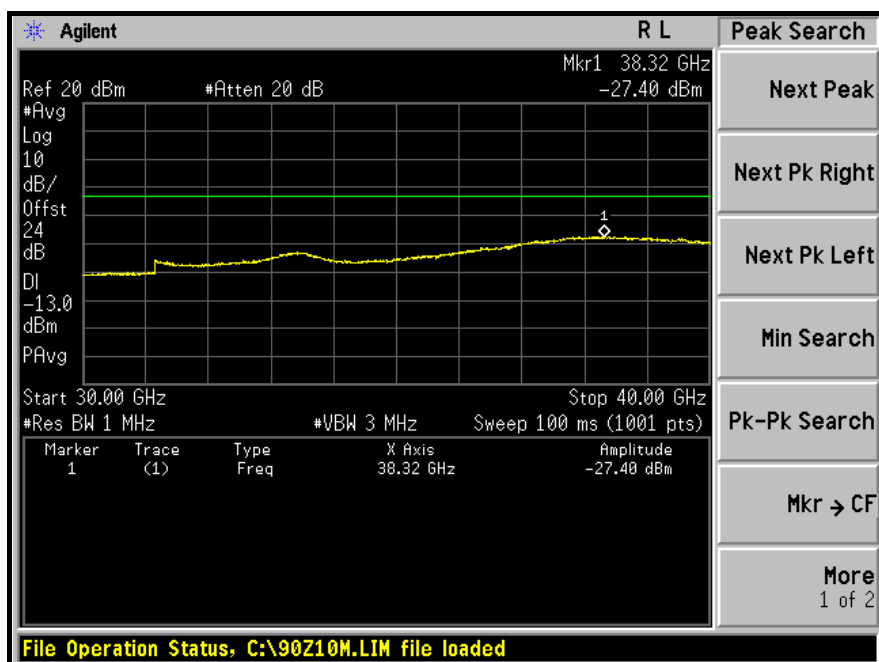

## 4.6 RADIATED EMISSION MEASUREMENT (BELOW 1GHz)

### 4.6.1 LIMITS OF RADIATED EMISSION MEASUREMENT

According to FCC 90.1323 specified that the power of any emission outside a licensee's frequency band(s) of operation shall be attenuated below the transmitter power (P) within the licensed band(s) of operation, measured in Watts, by at least  $43 + 10 \log (P)$  dB. The limit of emission equal to  $-13\text{dBm}$  Compliance with this provision is based on the use of measurement instrumentation employing a resolution bandwidth of 1 MHz or less, but at least one percent of the emission bandwidth of the fundamental emission of the transmitter, provided the measured energy is integrated over a 1 MHz bandwidth.



A D T

#### 4.6.2 TEST INSTRUMENTS

DESCRIPTION & MANUFACTURER	MODEL NO.	SERIAL NO.	CALIBRATED DATE	CALIBRATED UNTIL
ROHDE & SCHWARZ Spectrum Analyzer	FSP40	100036	Dec. 14, 2011	Dec. 13, 2012
Agilent PSA Spectrum Analyzer	E4446A	MY48250113	Nov. 30 , 2011	Nov. 29 , 2012
HP Pre_Amplifier	8449B	300801923	Oct. 31, 2011	Oct. 30, 2012
ROHDE & SCHWARZ Test Receiver	ESCS30	847124/029	Sep. 02, 2011	Sep. 01, 2012
SCHWARZBECK TRILOG Broadband Antenna	VULB 9168	138	Apr. 02, 2012	Apr. 01, 2013
Schwarzbeck Horn_Antenna	BBHA9120	D124	Dec. 16, 2011	Dec. 15, 2012
Schwarzbeck Horn_Antenna	BBHA 9170	BBHA9170153	Jan. 17, 2012	Jan. 16, 2013
RF Switches	EMH-011	1001	Sep. 24, 2011	Sep. 23, 2012
RF CABLE (Chaintek)	Sucoflex 106	RF106-102	Jan. 19, 2012	Jan. 18, 2013
RF Cable	8DFB	STCCAB-30M-1GHz	Sep. 24, 2011	Sep. 23, 2012
Software	ADT_Radiated_V7.6.15.9.2	NA	NA	NA
CT Antenna Tower & Turn Table	NA	NA	NA	NA

**Note:**

1. The calibration interval of the above test instruments is 12 months and the calibrations are traceable to NML/ROC and NIST/USA.
2. The horn antenna, preamplifier (model: 8449B) and Spectrum Analyzer (model: FSP40) are used only for the measurement of emission frequency above 1GHz if tested.
- 3 The test was performed in Open Site No. C.
4. The FCC Site Registration No. is 656396.
- 5 The VCCI Site Registration No. is R-1626.
- 6 The CANADA Site Registration No. is IC 7450G-3.
- 7 Tested Date: Apr. 17, 2012

#### 4.6.3 TEST PROCEDURES

- a. Substitution method is used for EIRP measurement. The EUT placed on the 0.8m height of Turn Table, rotated the table around 360 degrees to search the maximum radiation power and receiver antenna shall be rotated vertical and horizontal polarization and moved height from 1m to 4m to find the maximum polar radiated power. The “Read Value” is the spectrum reading the maximum power value.
- b. The substitution antenna is substituted for EUT at the same position and signals generator export the CW signal to the substitution antenna via a tx cable. Rotated the Turn Table and moved receiving antenna to find the maximum radiation power. Adjust output power level of S.G to get a Value of spectrum reading equal to “Read Value” of step a. Record the power level of S.G

EIRP = Output power level of S.G – TX cable loss + Antenna gain of Substitution antenna

**NOTE:** The resolution bandwidth of spectrum analyzer is 1 MHz and the video bandwidth is 3 MHz.

#### 4.6.4 DEVIATION FROM TEST STANDARD

No deviation

#### 4.6.5 TEST SETUP

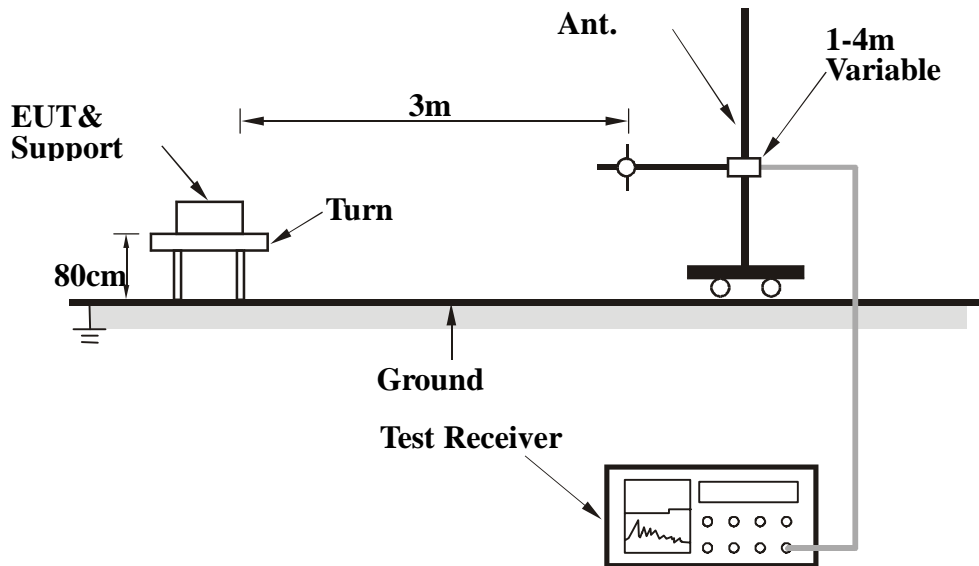

For the actual test configuration, please refer to the related item – Photographs of the Test Configuration.

#### 4.6.6 EUT OPERATING CONDITIONS

Same as 4.1.5.



A D T

#### 4.6.7 TEST RESULTS

<b>MODE</b>	Low channel	<b>FREQUENCY RANGE</b>	Below 1000MHz
<b>INPUT POWER</b>	120Vac, 60Hz	<b>ENVIRONMENTAL CONDITIONS</b>	25deg°C, 60%RH
<b>TESTED BY</b>	Robert Cheng	<b>CHANNEL BANDWIDTH</b>	5MHz

ANTENNA POLARITY & TEST DISTANCE: HORIZONTAL AT 3m						
NO.	FREQ. (MHz)	EMISSION LEVEL (dBuV)	LIMIT (dBm)	S.G POWER VALUE (dBm)	CORRECTION FACTOR (dB)	POWER VALUE (dBm)
1	246.33	39.51	-13	-55.59	3.87	-51.72
2	304.95	43.19	-13	-52.79	3.70	-49.08
3	604.45	35.43	-13	-59.23	1.79	-57.44
4	698.94	34.43	-13	-61.91	1.63	-60.28
5	849.34	36.48	-13	-58.21	1.04	-57.18
6	897.44	37.55	-13	-60.95	0.52	-60.42
ANTENNA POLARITY & TEST DISTANCE: VERTICAL AT 3m						
NO.	FREQ. (MHz)	EMISSION LEVEL (dBuV/m)	LIMIT (dBm)	S.G POWER VALUE (dBm)	CORRECTION FACTOR (dB)	POWER VALUE (dBm)
1	33.44	35.11	-13	-37.39	-14.06	-51.45
2	148.13	30.41	-13	-61.32	-1.07	-62.40
3	247.36	34.11	-13	-60.95	3.88	-57.07
4	304.8	42.00	-13	-53.98	3.70	-50.27
5	604.45	34.53	-13	-60.13	1.79	-58.34
6	849.12	32.42	-13	-62.28	1.04	-61.24

**NOTE:** Power Value (dBum) = S.G Power Value (dBm) + Correction Factor (dB).



A D T

<b>MODE</b>	Low channel	<b>FREQUENCY RANGE</b>	Below 1000MHz
<b>INPUT POWER</b>	120Vac, 60Hz	<b>ENVIRONMENTAL CONDITIONS</b>	25deg°C, 60%RH
<b>TESTED BY</b>	Robert Cheng	<b>CHANNEL BANDWIDTH</b>	10MHz

**ANTENNA POLARITY & TEST DISTANCE: HORIZONTAL AT 3m**

NO.	FREQ. (MHz)	EMISSION LEVEL (dBuV)	LIMIT (dBm)	S.G POWER VALUE (dBm)	CORRECTION FACTOR (dB)	POWER VALUE (dBm)
1	246.6	37.66	-13	-57.44	3.87	-53.57
2	304.62	44.49	-13	-51.49	3.70	-47.78
3	604.71	34.49	-13	-60.17	1.79	-58.38
4	699.32	33.17	-13	-63.17	1.63	-61.54
5	849.48	36.66	-13	-58.03	1.04	-57.00
6	897.09	36.66	-13	-61.84	0.52	-61.31

**ANTENNA POLARITY & TEST DISTANCE: VERTICAL AT 3m**

NO.	FREQ. (MHz)	EMISSION LEVEL (dBuV/m)	LIMIT (dBm)	S.G POWER VALUE (dBm)	CORRECTION FACTOR (dB)	POWER VALUE (dBm)
1	33.43	35.58	-13	-36.92	-14.06	-50.98
2	147.71	31.12	-13	-60.61	-1.07	-61.69
3	247.66	34.38	-13	-60.68	3.88	-56.80
4	304.62	41.05	-13	-54.93	3.70	-51.22
5	604.82	36.14	-13	-58.52	1.79	-56.73
6	849.37	33.29	-13	-61.41	1.04	-60.37

**NOTE:** Power Value (dBum) = S.G Power Value (dBm) + Correction Factor (dB).



## **4.7 RADIATED EMISSION MEASUREMENT (ABOVE 1GHz)**

### **4.7.1 LIMITS OF RADIATED EMISSION MEASUREMENT**

According to FCC 90.1323 specified that the power of any emission outside a licensee's frequency band(s) of operation shall be attenuated below the transmitter power (P) within the licensed band(s) of operation, measured in Watts, by at least  $43 + 10 \log (P)$  dB. The limit of emission equal to  $-13\text{dBm}$  Compliance with this provision is based on the use of measurement instrumentation employing a resolution bandwidth of 1 MHz or less, but at least one percent of the emission bandwidth of the fundamental emission of the transmitter, provided the measured energy is integrated over a 1 MHz bandwidth.

### **4.7.2 TEST INSTRUMENTS**

Same as 4.6.2.

### **4.7.3 TEST PROCEDURES**

Same as 4.6.3.

### **4.7.4 DEVIATION FROM TEST STANDARD**

No deviation

### **4.7.5 TEST SETUP**

Same as 4.6.5.

### **4.7.6 EUT OPERATING CONDITIONS**

Same as 4.1.5



A D T

#### 4.7.7 TEST RESULTS

<b>MODE</b>	Low channel	<b>FREQUENCY RANGE</b>	Above 1000MHz
<b>INPUT POWER</b>	120Vac, 60Hz	<b>ENVIRONMENTAL CONDITIONS</b>	25deg°C, 60%RH
<b>TESTED BY</b>	Wen Yu	<b>CHANNEL BANDWIDTH</b>	5MHz

ANTENNA POLARITY & TEST DISTANCE: HORIZONTAL AT 3m						
NO.	FREQ. (MHz)	EMISSION LEVEL (dBuV)	LIMIT (dBm)	S.G POWER VALUE (dBm)	CORRECTION FACTOR (dB)	POWER VALUE (dBm)
1	7305	53.20	-13	-49.19	4.71	-44.47
2	10957.5	56.80	-13	-44.80	3.13	-41.67
3	14610	61.00	-13	-36.95	3.13	-33.82
ANTENNA POLARITY & TEST DISTANCE: VERTICAL AT 3m						
NO.	FREQ. (MHz)	EMISSION LEVEL (dBuV/m)	LIMIT (dBm)	S.G POWER VALUE (dBm)	CORRECTION FACTOR (dB)	POWER VALUE (dBm)
1	7305	60.20	-13	-42.19	4.71	-37.47
2	10957.5	58.90	-13	-42.70	3.13	-39.57
3	14610	60.90	-13	-37.05	3.13	-33.92

**NOTE:** Power Value (dBum) = S.G Power Value (dBm) + Correction Factor (dB).



A D T

<b>MODE</b>	Middle channel	<b>FREQUENCY RANGE</b>	Above 1000MHz
<b>INPUT POWER</b>	120Vac, 60Hz	<b>ENVIRONMENTAL CONDITIONS</b>	25deg°C, 60%RH
<b>TESTED BY</b>	Wen Yu	<b>CHANNEL BANDWIDTH</b>	5MHz

**ANTENNA POLARITY & TEST DISTANCE: HORIZONTAL AT 3m**

NO.	FREQ. (MHz)	EMISSION LEVEL (dBuV)	LIMIT (dBm)	S.G POWER VALUE (dBm)	CORRECTION FACTOR (dB)	POWER VALUE (dBm)
1	7325	58.60	-13	-43.81	4.69	-39.12
2	10987.5	57.50	-13	-44.06	3.10	-40.96
3	14650	61.50	-13	-36.39	3.19	-33.20

**ANTENNA POLARITY & TEST DISTANCE: VERTICAL AT 3m**

NO.	FREQ. (MHz)	EMISSION LEVEL (dBuV/m)	LIMIT (dBm)	S.G POWER VALUE (dBm)	CORRECTION FACTOR (dB)	POWER VALUE (dBm)
1	7325	60.38	-13	-42.03	4.69	-37.34
2	10987.5	59.20	-13	-42.36	3.10	-39.26
3	14650	61.00	-13	-36.89	3.19	-33.70

**NOTE:** Power Value (dBum) = S.G Power Value (dBm) + Correction Factor (dB).



A D T

<b>MODE</b>	High channel	<b>FREQUENCY RANGE</b>	Above 1000MHz
<b>INPUT POWER</b>	120Vac, 60Hz	<b>ENVIRONMENTAL CONDITIONS</b>	25deg°C, 60%RH
<b>TESTED BY</b>	Wen Yu	<b>CHANNEL BANDWIDTH</b>	5MHz

**ANTENNA POLARITY & TEST DISTANCE: HORIZONTAL AT 3m**

NO.	FREQ. (MHz)	EMISSION LEVEL (dBuV)	LIMIT (dBm)	S.G POWER VALUE (dBm)	CORRECTION FACTOR (dB)	POWER VALUE (dBm)
1	7345	59.10	-13	-43.33	4.68	-38.66
2	11017.5	58.20	-13	-43.35	3.12	-40.23
3	14690	60.80	-13	-37.03	3.25	-33.78

**ANTENNA POLARITY & TEST DISTANCE: VERTICAL AT 3m**

NO.	FREQ. (MHz)	EMISSION LEVEL (dBuV/m)	LIMIT (dBm)	S.G POWER VALUE (dBm)	CORRECTION FACTOR (dB)	POWER VALUE (dBm)
1	7345	61.20	-13	-41.23	4.68	-36.56
2	11017.5	60.30	-13	-41.25	3.12	-38.13
3	14690	61.50	-13	-36.33	3.25	-33.08

**NOTE:** Power Value (dBum) = S.G Power Value (dBm) + Correction Factor (dB).



A D T

<b>MODE</b>	Low channel	<b>FREQUENCY RANGE</b>	Above 1000MHz
<b>INPUT POWER</b>	120Vac, 60Hz	<b>ENVIRONMENTAL CONDITIONS</b>	25deg°C, 60%RH
<b>TESTED BY</b>	Wen Yu	<b>CHANNEL BANDWIDTH</b>	10MHz

<b>ANTENNA POLARITY &amp; TEST DISTANCE: HORIZONTAL AT 3m</b>						
<b>NO.</b>	<b>FREQ. (MHz)</b>	<b>EMISSION LEVEL (dBuV)</b>	<b>LIMIT (dBm)</b>	<b>S.G POWER VALUE (dBm)</b>	<b>CORRECTION FACTOR (dB)</b>	<b>POWER VALUE (dBm)</b>
1	7310	58.30	-13	-44.09	4.71	-39.38
2	10965	60.50	-13	-41.09	3.12	-37.97
3	14620	60.70	-13	-37.24	3.14	-34.09
<b>ANTENNA POLARITY &amp; TEST DISTANCE: VERTICAL AT 3m</b>						
<b>NO.</b>	<b>FREQ. (MHz)</b>	<b>EMISSION LEVEL (dBuV/m)</b>	<b>LIMIT (dBm)</b>	<b>S.G POWER VALUE (dBm)</b>	<b>CORRECTION FACTOR (dB)</b>	<b>POWER VALUE (dBm)</b>
1	7310	63.00	-13	-39.39	4.71	-34.68
2	10965	59.10	-13	-42.49	3.12	-39.37
3	14620	59.80	-13	-38.14	3.14	-34.99

**NOTE:** Power Value (dBum) = S.G Power Value (dBm) + Correction Factor (dB).



A D T

<b>MODE</b>	Middle channel	<b>FREQUENCY RANGE</b>	Above 1000MHz
<b>INPUT POWER</b>	120Vac, 60Hz	<b>ENVIRONMENTAL CONDITIONS</b>	25deg°C, 60%RH
<b>TESTED BY</b>	Wen Yu	<b>CHANNEL BANDWIDTH</b>	10MHz

<b>ANTENNA POLARITY &amp; TEST DISTANCE: HORIZONTAL AT 3m</b>						
<b>NO.</b>	<b>FREQ. (MHz)</b>	<b>EMISSION LEVEL (dBuV)</b>	<b>LIMIT (dBm)</b>	<b>S.G POWER VALUE (dBm)</b>	<b>CORRECTION FACTOR (dB)</b>	<b>POWER VALUE (dBm)</b>
1	7325	58.00	-13	-44.41	4.69	-39.72
2	10987.5	58.30	-13	-43.26	3.10	-40.16
3	14650	59.30	-13	-38.59	3.19	-35.40
<b>ANTENNA POLARITY &amp; TEST DISTANCE: VERTICAL AT 3m</b>						
<b>NO.</b>	<b>FREQ. (MHz)</b>	<b>EMISSION LEVEL (dBuV/m)</b>	<b>LIMIT (dBm)</b>	<b>S.G POWER VALUE (dBm)</b>	<b>CORRECTION FACTOR (dB)</b>	<b>POWER VALUE (dBm)</b>
1	7325	61.60	-13	-40.81	4.69	-36.12
2	10987.5	58.40	-13	-43.16	3.10	-40.06
3	14650	60.50	-13	-37.39	3.19	-34.20

**NOTE:** Power Value (dBum) = S.G Power Value (dBm) + Correction Factor (dB).



A D T

<b>MODE</b>	High channel	<b>FREQUENCY RANGE</b>	Above 1000MHz
<b>INPUT POWER</b>	120Vac, 60Hz	<b>ENVIRONMENTAL CONDITIONS</b>	25deg°C, 60%RH
<b>TESTED BY</b>	Wen Yu	<b>CHANNEL BANDWIDTH</b>	10MHz

ANTENNA POLARITY & TEST DISTANCE: HORIZONTAL AT 3m						
NO.	FREQ. (MHz)	EMISSION LEVEL (dBuV)	LIMIT (dBm)	S.G POWER VALUE (dBm)	CORRECTION FACTOR (dB)	POWER VALUE (dBm)
1	7340	65.70	-13	-36.73	4.68	-32.05
2	11010	58.80	-13	-42.75	3.10	-39.64
3	14680	60.10	-13	-37.74	3.23	-34.51

ANTENNA POLARITY & TEST DISTANCE: VERTICAL AT 3m						
NO.	FREQ. (MHz)	EMISSION LEVEL (dBuV/m)	LIMIT (dBm)	S.G POWER VALUE (dBm)	CORRECTION FACTOR (dB)	POWER VALUE (dBm)
1	7340	60.10	-13	-42.33	4.68	-37.65
2	11010	58.40	-13	-43.15	3.10	-40.04
3	14680	60.40	-13	-37.44	3.23	-34.21

**NOTE:** Power Value (dBum) = S.G Power Value (dBm) + Correction Factor (dB).



A D T

## 5 PHOTOGRAPHS OF THE TEST CONFIGURATION

Please refer to the attached file (Test Setup Photo).





A D T

## 6 INFORMATION ON THE TESTING LABORATORIES

We, Bureau Veritas Consumer Products Services (H.K.) Ltd., Taoyuan Branch, were founded in 1988 to provide our best service in EMC, Radio, Telecom and Safety consultation. Our laboratories are accredited and approved according to ISO/IEC 17025.

Copies of accreditation and authorization certificates of our laboratories obtained from approval agencies can be downloaded from our web site:

[www.adt.com.tw/index.5.phtml](http://www.adt.com.tw/index.5.phtml).

If you have any comments, please feel free to contact us at the following:

**Linko EMC/RF Lab:**

Tel: 886-2-26052180

Fax: 886-2-26052943

**Hsin Chu EMC/RF Lab:**

Tel: 886-3-5935343

Fax: 886-3-5935342

**Hwa Ya EMC/RF/Safety/Telecom Lab:**

Tel: 886-3-3183232

Fax: 886-3-3270892

**Email:** [service.adt@tw.bureauveritas.com](mailto:service.adt@tw.bureauveritas.com)

**Web Site:** [www.adt.com.tw](http://www.adt.com.tw)

The address and road map of all our labs can be found in our web site also.

---END---