



FCC TEST REPORT (PART 27)

REPORT NO.: RF970625H07

MODEL NO.: RG230, RG230-2.5-1D,
RG230-2.5-1D2V,
RG230-2.5-4D,
RG230-2.5-4D2V

RECEIVED: June 25, 2008

TESTED: July 09 to 22, 2008

ISSUED: Sep. 18, 2008

APPLICANT: Accton Wireless Broadband Corp.

ADDRESS: 3F, No. 1 Creation Rd. III, Science-based Industrial
Park Hsinchu 30077, Taiwan, R.O.C.

ISSUED BY : Advance Data Technology Corporation

LAB LOCATION : No. 81-1, Lu Liao Keng, 9 Ling, Wu Lung Tsuen,
Chiung Lin Hsiang, Hsin Chu Hsien, Taiwan.

This test report consists of 69 pages in total. It may be duplicated completely for legal use with the approval of the applicant. It should not be reproduced except in full, without the written approval of our laboratory. The client should not use it to claim product endorsement by any government agencies. The test results in the report only apply to the tested sample.



TABLE OF CONTENTS

1	CERTIFICATION	4
2	SUMMARY OF TEST RESULTS	5
2.1	MEASUREMENT UNCERTAINTY	6
3	GENERAL INFORMATION.....	7
3.1	GENERAL DESCRIPTION OF EUT.....	7
3.2	DESCRIPTION OF TEST MODES.....	8
3.2.1	TEST MODE APPLICABILITY AND TESTED CHANNEL DETAIL.....	9
3.3	GENERAL DESCRIPTION OF APPLIED STANDARDS.....	11
3.4	DESCRIPTION OF SUPPORT UNITS	12
3.4.1	CONFIGURATION OF SYSTEM UNDER TEST	13
4	TEST TYPES AND RESULTS	14
4.1	OUTPUT POWER MEASUREMENT	14
4.1.1	LIMITS OF OUTPUT POWER MEASUREMENT	14
4.1.2	TEST INSTRUMENTS	15
4.1.3	TEST PROCEDURES.....	16
4.1.4	TEST SETUP.....	17
4.1.5	EUT OPERATING CONDITIONS.....	17
4.1.6	TEST RESULTS.....	18
4.2	FREQUENCY STABILITY MEASUREMENT.....	24
4.2.1	LIMITS OF FREQUENCY STABILITY MEASUREMENT	24
4.2.2	TEST INSTRUMENTS	24
4.2.3	TEST PROCEDURE	25
4.2.4	TEST SETUP.....	25
4.2.5	TEST RESULTS.....	26
4.3	EMISSION BANDWIDTH MEASUREMENT.....	28
4.3.1	LIMITS OF EMISSION BANDWIDTH MEASUREMENT	28
4.3.2	TEST INSTRUMENTS	28
4.3.3	TEST SETUP.....	28
4.3.4	TEST PROCEDURES.....	28
4.3.5	TEST RESULTS.....	29
4.4	CHANNEL EDGE MEASUREMENT	33
4.4.1	LIMITS OF CHANNEL EDGE MEASUREMENT	33
4.4.2	TEST INSTRUMENTS	33
4.4.3	TEST SETUP	33
4.4.4	TEST PROCEDURES.....	34
4.4.5	EUT OPERATING CONDITION	34
4.4.6	TEST RESULTS.....	35
4.5	CONDUCTED SPURIOUS EMISSIONS	40
4.5.1	LIMITS OF CONDUCTED SPURIOUS EMISSIONS MEASUREMENT	40



4.5.2	TEST INSTRUMENTS	40
4.5.3	TEST PROCEDURE	41
4.5.4	TEST SETUP	41
4.5.5	EUT OPERATING CONDITIONS	41
4.5.6	TEST RESULTS.....	42
4.6	RADIATED EMISSION MEASUREMENT (BELOW 1GHz)	54
4.6.1	LIMITS OF RADIATED EMISSION MEASUREMENT	54
4.6.2	TEST INSTRUMENTS	54
4.6.3	TEST PROCEDURES.....	55
4.6.4	DEVIATION FROM TEST STANDARD	55
4.6.5	TEST SETUP	56
4.6.6	EUT OPERATING CONDITIONS	56
4.6.7	TEST RESULTS.....	57
4.7	RADIATED EMISSION MEASUREMENT (ABOVE 1GHz).....	59
4.7.1	LIMITS OF RADIATED EMISSION MEASUREMENT	59
4.7.2	TEST INSTRUMENTS	59
4.7.3	TEST PROCEDURES.....	60
4.7.4	DEVIATION FROM TEST STANDARD	60
4.7.5	TEST SETUP	61
4.7.6	EUT OPERATING CONDITIONS	61
4.7.7	TEST RESULTS.....	62
5	PHOTOGRAPHS OF THE TEST CONFIGURATION.....	68
6	INFORMATION ON THE TESTING LABORATORIES	69



1 CERTIFICATION

PRODUCT: WiMAX 802.16e Self-Install Residential Gateway

BRAND NAME: AWB

MODEL NO.: RG230, RG230-2.5-1D, RG230-2.5-1D2V,
RG230-2.5-4D, RG230-2.5-4D2V

APPLICANT: Accton Wireless Broadband Corp.

TESTED: July 09 to 22, 2008

TEST SAMPLE: R&D SAMPLE

TEST STANDARDS: FCC 47 CFR Part 2
FCC 47 CFR Part 27, Subpart C & M
ANSI/TIA/EIA-603-C-2004

The above equipment (Model no.: RG230-2.5-4D2V) has been tested by **Advance Data Technology Corporation**, and found compliance with the requirement of the above standards. The test record, data evaluation & Equipment Under Test (EUT) configurations represented herein are true and accurate accounts of the measurements of the sample's EMC characteristics under the conditions specified in this report.

PREPARED BY : Claire Kuan , **DATE:** Sep. 18, 2008
(Claire Kuan, Specialist)

TECHNICAL ACCEPTANCE : Hank Chung , **DATE:** Sep. 18, 2008
Responsible for RF (Hank Chung, Deputy Manager)

APPROVED BY : May Chen , **DATE:** Sep. 18, 2008
(May Chen, Deputy Manager)

2 SUMMARY OF TEST RESULTS

The EUT has been tested according to the following specifications:

APPLIED STANDARD: FCC Part 27 & Part 2			
STANDARD SECTION	TEST TYPE AND LIMIT	RESULT	REMARK
2.1046 27.50(h)(2)	Maximum Peak Output Power Limit: max. 2 watts conducted peak power	PASS	Meet the requirement of limit.
2.1055 27.54	Frequency Stability Stay with the authorized bands of operation	PASS	Meet the requirement of limit.
2.1049 27.53(m)(6)	Emission Bandwidth	PASS	Meet the requirement of limit.
2.1051 27.53(m)(4)(6)	Band Edge Measurements	PASS	Meet the requirement of limit.
2.1051 27.53(m)(4)(6)	Conducted Spurious Emissions	PASS	Meet the requirement of limit.
2.1053 27.53(m)(4)(6)	Radiated Spurious Emissions	PASS	Meet the requirement of limit.

2.1 MEASUREMENT UNCERTAINTY

Where relevant, the following measurement uncertainty levels have been estimated for tests performed on the EUT as specified in CISPR 16-4:

This uncertainty represents an expanded uncertainty expressed at approximately the 95% confidence level using a coverage factor of $k=2$.

Measurement	Value
Radiated emissions (30MHz-1GHz)	3.94 dB
Radiated emissions (1GHz -18GHz)	2.33 dB
Radiated emissions (18GHz -40GHz)	2.55 dB

3 GENERAL INFORMATION

3.1 GENERAL DESCRIPTION OF EUT

PRODUCT	WiMAX 802.16e Self-Install Residential Gateway
MODEL NO.	RG230, RG230-2.5-1D, RG230-2.5-1D2V, RG230-2.5-4D, RG230-2.5-4D2V
FCC ID	V8YFW181RG25000W
POWER SUPPLY	DC 19V from switching power adapter
MODULATION TECHNOLOGY	OFDMA
MODULATION	QPSK-1/2&-3/4, 16QAM-1/2&3/4, 64QAM-1/2&-2/3&-3/4&-5/6 (64QAM for Rx only)
FREQUENCY RANGE	2505MHz ~ 2685MHz
CHANNEL BANDWIDTH	5MHz&10MHz
MAX. CONDUCTED POWER	5MHz: 23.53dBm 10MHz 23.02dBm
DATA CABLE	NA
I/O PORTS	See note 1 as below
ASSOCIATED DEVICES	NA

NOTE:

1. The EUT has five model names which are identical to each other in all aspects except for the followings:

Model Name	Description
RG230	LAN port x 4 & VOIP port x 2
RG230-2.5-1D	1D: LAN port x 1
RG230-2.5-1D2V	1D2V: LAN port x 1 & VOIP port x 2
RG230-2.5-4D	4D: LAN port x 4
RG230-2.5-4D2V	4D2V: LAN port x 4 & VOIP port x 2

From the above models, model: **RG230-2.5-4D2V** was the worst case and it was selected as representative model for the test and its data was recorded in this report.

2. The EUT must be supplied with a switching power adapter as below:

Brand	Model No.	Spec.
APD	NB-65B19	AC Input: AC 100-240V, 50-60Hz, 1.6A DC Output: DC 19V, 3.42A

3. The device has different DL/UL ration in normal operation, we used continuous mode to test by software, that is worst mode.

4. The above EUT information was declared by manufacturer and for more detailed features description, please refers to the manufacturer's specifications or User's Manual.

3.2 DESCRIPTION OF TEST MODES

Three channels have been tested and presented.

CHANNEL BANDWIDTH: 5MHz&10MHz

Low channel (L): 2505MHz.

Middle channel (M): 2600MHz.

High channel (H): 2685MHz.

3.2.1 TEST MODE APPLICABILITY AND TESTED CHANNEL DETAIL

EUT CONFIGURE MODE	APPLICABLE TO							DESCRIPTION
	OP	FS	EB	CE	CSE	RE<1G	RE ³ 1G	
MODE 1	√	√	√	√	√	√	√	Channel Bandwidth: 5MHz
MODE 2	√	√	√	√	√	√	√	Channel Bandwidth: 10MHz

Where **OP**: Output power **FS**: Frequency stability
EB: Emission bandwidth **CE**: Channel edge
CSE: Conducted spurious emissions **RE<1G**: Radiated emission below 1GHz
RE³1G: Radiated emission above 1GHz

OUTPUT POWER MEASUREMENT:

- Pre-Scan has been conducted to determine the worst-case mode from all possible combinations between available modulations, data rates, and antenna ports (if EUT with antenna diversity architecture).
- Following channel(s) was (were) selected for the final test as listed below.

TESTED CHANNEL	MODULATION TECHNOLOGY	MODULATION TYPE
L, M, H	OFDMA	QPSK

FREQUENCY STABILITY MEASUREMENT:

- Pre-Scan has been conducted to determine the worst-case mode from all possible combinations between available modulations, data rates, and antenna ports (if EUT with antenna diversity architecture).
- Following channel(s) was (were) selected for the final test as listed below.

TESTED CHANNEL	MODULATION TECHNOLOGY	MODULATION TYPE
M	OFDMA	Unmodulation

EMISSION BANDWIDTH MEASUREMENT:

- Pre-Scan has been conducted to determine the worst-case mode from all possible combinations between available modulations, data rates, and antenna ports (if EUT with antenna diversity architecture).
- Following channel(s) was (were) selected for the final test as listed below.

TESTED CHANNEL	MODULATION TECHNOLOGY	MODULATION TYPE
L, M, H	OFDMA	QPSK

CHANNEL EDGE MEASUREMENT:

- Pre-Scan has been conducted to determine the worst-case mode from all possible combinations between available modulations, data rates, and antenna ports (if EUT with antenna diversity architecture).
- Following channel(s) was (were) selected for the final test as listed below.

TESTED MODE	TESTED CHANNEL	MODULATION TECHNOLOGY	MODULATION TYPE
MODE 1	L, M, H	OFDMA	16QAM
MODE 2	L, M, H	OFDMA	QPSK

CONDUCTED SPURIOUS EMISSIONS MEASUREMENT:

- Pre-Scan has been conducted to determine the worst-case mode from all possible combinations between available modulations, data rates, and antenna ports (if EUT with antenna diversity architecture).
- Following channel(s) was (were) selected for the final test as listed below.

TESTED MODE	TESTED CHANNEL	MODULATION TECHNOLOGY	MODULATION TYPE
MODE 1	L, M, H	OFDMA	16QAM
MODE 2	L, M, H	OFDMA	QPSK

RADIATED EMISSION MEASUREMENT (BELOW 1 GHz):

- Pre-Scan has been conducted to determine the worst-case mode from all possible combinations between available modulations, data rates, and antenna ports (if EUT with antenna diversity architecture).
- Following channel(s) was (were) selected for the final test as listed below.

TESTED MODE	TESTED CHANNEL	MODULATION TECHNOLOGY	MODULATION TYPE
MODE 1	L	OFDMA	16QAM
MODE 2	L	OFDMA	QPSK

RADIATED EMISSION MEASUREMENT (ABOVE 1 GHz):

- Pre-Scan has been conducted to determine the worst-case mode from all possible combinations between available modulations, data rates, and antenna ports (if EUT with antenna diversity architecture).
- Following channel(s) was (were) selected for the final test as listed below.

TESTED MODE	TESTED CHANNEL	MODULATION TECHNOLOGY	MODULATION TYPE
MODE 1	L, M, H	OFDMA	16QAM
MODE 2	L, M, H	OFDMA	QPSK

3.3 GENERAL DESCRIPTION OF APPLIED STANDARDS

The EUT is a RF product. According to the specifications of the manufacturer, it must comply with the requirements of the following standards:

FCC 47 CFR Part 2

FCC 47 CFR Part 27, Subpart C & M

ANSI/TIA/EIA-603-C-2004

All test items have been performed and recorded as per the above standards.

NOTE: The EUT is also considered as a kind of computer peripheral, because the connection to computer is necessary for typical use. It has been verified to comply with the requirements of FCC Part 15, Subpart B, Class B (DoC). The test report has been issued separately.

3.4 DESCRIPTION OF SUPPORT UNITS

The EUT has been tested as an independent unit together with other necessary accessories or support units. The following support units or accessories were used to form a representative test configuration during the tests.

NO.	PRODUCT	BRAND	MODEL NO.	SERIAL NO.	FCC ID
1	NOTEBOOK	HP	HSTNN-S19C	JP96X-4Y88K-BXX Y8-K27B3-M86FT	FCC DoC
2	TELEPHONE	CAOKE	TC-203	TC0009793	NA
3	TELEPHONE	CAOKE	TC-203	TC0007452	NA
4	WiMAX Regulatory	Agilent	E4438C	MY45091206	NA
5	Antenna (Horn)	Schwarzbeck	BBHA9120-D1	D124	NA

NO.	SIGNAL CABLE DESCRIPTION OF THE ABOVE SUPPORT UNITS
1	NA
2	1.3 m Non shielded cable, RJ11 connector, w/o core.
3	1.3 m Non shielded cable, RJ11 connector, w/o core.
4	NA
5	NA

NOTE: All power cords of the above support units are non shielded (1.8m).

3.4.1 CONFIGURATION OF SYSTEM UNDER TEST

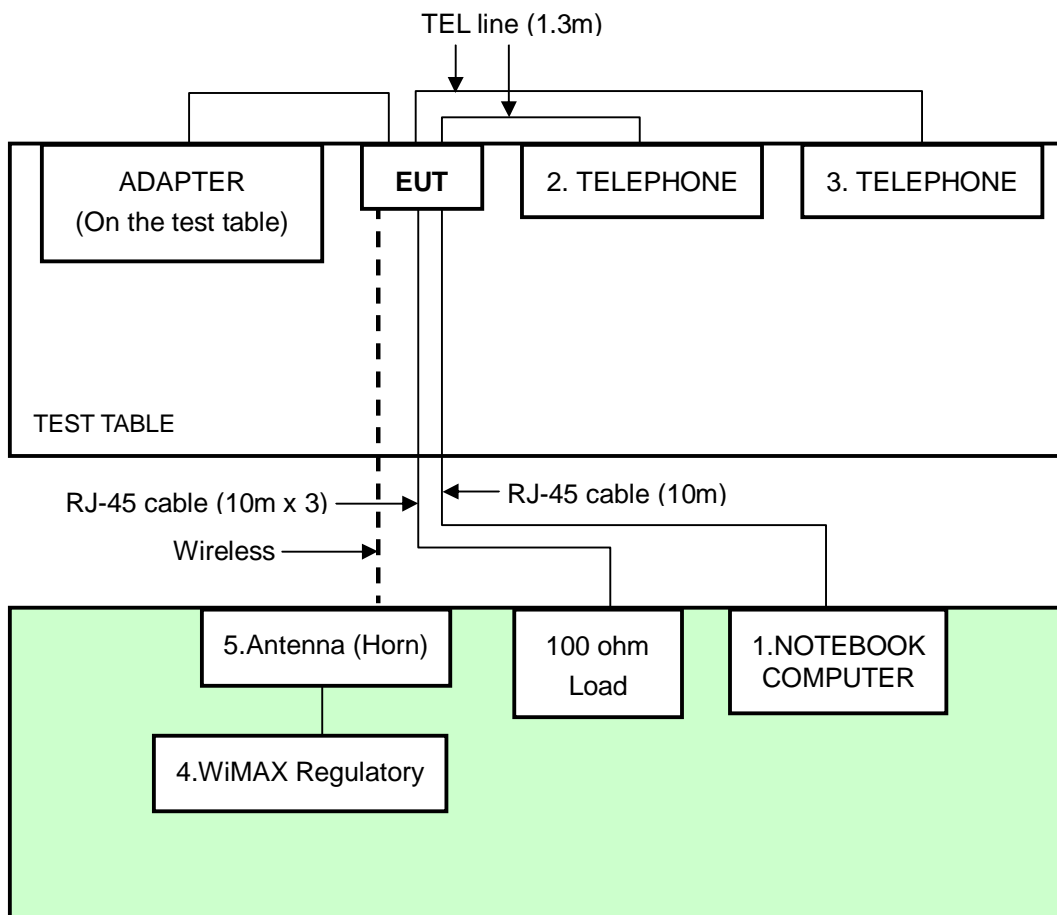

4 TEST TYPES AND RESULTS

4.1 OUTPUT POWER MEASUREMENT

4.1.1 LIMITS OF OUTPUT POWER MEASUREMENT

The radiated peak output power shall be according to the specific rule Part 27.50(h)(2) that "Other User stations are limited to 2 watts and 27.50(i) specific that "Peak transmit power must be measure over any interval of continuous transmission using instrumentation calibration in terms of rms-equivalent voltage."



4.1.2 TEST INSTRUMENTS

Description & Manufacturer	Model No.	Serial No.	Calibrated Until
Agilent Spectrum Analyzer	E4440A	MY46185282	Jun.14, 2009
HUBER+SUHNER	SUCOFLEX104	22076614	Nov. 13, 2008
JFW 10dB attenuation	50HF-010-SMA	N/A	N/A

NOTE:

The calibration interval of the above test instruments is 12 months and the calibrations are traceable to NML/ROC and NIST/USA.

4.1.3 TEST PROCEDURES

For Conducted Power:

- a. Set span to encompass the entire emission bandwidth (EBW) of the signal.
- b. For Channel bandwidth: 5 MHz:
Set RBW=56kHz, VBW=160kHz, Detector mode=RMS.
- c. For Channel bandwidth: 10 MHz:
Set RBW=100kHz, VBW=300kHz, Detector mode=RMS.
- d. Computer power by integrating the spectrum across the 26dB EBW of the signal.
- e. Record the power level.
- f. The “Read Value” is the spectrum reading the maximum power value.

4.1.4 TEST SETUP

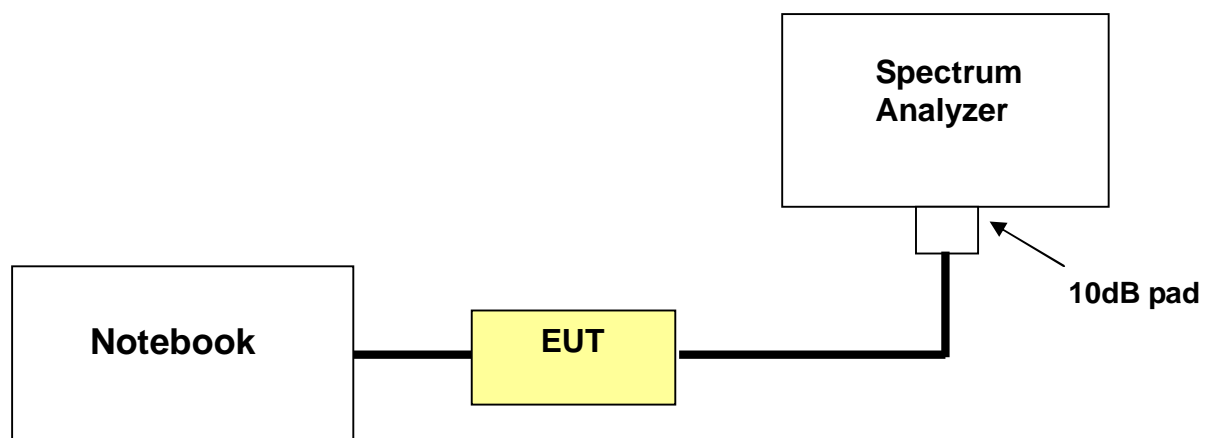

For the actual test configuration, please refer to the related item – Photographs of the Test Configuration.

4.1.5 EUT OPERATING CONDITIONS

- a. The Notebook controlled EUT to export rated output power under transmission mode and specific channel frequency.
- b. All telephones are calling to each other via EUT.



4.1.6 TEST RESULTS

CHANNEL BANDWIDTH: 5MHz

INPUT POWER (SYSTEM)	120Vac, 60Hz	DETECTOR FUNCTION	RMS
ENVIRONMENTAL CONDITIONS	20deg°C, 60%RH 960hPa	TESTED BY	Wen Yu

CONDUCTED POWER			
CHANNEL	FREQUENCY (MHz)	PEAK POWER OUTPUT(mW)	PEAK POWER OUTPUT(dBm)
Low	2505	219.280	23.41
Middle	2600	217.771	23.38
High	2685	225.424	23.53

LOW CHANNEL

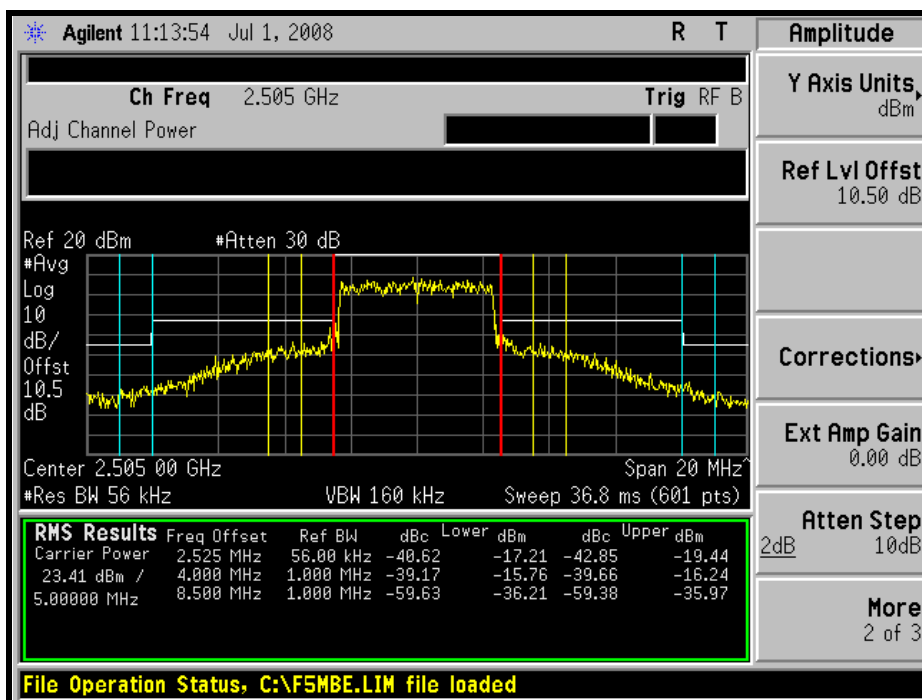

MIDDLE CHANNEL

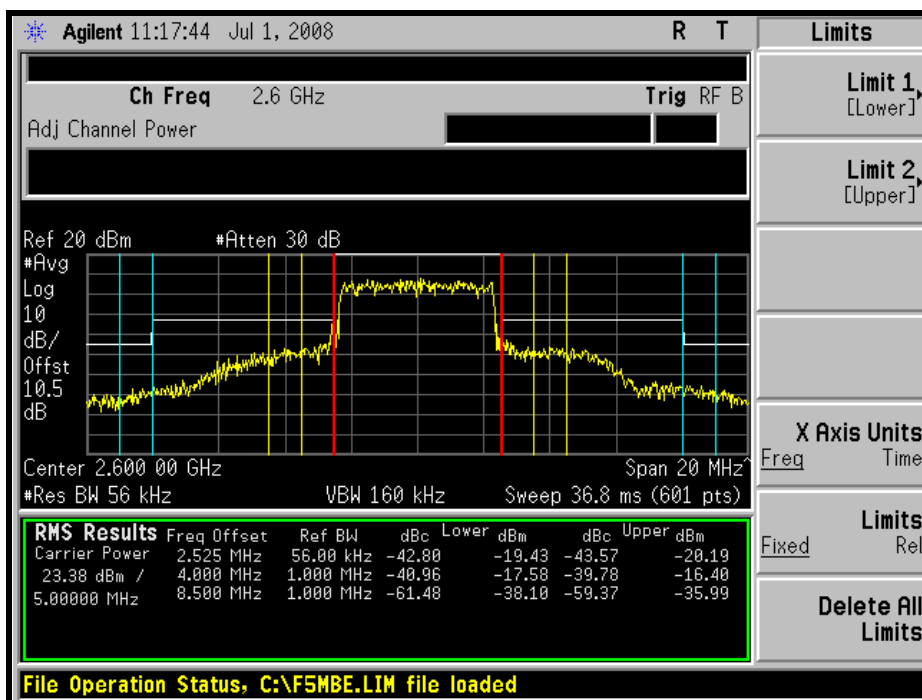

HIGH CHANNEL

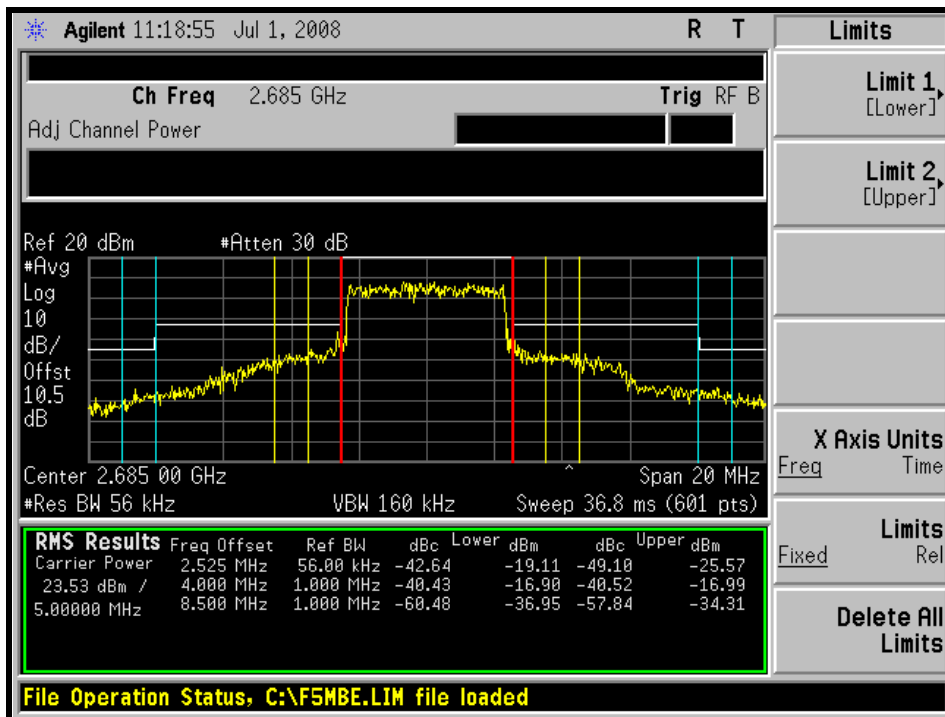



CHANNEL BANDWIDTH: 10MHz

INPUT POWER (SYSTEM)	120Vac, 60Hz	DETECTOR FUNCTION	RMS
ENVIRONMENTAL CONDITIONS	20deg°C, 60%RH 960hPa	TESTED BY	Wen Yu

CONDUCTED POWER			
CHANNEL	FREQUENCY (MHz)	PEAK POWER OUTPUT(mW)	PEAK POWER OUTPUT(dBm)
Low	2505	177.011	22.48
Middle	2600	200.447	23.02
High	2685	195.434	22.91

LOW CHANNEL

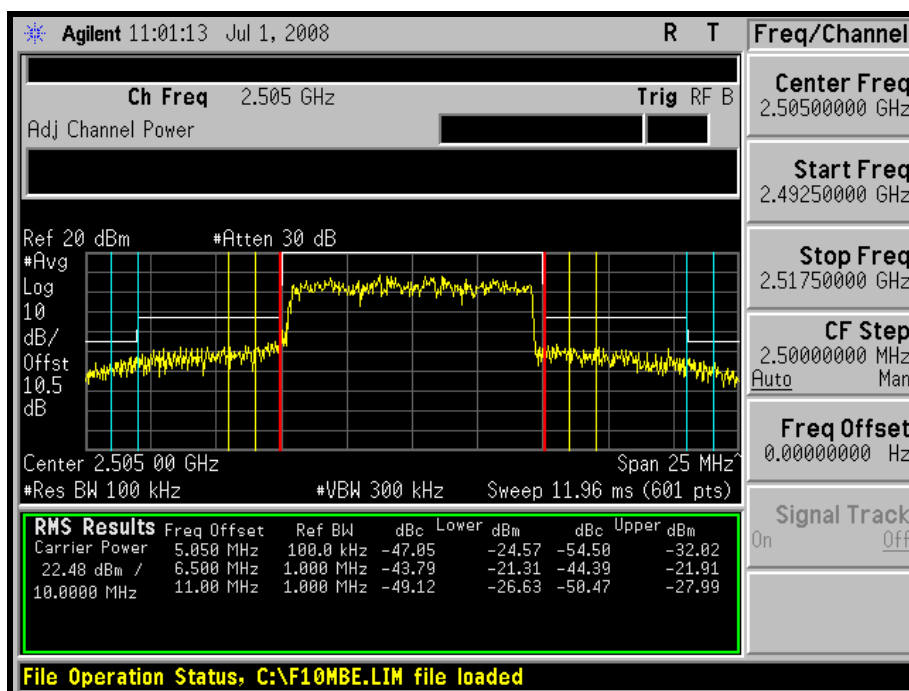

MIDDLE CHANNEL

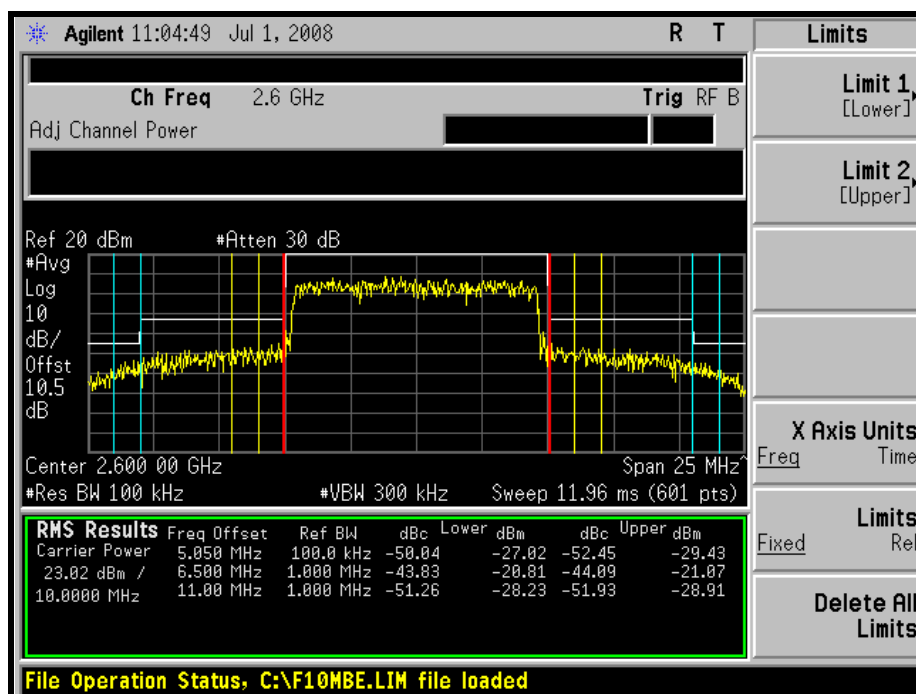

HIGH CHANNEL

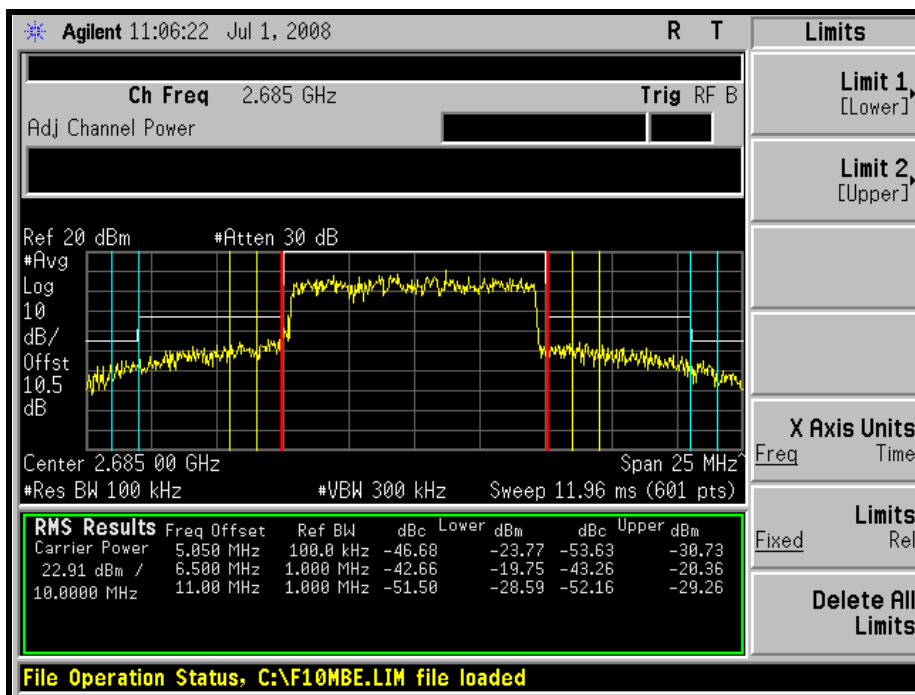



4.2 FREQUENCY STABILITY MEASUREMENT

4.2.1 LIMITS OF FREQUENCY STABILITY MEASUREMENT

According to the FCC part 2.1055 shall be tested the frequency stability. The rule is defined that "The frequency stability shall be sufficient to ensure that the fundamental emission stays within the authorized frequency block." The test extreme voltage is according to the 2.1055(d)(1) Vary primary supply voltage from 85 to 115 percent of the nominal value for other than hand carried battery equipment and the extreme temperature rule is comply with specification of EUT $-30^{\circ}\text{C} \sim 50^{\circ}\text{C}$.

4.2.2 TEST INSTRUMENTS

DESCRIPTION & MANUFACTURER	MODEL NO.	SERIAL NO.	CALIBRATED UNTIL
R&S SPECTRUM ANALYZER	FSP40	100037	Aug. 12, 2008
OVEN	MHU-225AU	911033	Dec. 04, 2008
HUBER+SUHNER	SUCOFLEX104	22076614	Nov. 13, 2008
AC POWER SOURCE	6205	1140503	N/A

NOTE: 1. The calibration interval of the above test instruments is 12 months. And the calibrations are traceable to NML/ROC and NIST/USA.

4.2.3 TEST PROCEDURE

- a. Power must be removed when changing from one temperature to another or one voltage to another voltage. Power warm up is at least 15 min and power applied should perform before recording frequency error.
- b. EUT is connected the external power supply to control the DC input power. The various Volts from the minimum 102 Volts to 138 Volts. Each step shall be record the frequency error rate.
- c. The temperature range step is 10 degrees in this test items. All temperature levels shall be hold the $\pm 0.5^{\circ}\text{C}$ during the measurement testing.
- d. The each temperature step shall be at least 0.5 hours, consider the EUT could be test under the stability condition.

4.2.4 TEST SETUP

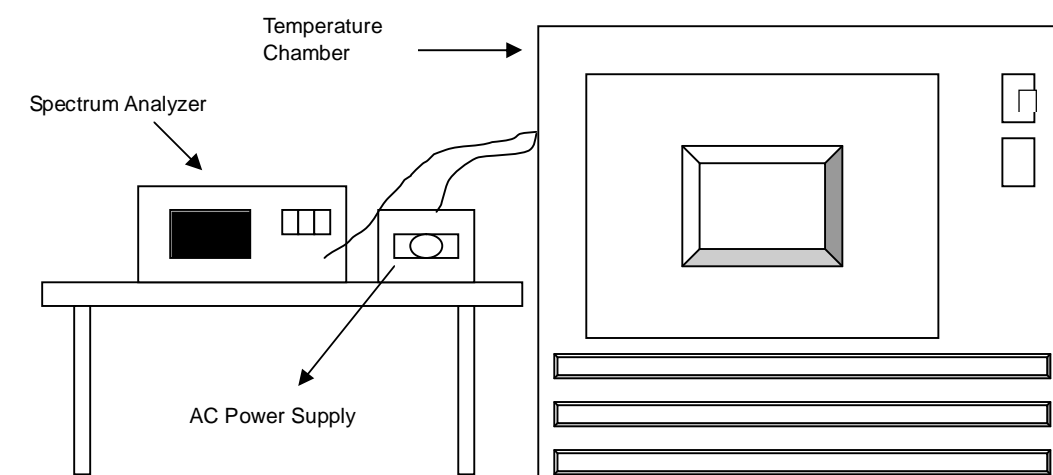



4.2.5 TEST RESULTS

MODE	Middle channel (2600MHz)	INPUT POWER (SYSTEM)	120Vac, 60Hz
ENVIRONMENTAL CONDITIONS	20deg°C, 60%RH 960hPa	TESTED BY	Wen Yu

AFC FREQUENCY ERROR VS. VOLTAGE		
VOLTAGE (Volts)	FREQUENCY (MHz)	FREQUENCY DRIFT (ppm)
138	2599.9925	0.000288
120	2599.9929	0.000273
102	2599.9921	0.000304



MODE	Middle channel (2600MHz)	INPUT POWER (SYSTEM)	120Vac, 60Hz
ENVIRONMENTAL CONDITIONS	20deg°C, 60%RH 960hPa	TESTED BY	Wen Yu

AFC FREQUENCY ERROR VS. TEMP.		
TEMP. (°C)	FREQUENCY (MHz)	FREQUENCY DRIFT (ppm)
55	2599.9807	0.000742
40	2599.9848	0.000585
30	2599.9914	0.000331
20	2599.9929	0.000273
10	2599.9974	0.000100
0	2599.9987	0.000050
-10	2600.0049	0.000188
-20	2600.0123	0.000473
-30	2600.0159	0.000612

4.3 EMISSION BANDWIDTH MEASUREMENT

4.3.1 LIMITS OF EMISSION BANDWIDTH MEASUREMENT

According to FCC 27.53(m)(6) specified that emission bandwidth is defined as the width of the signal between two points, one below the carrier center frequency and one above the carrier center frequency, outside of which all emissions are attenuated at least 26dB below the transmitter power.

4.3.2 TEST INSTRUMENTS

DESCRIPTION & MANUFACTURER	MODEL NO.	SERIAL NO.	CALIBRATED UNTIL
Agilent Spectrum Analyzer	E4440A	MY46185282	Jun.14, 2009
HUBER+SUHNER	SUCOFLEX104	22076614	Nov. 13, 2008
JFW 10dB attenuation	50HF-010-SMA	NA	NA

NOTE: 1. The calibration interval of the above test instruments is 12 months. And the calibrations are traceable to NML/ROC and NIST/USA.

4.3.3 TEST SETUP

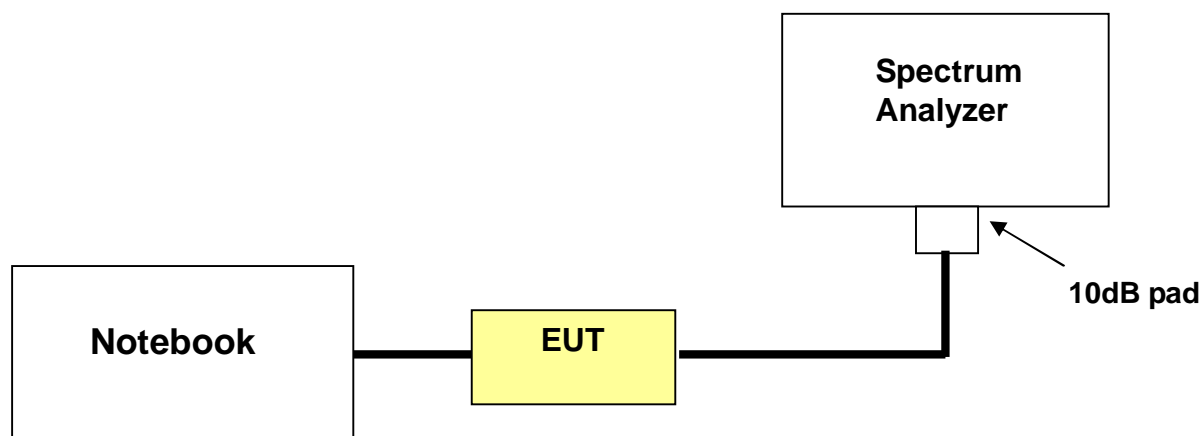

4.3.4 TEST PROCEDURES

- a. The Notebook controlled EUT to export rated output power under transmission mode and specific channel frequency. The bandwidth of the fundamental frequency was measured by spectrum analyzer with 100kHz RBW and 300kHz VBW. The 26dB bandwidth is define as the total spectrum the power of which is higher than peak power minus 26dB.

4.3.5 TEST RESULTS

CHANNEL BANDWIDTH: 5MHz

FREQUENCY (MHz)	-26 dBc BANDWIDTH (MHz)
2505	5.396
2600	5.399
2685	5.404

LOW CHANNEL

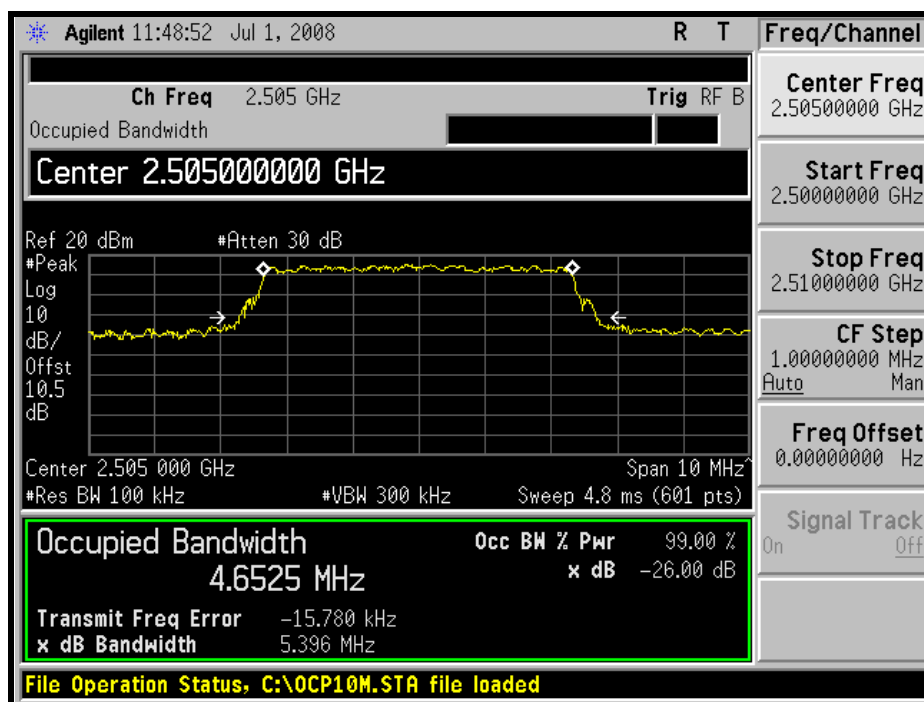

MIDDLE CHANNEL

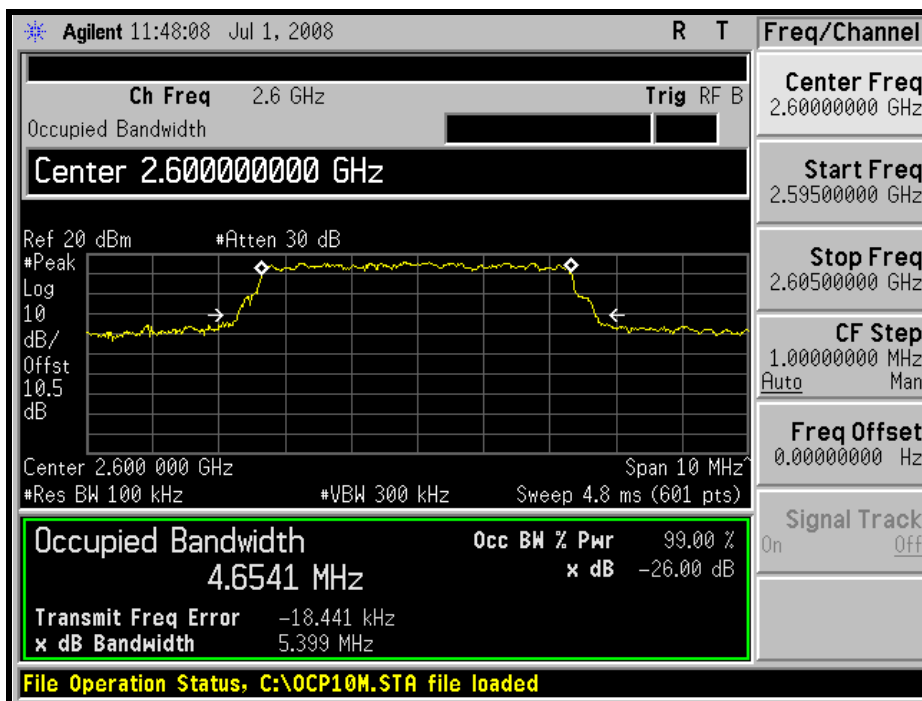

HIGH CHANNEL

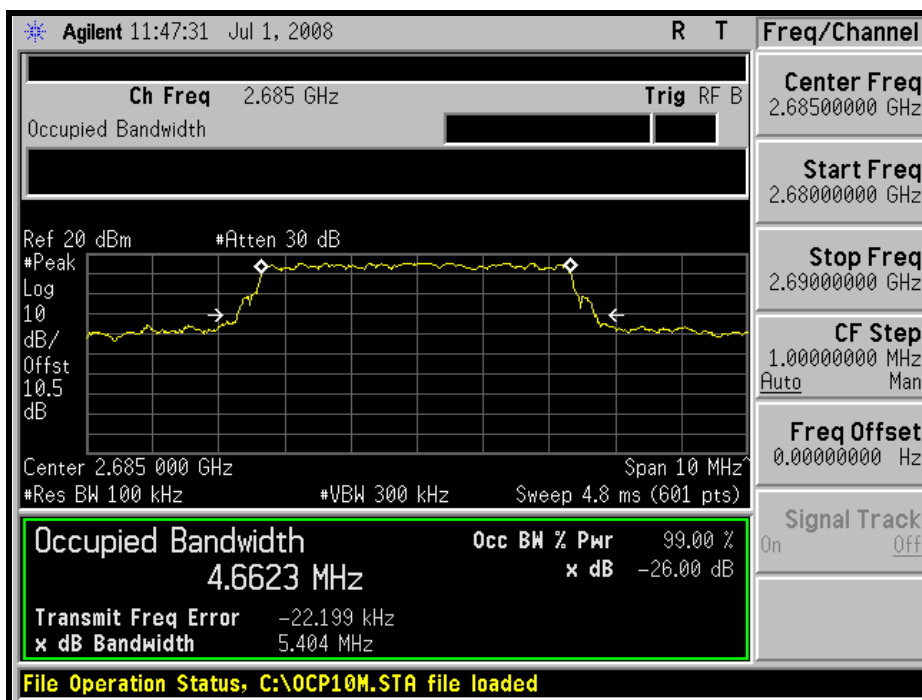

CHANNEL BANDWIDTH: 10MHz

FREQUENCY (MHz)	-26 dBc BANDWIDTH (MHz)
2505	9.789
2600	9.789
2685	9.877

LOW CHANNEL

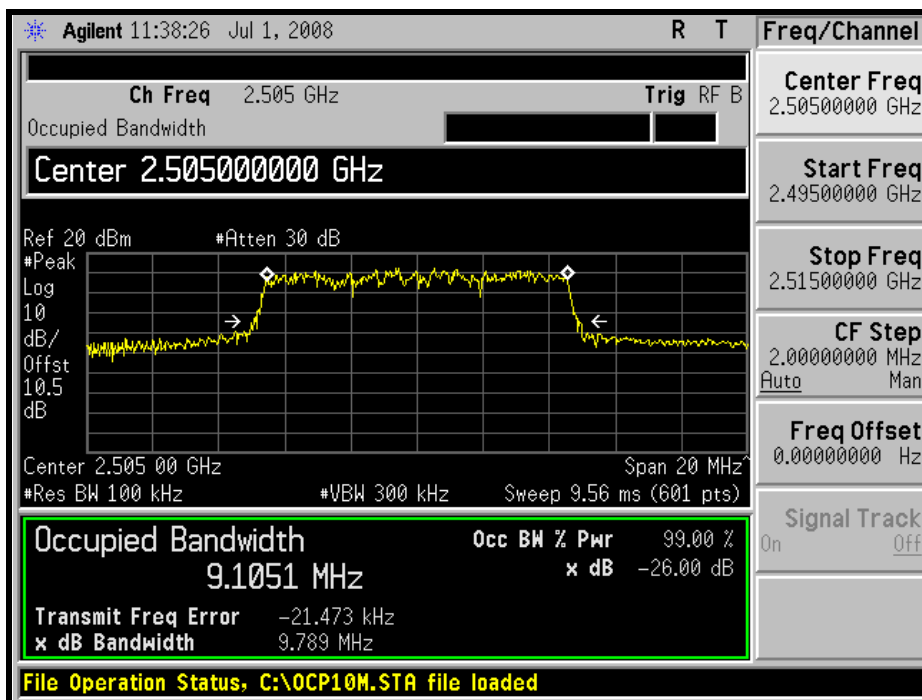

MIDDLE CHANNEL

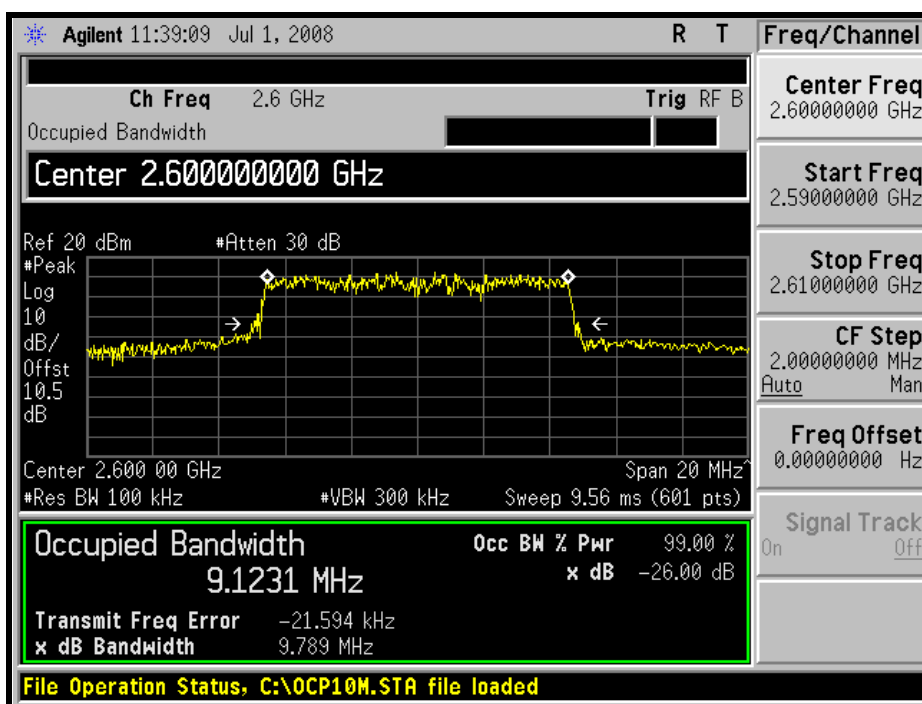

HIGH CHANNEL

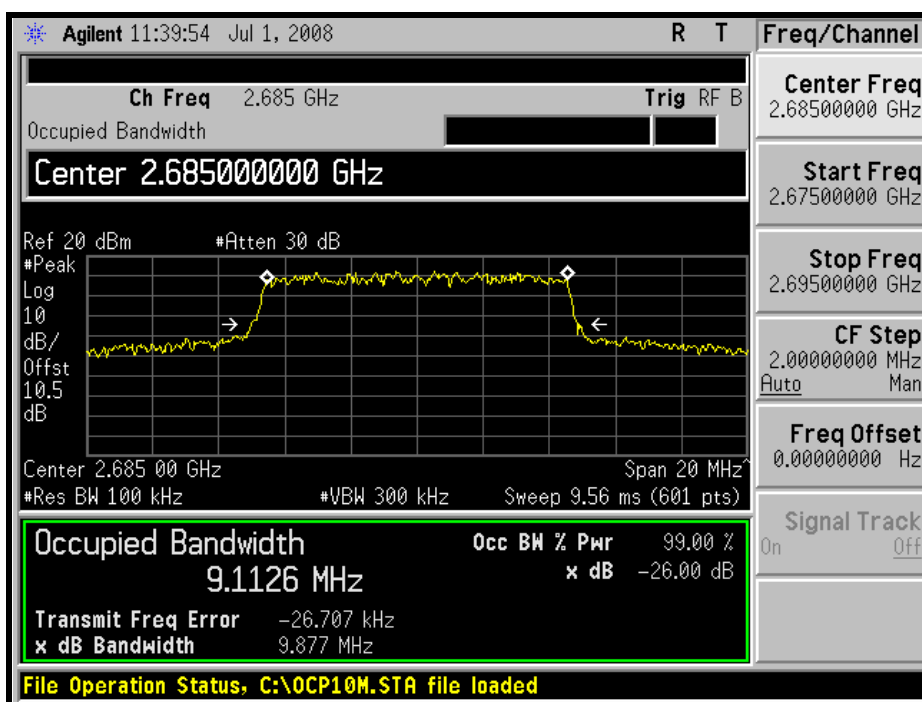



4.4 CHANNEL EDGE MEASUREMENT

4.4.1 LIMITS OF CHANNEL EDGE MEASUREMENT

According to FCC 27.53(m)(4) specified that power of any emission outside of the channel edge must be attenuated below the transmitting power (P) by a factor of at least $43 + 10 \log(P)$ dB and $55 + 10 \log(P)$ dB at 5.5 MHz from the channel edges. In the 1MHz bands immediately outside and adjacent to the frequency block a resolution bandwidth of at least one percent of the emission bandwidth of the fundamental emission of the transmitter may be employed.

4.4.2 TEST INSTRUMENTS

DESCRIPTION & MANUFACTURER	MODEL NO.	SERIAL NO.	CALIBRATED UNTIL
Agilent Spectrum Analyzer	E4440A	MY46185282	Jun.14, 2009
HUBER+SUHNER	SUCOFLEX104	22076614	Nov. 13, 2008
JFW 10dB attenuation	50HF-010-SMA	NA	NA

NOTE: 1. The calibration interval of the above test instruments is 12 months. And the calibrations are traceable to NML/ROC and NIST/USA.

4.4.3 TEST SETUP

Same as Item 4.3.3

4.4.4 TEST PROCEDURES

- a. The EUT was set up for the rated peak power . The power was measured with Spectrum Analyzer. All measurements were done at 3 channels: low, middle and high operational frequency range.
- b. For Channel bandwidth: 5 MHz:
The center frequency of spectrum is the band edge frequency and span is 20MHz. RB of the spectrum is 56kHz and VB of the spectrum is 160kHz.
- c. For Channel bandwidth: 10 MHz:
The center frequency of spectrum is the band edge frequency and span is 25MHz. RB of the spectrum is 100kHz and VB of the spectrum is 300kHz.
- d. Record the max trace plot into the test report.

4.4.5 EUT OPERATING CONDITION

- a. The Notebook controlled EUT to export rated output power under transmission mode and specific channel frequency.
- b. All telephones are calling to each other via EUT.

4.4.6 TEST RESULTS

CHANNEL BANDWIDTH: 5MHz

LOW CHANNEL

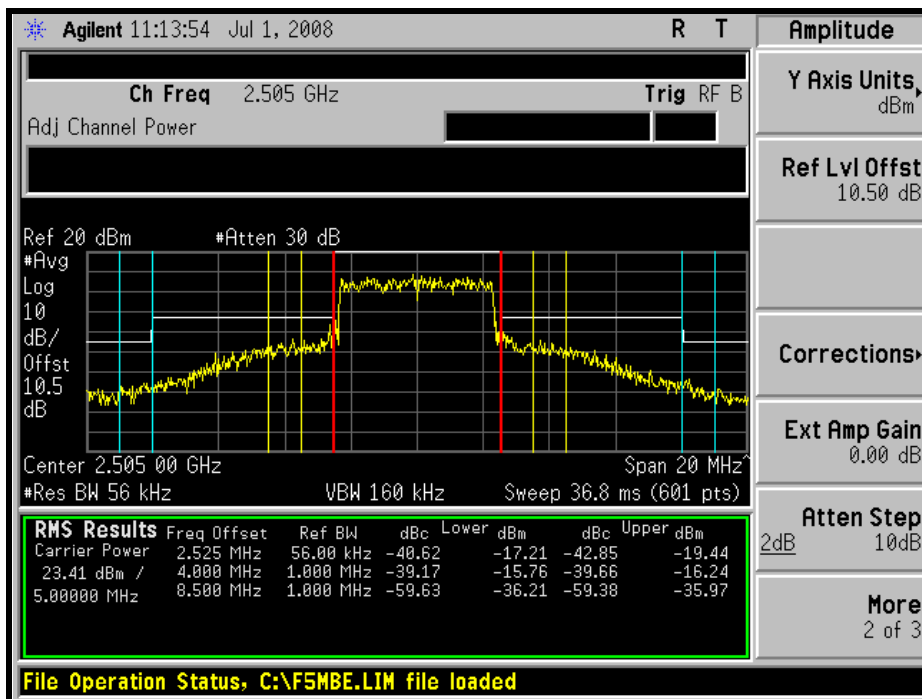

MIDDLE CHANNEL

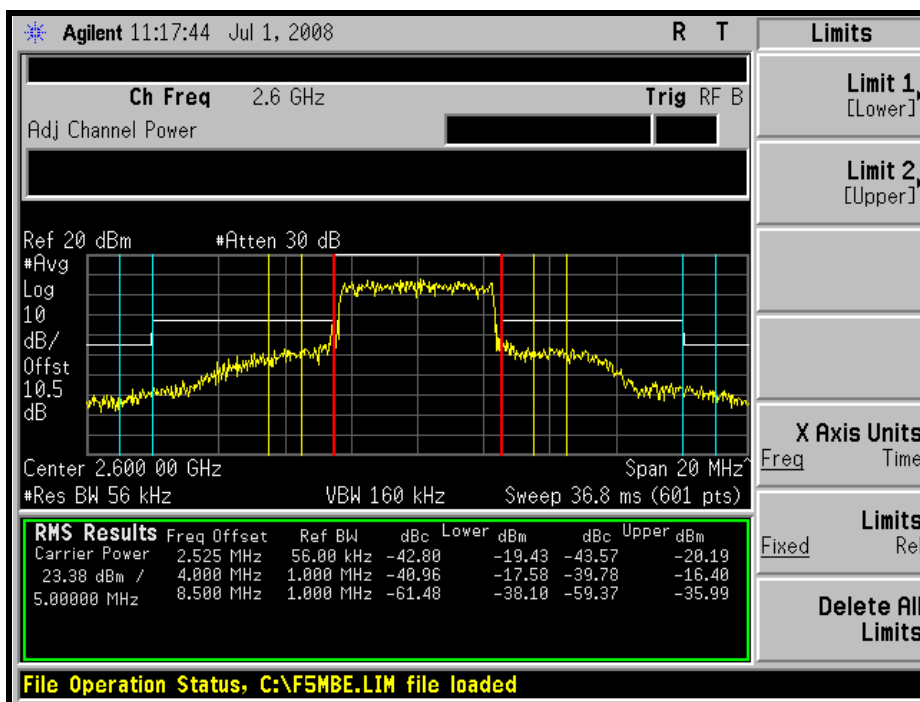

HIGH CHANNEL

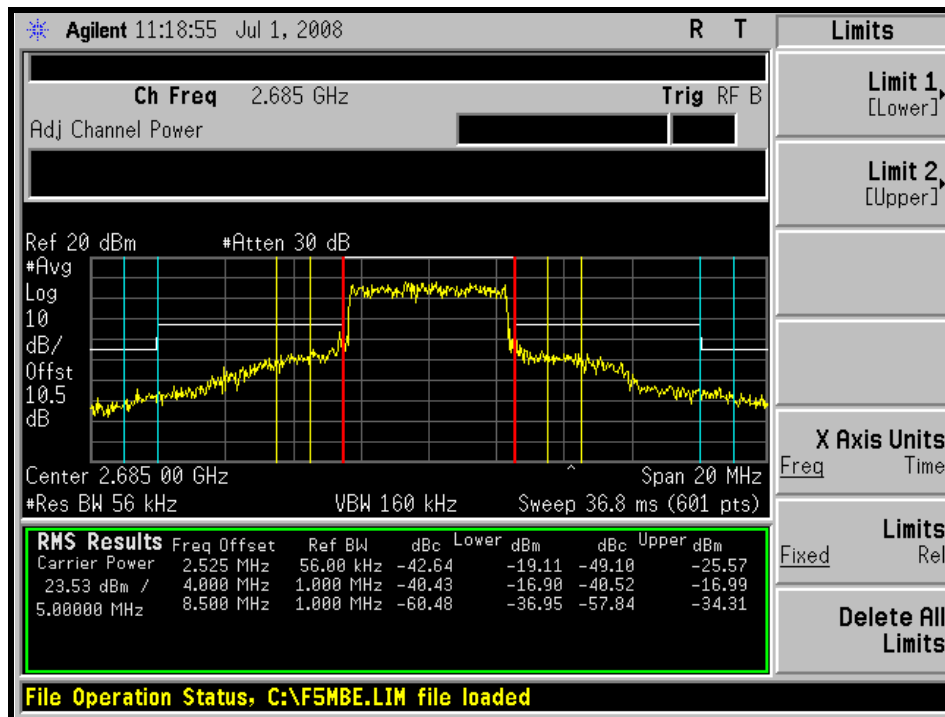

CHANNEL BANDWIDTH: 10MHz

LOW CHANNEL

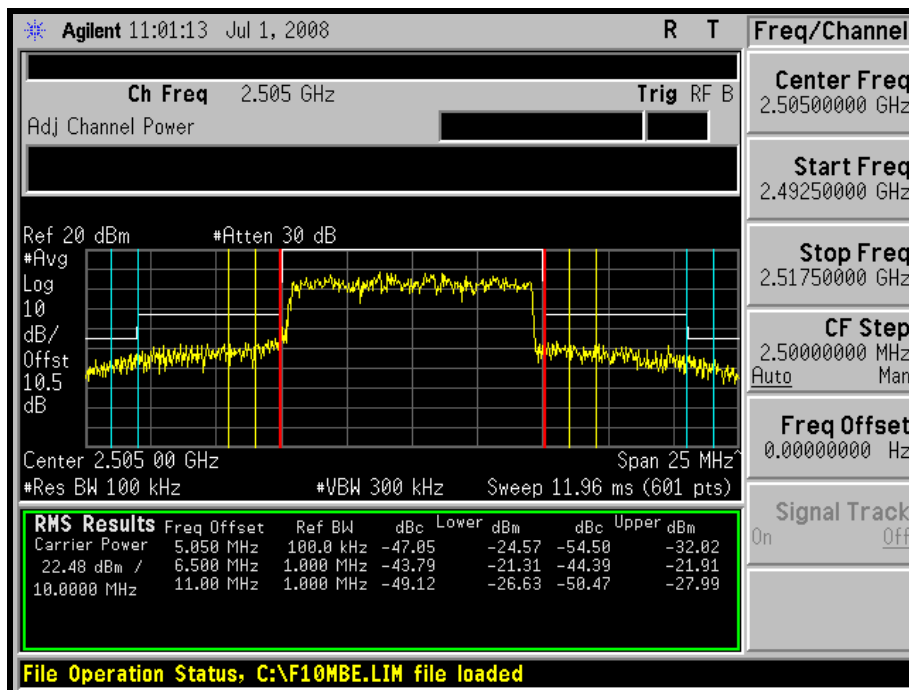

MIDDLE CHANNEL

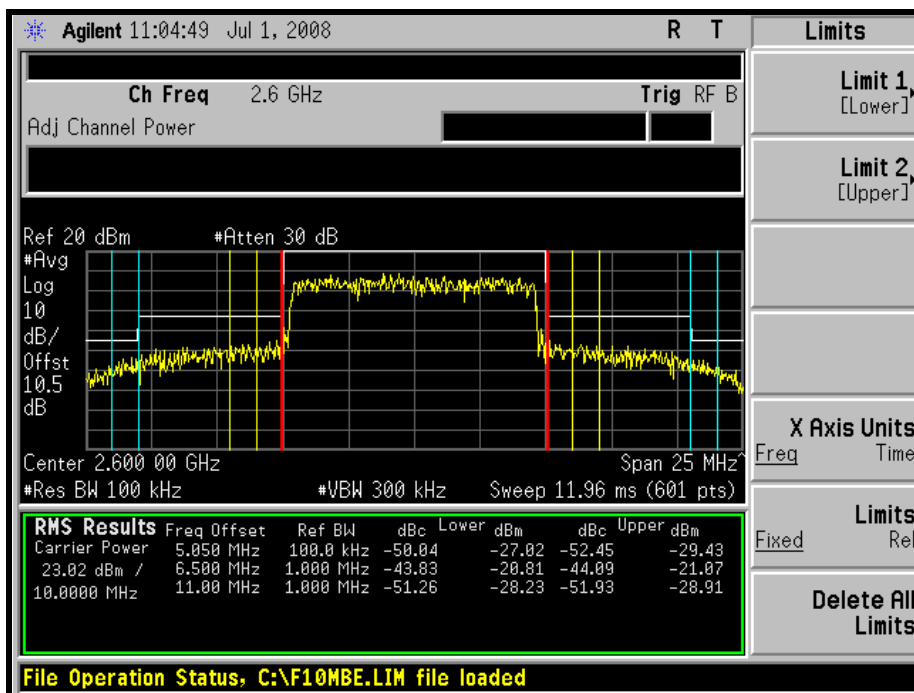

HIGH CHANNEL

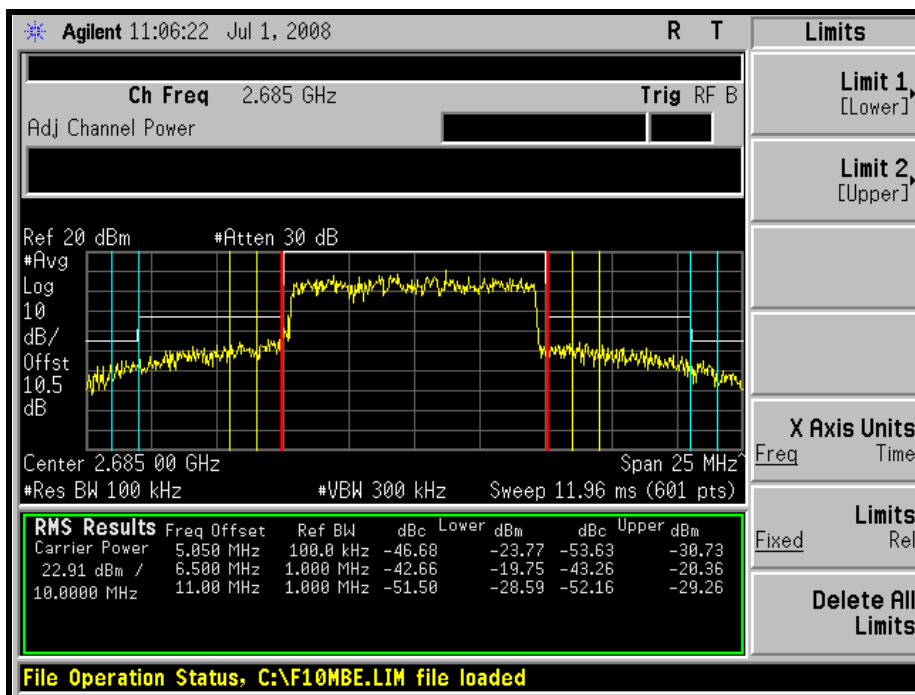



4.5 CONDUCTED SPURIOUS EMISSIONS

4.5.1 LIMITS OF CONDUCTED SPURIOUS EMISSIONS MEASUREMENT

In the FCC 27.53(m)(4), On any frequency outside a licensee's frequency block, the power of any emission shall be attenuated below the transmitter power (P) by at least $43 + 10 \log (P)$ dB and $55 + 10 \log (P)$ dB at 5.5 MHz from the channel edges.

4.5.2 TEST INSTRUMENTS

DESCRIPTION & MANUFACTURER	MODEL NO.	SERIAL NO.	CALIBRATED UNTIL
Agilent Spectrum Analyzer	E4440A	MY46185282	Jun.14, 2009
HUBER+SUHNER	SUCOFLEX104	22076614	Nov. 13, 2008
JFW 10dB attenuation	50HF-010-SMA	NA	NA
Wainwright Instruments High Pass Filter	WHK3.1/18G-10SS	ZZ-010091	NA

NOTE: 1. The calibration interval of the above test instruments is 12 months. And the calibrations are traceable to NML/ROC and NIST/USA.

4.5.3 TEST PROCEDURE

- a. The EUT was set up for the rated peak power. The power was measured with Spectrum Analyzer. All measurements were done at 3 channels: low, middle and high operational frequency range.
- b. When the spectrum scanned from 30MHz to 3GHz, it shall be connected to the 10dB pad attenuated the carried frequency. The spectrum set RB = 1MHz, VB = 3MHz.
- c. When the spectrum scanned from 3GHz to 26.5GHz, it shall be connected to the high pass filter attenuated the carried frequency. The spectrum set RB = 1MHz, VB = 3MHz.

4.5.4 TEST SETUP

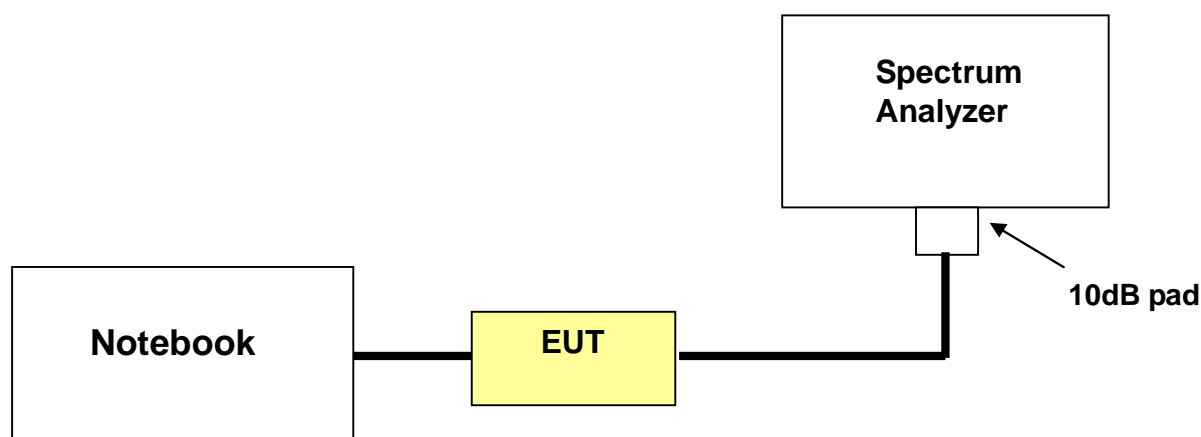

4.5.5 EUT OPERATING CONDITIONS

- a. The Notebook controlled EUT to export rated output power under transmission mode and specific channel frequency.
- b. All telephones are calling to each other via EUT.

4.5.6 TEST RESULTS

CHANNEL BANDWIDTH: 5MHz

LOW CHANNEL: 30MHz ~ 1GHz:

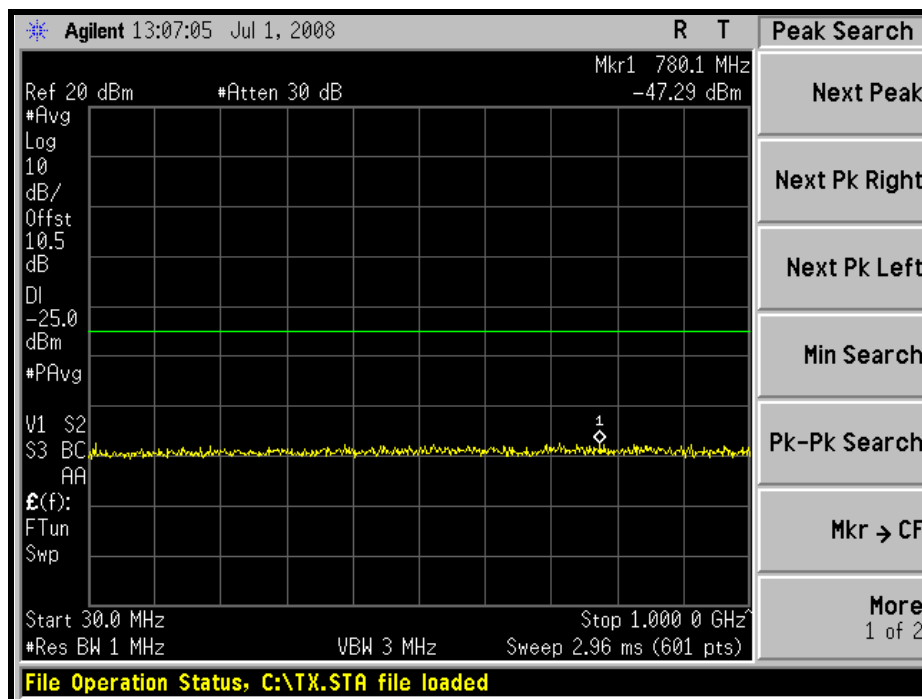

1GHz ~ 5GHz:

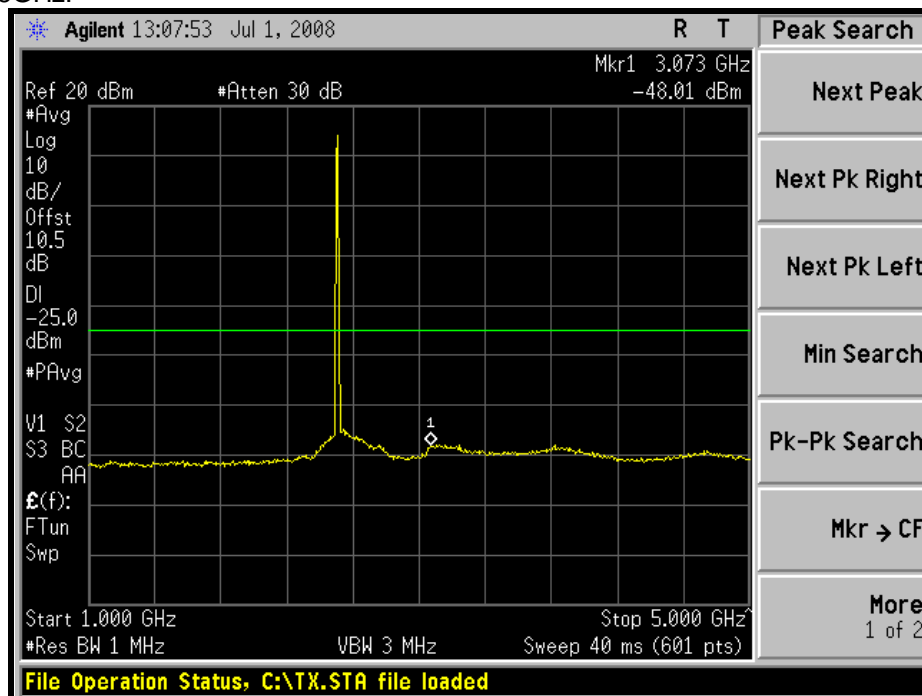

5GHz ~ 10GHz:

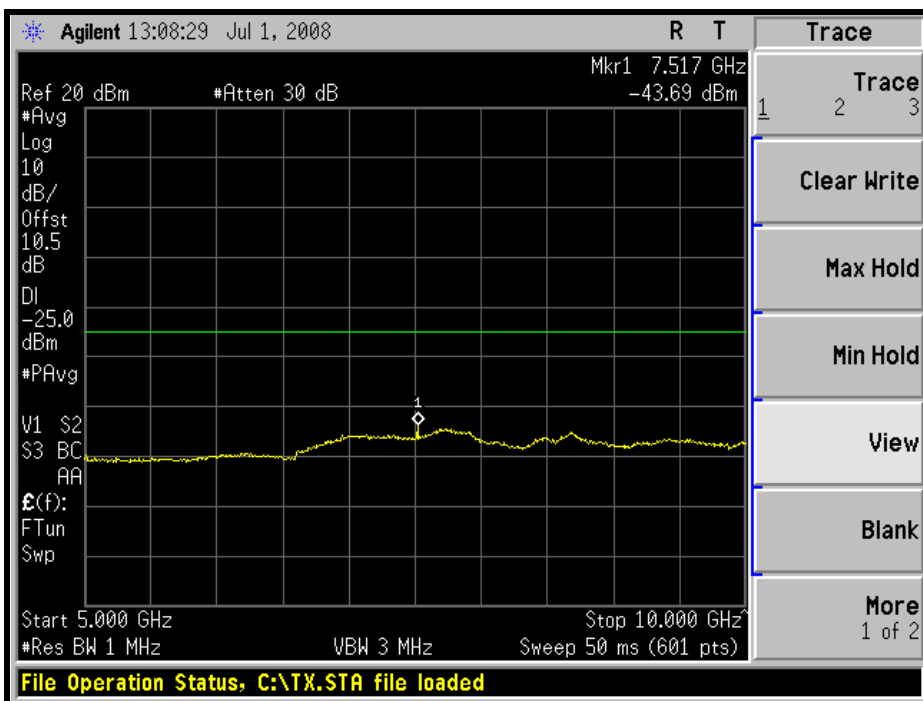

10GHz ~ 26.5GHz:

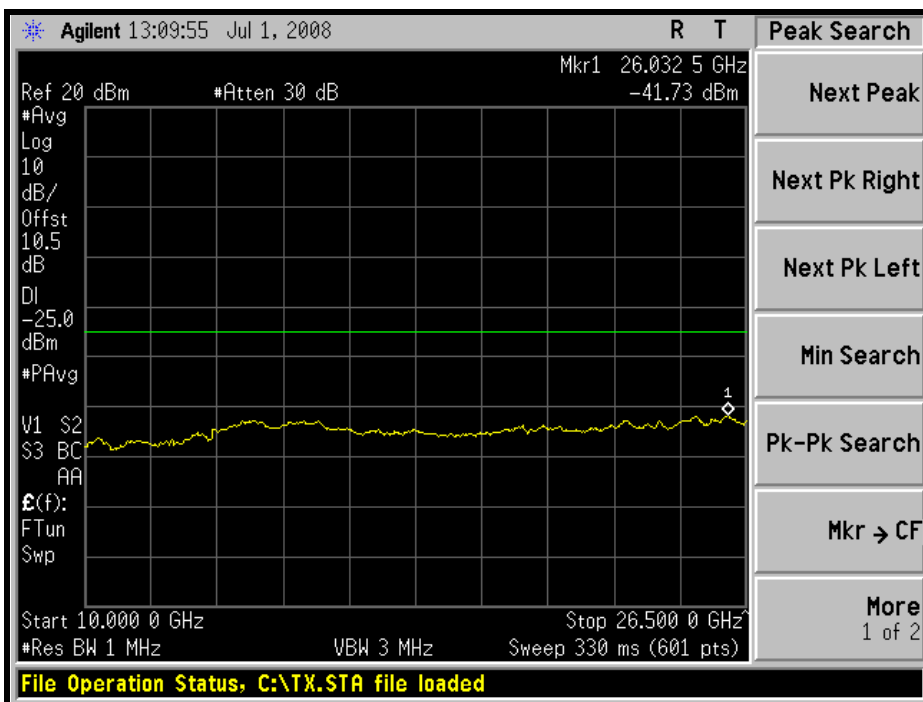

MIDDLE CHANNEL: 30MHz ~ 1GHz:

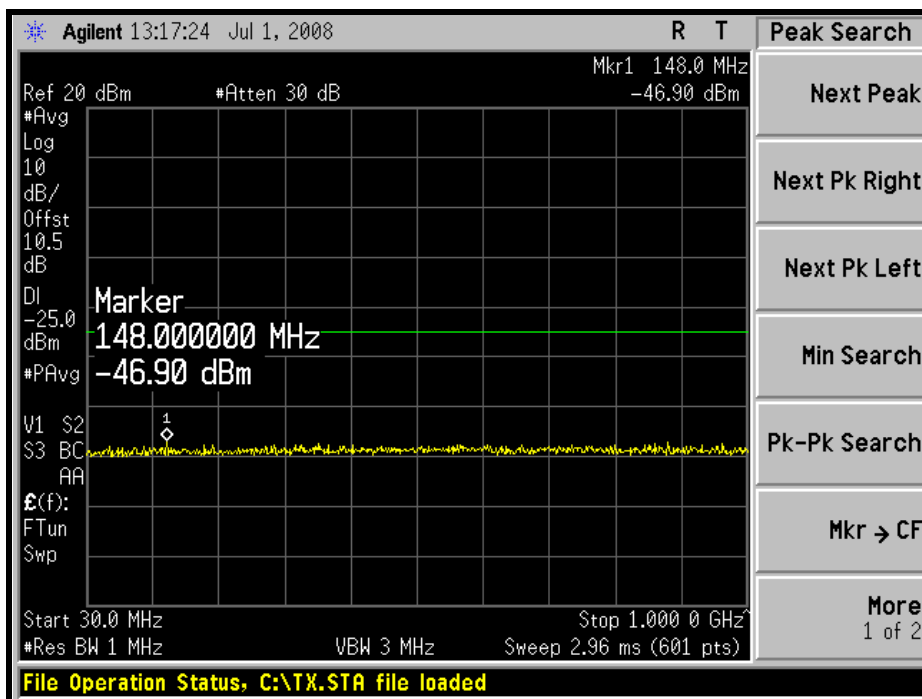

1GHz ~ 5GHz:

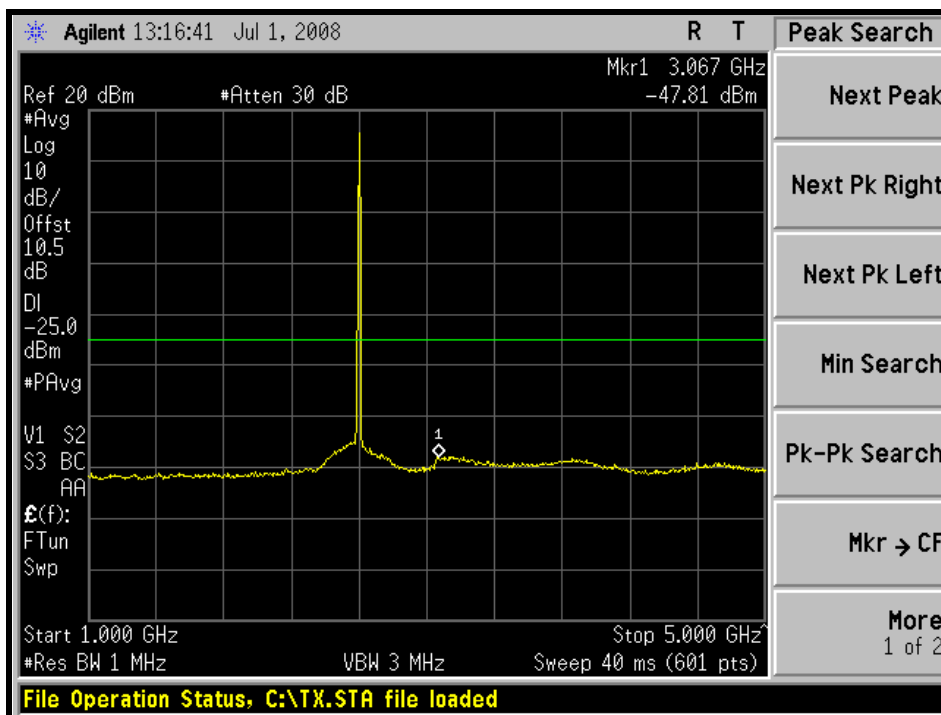

5GHz ~ 10GHz:

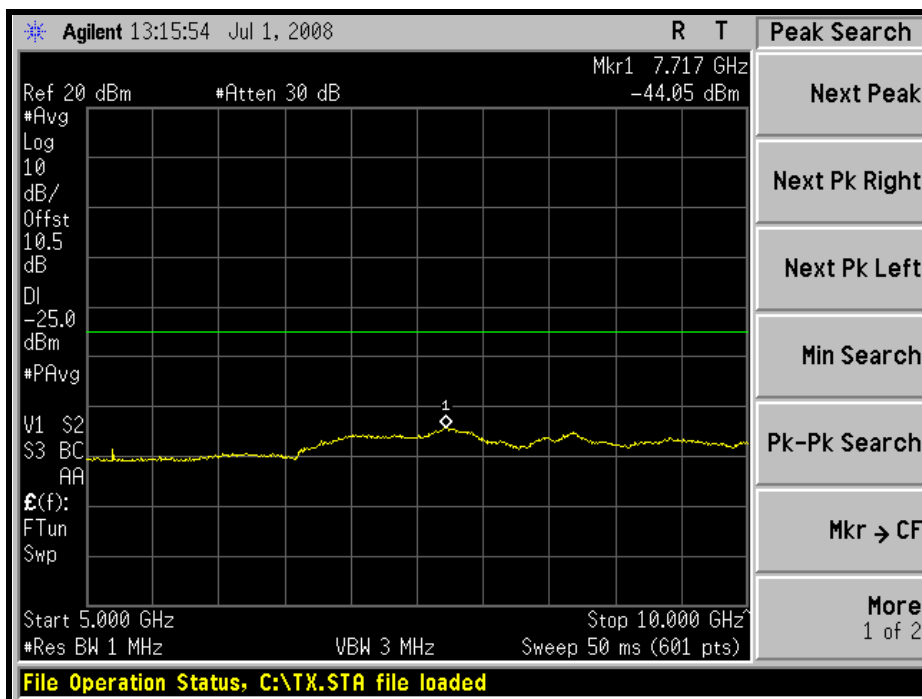

10GHz ~ 26.5GHz:

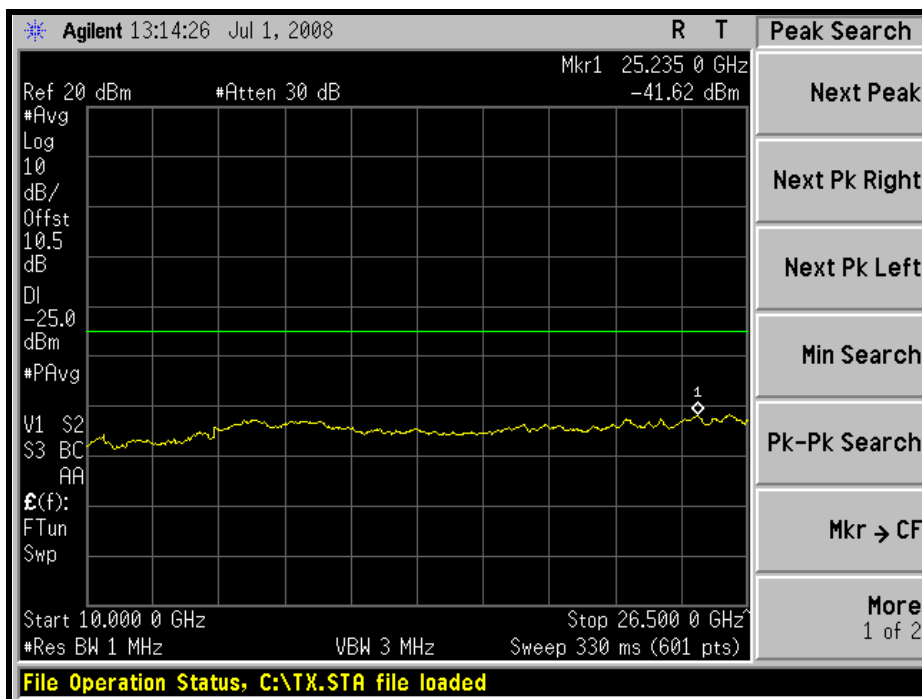

HIGH CHANNEL: 30MHz ~ 1GHz:

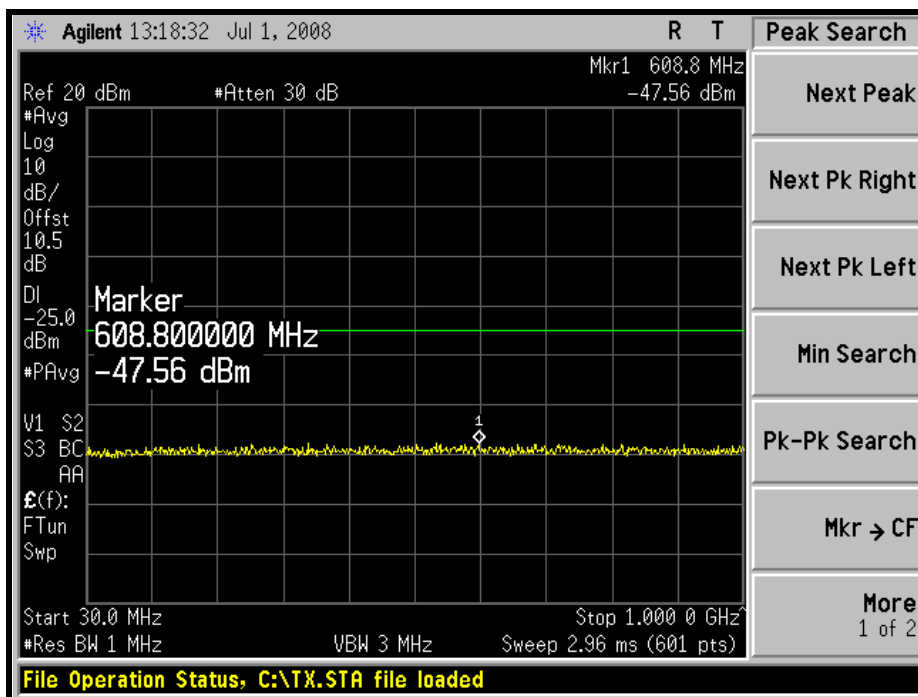

1GHz ~ 5GHz:

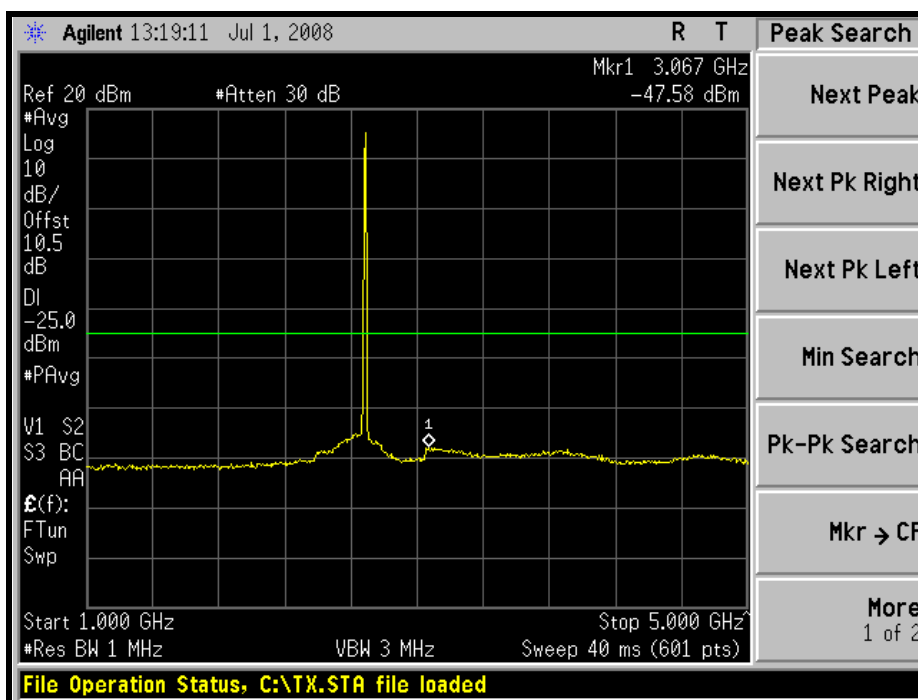

5GHz ~ 10GHz:

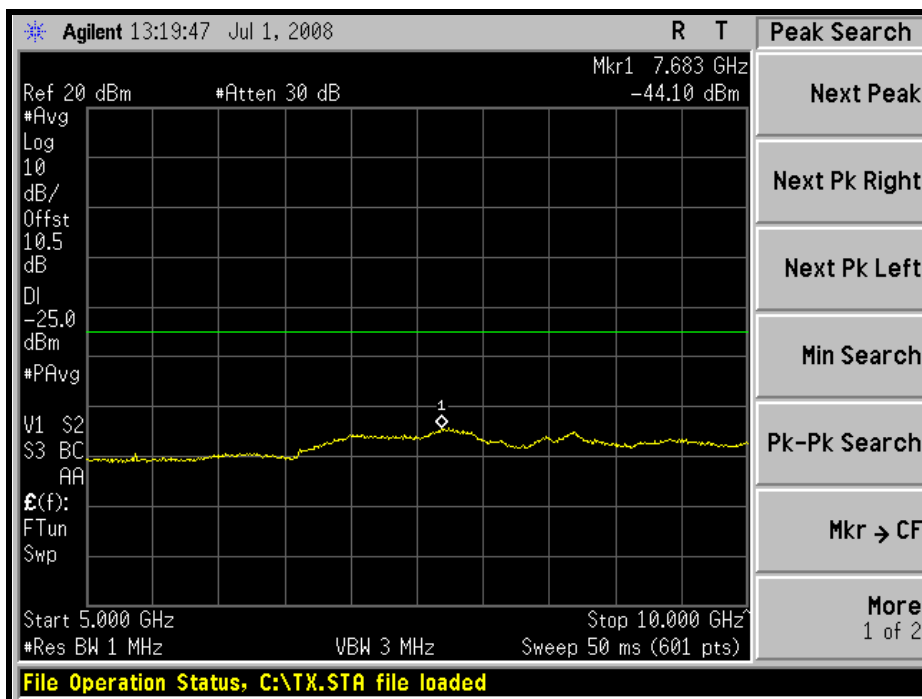

10GHz ~ 26.5GHz:

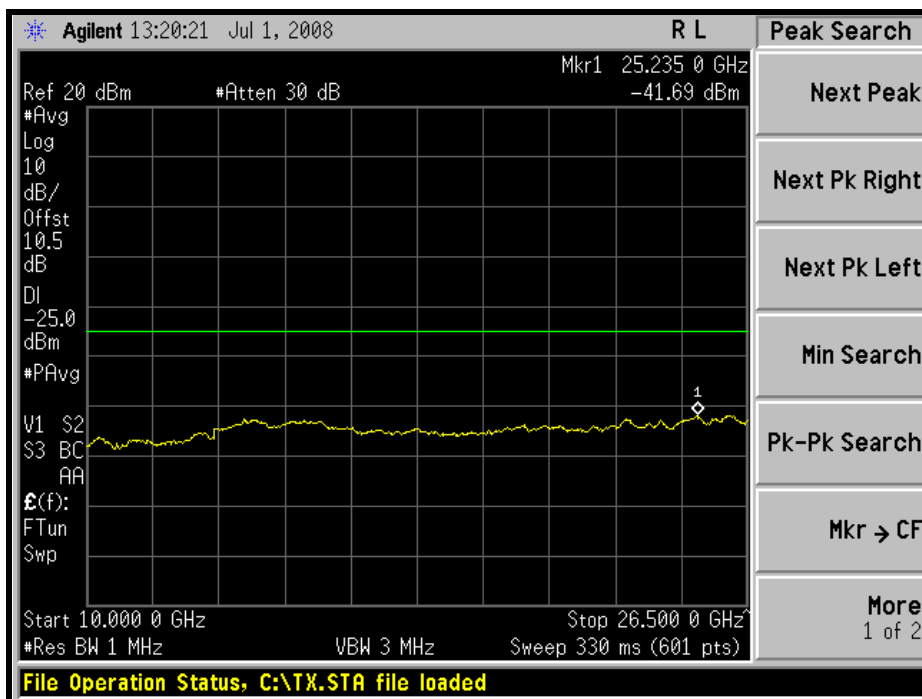

CHANNEL BANDWIDTH: 10MHz
LOW CHANNEL: 30MHz ~ 1GHz:

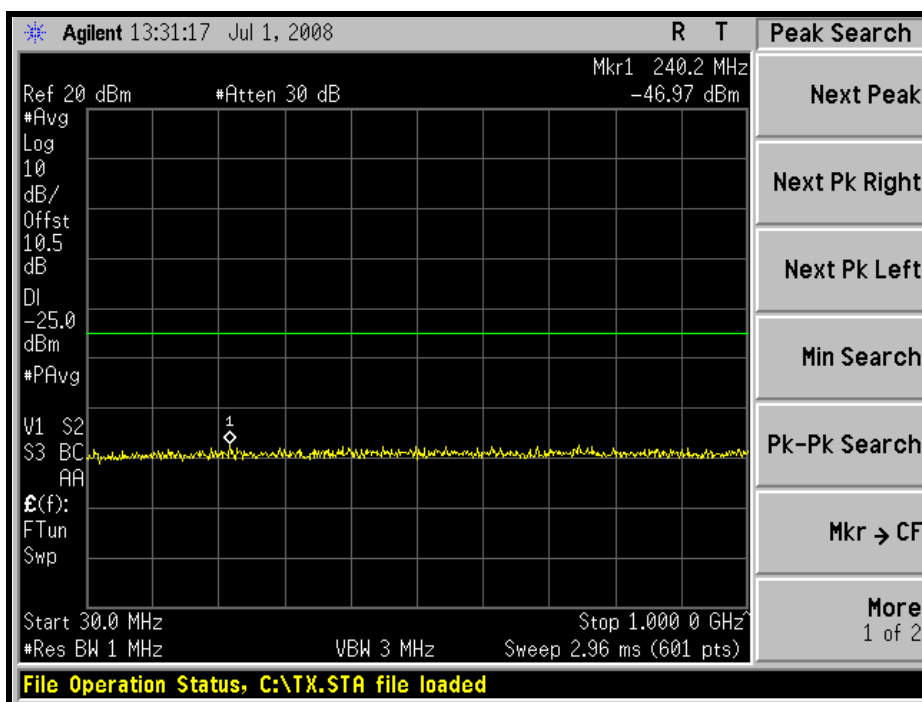

1GHz ~ 5GHz:

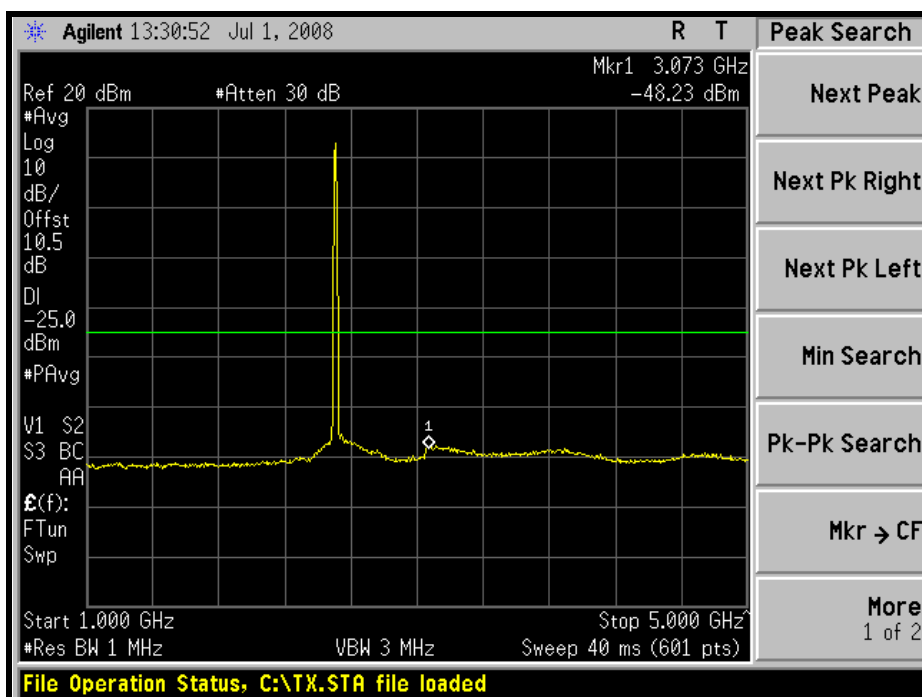

5GHz ~ 10GHz:

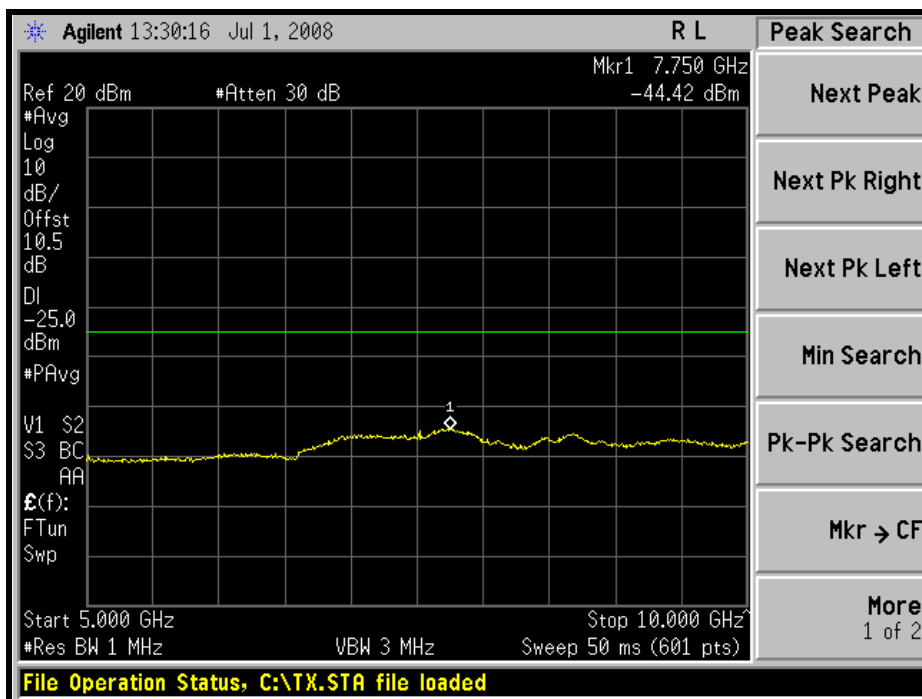

10GHz ~ 26.5GHz:

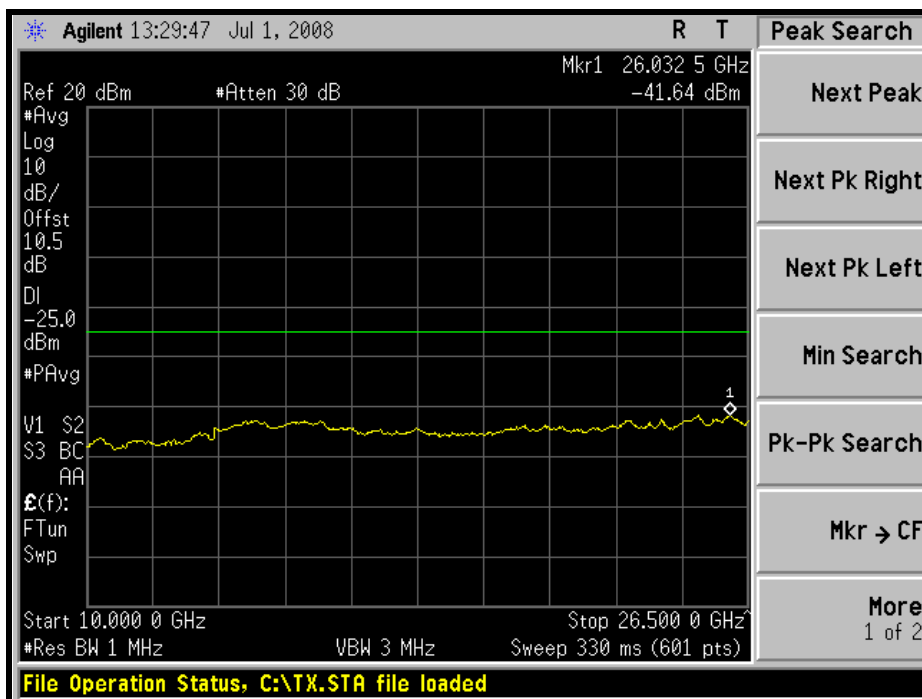

MIDDLE CHANNEL: 30MHz ~ 1GHz:

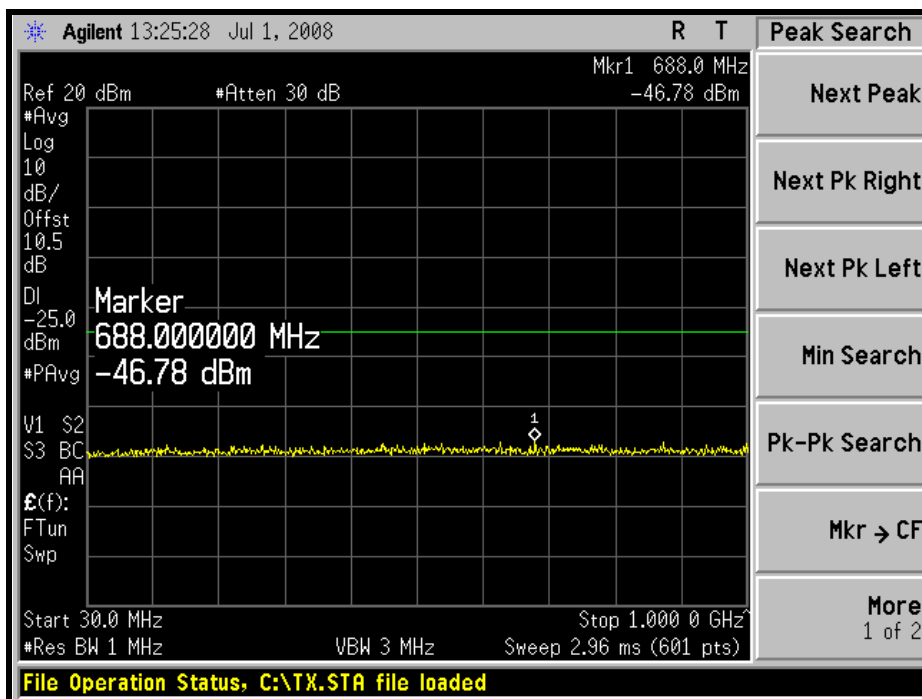

1GHz ~ 5GHz:

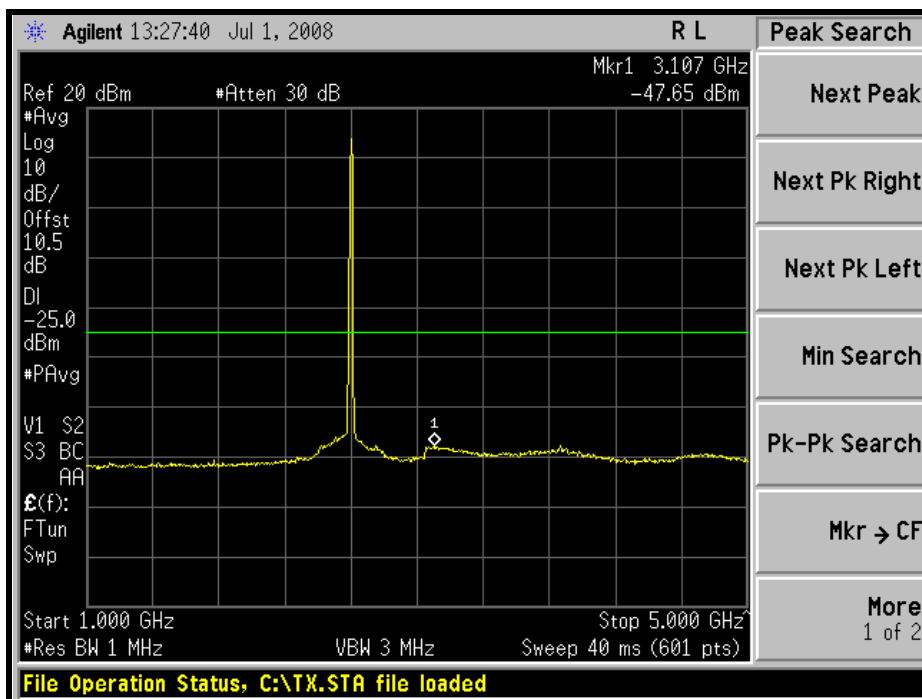

5GHz ~ 10GHz:

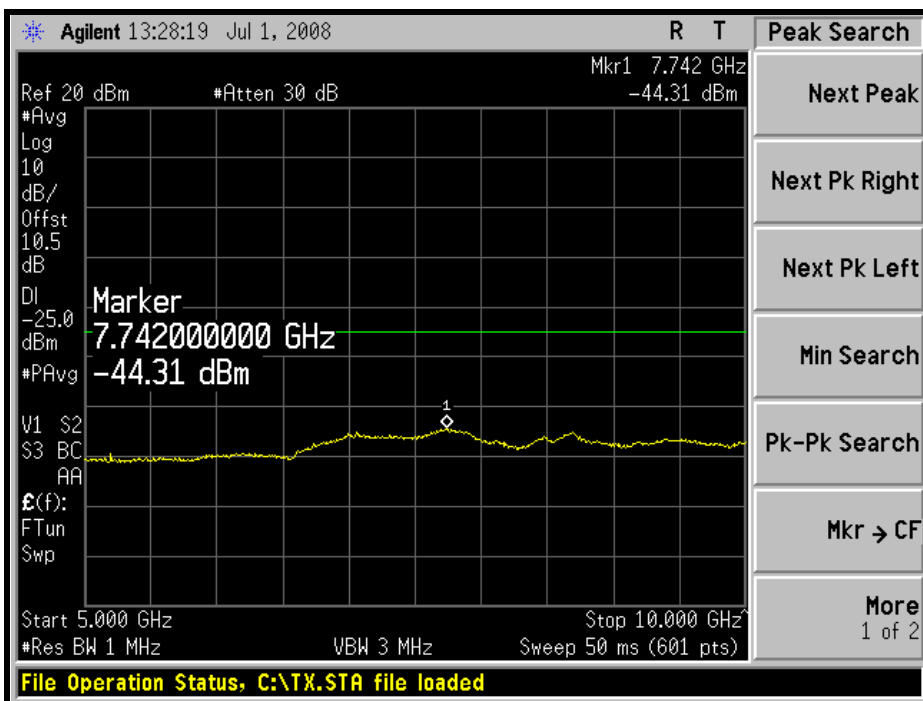

10GHz ~ 26.5GHz:

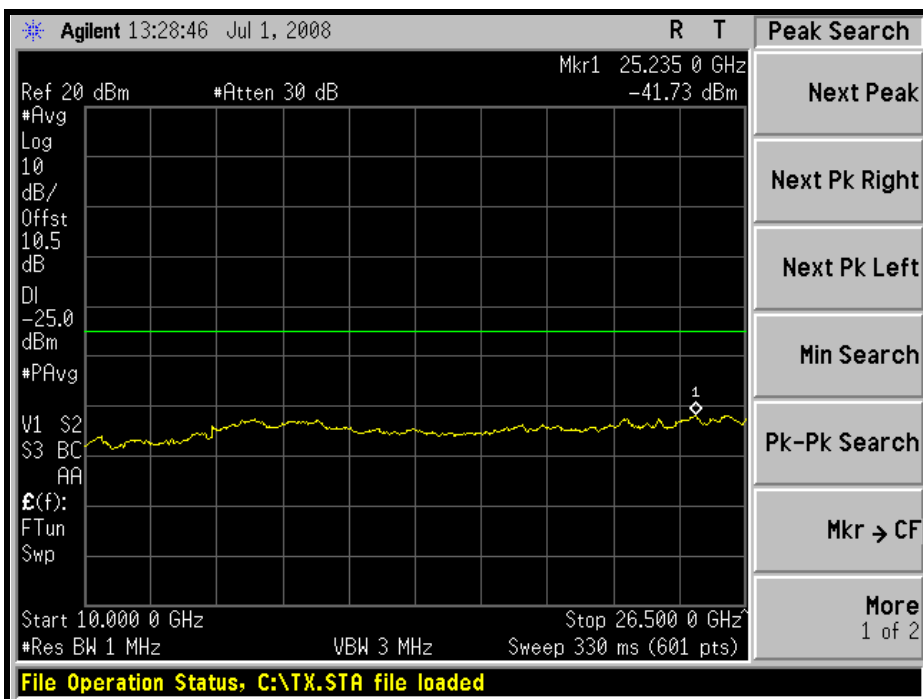

HIGH CHANNEL: 30MHz ~ 1GHz:

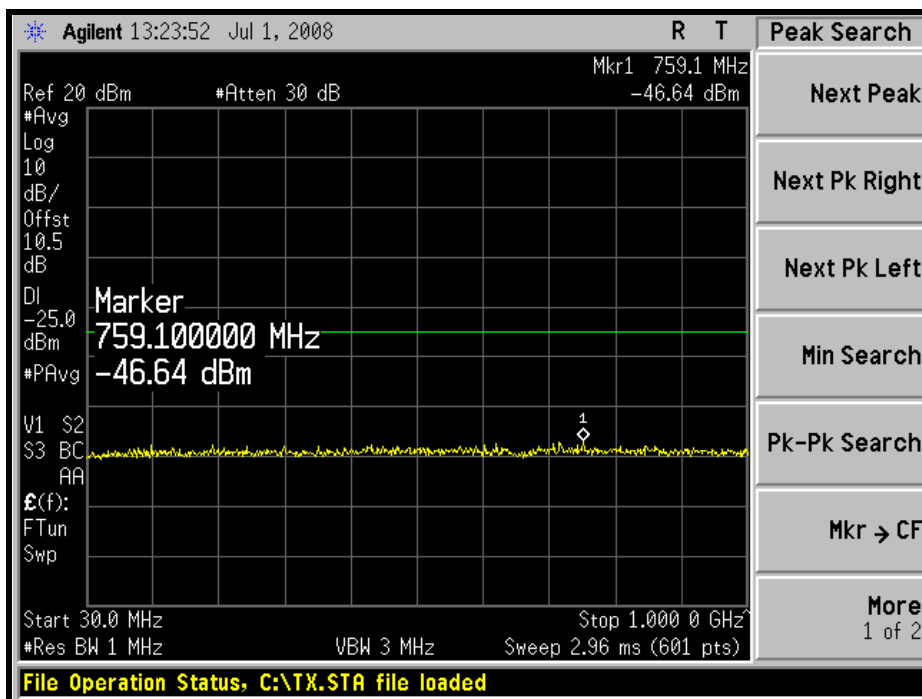

1GHz ~ 5GHz:

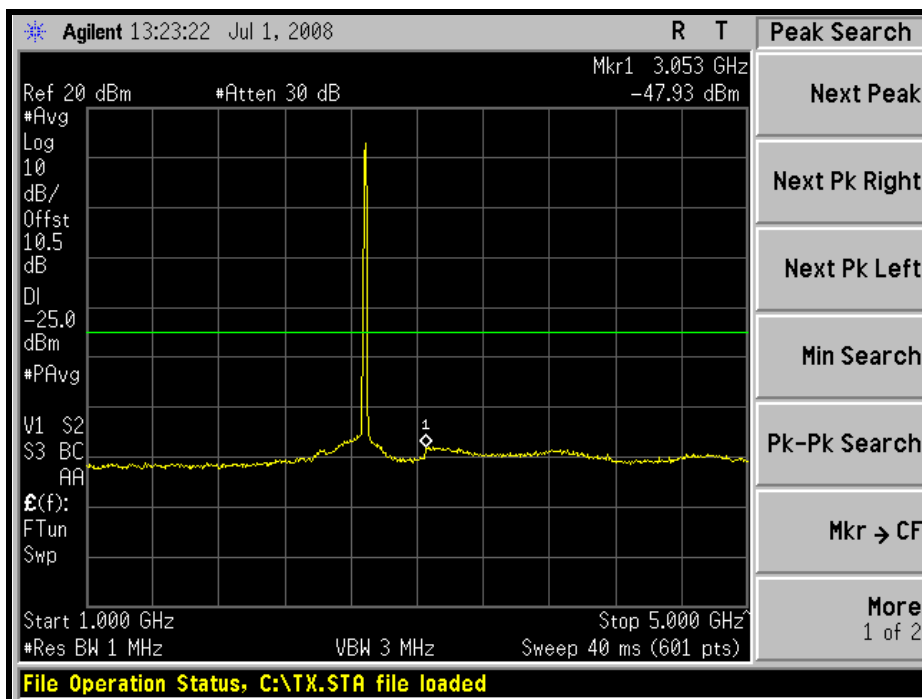

5GHz ~ 10GHz:

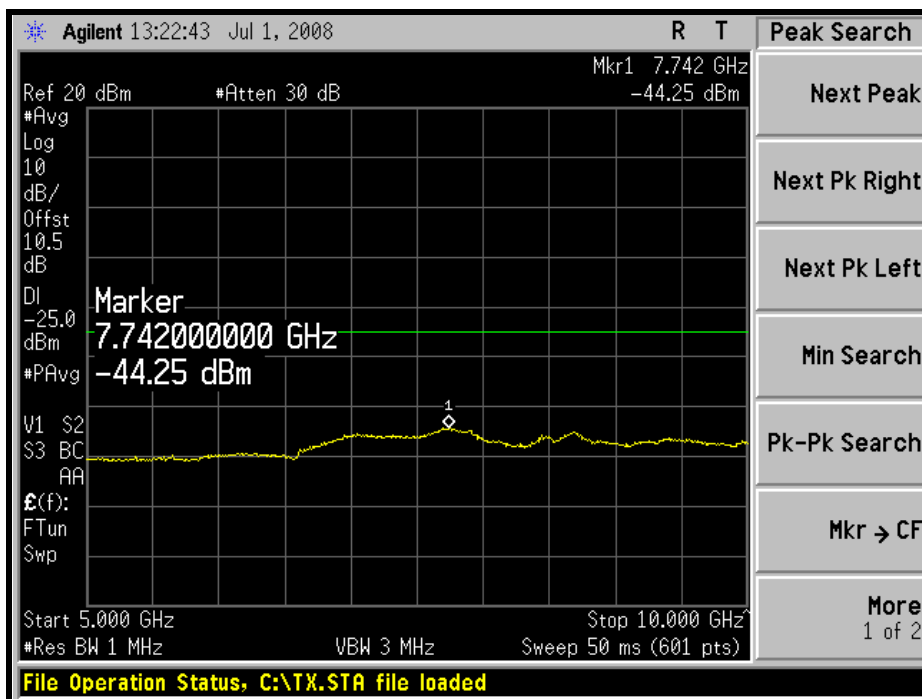

10GHz ~ 26.5GHz:

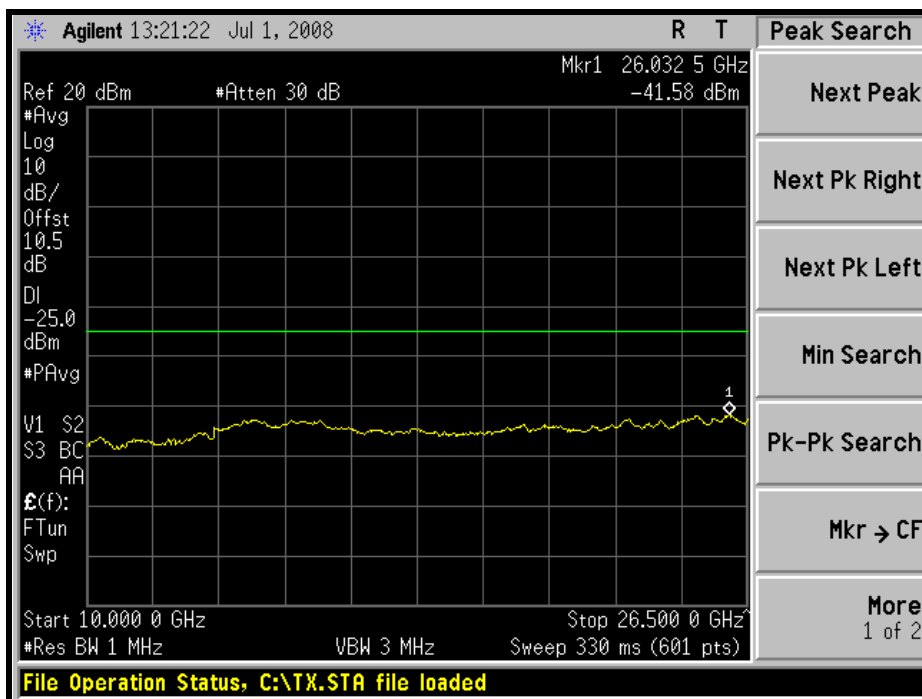

4.6 RADIATED EMISSION MEASUREMENT (BELOW 1GHz)

4.6.1 LIMITS OF RADIATED EMISSION MEASUREMENT

In the FCC 27.53(m) (4), On any frequency outside a licensee's frequency block the power of any emission shall be attenuated below the transmitter power (P) by at least $43 + 10 \log (P)$ dB and $55 + 10 \log (P)$ dB at 5.5 MHz from the channel edges.

4.6.2 TEST INSTRUMENTS

DESCRIPTION & MANUFACTURER	MODEL NO.	SERIAL NO.	CALIBRATED UNTIL
ADVANTEST Spectrum Analyzer	R3271A	85060311	July 15, 2009
HP Pre_Amplifier	8449B	3008A01922	Oct. 04, 2008
ROHDE & SCHWARZ Test Receiver	ESCS30	100375	Mar. 26, 2009
SCHWARZBECK TRILOG Broadband Antenna	VULB 9168	138	July 26, 2008
Schwarzbeck Horn_Antenna	BBHA9120	D124	Dec. 16, 2008
Schwarzbeck Horn_Antenna	BBHA 9170	BBHA9170153	Jan. 27, 2009
R&S Loop Antenna	HFH2-Z2	881058/15	Nov. 29, 2008
RF Switches (ARNITSU)	CS-201	1565157	Aug. 13, 2008
RF CABLE (Chaintek)	SF102	22054-2	Dec. 06. 2008
RF Cable(RICHTEC)	9913-30M N-N Cable	STCCAB-30M-1 GHz	Aug. 13, 2008
Software	ADT_Radiated_V 7.6.15.8	NA	NA
CHANCE MOST Antenna Tower	AT-100	0203	NA
CHANCE MOST Turn Table	TT-100	0203	NA

- Note: 1. The calibration interval of the above test instruments is 12 months and the calibrations are traceable to NML/ROC and NIST/USA.
 2. The horn antenna, HP preamplifier (model: 8449B) and Spectrum Analyzer (model: R3271A) are used only for the measurement of emission frequency above 1GHz if tested.
 3. The test was performed in ADT Open Site No. C.
 4. The FCC Site Registration No. is 656396.
 5. The VCCI Site Registration No. is R-1626.
 6. The CANADA Site Registration No. is IC 3789C-3

4.6.3 TEST PROCEDURES

- a. The EUT was placed on the top of a rotating table 0.8 meters above the ground. The table was rotated 360 degrees to determine the position of the highest radiation.
- b. The EUT was set 3 meters away from the receiving antenna, which was mounted on antenna tower and its position at 0.8 m above the ground.
- c. For each suspected emission, the EUT was arranged to its worst case and the rotatable table was turned from 0 degrees to 360 degrees to find the maximum reading and recorded the value.
- d. The EUT is replaced by a horn antenna connected to a signal generator tuned to the frequency of emission.
- e. The signal generator level has to be adjusted to have the same emission nature.
- f. The radiated power can be calculated via the factor and antenna gain.
- g. Repeat step a ~ f for horizontal polarization.

NOTE: The resolution bandwidth of spectrum analyzer is 1MHz and the video bandwidth is 3MHz.

4.6.4 DEVIATION FROM TEST STANDARD

No deviation

4.6.5 TEST SETUP

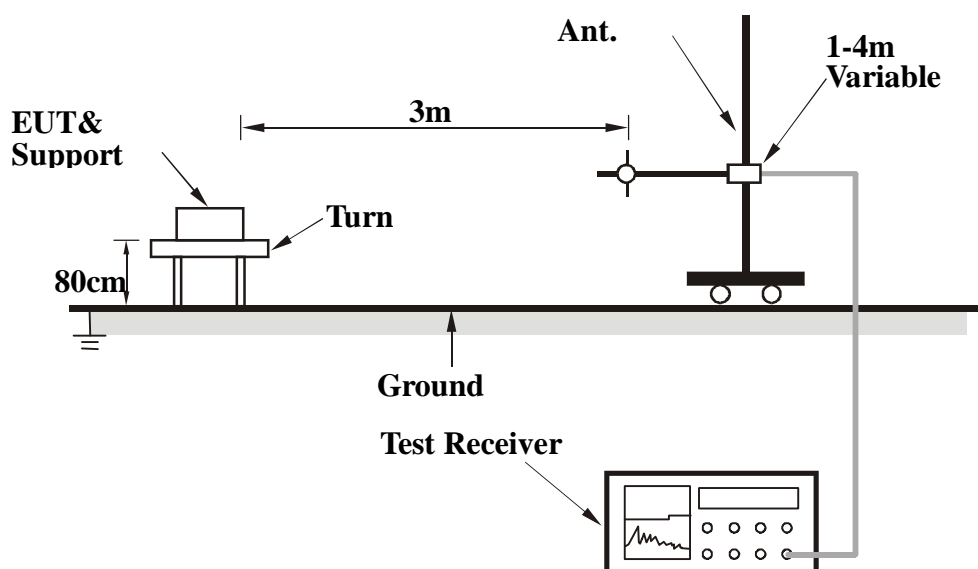

For the actual test configuration, please refer to the related item – Photographs of the Test Configuration.

4.6.6 EUT OPERATING CONDITIONS

- a. The Notebook controlled EUT to export rated output power under transmission mode and specific channel frequency.
- b. All telephones are calling to each other via EUT.

4.6.7 TEST RESULTS

CHANNEL BANDWIDTH: 5MHz

MODE	Low channel	FREQUENCY RANGE	Below 1000MHz
INPUT POWER (SYSTEM)	120Vac, 60Hz	ENVIRONMENTAL CONDITIONS	20deg°C, 60%RH 960hPa
TESTED BY	Phoenix Huang		

ANTENNA POLARITY & TEST DISTANCE: HORIZONTAL AT 3 M						
No.	Freq. (MHz)	Emission Level (dBuV/m)	Limit (dBm)	S.G level (dBm)	C.F. (dB)	Power level (dBm)
1	73.19	28.29	-25	-61.74	-3.75	-65.49
2	149.99	27.88	-25	-63.19	-1.00	-64.20
3	199.99	35.16	-25	-60.33	4.34	-55.99
4	224.99	31.79	-25	-63.62	4.01	-59.60
5	274.99	38.59	-25	-55.40	4.09	-51.31
6	299.99	36.65	-25	-59.13	3.71	-55.42
7	324.99	34.18	-25	-62.64	3.65	-58.99
8	375.00	32.82	-25	-65.03	3.46	-61.57
9	824.96	35.10	-25	-61.59	1.29	-60.30
10	849.96	34.30	-25	-60.35	1.03	-59.32

ANTENNA POLARITY & TEST DISTANCE: VERTICAL AT 3 M						
No.	Freq. (MHz)	Emission Level (dBuV/m)	Limit (dBm)	S.G level (dBm)	C.F. (dB)	Power level (dBm)
1	62.94	28.63	-25	-55.25	-6.73	-61.98
2	73.19	31.93	-25	-58.10	-3.75	-61.85
3	199.99	35.06	-25	-60.43	4.34	-56.09
4	274.99	33.56	-25	-60.43	4.09	-56.34
5	299.99	36.07	-25	-59.71	3.71	-56.00
6	349.99	31.60	-25	-66.26	3.60	-62.67
7	399.99	35.74	-25	-62.10	3.33	-58.77
8	424.99	32.01	-25	-66.04	3.07	-62.97
9	774.96	33.09	-25	-64.46	1.18	-63.27
10	824.96	35.42	-25	-61.27	1.29	-59.98

REMARKS: 1. Power Value(dBm)=S.G Power Value (dBm) + Correction Factor(dB)



CHANNEL BANDWIDTH: 10MHz

MODE	Low channel	FREQUENCY RANGE	Below 1000MHz
INPUT POWER (SYSTEM)	120Vac, 60Hz	ENVIRONMENTAL CONDITIONS	20deg°C, 60%RH 960hPa
TESTED BY	Phoenix Huang		

ANTENNA POLARITY & TEST DISTANCE: HORIZONTAL AT 3 M

No.	Freq. (MHz)	Emission Level (dBuV/m)	Limit (dBm)	S.G level (dBm)	C.F. (dB)	Power level (dBm)
1	73.19	28.37	-25	-61.66	-3.75	-65.41
2	149.99	27.96	-25	-63.11	-1.00	-64.12
3	199.99	35.34	-25	-60.15	4.34	-55.81
4	224.99	31.65	-25	-63.76	4.01	-59.74
5	274.99	38.69	-25	-55.30	4.09	-51.21
6	299.99	36.78	-25	-59.00	3.71	-55.29
7	324.99	34.52	-25	-62.30	3.65	-58.65
8	375.00	32.85	-25	-65.00	3.46	-61.54
9	824.96	35.22	-25	-61.47	1.29	-60.18
10	849.96	34.96	-25	-59.69	1.03	-58.66

ANTENNA POLARITY & TEST DISTANCE: VERTICAL AT 3 M

No.	Freq. (MHz)	Emission Level (dBuV/m)	Limit (dBm)	S.G level (dBm)	C.F. (dB)	Power level (dBm)
1	62.94	28.73	-25	-55.15	-6.73	-61.88
2	73.19	31.85	-25	-58.18	-3.75	-61.93
3	199.99	35.12	-25	-60.37	4.34	-56.03
4	274.99	33.68	-25	-60.31	4.09	-56.22
5	299.99	36.12	-25	-59.66	3.71	-55.95
6	349.99	31.58	-25	-66.28	3.60	-62.69
7	399.99	35.49	-25	-62.35	3.33	-59.02
8	424.99	32.25	-25	-65.80	3.07	-62.73
9	774.96	33.43	-25	-64.12	1.18	-62.93
10	824.96	35.38	-25	-61.31	1.29	-60.02

REMARKS: 1. Power Value(dBm)=S.G Power Value (dBm) + Correction Factor(dB)



4.7 RADIATED EMISSION MEASUREMENT (ABOVE 1GHz)

4.7.1 LIMITS OF RADIATED EMISSION MEASUREMENT

In the FCC 27.53(m) (4), On any frequency outside a licensee's frequency block, the power of any emission shall be attenuated below the transmitter power (P) by at least $43 + 10 \log (P)$ dB.

4.7.2 TEST INSTRUMENTS

DESCRIPTION & MANUFACTURER	MODEL NO.	SERIAL NO.	CALIBRATED UNTIL
ADVANTEST Spectrum Analyzer	R3271A	85060311	July 15, 2009
HP Pre_Amplifier	8449B	3008A01922	Oct. 04, 2008
ROHDE & SCHWARZ Test Receiver	ESCS30	100375	Mar. 26, 2009
SCHWARZBECK TRILOG Broadband Antenna	VULB 9168	138	July 26, 2008
Schwarzbeck Horn_Antenna	BBHA9120	D124	Dec. 16, 2008
Schwarzbeck Horn_Antenna	BBHA 9170	BBHA9170153	Jan. 27, 2009
R&S Loop Antenna	HFH2-Z2	881058/15	Nov. 29, 2008
RF Switches (ARNITSU)	CS-201	1565157	Aug. 13, 2008
RF CABLE (Chaintek)	SF102	22054-2	Dec. 06. 2008
RF Cable(RICHTEC)	9913-30M N-N Cable	STCCAB-30M-1 GHz	Aug. 13, 2008
Software	ADT_Radiated_V 7.6.15.8	NA	NA
CHANCE MOST Antenna Tower	AT-100	0203	NA
CHANCE MOST Turn Table	TT-100	0203	NA

- Note: 1. The calibration interval of the above test instruments is 12 months and the calibrations are traceable to NML/ROC and NIST/USA.
 2. The horn antenna, HP preamplifier (model: 8449B) and Spectrum Analyzer (model: R3271A) are used only for the measurement of emission frequency above 1GHz if tested.
 3. The test was performed in ADT Open Site No. C.
 4. The FCC Site Registration No. is 656396.
 5. The VCCI Site Registration No. is R-1626.
 6. The CANADA Site Registration No. is IC 3789C-3.

4.7.3 TEST PROCEDURES

- a. The EUT was placed on the top of a rotating table 0.8 meters above the ground. The table was rotated 360 degrees to determine the position of the highest radiation.
- b. The EUT was set 3 meters away from the receiving antenna, which was mounted on antenna tower and its position at 0.8 m above the ground.
- c. For each suspected emission, the EUT was arranged to its worst case and the rotatable table was turned from 0 degrees to 360 degrees to find the maximum reading and recorded the value.
- d. The EUT is replaced by a horn antenna connected to a signal generator tuned to the frequency of emission.
- e. The signal generator level has to be adjusted to have the same emission nature.
- f. The radiated power can be calculated via the factor and antenna gain.
- g. Repeat step a ~ f for horizontal polarization.

NOTE: The resolution bandwidth of spectrum analyzer is 1MHz and the video bandwidth is 3MHz.

4.7.4 DEVIATION FROM TEST STANDARD

No deviation

4.7.5 TEST SETUP

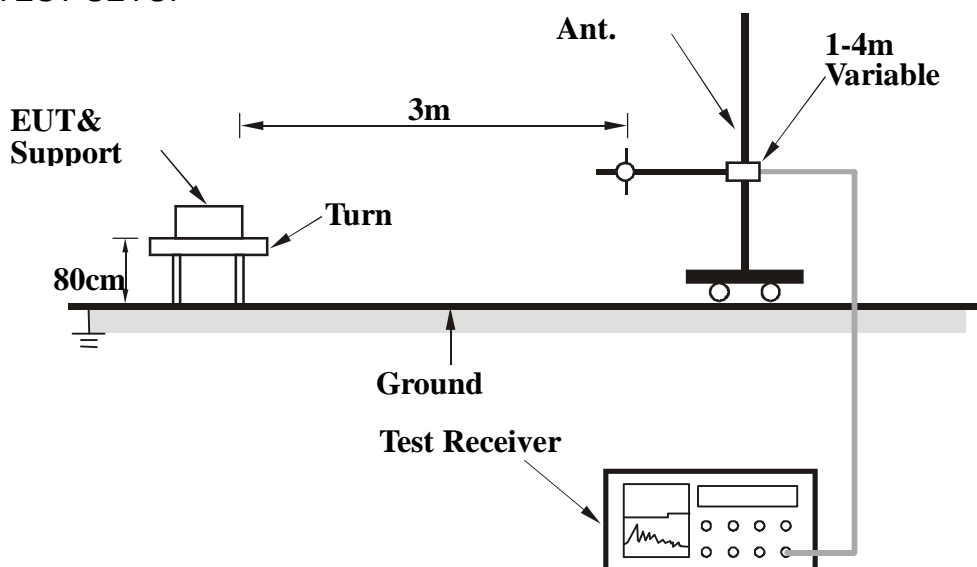

For the actual test configuration, please refer to the related item – Photographs of the Test Configuration.

4.7.6 EUT OPERATING CONDITIONS

- a. The Notebook controlled EUT to export rated output power under transmission mode and specific channel frequency.
- b. All telephones are calling to each other via EUT.

4.7.7 TEST RESULTS

CHANNEL BANDWIDTH: 5MHz

MODE	Low channel	FREQUENCY RANGE	Above 1000MHz
INPUT POWER (SYSTEM)	120Vac, 60Hz	ENVIRONMENTAL CONDITIONS	20deg°C, 60%RH 960hPa
TESTED BY	Phoenix Huang		

ANTENNA POLARITY & TEST DISTANCE: HORIZONTAL AT 3 M						
No.	Freq. (MHz)	Emission Level (dBuV/m)	Limit (dBm)	S.G level (dBm)	C.F. (dB)	Power level (dBm)
1	2540.00	50.97	-25	-47.80	6.69	-41.11
2	3340.00	37.92	-25	-65.08	7.62	-57.47
3	5010.00	47.98	-25	-56.27	7.01	-49.25
4	7515.00	43.70	-25	-58.92	4.53	-54.39
5	10020.00	49.30	-25	-52.28	4.02	-48.26

ANTENNA POLARITY & TEST DISTANCE: VERTICAL AT 3 M						
No.	Freq. (MHz)	Emission Level (dBuV/m)	Limit (dBm)	S.G level (dBm)	C.F. (dB)	Power level (dBm)
1	2540.00	57.74	-25	-41.03	6.69	-34.34
2	3340.00	39.21	-25	-63.79	7.62	-56.18
3	5010.00	43.38	-25	-60.87	7.01	-53.85
4	7515.00	42.78	-25	-59.84	4.53	-55.31
5	10020.00	45.28	-25	-56.30	4.02	-52.28

REMARKS: 1. Power Value(dBm)=S.G Power Value (dBm) + Correction Factor(dB)



MODE	Middle channel	FREQUENCY RANGE	Above 1000MHz
INPUT POWER (SYSTEM)	120Vac, 60Hz	ENVIRONMENTAL CONDITIONS	20deg°C, 60%RH 960hPa
TESTED BY	Phoenix Huang		

ANTENNA POLARITY & TEST DISTANCE: HORIZONTAL AT 3 M						
No.	Freq. (MHz)	Emission Level (dBuV/m)	Limit (dBm)	S.G level (dBm)	C.F. (dB)	Power level (dBm)
1	2666.60	51.95	-25	-47.87	6.81	-41.06
2	3466.60	33.41	-25	-69.75	7.80	-61.95
3	5200.00	47.05	-25	-57.48	7.05	-50.43
4	7800.00	44.47	-25	-58.15	4.29	-53.86
5	10400.00	50.13	-25	-51.88	3.66	-48.21

ANTENNA POLARITY & TEST DISTANCE: VERTICAL AT 3 M						
No.	Freq. (MHz)	Emission Level (dBuV/m)	Limit (dBm)	S.G level (dBm)	C.F. (dB)	Power level (dBm)
1	2666.60	56.27	-25	-43.55	6.81	-36.74
2	3466.60	32.65	-25	-70.51	7.80	-62.71
3	5200.00	44.63	-25	-59.90	7.05	-52.85
4	7800.00	45.32	-25	-57.30	4.29	-53.01
5	10400.00	50.35	-25	-51.66	3.66	-47.99

REMARKS: 1. Power Value(dBm)=S.G Power Value (dBm) + Correction Factor(dB)



MODE	High channel	FREQUENCY RANGE	Above 1000MHz
INPUT POWER (SYSTEM)	120Vac, 60Hz	ENVIRONMENTAL CONDITIONS	20deg°C, 60%RH 960hPa
TESTED BY	Phoenix Huang		

ANTENNA POLARITY & TEST DISTANCE: HORIZONTAL AT 3 M						
No.	Freq. (MHz)	Emission Level (dBuV/m)	Limit (dBm)	S.G level (dBm)	C.F. (dB)	Power level (dBm)
1	2780.00	50.77	-25	-49.99	6.92	-43.07
2	3580.00	33.97	-25	-69.52	7.80	-61.73
3	5370.00	49.22	-25	-55.57	7.09	-48.47
4	8055.00	44.28	-25	-58.34	4.13	-54.21
5	10740.00	52.93	-25	-48.92	3.34	-45.58

ANTENNA POLARITY & TEST DISTANCE: VERTICAL AT 3 M						
No.	Freq. (MHz)	Emission Level (dBuV/m)	Limit (dBm)	S.G level (dBm)	C.F. (dB)	Power level (dBm)
1	2780.00	56.06	-25	-44.70	6.92	-37.78
2	3580.00	32.88	-25	-70.61	7.80	-62.82
3	5370.00	52.15	-25	-52.64	7.09	-45.54
4	8055.00	45.20	-25	-57.42	4.13	-53.29
5	10740.00	54.27	-25	-47.58	3.34	-44.24

REMARKS: 1. Power Value(dBm)=S.G Power Value (dBm) + Correction Factor(dB)



CHANNEL BANDWIDTH: 10MHz

MODE	Low channel	FREQUENCY RANGE	Above 1000MHz
INPUT POWER (SYSTEM)	120Vac, 60Hz	ENVIRONMENTAL CONDITIONS	20deg°C, 60%RH 960hPa
TESTED BY	Phoenix Huang		

ANTENNA POLARITY & TEST DISTANCE: HORIZONTAL AT 3 M

No.	Freq. (MHz)	Emission Level (dBuV/m)	Limit (dBm)	S.G level (dBm)	C.F. (dB)	Power level (dBm)
1	2540.00	50.88	-25	-47.89	6.69	-41.20
2	3340.00	38.36	-25	-64.64	7.62	-57.03
3	5010.00	44.97	-25	-59.28	7.01	-52.26
4	7515.00	43.10	-25	-59.52	4.53	-54.99
5	1002.00	48.08	-25	-53.50	4.02	-49.48

ANTENNA POLARITY & TEST DISTANCE: VERTICAL AT 3 M

No.	Freq. (MHz)	Emission Level (dBuV/m)	Limit (dBm)	S.G level (dBm)	C.F. (dB)	Power level (dBm)
1	2540.00	59.06	-25	-39.71	6.69	-33.02
2	3340.00	39.90	-25	-63.10	7.62	-55.49
3	5010.00	47.70	-25	-56.55	7.01	-49.53
4	7515.00	45.31	-25	-57.31	4.53	-52.78
5	1002.00	46.36	-25	-55.22	4.02	-51.20

REMARKS: 1. Power Value(dBm)=S.G Power Value (dBm) + Correction Factor(dB)

MODE	Middle channel	FREQUENCY RANGE	Above 1000MHz
INPUT POWER (SYSTEM)	120Vac, 60Hz	ENVIRONMENTAL CONDITIONS	20deg°C, 60%RH 960hPa
TESTED BY	Phoenix Huang		

ANTENNA POLARITY & TEST DISTANCE: HORIZONTAL AT 3 M						
No.	Freq. (MHz)	Emission Level (dBuV/m)	Limit (dBm)	S.G level (dBm)	C.F. (dB)	Power level (dBm)
1	2666.60	52.18	-25	-47.64	6.81	-40.83
2	3466.60	33.43	-25	-69.73	7.80	-61.93
3	5200.00	43.25	-25	-61.28	7.05	-54.23
4	7800.00	43.62	-25	-59.00	4.29	-54.71
5	10400.00	48.68	-25	-53.33	3.66	-49.66

ANTENNA POLARITY & TEST DISTANCE: VERTICAL AT 3 M						
No.	Freq. (MHz)	Emission Level (dBuV/m)	Limit (dBm)	S.G level (dBm)	C.F. (dB)	Power level (dBm)
1	2666.60	57.72	-25	-42.10	6.81	-35.29
2	3466.60	33.57	-25	-69.59	7.80	-61.79
3	5200.00	46.72	-25	-57.81	7.05	-50.76
4	7800.00	44.67	-25	-57.95	4.29	-53.66
5	10400.00	49.82	-25	-52.19	3.66	-48.52

REMARKS: 1. Power Value(dBm)=S.G Power Value (dBm) + Correction Factor(dB)

MODE	High channel	FREQUENCY RANGE	Above 1000MHz
INPUT POWER (SYSTEM)	120Vac, 60Hz	ENVIRONMENTAL CONDITIONS	20deg°C, 60%RH 960hPa
TESTED BY	Phoenix Huang		

ANTENNA POLARITY & TEST DISTANCE: HORIZONTAL AT 3 M						
No.	Freq. (MHz)	Emission Level (dBuV/m)	Limit (dBm)	S.G level (dBm)	C.F. (dB)	Power level (dBm)
1	2780.00	51.27	-25	-49.49	6.92	-42.57
2	3580.00	33.39	-25	-70.10	7.80	-62.31
3	5370.00	48.08	-25	-56.71	7.09	-49.61
4	8055.00	43.93	-25	-58.69	4.13	-54.56
5	10740.00	49.37	-25	-52.48	3.34	-49.14

ANTENNA POLARITY & TEST DISTANCE: VERTICAL AT 3 M						
No.	Freq. (MHz)	Emission Level (dBuV/m)	Limit (dBm)	S.G level (dBm)	C.F. (dB)	Power level (dBm)
1	2780.00	55.76	-25	-45.00	6.92	-38.08
2	3580.00	33.48	-25	-70.01	7.80	-62.22
3	5370.00	48.75	-25	-56.04	7.09	-48.94
4	8055.00	44.30	-25	-58.32	4.13	-54.19
5	10740.00	52.12	-25	-49.73	3.34	-46.39

REMARKS: 1. Power Value(dBm)=S.G Power Value (dBm) + Correction Factor(dB)



5 PHOTOGRAPHS OF THE TEST CONFIGURATION

Please refer to the attached file (Test Setup Photo).



6 INFORMATION ON THE TESTING LABORATORIES

We, ADT Corp., were founded in 1988 to provide our best service in EMC, Radio, Telecom and Safety consultation. Our laboratories are accredited and approved by the following approval agencies according to ISO/IEC 17025.

USA	FCC, UL, A2LA
GERMANY	TUV Rheinland
JAPAN	VCCI
NORWAY	NEMKO
CANADA	INDUSTRY CANADA , CSA
R.O.C.	TAF, BSMI, NCC
NETHERLANDS	Telefication
SINGAPORE	GOST-ASIA (MOU)
RUSSIA	CERTIS (MOU)

Copies of accreditation certificates of our laboratories obtained from approval agencies can be downloaded from our web site:

www.adt.com.tw/index.5/phtml. If you have any comments, please feel free to contact us at the following:

Linko EMC/RF Lab:

Tel: 886-2-26052180

Fax: 886-2-26051924

Hsin Chu EMC/RF Lab:

Tel: 886-3-5935343

Fax: 886-3-5935342

Hwa Ya EMC/RF/Safety/Telecom Lab: Web Site: www.adt.com.tw

Tel: 886-3-3183232

Fax: 886-3-3185050

The address and road map of all our labs can be found in our web site also.

---END---