

FCC TEST REPORT

REPORT NO.: RF970702H03 - 1

MODEL NO.: OD200-IDU Series
(Series model refer to note 1)

RECEIVED: July 07, 2008

TESTED: Aug. 22 to 23, 2008

ISSUED: Aug. 27, 2008

APPLICANT: Accton Wireless Broadband Corp.

ADDRESS: 3F, No. 1 Creation Rd. III, Science-based
Industrial Park Hsinchu 30077, Taiwan,
R.O.C.

ISSUED BY: Advance Data Technology Corporation

TEST LOCATION: No. 81-1, Lu Liao Keng, 9 Ling, Wu Lung
Tsuen, Chiung Lin Hsiang, Hsin Chu Hsien,
Taiwan, R.O.C.

This test report consists of 62 pages in total. It may be duplicated completely for legal use with the approval of the applicant. It should not be reproduced except in full, without the written approval of our laboratory. The client should not use it to claim product endorsement by TAF or any government agencies. The test results in the report only apply to the tested sample.



Table of Contents

1.	CERTIFICATION	4
2.	SUMMARY OF TEST RESULTS	5
2.1	MEASUREMENT UNCERTAINTY	6
3.	GENERAL INFORMATION	7
3.1	GENERAL DESCRIPTION OF EUT	7
3.2	DESCRIPTION OF TEST MODES	9
3.2.1	TEST MODE APPLICABILITY AND TESTED CHANNEL DETAIL:	10
3.3	GENERAL DESCRIPTION OF APPLIED STANDARDS	12
3.4	DESCRIPTION OF SUPPORT UNITS	13
3.5	CONFIGURATION OF SYSTEM UNDER TEST	14
4.	TEST TYPES AND RESULTS	15
4.1	CONDUCTED EMISSION MEASUREMENT	15
4.1.1	LIMITS OF CONDUCTED EMISSION MEASUREMENT	15
4.1.2	TEST INSTRUMENTS	15
4.1.3	TEST PROCEDURES	16
4.1.4	DEVIATION FROM TEST STANDARD	16
4.1.5	TEST SETUP	17
4.1.6	EUT OPERATING CONDITIONS	17
4.1.7	TEST RESULTS	18
4.2	RADIATED EMISSION MEASUREMENT	20
4.2.1	LIMITS OF RADIATED EMISSION MEASUREMENT	20
4.2.2	TEST INSTRUMENTS	21
4.2.3	TEST PROCEDURES	22
4.2.4	DEVIATION FROM TEST STANDARD	22
4.2.5	TEST SETUP	23
4.2.6	EUT OPERATING CONDITIONS	23
4.2.7	TEST RESULTS	24
4.3	6dB BANDWIDTH MEASUREMENT	39
4.3.1	LIMITS OF 6dB BANDWIDTH MEASUREMENT	39
4.3.2	TEST INSTRUMENTS	39
4.3.3	TEST PROCEDURE	40
4.3.4	DEVIATION FROM TEST STANDARD	40
4.3.5	TEST SETUP	40
4.3.6	EUT OPERATING CONDITIONS	40
4.3.7	TEST RESULTS	41
4.4	MAXIMUM PEAK OUTPUT POWER	45



4.4.1	LIMITS OF MAXIMUM PEAK OUTPUT POWER MEASUREMENT	45
4.4.2	INSTRUMENTS	45
4.4.3	TEST PROCEDURES.....	46
4.4.4	DEVIATION FROM TEST STANDARD	46
4.4.5	TEST SETUP	46
4.4.6	EUT OPERATING CONDITIONS	46
4.4.7	TEST RESULTS.....	47
4.5	POWER SPECTRAL DENSITY MEASUREMENT	48
4.5.1	LIMITS OF POWER SPECTRAL DENSITY MEASUREMENT	48
4.5.2	TEST INSTRUMENTS	48
4.5.3	TEST PROCEDURE	49
4.5.4	DEVIATION FROM TEST STANDARD	49
4.5.5	TEST SETUP	49
4.5.6	EUT OPERATING CONDITION	49
4.5.7	TEST RESULTS.....	50
4.6	BAND EDGES MEASUREMENT	54
4.6.1	LIMITS OF BAND EDGES MEASUREMENT	54
4.6.2	TEST INSTRUMENTS	54
4.6.3	TEST PROCEDURE	54
4.6.4	DEVIATION FROM TEST STANDARD	55
4.6.5	EUT OPERATING CONDITION	55
4.6.6	TEST RESULTS.....	55
4.7	ANTENNA REQUIREMENT	60
4.7.1	STANDARD APPLICABLE.....	60
4.7.2	ANTENNA CONNECTED CONSTRUCTION	60
5.	INFORMATION ON THE TESTING LABORATORIES	61
6.	APPENDIX A - MODIFICATIONS RECORDERS FOR ENGINEERING CHANGES TO THE EUT BY THE LAB.....	62



1. CERTIFICATION

PRODUCT: WiMAX 802.16e Wave 2 Outdoor CPE Indoor unit
BRAND NAME: AWB
MODEL NO.: OD200-IDU Series (Series model refer to note 1)
TEST SAMPLE: R&D SAMPLE
TESTED: Aug. 22 to 23, 2008
APPLICANT: Accton Wireless Broadband Corp.
STANDARDS: FCC Part 15, Subpart C (Section 15.247),
ANSI C63.4-2003

The above equipment (Model: OD200-IDU-4D2V1W) has been tested by **Advance Data Technology Corporation**, and found compliance with the requirement of the above standards. The test record, data evaluation & Equipment Under Test (EUT) configurations represented herein are true and accurate accounts of the measurements of the sample's EMC characteristics under the conditions specified in this report.

PREPARED BY : Carol Liao , **DATE:** Aug. 27, 2008
(Carol Liao, Specialist)

TECHNICAL ACCEPTANCE : Hank Chung , **DATE:** Aug. 27, 2008
Responsible for RF (Hank Chung, Deputy Manager)

APPROVED BY : May Chen , **DATE:** Aug. 27, 2008
(May Chen, Deputy Manager)

2. SUMMARY OF TEST RESULTS

The EUT has been tested according to the following specifications:

APPLIED STANDARD: FCC Part 15, Subpart C (Section 15.247)			
Standard Section	Test Type and Limit	Result	Remark
15.207	AC Power Conducted Emission	PASS	Meet the requirement of limit. Minimum passing margin is -14.26dB at 0.533MHz
15.247(a)(2)	Spectrum Bandwidth of a Direct Sequence Spread Spectrum System Limit: min. 500kHz	PASS	Meet the requirement of limit.
15.247(b)	Maximum Peak Output Power Limit: max. 30dBm	PASS	Meet the requirement of limit.
15.247(d)	Radiated Emissions Limit: Table 15.209	PASS	Meet the requirement of limit. Minimum passing margin is -0.65dB at 2386.40MHz
15.247(e)	Power Spectral Density Limit: max. 8dBm	PASS	Meet the requirement of limit.
15.247(d)	Band Edge Measurement Limit: 20dB less than the peak value of fundamental frequency	PASS	Meet the requirement of limit.

2.1 MEASUREMENT UNCERTAINTY

Where relevant, the following measurement uncertainty levels have been estimated for tests performed on the EUT as specified in CISPR 16-4:

This uncertainty represents an expanded uncertainty expressed at approximately the 95% confidence level using a coverage factor of $k=2$.

Measurement	Value
Conducted emissions	2.45 dB
Radiated emissions (30MHz-1GHz)	3.83 dB
Radiated emissions (1GHz -18GHz)	2.28 dB
Radiated emissions (18GHz -40GHz)	2.52 dB

3. GENERAL INFORMATION

3.1 GENERAL DESCRIPTION OF EUT

PRODUCT	WiMAX 802.16e Wave 2 Outdoor CPE Indoor unit
MODEL NO.	OD200-IDU Series (Series model refer to note 1)
FCC ID	V8YFW181OD25001W
POWER SUPPLY	DC 19V from power adapter
MODULATION TYPE	CCK, DQPSK, DBPSK for DSSS 64QAM, 16QAM, QPSK, BPSK for OFDM
MODULATION TECHNOLOGY	DSSS, OFDM
TRANSFER RATE	802.11b: 11 / 5.5 / 2 / 1Mbps 802.11g: 54 / 48 / 36 / 24 / 18 / 12 / 9 / 6Mbps
FREQUENCY RANGE	2412 ~ 2462MHz
NUMBER OF CHANNEL	11
MAXIMUM OUTPUT POWER	802.11b: 149.279mW 802.11g: 185.780mW
ANTENNA TYPE	Please see note 2
DATA CABLE	NA
I/O PORT	LAN port x 4 ODU port x 1 Phone port x 2

NOTE:

- The EUT has three different model names, which are identical to each other in all aspects except for the followings :

Brand	Model No.	Description
AWB	OD200-IDU	4 LAN port +2 VOIP port + 1 WLAN
	OD200-IDU-4D1W	4 LAN port + 1 WLAN
	OD200-IDU-4D2V1W	4 LAN port +2 VOIP port + 1 WLAN

From the above models, model: **OD200-IDU-4D2V1W** was selected as representative model for the test and its data was recorded in this report.

2. There is one antenna provided to this EUT, please refer to the following table:

Antenna Type	Antenna Connector	Gain(dBi)
Dipole	Reverse SMA	2

3. The EUT (Wi-Fi product) was sold together with one WiMAX product. The detail information is as below:

Wi-Fi product	
Model Name	Description
OD200-IDU	4 LAN port +2 VOIP port + 1 WLAN
OD200-IDU-4D1W	4 LAN port + 1 WLAN
OD200-IDU-4D2V1W	4 LAN port +2 VOIP port + 1 WLAN
WiMAX product	
Model Name	Description
OD200-2.5-ODU	1 LAN Port + 1 USB Port + 1 Antenna Port

4. According to the note 3 description, this report was recorded the test data of Wi-Fi product. The test data for WiMAX product was recorded in another test report< RF970702H03>.
5. The EUT must be supplied with a power adapter as following :

Brand:	APD
Model No.:	NB-65B19
Input power :	AC 100-240V, 50-60Hz, 1.6A cable length: 1.8m/unshielded/without core
Output power :	DC 19V, 3.42A cable length: 1.8m/unshielded/without core

6. The EUT, operates in the 2.4GHz frequency range, lets you connect IEEE 802.11g and IEEE 802.11b technique devices to the network.
7. The above EUT information was declared by manufacturer and for more detailed features description, please refer to the manufacturer's specifications or user's manual.

3.2 DESCRIPTION OF TEST MODES

Eleven channels are provided for 802.11b, 802.11g:

CHANNEL	FREQUENCY	CHANNEL	FREQUENCY
1	2412MHz	7	2442MHz
2	2417MHz	8	2447MHz
3	2422MHz	9	2452MHz
4	2427MHz	10	2457MHz
5	2432MHz	11	2462MHz
6	2437MHz		

3.2.1 TEST MODE APPLICABILITY AND TESTED CHANNEL DETAIL:

EUT CONFIGURE MODE	APPLICABLE TO				DESCRIPTION
	PLC	RE < 1G	RE ≥ 1G	APCM	
-	√	√	√	√	-

Where **PLC**: Power Line Conducted Emission

RE < 1G: Radiated Emission below 1GHz

RE ≥ 1G: Radiated Emission above 1GHz

APCM: Antenna Port Conducted Measurement

POWER LINE CONDUCTED EMISSION TEST:

- Pre-Scan has been conducted to determine the worst-case mode from all possible combinations between available modulations, data rates and antenna ports (if EUT with antenna diversity architecture).
- Following channel(s) was (were) selected for the final test as listed below.

MODE	AVAILABLE CHANNEL	TESTED CHANNEL	MODULATION TECHNOLOGY	MODULATION TYPE	DATA RATE (Mbps)
802.11b	1 to 11	6	OFDM	BPSK	6

RADIATED EMISSION TEST (BELOW 1 GHz):

- Pre-Scan has been conducted to determine the worst-case mode from all possible combinations between available modulations, data rates and antenna ports (if EUT with antenna diversity architecture).
- Following channel(s) was (were) selected for the final test as listed below.

MODE	AVAILABLE CHANNEL	TESTED CHANNEL	MODULATION TECHNOLOGY	MODULATION TYPE	DATA RATE (Mbps)
802.11b	1 to 11	1	DSSS	DBPSK	1

RADIATED EMISSION TEST (ABOVE 1 GHz):

- Pre-Scan has been conducted to determine the worst-case mode from all possible combinations between available modulations, data rates and antenna ports (if EUT with antenna diversity architecture).
- Following channel(s) was (were) selected for the final test as listed below.

MODE	AVAILABLE CHANNEL	TESTED CHANNEL	MODULATION TECHNOLOGY	MODULATION TYPE	DATA RATE (Mbps)
802.11b	1 to 11	1, 6, 11	DSSS	DBPSK	1
802.11g	1 to 11	1, 6, 11	OFDM	BPSK	6

BANDEDGE MEASUREMENT:

- Pre-Scan has been conducted to determine the worst-case mode from all possible combinations between available modulations, data rates and antenna ports (if EUT with antenna diversity architecture).
- Following channel(s) was (were) selected for the final test as listed below.

MODE	AVAILABLE CHANNEL	TESTED CHANNEL	MODULATION TECHNOLOGY	MODULATION TYPE	DATA RATE (Mbps)
802.11b	1 to 11	1, 11	DSSS	DBPSK	1
802.11g	1 to 11	1, 11	OFDM	BPSK	6

ANTENNA PORT CONDUCTED MEASUREMENT:

- Pre-Scan has been conducted to determine the worst-case mode from all possible combinations between available modulations, data rates and antenna ports (if EUT with antenna diversity architecture).
- Following channel(s) was (were) selected for the final test as listed below.

MODE	AVAILABLE CHANNEL	TESTED CHANNEL	MODULATION TECHNOLOGY	MODULATION TYPE	DATA RATE (Mbps)
802.11b	1 to 11	1, 6, 11	DSSS	CCK	11
802.11g	1 to 11	1, 6, 11	OFDM	BPSK	6



3.3 GENERAL DESCRIPTION OF APPLIED STANDARDS

The EUT is a WiMAX 802.16e Wave 2 Outdoor CPE Indoor unit. According to the specifications of the manufacturer, it must comply with the requirements of the following standards:

FCC Part 15, Subpart C. (15.247)

ANSI C63.4-2003

All test items have been performed and recorded as per the above standards.

NOTE: The EUT is also considered as a kind of computer peripheral, because the connection to computer is necessary for typical use. It has been verified to comply with the requirements of FCC Part 15, Subpart B, Class B (DoC). The test report has been issued separately.



3.4 DESCRIPTION OF SUPPORT UNITS

The EUT has been tested as an independent unit together with other necessary accessories or support units. The following support units or accessories were used to form a representative test configuration during the tests.

NO.	PRODUCT	BRAND	MODEL NO.	SERIAL NO.	FCC ID
1	NOTEBOOK COMPUTER	DELL	PP18L	6976685584	FCC DoC
2	HUB	AVSYS	110H8	01-20E-000002	FCC DoC
3	WiMAX 802.16e Wave 2 Outdoor CPE Outdoor unit	AWB	OD200-2.5-ODU	NA	NA
4	TELEPHONE	CAOKE	TC-203	TC0009793	NA
5	TELEPHONE	CAOKE	TC-203	TC0003748	NA

NO.	SIGNAL CABLE DESCRIPTION OF THE ABOVE SUPPORT UNITS
1	NA
2	NA
3	NA
4	1.8 m Non shielded cable, RJ11 connector, w/o core.
5	1.8 m Non shielded cable, RJ11 connector, w/o core.

NOTE: All power cords of the above support units are non shielded (1.8m).

3.5 CONFIGURATION OF SYSTEM UNDER TEST

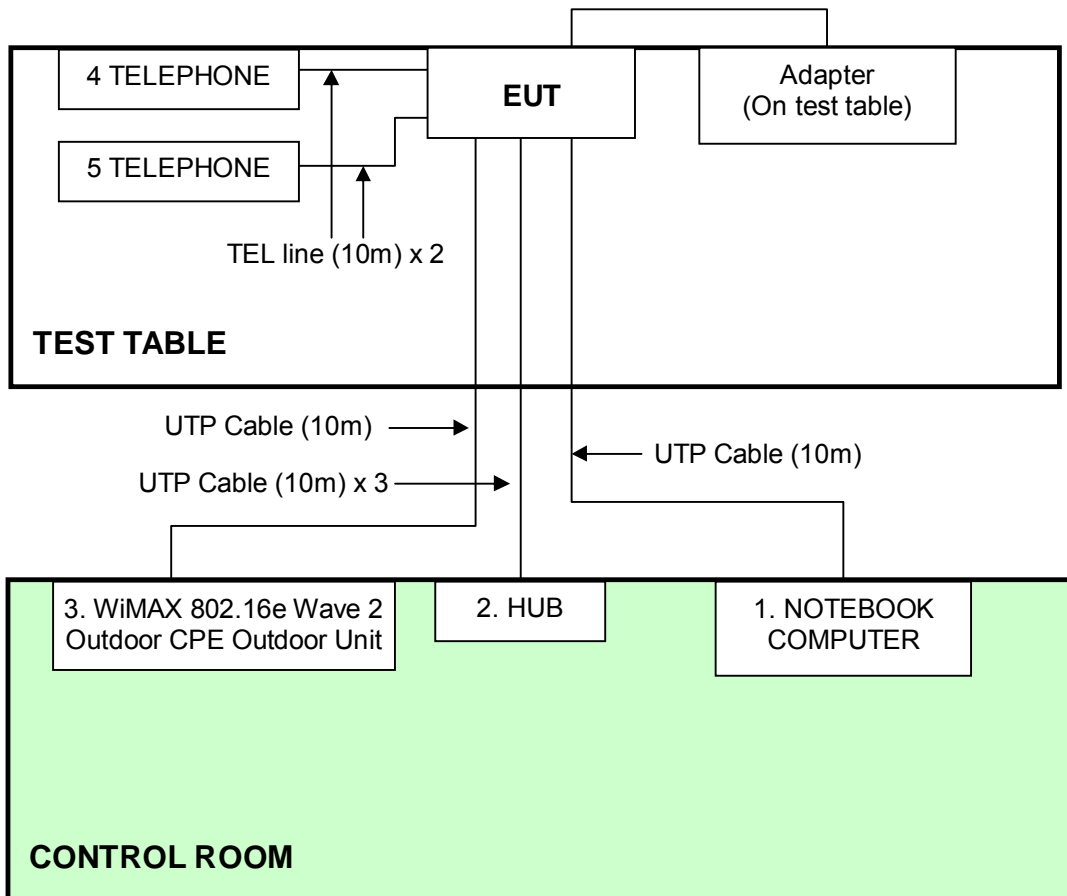

4. TEST TYPES AND RESULTS

4.1 CONDUCTED EMISSION MEASUREMENT

4.1.1 LIMITS OF CONDUCTED EMISSION MEASUREMENT

FREQUENCY OF EMISSION (MHz)	CONDUCTED LIMIT (dB μ V)	
	Quasi-peak	Average
0.15-0.5	66 to 56	56 to 46
0.5-5	56	46
5-30	60	50

- NOTE:**
1. The lower limit shall apply at the transition frequencies.
 2. The limit decreases in line with the logarithm of the frequency in the range of 0.15 to 0.50 MHz.
 3. All emanations from a class A/B digital device or system, including any network of conductors and apparatus connected thereto, shall not exceed the level of field strengths specified above.

4.1.2 TEST INSTRUMENTS

DESCRIPTION & MANUFACTURER	MODEL NO.	SERIAL NO.	CALIBRATED DATE	CALIBRATED UNTIL
ROHDE & SCHWARZ Test Receiver	ESCS 30	100287	March 11, 2008	March 10, 2009
Line-Impedance Stabilization Network(for EUT)	KNW-407	8-1395-12	May 07, 2008	May 06, 2009
Line-Impedance Stabilization Network(for Peripheral)	ENV-216	100072	June 13, 2008	June 12, 2009
RF Cable (JYEBAO)	5DFB	COACAB-001	July 24, 2008	July 23, 2009
50 ohms Terminator	50	3	Nov. 16, 2007	Nov. 15, 2008
Software	ADT_Cond_ V7.3.2	NA	NA	NA

- NOTE:**
1. The calibration interval of the above test instruments is 12 months and the calibrations are traceable to NML/ROC and NIST/USA.
 2. The test was performed in ADT Shielded Room No. A.
 3. The VCCI Con A Registration No. is C-817.

4.1.3 TEST PROCEDURES

- a. The EUT was placed 0.4 meters from the conducting wall of the shielded room with EUT being connected to the power mains through a line impedance stabilization network (LISN). Other support units were connected to the power mains through another LISN. The two LISNs provide 50 ohm/ 50uH of coupling impedance for the measuring instrument.
- b. Both lines of the power mains connected to the EUT were checked for maximum conducted interference.
- c. The frequency range from 150kHz to 30MHz was searched. Emission levels under (Limit - 20dB) were not recorded.

4.1.4 DEVIATION FROM TEST STANDARD

No deviation

4.1.5 TEST SETUP

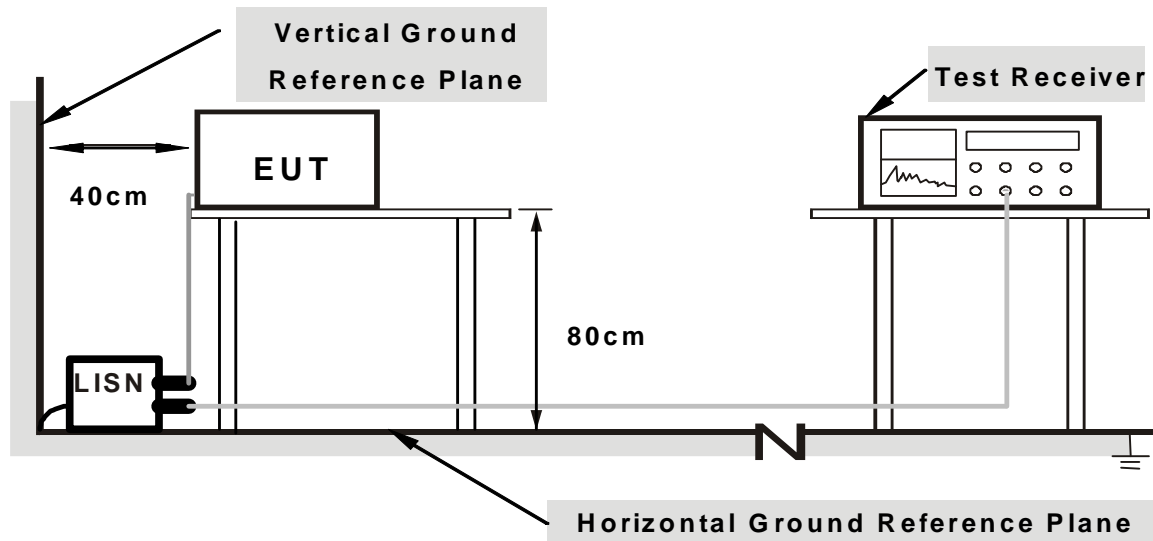

Note: 1.Support units were connected to second LISN.

2.Both of LISNs (AMN) are 80 cm from EUT and at least 80 from other units and other metal planes

For the actual test configuration, please refer to the related item – Photographs of the Test Configuration.

4.1.6 EUT OPERATING CONDITIONS

1. Placed the EUT on testing table.
2. Prepared other computer system (support units 1~3) to act as communication partner and placed them outside of testing area.
3. The communication partner run test program “ART 53b49” to enable EUT under transmission/receiving condition continuously via wireless transmission.
4. Support units 4~5 (Telephone) are call to each other via EUT by TEL lines.

4.1.7 TEST RESULTS

CHANNEL	Channel 6	PHASE	Line (L)
MODULATION TYPE	BPSK	6dB BANDWIDTH	9 kHz
TRANSFER RATE	6Mbps	INPUT POWER	120Vac, 60 Hz
ENVIRONMENTAL CONDITIONS	25deg. C, 60%RH, 965hPa	TESTED BY	Max Tseng

No	Freq. [MHz]	Corr. Factor (dB)	Reading Value		Emission Level		Limit		Margin	
			[dB (uV)]		[dB (uV)]		[dB (uV)]		(dB)	
			Q.P.	AV.	Q.P.	AV.	Q.P.	AV.	Q.P.	AV.
1	0.201	0.68	43.97	-	44.65	-	63.58	53.58	-18.93	-
2	0.533	0.48	41.26	-	41.74	-	56.00	46.00	-14.26	-
3	0.736	0.55	34.64	-	35.19	-	56.00	46.00	-20.81	-
4	1.070	0.65	31.38	-	32.03	-	56.00	46.00	-23.97	-
5	2.262	0.62	29.58	-	30.20	-	56.00	46.00	-25.80	-
6	21.660	1.14	33.43	-	34.57	-	60.00	50.00	-25.43	-

- REMARKS:**
1. Q.P. and AV. are abbreviations of quasi-peak and average individually.
 2. "-": The Quasi-peak reading value also meets average limit and measurement with the average detector is unnecessary.
 3. The emission levels of other frequencies were very low against the limit.
 4. Margin value = Emission level - Limit value
 5. Correction factor = Insertion loss + Cable loss
 6. Emission Level = Correction Factor + Reading Value.

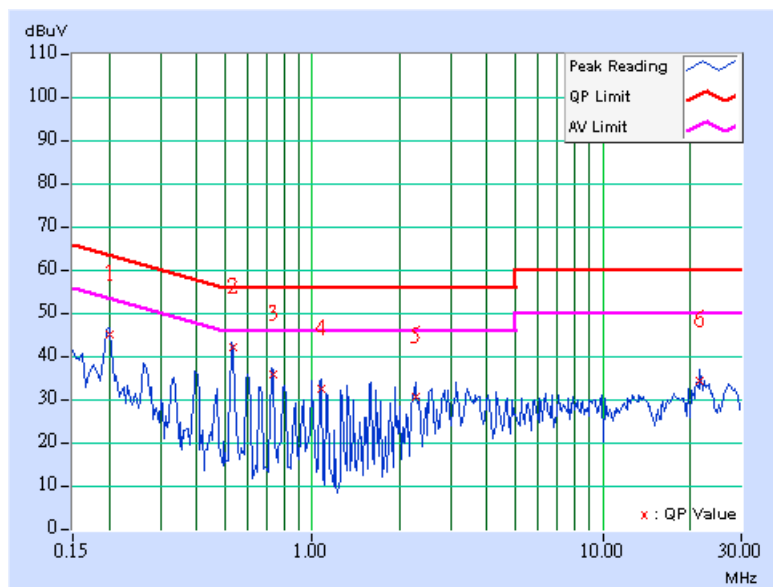

CHANNEL	Channel 6	PHASE	Neutral (N)
MODULATION TYPE	BPSK	6dB BANDWIDTH	9 kHz
TRANSFER RATE	6Mbps	INPUT POWER	120Vac, 60 Hz
ENVIRONMENTAL CONDITIONS	25deg. C, 60%RH, 965hPa	TESTED BY	Max Tseng

No	Freq. [MHz]	Corr. Factor (dB)	Reading Value		Emission Level		Limit		Margin	
			[dB (uV)]		[dB (uV)]		[dB (uV)]		(dB)	
			Q.P.	AV.	Q.P.	AV.	Q.P.	AV.	Q.P.	AV.
1	0.201	0.43	42.61	-	43.04	-	63.58	53.58	-20.54	-
2	0.530	0.25	40.11	-	40.36	-	56.00	46.00	-15.64	-
3	0.591	0.27	36.04	-	36.31	-	56.00	46.00	-19.69	-
4	0.728	0.31	32.70	-	33.01	-	56.00	46.00	-22.99	-
5	3.117	0.45	31.59	-	32.04	-	56.00	46.00	-23.96	-
6	20.379	0.96	32.70	-	33.66	-	60.00	50.00	-26.34	-

- REMARKS:**
1. Q.P. and AV. are abbreviations of quasi-peak and average individually.
 2. "-": The Quasi-peak reading value also meets average limit and measurement with the average detector is unnecessary.
 3. The emission levels of other frequencies were very low against the limit.
 4. Margin value = Emission level - Limit value
 5. Correction factor = Insertion loss + Cable loss
 6. Emission Level = Correction Factor + Reading Value.

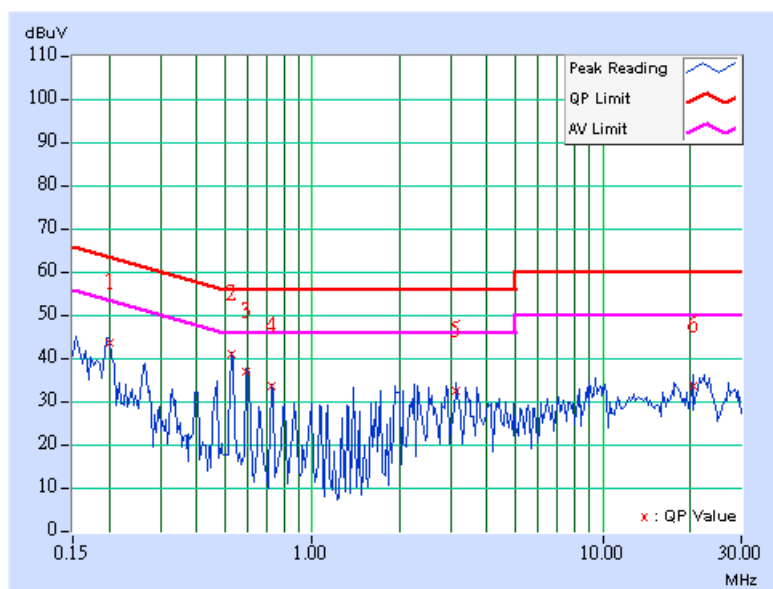

4.2 RADIATED EMISSION MEASUREMENT

4.2.1 LIMITS OF RADIATED EMISSION MEASUREMENT

Emissions radiated outside of the specified bands, shall be according to the general radiated limits in 15.209 as following:

Frequencies (MHz)	Field strength (microvolts/meter)	Measurement distance (meters)
0.009-0.490	2400/F(kHz)	300
0.490-1.705	24000/F(kHz)	30
1.705-30.0	30	30
30-88	100	3
88-216	150	3
216-960	200	3
Above 960	500	3

NOTE:

1. The lower limit shall apply at the transition frequencies.
2. Emission level (dBuV/m) = 20 log Emission level (uV/m).
3. As shown in 15.35(b), for frequencies above 1000MHz, the field strength limits are based on average detector, however, the peak field strength of any emission shall not exceed the maximum permitted average limits, specified above by more than 20dB under any condition of modulation.



4.2.2 TEST INSTRUMENTS

DESCRIPTION & MANUFACTURER	MODEL NO.	SERIAL NO.	CALIBRATED DATE	CALIBRATED UNTIL
ADVANTEST Spectrum Analyzer	R3271A	85060311	July 22, 2008	July 21, 2009
HP Pre_Amplifier	8449B	3008A0192 2	Oct. 05, 2007	Oct. 04, 2008
ROHDE & SCHWARZ Test Receiver	ESCS 30	841977/002	Nov. 13, 2007	Nov. 12, 2008
SCHAFFNER(CHASE) Broadband Antenna	CBL6112B	2798	April 30, 2008	April 29, 2009
Schwarzbeck Horn_Antenna	BBHA9120-D1	D123	Oct. 05, 2007	Oct. 04, 2008
Schwarzbeck Horn_Antenna	BBHA 9170	BBHA91701 53	Jan. 28, 2008	Jan. 27, 2009
RF Switches	MP59B	610017559 3	Aug. 10, 2008	Aug. 09, 2009
RF Cable	8DFB	STBCAB-30 M-1GHz	Sep. 08, 2007	Sep. 07, 2008
Software	ADT_Radiated _V7.6.15.8	NA	NA	NA
CHANCE MOST Antenna Tower	AT-100	CM-A007	NA	NA
CHANCE MOST Turn Table	TC-008	CM-T007	NA	NA
CORCOM AC Filter	MRI2030	024/019	NA	NA

- Note: 1. The calibration interval of the above test instruments is 12 months and the calibrations are traceable to NML/ROC and NIST/USA.
2. The horn antenna, HP preamplifier (model: 8449B) and Spectrum Analyzer (model: R3271A) are used only for the measurement of emission frequency above 1GHz if tested.
3. The test was performed in ADT Open Site No. B.
4. The VCCI Site Registration No. is R-847.
5. The FCC Site Registration No. is 92753.
6. The CANADA Site Registration No. is IC 3789C-2.

4.2.3 TEST PROCEDURES

- a. The EUT was placed on the top of a rotating table 0.8 meters above the ground at a 10-meter open field site. The table was rotated 360 degrees to determine the position of the highest radiation.
- b. The EUT was set 3 meters away from the interference-receiving antenna, which was mounted on the top of a variable-height antenna tower.
- c. The antenna is a broadband antenna, and its height is varied from one meter to four meters above the ground to determine the maximum value of the field strength. Both horizontal and vertical polarizations of the antenna are set to make the measurement.
- d. For each suspected emission, the EUT was arranged to its worst case and then the antenna was tuned to heights from 1 meter to 4 meters and the rotatable table was turned from 0 degrees to 360 degrees to find the maximum reading.
- e. The test-receiver system was set to Peak Detect Function and Specified Bandwidth with Maximum Hold Mode.
- f. If the emission level of the EUT in peak mode was 10 dB lower than the limit specified, then testing could be stopped and the peak values of the EUT would be reported. Otherwise the emissions that did not have 10 dB margin would be re-tested one by one using the quasi-peak method or average method as specified and then reported in Data sheet peak mode and QP mode.

NOTE:

1. The resolution bandwidth and video bandwidth of test receiver/spectrum analyzer is 120kHz for Peak detection (PK) and Quasi-peak detection (QP) at frequency below 1GHz.
2. The resolution bandwidth of test receiver/spectrum analyzer is 1 MHz and the video bandwidth is 3 MHz for Peak detection (PK) at frequency above 1GHz.
3. The resolution bandwidth of test receiver/spectrum analyzer is 1 MHz and the video bandwidth is 10 Hz for Average detection (AV) at frequency above 1GHz.

4.2.4 DEVIATION FROM TEST STANDARD

No deviation

4.2.5 TEST SETUP

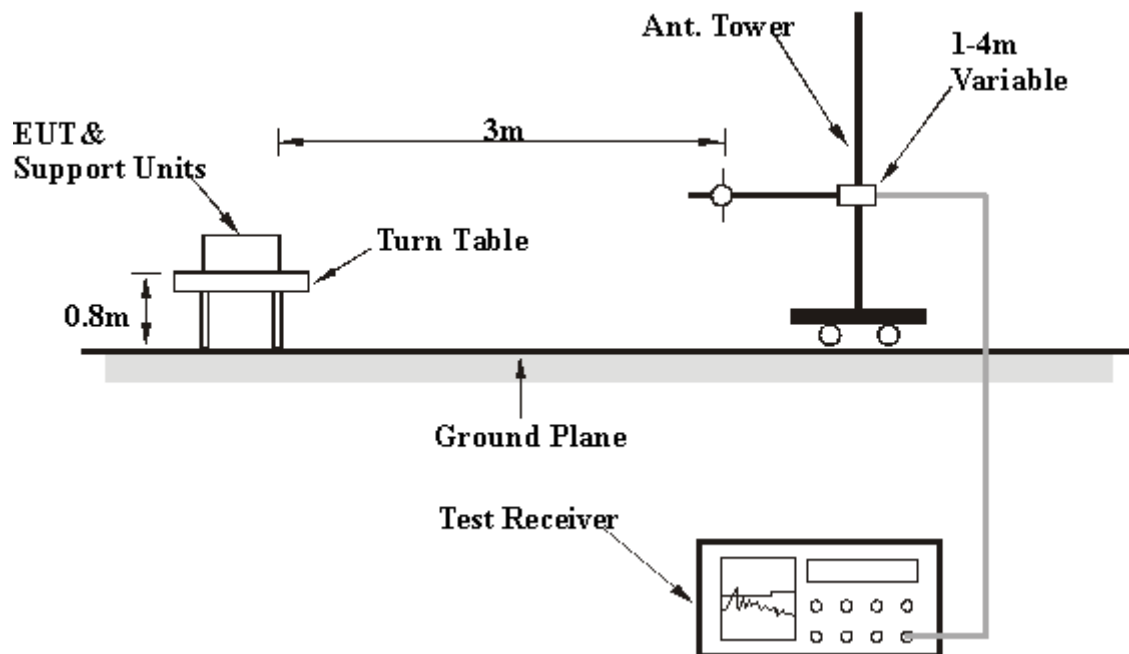

For the actual test configuration, please refer to the related item – Photographs of the Test Configuration.

4.2.6 EUT OPERATING CONDITIONS

Same as 4.1.6

4.2.7 TEST RESULTS

BELOW 1GHz WORST-CASE DATA : 802.11b DSSS MODULATION

EUT TEST CONDITION		MEASUREMENT DETAIL	
CHANNEL	Channel 1	FREQUENCY RANGE	Below 1000MHz
INPUT POWER (SYSTEM)	120Vac, 60 Hz	DETECTOR FUNCTION	Quasi-Peak
ENVIRONMENTAL CONDITIONS	28deg. C, 72%RH 955hPa	TESTED BY	Wen Yu

ANTENNA POLARITY & TEST DISTANCE: HORIZONTAL AT 3 M								
NO.	FREQ. (MHz)	EMISSION LEVEL (dBuV/m)	LIMIT (dBuV/m)	MARGIN (dB)	ANTENNA HEIGHT (m)	TABLE ANGLE (Degree)	RAW VALUE (dBuV)	CORRECTION FACTOR (dB/m)
1	108.02	33.97 QP	43.50	-9.53	1.00 H	277	22.54	11.43
2	199.99	37.52 QP	43.50	-5.98	1.12 H	35	27.65	9.87
3	224.98	32.67 QP	46.00	-13.33	1.23 H	227	20.55	12.12
4	227.70	31.19 QP	46.00	-14.81	1.33 H	28	18.82	12.36
5	250.20	37.61 QP	46.00	-8.39	1.00 H	67	23.24	14.37
6	324.99	35.26 QP	46.00	-10.74	1.00 H	66	20.14	15.12
7	375.00	35.87 QP	46.00	-10.13	1.00 H	330	19.31	16.56
8	499.99	37.27 QP	46.00	-8.73	1.00 H	111	17.28	19.99
9	849.96	34.58 QP	46.00	-11.42	1.00 H	255	7.89	26.69
10	875.00	32.88 QP	46.00	-13.12	1.00 H	184	5.75	27.13

ANTENNA POLARITY & TEST DISTANCE: VERTICAL AT 3 M								
NO.	FREQ. (MHz)	EMISSION LEVEL (dBuV/m)	LIMIT (dBuV/m)	MARGIN (dB)	ANTENNA HEIGHT (m)	TABLE ANGLE (Degree)	RAW VALUE (dBuV)	CORRECTION FACTOR (dB/m)
1	108.77	34.55 QP	43.50	-8.95	1.00 V	224	23.03	11.52
2	125.03	32.12 QP	43.50	-11.38	1.00 V	228	19.03	13.09
3	143.24	33.48 QP	43.50	-10.02	1.00 V	123	20.48	13.00
4	175.25	33.01 QP	43.50	-10.49	1.00 V	25	22.56	10.45
5	197.29	32.68 QP	43.50	-10.82	1.00 V	117	22.72	9.96
6	224.68	34.75 QP	46.00	-11.25	1.00 V	28	22.66	12.09
7	227.65	35.87 QP	46.00	-10.13	1.00 V	128	23.51	12.36
8	299.99	37.42 QP	46.00	-8.58	1.22 V	95	23.00	14.42
9	500.00	35.45 QP	46.00	-10.55	1.00 V	167	15.46	19.99
10	875.02	36.85 QP	46.00	-9.15	1.25 V	352	9.72	27.13

- REMARKS:**
1. Emission level (dBuV/m) = Raw Value (dBuV) + Correction Factor (dB/m).
 2. Correction Factor (dB/m) = Antenna Factor (dB/m) + Cable Factor (dB).
 3. The other emission levels were very low against the limit.
 4. Margin value = Emission level – Limit value.

802.11b DSSS MODULATION

EUT TEST CONDITION		MEASUREMENT DETAIL	
CHANNEL	Channel 1	FREQUENCY RANGE	1 ~ 25GHz
INPUT POWER (SYSTEM)	120Vac, 60 Hz	DETECTOR FUNCTION	Peak (PK) Average (AV)
ENVIRONMENTAL CONDITIONS	28deg. C, 72%RH 955hPa	TESTED BY	Wen Yu

ANTENNA POLARITY & TEST DISTANCE: HORIZONTAL AT 3 M								
NO.	FREQ. (MHz)	EMISSION LEVEL (dBuV/m)	LIMIT (dBuV/m)	MARGIN (dB)	ANTENNA HEIGHT (m)	TABLE ANGLE (Degree)	RAW VALUE (dBuV)	CORRECTION FACTOR (dB/m)
1	2386.40	59.02 PK	74.00	-14.98	1.43 H	12	28.97	30.05
2	2386.40	50.14 AV	54.00	-3.86	1.43 H	12	20.09	30.05
3	*2412.00	105.60 PK			1.45 H	13	75.45	30.15
4	*2412.00	100.20 AV			1.45 H	13	70.05	30.15
5	4824.00	47.20 PK	74.00	-26.80	1.19 H	28	11.74	35.46
6	4824.00	36.20 AV	54.00	-17.80	1.19 H	28	0.74	35.46
7	7236.00	51.30 PK	85.60	-34.30	1.47 H	29	9.45	41.85
8	7236.00	37.20 AV	80.20	-43.00	1.47 H	29	-4.65	41.85
ANTENNA POLARITY & TEST DISTANCE: VERTICAL AT 3 M								
NO.	FREQ. (MHz)	EMISSION LEVEL (dBuV/m)	LIMIT (dBuV/m)	MARGIN (dB)	ANTENNA HEIGHT (m)	TABLE ANGLE (Degree)	RAW VALUE (dBuV)	CORRECTION FACTOR (dB/m)
1	2386.40	61.06 PK	74.00	-12.94	1.00 V	31	31.01	30.05
2	2386.40	53.35 AV	54.00	-0.65	1.00 V	31	23.30	30.05
3	*2412.00	109.90 PK			1.00 V	29	79.75	30.15
4	*2412.00	104.00 AV			1.00 V	29	73.85	30.15
5	4824.00	46.30 PK	74.00	-27.70	1.01 V	357	10.84	35.46
6	4824.00	34.20 AV	54.00	-19.80	1.01 V	357	-1.26	35.46
7	7236.00	53.70 PK	89.90	-36.20	1.37 V	16	11.85	41.85
8	7236.00	41.70 AV	84.00	-42.30	1.37 V	16	-0.15	41.85

- REMARKS:**
1. Emission level (dBuV/m) = Raw Value (dBuV) + Correction Factor (dB/m).
 2. Correction Factor (dB/m) = Antenna Factor (dB/m) + Cable Factor (dB).
 3. The other emission levels were very low against the limit.
 4. Margin value = Emission level – Limit value.
 5. “ * “: Fundamental frequency.

EUT TEST CONDITION		MEASUREMENT DETAIL	
CHANNEL	Channel 6	FREQUENCY RANGE	1 ~ 25GHz
INPUT POWER (SYSTEM)	120Vac, 60 Hz	DETECTOR FUNCTION	Peak (PK) Average (AV)
ENVIRONMENTAL CONDITIONS	28deg. C, 72%RH 955hPa	TESTED BY	Wen Yu

ANTENNA POLARITY & TEST DISTANCE: HORIZONTAL AT 3 M								
NO.	FREQ. (MHz)	EMISSION LEVEL (dBuV/m)	LIMIT (dBuV/m)	MARGIN (dB)	ANTENNA HEIGHT (m)	TABLE ANGLE (Degree)	RAW VALUE (dBuV)	CORRECTION FACTOR (dB/m)
1	*2437.00	109.70 PK			1.44 H	11	79.46	30.24
2	*2437.00	104.61 AV			1.44 H	11	74.37	30.24
3	4874.00	51.60 PK	74.00	-22.40	1.13 H	36	16.05	35.55
4	4874.00	48.70 AV	54.00	-5.30	1.13 H	36	13.15	35.55
5	7311.00	57.20 PK	74.00	-16.80	1.42 H	26	15.16	42.04
6	7311.00	48.90 AV	54.00	-5.10	1.42 H	26	6.86	42.04
ANTENNA POLARITY & TEST DISTANCE: VERTICAL AT 3 M								
NO.	FREQ. (MHz)	EMISSION LEVEL (dBuV/m)	LIMIT (dBuV/m)	MARGIN (dB)	ANTENNA HEIGHT (m)	TABLE ANGLE (Degree)	RAW VALUE (dBuV)	CORRECTION FACTOR (dB/m)
1	*2437.00	112.60 PK			1.00 V	44	82.36	30.24
2	*2437.00	108.20 AV			1.00 V	44	77.96	30.24
3	4874.00	52.10 PK	74.00	-21.90	1.14 V	351	16.55	35.55
4	4874.00	47.80 AV	54.00	-6.20	1.14 V	351	12.25	35.55
5	7311.00	59.45 PK	74.00	-14.55	1.35 V	0	17.41	42.04
6	7311.00	52.50 AV	54.00	-1.50	1.35 V	0	10.46	42.04

- REMARKS:**
1. Emission level (dBuV/m) = Raw Value (dBuV) + Correction Factor (dB/m).
 2. Correction Factor (dB/m) = Antenna Factor (dB/m) + Cable Factor (dB).
 3. The other emission levels were very low against the limit.
 4. Margin value = Emission level – Limit value.
 5. “ * “: Fundamental frequency.

EUT TEST CONDITION		MEASUREMENT DETAIL	
CHANNEL	Channel 11	FREQUENCY RANGE	1 ~ 25GHz
INPUT POWER (SYSTEM)	120Vac, 60 Hz	DETECTOR FUNCTION	Peak (PK) Average (AV)
ENVIRONMENTAL CONDITIONS	28deg. C, 72%RH 955hPa	TESTED BY	Wen Yu

ANTENNA POLARITY & TEST DISTANCE: HORIZONTAL AT 3 M								
NO.	FREQ. (MHz)	EMISSION LEVEL (dBuV/m)	LIMIT (dBuV/m)	MARGIN (dB)	ANTENNA HEIGHT (m)	TABLE ANGLE (Degree)	RAW VALUE (dBuV)	CORRECTION FACTOR (dB/m)
1	*2462.00	108.40 PK			1.46 H	2	78.06	30.34
2	*2462.00	103.30 AV			1.46 H	2	72.96	30.34
3	2484.68	56.61 PK	74.00	-17.39	1.47 H	0	26.18	30.43
4	2484.68	46.00 AV	54.00	-8.00	1.47 H	0	15.57	30.43
5	4924.00	50.30 PK	74.00	-23.70	1.11 H	57	14.67	35.63
6	4924.00	47.00 AV	54.00	-7.00	1.11 H	57	11.37	35.63
7	7386.00	54.30 PK	74.00	-19.70	1.41 H	27	12.07	42.23
8	7386.00	43.20 AV	54.00	-10.80	1.41 H	27	0.97	42.23
ANTENNA POLARITY & TEST DISTANCE: VERTICAL AT 3 M								
NO.	FREQ. (MHz)	EMISSION LEVEL (dBuV/m)	LIMIT (dBuV/m)	MARGIN (dB)	ANTENNA HEIGHT (m)	TABLE ANGLE (Degree)	RAW VALUE (dBuV)	CORRECTION FACTOR (dB/m)
1	*2462.00	113.50 PK			1.00 V	346	83.16	30.34
2	*2462.00	108.60 AV			1.00 V	346	78.26	30.34
3	2483.50	61.44 PK	74.00	-12.56	1.00 V	343	31.01	30.43
4	2483.50	53.14 AV	54.00	-0.86	1.00 V	343	22.71	30.43
5	4924.00	49.90 PK	74.00	-24.10	1.13 V	1	14.27	35.63
6	4924.00	44.30 AV	54.00	-9.70	1.13 V	1	8.67	35.63
7	7386.00	55.90 PK	74.00	-18.10	1.33 V	357	13.67	42.23
8	7386.00	47.00 AV	54.00	-7.00	1.33 V	357	4.77	42.23

- REMARKS:**
1. Emission level (dBuV/m) = Raw Value (dBuV) + Correction Factor (dB/m).
 2. Correction Factor (dB/m) = Antenna Factor (dB/m) + Cable Factor (dB).
 3. The other emission levels were very low against the limit.
 4. Margin value = Emission level – Limit value.
 5. “ * “: Fundamental frequency.

RESTRICTED BANDEDGE (802.11b MODE, CH11, HORIZONTAL)

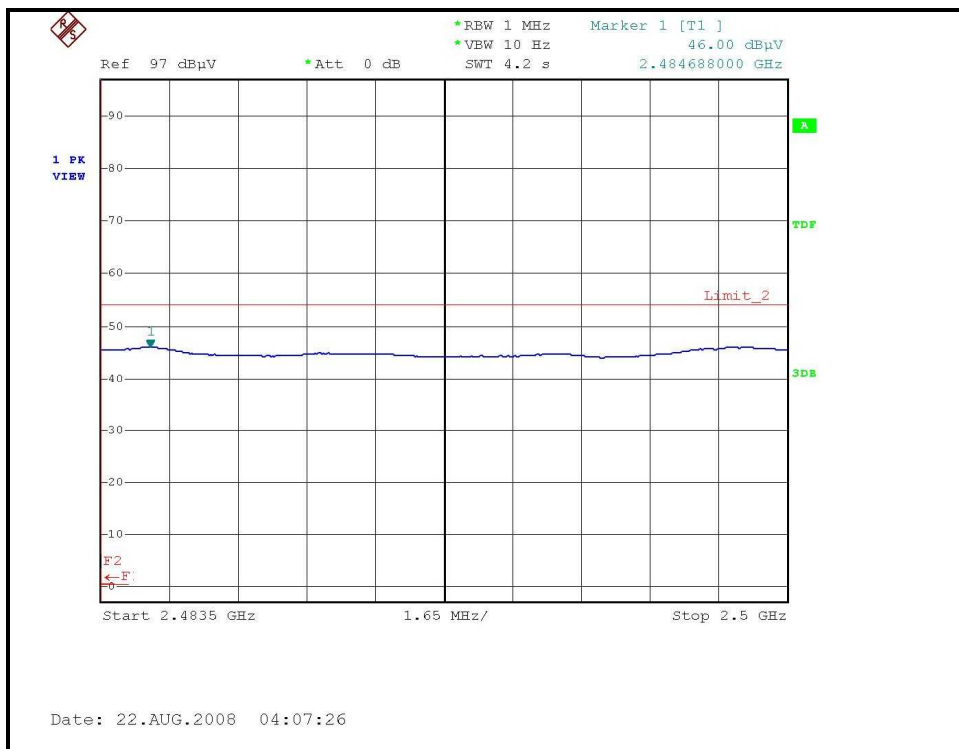
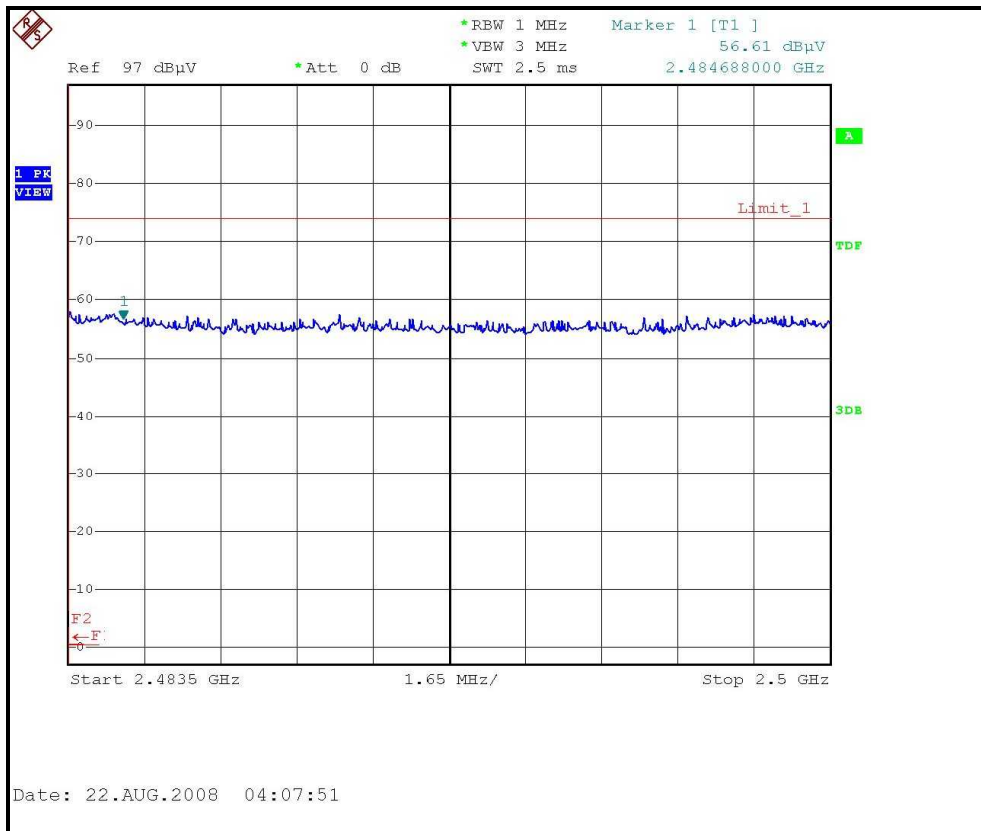

RESTRICTED BANDEDGE (802.11b MODE,CH11, VERTICAL)

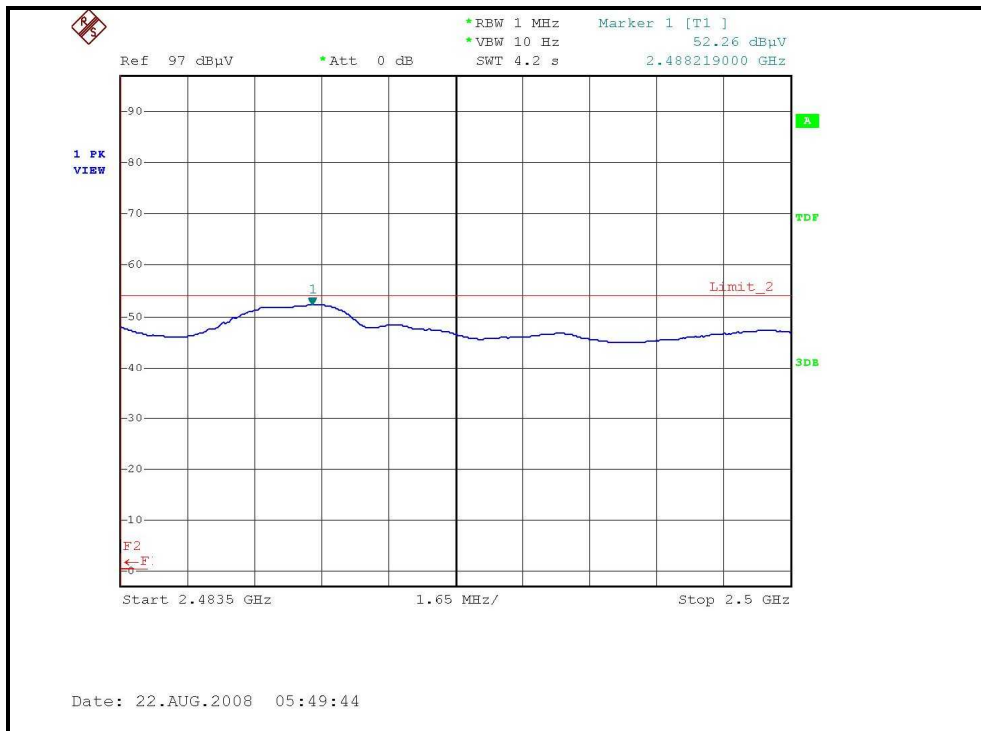
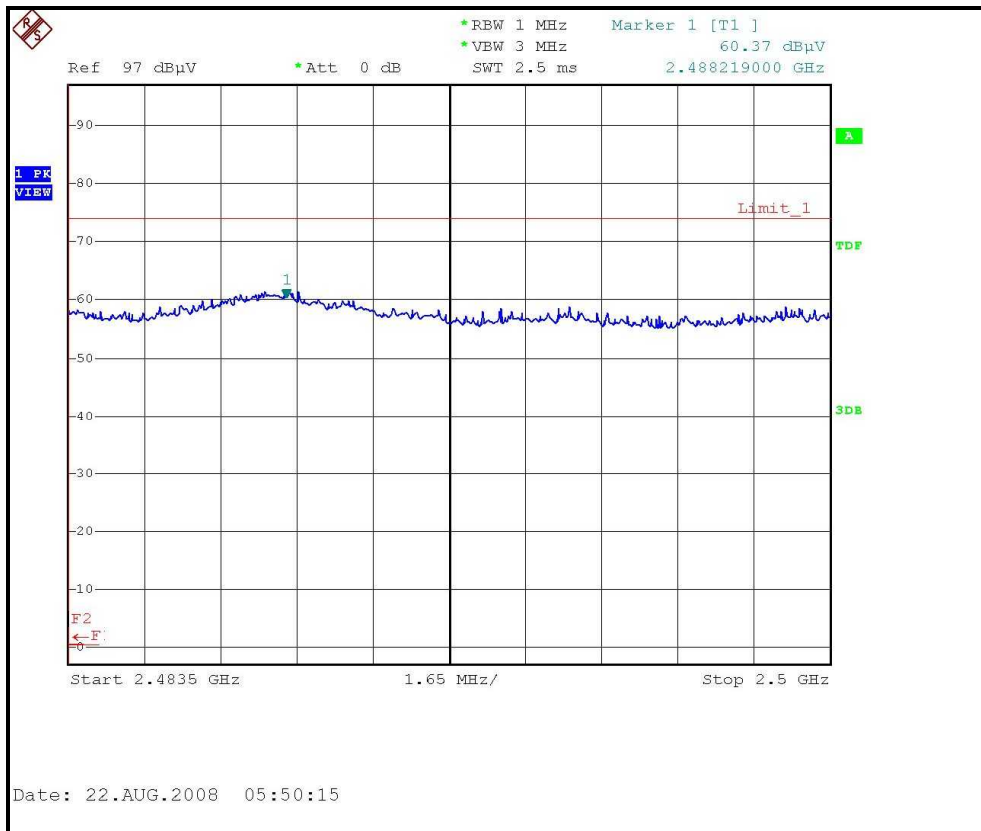

802.11g OFDM MODULATION

EUT TEST CONDITION		MEASUREMENT DETAIL	
CHANNEL	Channel 1	FREQUENCY RANGE	1 ~ 25GHz
INPUT POWER (SYSTEM)	120Vac, 60 Hz	DETECTOR FUNCTION	Peak (PK) Average (AV)
ENVIRONMENTAL CONDITIONS	28deg. C, 72%RH 955hPa	TESTED BY	Wen Yu

ANTENNA POLARITY & TEST DISTANCE: HORIZONTAL AT 3 M								
NO.	FREQ. (MHz)	EMISSION LEVEL (dBuV/m)	LIMIT (dBuV/m)	MARGIN (dB)	ANTENNA HEIGHT (m)	TABLE ANGLE (Degree)	RAW VALUE (dBuV)	CORRECTION FACTOR (dB/m)
1	2390.00	64.30 PK	74.00	-9.70	1.45 H	15	34.24	30.06
2	2390.00	49.04 AV	54.00	-4.96	1.45 H	15	18.98	30.06
3	*2412.00	107.20 PK			1.45 H	15	77.05	30.15
4	*2412.00	95.50 AV			1.45 H	15	65.35	30.15
5	4824.00	43.60 PK	74.00	-30.40	1.29 H	234	8.14	35.46
6	4824.00	30.20 AV	54.00	-23.80	1.29 H	234	-5.26	35.46
7	7236.00	54.60 PK	87.20	-32.60	1.44 H	213	12.75	41.85
8	7236.00	37.20 AV	75.50	-38.30	1.44 H	213	-4.65	41.85
ANTENNA POLARITY & TEST DISTANCE: VERTICAL AT 3 M								
NO.	FREQ. (MHz)	EMISSION LEVEL (dBuV/m)	LIMIT (dBuV/m)	MARGIN (dB)	ANTENNA HEIGHT (m)	TABLE ANGLE (Degree)	RAW VALUE (dBuV)	CORRECTION FACTOR (dB/m)
1	2390.00	70.89 PK	74.00	-3.11	1.00 V	27	40.83	30.06
2	2390.00	52.65 AV	54.00	-1.35	1.00 V	27	22.59	30.06
3	*2412.00	110.00 PK			1.00 V	16	79.85	30.15
4	*2412.00	98.70 AV			1.00 V	16	68.55	30.15
5	4824.00	44.70 PK	74.00	-29.30	1.12 V	346	9.24	35.46
6	4824.00	31.10 AV	54.00	-22.90	1.12 V	346	-4.36	35.46
7	7236.00	55.50 PK	90.00	-34.50	1.28 V	0	13.65	41.85
8	7236.00	38.80 AV	78.70	-39.90	1.28 V	0	-3.05	41.85

- REMARKS:**
1. Emission level (dBuV/m) = Raw Value (dBuV) + Correction Factor (dB/m).
 2. Correction Factor (dB/m) = Antenna Factor (dB/m) + Cable Factor (dB).
 3. The other emission levels were very low against the limit.
 4. Margin value = Emission level – Limit value.
 5. “ * “: Fundamental frequency.

EUT TEST CONDITION		MEASUREMENT DETAIL	
CHANNEL	Channel 6	FREQUENCY RANGE	1 ~ 25GHz
INPUT POWER (SYSTEM)	120Vac, 60 Hz	DETECTOR FUNCTION	Peak (PK) Average (AV)
ENVIRONMENTAL CONDITIONS	28deg. C, 72%RH 955hPa	TESTED BY	Wen Yu

ANTENNA POLARITY & TEST DISTANCE: HORIZONTAL AT 3 M								
NO.	FREQ. (MHz)	EMISSION LEVEL (dBuV/m)	LIMIT (dBuV/m)	MARGIN (dB)	ANTENNA HEIGHT (m)	TABLE ANGLE (Degree)	RAW VALUE (dBuV)	CORRECTION FACTOR (dB/m)
1	*2437.00	107.50 PK			1.44 H	13	77.26	30.24
2	*2437.00	96.20 AV			1.44 H	13	65.96	30.24
3	4874.00	43.90 PK	74.00	-30.10	1.27 H	262	8.35	35.55
4	4874.00	31.30 AV	54.00	-22.70	1.27 H	262	-4.25	35.55
5	7311.00	57.40 PK	74.00	-16.60	1.38 H	217	15.36	42.04
6	7311.00	38.20 AV	54.00	-15.80	1.38 H	217	-3.84	42.04
ANTENNA POLARITY & TEST DISTANCE: VERTICAL AT 3 M								
NO.	FREQ. (MHz)	EMISSION LEVEL (dBuV/m)	LIMIT (dBuV/m)	MARGIN (dB)	ANTENNA HEIGHT (m)	TABLE ANGLE (Degree)	RAW VALUE (dBuV)	CORRECTION FACTOR (dB/m)
1	*2437.00	109.80 PK			1.00 V	17	79.56	30.24
2	*2437.00	101.00 AV			1.00 V	17	70.76	30.24
3	4874.00	45.00 PK	74.00	-29.00	1.22 V	351	9.45	35.55
4	4874.00	32.10 AV	54.00	-21.90	1.22 V	351	-3.45	35.55
5	7311.00	58.00 PK	74.00	-16.00	1.36 V	3	15.96	42.04
6	7311.00	39.90 AV	54.00	-14.10	1.36 V	3	-2.14	42.04

- REMARKS:**
1. Emission level (dBuV/m) = Raw Value (dBuV) + Correction Factor (dB/m).
 2. Correction Factor (dB/m) = Antenna Factor (dB/m) + Cable Factor (dB).
 3. The other emission levels were very low against the limit.
 4. Margin value = Emission level – Limit value.
 5. “ * “: Fundamental frequency.

EUT TEST CONDITION		MEASUREMENT DETAIL	
CHANNEL	Channel 11	FREQUENCY RANGE	1 ~ 25GHz
INPUT POWER (SYSTEM)	120Vac, 60 Hz	DETECTOR FUNCTION	Peak (PK) Average (AV)
ENVIRONMENTAL CONDITIONS	28deg. C, 72%RH 955hPa	TESTED BY	Wen Yu

ANTENNA POLARITY & TEST DISTANCE: HORIZONTAL AT 3 M								
NO.	FREQ. (MHz)	EMISSION LEVEL (dBuV/m)	LIMIT (dBuV/m)	MARGIN (dB)	ANTENNA HEIGHT (m)	TABLE ANGLE (Degree)	RAW VALUE (dBuV)	CORRECTION FACTOR (dB/m)
1	*2462.00	106.20 PK			1.47 H	3	75.86	30.34
2	*2462.00	95.30 AV			1.47 H	3	64.96	30.34
3	2483.50	65.43 PK	74.00	-8.57	1.46 H	1	35.00	30.43
4	2483.50	48.03 AV	54.00	-5.97	1.46 H	1	17.60	30.43
5	4924.00	43.80 PK	74.00	-30.20	1.26 H	253	8.17	35.63
6	4924.00	30.10 AV	54.00	-23.90	1.26 H	253	-5.53	35.63
7	7386.00	54.20 PK	74.00	-19.80	1.39 H	218	11.97	42.23
8	7386.00	37.60 AV	54.00	-16.40	1.39 H	218	-4.63	42.23
ANTENNA POLARITY & TEST DISTANCE: VERTICAL AT 3 M								
NO.	FREQ. (MHz)	EMISSION LEVEL (dBuV/m)	LIMIT (dBuV/m)	MARGIN (dB)	ANTENNA HEIGHT (m)	TABLE ANGLE (Degree)	RAW VALUE (dBuV)	CORRECTION FACTOR (dB/m)
1	*2462.00	111.44 PK			1.00 V	343	81.10	30.34
2	*2462.00	100.30 AV			1.00 V	343	69.96	30.34
3	2483.50	73.30 PK	74.00	-0.70	1.00 V	17	42.87	30.43
4	2483.50	52.69 AV	54.00	-1.31	1.00 V	17	22.26	30.43
5	4924.00	44.90 PK	74.00	-29.10	1.14 V	340	9.27	35.63
6	4924.00	31.60 AV	54.00	-22.40	1.14 V	340	-4.03	35.63
7	7386.00	55.80 PK	74.00	-18.20	1.33 V	1	13.57	42.23
8	7386.00	38.90 AV	54.00	-15.10	1.33 V	1	-3.33	42.23

- REMARKS:**
1. Emission level (dBuV/m) = Raw Value (dBuV) + Correction Factor (dB/m).
 2. Correction Factor (dB/m) = Antenna Factor (dB/m) + Cable Factor (dB).
 3. The other emission levels were very low against the limit.
 4. Margin value = Emission level – Limit value.
 5. “ * “: Fundamental frequency.

RESTRICTED BANDEDGE (802.11g MODE, CH1, HORIZONTAL)

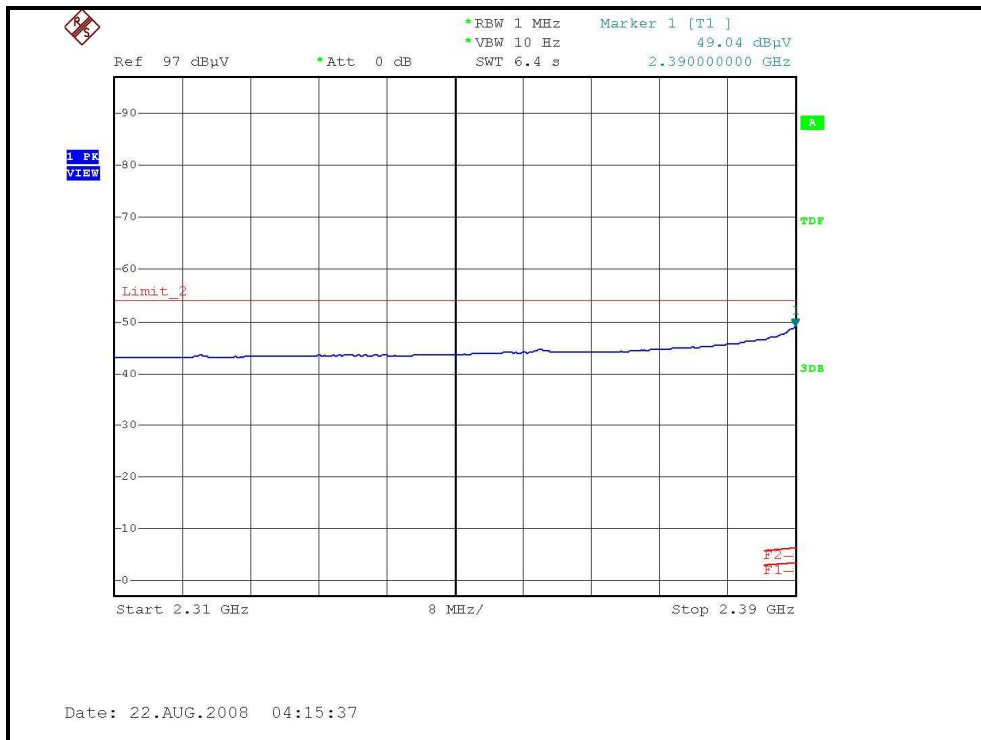
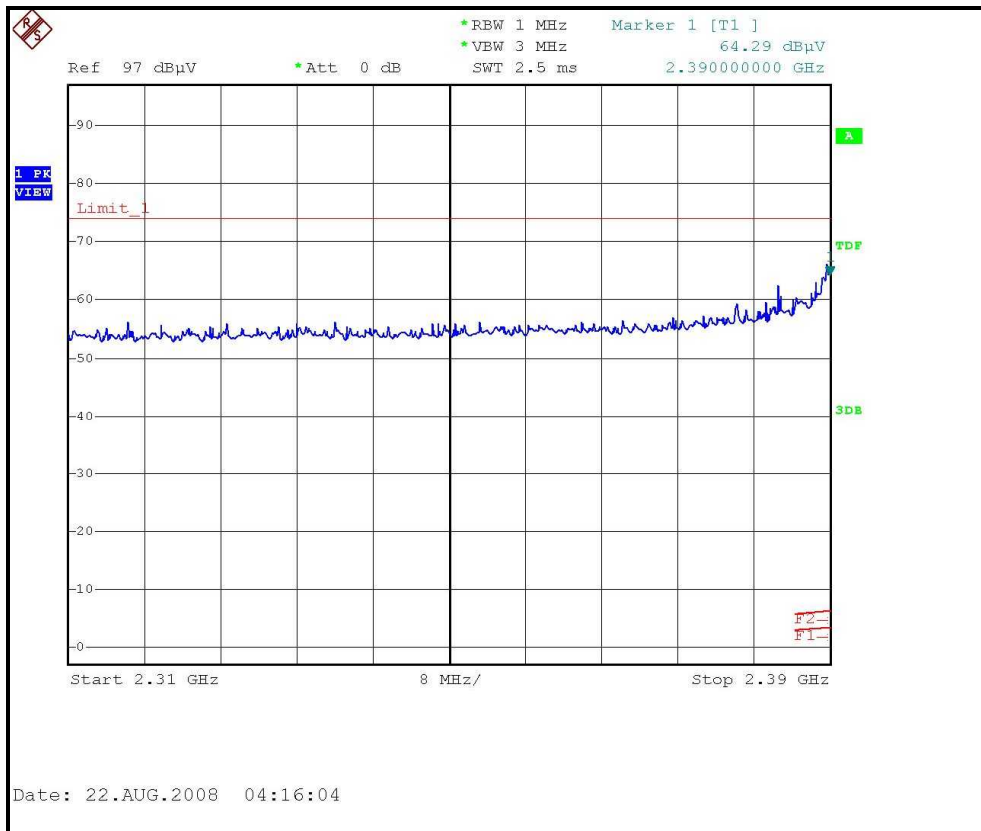

RESTRICTED BANDEDGE (802.11g MODE, CH1, VERTICAL)

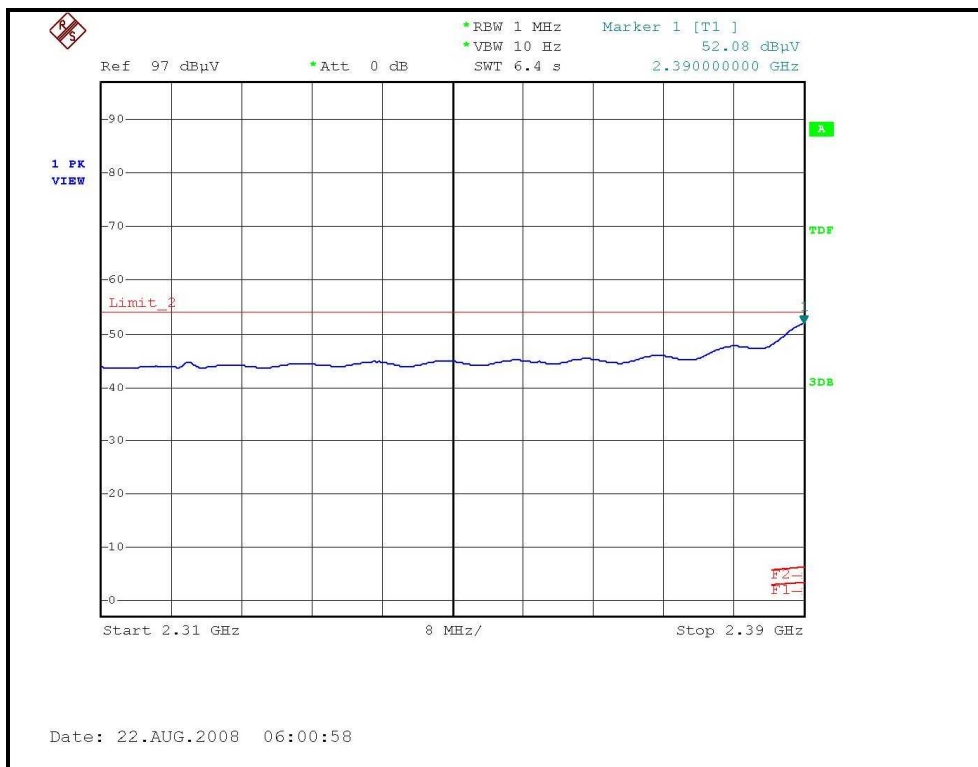
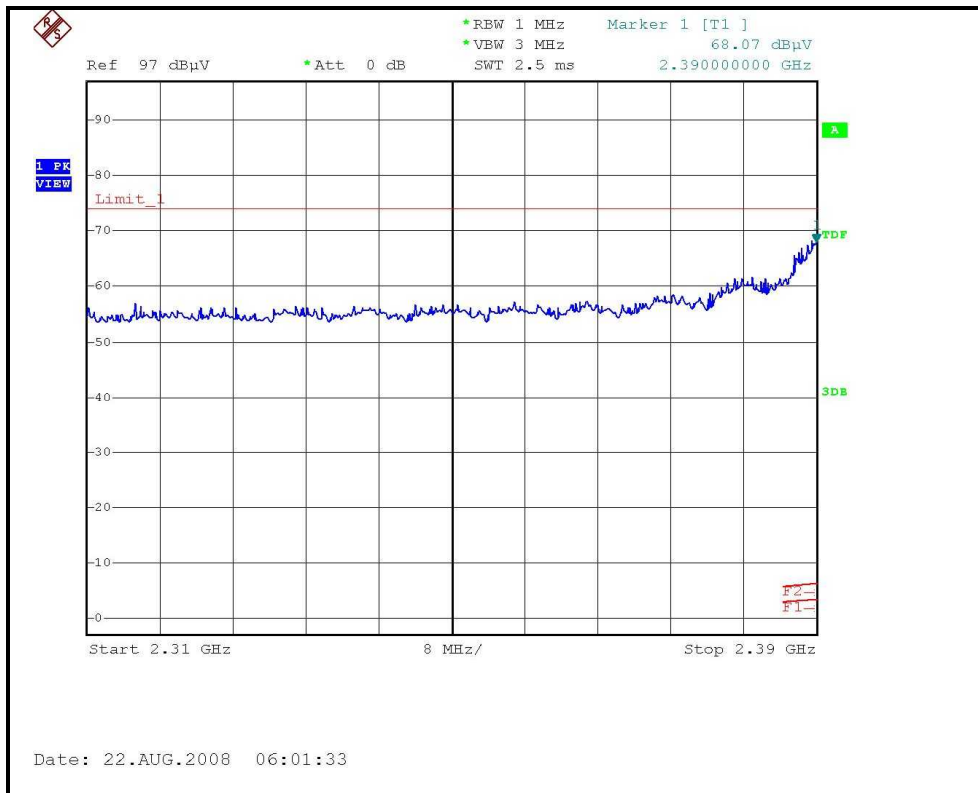

RESTRICTED BANDEDGE (802.11g MODE, CH11, VERTICAL)

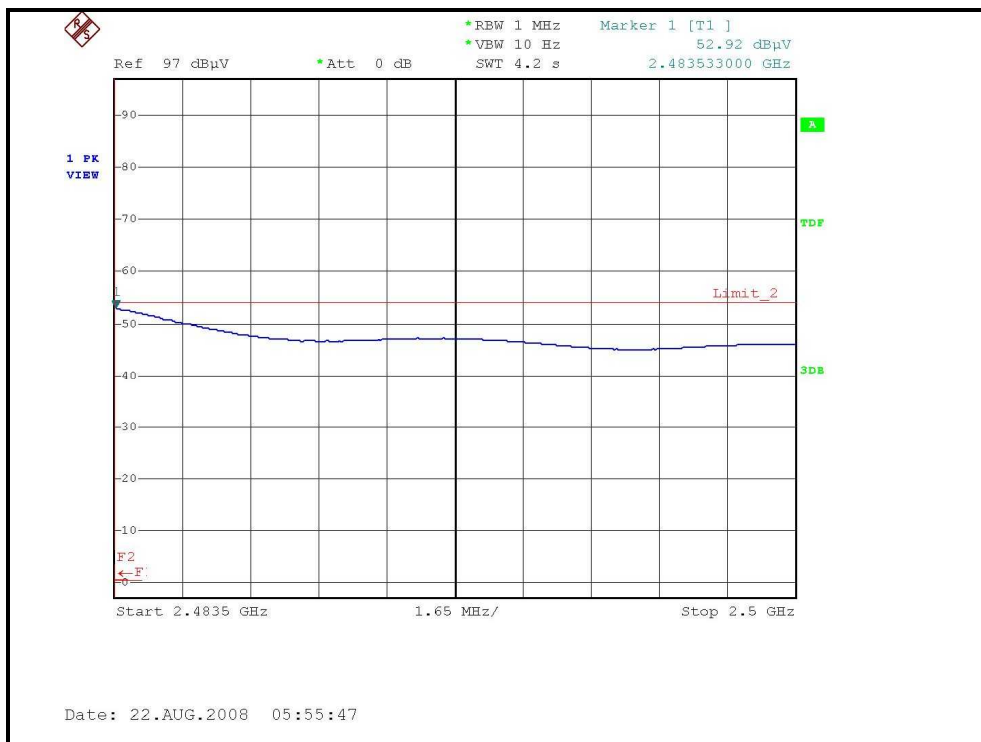
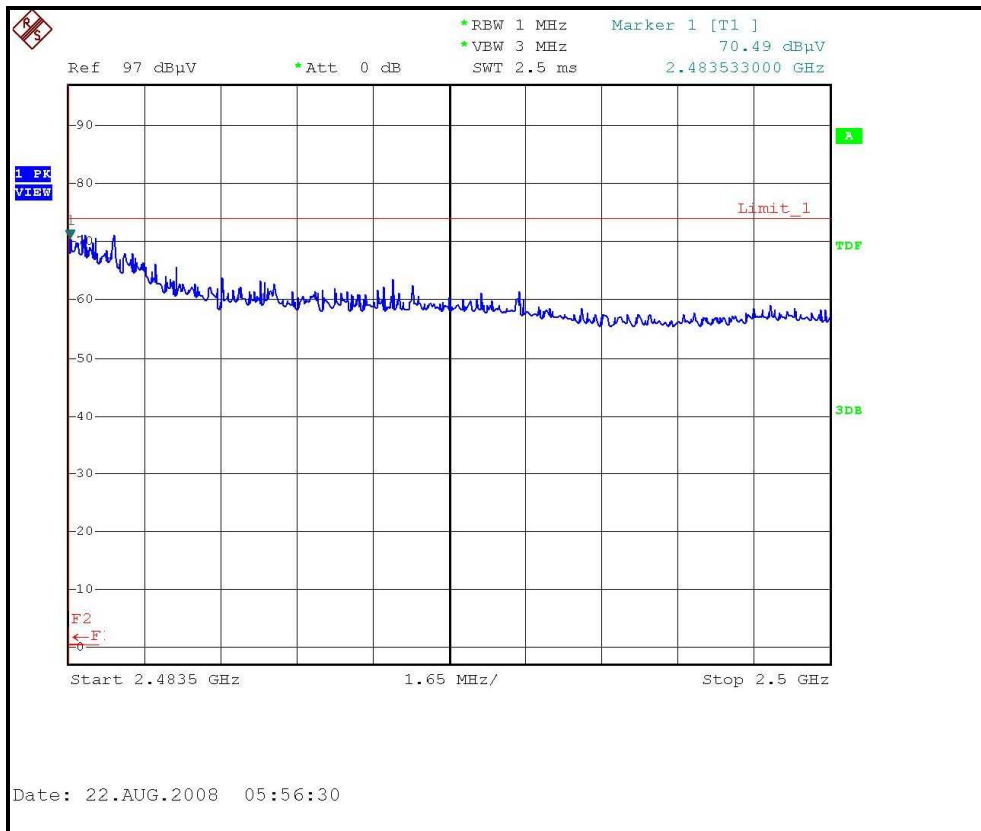

4.3 6dB BANDWIDTH MEASUREMENT

4.3.1 LIMITS OF 6dB BANDWIDTH MEASUREMENT

The minimum of 6dB Bandwidth Measurement is 0.5 MHz.

4.3.2 TEST INSTRUMENTS

Description & Manufacturer	Model No.	Serial No.	Calibrated Until
R&S SPECTRUM ANALYZER	FSP40	100037	Aug. 08, 2009

NOTE:

- 1.The measurement uncertainty is less than +/- 2.6dB, which is calculated as per the NAMAS document NIS81. This uncertainty represents an expanded uncertainty expressed at approximately the 95% confidence level using a coverage factor of k=2.
- 2.The calibration interval of the above test instruments is 12 months and the calibrations are traceable to NML/ROC and NIST/USA.

4.3.3 TEST PROCEDURE

The transmitter output was connected to the spectrum analyzer through an attenuator. The bandwidth of the fundamental frequency was measured by spectrum analyzer with 100kHz RBW and 100kHz VBW. The 6dB bandwidth is defined as the total spectrum the power of which is higher than peak power minus 6dB.

4.3.4 DEVIATION FROM TEST STANDARD

No deviation

4.3.5 TEST SETUP



4.3.6 EUT OPERATING CONDITIONS

The software provided by client to enable the EUT under transmission condition continuously at lowest, middle and highest channel frequencies individually.

4.3.7 TEST RESULTS

802.11b DSSS MODULATION:

MODULATION TYPE	DBPSK	TRANSFER RATE	1Mbps
INPUT POWER	120Vac, 60 Hz	ENVIRONMENTAL CONDITIONS	25deg.C, 60%RH, 955hPa
TESTED BY	Wen Yu		

CHANNEL	CHANNEL FREQUENCY (MHz)	6dB BANDWIDTH (MHz)	MINIMUM LIMIT (MHz)	PASS / FAIL
1	2412	12.13	0.5	PASS
6	2437	11.09	0.5	PASS
11	2462	11.06	0.5	PASS

CH1

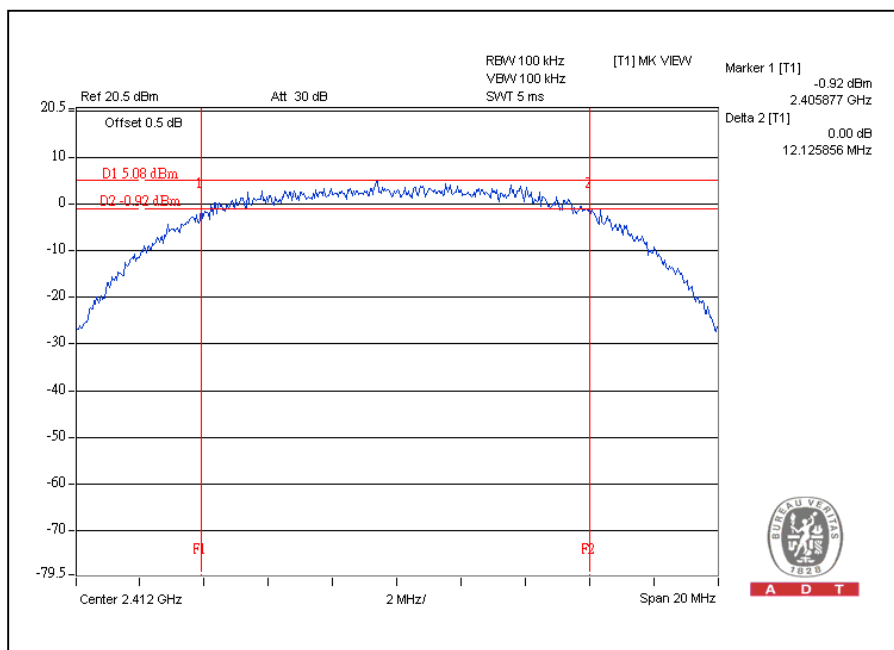

CH6

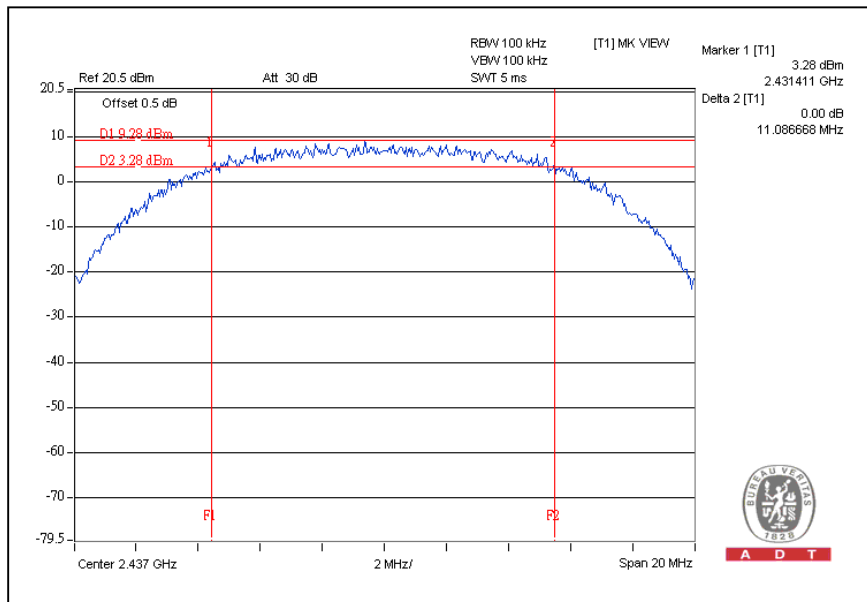

CH11

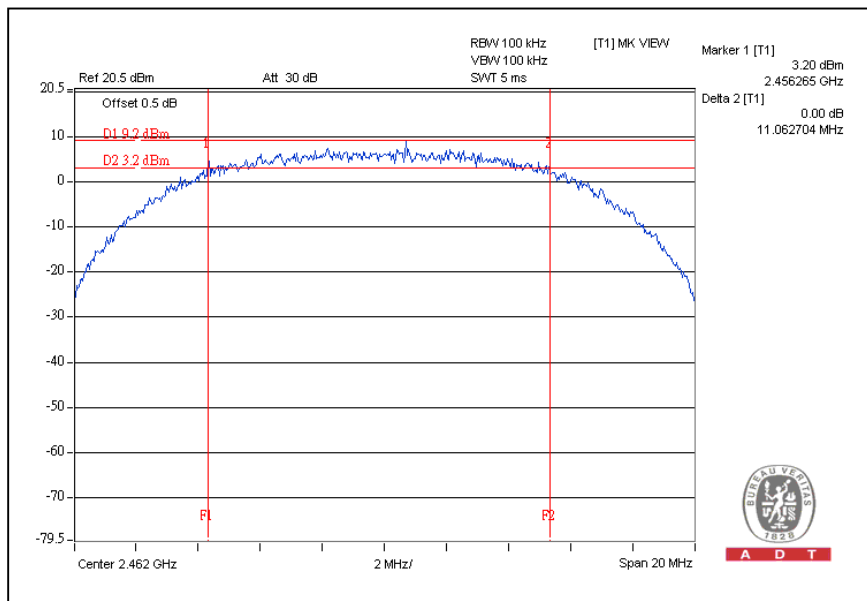

CH6

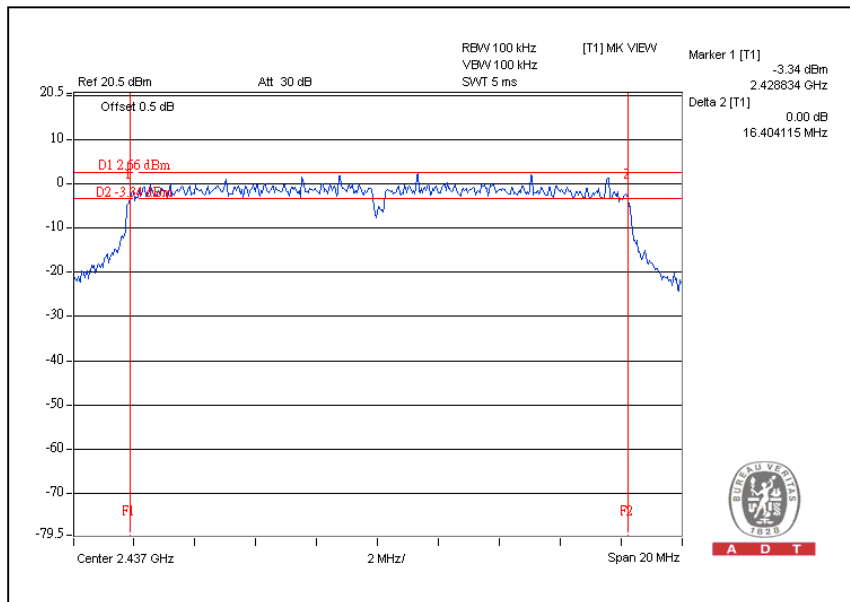

CH11

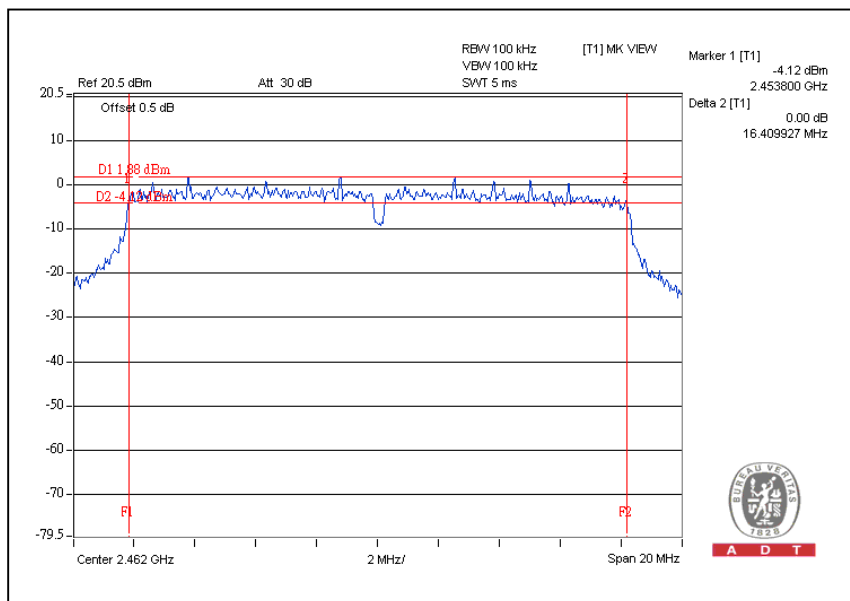

4.4 MAXIMUM PEAK OUTPUT POWER

4.4.1 LIMITS OF MAXIMUM PEAK OUTPUT POWER MEASUREMENT

The Maximum Peak Output Power Measurement is 30dBm.

4.4.2 INSTRUMENTS

Description & Manufacturer	Model No.	Serial No.	Calibrated Until
R&S SPECTRUM ANALYZER	FSP40	100037	Aug. 08, 2009
Agilent SIGNAL GENERATOR	E8257C	MY43320668	Dec. 25, 2008
TEKTRONIX OSCILLOSCOPE	TDS380	B016335	July 20, 2009
NARDA DETECTOR	4503A	FSCM99899	NA

NOTE:

The calibration interval of the above test instruments is 12 months and the calibrations are traceable to NML/ROC and NIST/USA.

4.4.3 TEST PROCEDURES

1. A detector was used on the output port of the EUT. An oscilloscope was used to read the response of the detector.
2. Replaced the EUT by the signal generator. The center frequency of the S.G was adjusted to the center frequency of the measured channel.
3. Adjusted the power to have the same reading on oscilloscope. Record the power level.

4.4.4 DEVIATION FROM TEST STANDARD

No deviation

4.4.5 TEST SETUP



4.4.6 EUT OPERATING CONDITIONS

Same as Item 4.3.6

4.4.7 TEST RESULTS

802.11b DSSS MODULATION:

MODULATION TYPE	DBPSK	TRANSFER RATE	1Mbps
INPUT POWER	120Vac, 60 Hz	ENVIRONMENTAL CONDITIONS	25deg.C, 60%RH, 955hPa
TESTED BY	Wen Yu		

CHANNEL	CHANNEL FREQUENCY (MHz)	PEAK POWER OUTPUT (mW)	PEAK POWER OUTPUT (dBm)	PEAK POWER LIMIT (dBm)	PASS / FAIL
1	2412	64.565	18.10	30	PASS
6	2437	149.279	21.74	30	PASS
11	2462	127.938	21.07	30	PASS

802.11g OFDM MODULATION:

MODULATION TYPE	BPSK	TRANSFER RATE	6Mbps
INPUT POWER	120Vac, 60 Hz	ENVIRONMENTAL CONDITIONS	25deg.C, 60%RH, 955hPa
TESTED BY	Wen Yu		

CHANNEL	CHANNEL FREQUENCY (MHz)	PEAK POWER OUTPUT (mW)	PEAK POWER OUTPUT (dBm)	PEAK POWER LIMIT (dBm)	PASS / FAIL
1	2412	167.880	22.25	30	PASS
6	2437	185.780	22.69	30	PASS
11	2462	160.694	22.06	30	PASS



4.5 POWER SPECTRAL DENSITY MEASUREMENT

4.5.1 LIMITS OF POWER SPECTRAL DENSITY MEASUREMENT

The Maximum of Power Spectral Density Measurement is 8dBm.

4.5.2 TEST INSTRUMENTS

Description & Manufacturer	Model No.	Serial No.	Calibrated Until
R&S SPECTRUM ANALYZER	FSP40	100037	Aug. 08, 2009

NOTE:

- 1.The measurement uncertainty is less than +/- 2.6dB, which is calculated as per the NAMAS document NIS81. This uncertainty represents an expanded uncertainty expressed at approximately the 95% confidence level using a coverage factor of k=2.
- 2.The calibration interval of the above test instruments is 12 months and the calibrations are traceable to NML/ROC and NIST/USA.

4.5.3 TEST PROCEDURE

The transmitter output was connected to the spectrum analyzer through an attenuator, the bandwidth of the fundamental frequency was measured with the spectrum analyzer using 3kHz RBW and 30kHz VBW, set sweep time = span/3kHz. The power spectral density was measured and recorded. The sweep time is allowed to be longer than span/3kHz for a full response of the mixer in the spectrum analyzer.

4.5.4 DEVIATION FROM TEST STANDARD

No deviation

4.5.5 TEST SETUP

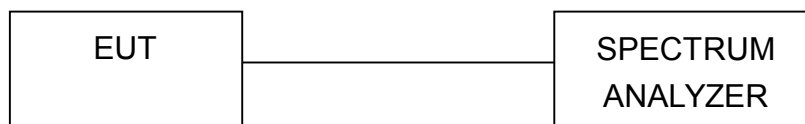

4.5.6 EUT OPERATING CONDITION

Same as Item 4.3.6

4.5.7 TEST RESULTS

802.11b DSSS MODULATION:

MODULATION TYPE	DBPSK	TRANSFER RATE	1Mbps
INPUT POWER	120Vac, 60 Hz	ENVIRONMENTAL CONDITIONS	25deg.C, 60%RH, 955hPa
TESTED BY	Wen Yu		

CHANNEL	CHANNEL FREQUENCY (MHz)	RF POWER LEVEL IN 3kHz BW (dBm)	MAXIMUM LIMIT (dBm)	PASS / FAIL
1	2412	-7.48	8	PASS
6	2437	-2.63	8	PASS
11	2462	-2.37	8	PASS

CH1

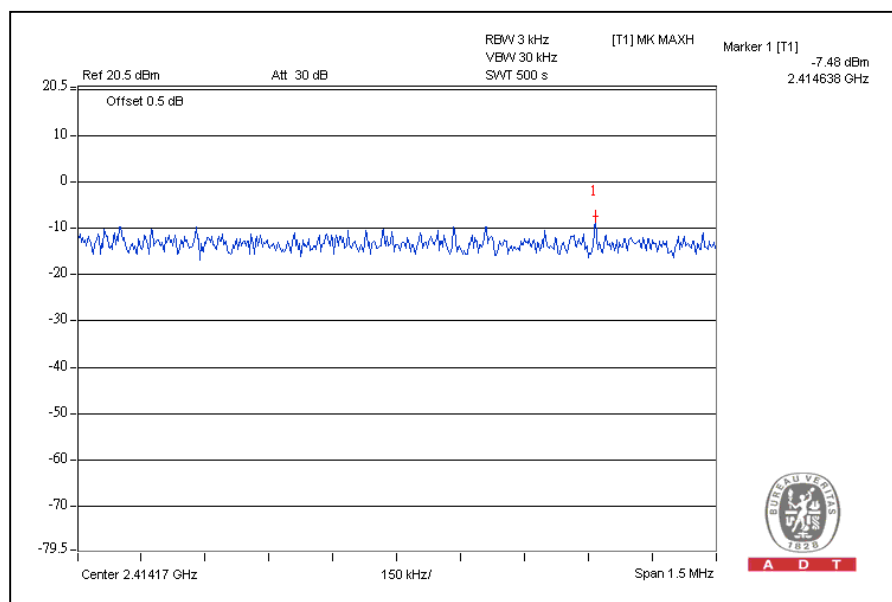

CH6

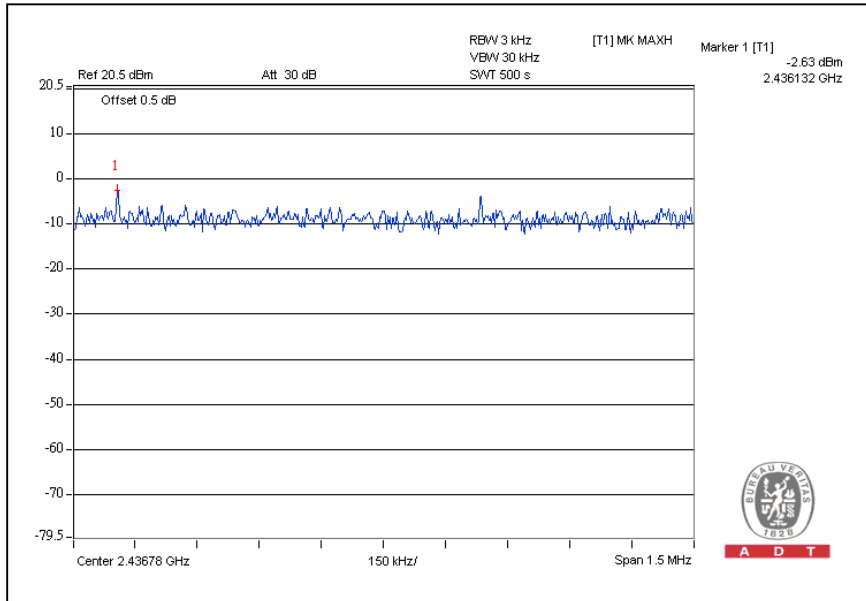

CH11

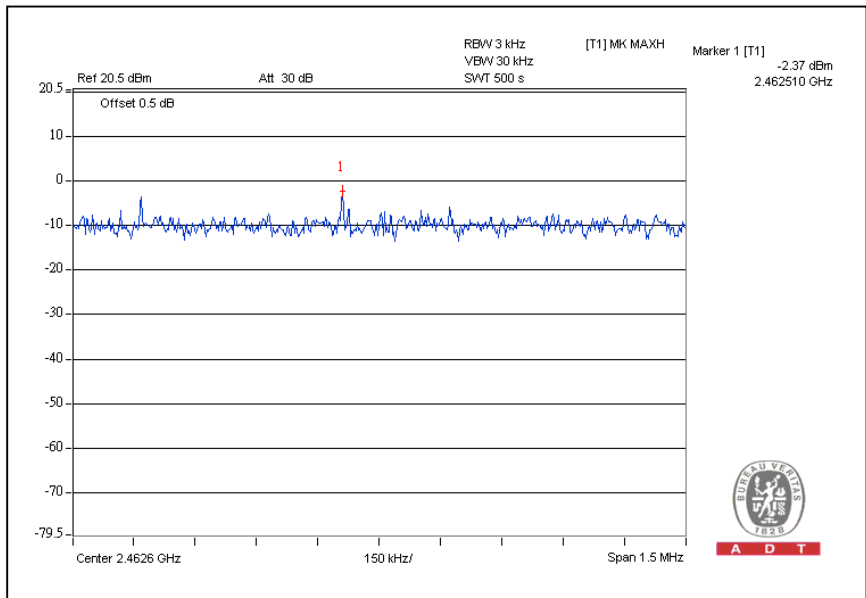

802.11g OFDM MODULATION:

MODULATION TYPE	BPSK	TRANSFER RATE	6Mbps
INPUT POWER	120Vac, 60 Hz	ENVIRONMENTAL CONDITIONS	24deg.C, 66%RH, 972hPa
TESTED BY	Sky Liao		

CHANNEL	CHANNEL FREQUENCY (MHz)	RF POWER LEVEL IN 3kHz BW (dBm)	MAXIMUM LIMIT (dBm)	PASS / FAIL
1	2412	-12.56	8	PASS
6	2437	-9.32	8	PASS
11	2462	-11.02	8	PASS

CH1

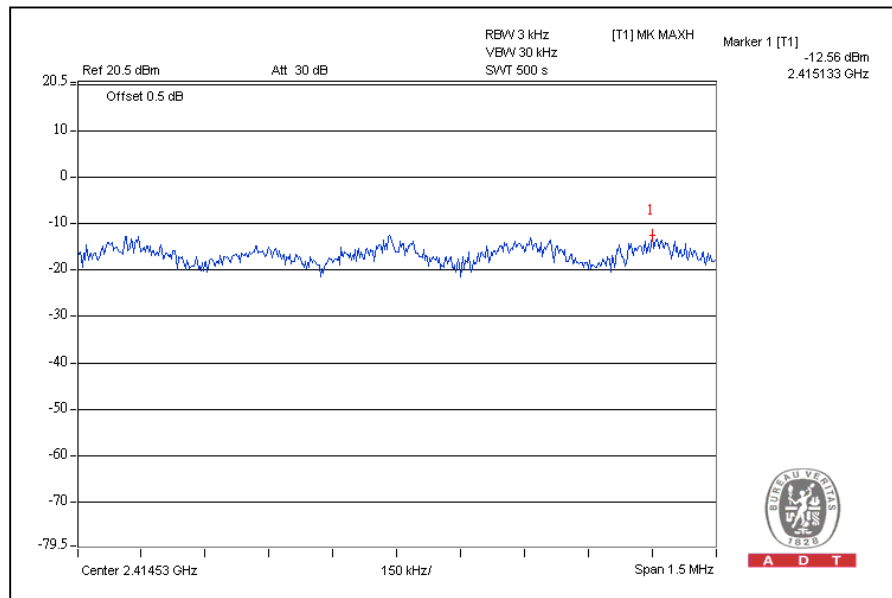



4.6 BAND EDGES MEASUREMENT

4.6.1 LIMITS OF BAND EDGES MEASUREMENT

Below -20dB of the highest emission level of operating band (in 100KHz Resolution Bandwidth).

4.6.2 TEST INSTRUMENTS

Description & Manufacturer	Model No.	Serial No.	Calibrated Until
R&S SPECTRUM ANALYZER	FSP40	100037	Aug. 08, 2009

NOTE:

- 1.The measurement uncertainty is less than $\pm 2.6\text{dB}$, which is calculated as per the NAMAS document NIS81. This uncertainty represents an expanded uncertainty expressed at approximately the 95% confidence level using a coverage factor of $k=2$.
- 2.The calibration interval of the above test instruments is 12 months and the calibrations are traceable to NML/ROC and NIST/USA.

4.6.3 TEST PROCEDURE

The transmitter output was connected to the spectrum analyzer via a low loss cable. Set both RBW of spectrum analyzer to 100kHz and VBW of spectrum analyzer to 300kHz with suitable frequency span including 100 MHz bandwidth from band edge. The band edges was measured and recorded.

The spectrum plots (RBW = 100kHz, VBW = 300kHz) are attached on the following pages.

4.6.4 DEVIATION FROM TEST STANDARD

No deviation

4.6.5 EUT OPERATING CONDITION

Same as Item 4.3.6

4.6.6 TEST RESULTS

The spectrum plots are attached on the following below images. D1 line indicates the highest level, and D2 line indicates the 20dB offset below D1. It shows compliance with the requirement in part 15.247(d).

802.11b DSSS MODULATION: CH1

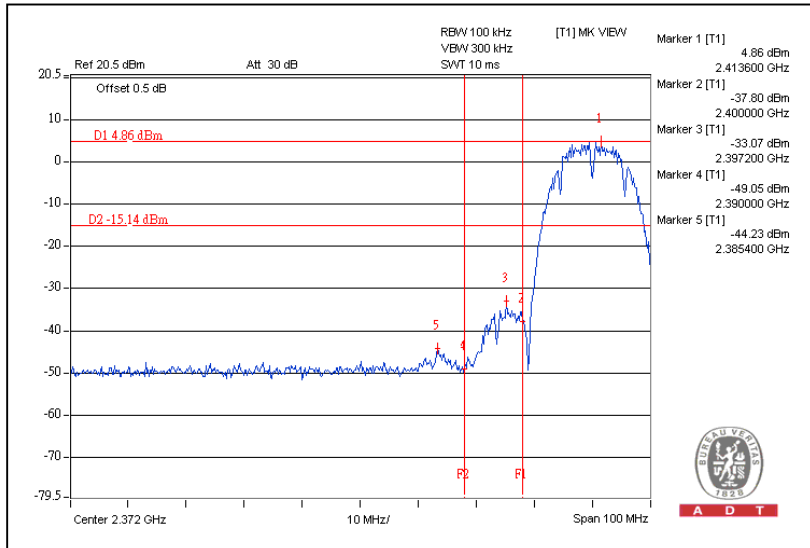

CH11

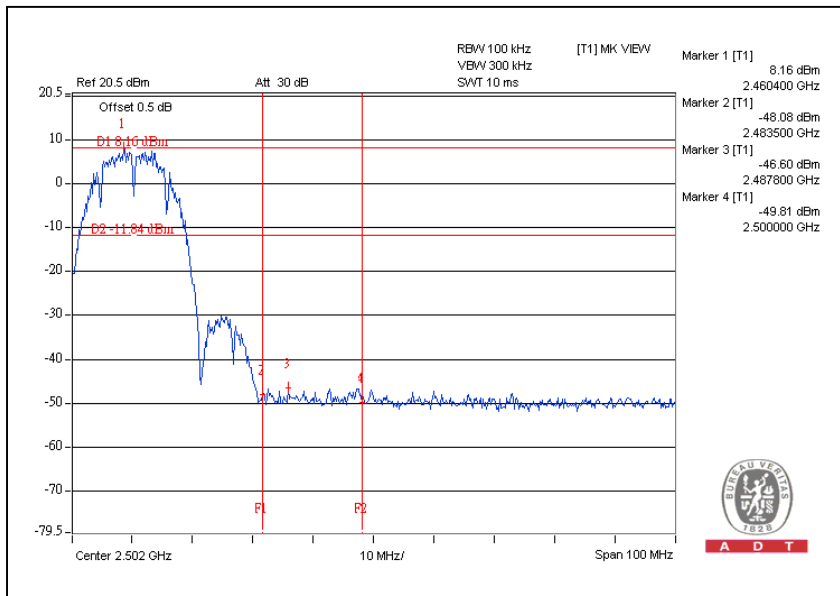

CH1

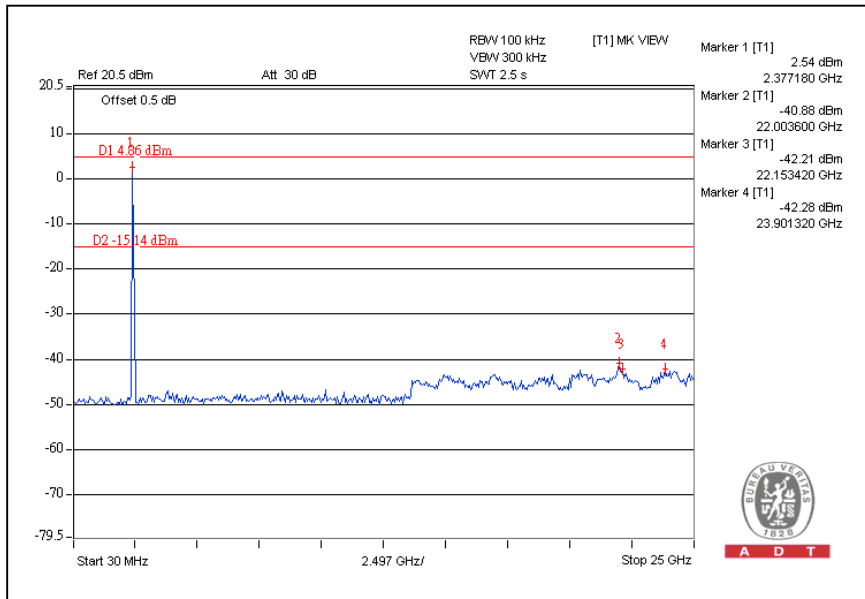

CH11

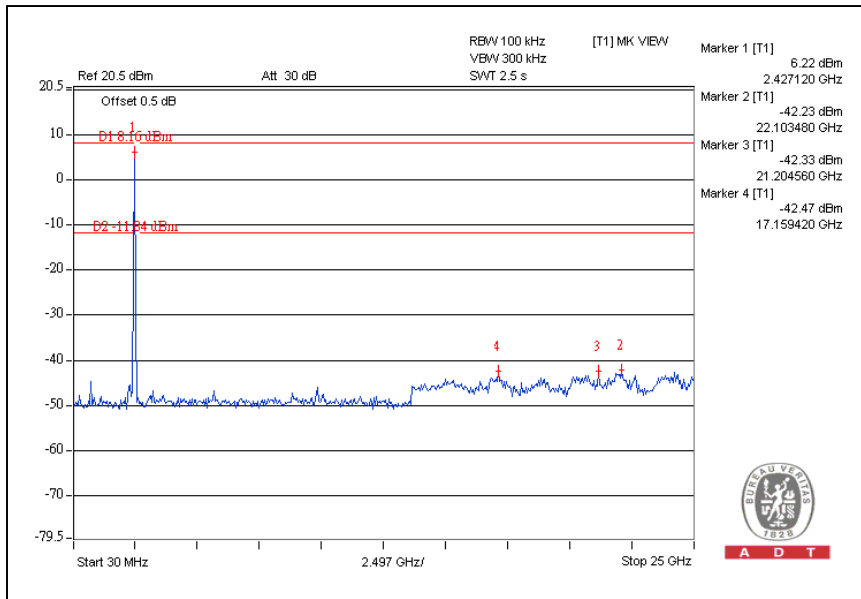

802.11g OFDM MODULATION:

CH 1

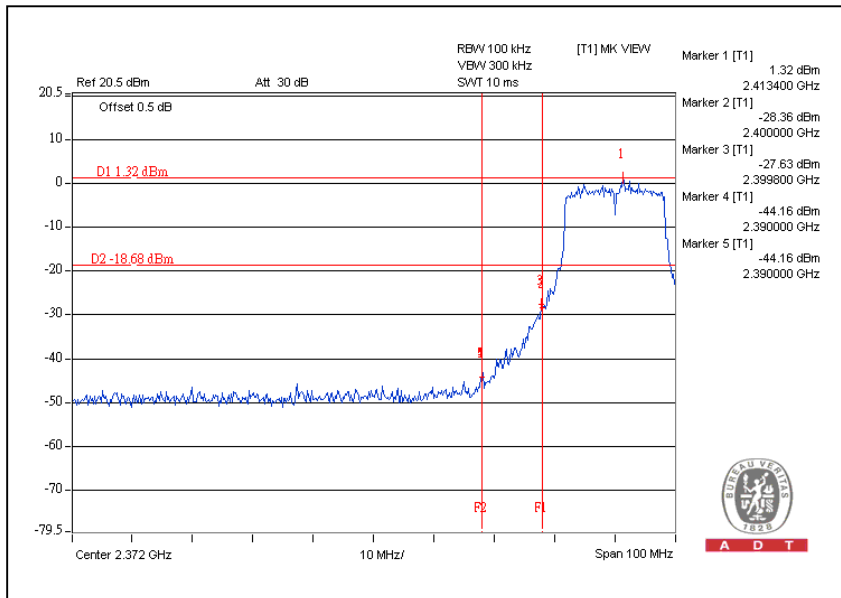

CH11

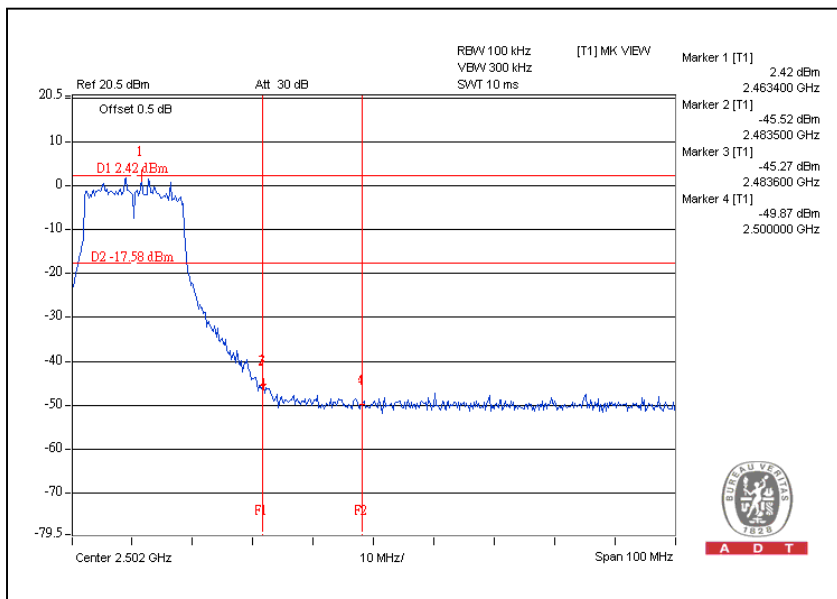

CH1

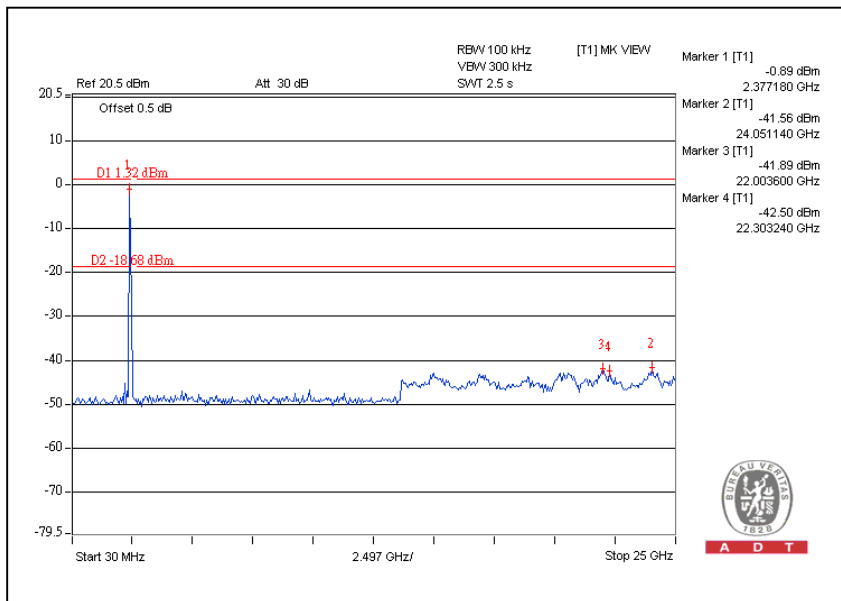

CH11

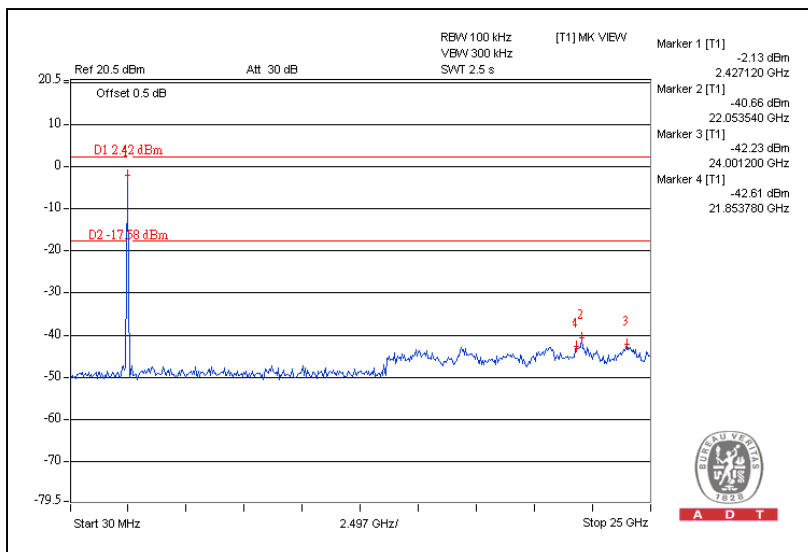

4.7 ANTENNA REQUIREMENT

4.7.1 STANDARD APPLICABLE

For intentional device, according to FCC 47 CFR Section 15.203, an intentional radiator shall be designed to ensure that no antenna other than that furnished by the responsible party shall be used with the device. And according to FCC 47 CFR Section 15.247 (b), if transmitting antennas of directional gain greater than 6dBi are used, the power shall be reduced by the amount in dB that the directional gain of the antenna exceeds 6dBi.

4.7.2 ANTENNA CONNECTED CONSTRUCTION

There is one antenna provided to this EUT, please refer to the following table:

Antenna Type	Antenna Connector	Gain(dBi)
Dipole	Reverse SMA	2



5. INFORMATION ON THE TESTING LABORATORIES

We, ADT Corp., were founded in 1988 to provide our best service in EMC, Radio, Telecom and Safety consultation. Our laboratories are accredited and approved by the following approval agencies according to ISO/IEC 17025.

USA	FCC, UL
Germany	TUV Rheinland
Japan	VCCI
Norway	NEMKO
Canada	INDUSTRY CANADA , CSA
R.O.C.	TAF, BSMI, NCC
Netherlands	Telefication
Singapore	GOST-ASIA(MOU)
Russia	CERTIS(MOU)

Copies of accreditation certificates of our laboratories obtained from approval agencies can be downloaded from our web site:

www.adt.com.tw/index.5/phtml. If you have any comments, please feel free to contact us at the following:

Linko EMC/RF Lab:

Tel: 886-2-26052180

Fax: 886-2-26052943

Hsin Chu EMC/RF Lab:

Tel: 886-3-5935343

Fax: 886-3-5935342

Hwa Ya EMC/RF/Safety Telecom Lab:

Tel: 886-3-3183232

Fax: 886-3-3185050

Web Site: www.adt.com.tw

The address and road map of all our labs can be found in our web site also

6. APPENDIX A - MODIFICATIONS RECORDERS FOR ENGINEERING CHANGES TO THE EUT BY THE LAB

No any modifications are made to the EUT by the lab during the test.

---END---