



**MET Laboratories, Inc.** *Safety Certification - EMI - Telecom Environmental Simulation*

914 WEST PATAPSCO AVENUE • BALTIMORE, MARYLAND 21230-3432 • PHONE (410) 354-3300 • FAX (410) 354-3313

33439 WESTERN AVENUE • UNION CITY, CALIFORNIA 94587 • PHONE (510) 489-6300 • FAX (510) 489-6372

3162 BELICK STREET • SANTA CLARA, CA 95054 • PHONE (408) 748-3585 • FAX (510) 489-6372

13301 MCCALLEN PASS • AUSTIN, TEXAS 78753 • PHONE (512) 287-2500 • FAX (512) 287-2513

January 21, 2014

Autani Corp.  
7170 Riverwood Drive, Suite B  
Columbia, MD 21046

Dear Mark Plasterer,

Enclosed is the EMC Wireless test report for compliance testing of the Autani Corp., ZRB3 as tested to the requirements of Title 47 of the CFR, Ch. 1 (10-1-06 ed.), Part 15, Subpart B and ICES-003, Issue 5 August 2012 for a Class B Digital Device, and FCC Part 15 Subpart C and RSS-210, Issue 8, Dec. 2010 for Intentional Radiators.

Thank you for using the services of MET Laboratories, Inc. If you have any questions regarding these results or if MET can be of further service to you, please feel free to contact me.

Sincerely yours,  
MET LABORATORIES, INC.

Jennifer Warnell  
Documentation Department

Reference: (\Autani Corp.\EMC40618-FCC247 Rev. 1)

Certificates and reports shall not be reproduced except in full, without the written permission of MET Laboratories, Inc.

## **Electromagnetic Compatibility Criteria Test Report**

for the

**Autani Corp.  
ZRB3**

**Tested under**  
the FCC Certification Rules  
contained in  
Title 47 of the CFR, Parts 15 Subpart B & ICES-003  
for Class B Digital Devices  
&  
15.247 Subpart C & RSS-210, Issue 8, Dec. 2010  
for Intentional Radiators

**MET Report: EMC40618-FCC247 Rev. 1**

January 21, 2014

**Prepared For:**

**Autani Corp.  
7170 Riverwood Drive, Suite B  
Columbia, MD 21046**

**Prepared By:**  
**MET Laboratories, Inc.**  
914 W. Patapsco Ave  
Baltimore, MD 21230

## Electromagnetic Compatibility Criteria Test Report

for the

**Autani Corp.**  
**ZRB3**

**Tested under**  
the FCC Certification Rules  
contained in  
Title 47 of the CFR, Parts 15 Subpart B & ICES-003  
for Class B Digital Devices  
&  
15.247 Subpart C & RSS-210, Issue 8, Dec. 2010  
for Intentional Radiators



Shawn McMillen, Project Engineer  
Electromagnetic Compatibility Lab



Jennifer Warnell  
Documentation Department

**Engineering Statement:** The measurements shown in this report were made in accordance with the procedures indicated, and the emissions from this equipment were found to be within the limits applicable. I assume full responsibility for the accuracy and completeness of these measurements, and for the qualifications of all persons taking them. It is further stated that upon the basis of the measurements made, the equipment tested is capable of operation in accordance with the requirements of the FCC Rules Parts 15B, 15.247 and Industry Canada standards ICES-003, Issue 5 August 2012, RSS-210, Issue 8, Dec. 2010 under normal use and maintenance.



Asad Bajwa,  
Director, Electromagnetic Compatibility Lab

## Report Status Sheet

Revision	Report Date	Reason for Revision
∅	January 16, 2014	Initial Issue.
1	January 21, 2014	Editorial correction.

## Table of Contents

<b>I.</b>	<b>Executive Summary .....</b>	<b>1</b>
	A. Purpose of Test .....	2
	B. Executive Summary .....	2
<b>II.</b>	<b>Equipment Configuration .....</b>	<b>3</b>
	A. Overview.....	4
	B. References.....	5
	C. Test Site .....	5
	D. Description of Test Sample.....	6
	E. Equipment Configuration.....	7
	F. Support Equipment .....	7
	G. Ports and Cabling Information.....	7
	H. Mode of Operation.....	8
	I. Method of Monitoring EUT Operation .....	8
	J. Modifications .....	9
	a) Modifications to EUT.....	9
	b) Modifications to Test Standard.....	9
	K. Disposition of EUT.....	9
<b>III.</b>	<b>Electromagnetic Compatibility Criteria for Unintentional Radiators .....</b>	<b>10</b>
	§ 15.107(a) Conducted Emissions Limits.....	11
	§ 15.109(a) Radiated Emissions Limits.....	14
<b>IV.</b>	<b>Electromagnetic Compatibility Criteria for Intentional Radiators.....</b>	<b>16</b>
	§ 15.203 Antenna Requirement .....	17
	§ 15.207(a) Conducted Emissions Limits.....	18
	§ 15.247(a)(a) 6 dB and 99% Bandwidth .....	21
	§ 15.247(b) Peak Power Output .....	25
	§ 15.247(d) Radiated Spurious Emissions Requirements and Band Edge .....	28
	§ 15.247(d) RF Conducted Spurious Emissions Requirements and Band Edge.....	40
	§ 15.247(e) Peak Power Spectral Density .....	43
	§ 15.247(i) Maximum Permissible Exposure .....	46
<b>V.</b>	<b>Test Equipment .....</b>	<b>47</b>
<b>VI.</b>	<b>Certification &amp; User's Manual Information.....</b>	<b>49</b>
	A. Certification Information .....	50
	B. Label and User's Manual Information .....	54
<b>VII.</b>	<b>ICES-003 Procedural &amp; Labeling Requirements.....</b>	<b>56</b>

## List of Tables

Table 1. Executive Summary of EMC Part 15.247 Compliance Testing .....	2
Table 2. EUT Summary Table.....	4
Table 3. References .....	5
Table 4. Equipment Configuration .....	7
Table 5. Ports and Cabling Information .....	7
Table 6. Conducted Limits for Radio Frequency Devices calculated from FCC Part 15 Subsections 15.107(a) (b) .....	11
Table 7. Conducted Emissions - Voltage, AC Power, Phase Line (120 VAC, 60 Hz).....	12
Table 8. Conducted Emissions - Voltage, AC Power, Neutral Line (120 VAC, 60 Hz).....	13
Table 9. Radiated Emissions Limits calculated from FCC Part 15, §15.109 (a) (b) .....	14
Table 10. Radiated Emissions Limits, Test Results, 30 MHz – 1 GHz .....	15
Table 11. Conducted Limits for Intentional Radiators from FCC Part 15 § 15.207(a) .....	18
Table 12. Conducted Emissions, 15.207(a), Phase Line, Test Results .....	19
Table 13. Conducted Emissions, 15.207(a), Neutral Line, Test Results .....	20
Table 14. 6 dB Occupied Bandwidth, Test Results .....	22
Table 15. 99% Occupied Bandwidth, Test Results .....	22
Table 16. Output Power Requirements from §15.247(b) .....	25
Table 17. Peak Power Output, Test Results .....	26
Table 18. Restricted Bands of Operation.....	28
Table 19. Radiated Emissions Limits Calculated from FCC Part 15, § 15.209 (a) .....	29
Table 20. Peak Power Spectral Density, Test Results .....	44
Table 21. Test Equipment List .....	48

## List of Plots

Plot 1. Conducted Emissions, Phase Line Plot .....	12
Plot 2. Conducted Emissions, Neutral Line Plot .....	13
Plot 3. Radiated Emissions, 30 MHz - 1 GHz .....	15
Plot 4. Conducted Emissions, 15.207(a), Phase Line .....	19
Plot 5. Conducted Emissions, 15.207(a), Neutral Line .....	20
Plot 6. 6 dB Occupied Bandwidth, Low Channel.....	23
Plot 7. 6 dB Occupied Bandwidth, Mid Channel .....	23
Plot 8. 6 dB Occupied Bandwidth, High Channel .....	23
Plot 9. 99% Occupied Bandwidth, Low Channel .....	24
Plot 10. 99% Occupied Bandwidth, Mid Channel.....	24
Plot 11. 99% Occupied Bandwidth, High Channel .....	24
Plot 12. Peak Power Output, Low Channel .....	27
Plot 13. Peak Power Output, Mid Channel.....	27
Plot 14. Peak Power Output, High Channel .....	27
Plot 15. Radiated Spurious Emissions, Internal Antenna, Low Channel, 30 MHz – 1 GHz .....	30
Plot 16. Radiated Spurious Emissions, Internal Antenna, Low Channel, Peak under Average, 1 GHz – 18 GHz.....	30
Plot 17. Radiated Spurious Emissions, Internal Antenna, Low Channel, 3 <sup>rd</sup> Harmonic, Average .....	30
Plot 18. Radiated Spurious Emissions, Internal Antenna, Mid Channel, 30 MHz – 1 GHz.....	31
Plot 19. Radiated Spurious Emissions, Internal Antenna, Mid Channel, Peak under Average, 1 GHz – 18 GHz .....	31
Plot 20. Radiated Spurious Emissions, Internal Antenna, Mid Channel, 3 <sup>rd</sup> Harmonic, Average.....	31
Plot 21. Radiated Spurious Emissions, Internal Antenna, High Channel, 30 MHz – 1GHz .....	32
Plot 22. Radiated Spurious Emissions, Internal Antenna, High Channel, Peak under Average, 1 GHz – 18 GHz.....	32
Plot 23. Radiated Spurious Emissions, Internal Antenna, High Channel, 3 <sup>rd</sup> Harmonic, Average.....	32
Plot 24. Radiated Spurious Emissions, External Antenna, Low Channel, 30 MHz – 1 GHz .....	33
Plot 25. Radiated Spurious Emissions, External Antenna, Low Channel, Peak Under Average, 1 GHz – 18 GHz.....	33
Plot 26. Radiated Spurious Emissions, External Antenna, Low Channel, 3 <sup>rd</sup> Harmonic, Average .....	33

Plot 27. Radiated Spurious Emissions, External Antenna, Mid Channel, 30 MHz – 1 GHz.....	34
Plot 28. Radiated Spurious Emissions, External Antenna, Mid Channel, Peak under Average, 1 GHz – 18 GHz .....	34
Plot 29. Radiated Spurious Emissions, External Antenna, Mid Channel, 3 <sup>rd</sup> Harmonic, Average.....	34
Plot 30. Radiated Spurious Emissions, External Antenna, High Channel, 30 MHz – 1 GHz .....	35
Plot 31. Radiated Spurious Emissions, External Antenna, High Channel, Peak under Average, 1 GHz – 18 GHz.....	35
Plot 32. Radiated Spurious Emissions, External Antenna, High Channel, 3 <sup>rd</sup> Harmonic, Average .....	35
Plot 33. Radiated Band Edge, Internal Antenna, Low Channel, Average .....	36
Plot 34. Radiated Band Edge, Internal Antenna, Low Channel, Peak.....	36
Plot 35. Radiated Band Edge in First 2 MHz using Reduced RBW, Average, Internal Antenna, High Channel .....	37
Plot 36. Radiated Band Edge at 2483.5 MHz and Beyond, Average, Internal Antenna, High Channel .....	37
Plot 37. Radiated Band Edge at 2483.5 MHz, Peak, Internal Antenna, High Channel .....	37
Plot 38. Radiated Band Edge, External Antenna, Low Channel, Average.....	38
Plot 39. Radiated Band Edge, External Antenna, Low Channel, Peak.....	38
Plot 40. Radiated Band Edge in First 2 MHz using Reduced RBW, Average, External Antenna, High Channel .....	38
Plot 41. Radiated Spurious Emissions, External Antenna, High Channel, 2485.5 MHz and Beyond, Average .....	39
Plot 42. Radiated Band Edge, External Antenna, High Channel, Peak .....	39
Plot 43. Conducted Spurious Emissions, Low Channel, 30 MHz – 26 GHz.....	41
Plot 44. Conducted Spurious Emissions, Mid Channel, 30 MHz – 26 GHz .....	41
Plot 45. Conducted Spurious Emissions, High Channel, 30 MHz – 26 GHz .....	41
Plot 46. Conducted Band Edge, Low .....	42
Plot 47. Conducted Band Edge, High.....	42
Plot 48. Peak Power Spectral Density, Low Channel.....	45
Plot 49. Peak Power Spectral Density, Mid Channel .....	45
Plot 50. Peak Power Spectral Density, High Channel.....	45

## List of Figures

Figure 1. Block Diagram of Test Configuration.....	6
Figure 2. Block Diagram, Occupied Bandwidth Test Setup.....	21
Figure 3. Peak Power Output Test Setup.....	25
Figure 4. Block Diagram, Conducted Spurious Emissions Test Setup.....	40
Figure 5. Block Diagram, Peak Power Spectral Density Test Setup .....	43

## List of Terms and Abbreviations

AC	Alternating Current
ACF	Antenna Correction Factor
Cal	Calibration
<i>d</i>	Measurement Distance
dB	Decibels
dB $\mu$ A	Decibels above one <b>microamp</b>
dB $\mu$ V	Decibels above one <b>microvolt</b>
dB $\mu$ A/m	Decibels above one <b>microamp per meter</b>
dB $\mu$ V/m	Decibels above one <b>microvolt per meter</b>
DC	Direct Current
E	Electric Field
DSL	Digital Subscriber Line
ESD	Electrostatic Discharge
EUT	Equipment Under Test
<i>f</i>	Frequency
FCC	Federal Communications Commission
GRP	Ground Reference Plane
H	Magnetic Field
HCP	Horizontal Coupling Plane
Hz	Hertz
IEC	International Electrotechnical Commission
kHz	kilohertz
kPa	kilopascal
kV	kilovolt
LISN	Line Impedance Stabilization Network
MHz	Megahertz
$\mu$ H	microhenry
$\mu$	microfarad
$\mu$ s	microseconds
NEBS	Network Equipment-Building System
PRF	Pulse Repetition Frequency
RF	Radio Frequency
RMS	Root-Mean-Square
TWT	Traveling Wave Tube
V/m	Volts per meter
VCP	Vertical Coupling Plane



# I. Executive Summary

## A. Purpose of Test

An EMC evaluation was performed to determine compliance of the Autani Corp. ZRB3, with the requirements of Part 15, §15.247. All references are to the most current version of Title 47 of the Code of Federal Regulations in effect. In accordance with §2.1033, the following data is presented in support of the Certification of the ZRB3. Autani Corp. should retain a copy of this document which should be kept on file for at least two years after the manufacturing of the ZRB3, has been **permanently** discontinued.

## B. Executive Summary

The following tests were conducted on a sample of the equipment for the purpose of demonstrating compliance with Part 15, §15.247, in accordance with Autani Corp., purchase order number 20130909-02. All tests were conducted using measurement procedure ANSI C63.4-2003.

FCC Reference 47 CFR Part 15.247:2005	IC Reference RSS-210 Issue 8: 2010; RSS-GEN Issue 3: 2010	Description	Compliance
47 CFR Part 15.107 (a)	ICES-003 Issue 5 August 2012	Conducted Emission Limits for a Class B Digital Device	Compliant
47 CFR Part 15.109 (a)	ICES-003 Issue 5 August 2012	Radiated Emission Limits for a Class B Digital Device	Compliant
Title 47 of the CFR, Part 15 §15.203	N/A	Antenna Requirement	Compliant
Title 47 of the CFR, Part 15 §15.207(a)	RSS-GEN (7.2.4)	Conducted Emission Limits	Compliant
Title 47 of the CFR, Part 15 §15.247(a)(2)	RSS-Gen(4.6)	6dB Occupied Bandwidth	Compliant
		99% Occupied Bandwidth	Compliant
Title 47 of the CFR, Part 15 §15.247(b)	RSS-210(A8.4)	Peak Power Output	Compliant
Title 47 of the CFR, Part 15 §15.247(d); §15.209; §15.205	RSS-210(A8.5)	Radiated Spurious Emissions Requirements	Compliant
Title 47 of the CFR, Part 15 §15.247(d)	RSS-210(A8.5)	RF Conducted Spurious Emissions Requirements	Compliant
Title 47 of the CFR, Part 15 §15.247(d)	RSS-210(A8.5)	RF Conducted Band Edge	Compliant
Title 47 of the CFR, Part 15; §15.247(e)	RSS-210(A8.2)	Peak Power Spectral Density	Compliant
Title 47 of the CFR, Part 15 §15.247(i)	RSS-Gen(5.6)	Maximum Permissible Exposure (MPE)	Compliant

**Table 1. Executive Summary of EMC Part 15.247 Compliance Testing**

## II. Equipment Configuration

## A. Overview

MET Laboratories, Inc. was contracted by Autani Corp. to perform testing on the ZRB3, under Autani Corp.'s purchase order number 20130909-02.

This document describes the test setups, test methods, required test equipment, and the test limit criteria used to perform compliance testing of the Autani Corp., ZRB3.

The results obtained relate only to the item(s) tested.

<b>Model(s) Tested:</b>	ZRB3	
<b>Model(s) Covered:</b>	ZRB3	
<b>EUT Specifications:</b>	Primary Power: 120 VAC, 60 Hz	
	FCC ID: V8NZRB1000152 IC: 7737A-ZRB1000152	
	Protocol:	IEEE 802.15.4 DSSS
	Equipment Code:	DTS
	Peak RF Output Power:	24.04 dBm
	EUT Frequency Ranges:	2405 – 2475 MHz
<b>Analysis:</b>	The results obtained relate only to the item(s) tested.	
<b>Environmental Test Conditions:</b>	Temperature: 15-35° C	
	Relative Humidity: 30-60%	
	Barometric Pressure: 860-1060 mbar	
<b>Evaluated by:</b>	Shawn McMillen, Benjamin Taylor	
<b>Report Date(s):</b>	January 21, 2014	

**Table 2. EUT Summary Table**

## B. References

<b>CFR 47, Part 15, Subpart C</b>	Federal Communication Commission, Code of Federal Regulations, Title 47, Part 15: General Rules and Regulations, Allocation, Assignment, and Use of Radio Frequencies
<b>CFR 47, Part 15, Subpart B</b>	Electromagnetic Compatibility: Criteria for Radio Frequency Devices
<b>RSS-210, Issue 8, Dec. 2010</b>	Low-power Licence-exempt Radiocommunications Devices (All Frequency Bands): Category I Equipment
<b>RSS-GEN, Issue 3, Dec. 2010</b>	General Requirements and Information for the Certification of Radio Apparatus
<b>ICES-003, Issue 5 August 2012</b>	Information Technology Equipment (ITE) — Limits and methods of measurement
<b>ANSI C63.4:2003</b>	Methods and Measurements of Radio-Noise Emissions from Low-Voltage Electrical And Electronic Equipment in the Range of 9 kHz to 40 GHz
<b>ISO/IEC 17025:2005</b>	General Requirements for the Competence of Testing and Calibration Laboratories
<b>ANSI C63.10-2009</b>	American National Standard for Testing Unlicensed Wireless Devices

**Table 3. References**

## C. Test Site

All testing was performed at MET Laboratories, Inc., 914 W. Patapsco Ave., Baltimore, MD 21230. All equipment used in making physical determinations is accurate and bears recent traceability to the National Institute of Standards and Technology.

Radiated Emissions measurements were performed in a 3 meter semi-anechoic chamber (equivalent to an Open Area Test Site). In accordance with §2.948(a)(3), a complete site description is contained at MET Laboratories.

## D. Description of Test Sample

The Autani Corp. ZRB3, Equipment Under Test (EUT), is a bridge between two interfaces: wireless ZigBee and wired (half/full-duplex) RS485 or RS232. Messages, data, and control are passed from one medium to the other by this device. Information can originate on either side of the interface. The firmware loaded into the ZRB3 controls how the information is processed and forwarded on each interface. ZigBee is the only wireless protocol supported; however, many wired protocols can be supported (i.e. BakNET, LonWorks, etc.).

The ZRB3 supports 3 primary product lines: RS485, RS232, and the Integrated Thermostat (iStat). The ZRB3 contains an etched antenna (2dBi) and an optional external antenna (2dBi).

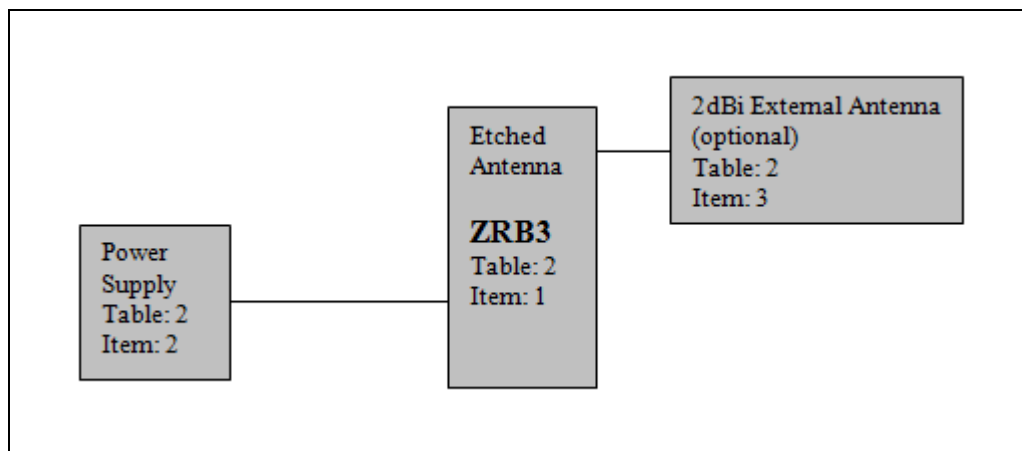

**Figure 1. Block Diagram of Test Configuration**

## E. Equipment Configuration

The EUT was set up as outlined in Figure 1, Block Diagram of Test Setup. All cards, racks, etc., incorporated as part of the EUT is included in the following list.

Ref. ID	Name / Description	Model Number	Part Number	Serial Number	Revision
1	ZRB3	1000152	1000152	varies	1
2	24VAC Wall Wart	varies	100450	varies	N/A
3	2dBi External Antenna	varies	varies	varies	N/A

**Table 4. Equipment Configuration**

## F. Support Equipment

The EUT did not require any support equipment for operation or monitoring.

## G. Ports and Cabling Information

Ref. ID	Port Name on EUT	Cable Description	Qty.	Length (m)	Shielded (Y/N)	Termination Point
1	Unit Interface	6 conductor, 26 AWG	1	0.33	N	1
2	UMCC Connector	RF Coax, UMCC to RP-SMA	1	0.01	Y	2

**Table 5. Ports and Cabling Information**

## H. Mode of Operation

### Production Mode:

The ZRB3 is configured wirelessly through the ZigBee interface. Once configured the mode of operation is dependent on the firmware loaded into the device; however, each mode has the same basic features. Each mode allows wireless traffic to be transferred to the wired interface and vice-versa.

### FCC Mode:

The ZRB3 has a special image programmed into the SoC to facilitate the FCC testing. This image represents the worse possible case from a noise perspective. The following details the operation and how to change states.

There is one switch (SW1) and two LED's (LED1 and LED2) on the ZRB3. The function is as follows:

- 1) At board power-on, both LED's are off and there is no RF transmission.
- 2) A long press, ~ 3 seconds, of SW1 repeatedly sequences through the RF channels.
- 3) A short press, ~1 second, of SW1 while states in 1-4 above causes the CW tone to be replaced with a modulated tone containing pseudo-random data. LED1 turns solid green while the pseudo-random modulation is in effect.

Commands may be sent to the ZRB3 using Hyperterm and the supplied MOXA serial connection. See details below.

The serial parameters are 115200,N,8,1

Menu: (h for help)

**zrb3>h**

tx <power> (-20 to 8)

chn <strategy> (all or subset)

m - toggle modulation (only if transmitting)

s - start/increment transmitting channel

v - view current settings

reset

Example:

**zrb3>view**

tx=1, chn=all

**zrb3>**

## I. Method of Monitoring EUT Operation

### Production Mode:

The device has two indicating LEDs which provide status feedback to the user/installer. If the device is operating as anticipated one of the LEDs will be blinking red or green. If the device is not performing to the manufacturer's intended operation the LEDs should be off.

### FCC Mode:

If the device is operating as described in the Modes of Operation section, RF energy in the ISM band should be observed. If the device is not operating properly, no RF energy will be observed in the ISM band.



## **J. Modifications**

### **a) Modifications to EUT**

No modifications were made to the EUT.

### **b) Modifications to Test Standard**

No modifications were made to the test standard.

## **K. Disposition of EUT**

The test sample including all support equipment submitted to the Electro-Magnetic Compatibility Lab for testing was returned to Autani Corp. upon completion of testing.

### **III. Electromagnetic Compatibility Criteria for Unintentional Radiators**

## Electromagnetic Compatibility Criteria

### § 15.107 Conducted Emissions Limits

**Test Requirement(s):** **15.107 (a)** Except for Class A digital devices, for equipment that is designed to be connected to the public utility (AC) power line, the radio frequency voltage that is conducted back onto the AC power line on any frequency or frequencies within the band 150 kHz to 30 MHz shall not exceed the limits in Table 6. Compliance with this provision shall be based on the measurement of the radio frequency voltage between each power line and ground at the power terminals.

**15.107 (b)** For a Class A digital device that is designed to be connected to the public utility (AC) power line, the radio frequency voltage that is conducted back onto the AC power line on any frequency or frequencies within the band 150 kHz to 30 MHz shall not exceed the limits in Table 6. Compliance with this provision shall be based on the measurement of the radio frequency voltage between each power line and ground at the power terminals. The lower limit applies at the band edges.

Frequency range (MHz)	Class A Conducted Limits (dB $\mu$ V)		*Class B Conducted Limits (dB $\mu$ V)	
	Quasi-Peak	Average	Quasi-Peak	Average
* 0.15- 0.45	79	66	66 - 56	56 - 46
0.45 - 0.5	79	66	56	46
0.5 - 30	73	60	60	50

Note 1 — The lower limit shall apply at the transition frequencies.  
Note 2 — The limit decreases linearly with the logarithm if the frequency in the range 0.15 MHz to 0.5 MHz.

**Table 6. Conducted Limits for Radio Frequency Devices calculated from FCC Part 15 Subsections 15.107(a) (b)**

**Test Procedures:** The EUT was placed on a non-metallic table, 80 cm above the ground plane and 40cm from a vertical ground plane. The method of testing, test conditions, and test procedures of ANSI C63.4 were used. The EUT was powered through a 50 $\Omega$ /50 $\mu$ H LISN. An EMI receiver, connected to the measurement port of the LISN, scanned the frequency range from 150 kHz to 30 MHz in order to find the peak conducted emissions. All peak emissions within 6 dB of the limit were re-measured using a quasi-peak and/or average detector as appropriate.

**Test Results:** The EUT was compliant with the Class B requirement(s) of this section. Measured emissions were below applicable limits.

**Test Engineer(s):** Benjamin Taylor

**Test Date(s):** 12/20/13

**Conducted Emissions - Voltage, AC Power, Phase Line (120 VAC, 60 Hz)**

Frequency (MHz)	Uncorrected Meter Reading (dBμV) QP	Cable Loss (dB)	Corrected Measurement (dBμV) QP	Limit (dBμV) QP	Margin (dB) QP	Uncorrected Meter Reading (dBμV) Avg.	Cable Loss (dB)	Corrected Measurement (dBμV) AVG	Limit (dBμV) AVG	Margin (dB) AVG
0.6818	17.3	0	17.3	56	-38.7	13.18	0	13.18	46	-32.82
0.8592	25.52	0	25.52	56	-30.48	21.14	0	21.14	46	-24.86
1.087	33.67	0	33.67	56	-22.33	31.99	0	31.99	46	-14.01
1.299	35.46	0	35.46	56	-20.54	32.38	0	32.38	46	-13.62
1.372	29.92	0	29.92	56	-26.08	25.51	0	25.51	46	-20.49
1.591	29.4	0	29.4	56	-26.6	26.44	0	26.44	46	-19.56

**Table 7. Conducted Emissions - Voltage, AC Power, Phase Line (120 VAC, 60 Hz)**

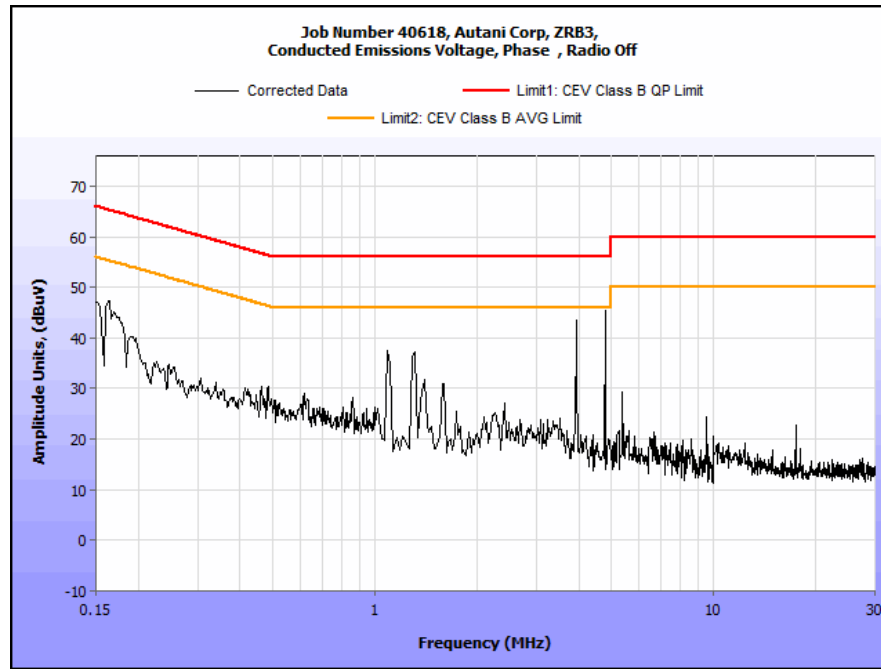

**Plot 1. Conducted Emissions, Phase Line Plot**

### Conducted Emissions - Voltage, AC Power, Neutral Line (120 VAC, 60 Hz)

Frequency (MHz)	Uncorrected Meter Reading (dB $\mu$ V) QP	Cable Loss (dB)	Corrected Measurement (dB $\mu$ V) QP	Limit (dB $\mu$ V) QP	Margin (dB) QP	Uncorrected Meter Reading (dB $\mu$ V) Avg.	Cable Loss (dB)	Corrected Measurement (dB $\mu$ V) AVG	Limit (dB $\mu$ V) AVG	Margin (dB) AVG
0.182	9.422	0	9.422	64.39	-54.968	3.657	0	3.657	54.39	-50.733
0.6832	31.24	0	31.24	56	-24.76	27.59	0	27.59	46	-18.41
0.8615	37.14	0	37.14	56	-18.86	33.04	0	33.04	46	-12.96
1.091	34.85	0	34.85	56	-21.15	32.37	0	32.37	46	-13.63
1.588	26.37	0	26.37	56	-29.63	23.64	0	23.64	46	-22.36
2.106	18.21	0	18.21	56	-37.79	15.16	0	15.16	46	-30.84

Table 8. Conducted Emissions - Voltage, AC Power, Neutral Line (120 VAC, 60 Hz)

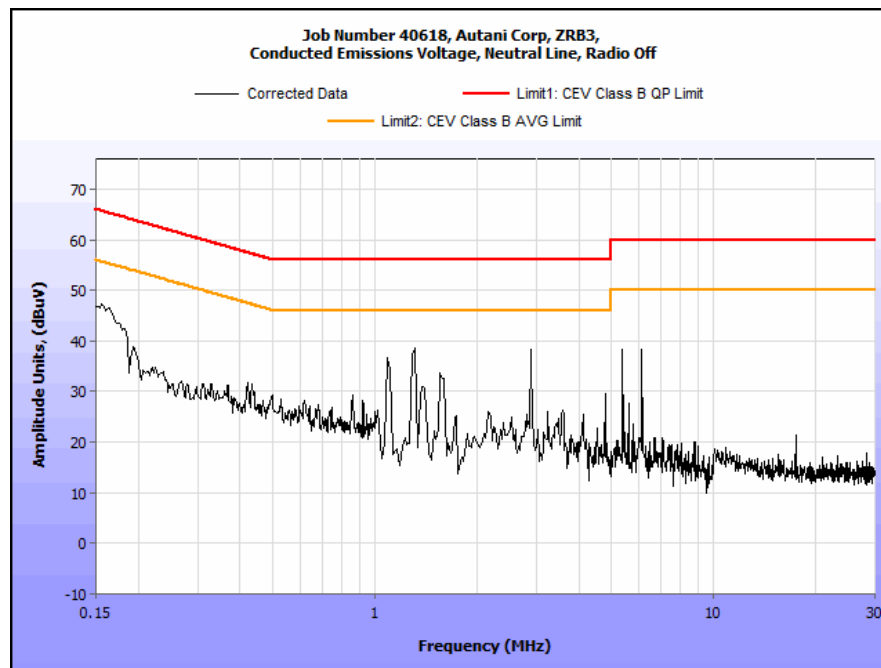

Plot 2. Conducted Emissions, Neutral Line Plot

## Radiated Emission Limits

### § 15.109 Radiated Emissions Limits

**Test Requirement(s):** **15.109 (a)** Except for Class A digital devices, the field strength of radiated emissions from unintentional radiators at a distance of 3 meters shall not exceed the Class B limits expressed in Table 9.

**15.109 (b)** The field strength of radiated emissions from a Class A digital device, as determined at a distance of 10 meters, shall not exceed the Class A limits expressed in Table 9.

Frequency (MHz)	Field Strength (dB $\mu$ V/m)	
	§15.109 (b), Class A Limit (dB $\mu$ V) @ 10m	§15.109 (a), Class B Limit (dB $\mu$ V) @ 3m
30 - 88	39.00	40.00
88 - 216	43.50	43.50
216 - 960	46.40	46.00
Above 960	49.50	54.00

**Table 9. Radiated Emissions Limits calculated from FCC Part 15, §15.109 (a) (b)**

**Test Procedures:** The EUT was placed on a non-metallic table, 80 cm above the ground plane on the turntable inside a semi-anechoic chamber. The method of testing and test conditions of ANSI C63.4 were used. An antenna was located 3 m from the EUT on an adjustable mast. A pre-scan was first performed in order to find prominent radiated emissions. For final emissions measurements at each frequency of interest, the EUT was rotated and the antenna height was varied between 1 m and 4 m in order to maximize the emission. Measurements in both horizontal and vertical polarities were made and the data was recorded. Unless otherwise specified, measurements were made using a quasi-peak detector with a 120 kHz bandwidth.

**Test Results:** The EUT was compliant with the Class B requirement(s) of this section. Measured emissions were below applicable limits.

**Test Engineer(s):** Benjamin Taylor

**Test Date(s):** 01/04/14

### Radiated Emissions Limits Test Results, Class B

Frequency (MHz)	EUT Azimuth (Degrees)	Antenna Polarity (H/V)	Antenna HEIGHT (m)	Uncorrected Amplitude (dB $\mu$ V)	Antenna Correction Factor (dB) (+)	Cable Loss (dB) (+)	Distance Correction Factor (dB) (-)	Corrected Amplitude (dB $\mu$ V/m)	Limit (dB $\mu$ V/m)	Margin (dB)
74.188377	10	H	1.06	5.80	8.10	0.65	0.00	14.55	40.00	-25.45
74.188377	15	V	1.03	5.87	8.10	0.65	0.00	14.62	40.00	-25.38
118.05611	13	H	1.02	5.50	13.61	0.86	0.00	19.97	43.50	-23.53
118.05611	15	V	1.04	5.65	13.61	0.86	0.00	20.12	43.50	-23.38
264.18838	27	H	1.06	4.52	13.30	1.35	0.00	19.17	46.00	-26.83
264.18838	18	V	1.10	4.43	13.30	1.35	0.00	19.08	46.00	-26.92
727.67535	6	H	1.05	5.34	21.00	2.31	0.00	28.65	46.00	-17.35
727.67535	17	V	1.03	5.30	21.00	2.31	0.00	28.61	46.00	-17.39

**Table 10. Radiated Emissions Limits, Test Results, 30 MHz – 1 GHz**

Note: The EUT was tested at 3 m.

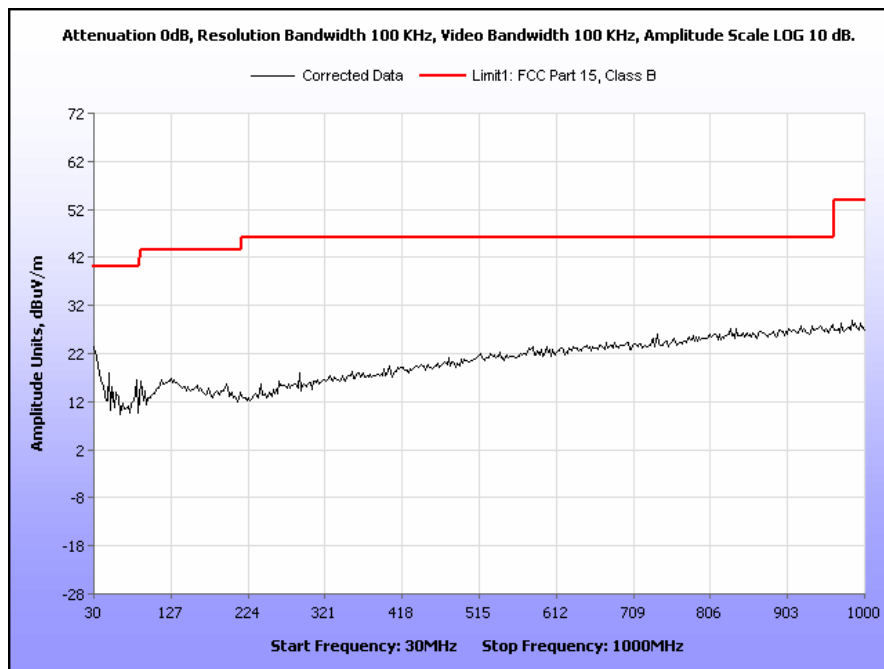

**Plot 3. Radiated Emissions, 30 MHz - 1 GHz**

## **IV. Electromagnetic Compatibility Criteria for Intentional Radiators**



## Electromagnetic Compatibility Criteria for Intentional Radiators

### § 15.203 Antenna Requirement

**Test Requirement:**

**§ 15.203:** An intentional radiator shall be designed to ensure that no antenna other than that furnished by the responsible party shall be used with the device. The use of a permanently attached antenna or of an antenna that uses a unique coupling to the intentional radiator shall be considered sufficient to comply with the provisions of this section. The manufacturer may design the unit so that a broken antenna can be replaced by the user, but the use of a standard antenna jack or electrical connector is prohibited.

The structure and application of the EUT were analyzed to determine compliance with Section 15.203 of the Rules. Section 15.203 states that the subject device must meet at least one of the following criteria:

- a.) Antenna must be permanently attached to the unit.
- b.) Antenna must use a unique type of connector to attach to the EUT.
- c.) Unit must be professionally installed. Installer shall be responsible for verifying that the correct antenna is employed with the unit.

**Results:**

The EUT as tested is compliant the criteria of §15.203. The EUT has an integral antenna and a unique connector. Antenna gain is 2.2 dBi.

**Test Engineer(s):**

Shawn McMillen

**Test Date(s):**

12/20/13

## Electromagnetic Compatibility Criteria for Intentional Radiators

### § 15.207(a) Conducted Emissions Limits

**Test Requirement(s):** § 15.207 (a): For an intentional radiator that is designed to be connected to the public utility (AC) power line, the radio frequency voltage that is conducted back onto the AC power line on any frequency or frequencies, within the band 150 kHz to 30MHz, shall not exceed the limits in the following table, as measured using a 50  $\mu$ H/50  $\Sigma$  line impedance stabilization network (LISN). Compliance with the provisions of this paragraph shall be based on the measurement of the radio frequency voltage between each power line and ground at the power terminal. The lower limit applies at the boundary between the frequency ranges.

Frequency range (MHz)	§ 15.207(a), Conducted Limit (dB $\mu$ V)	
	Quasi-Peak	Average
* 0.15- 0.45	66 - 56	56 - 46
0.45 - 0.5	56	46
0.5 - 30	60	50

**Table 11. Conducted Limits for Intentional Radiators from FCC Part 15 § 15.207(a)**

**Test Procedure:** The EUT was placed on a 0.8 m-high wooden table above ground plane, and 40cm from a vertical ground plane. The EUT was powered from a 50  $\Omega$ /50  $\mu$ H Line Impedance Stabilization Network (LISN). The EMC receiver scanned the frequency range from 150 kHz to 30 MHz. Conducted Emissions measurements were made in accordance with *ANSI C63.4-2003 "Methods and Measurements of Radio-Noise Emissions from Low-Voltage Electrical and Electronic Equipment in the Range of 9kHz to 40 GHz"*. The measurements were performed over the frequency range of 0.15 MHz to 30 MHz using a 50  $\Omega$ /50  $\mu$ H LISN as the input transducer to an EMC/field intensity meter. For the purpose of this testing, the transmitter was turned on. Scans were performed with the transmitter on.

**Test Results:** The EUT was compliant with this requirement. Measured emissions were below applicable limits.

**Test Engineer(s):** Benjamin Taylor

**Test Date(s):** 12/20/13

### 15.207(a) Conducted Emissions Test Results

Frequency (MHz)	Uncorrected Meter Reading (dBμV) QP	Cable Loss (dB)	Corrected Measurement (dBμV) QP	Limit (dBμV) QP	Margin (dB) QP	Uncorrected Meter Reading (dBμV) Avg.	Cable Loss (dB)	Corrected Measurement (dBμV) AVG	Limit (dBμV) AVG	Margin (dB) AVG
1.817	43	0	43	56	-13	20.665	0	20.665	46	-25.335
2.877	24.6	0	24.6	56	-31.4	10.83	0	10.83	46	-35.17
3.324	45.9	0	45.9	56	-10.1	22.53	0	22.53	46	-23.47
3.927	51.8	0.11	51.91	56	-4.09	34.9	0.11	35.01	46	-10.99
6.46	50.7	0.17	50.87	60	-9.13	29.36	0.17	29.53	50	-20.47
7.815	21.59	0.17	21.76	60	-38.24	7.3	0.17	7.47	50	-42.53

Table 12. Conducted Emissions, 15.207(a), Phase Line, Test Results

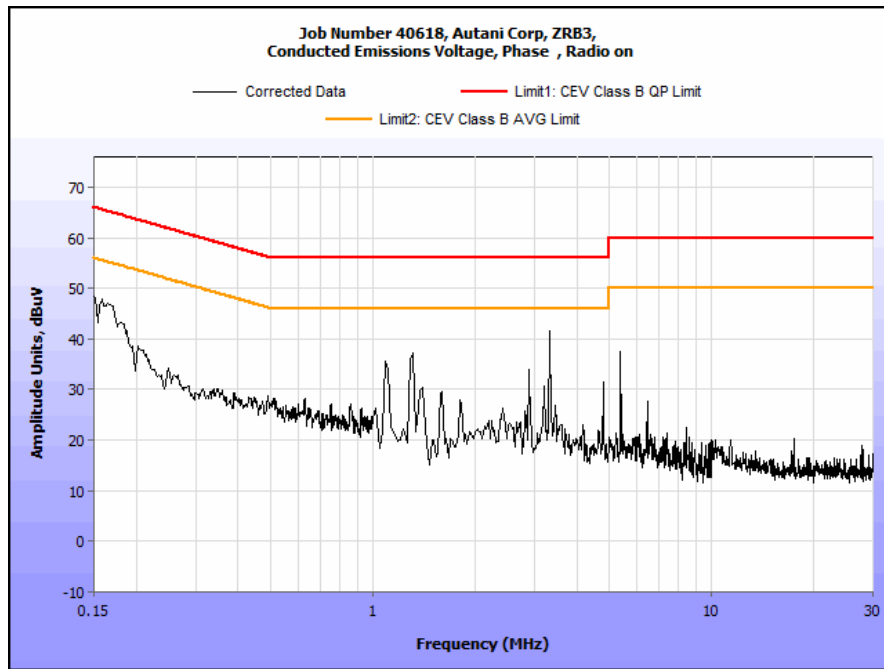

Plot 4. Conducted Emissions, 15.207(a), Phase Line

### 15.207(a) Conducted Emissions Test Results

Frequency (MHz)	Uncorrected Meter Reading (dBμV) QP	Cable Loss (dB)	Corrected Measurement (dBμV) QP	Limit (dBμV) QP	Margin (dB) QP	Uncorrected Meter Reading (dBμV) Avg.	Cable Loss (dB)	Corrected Measurement (dBμV) AVG	Limit (dBμV) AVG	Margin (dB) AVG
0.6975	31.68	0	31.68	56	-24.32	28.06	0	28.06	46	-17.94
0.8582	34.05	0	34.05	56	-21.95	32.17	0	32.17	46	-13.83
1.091	33.93	0	33.93	56	-22.07	33.96	0	33.96	46	-12.04
1.81	50.9	0	50.9	56	-5.1	26.8	0	26.8	46	-19.2
2.879	35.44	0	35.44	56	-20.56	15.75	0	15.75	46	-30.25
6.457	28.35	0.17	28.52	60	-31.48	9.67	0.17	9.84	50	-40.16

Table 13. Conducted Emissions, 15.207(a), Neutral Line, Test Results

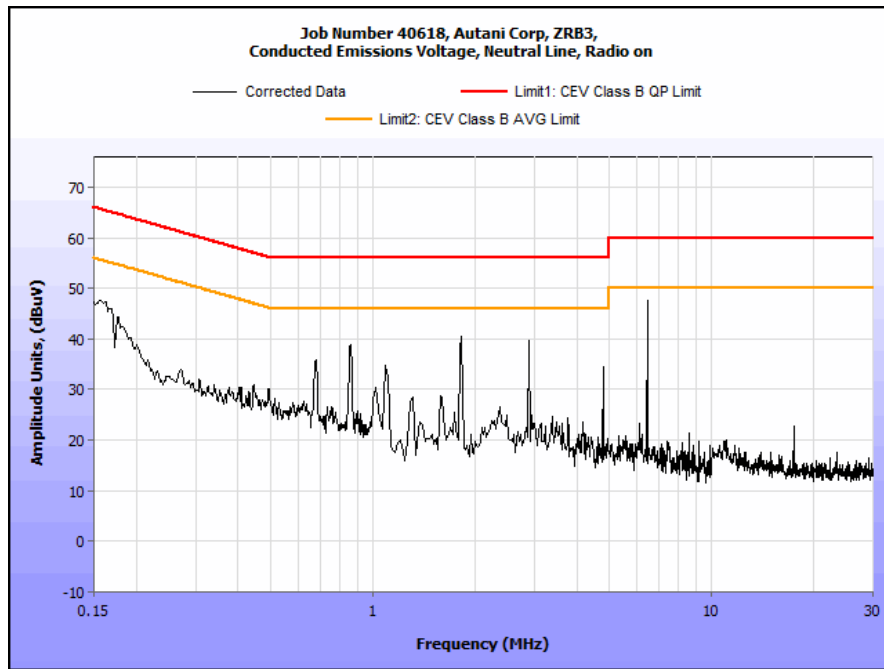

Plot 5. Conducted Emissions, 15.207(a), Neutral Line

## Electromagnetic Compatibility Criteria for Intentional Radiators

### § 15.247(a)(2) 6 dB and 99% Bandwidth

**Test Requirements:** § 15.247(a)(2): Operation under the provisions of this section is limited to frequency hopping and digitally modulated intentional radiators that comply with the following provisions:

For systems using digital modulation techniques, the EUT may operate in the 902-928 MHz, 2400-2483.5 MHz and 5725-5850 MHz bands. The minimum 6dB bandwidth shall be at least 500 kHz.

**Test Procedure:** The transmitter was on and transmitting at the highest output power. The bandwidth of the fundamental frequency was measured with the spectrum analyzer using a RBW approximately 1% of the total emission bandwidth, VBW > RBW. The 6 dB Bandwidth was measured and recorded. The measurements were performed on the low, mid and high channels.

**Test Results** The EUT was compliant with § 15.247 (a)(2).

The 6 dB and 99% Bandwidth was determined from the plots on the following pages.

**Test Engineer(s):** Shawn McMillen

**Test Date(s):** 12/20/13

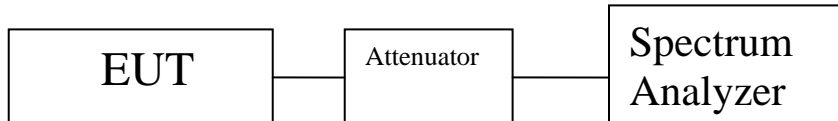

**Figure 2. Block Diagram, Occupied Bandwidth Test Setup**

### Occupied Bandwidth Test Results

Occupied Bandwidth		
Carrier Channel	Frequency (MHz)	Measured 6 dB Bandwidth (MHz)
Low	2405	1.634
Mid	2440	1.044
High	2475	1.585

**Table 14. 6 dB Occupied Bandwidth, Test Results**

Occupied Bandwidth		
Carrier Channel	Frequency (MHz)	Measured 99% Bandwidth (MHz)
Low	2405	2.3038
Mid	2440	2.4062
High	2475	2.4048

**Table 15. 99% Occupied Bandwidth, Test Results**

## 6 dB Occupied Bandwidth Test Results

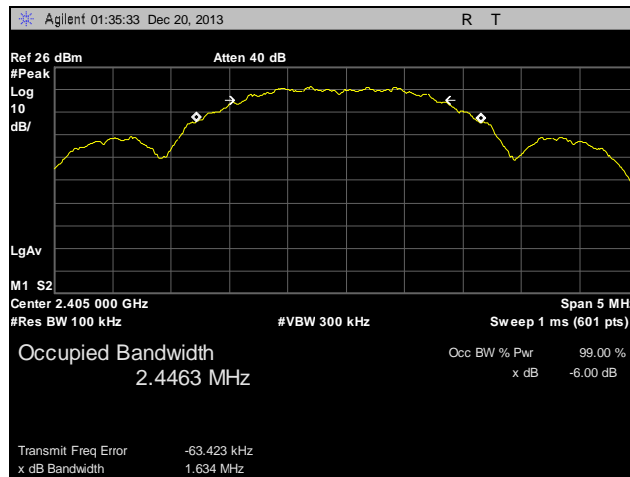

**Plot 6. 6 dB Occupied Bandwidth, Low Channel**

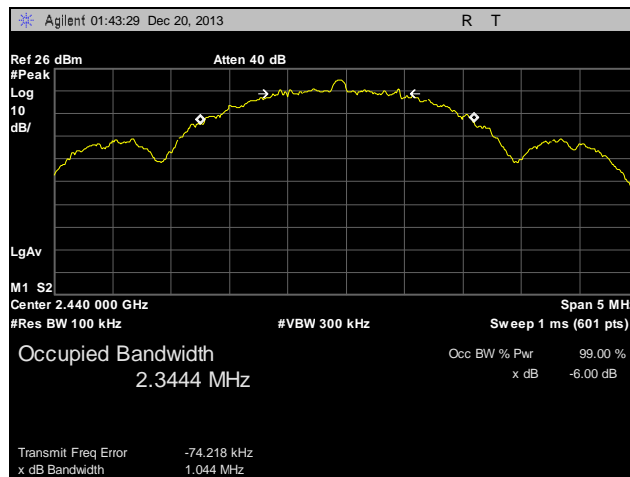

**Plot 7. 6 dB Occupied Bandwidth, Mid Channel**

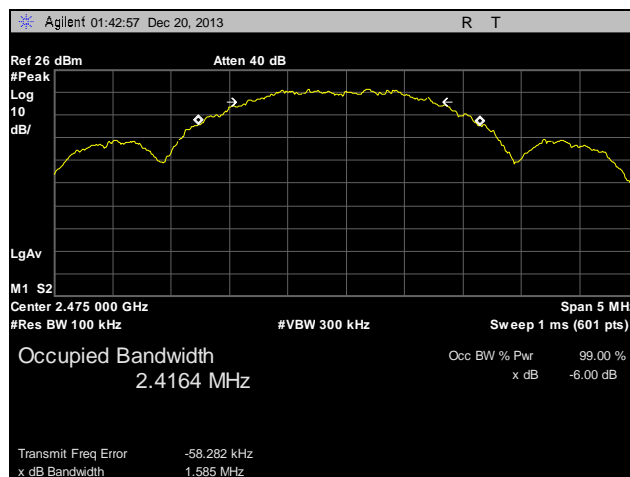

**Plot 8. 6 dB Occupied Bandwidth, High Channel**

## 99% Occupied Bandwidth Test Results

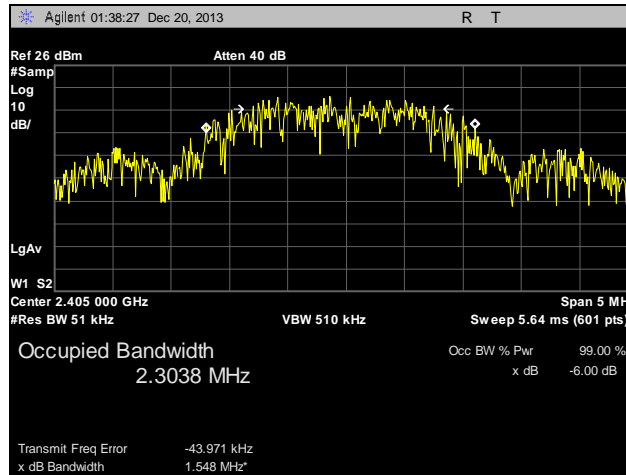

**Plot 9. 99% Occupied Bandwidth, Low Channel**

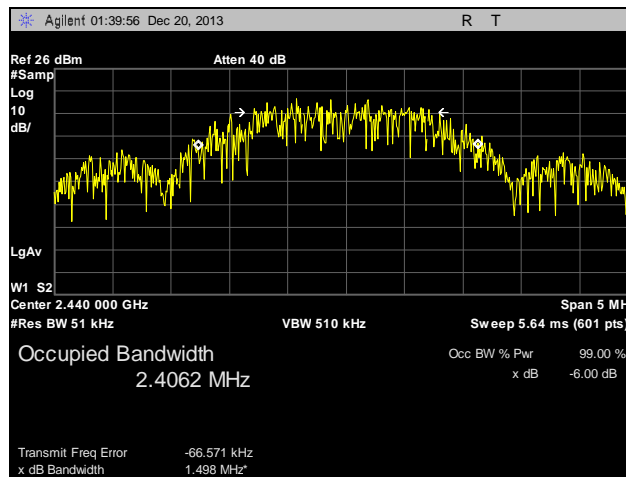

**Plot 10. 99% Occupied Bandwidth, Mid Channel**

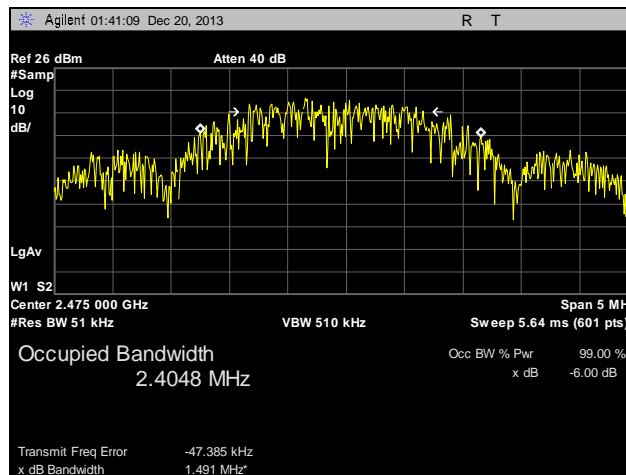

**Plot 11. 99% Occupied Bandwidth, High Channel**



## Electromagnetic Compatibility Criteria for Intentional Radiators

### § 15.247(b) Peak Power Output

**Test Requirements:** §15.247(b): The maximum peak output power of the intentional radiator shall not exceed the following:

Digital Transmission Systems (MHz)	Output Limit (Watts)
902-928	1.000
2400-2483.5	1.000
5725- 5850	1.000

**Table 16. Output Power Requirements from §15.247(b)**

§15.247(b)(4): The conducted output power limit specified in paragraph (b) of this section is based on the use of antennas with directional gains that do not exceed 6 dBi. Except as shown in paragraph (c) of this section, if transmitting antennas of directional gain greater than 6 dBi are used, the conducted output power from the intentional radiator shall be reduced below the stated values in paragraphs (b)(1), (b)(2), and (b)(3) of this section, as appropriate, by the amount in dB that the directional gain of the antenna exceeds 6 dBi.

**Test Procedure:** The transmitter was connected to a calibrated spectrum analyzer. The EUT was measured at the low, mid and high channels of each band at the maximum power level.

**Test Results:** The EUT was compliant with the Peak Power Output limits of §15.247(b).

**Test Engineer(s):** Shawn McMillen

**Test Date(s):** 12/20/13

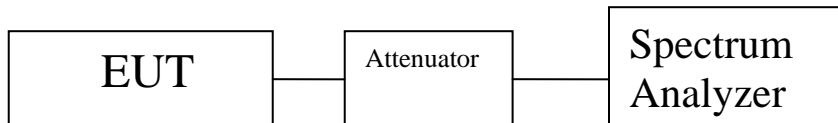

**Figure 3. Peak Power Output Test Setup**

## Peak Power Output Test Results

Peak Conducted Output Power		
Carrier Channel	Frequency (MHz)	Measured Peak Output Power dBm
Low	2405	23.65
Mid	2440	23.95
High	2475	24.04

Table 17. Peak Power Output, Test Results

## Peak Power Output Test Results

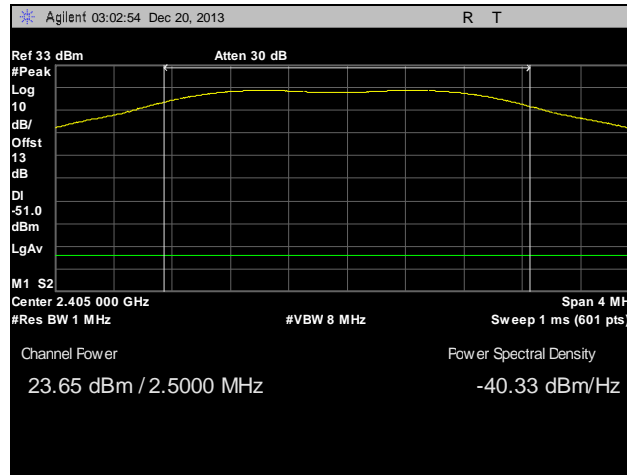

**Plot 12. Peak Power Output, Low Channel**

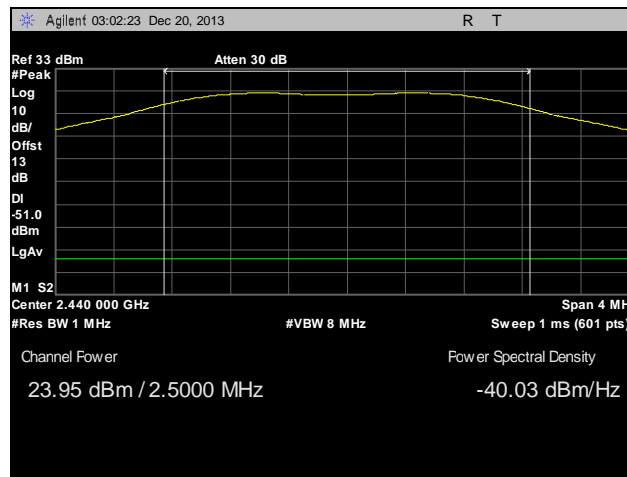

**Plot 13. Peak Power Output, Mid Channel**

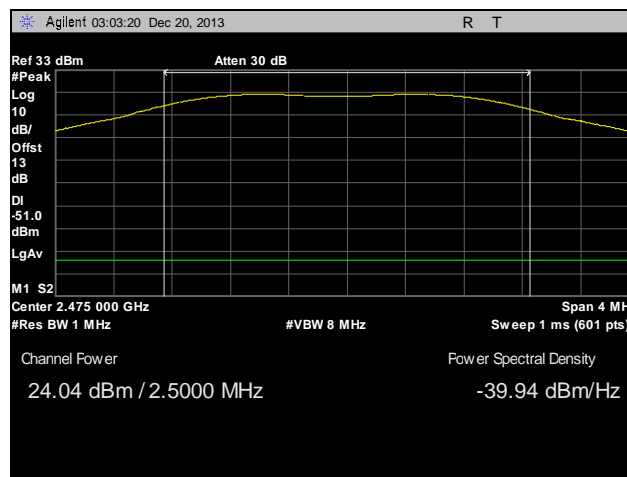

**Plot 14. Peak Power Output, High Channel**

## Electromagnetic Compatibility Criteria for Intentional Radiators

### § 15.247(d) Radiated Spurious Emissions Requirements and Band Edge

**Test Requirements:** §15.247(d); §15.205: Emissions outside the frequency band.

**§15.247(d):** In any 100 kHz bandwidth outside the frequency band in which the spread spectrum or digitally modulated intentional radiator is operating, the radio frequency power that is produced by the intentional radiator shall be at least 20 dB below that in the 100 kHz bandwidth within the band that contains the highest level of the desired power, based on either an RF conducted or a radiated measurement. Attenuation below the general limits specified in § 15.209(a) is not required. In addition, radiated emissions which fall in the restricted bands, as defined in § 15.205(a), must also comply with the radiated emission limits specified in § 15.209(a).

**§15.205(a):** Except as shown in paragraph (d) of this section, only spurious emissions are permitted in any of the frequency bands listed below:

MHz	MHz	MHz	GHz
0.090–0.110-----	16.42–16.423	399.9–410	4.5–5.15
<sup>1</sup> 0.495–0.505-----	16.69475–16.69525	608–614	5.35–5.46
2.1735–2.1905-----	16.80425–16.80475	960–1240	7.25–7.75
4.125–4.128-----	25.5–25.67	1300–1427	8.025–8.5
4.17725–4.17775-----	37.5–38.25	1435–1626.5	9.0–9.2
4.20725–4.20775-----	73–74.6	1645.5–1646.5	9.3–9.5
6.215–6.218-----	74.8–75.2	1660–1710	10.6–12.7
6.26775–6.26825-----	108–121.94	1718.8–1722.2	13.25–13.4
6.31175–6.31225-----	123–138	2200–2300	14.47–14.5
8.291–8.294-----	149.9–150.05	2310–2390	15.35–16.2
8.362–8.366-----	156.52475–156.52525	2483.5–2500	17.7–21.4
8.37625–8.38675-----	156.7–156.9	2655–2900	22.01–23.12
8.41425–8.41475-----	162.0125–167.17	3260–3267	23.6–24.0
12.29–12.293-----	167.72–173.2	3332–3339	31.2–31.8
12.51975–12.52025-----	240–285	3345.8–3358 36.	43–36.5
12.57675–12.57725-----	322–335.4	3600–4400	( <sup>2</sup> )

**Table 18. Restricted Bands of Operation**

<sup>1</sup> Until February 1, 1999, this restricted band shall be 0.490 – 0.510 MHz.

<sup>2</sup> Above 38.6

**Test Requirement(s):** § 15.209 (a): Except as provided elsewhere in this subpart, the emissions from an intentional radiator shall not exceed the field strength levels specified in Table 19.

Frequency (MHz)	§ 15.209(a), Radiated Emission Limits (dB $\mu$ V) @ 3m
30 - 88	40.00
88 - 216	43.50
216 - 960	46.00
Above 960	54.00

**Table 19. Radiated Emissions Limits Calculated from FCC Part 15, § 15.209 (a)**

**Test Procedures:** The transmitter was turned on. Measurements were performed of the low, mid and high Channels. The EUT was rotated orthogonally through all three axes. Plots shown are corrected for both antenna correction factor and distance and compared to a 3 m limit line. Only noise floor was measured above 18 GHz.

**Test Results:** The EUT was compliant with the Radiated Spurious Emission limits of § 15.247(d). No emissions were found above 18GHz.

**Test Engineer(s):** Shawn McMillen; Benjamin Taylor

**Test Date(s):** 12/20/13; 01/04/14

## Radiated Spurious Emissions Test Results

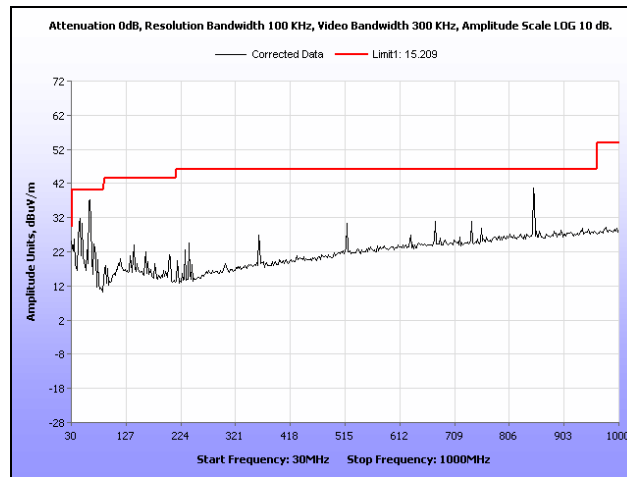

Plot 15. Radiated Spurious Emissions, Internal Antenna, Low Channel, 30 MHz – 1 GHz

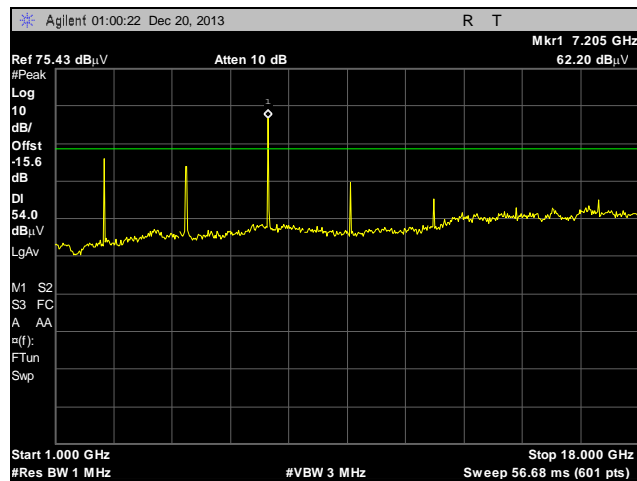

Plot 16. Radiated Spurious Emissions, Internal Antenna, Low Channel, Peak under Average, 1 GHz – 18 GHz

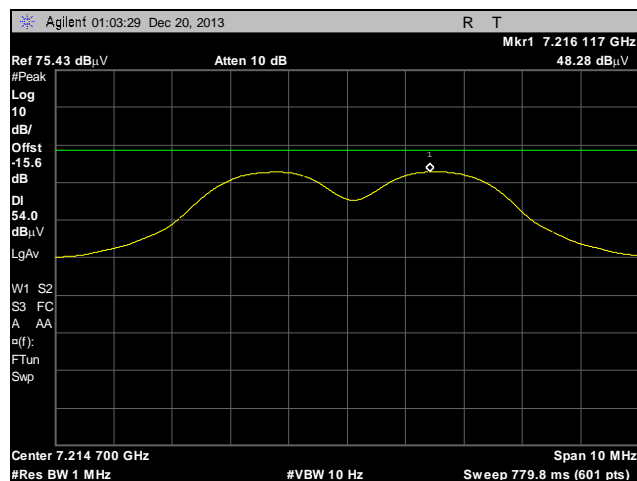

Plot 17. Radiated Spurious Emissions, Internal Antenna, Low Channel, 3<sup>rd</sup> Harmonic, Average

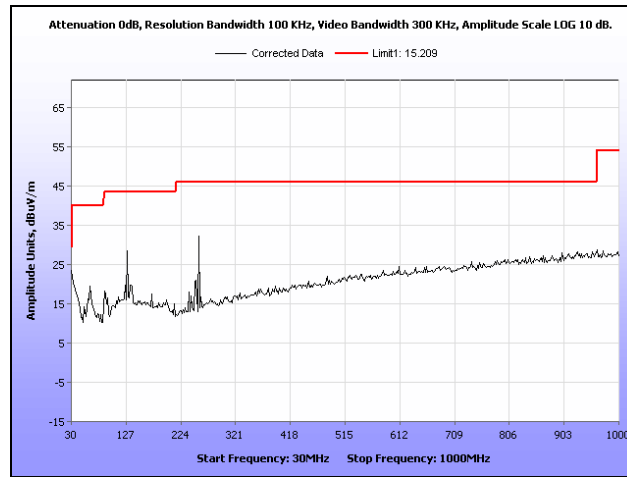

Plot 18. Radiated Spurious Emissions, Internal Antenna, Mid Channel, 30 MHz – 1 GHz

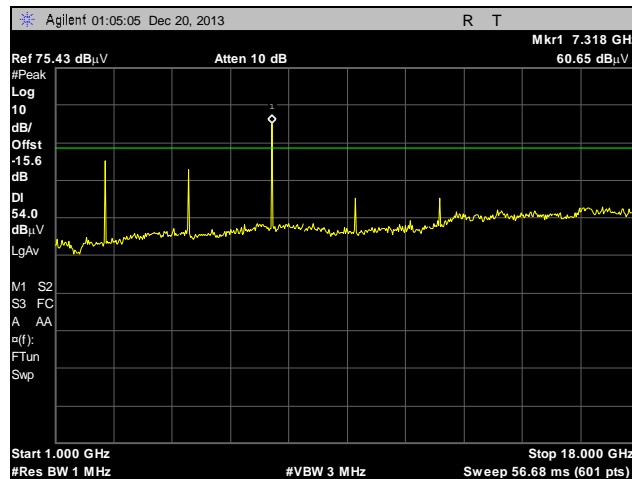

Plot 19. Radiated Spurious Emissions, Internal Antenna, Mid Channel, Peak under Average, 1 GHz – 18 GHz

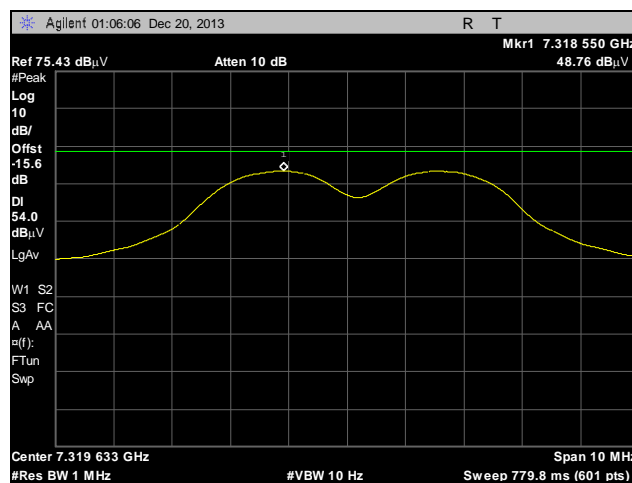

Plot 20. Radiated Spurious Emissions, Internal Antenna, Mid Channel, 3<sup>rd</sup> Harmonic, Average

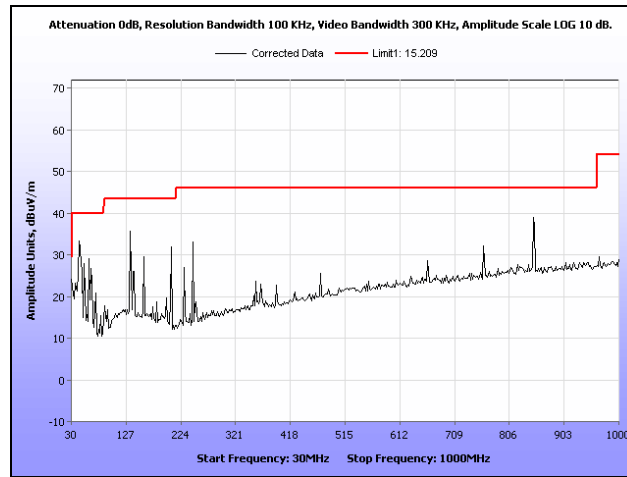

Plot 21. Radiated Spurious Emissions, Internal Antenna, High Channel, 30 MHz – 1GHz

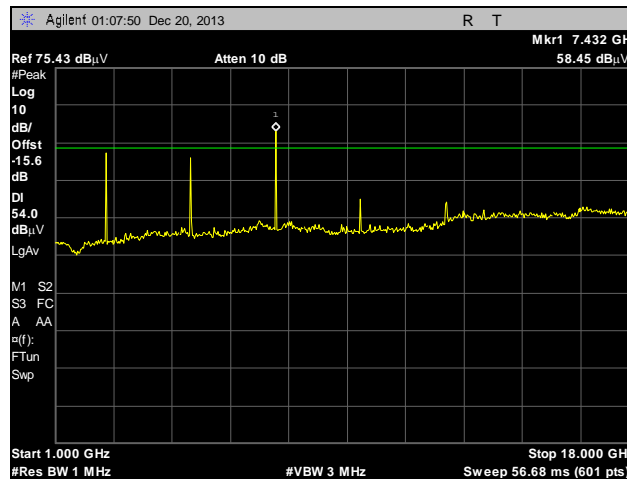

Plot 22. Radiated Spurious Emissions, Internal Antenna, High Channel, Peak under Average, 1 GHz – 18 GHz

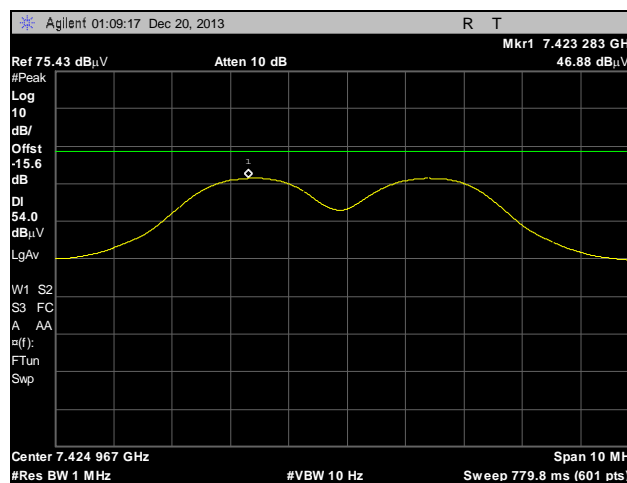

Plot 23. Radiated Spurious Emissions, Internal Antenna, High Channel, 3<sup>rd</sup> Harmonic, Average



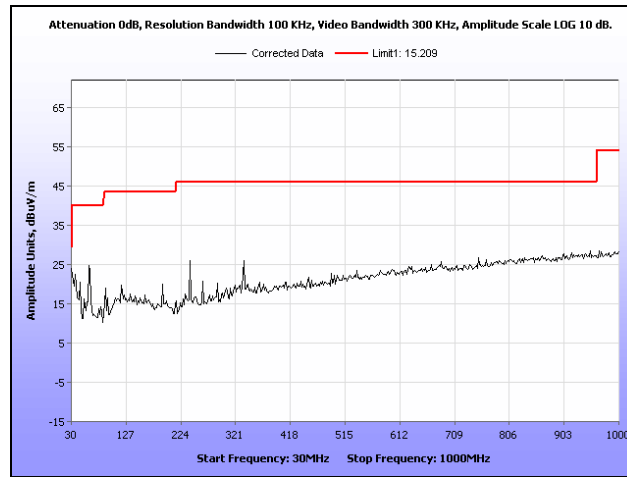

**Plot 24. Radiated Spurious Emissions, External Antenna, Low Channel, 30 MHz – 1 GHz**

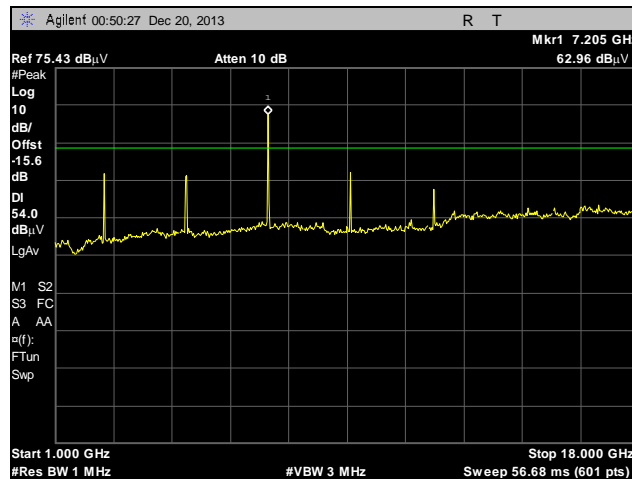

**Plot 25. Radiated Spurious Emissions, External Antenna, Low Channel, Peak Under Average, 1 GHz – 18 GHz**

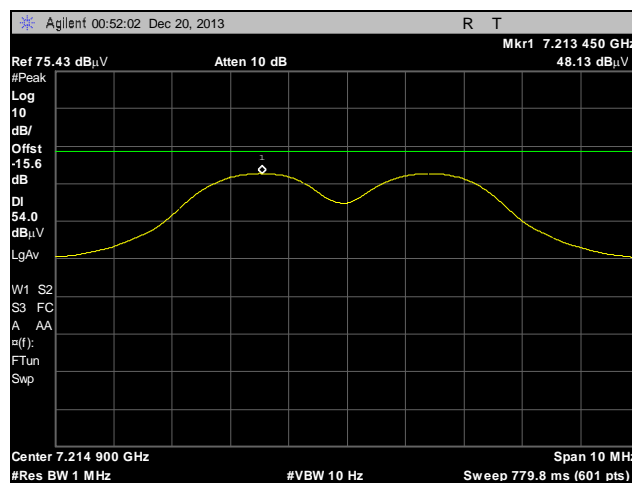

**Plot 26. Radiated Spurious Emissions, External Antenna, Low Channel, 3<sup>rd</sup> Harmonic, Average**

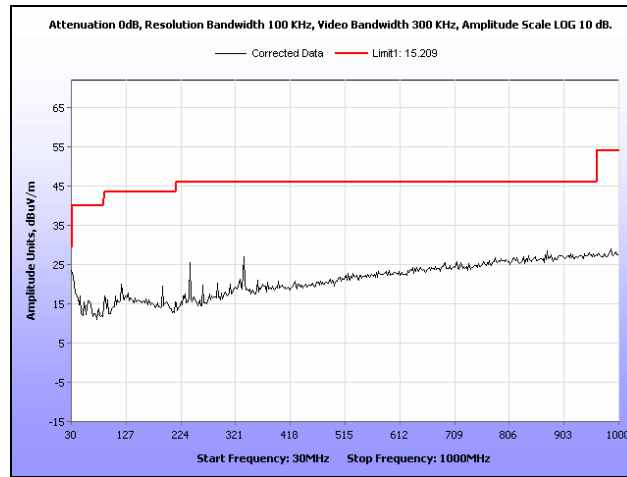

**Plot 27. Radiated Spurious Emissions, External Antenna, Mid Channel, 30 MHz – 1 GHz**

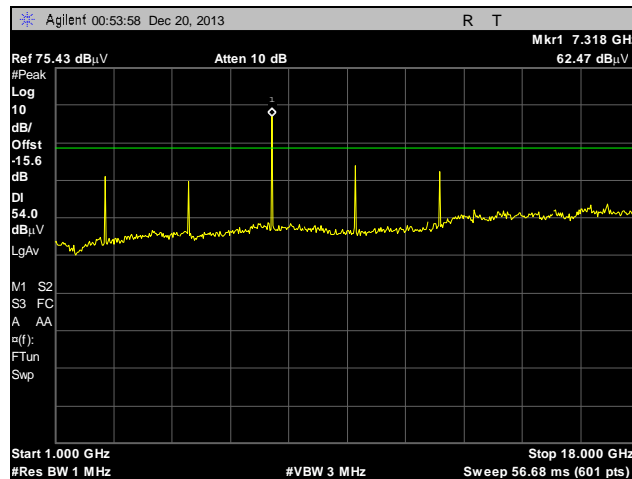

**Plot 28. Radiated Spurious Emissions, External Antenna, Mid Channel, Peak under Average, 1 GHz – 18 GHz**

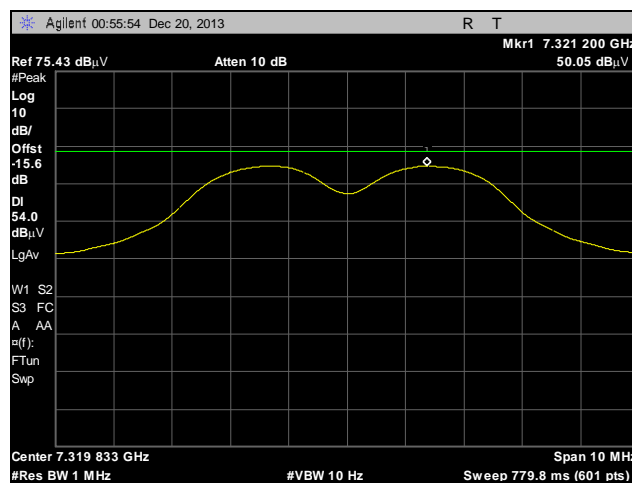

**Plot 29. Radiated Spurious Emissions, External Antenna, Mid Channel, 3<sup>rd</sup> Harmonic, Average**

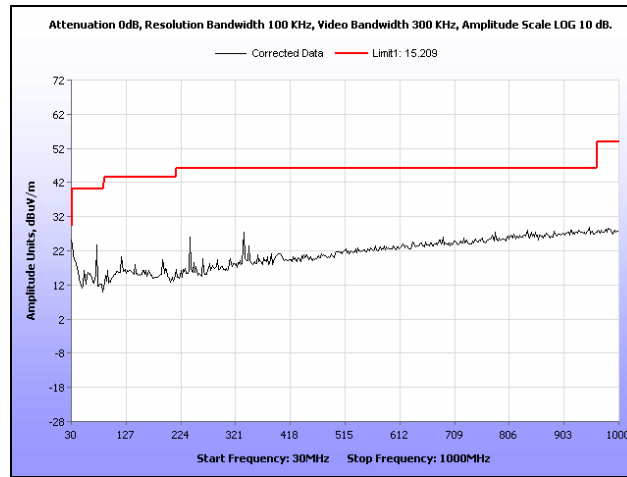

**Plot 30. Radiated Spurious Emissions, External Antenna, High Channel, 30 MHz – 1 GHz**

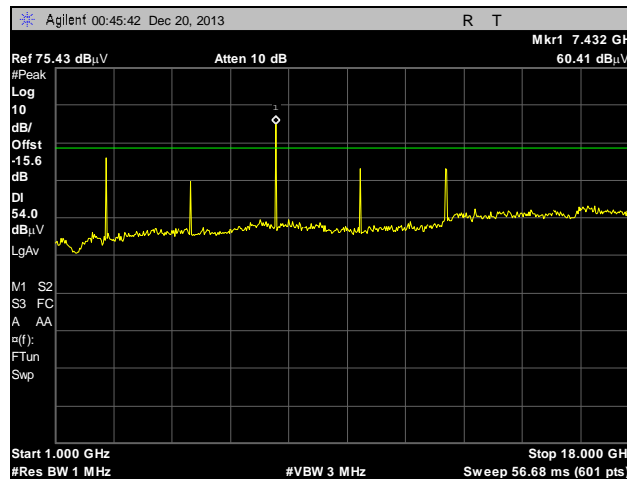

**Plot 31. Radiated Spurious Emissions, External Antenna, High Channel, Peak under Average, 1 GHz – 18 GHz**

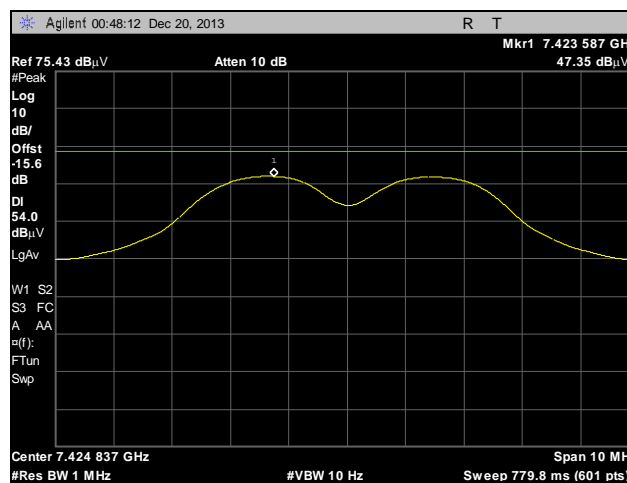

**Plot 32. Radiated Spurious Emissions, External Antenna, High Channel, 3<sup>rd</sup> Harmonic, Average**

## Radiated Band Edge Measurements

**Test Procedures:** The transmitter was turned on. Measurements were performed of the low, mid and high Channels. The EUT was rotated orthogonally through all three axes. Plots shown are corrected for both antenna correction factor and distance and compared to a 3 m limit line.

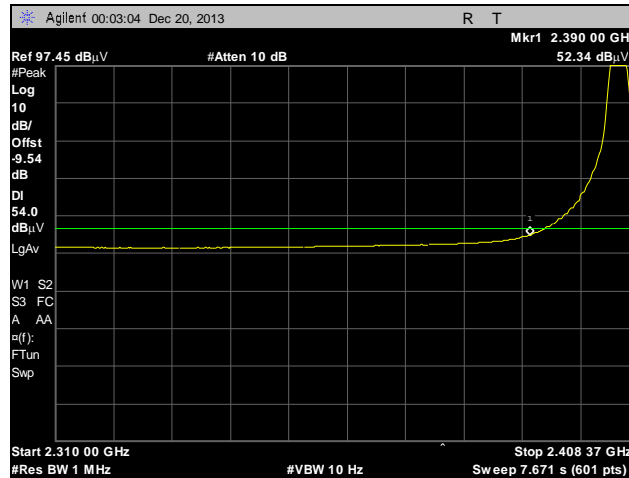

**Plot 33. Radiated Band Edge, Internal Antenna, Low Channel, Average**

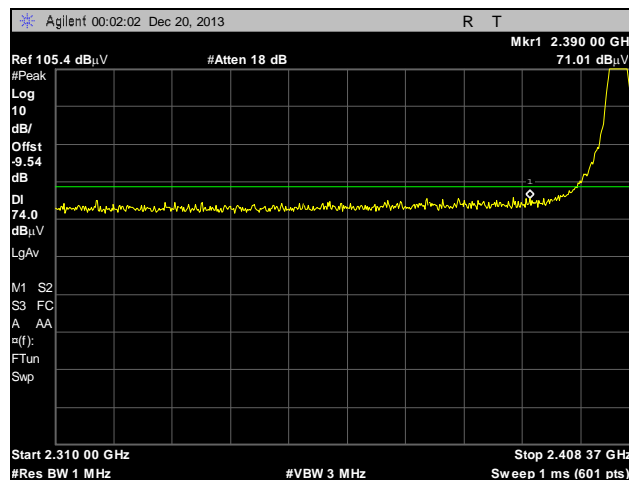

**Plot 34. Radiated Band Edge, Internal Antenna, Low Channel, Peak**

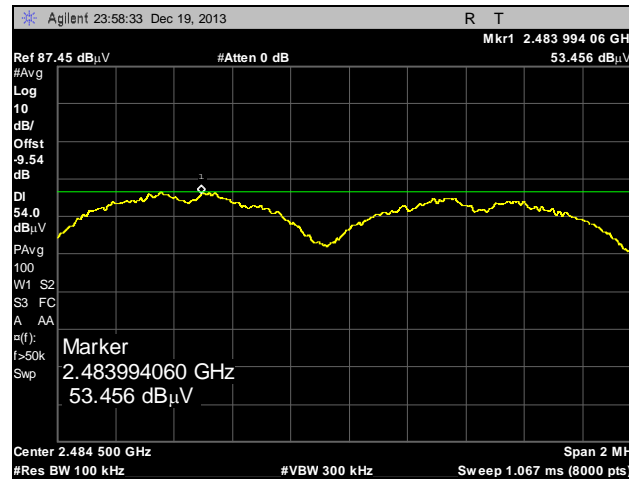

**Plot 35. Radiated Band Edge in First 2 MHz using Reduced RBW, Average, Internal Antenna, High Channel**

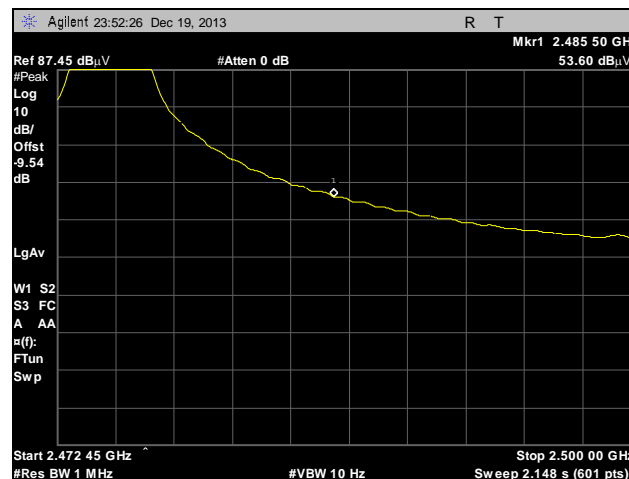

**Plot 36. Radiated Band Edge at 2483.5 MHz and Beyond, Average, Internal Antenna, High Channel**

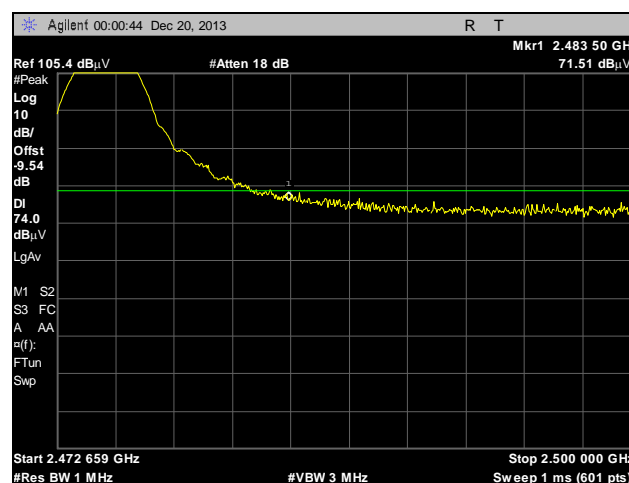

**Plot 37. Radiated Band Edge at 2483.5 MHz, Peak, Internal Antenna, High Channel**

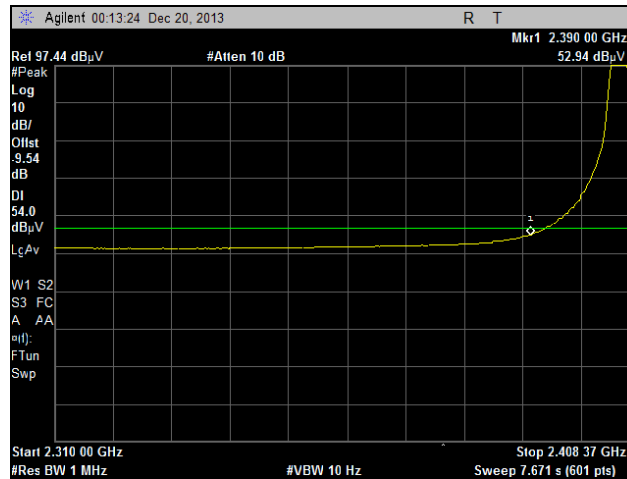

Plot 38. Radiated Band Edge, External Antenna, Low Channel, Average

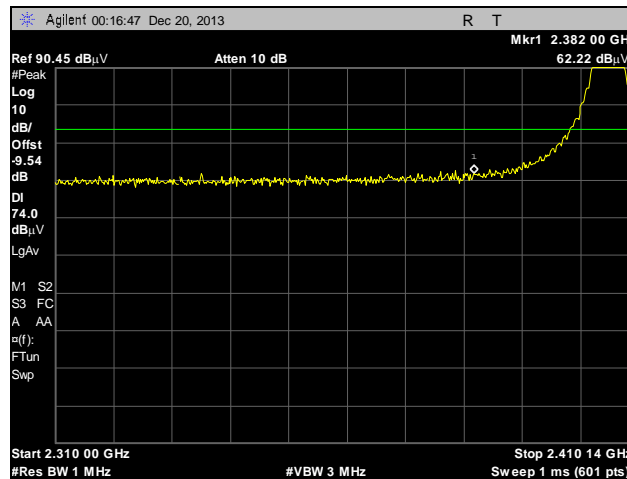

Plot 39. Radiated Band Edge, External Antenna, Low Channel, Peak

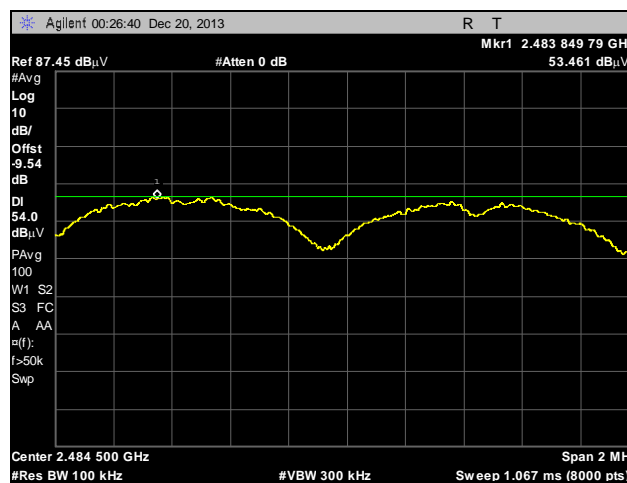

Plot 40. Radiated Band Edge in First 2 MHz using Reduced RBW, Average, External Antenna, High Channel

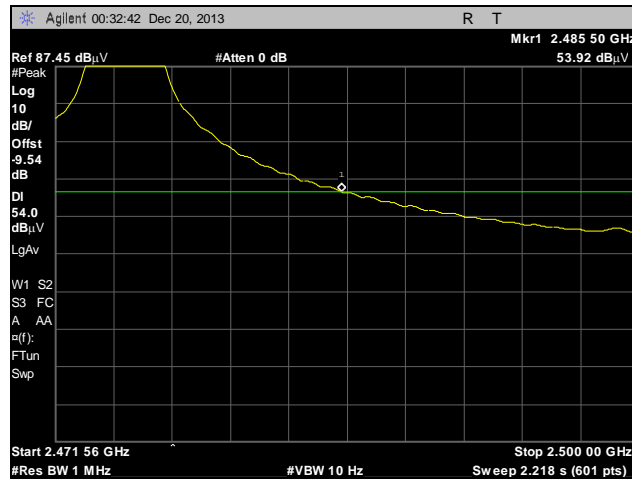

**Plot 41. Radiated Spurious Emissions, External Antenna, High Channel, 2485.5 MHz and Beyond, Average**

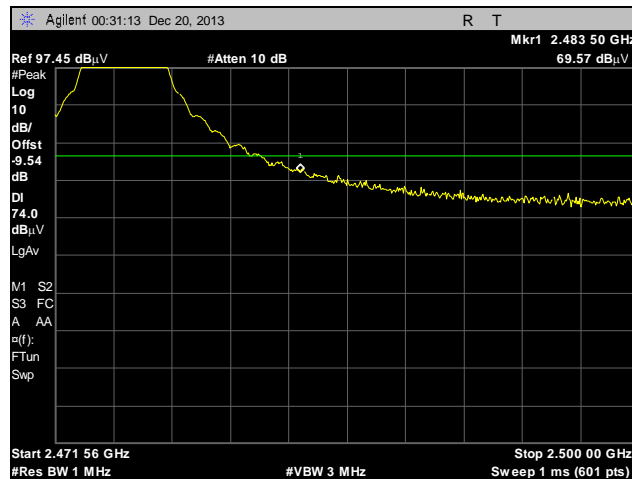

**Plot 42. Radiated Band Edge, External Antenna, High Channel, Peak**

## Electromagnetic Compatibility Criteria for Intentional Radiators

### § 15.247(d) RF Conducted Spurious Emissions Requirements and Band Edge

**Test Requirement:** **15.247(d)** In any 100 kHz bandwidth outside the frequency band in which the spread spectrum or digitally modulated intentional radiator is operating, the radio frequency power that is produced by the intentional radiator shall be at least 20 dB below that in the 100 kHz bandwidth within the band that contains the highest level of the desired power, based on either an RF conducted or a radiated measurement, provided the transmitter demonstrates compliance with the peak conducted power limits. If the transmitter complies with the conducted power limits based on the use of RMS averaging over a time interval, as permitted under paragraph (b)(3) of this section, the attenuation required under this paragraph shall be 30 dB instead of 20 dB.

**Test Procedure:** For intentional radiators with a digital device portion which operates below 10 GHz, the spectrum was investigated as per §15.33(a)(1) and §15.33(a)(4); i.e., the lowest RF signal generated or used in the device up to the 10<sup>th</sup> harmonic of the highest fundamental frequency or to 40 GHz, whichever is lower.

Since the EUT had an integral antenna, conducted measurements could not be performed. Measurements needed to be taken radiated. An antenna was located 3 m away from the EUT and plots were taken. The EUT was rotated through all three orthogonal axes. The plots were corrected for both antenna correction factor and cable loss.

See following pages for detailed test results with RF Conducted Spurious Emissions.

**Test Results:** The EUT was compliant with the Conducted Spurious Emission limits of **§15.247(d)**.

**Test Engineer(s):** Shawn McMillen

**Test Date(s):** 12/20/13

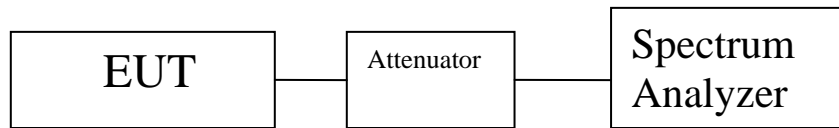
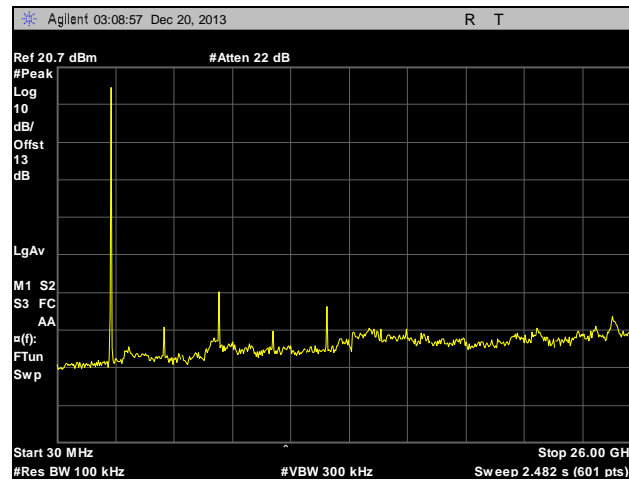

Figure 4. Block Diagram, Conducted Spurious Emissions Test Setup



## Conducted Spurious Emissions Test Results



**Plot 43. Conducted Spurious Emissions, Low Channel, 30 MHz – 26 GHz**

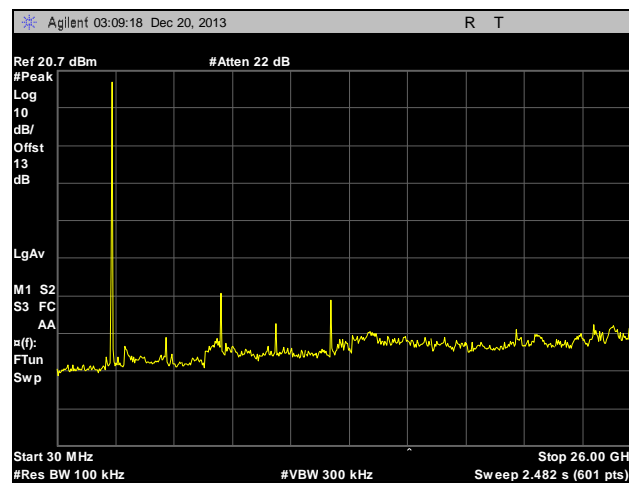

**Plot 44. Conducted Spurious Emissions, Mid Channel, 30 MHz – 26 GHz**

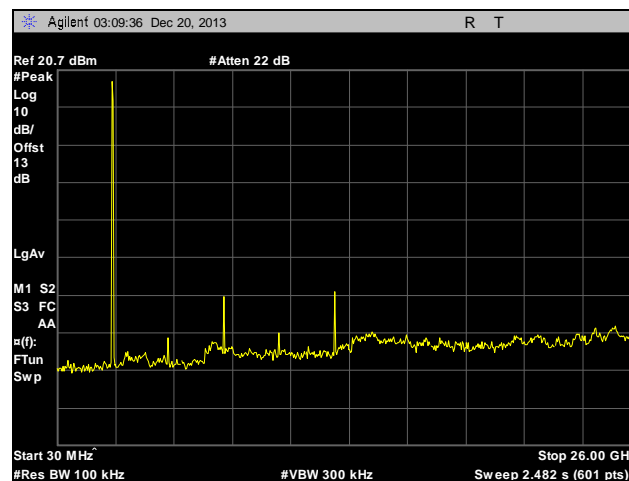

**Plot 45. Conducted Spurious Emissions, High Channel, 30 MHz – 26 GHz**

### Conducted Band Edge Test Results

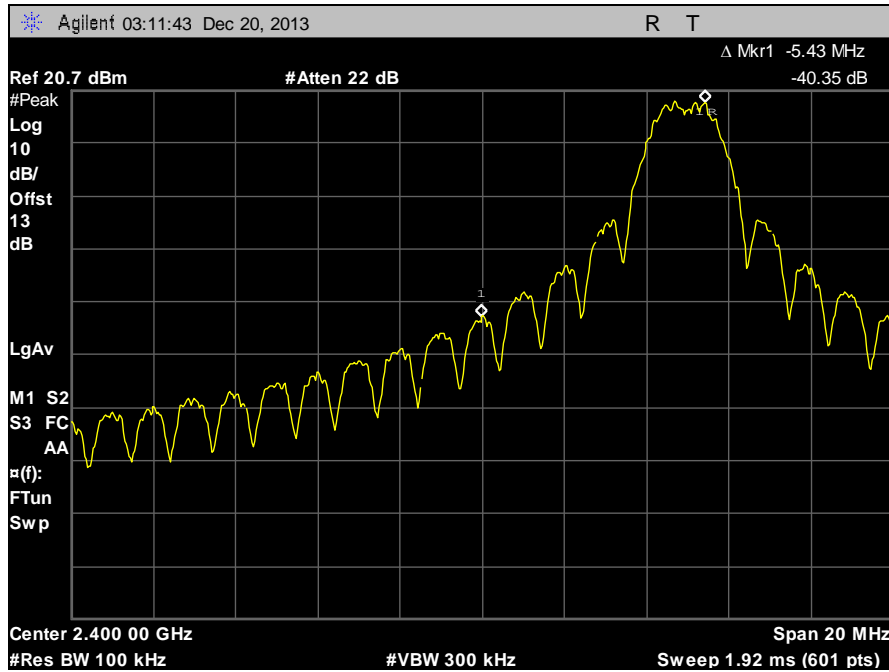

Plot 46. Conducted Band Edge, Low

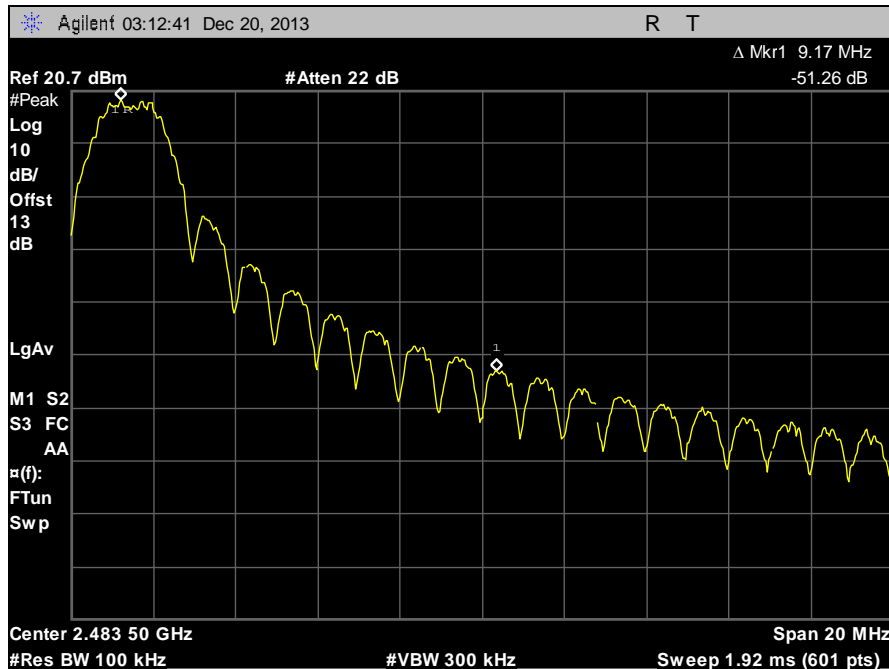

Plot 47. Conducted Band Edge, High

## Electromagnetic Compatibility Criteria for Intentional Radiators

### § 15.247(e) Peak Power Spectral Density

**Test Requirements:** §15.247(e): For digitally modulated systems, the peak power spectral density conducted from the intentional radiator to the antenna shall not be greater than 8dBm in any 3 kHz band during any time interval of continuous transmission.

**Test Procedure:** The transmitter was connected directly to a Spectrum Analyzer through an attenuator. The power level was set to the maximum level throughout each of the 100 sweeps of power averaging. The RBW was set to 3 kHz and a VBW set to 9 kHz or greater. The spectrum analyzer was set to an auto sweep time and a peak detector was used. Measurements were carried out at the low, mid and high channels.

**Test Results:** The EUT was compliant with the peak power spectral density limits of § 15.247 (e).

The peak power spectral density was determined from plots on the following page(s).

**Test Engineer:** Shawn McMillen

**Test Date:** 12/20/13

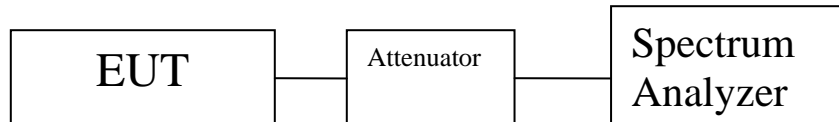

Figure 5. Block Diagram, Peak Power Spectral Density Test Setup

### Peak Power Spectral Density Test Results

Peak Power Spectral Density				
Carrier Channel	Frequency (MHz)	Measured PPSD (dBm)	Limit (dBm)	Margin (dB)
Low	2405	6.56	8	-1.44
Mid	2440	6.72	8	-1.28
High	2475	6.92	8	-1.08

Table 20. Peak Power Spectral Density, Test Results

## Peak Power Spectral Density

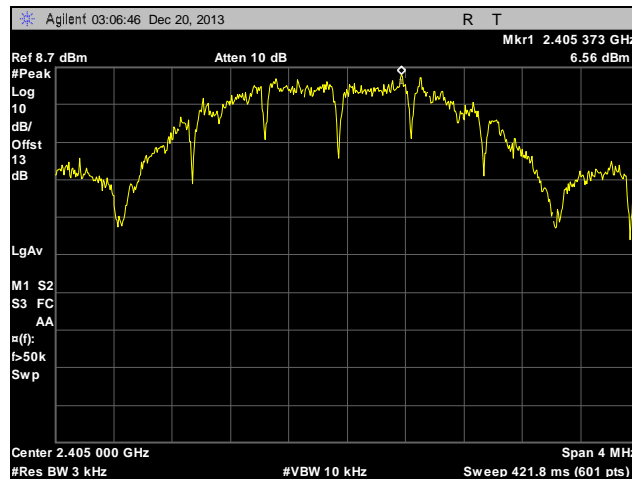

**Plot 48. Peak Power Spectral Density, Low Channel**



**Plot 49. Peak Power Spectral Density, Mid Channel**

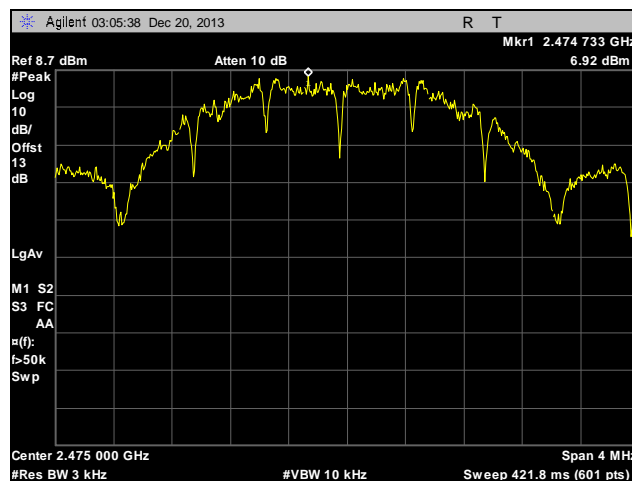

**Plot 50. Peak Power Spectral Density, High Channel**

## Electromagnetic Compatibility Criteria for Intentional Radiators

### § 15.247(i) Maximum Permissible Exposure

**RF Exposure Requirements:** §1.1307(b)(1) and §1.1307(b)(2): Systems operating under the provisions of this section shall be operated in a manner that ensures that the public is not exposed to radio frequency energy levels in excess of the Commission's guidelines.

**RF Radiation Exposure Limit:** §1.1310: As specified in this section, the Maximum Permissible Exposure (MPE) Limit shall be used to evaluate the environmental impact of human exposure to radiofrequency (RF) radiation as specified in Sec. 1.1307(b), except in the case of portable devices which shall be evaluated according to the provisions of Sec. 2.1093 of this chapter.

MPE Limit Calculation: EUT's operating frequencies @ 2400-2483.5 MHz; highest conducted power = 24.04 dBm (peak) therefore, **Limit for Uncontrolled exposure: 1 mW/cm<sup>2</sup> or 10 W/m<sup>2</sup>**

EUT maximum antenna gain = 2 dBi.

Equation from page 18 of OET 65, Edition 97-01

$$S = PG / 4\pi R^2 \quad \text{or} \quad R = \sqrt{PG / 4\pi S}$$

where, P = Power Input to antenna (253.5 mW)  
G = Antenna Gain (1.58 numeric)  
R = 20cm

$$S = 253.5 * 1.58 / 4\pi (20)^2$$
$$S = 0.08 \text{ mW/cm}^2$$

Therefore, the uncontrolled exposure limit is met at 20cm.

## IV. Test Equipment

## Test Equipment

Calibrated test equipment utilized during testing was maintained in a current state of calibration per the requirements of ISO/IEC 17025:2005.

MET Asset #	Equipment	Manufacturer	Model	Last Cal Date	Cal Due Date
1T4300	SEMI-ANECHOIC CHAMBER # 1 (NSA)	EMC TEST SYSTEMS	NONE	07/24/2012	07/24/2015
1T4751	ANTENNA - BILOG	SUNOL SCIENCES	JB6	01/08/2013	07/08/2014
1T4409	EMI RECEIVER	ROHDE & SCHWARZ	ESIB7	07/16/2012	07/16/2014
1T4818	COMB GENERATOR	COM-POWER	CGO-520	SEE NOTE	
1T4786	HYGROMETER / THERMOMETER / BAROMETER / DEW POINT PEN	CONTROL COMPANY	15-078-198, FB70423, 245CD	02/01/2012	02/01/2014
1T4149	HIGH-FREQUENCY ANECHOIC CHAMBER	RAY-PROOF	81	NOT REQUIRED	
1T4612	SPECTRUM ANALYZER	AGILENT TECHNOLOGIES	E4407B	07/30/2013	01/30/2015
1T4442	PRE-AMPLIFIER, MICROWAVE	MITEQ	AFS42-01001800-30-10P	SEE NOTE	
1T4483	ANTENNA; HORN	ETS-LINDGREN	3117	08/06/2012	02/06/2014

**Table 21. Test Equipment List**

Note: Functionally tested equipment is verified using calibrated instrumentation at the time of testing.



## **V. Certification & User's Manual Information**

## Certification & User's Manual Information

### A. Certification Information

The following is extracted from Title 47 of the Code of Federal Regulations, Part 2, Subpart I — Marketing of Radio frequency devices:

#### § 2.801 Radio-frequency device defined.

As used in this part, a radio-frequency device is any device which in its operation is capable of Emitting radio-frequency energy by radiation, conduction, or other means. Radio- frequency devices include, but are not limited to:

- (a) The various types of radio communication transmitting devices described throughout this chapter.
- (b) *The incidental, unintentional and intentional radiators defined in Part 15 of this chapter.*
- (c) The industrial, scientific, and medical equipment described in Part 18 of this chapter.
- (d) Any part or component thereof which in use emits radio-frequency energy by radiation, conduction, or other means.

#### § 2.803 Marketing of radio frequency devices prior to equipment authorization.

- (a) Except as provided elsewhere in this chapter, no person shall sell or lease, or offer for sale or lease (including advertising for sale or lease), or import, ship or distribute for the purpose of selling or leasing or offering for sale or lease, any radio frequency device unless:
  - (1) In the case of a device subject to certification, such device has been authorized by the Commission in accordance with the rules in this chapter and is properly identified and labeled as required by §2.925 and other relevant sections in this chapter; or
  - (2) In the case of a device that is not required to have a grant of equipment authorization issued by the Commission, but which must comply with the specified technical standards prior to use, such device also complies with all applicable administrative (including verification of the equipment or authorization under a Declaration of Conformity, where required), technical, labeling and identification requirements specified in this chapter.
- (d) Notwithstanding the provisions of paragraph (a) of this section, the offer for sale solely to business, commercial, industrial, scientific or medical users (but not an offer for sale to other parties or to end users located in a residential environment) of a radio frequency device that is in the conceptual, developmental, design or pre-production stage is permitted prior to equipment authorization or, for devices not subject to the equipment authorization requirements, prior to a determination of compliance with the applicable technical requirements *provided* that the prospective buyer is advised in writing at the time of the offer for sale that the equipment is subject to the FCC rules and that the equipment will comply with the appropriate rules before delivery to the buyer or to centers of distribution.

- (e)(1) Notwithstanding the provisions of paragraph (a) of this section, prior to equipment authorization or determination of compliance with the applicable technical requirements any radio frequency device may be operated, but not marketed, for the following purposes and under the following conditions:
- (i) *Compliance testing*;
  - (ii) Demonstrations at a trade show provided the notice contained in paragraph (c) of this section is displayed in a conspicuous location on, or immediately adjacent to, the device;
  - (iii) Demonstrations at an exhibition conducted at a business, commercial, industrial, scientific or medical location, but excluding locations in a residential environment, provided the notice contained in paragraphs (c) or (d) of this section, as appropriate, is displayed in a conspicuous location on, or immediately adjacent to, the device;
  - (iv) Evaluation of product performance and determination of customer acceptability, provided such operation takes place at the manufacturer's facilities during developmental, design or pre-production states; or
  - (v) Evaluation of product performance and determination of customer acceptability where customer acceptability of a radio frequency device cannot be determined at the manufacturer's facilities because of size or unique capability of the device, provided the device is operated at a business, commercial, industrial, scientific or medical user's site, but not at a residential site, during the development, design or pre-production stages.
- (e)(2) For the purpose of paragraphs (e)(1)(iv) and (e)(1)(v) of this section, the term *manufacturer's facilities* includes the facilities of the party responsible for compliance with the regulations and the manufacturer's premises, as well as the facilities of other entities working under the authorization of the responsible party in connection with the development and manufacture, but not the marketing, of the equipment.
- (f) For radio frequency devices subject to verification and sold solely to business, commercial, industrial, scientific and medical users (excluding products sold to other parties or for operation in a residential environment), parties responsible for verification of the devices shall have the option of ensuring compliance with the applicable technical specifications of this chapter at each end user's location after installation, provided that the purchase or lease agreement includes a proviso that such a determination of compliance be made and is the responsibility of the party responsible for verification of the equipment.

## Certification & User's Manual Information

The following is extracted from Title 47 of the Code of Federal Regulations, Part 2, Subpart J — Equipment Authorization Procedures:

### § 2.901 Basis and Purpose

- (a) In order to carry out its responsibilities under the Communications Act and the various treaties and international regulations, and in order to promote efficient use of the radio spectrum, the Commission has developed technical standards for radio frequency equipment and parts or components thereof. The technical standards applicable to individual types of equipment are found in that part of the rules governing the service wherein the equipment is to be operated.<sup>1</sup> *In addition to the technical standards provided, the rules governing the service may require that such equipment be verified by the manufacturer or importer, be authorized under a Declaration of Conformity, or receive an equipment authorization from the Commission by one of the following procedures: certification or registration.*
- (b) The following sections describe the verification procedure, the procedure for a Declaration of Conformity, and the procedures to be followed in obtaining certification from the Commission and the conditions attendant to such a grant.

### § 2.907 Certification.

- (a) Certification is an equipment authorization issued by the Commission, based on representation and test data submitted by the applicant.
- (b) Certification attaches to all units subsequently marketed by the grantee which are identical (see Section 2.908) to the sample tested except for permissive changes or other variations authorized by the Commission pursuant to Section 2.1043.

---

<sup>1</sup> In this case, the equipment is subject to the rules of Part 15. More specifically, the equipment falls under Subpart B (of Part 15), which deals with unintentional radiators.

## Certification & User's Manual Information

### § 2.948 Description of measurement facilities.

- (a) Each party making measurements of equipment that is subject to an equipment authorization under Part 15 or Part 18 of this chapter, regardless of whether the measurements are filed with the Commission or kept on file by the party responsible for compliance of equipment marketed within the U.S. or its possessions, shall compile a description of the measurement facilities employed.
- (1) If the measured equipment is subject to the verification procedure, the description of the measurement facilities shall be retained by the party responsible for verification of the equipment.
- (i) *If the equipment is verified through measurements performed by an independent laboratory, it is acceptable for the party responsible for verification of the equipment to rely upon the description of the measurement facilities retained by or placed on file with the Commission by that laboratory. In this situation, the party responsible for the verification of the equipment is not required to retain a duplicate copy of the description of the measurement facilities.*
- (ii) If the equipment is verified based on measurements performed at the installation site of the equipment, no specific site calibration data is required. It is acceptable to retain the description of the measurement facilities at the site at which the measurements were performed.
- (2) If the equipment is to be authorized by the Commission under the certification procedure, the description of the measurement facilities shall be filed with the Commission's Laboratory in Columbia, Maryland. The data describing the measurement facilities need only be filed once but must be updated as changes are made to the measurement facilities or as otherwise described in this section. At least every three years, the organization responsible for filing the data with the Commission shall certify that the data on file is current.

## Certification & User's Manual Information

### 1. Label and User's Manual Information

The following is extracted from Title 47 of the Code of Federal Regulations, Part 15, Subpart A — General:

#### § 15.19 Labeling requirements.

(a) *In addition to the requirements in Part 2 of this chapter, a device subject to certification or verification shall be labeled as follows:*

- (1) Receivers associated with the operation of a licensed radio service, e.g., FM broadcast under Part 73 of this chapter, land mobile operation under Part 90, etc., shall bear the following statement in a conspicuous location on the device:

This device complies with Part 15 of the FCC Rules. Operation is subject to the condition that this device does not cause harmful interference.

- (2) A stand-alone cable input selector switch, shall bear the following statement in a conspicuous location on the device:

This device is verified to comply with Part 15 of the FCC Rules for use with cable television service.

- (3) All other devices shall bear the following statement in a conspicuous location on the device:

*This device complies with Part 15 of the FCC Rules. Operation is subject to the following two conditions: (1) This device may not cause harmful interference, and (2) this device must accept any interference received, including interference that may cause undesired operation.*

- (4) Where a device is constructed in two or more sections connected by wires and marketed together, the statement specified under paragraph (a) of this section is required to be affixed only to the main control unit.

- (5) When the device is so small or for such use that it is not practicable to place the statement specified under paragraph (a) of this section on it, the information required by this paragraph shall be placed in a prominent location in the instruction manual or pamphlet supplied to the user or, alternatively, shall be placed on the container in which the device is marketed. However, the FCC identifier or the unique identifier, as appropriate, must be displayed on the device.

#### § 15.21 Information to user.

The user's manual or instruction manual for an intentional or unintentional radiator shall caution the user that changes or modifications not expressly approved by the party responsible for compliance could void the user's authority to operate the equipment.

## Verification & User's Manual Information

The following is extracted from Title 47 of the Code of Federal Regulations, Part 15, Subpart B — Unintentional Radiators:

### § 15.105 Information to the user.

- (a) For a Class A digital device or peripheral, the instructions furnished the user shall include the following or similar statement, placed in a prominent location in the text of the manual:

Note: This equipment has been tested and found to comply with the limits for a Class A digital device, pursuant to Part 15 of the FCC Rules. These limits are designed to provide reasonable protection against harmful interference when the equipment is operated in a commercial environment. This equipment generates, uses, and can radiate radio frequency energy and, if not installed and used in accordance with the instruction manual, may cause harmful interference to radio communications. Operation of this equipment in a residential area is likely to cause harmful interference in which case the user will be required to correct the interference at own expense.

- (b) For a Class B digital device or peripheral, the instructions furnished the user shall include the following or similar statement, placed in a prominent location in the text of the manual:

Note: This equipment has been tested and found to comply with the limits for a Class B digital device, pursuant to Part 15 of the FCC Rules. These limits are designed to provide reasonable protection against harmful interference when the equipment is operated in a residential environment. This equipment generates, uses, and can radiate radio frequency energy and, if not installed and used in accordance with the instruction manual, may cause harmful interference to radio communications. However, there is no guarantee that interference will not occur in a particular installation. If this equipment does cause harmful interference to radio or television reception, which can be determined by turning the equipment off and on, the user is encouraged to try to correct the interference by one or more of the following measures:

- Reorient or relocate the receiving antenna.
- Increase the separation between the equipment and receiver.
- Connect the equipment into an outlet on a circuit different from that to which the receiver is connected.
- Consult the dealer or an experienced radio/TV technician for help.

## ICES-003 Procedural & Labeling Requirements

From the Industry Canada Electromagnetic Compatibility Advisory Bulletin entitled, "Implementation and Interpretation of the Interference-Causing Equipment Standard for Digital Apparatus, ICES-003" (EMCAB-3, Issue 2, July 1995):

"At present, CISPR 22: 2002 and ICES technical requirements are essentially equivalent. Therefore, if you have CISPR 22: 2002 approval by meeting CISPR Publication 22, the only additional requirements are: to attach a note to the report of the test results for compliance, indicating that these results are deemed satisfactory evidence of compliance with ICES-003 of the Canadian Interference-Causing Equipment Regulations; to maintain these records on file for the requisite five year period; and to provide the device with a notice of compliance in accordance with ICES-003."

### Procedural Requirements:

According to Industry Canada's Interference Causing Equipment Standard for Digital Apparatus ICES-003 Issue 5 August 2012:

- Section 6.1: A record of the measurements and results, showing the date that the measurements were completed, shall be retained by the manufacturer or importer for a period of at least five years from the date shown in the record and made available for examination on the request of the Minister.
- Section 6.2: A written notice indicating compliance must accompany each unit of digital apparatus to the end user. The notice shall be in the form of a label that is affixed to the apparatus. Where because of insufficient space or other constraints it is not feasible to affix a label to the apparatus, the notice may be in the form of a statement in the users' manual.

### Labeling Requirements:

The suggested text for the notice, in English and in French, is provided below, from the Annex of ICES-003:

CAN ICES-3 (A)/NMB-3(A)



# End of Report