

Measurement of Antenna for W30E Project

Manufacture: SHENZHEN TENDA TECHNOLOGY CO., LTD.

1. Antenna Appearance:

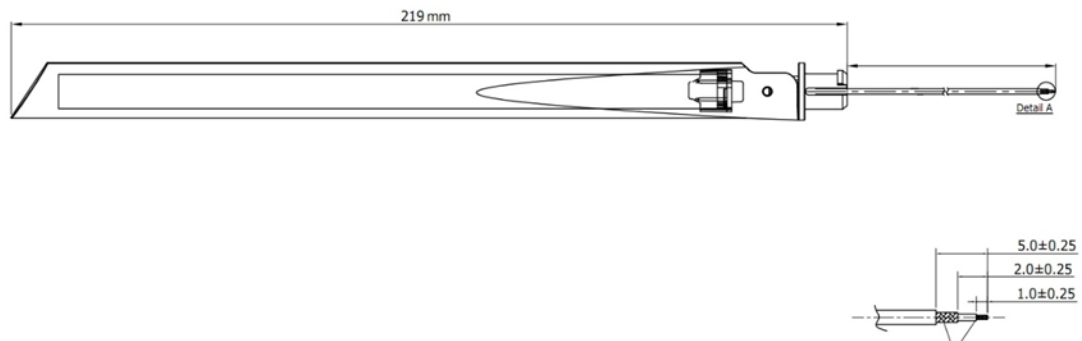

2. Electrical performance test results at normal temperature

a) 2. 4G Antenna

No	Test Item	Unit	Demand Performance	Test Result		Judgement
1	Frequency Range	MHz	2400-2500	2400-2500		OK
2	Gain	dBi	5	2400	4.49	OK
				2450	4.47	OK
				2500	4.94	OK
3	Isolation	dB	≤ -15	2400	-26	OK
				2450	-25	OK
				2500	-24	OK
4	Return loss	dB	≤ -10	2400	-21	OK
				2450	-19	OK
				2500	-14	OK

B) 5G Antenna

No	Test Item	Unit	Demand Performance	Test Result		Judgement
1	Frequency Range	MHz	5150-5850	5150-5850		OK
2	Gain	dBi	5	5150	5.93	OK
				5500	5.49	OK
				5850	5.34	OK
3	Isolation	dB	≤ -15	5150	-25	OK
				5500	-27	OK
				5850	-28	OK
4	Return loss	dB	≤ -10	5150	-14	OK
				5500	-25	OK
				5850	-22	OK

Directional diagram for 2.4GHz

EUT		
Remark		
Frequency	E Total. dB(dB)	Efficiency()
2400MHz	4.49	70%
2410MHz	4.56	73%
2420MHz	4.75	78%
2430MHz	4.83	82%
2440MHz	4.70	84%
2450MHz	4.47	85%
2460MHz	4.58	87%
2470MHz	4.84	92%
2480MHz	5.00	97%
2490MHz	5.00	98%
2500MHz	4.94	96%

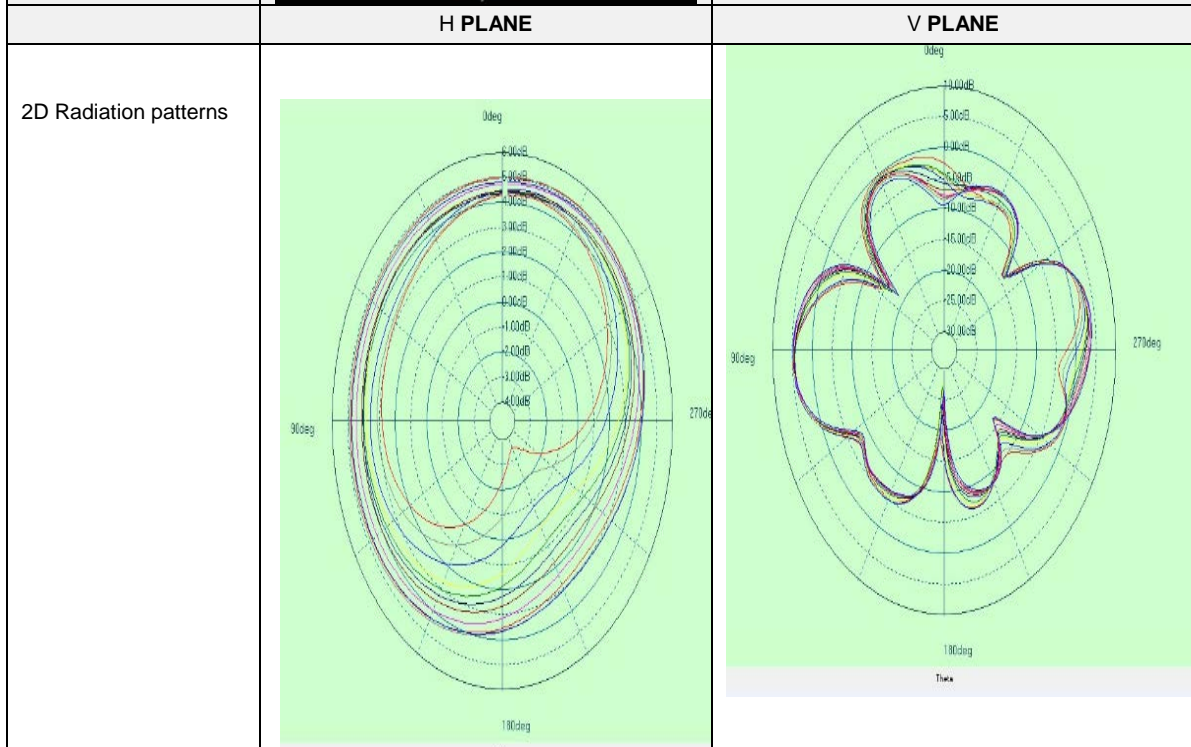
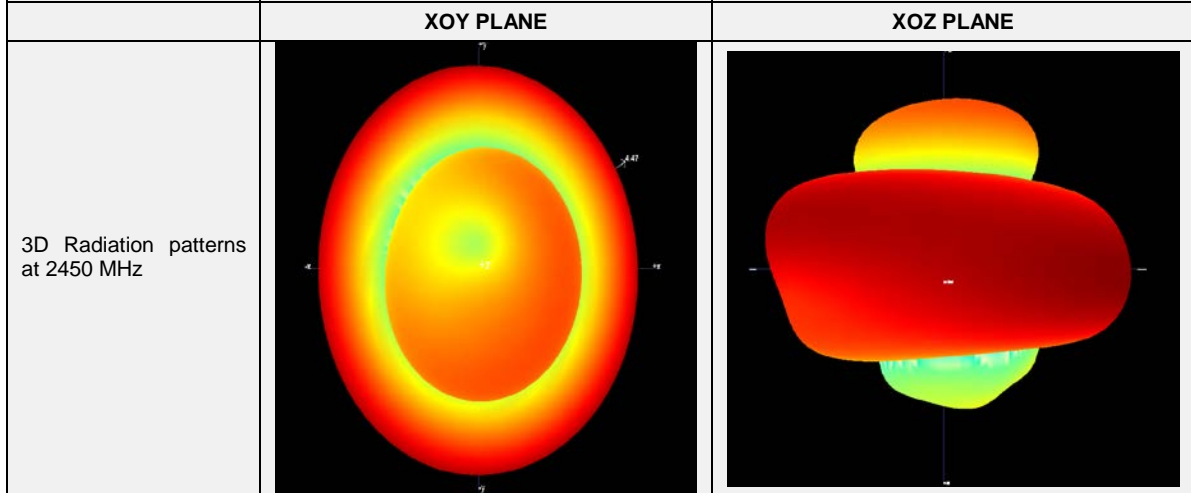

Directional diagram for 5GHz

Frequency	E Total. dB(dBi)	Efficiency()
5000MHz	5.43	68%
5050MHz	5.68	73%
5100MHz	5.75	76%
5150MHz	5.93	77%
5200MHz	5.90	79%
5250MHz	5.86	79%
5300MHz	5.97	80%
5350MHz	6.02	82%
5400MHz	5.85	80%
5450MHz	5.85	81%
5500MHz	5.49	77%
5550MHz	5.41	76%
5600MHz	5.24	74%
5650MHz	4.98	75%
5700MHz	5.12	76%
5750MHz	5.24	77%
5800MHz	4.99	74%
5850MHz	5.34	77%
5900MHz	5.30	74%
5950MHz	5.91	84%
6000MHz	5.58	80%

XOY_PLANE

XOZ PLANE

3D Radiation patterns at 5150 MHz

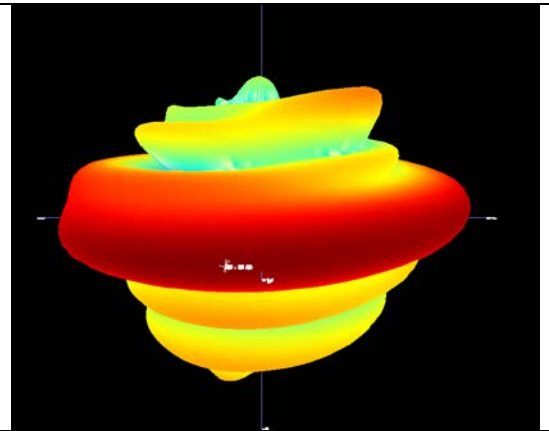
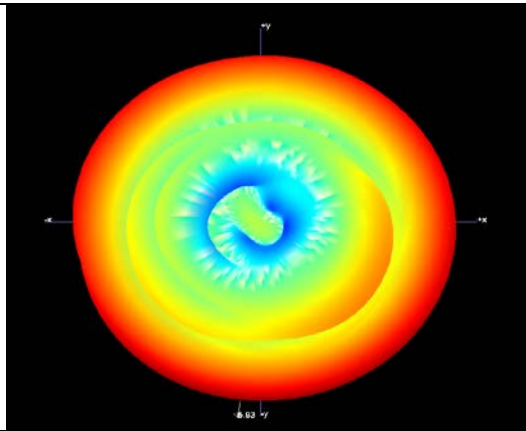

2D Radiation patterns

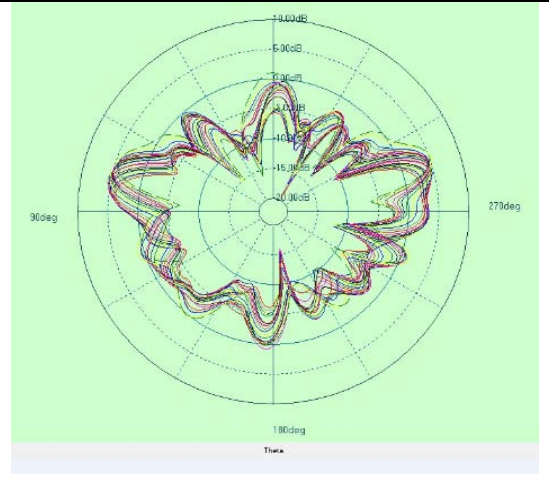
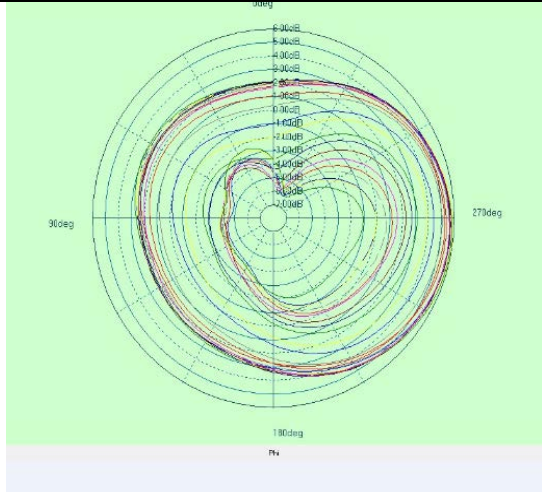

2. 4G Return loss test

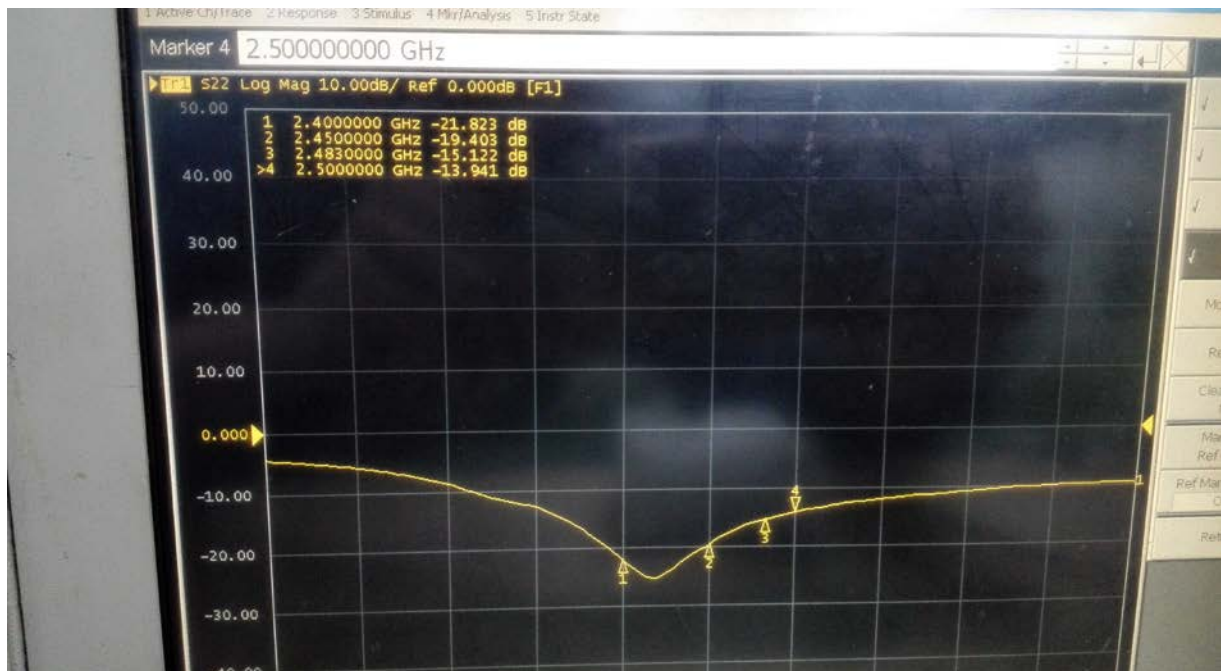

2. 4G Isolation

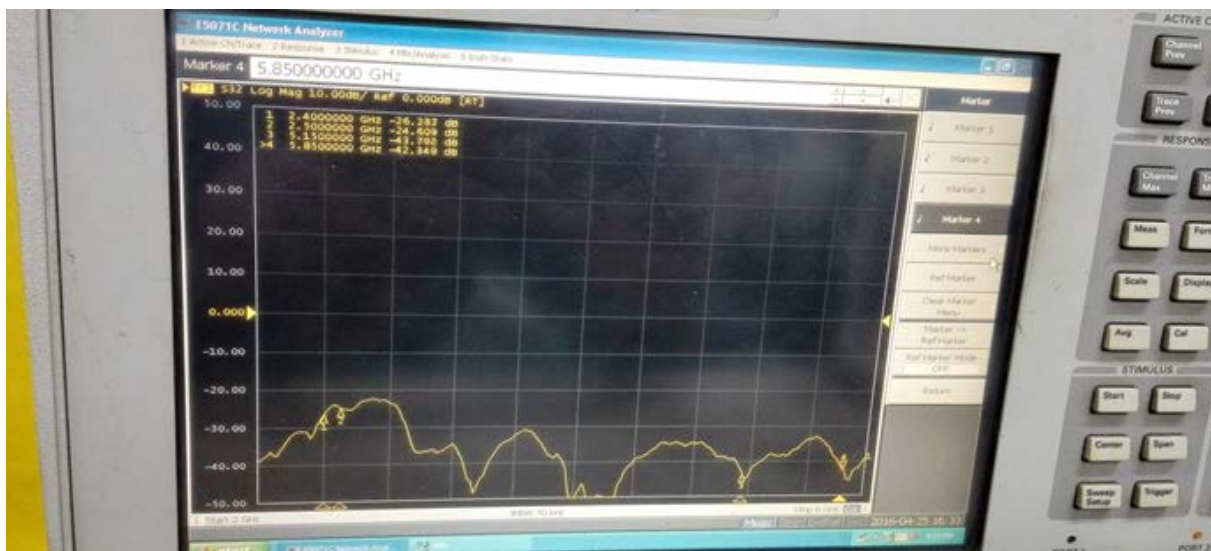

5G Return loss test

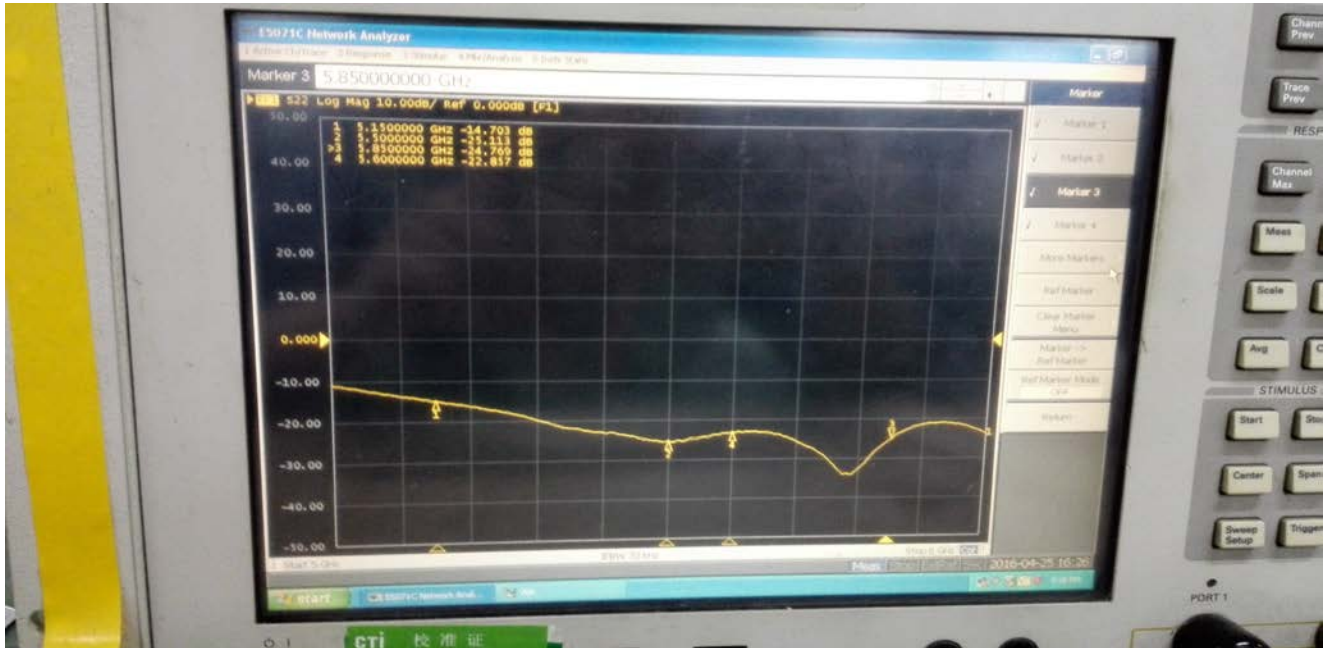

5G Isolation

