



# FCC Radio Test Report

## FCC ID: V7TW303RV3

This report concerns (check one):  Original Grant  Class II Change

**Issued Date** : Sep. 23, 2013  
**Project No.** : 1309C003  
**Equipment** : Wireless N300 Home Router  
**Model Name** : W303R  
**Applicant** : SHENZHEN TENDA TECHNOLOGY CO.,LTD.  
**Address** : Tenda Industrial Park, No. 34-1, Shilong Rd.,  
Shiyan Town, Bao'an District, Shenzhen,  
P.R.China 518108

**Tested by:** Neutron Engineering Inc. EMC Laboratory

**Date of Receipt:** Aug. 31, 2013

**Date of Test:** Aug. 31, 2013~ Sep. 20, 2013

**Testing Engineer** : David Mao  
( David Mao)

**Technical Manager** : Leo Hung  
(Leo Hung)

**Authorized Signatory** : Steven Lu  
(Steven Lu)

### **Neutron Engineering Inc.**

No.3,Jinshagang 1st Road, ShiXia,

Dalang Town, Dong Guan, China.

TEL: 0769-8318-3000

FAX: 0769-8319-6000



### **Declaration**

**Neutron** represents to the client that testing is done in accordance with standard procedures as applicable and that test instruments used has been calibrated with the standards traceable to National Measurement Laboratory (**NML**) of **R.O.C.**, or National Institute of Standards and Technology (**NIST**) of **U.S.A.**

**Neutron's** reports apply only to the specific samples tested under conditions. It is manufacture's responsibility to ensure that additional production units of this model are manufactured with the identical electrical and mechanical components. **Neutron** shall have no liability for any declarations, inferences or generalizations drawn by the client or others from **Neutron** issued reports.

**Neutron's** reports must not be used by the client to claim product endorsement by the authorities or any agency of the Government.

This report is the confidential property of the client. As a mutual protection to the clients, the public and **Neutron-self**, extracts from the test report shall not be reproduced except in full with **Neutron's** authorized written approval.

**Neutron's** laboratory quality assurance procedures are in compliance with the **ISO Guide 17025** requirements, and accredited by the conformity assessment authorities listed in this test report.

### **Limitation**

For the use of the authority's logo is limited unless the Test Standard(s)/Scope(s)/Item(s) mentioned in this test report is (are) included in the conformity assessment authorities acceptance respective.



<b>Table of Contents</b>	<b>Page</b>
<b>REPORT ISSUED HISTORY</b>	<b>5</b>
<b>1 . CERTIFICATION</b>	<b>6</b>
<b>2 . SUMMARY OF TEST RESULTS</b>	<b>7</b>
2.1 TEST FACILITY	8
2.2 MEASUREMENT UNCERTAINTY	8
<b>3 . GENERAL INFORMATION</b>	<b>9</b>
3.1 GENERAL DESCRIPTION OF EUT	9
3.2 DESCRIPTION OF TEST MODES	11
3.3 TABLE OF PARAMETERS OF TEXT SOFTWARE SETTING	12
3.4 BLOCK DIAGRAM SHOWING THE CONFIGURATION OF SYSTEM TESTED	13
3.5 DESCRIPTION OF SUPPORT UNITS	14
<b>4 . EMC EMISSION TEST</b>	<b>15</b>
4.1 CONDUCTED EMISSION MEASUREMENT	15
4.1.1 POWER LINE CONDUCTED EMISSION LIMITS	15
4.1.2 MEASUREMENT INSTRUMENTS LIST AND SETTING	15
4.1.3 TEST PROCEDURE	16
4.1.4 DEVIATION FROM TEST STANDARD	16
4.1.5 TEST SETUP	16
4.1.6 EUT OPERATING CONDITIONS	16
4.1.7 TEST RESULTS	17
4.2 RADIATED EMISSION MEASUREMENT	20
4.2.1 RADIATED EMISSION LIMITS	20
4.2.2 MEASUREMENT INSTRUMENTS LIST AND SETTING	21
4.2.3 TEST PROCEDURE	22
4.2.4 DEVIATION FROM TEST STANDARD	22
4.2.5 TEST SETUP	23
4.2.6 EUT OPERATING CONDITIONS	24
4.2.7 TEST RESULTS (BETWEEN 30 – 1000 MHZ)	25
4.2.8 TEST RESULTS (ABOVE 1000 MHZ)	32
<b>5 . BANDWIDTH TEST</b>	<b>80</b>
5.1 APPLIED PROCEDURES / LIMIT	80
5.1.1 MEASUREMENT INSTRUMENTS LIST	80
5.1.2 TEST PROCEDURE	80
5.1.3 DEVIATION FROM STANDARD	80
5.1.4 TEST SETUP	80
5.1.5 EUT OPERATION CONDITIONS	80
5.1.6 TEST RESULTS	81



<b>Table of Contents</b>	<b>Page</b>
<b>6 . MAXIMUM OUTPUT POWER TEST</b>	<b>93</b>
<b>6.1 APPLIED PROCEDURES / LIMIT</b>	<b>93</b>
6.1.1 MEASUREMENT INSTRUMENTS LIST	93
6.1.2 TEST PROCEDURE	93
6.1.3 DEVIATION FROM STANDARD	93
6.1.4 TEST SETUP	93
6.1.5 EUT OPERATION CONDITIONS	93
6.1.6 TEST RESULTS	94
<b>7 . ANTENNA CONDUCTED SPURIOUS EMISSION</b>	<b>97</b>
<b>7.1 APPLIED PROCEDURES / LIMIT</b>	<b>97</b>
7.1.1 MEASUREMENT INSTRUMENTS LIST	97
7.1.2 TEST PROCEDURE	97
7.1.3 DEVIATION FROM STANDARD	97
7.1.4 TEST SETUP	97
7.1.5 EUT OPERATION CONDITIONS	97
7.1.6 TEST RESULTS	98
<b>8 . POWER SPECTRAL DENSITY TEST</b>	<b>128</b>
<b>8.1 APPLIED PROCEDURES / LIMIT</b>	<b>128</b>
8.1.1 MEASUREMENT INSTRUMENTS LIST	128
8.1.2 TEST PROCEDURE	128
8.1.3 DEVIATION FROM STANDARD	128
8.1.4 TEST SETUP	128
8.1.5 EUT OPERATION CONDITIONS	128
8.1.6 TEST RESULTS	129
<b>9 . EUT TEST PHOTO</b>	<b>143</b>



REPORT ISSUED HISTORY

Issued No.	Description	Issued Date
NEI-FCCP-1-1309C003	Original Issue.	Sep. 23, 2013
-	-	-



## 1. CERTIFICATION

Equipment : Wireless N300 Home Router  
Brand Name : Tenda  
Model Name : W303R  
Applicant : SHENZHEN TENDA TECHNOLOGY CO.,LTD.  
Manufacturer : SHENZHEN TENDA TECHNOLOGY CO.,LTD.  
Address : Tenda Industrial Park, No. 34-1, Shilong Rd., Shiyan Town, Bao'an District,  
Shenzhen, P.R.China 518108  
Date of Test : Aug. 31, 2013~ Sep. 20, 2013  
Test Item : ENGINEERING SAMPLE  
Standard(s) : FCC Part15(2012), Subpart C(15.247) / ANSI C63.4-2009

The above equipment has been tested and found compliance with the requirement of the relative standards by Neutron Engineering Inc. EMC Laboratory.

The test data, data evaluation, and equipment configuration contained in our test report (Ref No. NEI-FCCP-1-1309C003) were obtained utilizing the test procedures, test instruments, test sites that has been accredited by the Authority of TAF according to the ISO-17025 quality assessment standard and technical standard(s).



## 2. SUMMARY OF TEST RESULTS

Test procedures according to the technical standard(s):

<b>FCC Part15 (15.247) , Subpart C</b>				
Standard(s)	Section	Test Item	Judgment	Remark
	15.207	Conducted Emission	PASS	
	15.247(d)	Antenna conducted Spurious Emission	PASS	
	15.247(a)(2)	6dB Bandwidth	PASS	
	15.247(b)(3)	Peak Output Power	PASS	
	15.247(e)	Power Spectral Density	PASS	
	15.203	Antenna Requirement	PASS	
	15.209/15.205	Transmitter Radiated Emissions	PASS	

**NOTE:**

- (1) "N/A" denotes test is not applicable in this test report.
- (2) The test follows FCC KDB Publication No. 558074 D01 DTS Meas Guidance v03r01 (Measurement Guidelines of DTS)



**2.1 TEST FACILITY**

The test facilities used to collect the test data in this report is **DG-C02/DG-CB03** at the location of No.3,Jinshagang 1st Road, ShiXia, Dalang Town, Dong Guan, China.523792  
 Neutron's test firm number is 319330

**2.2 MEASUREMENT UNCERTAINTY**

Where relevant, the following measurement uncertainty levels have been estimated for tests performed on the EUT as specified in CISPR 16-4-2:

The reported uncertainty of measurement  $y \pm U$ , where expanded uncertainty U is based on a standard uncertainty multiplied by a coverage factor of  $k=2$ , providing a level of confidence of approximately 95 %.

**A. Conducted Measurement :**

Test Site	Method	Measurement Frequency Range	U , (dB)	NOTE
DG-C02	CISPR	150 KHz ~ 30MHz	1.94	

**B. Radiated Measurement :**

Test Site	Method	Measurement Frequency Range	Ant. H / V	U , (dB)	NOTE
DG-CB03	CISPR	9KHz~30MHz	V	3.79	
		9KHz~30MHz	H	3.57	
		30MHz ~ 200MHz	V	3.82	
		30MHz ~ 200MHz	H	3.60	
		200MHz ~ 1,000MHz	V	3.86	
		200MHz ~ 1,000MHz	H	3.94	
		1GHz~18GHz	V	3.12	
		1GHz~18GHz	H	3.68	
		18GHz~40GHz	V	4.15	
		18GHz~40GHz	H	4.14	





**3. GENERAL INFORMATION**

**3.1 GENERAL DESCRIPTION OF EUT**

Equipment	Wireless N300 Home Router	
Brand Name	Tenda	
Model Name	W303R	
Model Difference	N/A	
Product Description	Operation Frequency	2412~2462 MHz
	Modulation Technology	802.11b:DSSS
		802.11g:OFDM
		802.11n:OFDM
	Bit Rate of Transmitter	802.11b: 11/5.5/2/1 Mbps
		802.11g: 54/48/36/24/18/12/9/6 Mbps
		802.11n up to 300 Mbps
	Number Of Channel	11 CH, Please see note 2.(Page 10)
Antenna Designation	Please see note 3.(Page 10)	
Antenna Gain(Peak)		
Output Power (Max.)	802.11b: 18.53 dBm	
	802.11g: 21.01 dBm	
	802.11n(20MHz):24.05 dBm	
	802.11n(40MHz):23.55 dBm	
More details of EUT technical specification, please refer to the User's Manual.		
Power Source	DC voltage supplied from AC/DC adapter Brand / Model: HEWEISHUN/TEA09U-09060	
Power Rating	I/P AC 100-240V~50/60Hz 0.3A O/P DC 9V 0.6A	
Connecting I/O Port(s)	Please refer to the User's Manual	

**Note:**

1. For a more detailed features description, please refer to the manufacturer's specifications or the User's Manual.



2. CH 01 – CH 11 for 802.11b, 802.11g, 802.11n(20MHz)  
 CH 03 – CH 09 for 802.11n(40MHz)

**Channel List**

Channel	Frequency (MHz)	Channel	Frequency (MHz)	Channel	Frequency (MHz)	Channel	Frequency (MHz)
01	2412	04	2427	07	2442	10	2457
02	2417	05	2432	08	2447	11	2462
03	2422	06	2437	09	2452		

3. Table for Filed Antenna

Ant.	Brand	S/N	Antenna Type	Connector	Gain (dBi)	Note
0	Tenda	321A0000001	Dipole	N/A	5.24	TX/RX
1	Tenda	321A0000001	Dipole	N/A	5.24	TX/RX
2	Tenda	321A0000001	Dipole	N/A	5.24	RX

Note: The EUT incorporates a MIMO function. Physically, the EUT provides two completed transmitters and three receivers (2T3R).all transmit signals are completely uncorrelated, then, Direction gain =  $G_{ANT}$ , that is Directional gain=5.24.

- 4.

Operating Mode TX Mode	1TX	2TX
802.11b	V (ANT 0 or ANT 1)	-
802.11g	V (ANT 0 or ANT 1)	-
802.11n(20MHz)	-	V (ANT 0 & ANT 1)
802.11n(40MHz)	-	V (ANT 0 & ANT 1)



**3.2 DESCRIPTION OF TEST MODES**

To investigate the maximum EMI emission characteristics generates from EUT, the test system was pre-scanning tested base on the consideration of following EUT operation mode or test configuration mode which possible have effect on EMI emission level. Each of these EUT operation mode(s) or test configuration mode(s) mentioned above was evaluated respectively.

Pretest Mode	Description
Mode 1	TX B MODE CHANNEL 01/06/11
Mode 2	TX G MODE CHANNEL 01/06/11
Mode 3	TX N-20MHZ MODE CHANNEL 01/06/11
Mode 4	TX N-40MHZ MODE CHANNEL 03/06/09
Mode 5	TX Mode

The EUT system operated these modes were found to be the worst case during the pre-scanning test as following:

<b>For Conducted Test</b>	
Final Test Mode	Description
Mode 5	TX Mode

<b>For Radiated Test</b>	
Final Test Mode	Description
Mode 1	TX B MODE CHANNEL 01/06/11
Mode 2	TX G MODE CHANNEL 01/06/11
Mode 3	TX N-20MHZ MODE CHANNEL 01/06/11
Mode 4	TX N-40MHZ MODE CHANNEL 03/06/09

Note:

- (1) The measurements are performed at the high, middle, low available channels.
- (2) 802.11b mode: DBPSK (1Mbps)  
 802.11g mode: OFDM (6Mbps)  
 802.11n HT20 mode : BPSK (13Mbps)  
 802.11n HT40 mode : BPSK (27Mbps)  
 For radiated emission tests, the highest output powers were set for final test.
- (3) The EUT was pre-tested on positioned of each 3 axis. The worst case was found positioned on X-plane. Therefore only the test data of this X-plane was used for radiated emission measurement test.



**3.3 TABLE OF PARAMETERS OF TEXT SOFTWARE SETTING**

During testing channel & power controlling software provided by the customer was used to control the operating channel as well as the output power level. The RF output power selection is for the setting of RF output power expected by the customer and is going to be fixed on the firmware of the final end product power parameters of WLAN

Test software version	Mtool		
Frequency	2412 MHz	2437 MHz	2462 MHz
IEEE 802.11b DSSS	73	72	72
IEEE 802.11g OFDM	65	66	66

Test software version	Mtool		
Frequency (MHz)	2412 MHz	2437 MHz	2462 MHz
IEEE 802.11n (20MHz)	65	64	64
Frequency (MHz)	2422 MHz	2437 MHz	2452 MHz
IEEE 802.11n (40MHz)	59	58	58



**3.4 BLOCK DIAGRAM SHOWING THE CONFIGURATION OF SYSTEM TESTED**

**Conducted Mode:**

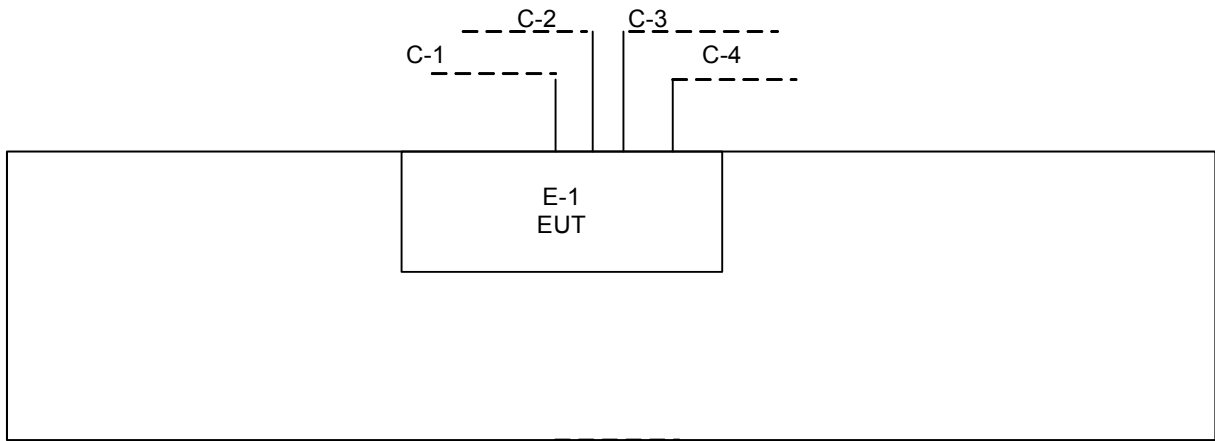

**Control Room**

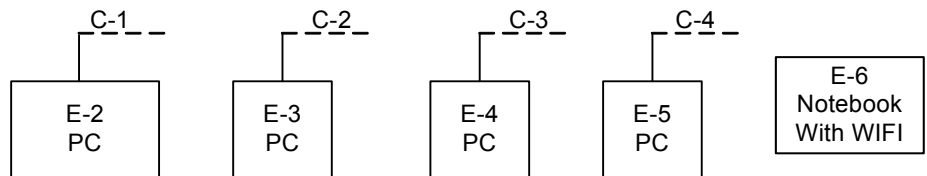

C-1: RJ45 Cable  
 C-2: RJ45 Cable  
 C-3: RJ45 Cable  
 C-4: RJ45 Cable

**Radiated TX Mode:**

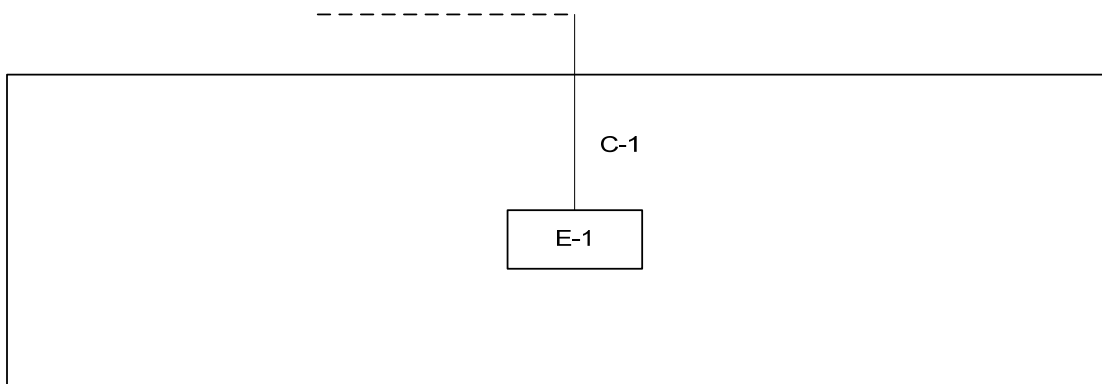

**Control Room**

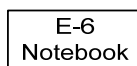

C-1: RJ45 Cable



**3.5 DESCRIPTION OF SUPPORT UNITS**

The EUT has been tested as an independent unit together with other necessary accessories or support units. The following support units or accessories were used to form a representative test configuration during the tests.

Item	Equipment	Mfr/Brand	Model/Type No.	FCC ID	Series No.	Note
E-1	Wireless N300 Home Router	Tenda	W303R	V7TW303RV 3	N/A	EUT
E-2	PC	HP	Dx7200MT	DOC	CNG60601DV	
E-3	PC	HP	Dx7208	DOC	CNG7050PF6	
E-4	PC	HP	Dx7208	DOC	CNG7050PB7	
E-5	PC	HP	Dx7400	DOC	CNG7430PWL	
E-6	Notebook	Dell	INSPIRON 1420	DOC	JX193A01SDC2	

Item	Shielded Type	Ferrite Core	Length	Note
C-1	NO	NO	10m	
C-2	NO	NO	10m	
C-3	NO	NO	10m	
C-4	NO	NO	10m	

Note:

- (1) The support equipment was authorized by Declaration of Confirmation.
- (2) For detachable type I/O cable should be specified the length in m in 『Length』 column.



**4. EMC EMISSION TEST**

**4.1 CONDUCTED EMISSION MEASUREMENT**

**4.1.1 POWER LINE CONDUCTED EMISSION Limits (Frequency Range 150KHz-30MHz)**

FREQUENCY (MHz)	Class A (dBuV)		Class B (dBuV)		Standard
	Quasi-peak	Average	Quasi-peak	Average	
0.15 -0.5	79.00	66.00	66 - 56 *	56 - 46 *	CISPR
0.50 -5.0	73.00	60.00	56.00	46.00	CISPR
5.0 -30.0	73.00	60.00	60.00	50.00	CISPR

0.15 -0.5	79.00	66.00	66 - 56 *	56 - 46 *	FCC
0.50 -5.0	73.00	60.00	56.00	46.00	FCC
5.0 -30.0	73.00	60.00	60.00	50.00	FCC

Note:

- (1) The tighter limit applies at the band edges.
- (2) The limit of " \* " marked band means the limitation decreases linearly with the logarithm of the frequency in the range.

**4.1.2 MEASUREMENT INSTRUMENTS LIST AND SETTING**

Item	Kind of Equipment	Manufacturer	Type No.	Serial No.	Last Calibration	Next Calibration
1	LISN	EMCO	3816/2	00052765	May.04.2013	Apr. 25, 2014
2	LISN	R&S	ENV216	100087	Nov.17.2012	Nov.16, 2013
3	Test Cable	N/A	C_17	N/A	Mar.28.2013	Mar.15.2014
4	EMI TEST RECEIVER	R&S	ESCS30	826547/02 2	May.04.2013	Apr. 25, 2014
5	50Ω Terminator	SHX	TF2-3G-A	08122902	May.04.2013	Apr. 25, 2014

Remark: "N/A" denotes no model name, serial no. or calibration specified.  
All calibration period of equipment list is one year.

The following table is the setting of the receiver

Receiver Parameters	Setting
Attenuation	10 dB
Start Frequency	0.15 MHz
Stop Frequency	30 MHz
IF Bandwidth	9 kHz

#### 4.1.3 TEST PROCEDURE

- The EUT was placed 0.8 meters from the horizontal ground plane with EUT being connected to the power mains through a line impedance stabilization network (LISN). All other support equipments powered from additional LISN(s). The LISN provide 50 Ohm/ 50uH of coupling impedance for the measuring instrument.
- Interconnecting cables that hang closer than 40 cm to the ground plane shall be folded back and forth in the center forming a bundle 30 to 40 cm long.
- I/O cables that are not connected to a peripheral shall be bundled in the center. The end of the cable may be terminated, if required, using the correct terminating impedance. The overall length shall not exceed 1 m.
- LISN at least 80 cm from nearest part of EUT chassis.
- For the actual test configuration, please refer to the related Item –EUT Test Photos.

#### 4.1.4 DEVIATION FROM TEST STANDARD

No deviation

#### 4.1.5 TEST SETUP

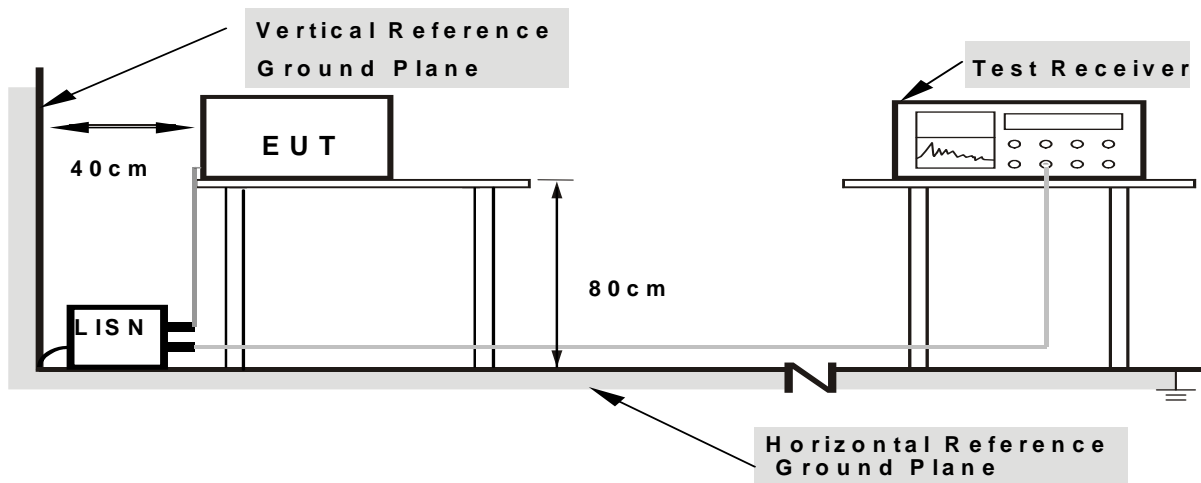

**Note: 1.Support units were connected to second LISN.**

**2.Both of LISNs (AMN) are 80 cm from EUT and at least 80 cm from other units and other metal planes**

#### 4.1.6 EUT OPERATING CONDITIONS

The EUT was configured for testing in a typical fashion (as a customer would normally use it). The EUT has been programmed to continuously transmit during test. This operating condition was tested and used to collect the included data.





#### 4.1.7 TEST RESULTS

Remark

- (1) All readings are QP Mode value unless otherwise stated AVG in column of "Note". If the QP Mode Measured value compliance with the QP Limits and lower than AVG Limits, the EUT shall be deemed to meet both QP & AVG Limits and then only QP Mode was measured, but AVG Mode didn't perform. In this case, a "\*" marked in AVG Mode column of Interference Voltage Measured.
- (2) Measuring frequency range from 150KHz to 30MHz.



EUT:	Wireless N300 Home Router	Model Name:	W303R
Temperature:	24 °C	Relative Humidity:	55 %
Test Power:	AC 120V/60Hz	Phase:	Line
Test Mode :	TX Mode		

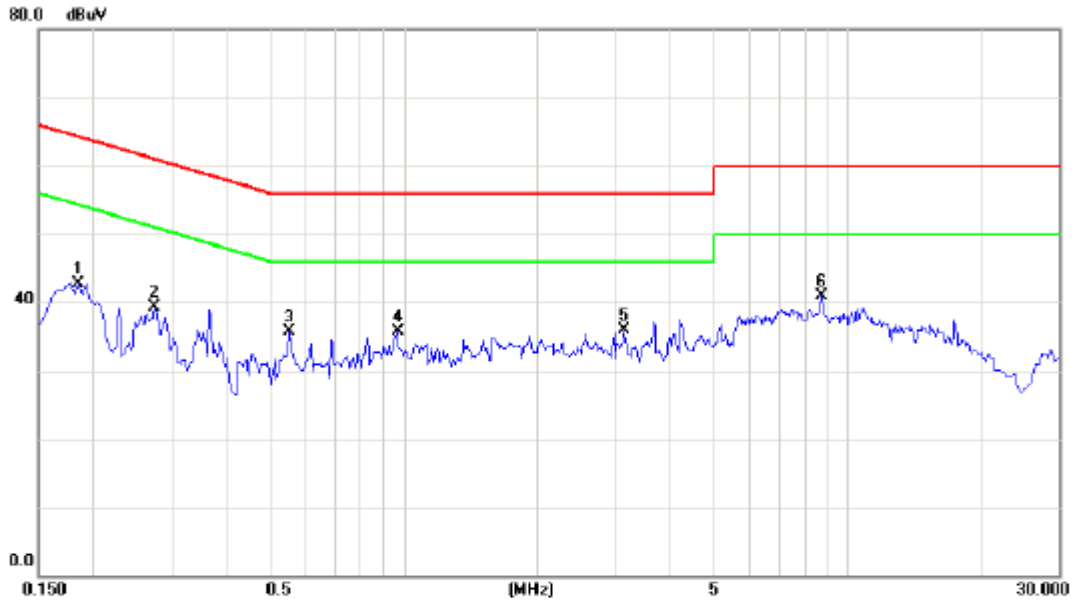

No. Mk.	Freq. MHz	Reading Level dBuV	Correct Factor dB	Measurement dBuV	Limit dBuV	Over dB	Detector	Comment
1	0.1850	33.01	9.65	42.66	64.26	-21.60	peak	
2	0.2750	29.59	9.67	39.26	60.97	-21.71	peak	
3	0.5523	26.06	9.70	35.76	56.00	-20.24	peak	
4	0.9683	25.89	9.74	35.63	56.00	-20.37	peak	
5	3.1523	25.98	9.88	35.86	56.00	-20.14	peak	
6 *	8.7421	30.90	10.03	40.93	60.00	-19.07	peak	



EUT:	Wireless N300 Home Router	Model Name:	W303R
Temperature:	24 °C	Relative Humidity:	55 %
Test Power:	AC 120V/60Hz	Phase:	Neutral
Test Mode :	TX Mode		

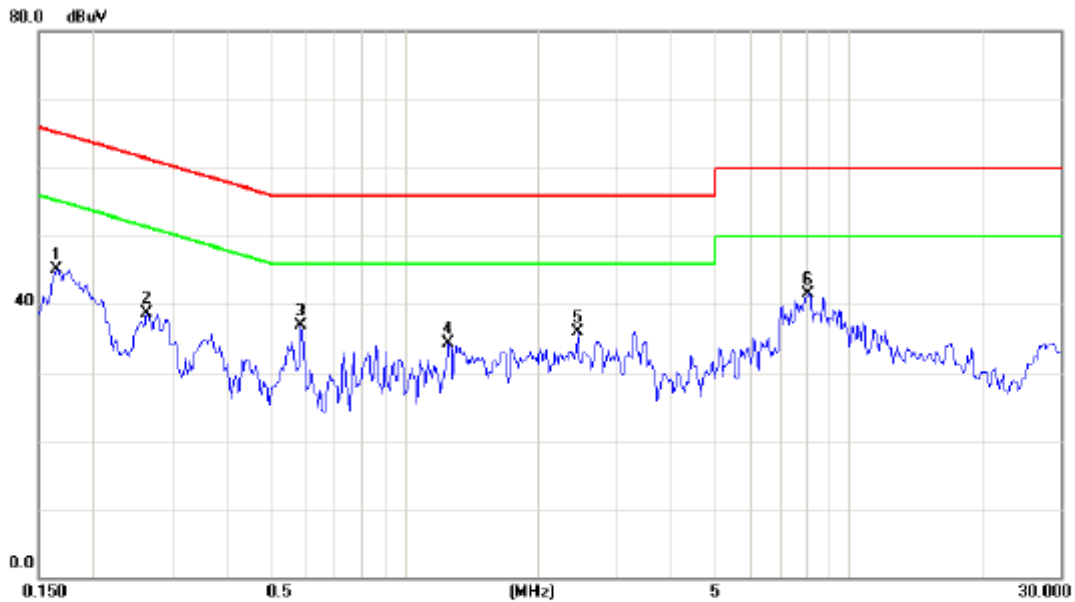

No. Mk.	Freq. MHz	Reading Level dBuV	Correct Factor dB	Measurement dBuV	Limit dBuV	Over dB	Detector	Comment
1	0.1655	35.33	9.70	45.03	65.18	-20.15	peak	
2	0.2631	28.95	9.72	38.67	61.33	-22.66	peak	
3	0.5875	27.07	9.74	36.81	56.00	-19.19	peak	
4	1.2593	24.43	9.79	34.22	56.00	-21.78	peak	
5	2.4546	26.02	9.88	35.90	56.00	-20.10	peak	
6 *	8.1051	31.48	10.08	41.56	60.00	-18.44	peak	



**4.2 RADIATED EMISSION MEASUREMENT**

**4.2.1 RADIATED EMISSION LIMITS (Frequency Range 9KHz-1000MHz)**

20dBc in any 100 kHz bandwidth outside the operating frequency band. In case the emission fall within the restricted band specified on 15.205(a), then the 15.209(a) limit in the table below has to be followed.

Frequencies (MHz)	Field Strength (micorvolts/meter)	Measurement Distance (meters)
0.009~0.490	2400/F(KHz)	300
0.490~1.705	24000/F(KHz)	30
1.705~30.0	30	30
30~88	100	3
88~216	150	3
216~960	200	3
960~1000	500	3

**LIMITS OF RADIATED EMISSION MEASUREMENT (Above 1000MHz)**

FREQUENCY (MHz)	(dBuV/m) (at 3m)	
	PEAK	AVERAGE
Above 1000	74	54

**Notes:**

- (1) The limit for radiated test was performed according to FCC PART 15C.
- (2) The tighter limit applies at the band edges.
- (3) Emission level (dBuV/m)=20log Emission level (uV/m).

**FREQUENCY RANGE OF RADIATED MEASUREMENT (For unintentional radiators)**

Highest frequency generated or Upper frequency of measurement used in the device or on which the device operates or tunes (MHz)	Range (MHz)
Below 1.705	30
1.705 – 108	1000
108 – 500	2000
500 – 1000	5000
Above 1000	5 <sup>th</sup> harmonic of the highest frequency or 40 GHz, whichever is lower



**4.2.2 MEASUREMENT INSTRUMENTS LIST AND SETTING**

Item	Kind of Equipment	Manufacturer	Type No.	Serial No.	Last Calibration	Next Calibration
1	Antenna	Schwarzbeck	VULB9160	9160-3232	May.25.2013	Apr. 25, 2014
2	Amplifier	HP	8447D	2944A09673	May.04.2013	Apr. 25, 2014
3	Test Receiver	R&S	ESCI	100382	May.04.2013	Apr. 25, 2014
4	Test Cable	N/A	C-01_CB03	N/A	Jul.01.2013	Jul. 02, 2014
5	Antenna	ETS	3115	00075789	May.25.2013	Apr. 25, 2014
6	Amplifier	Agilent	8449B	3008A02274	May.04.2013	Apr. 25, 2014
7	Spectrum	Agilent	E4408B	US39240143	Nov.24.2012	Nov.16, 2013
8	Test Cable	HUBER+SUHNER	C-45	N/A	May.02.2013	Apr. 30, 2014
9	Controller	CT	SC100	N/A	N/A	N/A
10	Horn Antenna	EMCO	3115	9605-4803	May.25.2013	Apr. 25, 2014
11	Active Loop Antenna	R&S	HFH2-Z2	830749/020	May.04.2013	Apr. 25, 2014
12	Broad-Band Horn Antenna	Schwarzbeck	BBHA 9170	9170319	Oct.13.2012	Oct.12.2013

Remark: "N/A" denotes no model name, serial no. or calibration specified.  
All calibration period of equipment list is one year.

Spectrum Parameter	Setting
Attenuation	Auto
Start Frequency	1000 MHz
Stop Frequency	10th carrier harmonic
RB / VB (Emission in restricted band)	1MHz / 1MHz for Peak, 1 MHz / 10Hz for Average

Receiver Parameter	Setting
Attenuation	Auto
Start ~ Stop Frequency	9kHz~90kHz for PK/AVG detector
Start ~ Stop Frequency	90kHz~110kHz for QP detector
Start ~ Stop Frequency	110kHz~490kHz for PK/AVG detector
Start ~ Stop Frequency	490kHz~30MHz for QP detector
Start ~ Stop Frequency	30MHz~1000MHz for QP detector



**4.2.3 TEST PROCEDURE**

- a. The EUT was placed on the top of a rotating table 0.8 meters above the ground at a 3 meter semi-anechoic chamber. The table was rotated 360 degrees to determine the position of the highest radiation.(below 1GHz)
- b. The EUT was placed on the top of a rotating table 0.8 meters above the ground at a 3 meter fully-anechoic chamber. The table was rotated 360 degrees to determine the position of the highest radiation.(above 1GHz)
- c. The height of the equipment or of the substitution antenna shall be 0.8 m; the height of the test antenna shall vary between 1 m to 4 m. Both horizontal and vertical polarizations of the antenna are set to make the measurement.
- d. The initial step in collecting conducted emission data is a spectrum analyzer peak detector mode pre-scanning the measurement frequency range. Significant peaks are then marked and then Quasi Peak detector mode re-measured.
- e. If the Peak Mode measured value compliance with and lower than Quasi Peak Mode Limit, the EUT shall be deemed to meet QP Limits and then no additional QP Mode measurement performed.
- f. For the actual test configuration, please refer to the related Item –EUT Test Photos.

**4.2.4 DEVIATION FROM TEST STANDARD**

No deviation

**4.2.5 TEST SETUP**

(A) Radiated Emission Test Set-Up Frequency Below 1 GHz

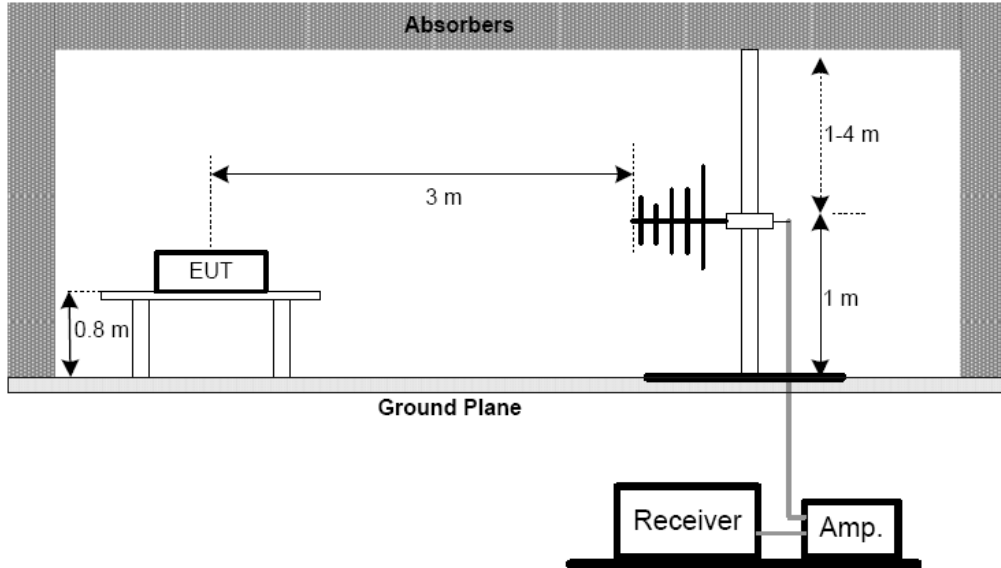

(B) Radiated Emission Test Set-Up Frequency Above 1 GHz

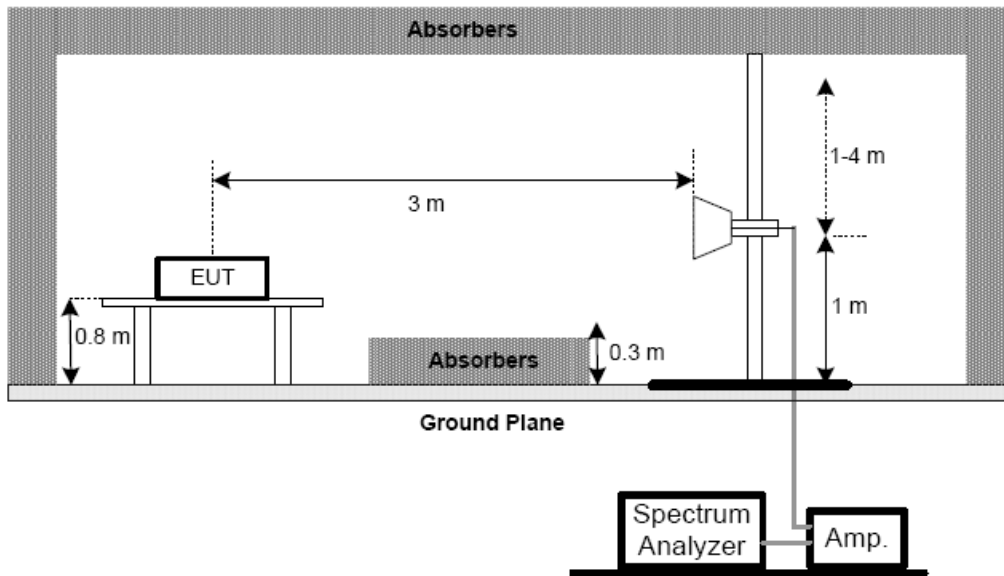

(C) For radiated emissions below 30MHz

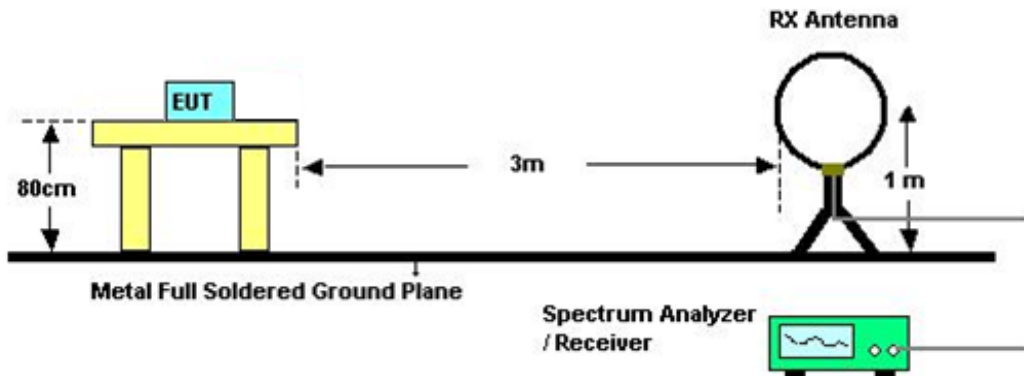

#### 4.2.6 EUT OPERATING CONDITIONS

The EUT tested system was configured as the statements of 4.1.6 Unless otherwise a special operating condition is specified in the follows during the testing.





#### **4.2.7 TEST RESULTS (BETWEEN 30 – 1000 MHZ)**

Remark :

- (1) Reading in which marked as QP or Peak means measurements by using are Quasi-Peak Mode or Peak Mode with Detector BW=120KHz ; SPA setting in RBW=120KHz, VBW =120KHz, Swp. Time = 0.3 sec./MHz ◦
- (2) All readings are Peak unless otherwise stated QP in column of 『Note』 . Peak denotes that the Peak reading compliance with the QP Limits and then QP Mode measurement didn't perform ◦
- (3) Measuring frequency range from 30MHz to 1000MHz ◦
- (4) If the peak scan value lower limit more than 20dB, then this signal data does not show in table ◦



EUT:	Wireless N300 Home Router	Model Name:	W303R
Temperature:	24 °C	Relative Humidity:	54 %
Test Voltage:	AC 120V/60Hz	Polarization:	Vertical
Test Mode:	TX B MODE CHANNEL 01		

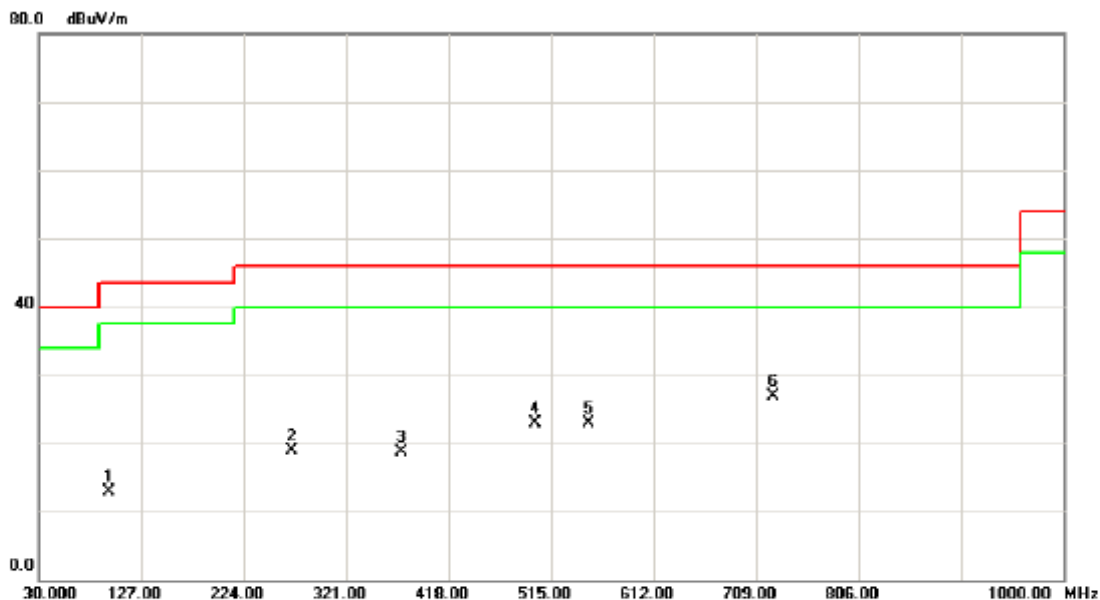

No.	Mk.	Freq. MHz	Reading Level dBuV	Correct Factor dB	Measure- ment dBuV/m	Limit dBuV/m	Over dB	Detector	Comment
1		95.9600	31.58	-18.70	12.88	43.50	-30.62	peak	
2		269.5900	32.79	-13.84	18.95	46.00	-27.05	peak	
3		373.3800	29.37	-10.72	18.65	46.00	-27.35	peak	
4		500.4500	31.37	-8.37	23.00	46.00	-23.00	peak	
5		549.9200	29.57	-6.59	22.98	46.00	-23.02	peak	
6	*	725.4900	31.33	-4.45	26.88	46.00	-19.12	peak	



# Neutron Engineering Inc.

EUT:	Wireless N300 Home Router	Model Name:	W303R
Temperature:	24 °C	Relative Humidity:	54 %
Test Voltage:	AC 120V/60Hz	Polarization:	Horizontal
Test Mode:	TX B MODE CHANNEL 01		

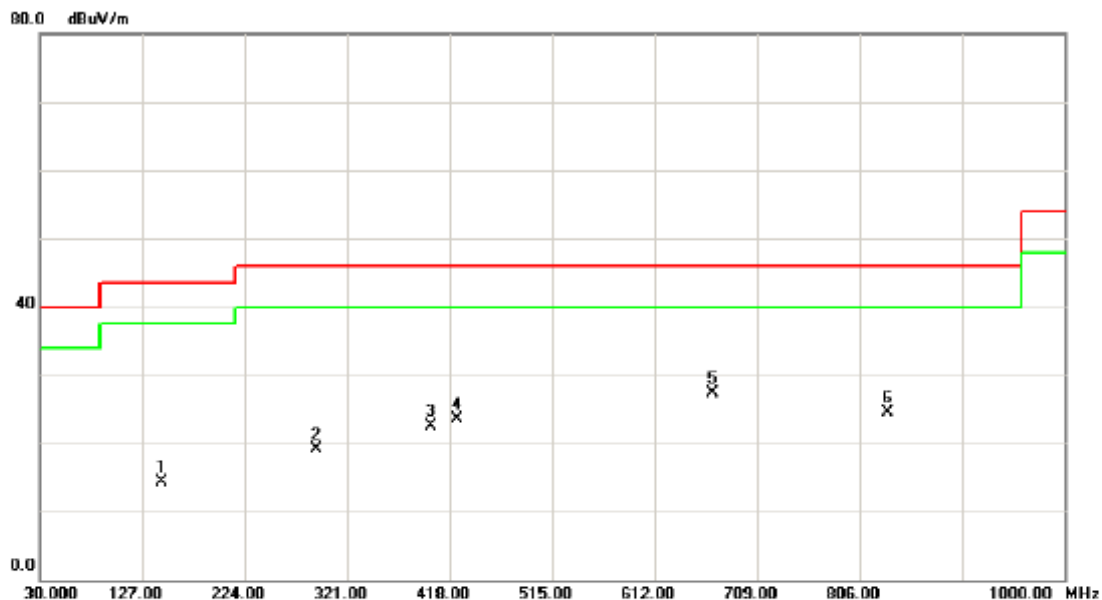

No.	Mk.	Freq. MHz	Reading Level dBuV	Correct Factor dB	Measure- ment dBuV/m	Limit dBuV/m	Over dB	Detector	Comment
1		145.4300	32.28	-17.92	14.36	43.50	-29.14	peak	
2		291.9000	31.76	-12.62	19.14	46.00	-26.86	peak	
3		400.5400	32.27	-9.80	22.47	46.00	-23.53	peak	
4		424.7900	32.93	-9.41	23.52	46.00	-22.48	peak	
5	*	666.3200	32.05	-4.67	27.38	46.00	-18.62	peak	
6		832.1900	27.46	-3.05	24.41	46.00	-21.59	peak	



EUT:	Wireless N300 Home Router	Model Name:	W303R
Temperature:	24 °C	Relative Humidity:	54 %
Test Voltage:	AC 120V/60Hz	Polarization:	Vertical
Test Mode:	TX B MODE CHANNEL 06		

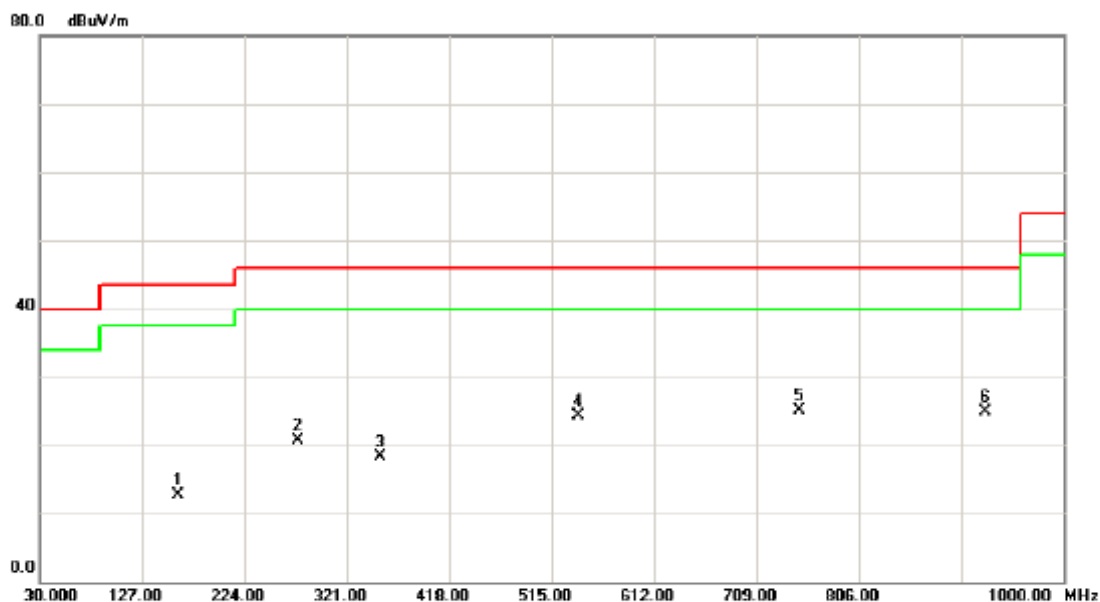

No. Mk.	Freq. MHz	Reading Level dBuV	Correct Factor dB	Measurement dBuV/m	Limit dBuV/m	Over dB	Detector	Comment
1	160.9500	30.61	-17.94	12.67	43.50	-30.83	peak	
2	274.4400	34.30	-13.52	20.78	46.00	-25.22	peak	
3	352.0400	29.84	-11.45	18.39	46.00	-27.61	peak	
4	540.2200	31.29	-6.95	24.34	46.00	-21.66	peak	
5 *	749.7400	29.44	-4.24	25.20	46.00	-20.80	peak	
6	925.3100	26.54	-1.61	24.93	46.00	-21.07	peak	



EUT:	Wireless N300 Home Router	Model Name:	W303R
Temperature:	24 °C	Relative Humidity:	54 %
Test Voltage:	AC 120V/60Hz	Polarization:	Horizontal
Test Mode:	TX B MODE CHANNEL 06		

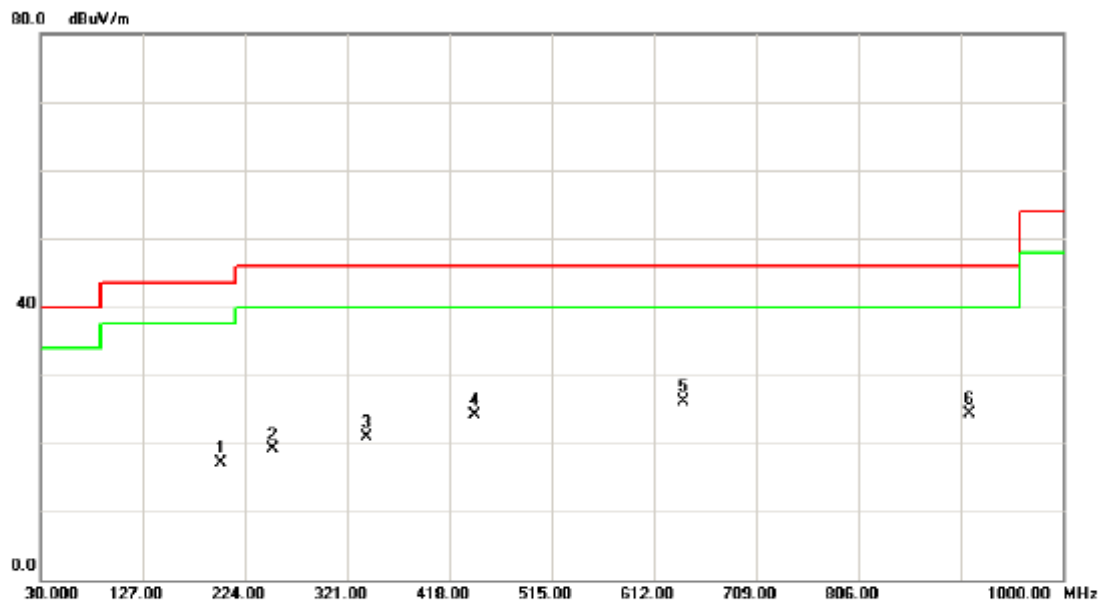

No.	Mk.	Freq. MHz	Reading Level dBuV	Correct Factor dB	Measure- ment dBuV/m	Limit dBuV/m	Over dB	Detector	Comment
1		201.6900	34.07	-16.90	17.17	43.50	-26.33	peak	
2		250.1900	34.20	-15.02	19.18	46.00	-26.82	peak	
3		339.4300	32.72	-11.75	20.97	46.00	-25.03	peak	
4		441.2800	33.23	-9.15	24.08	46.00	-21.92	peak	
5	*	640.1300	31.01	-4.83	26.18	46.00	-19.82	peak	
6		910.7600	26.18	-1.78	24.40	46.00	-21.60	peak	



EUT:	Wireless N300 Home Router	Model Name:	W303R
Temperature:	24 °C	Relative Humidity:	54 %
Test Voltage:	AC 120V/60Hz	Polarization:	Vertical
Test Mode:	TX B MODE CHANNEL 11		

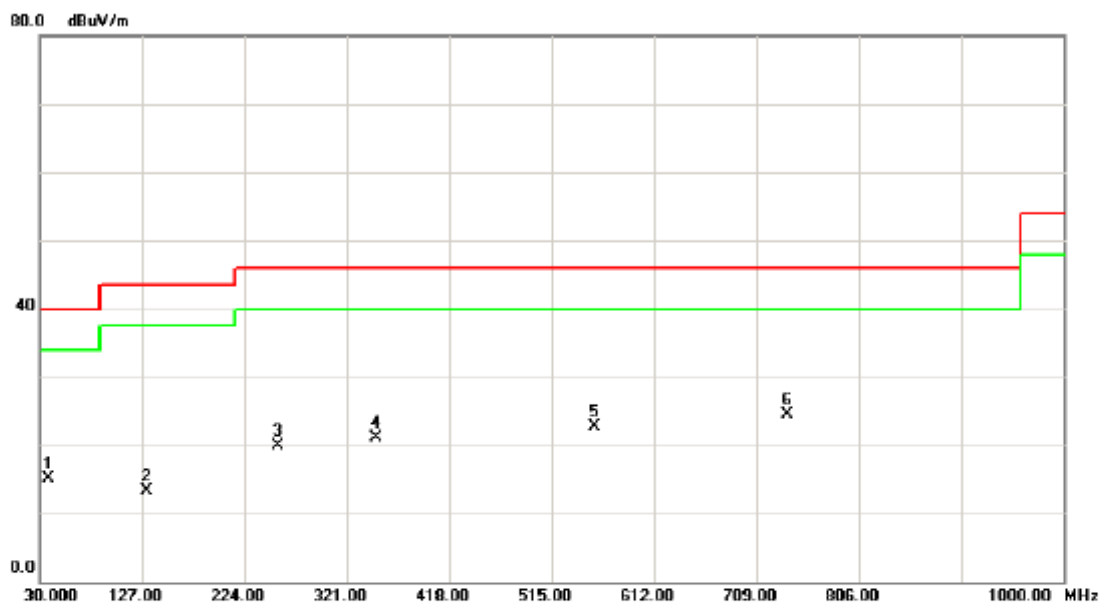

No.	Mk.	Freq. MHz	Reading Level dBuV	Correct Factor dB	Measure- ment dBuV/m	Limit dBuV/m	Over dB	Detector	Comment
1		38.7300	32.11	-17.01	15.10	40.00	-24.90	peak	
2		131.8500	31.59	-18.28	13.31	43.50	-30.19	peak	
3		256.0100	34.48	-14.65	19.83	46.00	-26.17	peak	
4		348.1600	32.65	-11.57	21.08	46.00	-24.92	peak	
5		555.7400	29.27	-6.47	22.80	46.00	-23.20	peak	
6	*	738.1000	28.85	-4.34	24.51	46.00	-21.49	peak	



EUT:	Wireless N300 Home Router	Model Name:	W303R
Temperature:	24 °C	Relative Humidity:	54 %
Test Voltage:	AC 120V/60Hz	Polarization:	Horizontal
Test Mode:	TX B MODE CHANNEL 11		

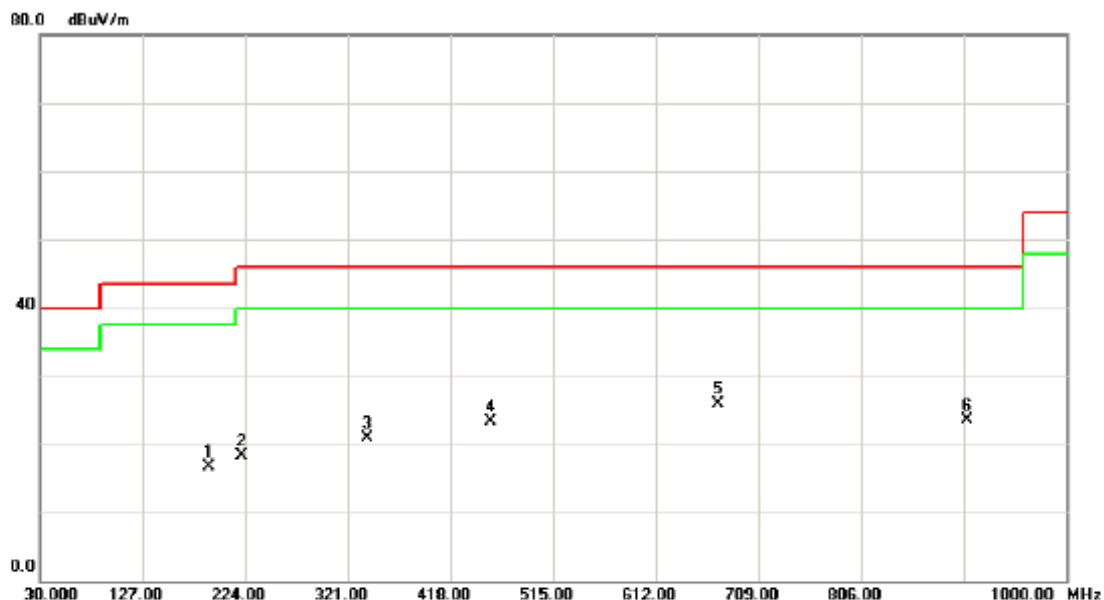

No.	Mk.	Freq. MHz	Reading Level dBuV	Correct Factor dB	Measure- ment dBuV/m	Limit dBuV/m	Over dB	Detector	Comment
1		189.0800	33.81	-17.11	16.70	43.50	-26.80	peak	
2		221.0900	34.60	-16.29	18.31	46.00	-27.69	peak	
3		339.4300	32.72	-11.75	20.97	46.00	-25.03	peak	
4		455.8300	32.17	-8.92	23.25	46.00	-22.75	peak	
5	*	670.2000	30.61	-4.68	25.93	46.00	-20.07	peak	
6		905.9100	25.28	-1.85	23.43	46.00	-22.57	peak	



**4.2.8 TEST RESULTS (ABOVE 1000 MHZ)**

EUT :	Wireless N300 Home Router	Model Name :	W303R
Temperature :	24 °C	Relative Humidity :	51 %
Pressure :	1010 hPa	Test Voltage :	AC 120V/60Hz
Test Mode :	TX B MODE 2412MHz		

Freq. (MHz)	Ant.Pol. H/V	Reading		Ant./CF CF(dB)	Act.		Limit		Note
		Peak (dBuV)	AV (dBuV)		Peak (dBuV/m)	AV (dBuV/m)	Peak (dBuV/m)	AV (dBuV/m)	
2390.00	V	22.62	11.92	32.28	54.90	44.20	74.00	54.00	X/E
<b>2413.00</b>	<b>V</b>	<b>70.23</b>	<b>66.82</b>	<b>32.25</b>	<b>102.48</b>	<b>99.07</b>			<b>X/F</b>
4823.98	V	49.71	34.35	5.29	55.00	39.64	74.00	54.00	X/H

Remark :

- (1) All readings are Peak unless otherwise stated QP in column of 『Note』 . Peak denotes that the Peak reading compliance with the QP Limits and then QP Mode measurement didn't perform ◦
- (2) Measuring frequency range from 30MHz to 1000MHz or the 10th harmonic of highest fundamental frequency ◦ "F" denotes fundamental frequency; "H" denotes spurious frequency. "E" denotes band edge frequency. (This judgment method includes the Band Edge Requirement.)
- (3) Radiated emissions measured in frequency range above 1000MHz were made with an instrument using Peak detector mode and AV detector mode of the emission ◦
- (4) Data of measurement within this frequency range shown " \* " in the table above means the reading of emissions are attenuated more than 20dB below the permissible limits or the field strength is too small to be measured.
- (5) A preamp and high pass filter were used for this test in order to provide sufficient measurement sensitivity.
- (6) EUT Orthogonal Axis :  
"X" - denotes Laid on Table ; "Y" - denotes Vertical Stand ; "Z" - denotes Side Stand
- (7) During the measurements above 1 GHz it is taken care of that the EUT is always within the 3 dB cone of radiation BW of the used antenna





TX CH01 (Above 1000 MHz, Vertical)

110.0 dBuV/m

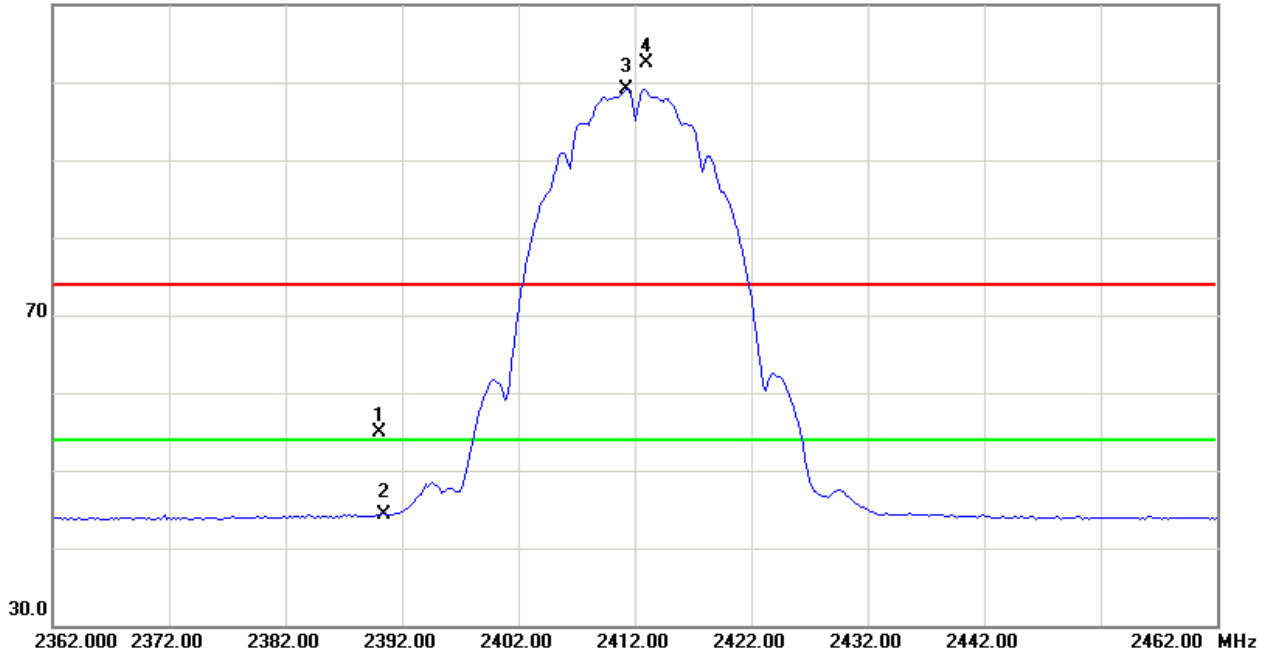

80.0 dBuV/m

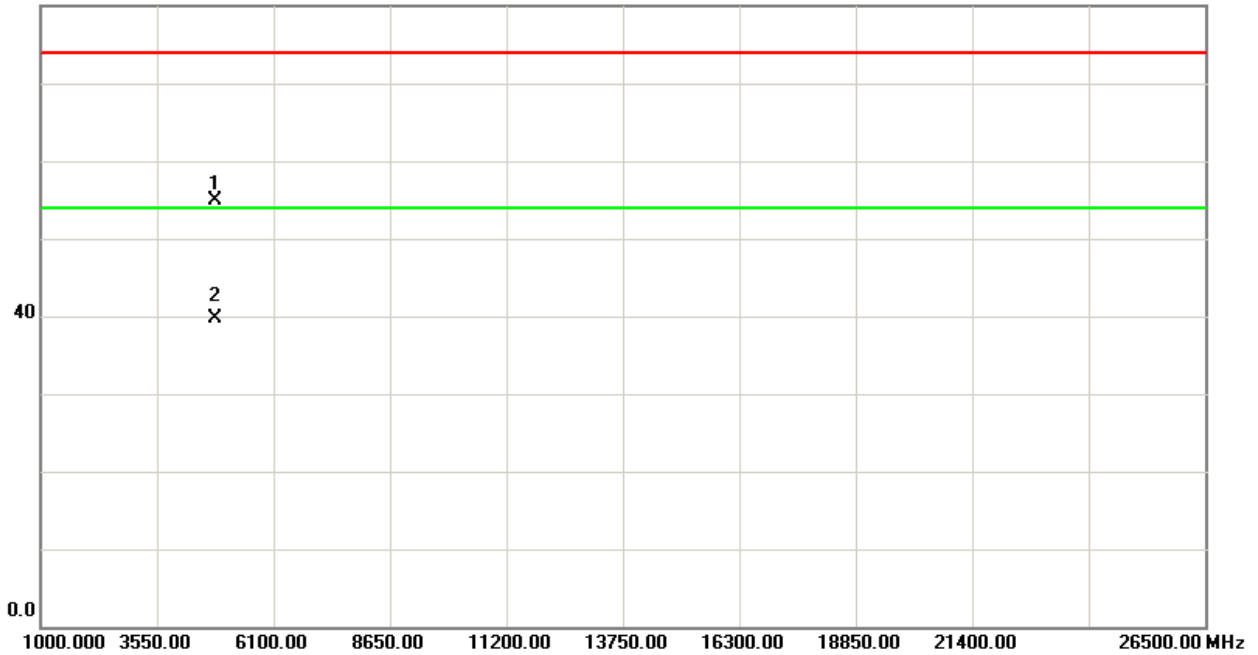



EUT :	Wireless N300 Home Router	Model Name :	W303R
Temperature :	24 °C	Relative Humidity :	51 %
Pressure :	1010 hPa	Test Voltage :	AC 120V/60Hz
Test Mode :	TX B MODE 2412MHz		

Freq.	Ant.Pol.	Reading		Ant./CF	Act.		Limit		Note
		Peak	AV		Peak	AV	Peak	AV	
(MHz)	H/V	(dBuV)	(dBuV)	CF(dB)	(dBuV/m)	(dBuV/m)	(dBuV/m)	(dBuV/m)	
2390.00	H	24.71	12.94	32.28	56.99	45.22	74.00	54.00	X/E
<b>2413.00</b>	<b>H</b>	<b>74.89</b>	<b>70.50</b>	<b>32.25</b>	<b>107.14</b>	<b>102.75</b>			<b>X/F</b>
4823.97	H	45.27	31.58	5.29	50.56	36.87	74.00	54.00	X/H

Remark :

- (1) All readings are Peak unless otherwise stated QP in column of 『Note』 . Peak denotes that the Peak reading compliance with the QP Limits and then QP Mode measurement didn't perform ◦
- (2) Measuring frequency range from 30MHz to 1000MHz or the 10th harmonic of highest fundamental frequency ◦ "F" denotes fundamental frequency; "H" denotes spurious frequency. "E" denotes band edge frequency. (This judgment method includes the Band Edge Requirement.)
- (3) Radiated emissions measured in frequency range above 1000MHz were made with an instrument using Peak detector mode and AV detector mode of the emission ◦
- (4) Data of measurement within this frequency range shown " \* " in the table above means the reading of emissions are attenuated more than 20dB below the permissible limits or the field strength is too small to be measured.
- (5) A preamp and high pass filter were used for this test in order to provide sufficient measurement sensitivity.
- (6) EUT Orthogonal Axis :  
"X" - denotes Laid on Table ; "Y" - denotes Vertical Stand ; "Z" - denotes Side Stand
- (7) During the measurements above 1 GHz it is taken care of that the EUT is always within the 3 dB cone of radiation BW of the used antenna



TX CH01 (Above 1000 MHz, Horizontal)

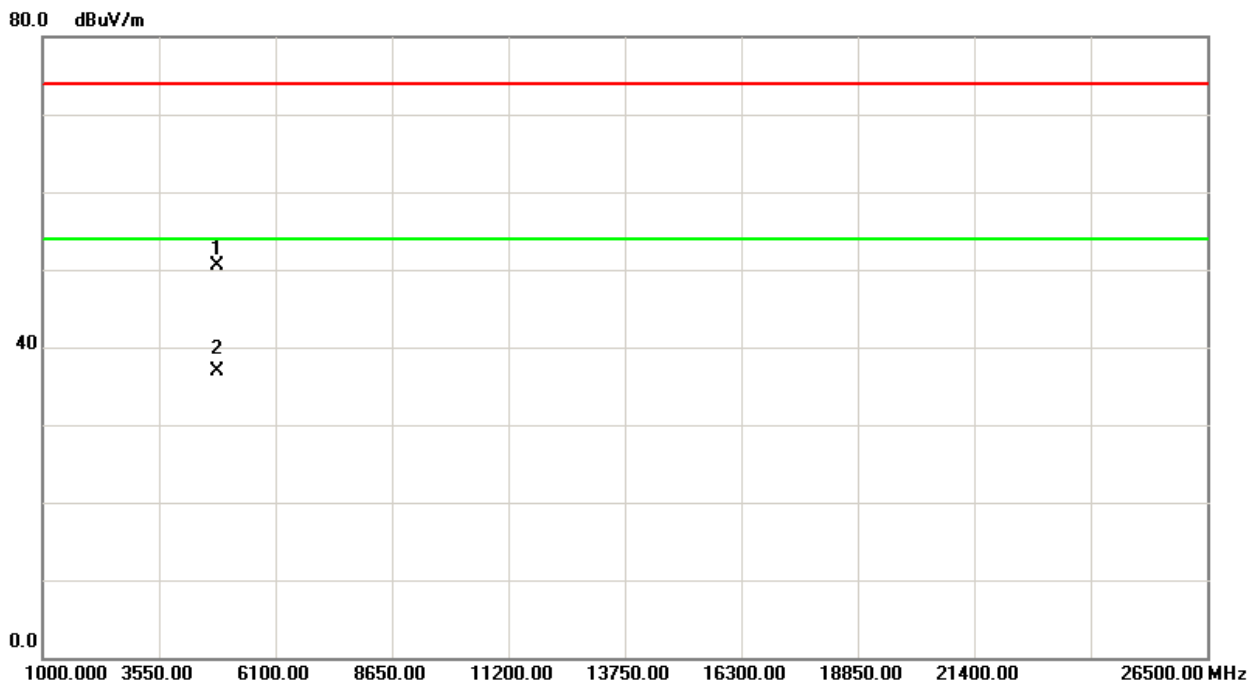
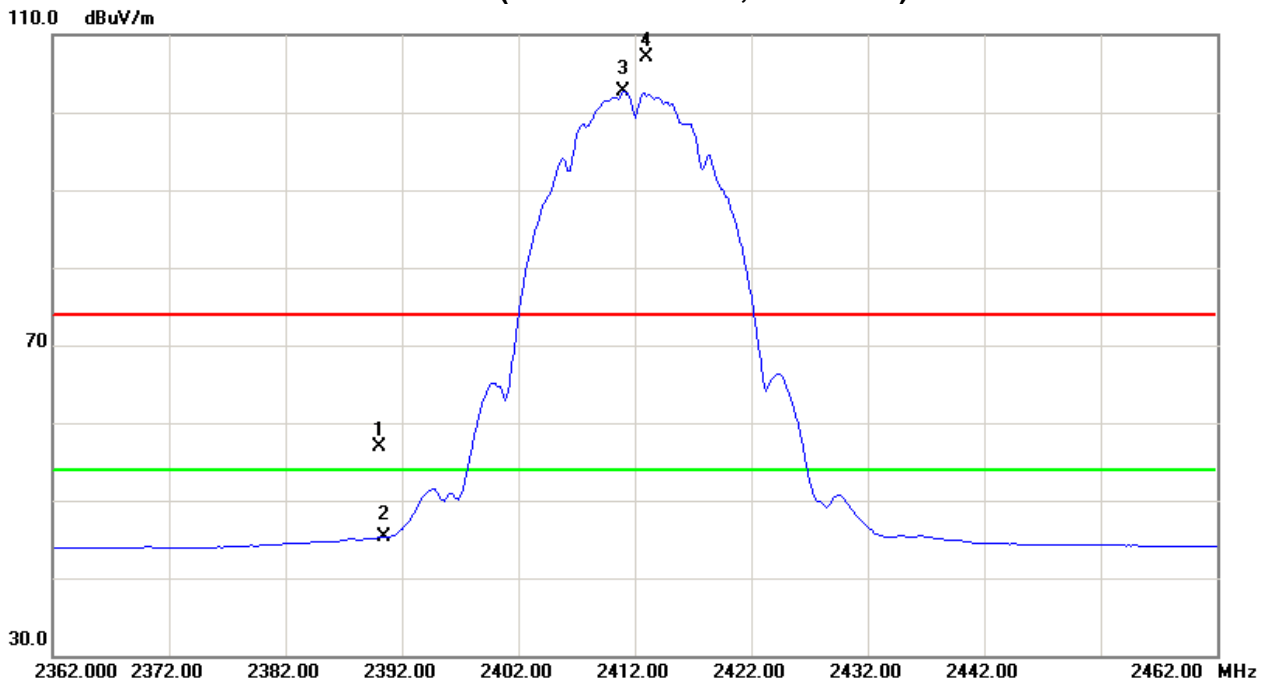



EUT :	Wireless N300 Home Router	Model Name :	W303R
Temperature :	24 °C	Relative Humidity :	51 %
Pressure :	1010 hPa	Test Voltage :	AC 120V/60Hz
Test Mode :	TX B MODE 2437MHz		

Freq.	Ant.Pol.	Reading		Ant./CF	Act.		Limit		Note
		Peak	AV		Peak	AV	Peak	AV	
(MHz)	H/V	(dBuV)	(dBuV)	CF(dB)	(dBuV/m)	(dBuV/m)	(dBuV/m)	(dBuV/m)	
<b>2438.20</b>	<b>V</b>	<b>70.38</b>	<b>66.59</b>	<b>32.22</b>	<b>102.60</b>	<b>98.81</b>			<b>X/F</b>
4873.98	V	48.74	34.96	5.47	54.21	40.43	74.00	54.00	X/H

Remark :

- (1) All readings are Peak unless otherwise stated QP in column of 『Note』 . Peak denotes that the Peak reading compliance with the QP Limits and then QP Mode measurement didn't perform ◦
- (2) Measuring frequency range from 30MHz to 1000MHz or the 10th harmonic of highest fundamental frequency ◦ "F" denotes fundamental frequency; "H" denotes spurious frequency. "E" denotes band edge frequency. (This judgment method includes the Band Edge Requirement.)
- (3) Radiated emissions measured in frequency range above 1000MHz were made with an instrument using Peak detector mode and AV detector mode of the emission ◦
- (4) Data of measurement within this frequency range shown " \* " in the table above means the reading of emissions are attenuated more than 20dB below the permissible limits or the field strength is too small to be measured.
- (5) A preamp and high pass filter were used for this test in order to provide sufficient measurement sensitivity.
- (6) EUT Orthogonal Axis :  
"X" - denotes Laid on Table ; "Y" - denotes Vertical Stand ; "Z" - denotes Side Stand
- (7) During the measurements above 1 GHz it is taken care of that the EUT is always within the 3 dB cone of radiation BW of the used antenna



TX CH06 (Above 1000 MHz, Vertical)

110.0 dBuV/m

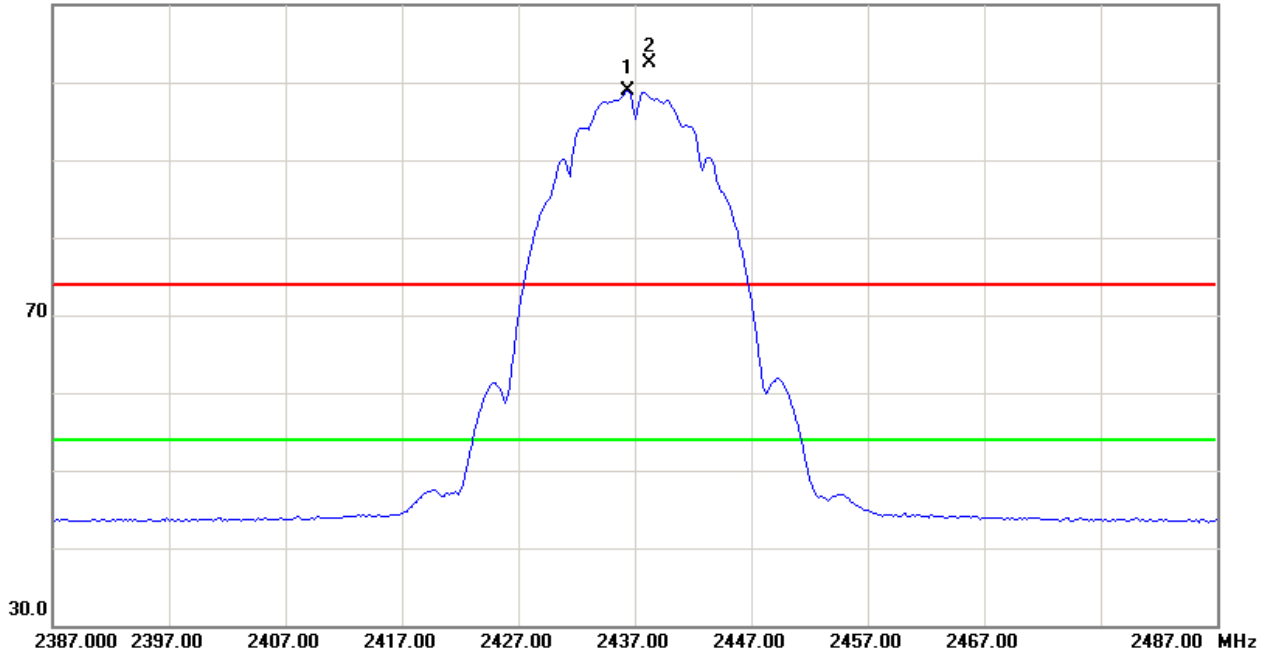

80.0 dBuV/m

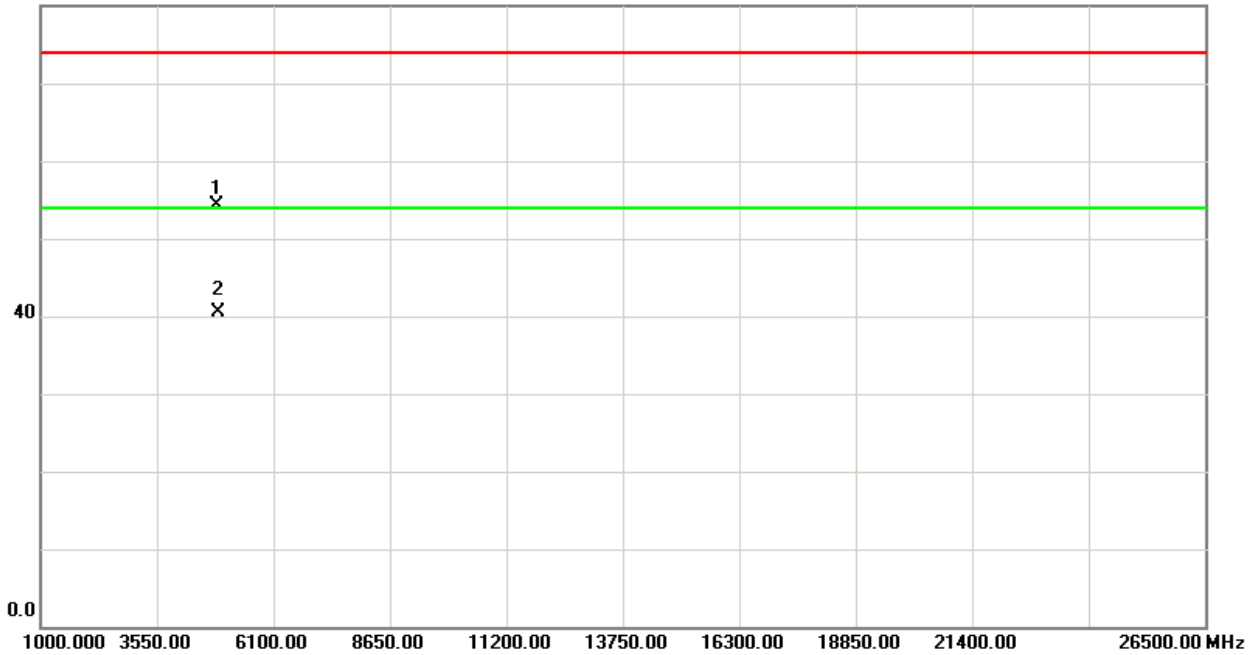



EUT :	Wireless N300 Home Router	Model Name :	W303R
Temperature :	24 °C	Relative Humidity :	51 %
Pressure :	1010 hPa	Test Voltage :	AC 120V/60Hz
Test Mode :	TX B MODE 2437MHz		

Freq. (MHz)	Ant.Pol. H/V	Reading		Ant./CF CF(dB)	Act.		Limit		Note
		Peak (dBuV)	AV (dBuV)		Peak (dBuV/m)	AV (dBuV/m)	Peak (dBuV/m)	AV (dBuV/m)	
<b>2438.00</b>	<b>H</b>	<b>75.46</b>	<b>71.58</b>	<b>32.22</b>	<b>107.68</b>	<b>103.80</b>			<b>X/F</b>
4874.01	H	45.13	31.43	5.47	50.60	36.90	74.00	54.00	X/H

Remark :

- (1) All readings are Peak unless otherwise stated QP in column of 『Note』 . Peak denotes that the Peak reading compliance with the QP Limits and then QP Mode measurement didn't perform ◦
- (2) Measuring frequency range from 30MHz to 1000MHz or the 10th harmonic of highest fundamental frequency ◦ "F" denotes fundamental frequency; "H" denotes spurious frequency. "E" denotes band edge frequency. (This judgment method includes the Band Edge Requirement.)
- (3) Radiated emissions measured in frequency range above 1000MHz were made with an instrument using Peak detector mode and AV detector mode of the emission ◦
- (4) Data of measurement within this frequency range shown " \* " in the table above means the reading of emissions are attenuated more than 20dB below the permissible limits or the field strength is too small to be measured.
- (5) A preamp and high pass filter were used for this test in order to provide sufficient measurement sensitivity.
- (6) EUT Orthogonal Axis :  
"X" - denotes Laid on Table ; "Y" - denotes Vertical Stand ; "Z" - denotes Side Stand
- (7) During the measurements above 1 GHz it is taken care of that the EUT is always within the 3 dB cone of radiation BW of the used antenna



TX CH06 (Above 1000 MHz, Horizontal)

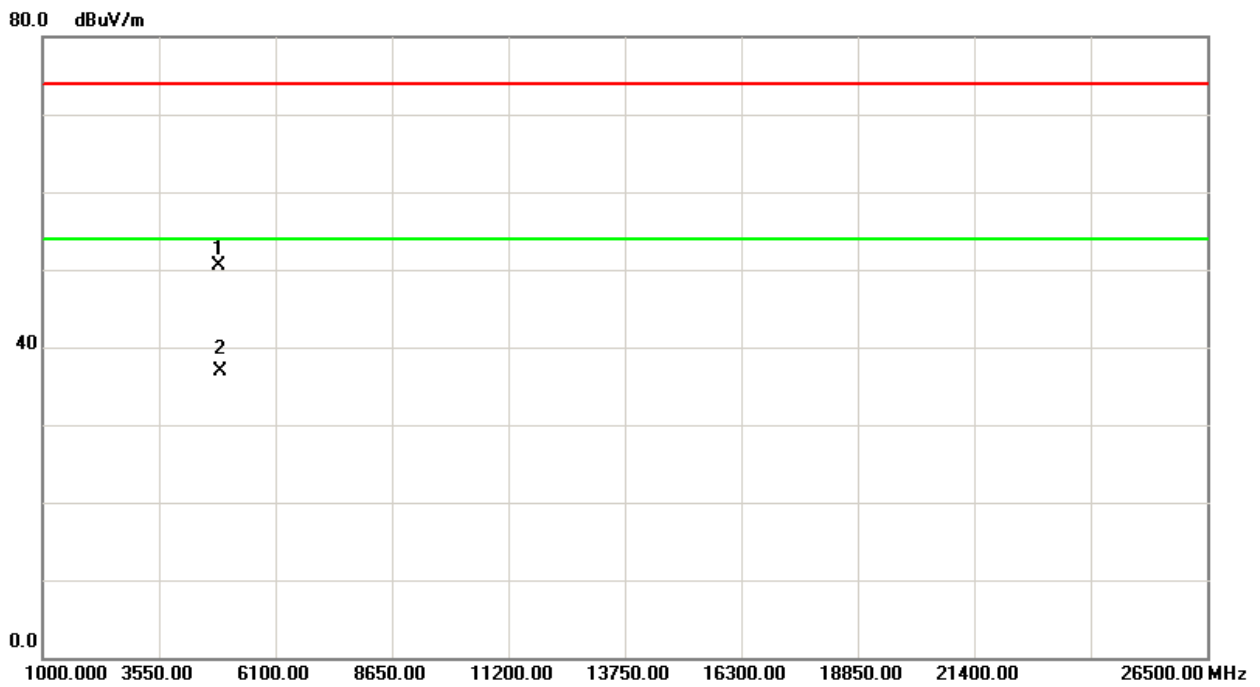
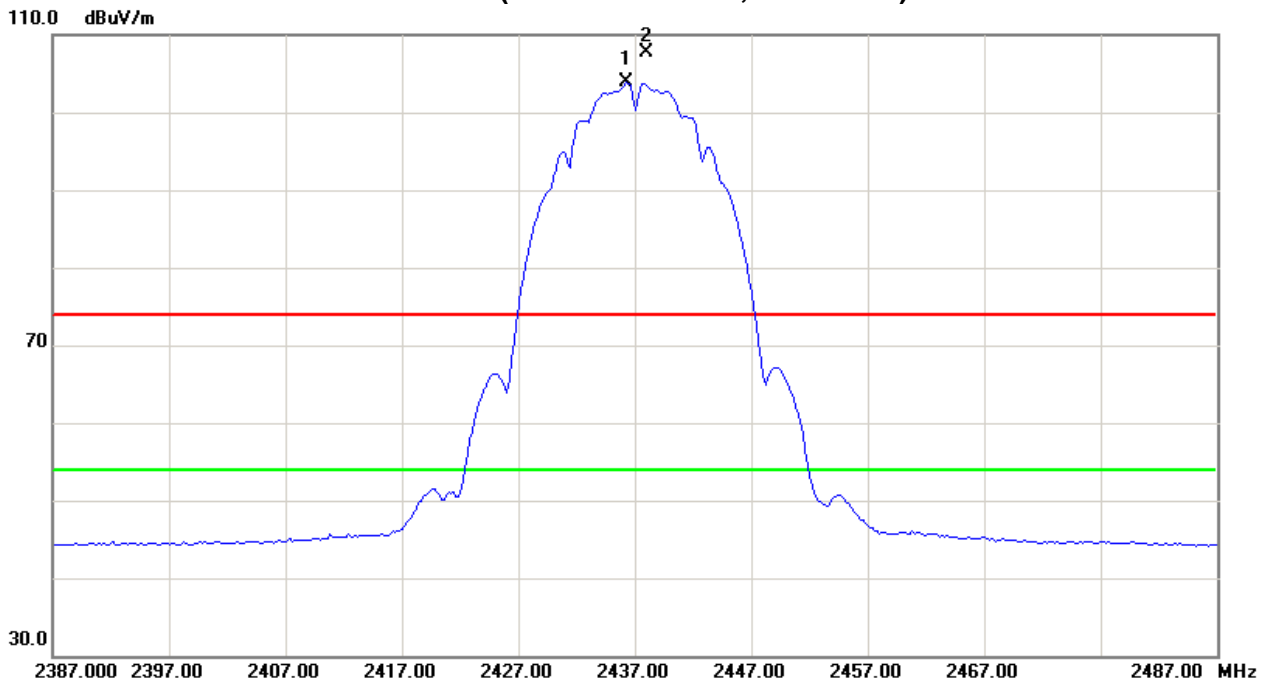



EUT :	Wireless N300 Home Router	Model Name :	W303R
Temperature :	24 °C	Relative Humidity :	51 %
Pressure :	1010 hPa	Test Voltage :	AC 120V/60Hz
Test Mode :	TX B MODE 2462MHz		

Freq.	Ant.Pol.	Reading		Ant./CF	Act.		Limit		Note
		Peak	AV		Peak	AV	Peak	AV	
(MHz)	H/V	(dBuV)	(dBuV)	CF(dB)	(dBuV/m)	(dBuV/m)	(dBuV/m)	(dBuV/m)	
<b>2463.00</b>	<b>V</b>	<b>70.11</b>	<b>66.49</b>	<b>32.20</b>	<b>102.31</b>	<b>98.69</b>			<b>X/F</b>
2483.50	V	23.51	11.94	32.17	55.68	44.11	74.00	54.00	X/E
4924.01	V	48.56	33.61	5.65	54.21	39.26	74.00	54.00	X/H

Remark :

- (1) All readings are Peak unless otherwise stated QP in column of 『Note』 . Peak denotes that the Peak reading compliance with the QP Limits and then QP Mode measurement didn't perform ◦
- (2) Measuring frequency range from 30MHz to 1000MHz or the 10th harmonic of highest fundamental frequency ◦ "F" denotes fundamental frequency; "H" denotes spurious frequency. "E" denotes band edge frequency. (This judgment method includes the Band Edge Requirement.)
- (3) Radiated emissions measured in frequency range above 1000MHz were made with an instrument using Peak detector mode and AV detector mode of the emission ◦
- (4) Data of measurement within this frequency range shown " \* " in the table above means the reading of emissions are attenuated more than 20dB below the permissible limits or the field strength is too small to be measured.
- (5) A preamp and high pass filter were used for this test in order to provide sufficient measurement sensitivity.
- (6) EUT Orthogonal Axis :  
"X" - denotes Laid on Table ; "Y" - denotes Vertical Stand ; "Z" - denotes Side Stand
- (7) During the measurements above 1 GHz it is taken care of that the EUT is always within the 3 dB cone of radiation BW of the used antenna





TX CH11 (Above 1000 MHz, Vertical)

110.0 dBuV/m

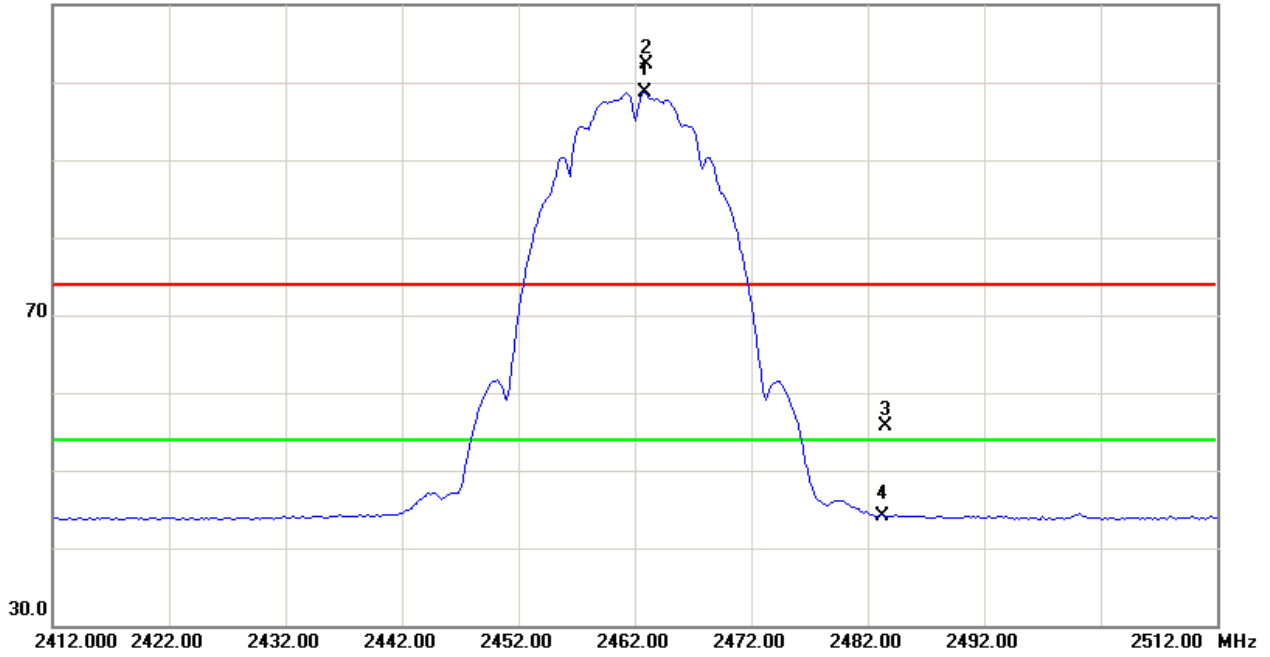

80.0 dBuV/m

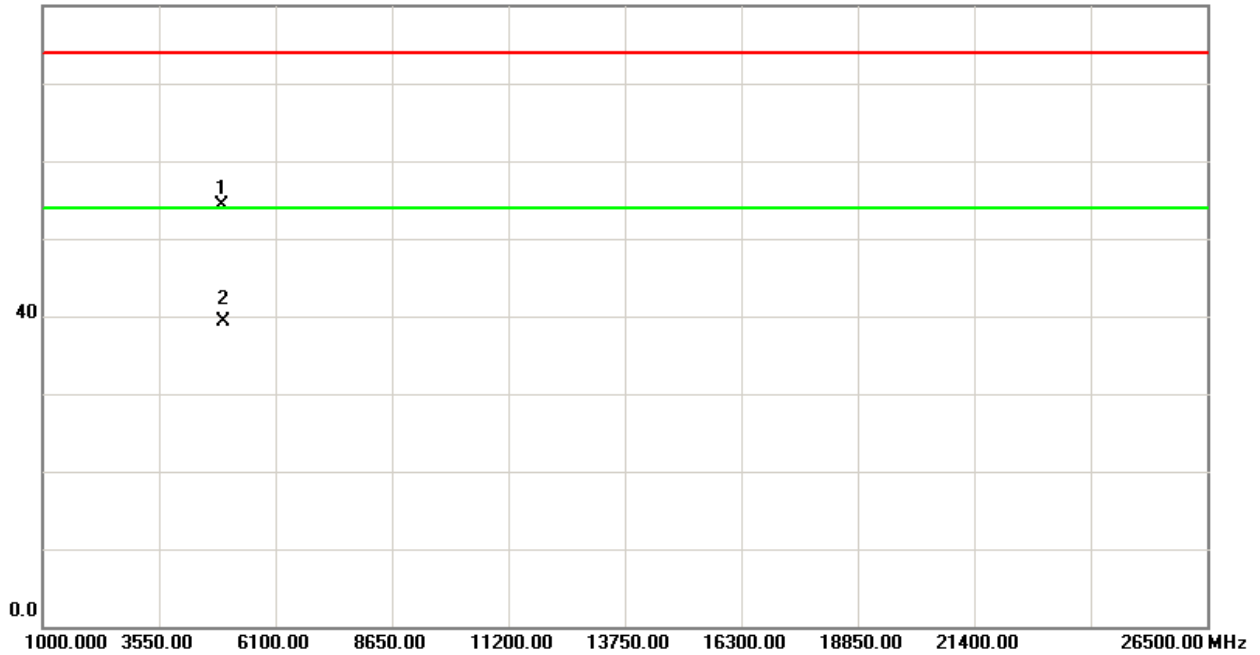



EUT :	Wireless N300 Home Router	Model Name :	W303R
Temperature :	24 °C	Relative Humidity :	51 %
Pressure :	1010 hPa	Test Voltage :	AC 120V/60Hz
Test Mode :	TX B MODE 2462MHz		

Freq.	Ant.Pol.	Reading		Ant./CF	Act.		Limit		Note
		Peak	AV		Peak	AV	Peak	AV	
(MHz)	H/V	(dBuV)	(dBuV)	CF(dB)	(dBuV/m)	(dBuV/m)	(dBuV/m)	(dBuV/m)	
<b>2463.00</b>	<b>H</b>	<b>75.45</b>	<b>71.48</b>	<b>32.20</b>	<b>107.65</b>	<b>103.68</b>			<b>X/F</b>
2483.50	H	25.40	13.28	32.17	57.57	45.45	74.00	54.00	X/E
4923.98	H	47.92	32.36	5.65	53.57	38.01	74.00	54.00	X/H

Remark :

- (1) All readings are Peak unless otherwise stated QP in column of 『Note』 . Peak denotes that the Peak reading compliance with the QP Limits and then QP Mode measurement didn't perform ◦
- (2) Measuring frequency range from 30MHz to 1000MHz or the 10th harmonic of highest fundamental frequency ◦ "F" denotes fundamental frequency; "H" denotes spurious frequency. "E" denotes band edge frequency. (This judgment method includes the Band Edge Requirement.)
- (3) Radiated emissions measured in frequency range above 1000MHz were made with an instrument using Peak detector mode and AV detector mode of the emission ◦
- (4) Data of measurement within this frequency range shown " \* " in the table above means the reading of emissions are attenuated more than 20dB below the permissible limits or the field strength is too small to be measured.
- (5) A preamp and high pass filter were used for this test in order to provide sufficient measurement sensitivity.
- (6) EUT Orthogonal Axis :  
"X" - denotes Laid on Table ; "Y" - denotes Vertical Stand ; "Z" - denotes Side Stand
- (7) During the measurements above 1 GHz it is taken care of that the EUT is always within the 3 dB cone of radiation BW of the used antenna



TX CH11 (Above 1000 MHz, Horizontal)

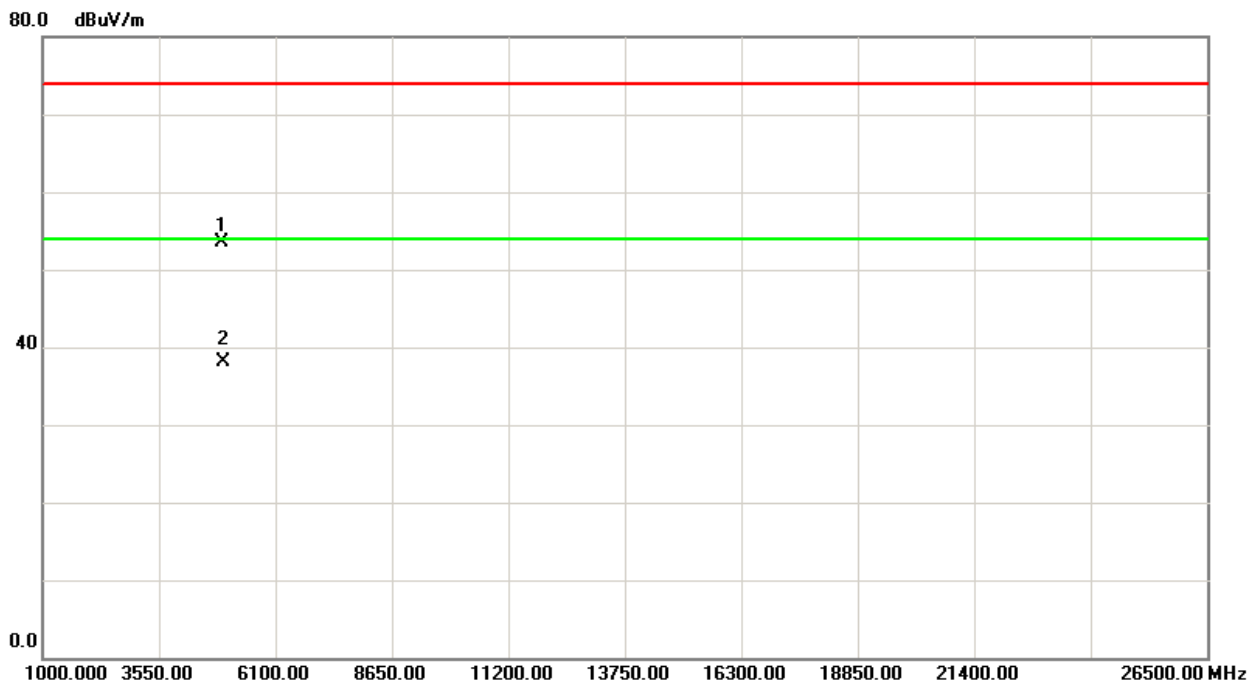
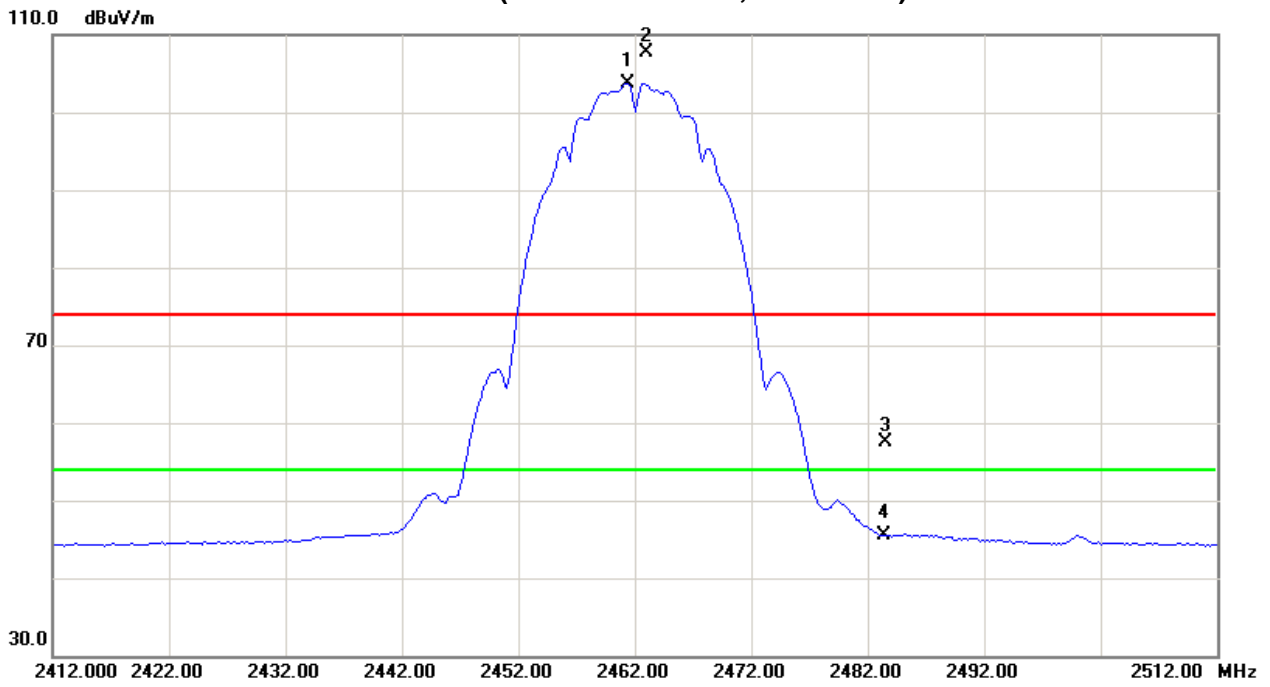



EUT :	Wireless N300 Home Router	Model Name :	W303R
Temperature :	24 °C	Relative Humidity :	51 %
Pressure :	1010 hPa	Test Voltage :	AC 120V/60Hz
Test Mode :	TX G MODE 2412MHz		

Freq. (MHz)	Ant.Pol. H/V	Reading		Ant./CF CF(dB)	Act.		Limit		Note
		Peak (dBuV)	AV (dBuV)		Peak (dBuV/m)	AV (dBuV/m)	Peak (dBuV/m)	AV (dBuV/m)	
2390.00	V	21.50	11.23	32.28	53.78	43.51	74.00	54.00	X/E
<b>2414.40</b>	<b>V</b>	<b>64.10</b>	<b>53.61</b>	<b>32.24</b>	<b>96.34</b>	<b>85.85</b>			<b>X/F</b>
4824.10	V	48.35	35.49	5.29	53.64	40.78	74.00	54.00	X/H

Remark :

- (1) All readings are Peak unless otherwise stated QP in column of 『Note』 . Peak denotes that the Peak reading compliance with the QP Limits and then QP Mode measurement didn't perform ◦
- (2) Measuring frequency range from 30MHz to 1000MHz or the 10th harmonic of highest fundamental frequency ◦ "F" denotes fundamental frequency; "H" denotes spurious frequency. "E" denotes band edge frequency. (This judgment method includes the Band Edge Requirement.)
- (3) Radiated emissions measured in frequency range above 1000MHz were made with an instrument using Peak detector mode and AV detector mode of the emission ◦
- (4) Data of measurement within this frequency range shown " \* " in the table above means the reading of emissions are attenuated more than 20dB below the permissible limits or the field strength is too small to be measured.
- (5) A preamp and high pass filter were used for this test in order to provide sufficient measurement sensitivity.
- (6) EUT Orthogonal Axis :  
"X" - denotes Laid on Table ; "Y" - denotes Vertical Stand ; "Z" - denotes Side Stand
- (7) During the measurements above 1 GHz it is taken care of that the EUT is always within the 3 dB cone of radiation BW of the used antenna



TX CH01 (Above 1000 MHz, Vertical)

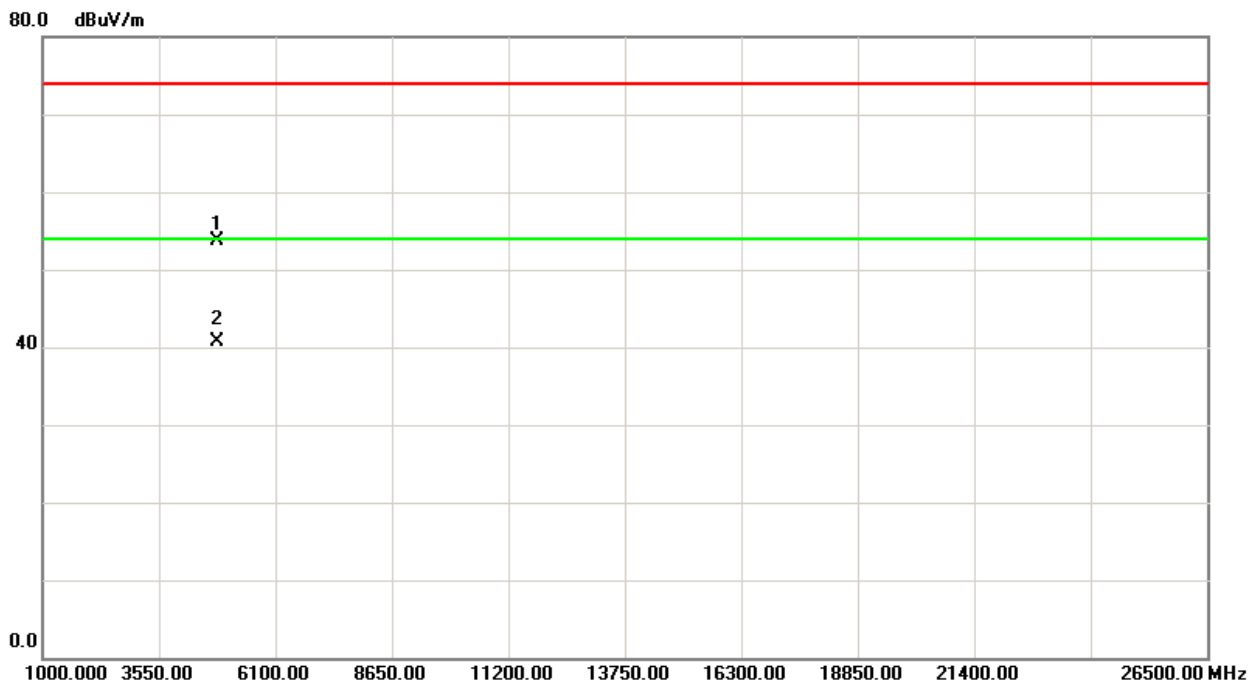
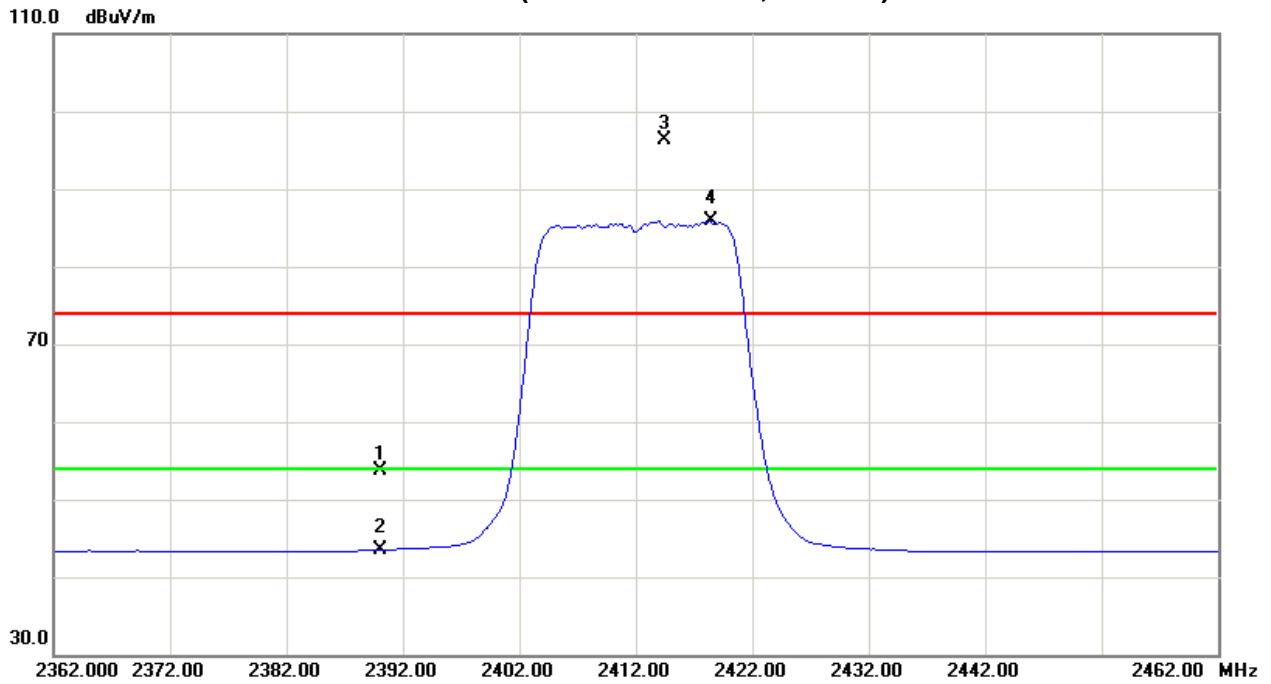



EUT :	Wireless N300 Home Router	Model Name :	W303R
Temperature :	24 °C	Relative Humidity :	51 %
Pressure :	1010 hPa	Test Voltage :	AC 120V/60Hz
Test Mode :	TX G MODE 2412MHz		

Freq. (MHz)	Ant.Pol. H/V	Reading		Ant./CF CF(dB)	Act.		Limit		Note
		Peak (dBuV)	AV (dBuV)		Peak (dBuV/m)	AV (dBuV/m)	Peak (dBuV/m)	AV (dBuV/m)	
2390.00	H	23.39	11.77	32.28	55.67	44.05	74.00	54.00	X/E
<b>2414.40</b>	<b>H</b>	<b>69.01</b>	<b>58.37</b>	<b>32.25</b>	<b>101.26</b>	<b>90.62</b>			<b>X/F</b>
4823.98	H	45.98	33.65	5.29	51.27	38.94	74.00	54.00	X/H

Remark :

- (1) All readings are Peak unless otherwise stated QP in column of 『Note』 . Peak denotes that the Peak reading compliance with the QP Limits and then QP Mode measurement didn't perform ◦
- (2) Measuring frequency range from 30MHz to 1000MHz or the 10th harmonic of highest fundamental frequency ◦ "F" denotes fundamental frequency; "H" denotes spurious frequency. "E" denotes band edge frequency. (This judgment method includes the Band Edge Requirement.)
- (3) Radiated emissions measured in frequency range above 1000MHz were made with an instrument using Peak detector mode and AV detector mode of the emission ◦
- (4) Data of measurement within this frequency range shown " \* " in the table above means the reading of emissions are attenuated more than 20dB below the permissible limits or the field strength is too small to be measured.
- (5) A preamp and high pass filter were used for this test in order to provide sufficient measurement sensitivity.
- (6) EUT Orthogonal Axis :  
"X" - denotes Laid on Table ; "Y" - denotes Vertical Stand ; "Z" - denotes Side Stand
- (7) During the measurements above 1 GHz it is taken care of that the EUT is always within the 3 dB cone of radiation BW of the used antenna



TX CH01 (Above 1000 MHz, Horizontal)

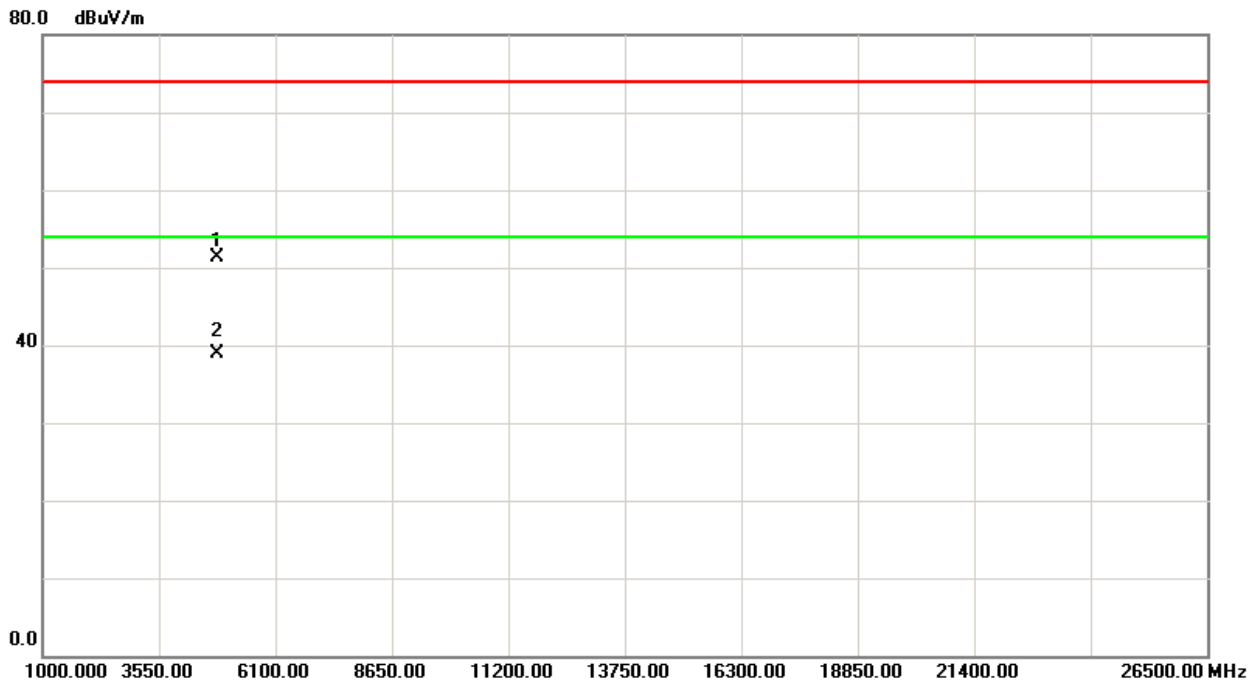
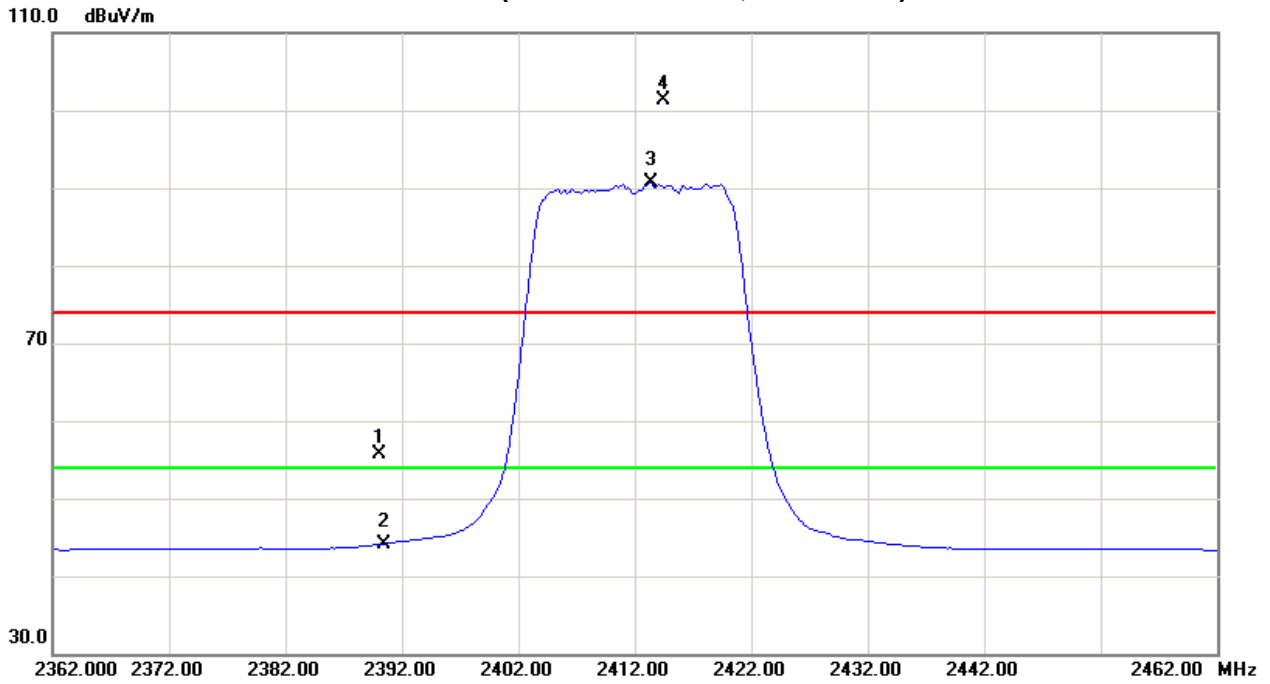



EUT :	Wireless N300 Home Router	Model Name :	W303R
Temperature :	24 °C	Relative Humidity :	51 %
Pressure :	1010 hPa	Test Voltage :	AC 120V/60Hz
Test Mode :	TX G MODE 2437MHz		

Freq.	Ant.Pol.	Reading		Ant./CF	Act.		Limit		Note
		Peak	AV		Peak	AV	Peak	AV	
(MHz)	H/V	(dBuV)	(dBuV)	CF(dB)	(dBuV/m)	(dBuV/m)	(dBuV/m)	(dBuV/m)	
<b>2439.40</b>	<b>V</b>	<b>64.62</b>	<b>54.24</b>	<b>32.22</b>	<b>96.84</b>	<b>86.46</b>			<b>X/F</b>
4873.99	V	47.98	35.65	5.47	53.45	41.12	74.00	54.00	X/H

Remark :

- (1) All readings are Peak unless otherwise stated QP in column of 『Note』 . Peak denotes that the Peak reading compliance with the QP Limits and then QP Mode measurement didn't perform ◦
- (2) Measuring frequency range from 30MHz to 1000MHz or the 10th harmonic of highest fundamental frequency ◦ "F" denotes fundamental frequency; "H" denotes spurious frequency. "E" denotes band edge frequency. (This judgment method includes the Band Edge Requirement.)
- (3) Radiated emissions measured in frequency range above 1000MHz were made with an instrument using Peak detector mode and AV detector mode of the emission ◦
- (4) Data of measurement within this frequency range shown " \* " in the table above means the reading of emissions are attenuated more than 20dB below the permissible limits or the field strength is too small to be measured.
- (5) A preamp and high pass filter were used for this test in order to provide sufficient measurement sensitivity.
- (6) EUT Orthogonal Axis :  
 "X" - denotes Laid on Table ; "Y" - denotes Vertical Stand ; "Z" - denotes Side Stand
- (7) During the measurements above 1 GHz it is taken care of that the EUT is always within the 3 dB cone of radiation BW of the used antenna





TX CH06 (Above 1000 MHz, Vertical)

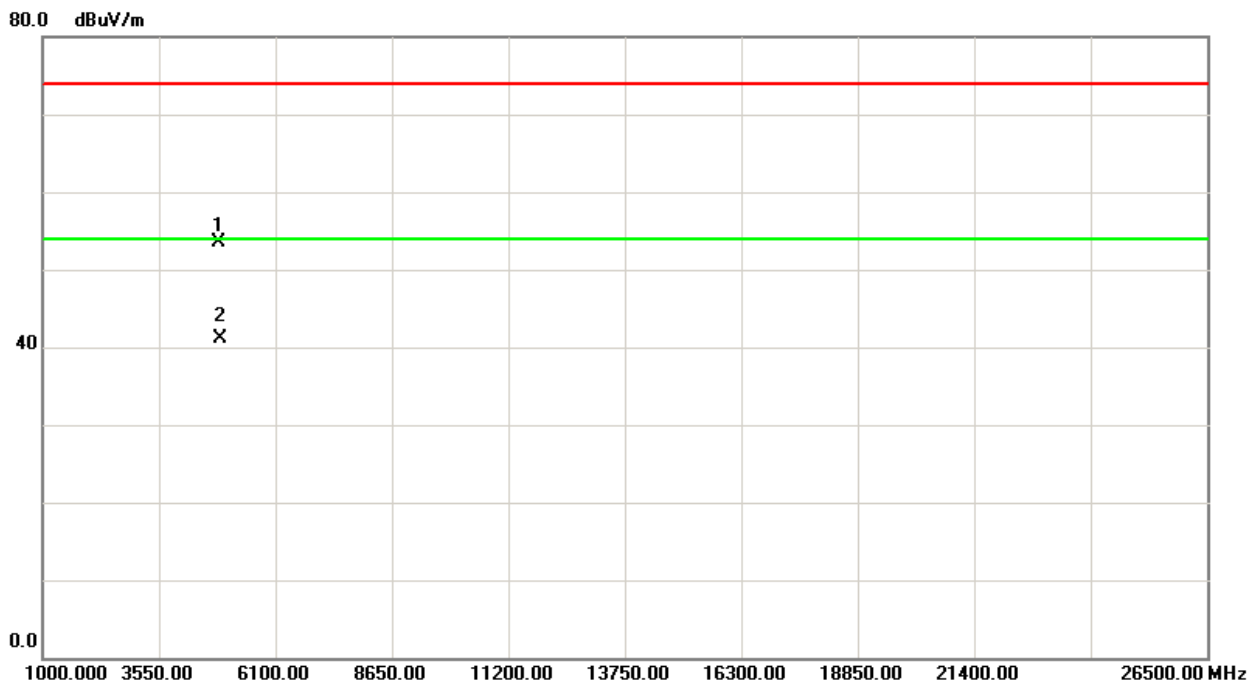
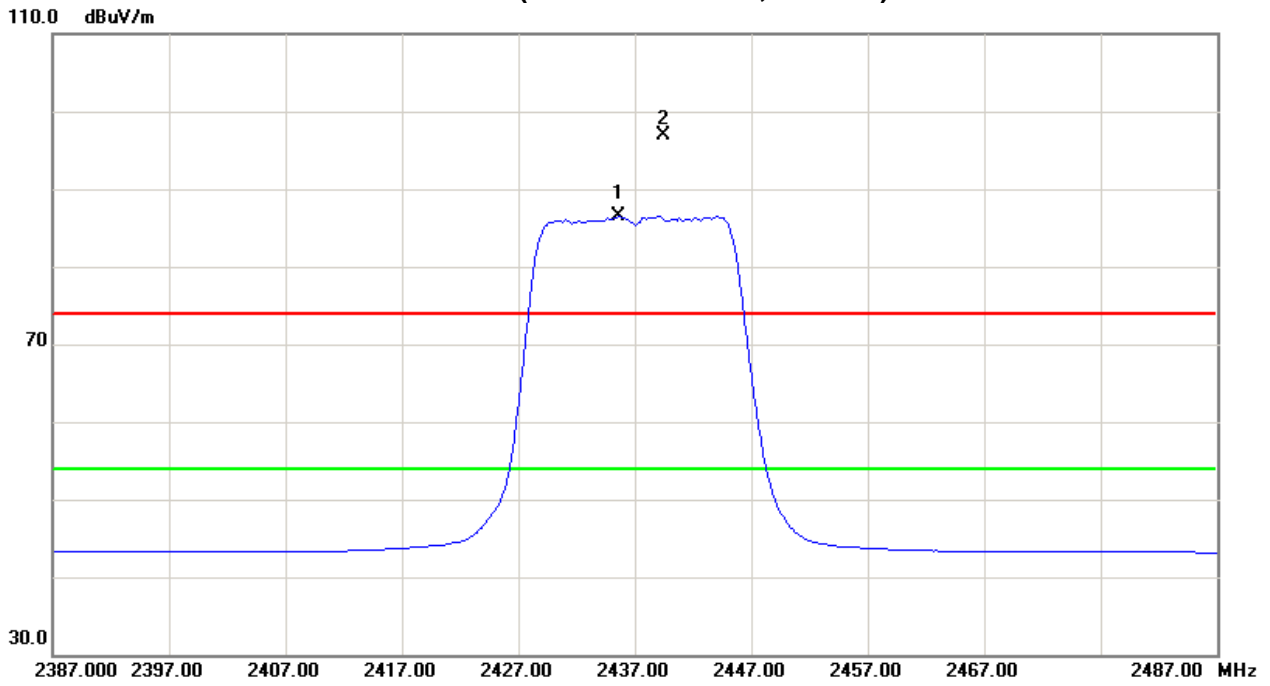



EUT :	Wireless N300 Home Router	Model Name :	W303R
Temperature :	24 °C	Relative Humidity :	51 %
Pressure :	1010 hPa	Test Voltage :	AC 120V/60Hz
Test Mode :	TX G MODE 2437MHz		

Freq.	Ant.Pol.	Reading		Ant./CF	Act.		Limit		Note
		Peak	AV		Peak	AV	Peak	AV	
(MHz)	H/V	(dBuV)	(dBuV)	CF(dB)	(dBuV/m)	(dBuV/m)	(dBuV/m)	(dBuV/m)	
<b>2439.40</b>	<b>H</b>	<b>69.56</b>	<b>58.71</b>	<b>32.22</b>	<b>101.78</b>	<b>90.93</b>			<b>X/F</b>
4873.98	H	46.72	35.03	5.47	52.19	40.50	74.00	54.00	X/H

Remark :

- (1) All readings are Peak unless otherwise stated QP in column of 『Note』 . Peak denotes that the Peak reading compliance with the QP Limits and then QP Mode measurement didn't perform ◦
- (2) Measuring frequency range from 30MHz to 1000MHz or the 10th harmonic of highest fundamental frequency ◦ "F" denotes fundamental frequency; "H" denotes spurious frequency. "E" denotes band edge frequency. (This judgment method includes the Band Edge Requirement.)
- (3) Radiated emissions measured in frequency range above 1000MHz were made with an instrument using Peak detector mode and AV detector mode of the emission ◦
- (4) Data of measurement within this frequency range shown " \* " in the table above means the reading of emissions are attenuated more than 20dB below the permissible limits or the field strength is too small to be measured.
- (5) A preamp and high pass filter were used for this test in order to provide sufficient measurement sensitivity.
- (6) EUT Orthogonal Axis :  
 "X" - denotes Laid on Table ; "Y" - denotes Vertical Stand ; "Z" - denotes Side Stand
- (7) During the measurements above 1 GHz it is taken care of that the EUT is always within the 3 dB cone of radiation BW of the used antenna



TX CH06 (Above 1000 MHz, Horizontal)

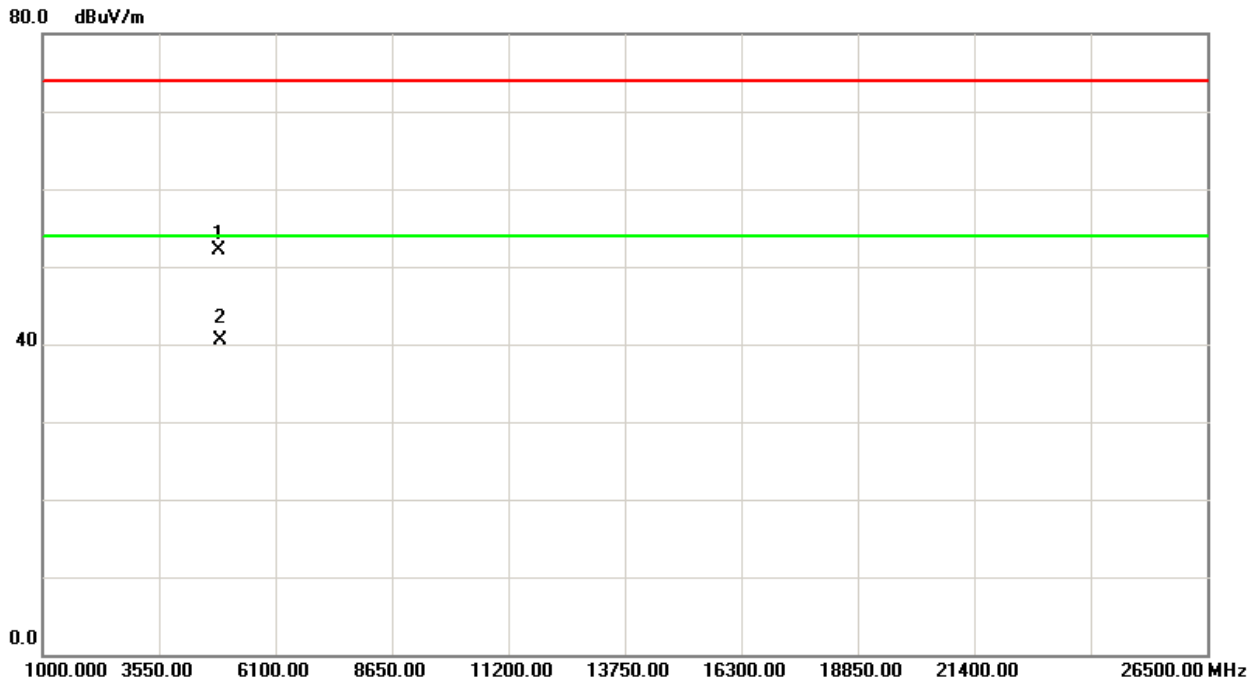
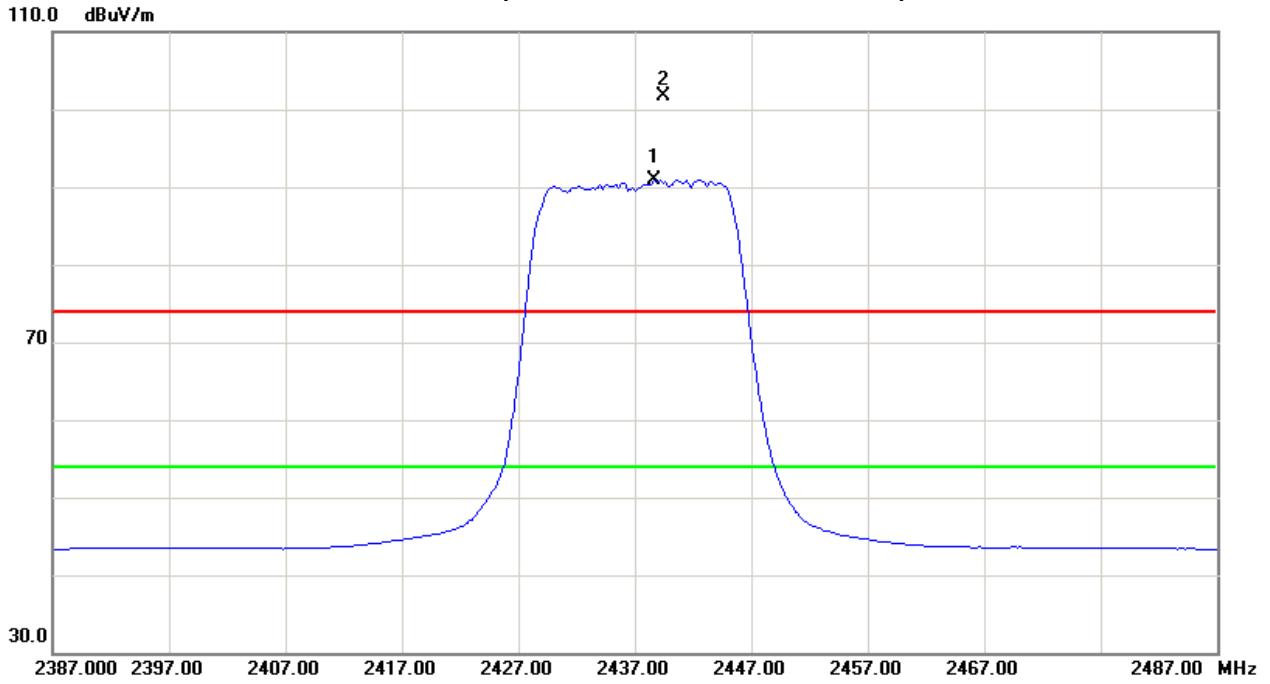



EUT :	Wireless N300 Home Router	Model Name :	W303R
Temperature :	24 °C	Relative Humidity :	51 %
Pressure :	1010 hPa	Test Voltage :	AC 120V/60Hz
Test Mode :	TX G MODE 2462MHz		

Freq.	Ant.Pol.	Reading		Ant./CF	Act.		Limit		Note
		Peak	AV		Peak	AV	Peak	AV	
(MHz)	H/V	(dBuV)	(dBuV)	CF(dB)	(dBuV/m)	(dBuV/m)	(dBuV/m)	(dBuV/m)	
<b>2457.00</b>	<b>V</b>	<b>64.83</b>	<b>54.14</b>	<b>32.21</b>	<b>97.04</b>	<b>86.35</b>			<b>X/F</b>
2483.50	V	22.46	11.30	32.17	54.63	43.47	74.00	54.00	X/E
4923.98	V	48.01	34.98	5.65	53.66	40.63	74.00	54.00	X/H

Remark :

- (1) All readings are Peak unless otherwise stated QP in column of 『Note』 . Peak denotes that the Peak reading compliance with the QP Limits and then QP Mode measurement didn't perform ◦
- (2) Measuring frequency range from 30MHz to 1000MHz or the 10th harmonic of highest fundamental frequency ◦ "F" denotes fundamental frequency; "H" denotes spurious frequency. "E" denotes band edge frequency. (This judgment method includes the Band Edge Requirement.)
- (3) Radiated emissions measured in frequency range above 1000MHz were made with an instrument using Peak detector mode and AV detector mode of the emission ◦
- (4) Data of measurement within this frequency range shown " \* " in the table above means the reading of emissions are attenuated more than 20dB below the permissible limits or the field strength is too small to be measured.
- (5) A preamp and high pass filter were used for this test in order to provide sufficient measurement sensitivity.
- (6) EUT Orthogonal Axis :  
"X" - denotes Laid on Table ; "Y" - denotes Vertical Stand ; "Z" - denotes Side Stand
- (7) During the measurements above 1 GHz it is taken care of that the EUT is always within the 3 dB cone of radiation BW of the used antenna



TX CH11 (Above 1000 MHz, Vertical)

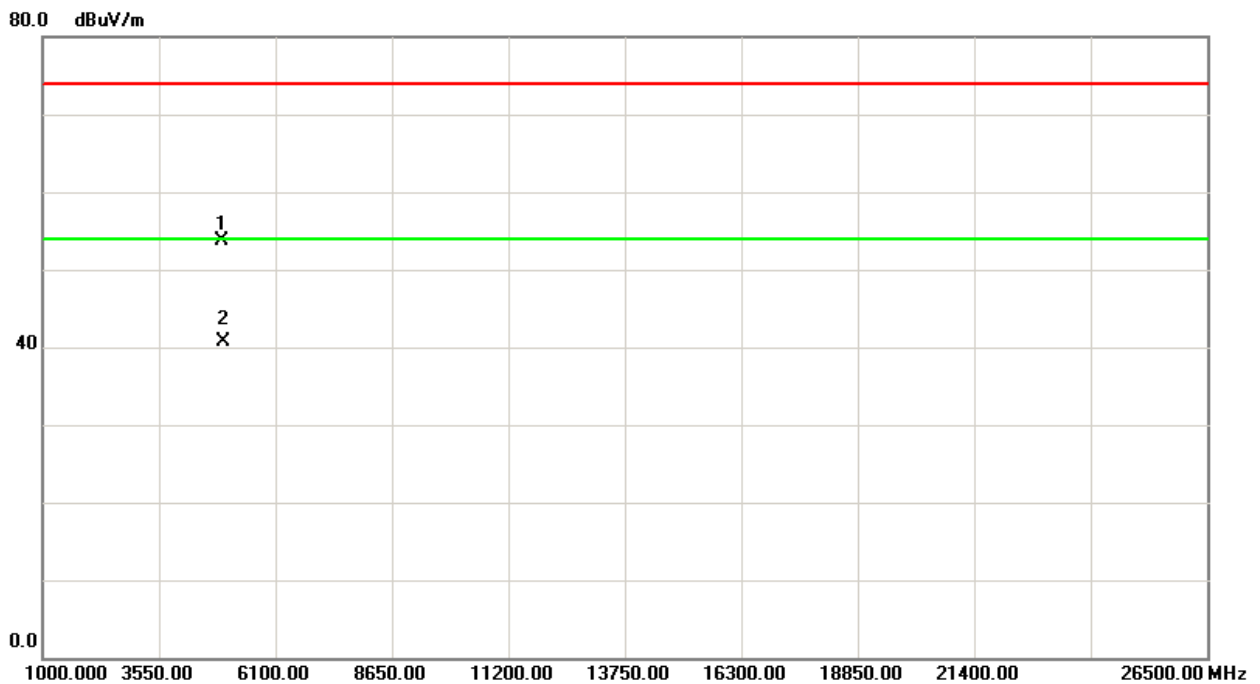
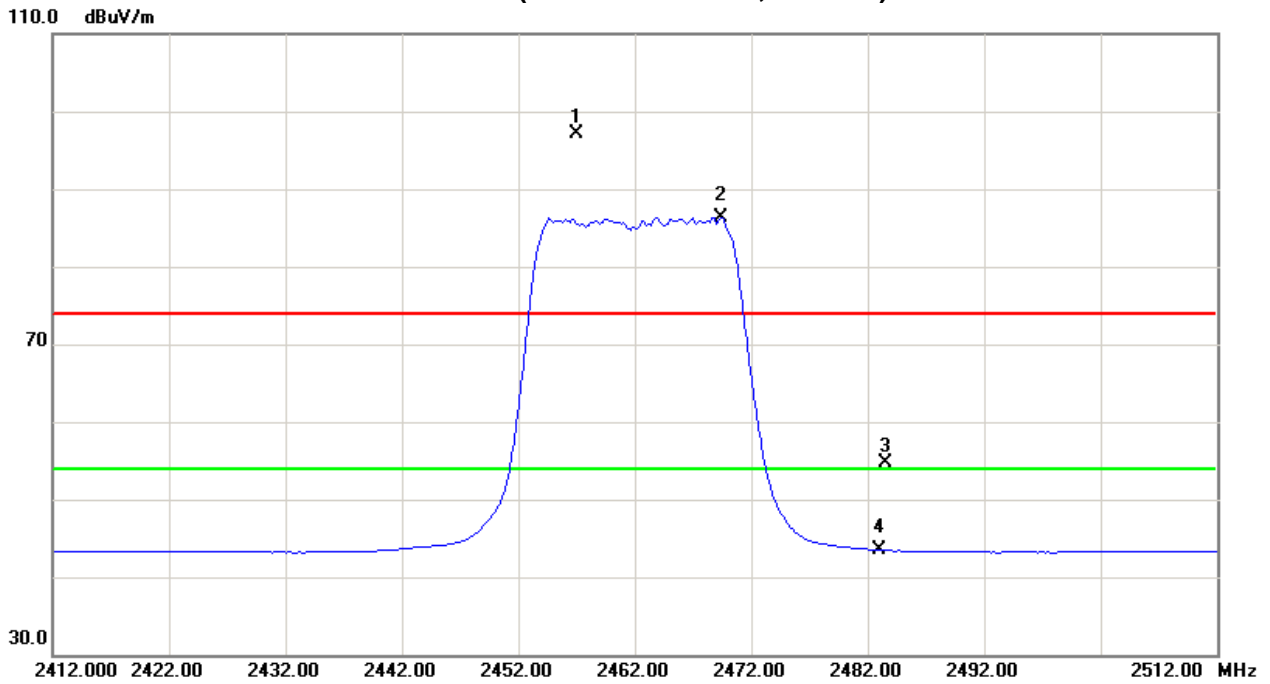



EUT :	Wireless N300 Home Router	Model Name :	W303R
Temperature :	24 °C	Relative Humidity :	51 %
Pressure :	1010 hPa	Test Voltage :	AC 120V/60Hz
Test Mode :	TX G MODE 2462MHz		

Freq.	Ant.Pol.	Reading		Ant./CF	Act.		Limit		Note
		Peak	AV		Peak	AV	Peak	AV	
(MHz)	H/V	(dBuV)	(dBuV)	CF(dB)	(dBuV/m)	(dBuV/m)	(dBuV/m)	(dBuV/m)	
<b>2468.40</b>	<b>H</b>	<b>69.85</b>	<b>59.33</b>	<b>32.19</b>	<b>102.04</b>	<b>91.52</b>			<b>X/F</b>
2483.50	H	24.18	12.12	32.17	56.35	44.29	74.00	54.00	X/E
4924.12	H	44.98	33.06	5.65	50.63	38.71	74.00	54.00	X/H

Remark :

- (1) All readings are Peak unless otherwise stated QP in column of 『Note』 . Peak denotes that the Peak reading compliance with the QP Limits and then QP Mode measurement didn't perform ◦
- (2) Measuring frequency range from 30MHz to 1000MHz or the 10th harmonic of highest fundamental frequency ◦ "F" denotes fundamental frequency; "H" denotes spurious frequency. "E" denotes band edge frequency. (This judgment method includes the Band Edge Requirement.)
- (3) Radiated emissions measured in frequency range above 1000MHz were made with an instrument using Peak detector mode and AV detector mode of the emission ◦
- (4) Data of measurement within this frequency range shown " \* " in the table above means the reading of emissions are attenuated more than 20dB below the permissible limits or the field strength is too small to be measured.
- (5) A preamp and high pass filter were used for this test in order to provide sufficient measurement sensitivity.
- (6) EUT Orthogonal Axis :  
"X" - denotes Laid on Table ; "Y" - denotes Vertical Stand ; "Z" - denotes Side Stand
- (7) During the measurements above 1 GHz it is taken care of that the EUT is always within the 3 dB cone of radiation BW of the used antenna



TX CH11 (Above 1000 MHz, Horizontal)

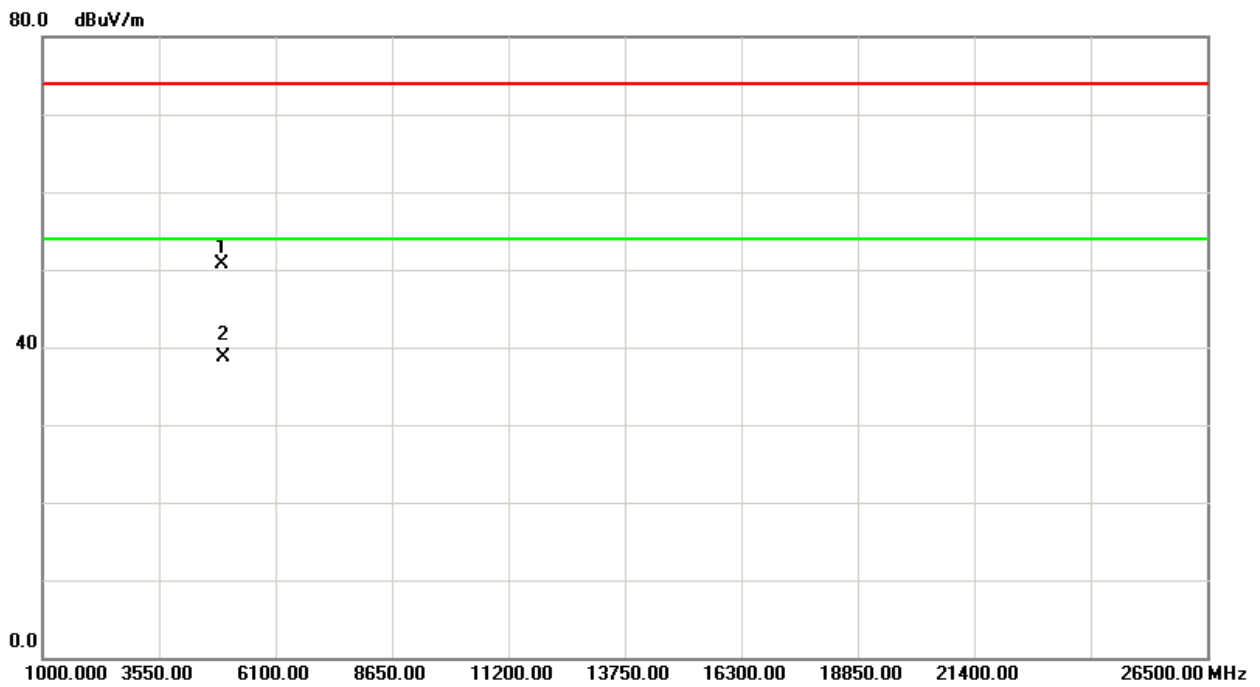
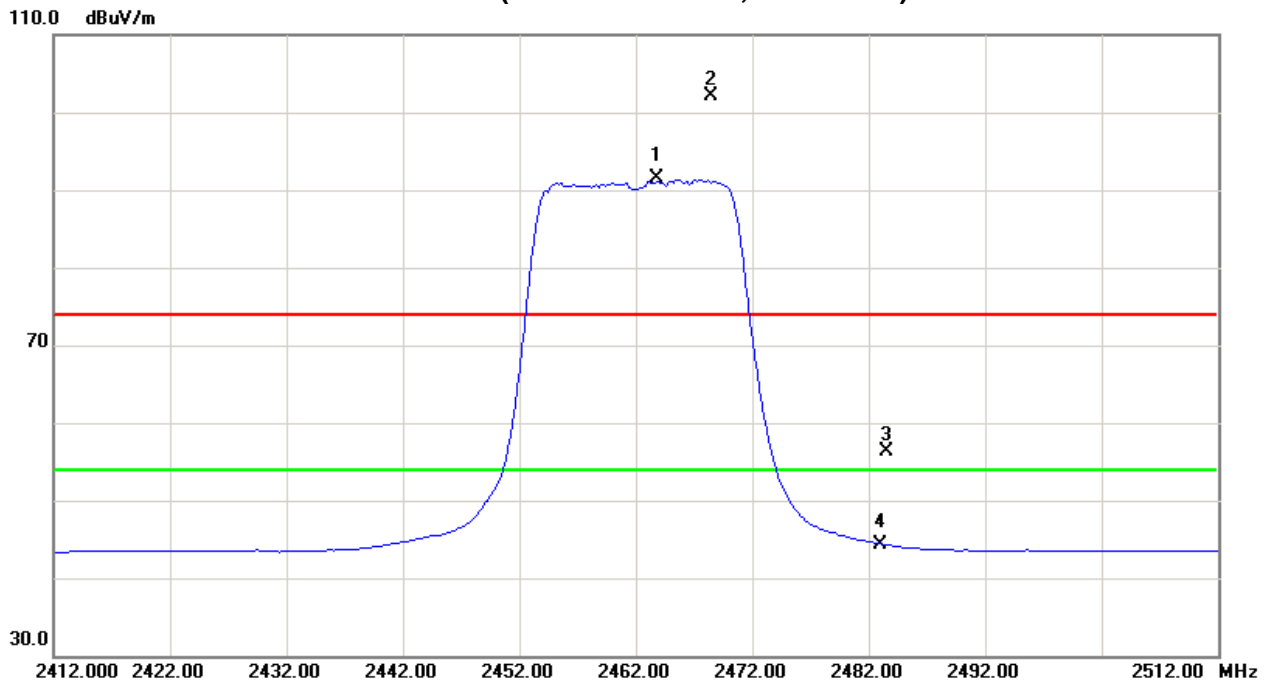



EUT :	Wireless N300 Home Router	Model Name :	W303R
Temperature :	24 °C	Relative Humidity :	51 %
Pressure :	1010 hPa	Test Voltage :	AC 120V/60Hz
Test Mode :	TX N-20M MODE 2412MHz		

Freq.	Ant.Pol.	Reading		Ant./CF	Act.		Limit		Note
		Peak	AV		Peak	AV	Peak	AV	
(MHz)	H/V	(dBuV)	(dBuV)	CF(dB)	(dBuV/m)	(dBuV/m)	(dBuV/m)	(dBuV/m)	
2390.00	V	26.27	14.15	32.28	58.55	46.43	74.00	54.00	X/E
<b>2412.60</b>	<b>V</b>	<b>71.98</b>	<b>59.79</b>	<b>32.25</b>	<b>104.23</b>	<b>92.04</b>			<b>X/F</b>
4823.98	V	47.96	34.96	5.29	53.25	40.25	74.00	54.00	X/H

Remark :

- (1) All readings are Peak unless otherwise stated QP in column of 『Note』 . Peak denotes that the Peak reading compliance with the QP Limits and then QP Mode measurement didn't perform ◦
- (2) Measuring frequency range from 30MHz to 1000MHz or the 10th harmonic of highest fundamental frequency ◦ "F" denotes fundamental frequency; "H" denotes spurious frequency. "E" denotes band edge frequency. (This judgment method includes the Band Edge Requirement.)
- (3) Radiated emissions measured in frequency range above 1000MHz were made with an instrument using Peak detector mode and AV detector mode of the emission ◦
- (4) Data of measurement within this frequency range shown " \* " in the table above means the reading of emissions are attenuated more than 20dB below the permissible limits or the field strength is too small to be measured.
- (5) A preamp and high pass filter were used for this test in order to provide sufficient measurement sensitivity.
- (6) EUT Orthogonal Axis :  
"X" - denotes Laid on Table ; "Y" - denotes Vertical Stand ; "Z" - denotes Side Stand
- (7) During the measurements above 1 GHz it is taken care of that the EUT is always within the 3 dB cone of radiation BW of the used antenna





TX CH01 (Above 1000 MHz, Vertical)

110.0 dBuV/m

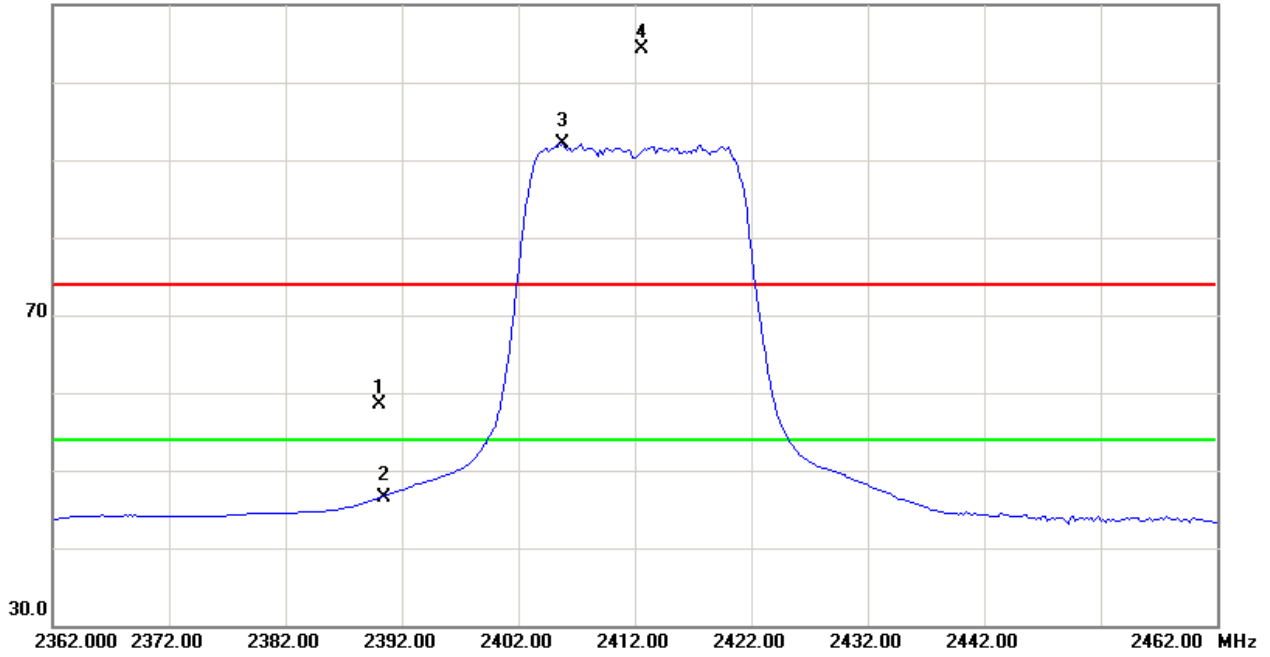

80.0 dBuV/m

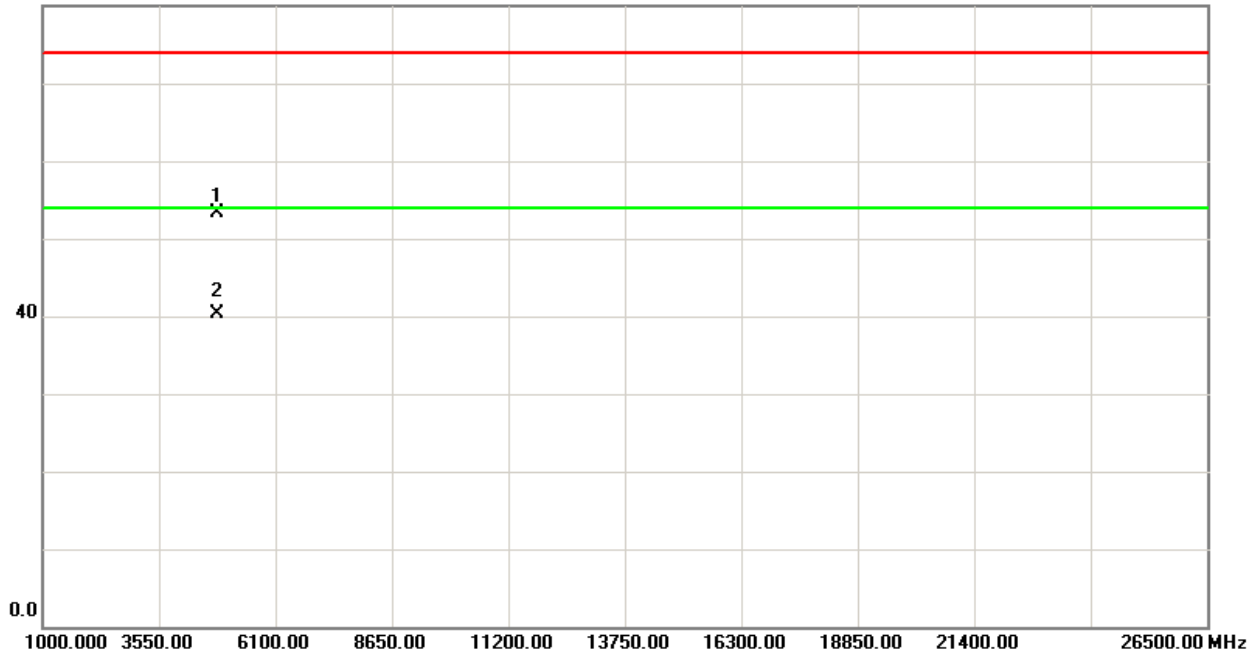



EUT :	Wireless N300 Home Router	Model Name :	W303R
Temperature :	24 °C	Relative Humidity :	51 %
Pressure :	1010 hPa	Test Voltage :	AC 120V/60Hz
Test Mode :	TX N-20M MODE 2412MHz		

Freq.	Ant.Pol.	Reading		Ant./CF	Act.		Limit		Note
		Peak	AV		Peak	AV	Peak	AV	
(MHz)	H/V	(dBuV)	(dBuV)	CF(dB)	(dBuV/m)	(dBuV/m)	(dBuV/m)	(dBuV/m)	
2390.00	H	25.34	13.51	32.28	57.62	45.79	74.00	54.00	X/E
<b>2415.20</b>	<b>H</b>	<b>73.46</b>	<b>59.54</b>	<b>32.25</b>	<b>105.71</b>	<b>91.79</b>			<b>X/F</b>
4823.97	H	43.76	32.73	5.29	49.05	38.02	74.00	54.00	X/H

Remark :

- (1) All readings are Peak unless otherwise stated QP in column of 『Note』 . Peak denotes that the Peak reading compliance with the QP Limits and then QP Mode measurement didn't perform ◦
- (2) Measuring frequency range from 30MHz to 1000MHz or the 10th harmonic of highest fundamental frequency ◦ "F" denotes fundamental frequency; "H" denotes spurious frequency. "E" denotes band edge frequency. (This judgment method includes the Band Edge Requirement.)
- (3) Radiated emissions measured in frequency range above 1000MHz were made with an instrument using Peak detector mode and AV detector mode of the emission ◦
- (4) Data of measurement within this frequency range shown " \* " in the table above means the reading of emissions are attenuated more than 20dB below the permissible limits or the field strength is too small to be measured.
- (5) A preamp and high pass filter were used for this test in order to provide sufficient measurement sensitivity.
- (6) EUT Orthogonal Axis :  
"X" - denotes Laid on Table ; "Y" - denotes Vertical Stand ; "Z" - denotes Side Stand
- (7) During the measurements above 1 GHz it is taken care of that the EUT is always within the 3 dB cone of radiation BW of the used antenna



TX CH01 (Above 1000 MHz, Horizontal)

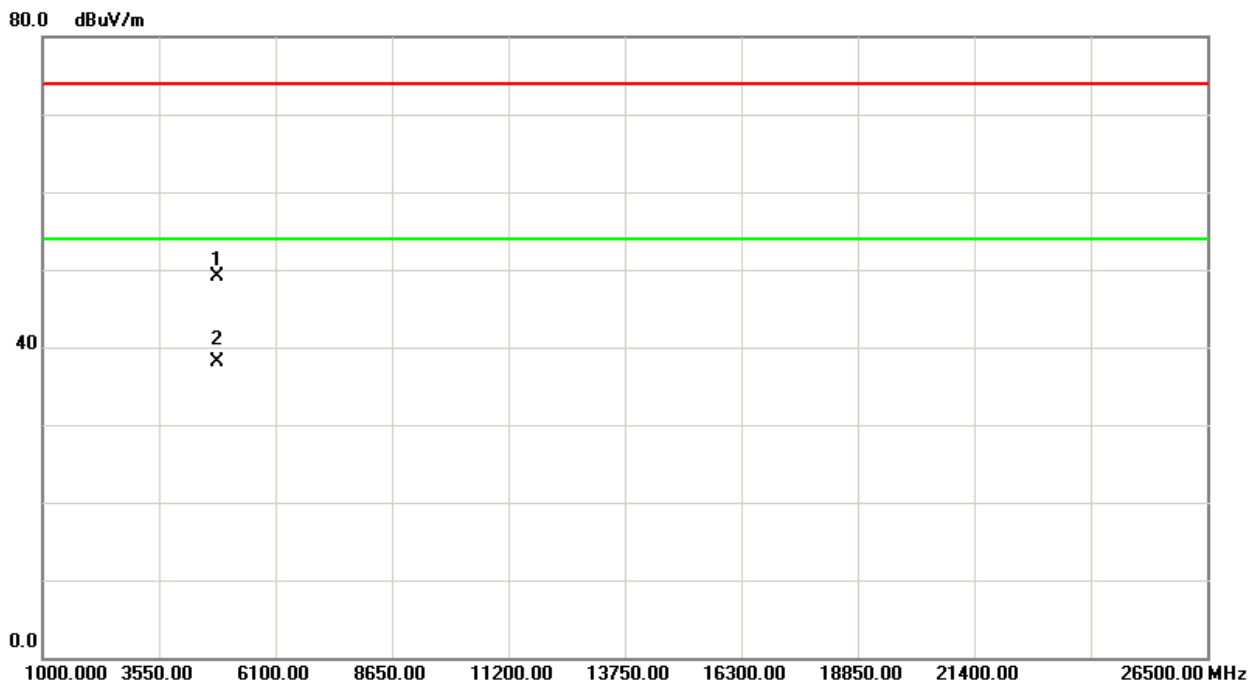
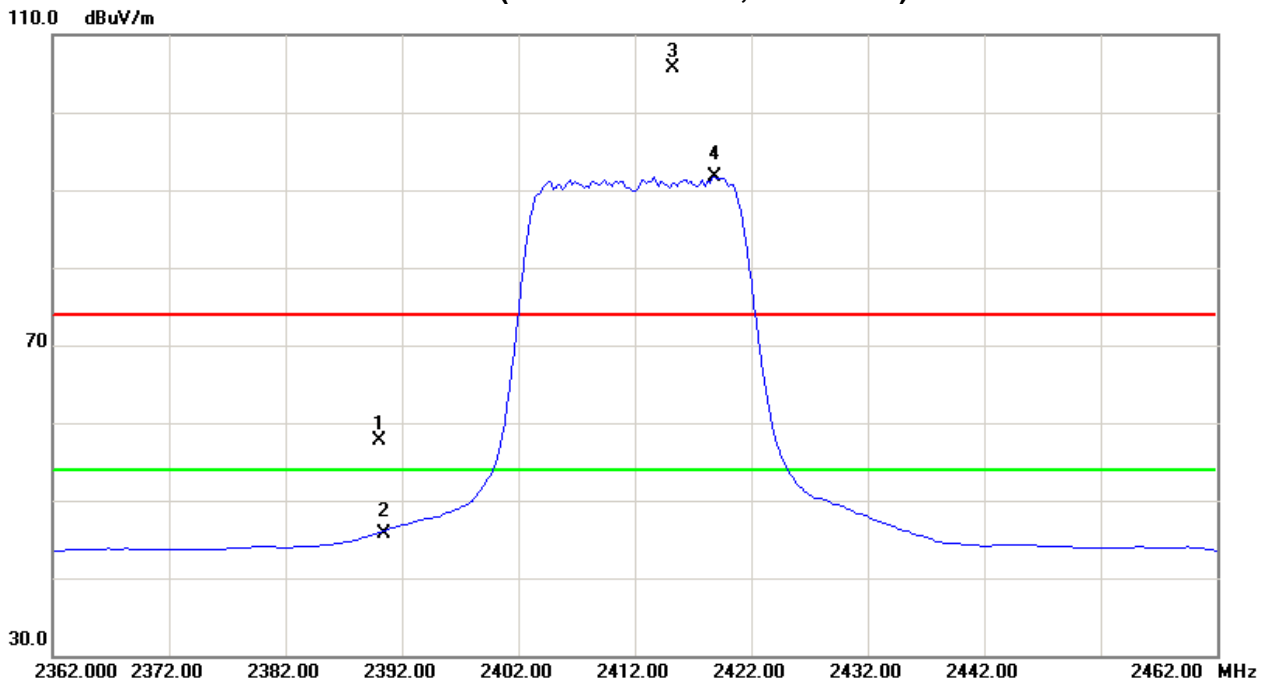



EUT :	Wireless N300 Home Router	Model Name :	W303R
Temperature :	24 °C	Relative Humidity :	51 %
Pressure :	1010 hPa	Test Voltage :	AC 120V/60Hz
Test Mode :	TX N-20M MODE 2437MHz		

Freq.	Ant.Pol.	Reading		Ant./CF	Act.		Limit		Note
		Peak	AV		Peak	AV	Peak	AV	
(MHz)	H/V	(dBuV)	(dBuV)	CF(dB)	(dBuV/m)	(dBuV/m)	(dBuV/m)	(dBuV/m)	
<b>2437.80</b>	<b>V</b>	<b>71.95</b>	<b>59.52</b>	<b>32.22</b>	<b>104.17</b>	<b>91.74</b>			<b>X/F</b>
4874.01	V	47.75	35.02	5.47	53.22	40.49	74.00	54.00	X/H

Remark :

- (1) All readings are Peak unless otherwise stated QP in column of 『Note』 . Peak denotes that the Peak reading compliance with the QP Limits and then QP Mode measurement didn't perform ◦
- (2) Measuring frequency range from 30MHz to 1000MHz or the 10th harmonic of highest fundamental frequency ◦ "F" denotes fundamental frequency; "H" denotes spurious frequency. "E" denotes band edge frequency. (This judgment method includes the Band Edge Requirement.)
- (3) Radiated emissions measured in frequency range above 1000MHz were made with an instrument using Peak detector mode and AV detector mode of the emission ◦
- (4) Data of measurement within this frequency range shown " \* " in the table above means the reading of emissions are attenuated more than 20dB below the permissible limits or the field strength is too small to be measured.
- (5) A preamp and high pass filter were used for this test in order to provide sufficient measurement sensitivity.
- (6) EUT Orthogonal Axis :  
 "X" - denotes Laid on Table ; "Y" - denotes Vertical Stand ; "Z" - denotes Side Stand
- (7) During the measurements above 1 GHz it is taken care of that the EUT is always within the 3 dB cone of radiation BW of the used antenna



TX CH06 (Above 1000 MHz, Vertical)

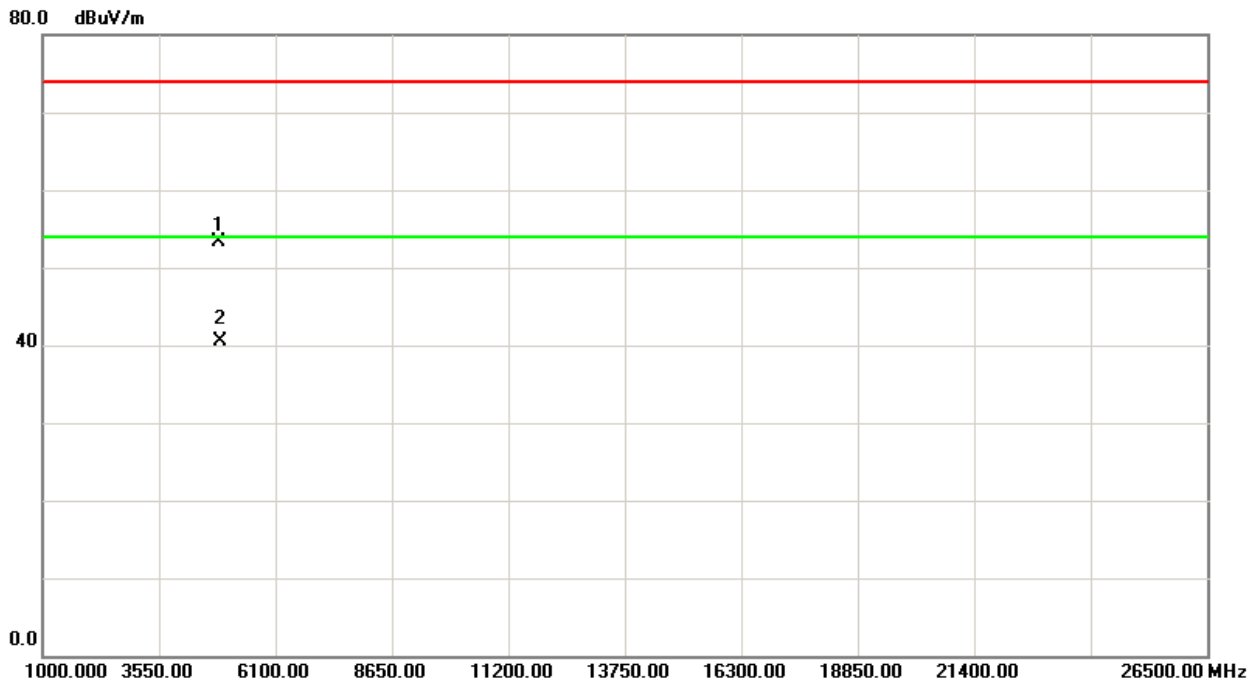
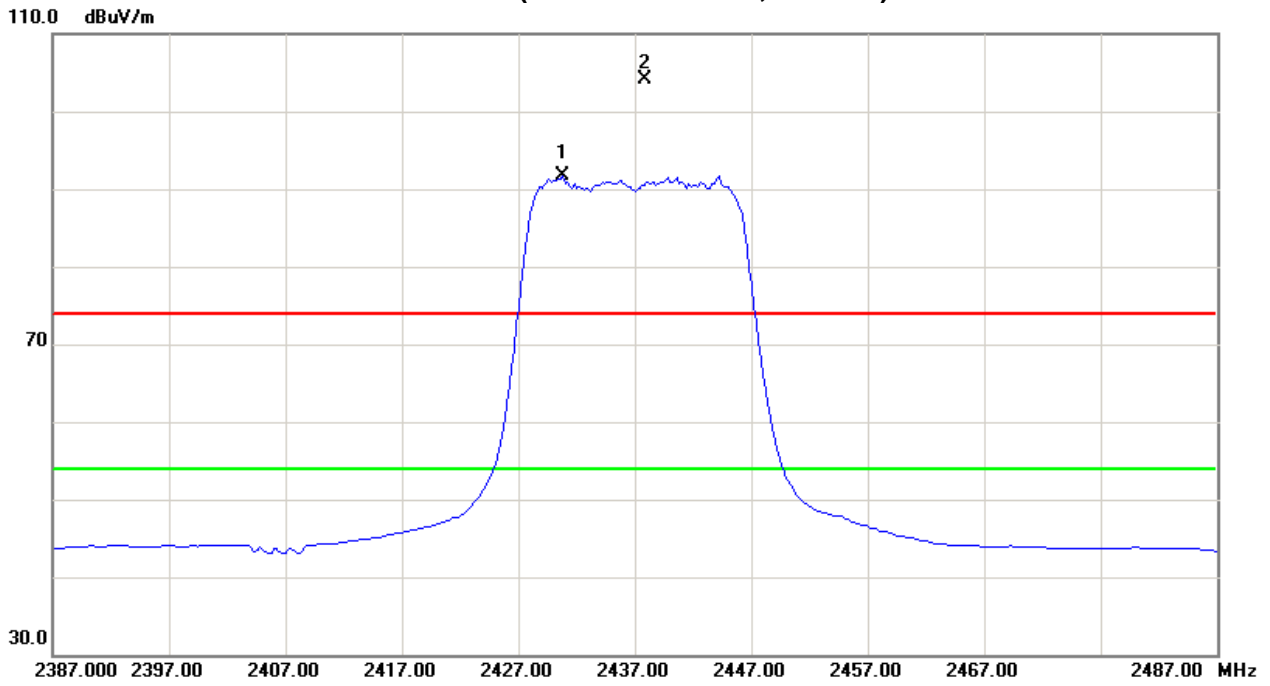



EUT :	Wireless N300 Home Router	Model Name :	W303R
Temperature :	24 °C	Relative Humidity :	51 %
Pressure :	1010 hPa	Test Voltage :	AC 120V/60Hz
Test Mode :	TX N-20M MODE 2437MHz		

Freq.	Ant.Pol.	Reading		Ant./CF	Act.		Limit		Note
		Peak	AV		Peak	AV	Peak	AV	
(MHz)	H/V	(dBuV)	(dBuV)	CF(dB)	(dBuV/m)	(dBuV/m)	(dBuV/m)	(dBuV/m)	
<b>2435.80</b>	<b>H</b>	<b>75.74</b>	<b>61.51</b>	<b>32.23</b>	<b>107.97</b>	<b>93.74</b>			<b>X/F</b>
4873.95	H	48.89	35.89	5.47	54.36	41.36	74.00	54.00	X/H

Remark :

- (1) All readings are Peak unless otherwise stated QP in column of 『Note』 . Peak denotes that the Peak reading compliance with the QP Limits and then QP Mode measurement didn't perform ◦
- (2) Measuring frequency range from 30MHz to 1000MHz or the 10th harmonic of highest fundamental frequency ◦ "F" denotes fundamental frequency; "H" denotes spurious frequency. "E" denotes band edge frequency. (This judgment method includes the Band Edge Requirement.)
- (3) Radiated emissions measured in frequency range above 1000MHz were made with an instrument using Peak detector mode and AV detector mode of the emission ◦
- (4) Data of measurement within this frequency range shown " \* " in the table above means the reading of emissions are attenuated more than 20dB below the permissible limits or the field strength is too small to be measured.
- (5) A preamp and high pass filter were used for this test in order to provide sufficient measurement sensitivity.
- (6) EUT Orthogonal Axis :  
 "X" - denotes Laid on Table ; "Y" - denotes Vertical Stand ; "Z" - denotes Side Stand
- (7) During the measurements above 1 GHz it is taken care of that the EUT is always within the 3 dB cone of radiation BW of the used antenna



TX CH06 (Above 1000 MHz, Horizontal)

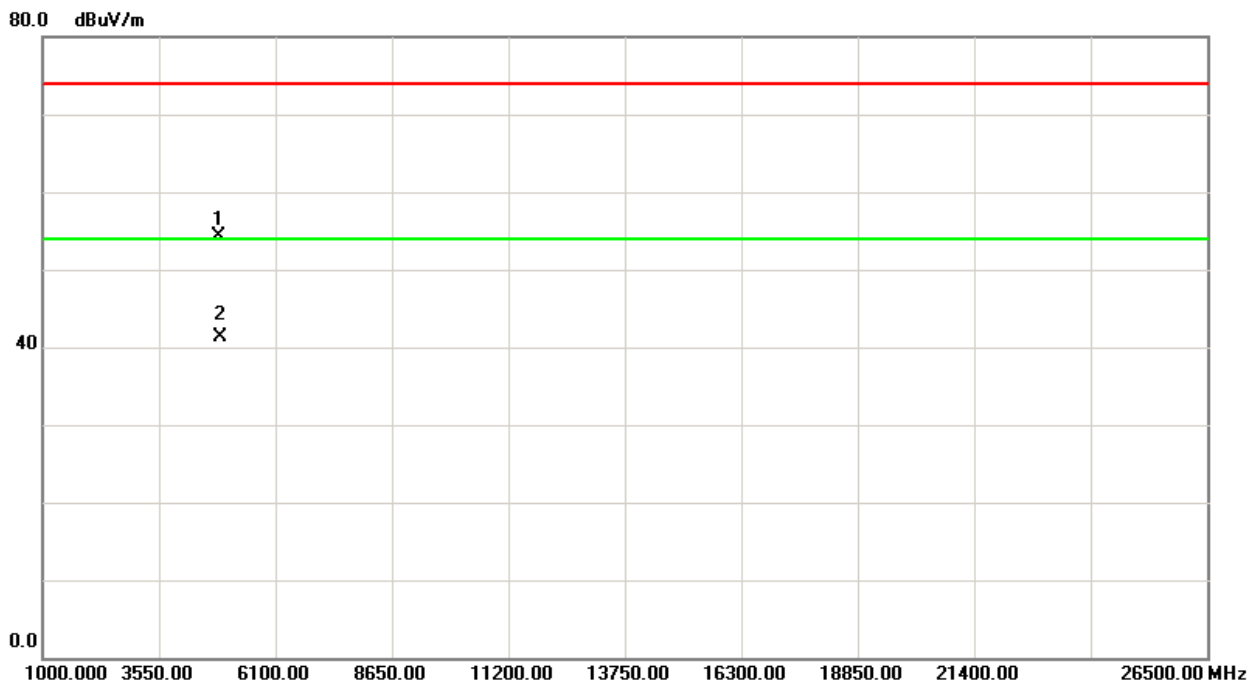
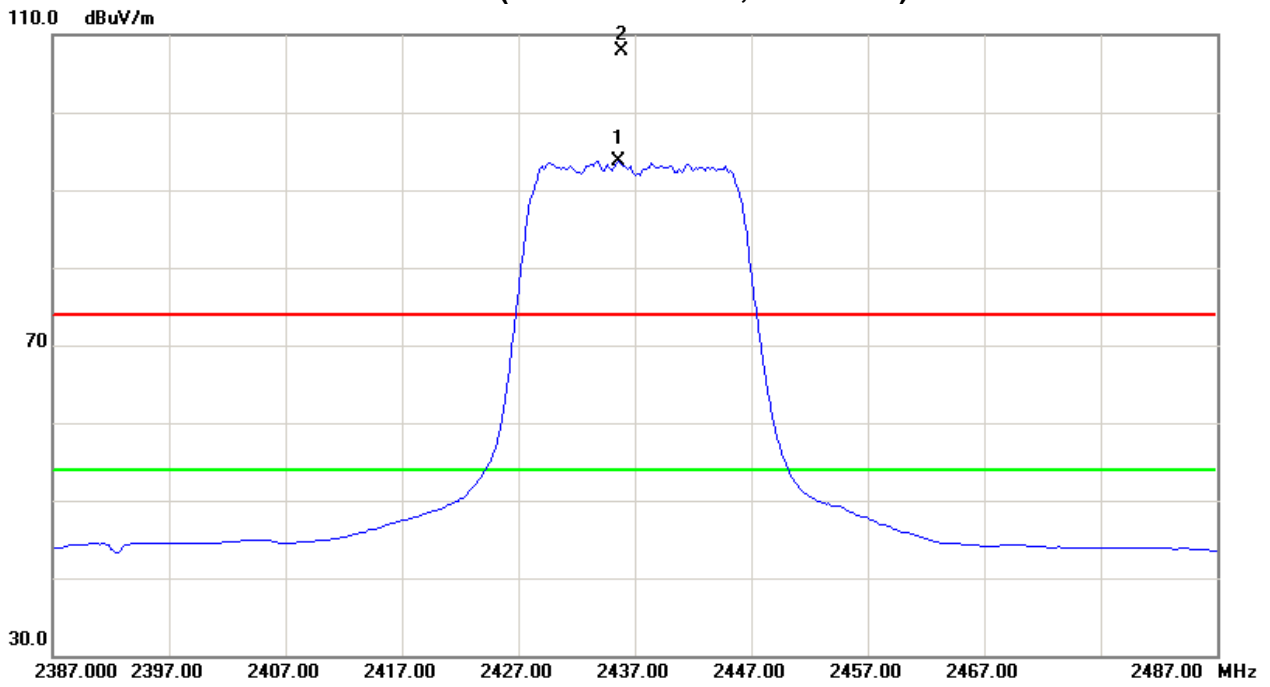



## Neutron Engineering Inc.

EUT :	Wireless N300 Home Router	Model Name :	W303R
Temperature :	24 °C	Relative Humidity :	51 %
Pressure :	1010 hPa	Test Voltage :	AC 120V/60Hz
Test Mode :	TX N-20M MODE 2462MHz		

Freq.	Ant.Pol.	Reading		Ant./CF	Act.		Limit		Note
		Peak	AV		Peak	AV	Peak	AV	
(MHz)	H/V	(dBuV)	(dBuV)	CF(dB)	(dBuV/m)	(dBuV/m)	(dBuV/m)	(dBuV/m)	
<b>2462.80</b>	<b>V</b>	<b>72.06</b>	<b>59.19</b>	<b>32.20</b>	<b>104.26</b>	<b>91.39</b>			<b>X/F</b>
2483.50	V	25.34	13.30	32.17	57.51	45.47	74.00	54.00	X/E
4924.10	V	47.52	35.80	5.65	53.17	41.45	74.00	54.00	X/H

### Remark :

- (1) All readings are Peak unless otherwise stated QP in column of 『Note』 . Peak denotes that the Peak reading compliance with the QP Limits and then QP Mode measurement didn't perform ◦
- (2) Measuring frequency range from 30MHz to 1000MHz or the 10th harmonic of highest fundamental frequency ◦ "F" denotes fundamental frequency; "H" denotes spurious frequency. "E" denotes band edge frequency. (This judgment method includes the Band Edge Requirement.)
- (3) Radiated emissions measured in frequency range above 1000MHz were made with an instrument using Peak detector mode and AV detector mode of the emission ◦
- (4) Data of measurement within this frequency range shown " \* " in the table above means the reading of emissions are attenuated more than 20dB below the permissible limits or the field strength is too small to be measured.
- (5) A preamp and high pass filter were used for this test in order to provide sufficient measurement sensitivity.
- (6) EUT Orthogonal Axis :  
"X" - denotes Laid on Table ; "Y" - denotes Vertical Stand ; "Z" - denotes Side Stand
- (7) During the measurements above 1 GHz it is taken care of that the EUT is always within the 3 dB cone of radiation BW of the used antenna





TX CH11 (Above 1000 MHz, Vertical)

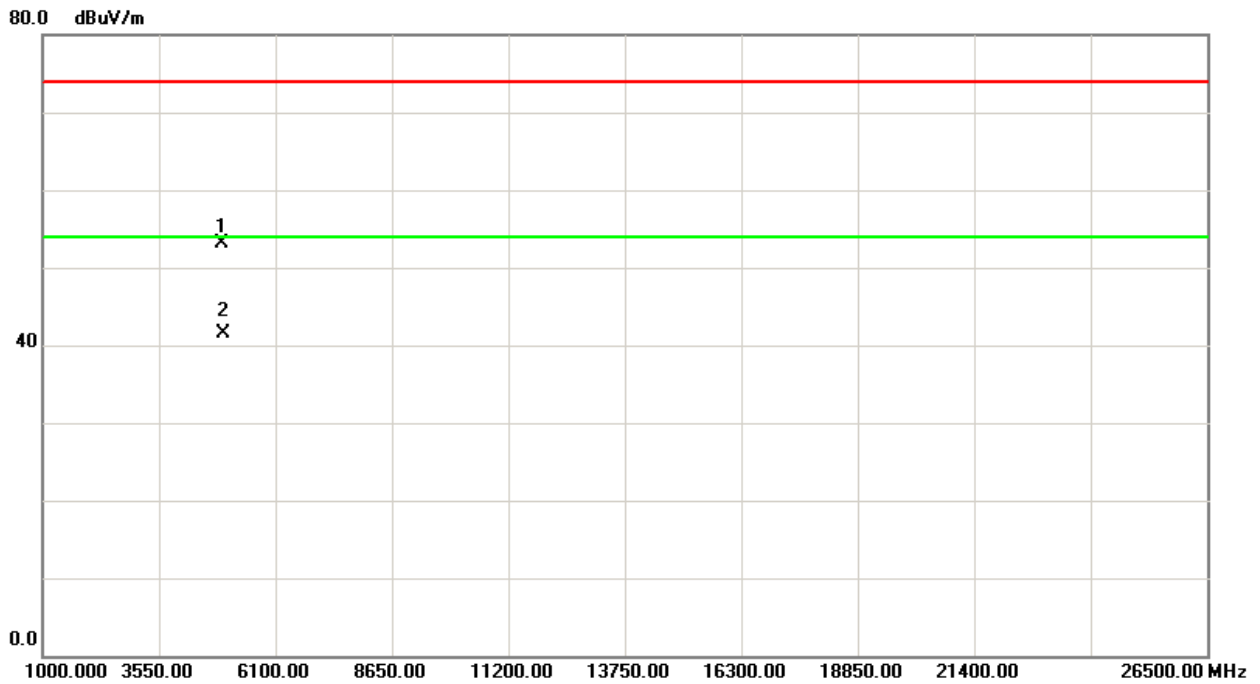
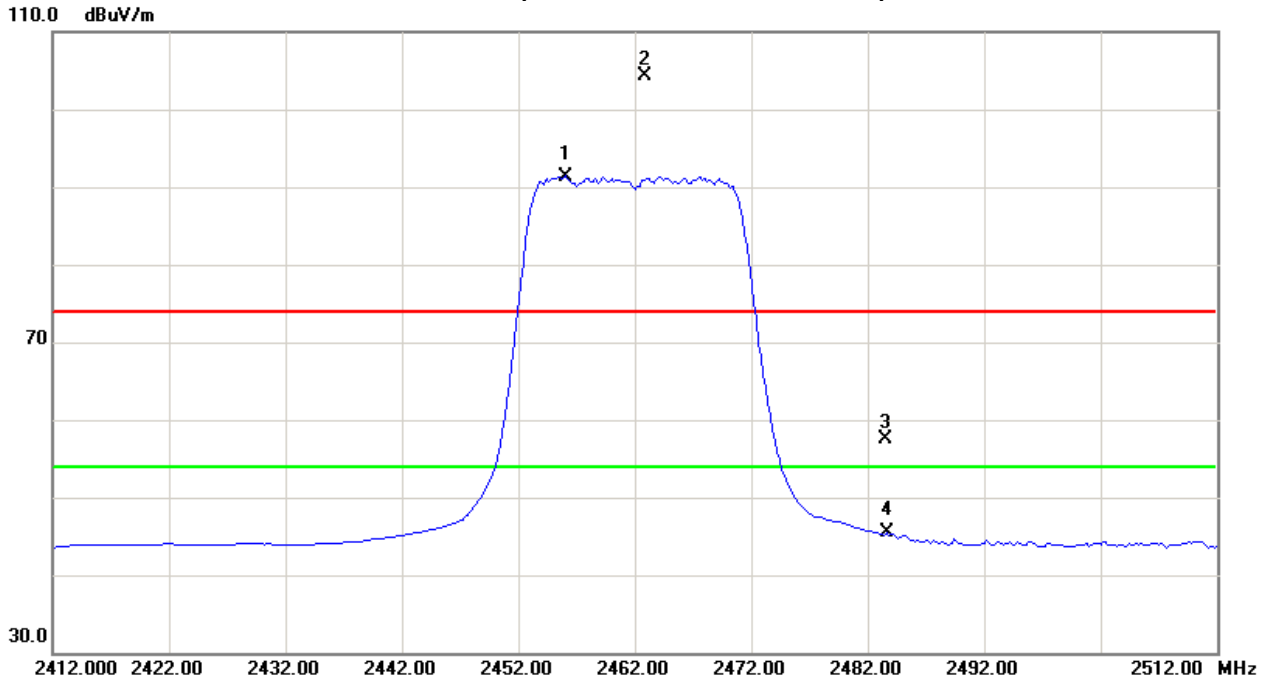



EUT :	Wireless N300 Home Router	Model Name :	W303R
Temperature :	24 °C	Relative Humidity :	51 %
Pressure :	1010 hPa	Test Voltage :	AC 120V/60Hz
Test Mode :	TX N-20M MODE 2462MHz		

Freq.	Ant.Pol.	Reading		Ant./CF	Act.		Limit		Note
		Peak	AV		Peak	AV	Peak	AV	
(MHz)	H/V	(dBuV)	(dBuV)	CF(dB)	(dBuV/m)	(dBuV/m)	(dBuV/m)	(dBuV/m)	
<b>2460.60</b>	<b>H</b>	<b>74.54</b>	<b>60.82</b>	<b>32.20</b>	<b>106.74</b>	<b>93.02</b>			<b>X/F</b>
2483.50	H	24.98	13.11	32.17	57.15	45.28	74.00	54.00	X/E
4924.03	H	46.86	33.45	5.65	52.51	39.10	74.00	54.00	X/H

Remark :

- (1) All readings are Peak unless otherwise stated QP in column of 『Note』 . Peak denotes that the Peak reading compliance with the QP Limits and then QP Mode measurement didn't perform ◦
- (2) Measuring frequency range from 30MHz to 1000MHz or the 10th harmonic of highest fundamental frequency ◦ "F" denotes fundamental frequency; "H" denotes spurious frequency. "E" denotes band edge frequency. (This judgment method includes the Band Edge Requirement.)
- (3) Radiated emissions measured in frequency range above 1000MHz were made with an instrument using Peak detector mode and AV detector mode of the emission ◦
- (4) Data of measurement within this frequency range shown " \* " in the table above means the reading of emissions are attenuated more than 20dB below the permissible limits or the field strength is too small to be measured.
- (5) A preamp and high pass filter were used for this test in order to provide sufficient measurement sensitivity.
- (6) EUT Orthogonal Axis :  
"X" - denotes Laid on Table ; "Y" - denotes Vertical Stand ; "Z" - denotes Side Stand
- (7) During the measurements above 1 GHz it is taken care of that the EUT is always within the 3 dB cone of radiation BW of the used antenna



TX CH11 (Above 1000 MHz, Horizontal)

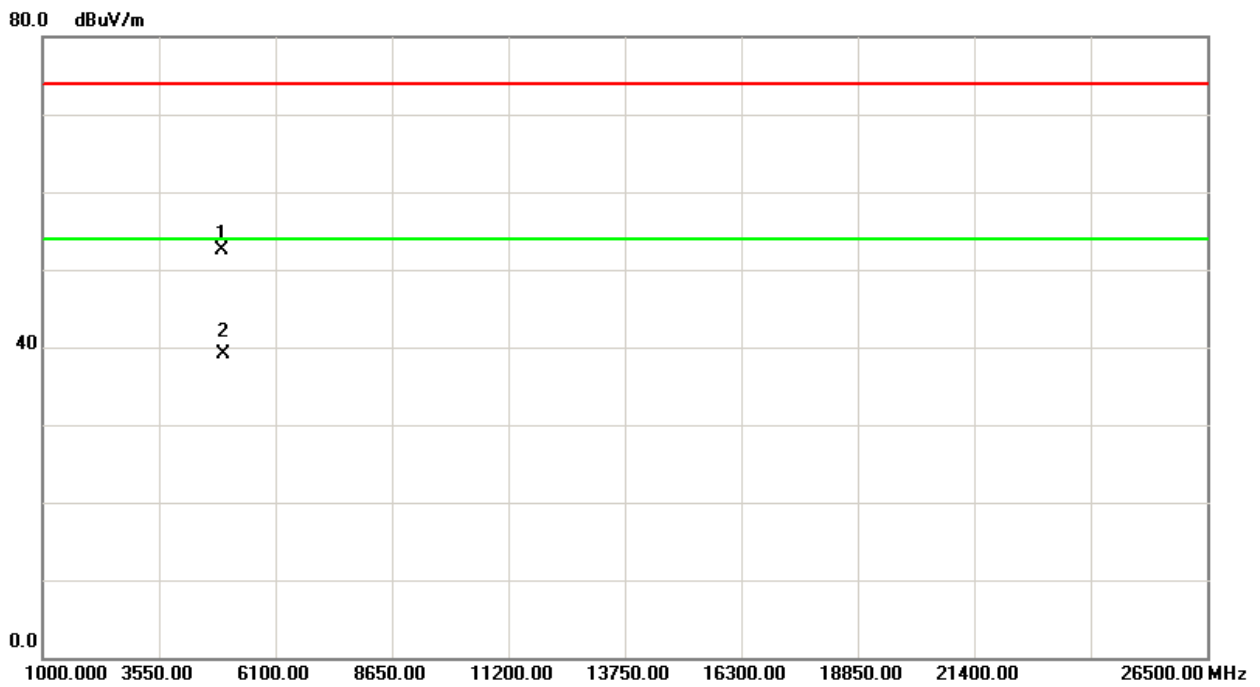
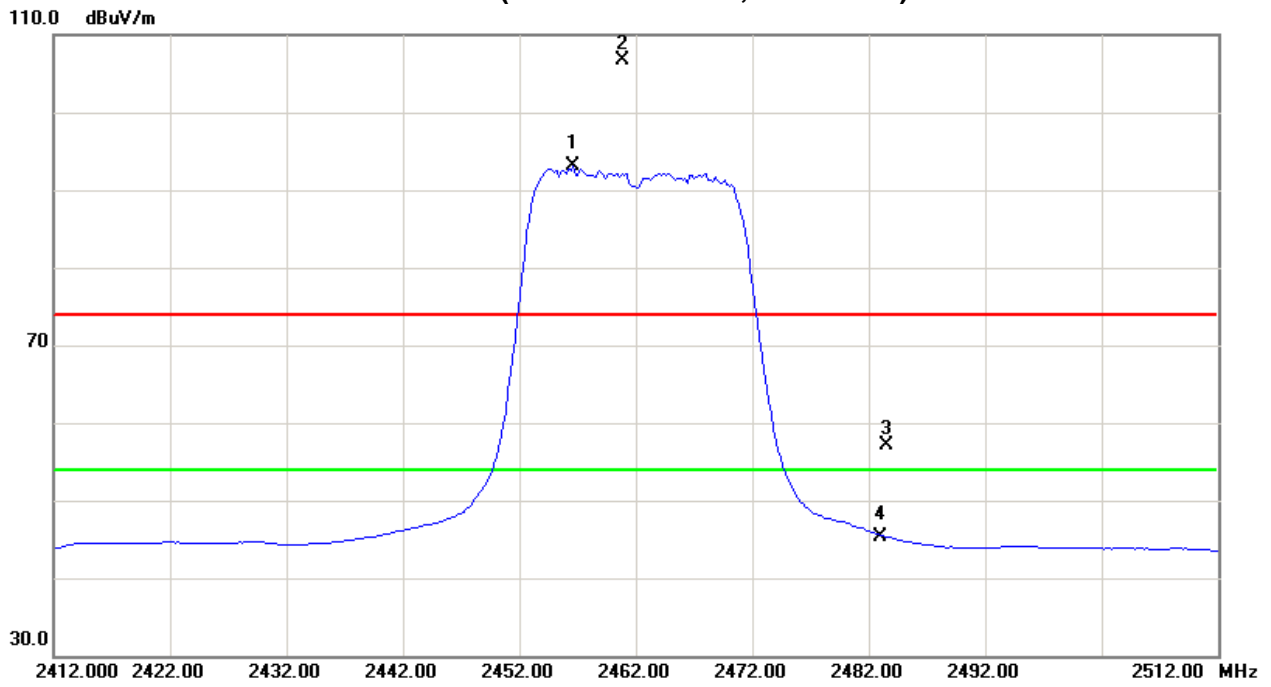



EUT :	Wireless N300 Home Router	Model Name :	W303R
Temperature :	24 °C	Relative Humidity :	51 %
Pressure :	1010 hPa	Test Voltage :	AC 120V/60Hz
Test Mode :	TX N-40M MODE 2422MHz		

Freq.	Ant.Pol.	Reading		Ant./CF	Act.		Limit		Note
		Peak	AV		Peak	AV	Peak	AV	
(MHz)	H/V	(dBuV)	(dBuV)	CF(dB)	(dBuV/m)	(dBuV/m)	(dBuV/m)	(dBuV/m)	
2390.00	V	28.13	14.82	32.28	60.41	47.10	74.00	54.00	X/E
<b>2424.80</b>	<b>V</b>	<b>68.65</b>	<b>55.39</b>	<b>32.24</b>	<b>100.89</b>	<b>87.63</b>			<b>X/F</b>
4844.10	V	47.72	34.79	5.36	53.08	40.15	74.00	54.00	X/H

Remark :

- (1) All readings are Peak unless otherwise stated QP in column of 『Note』 . Peak denotes that the Peak reading compliance with the QP Limits and then QP Mode measurement didn't perform ◦
- (2) Measuring frequency range from 30MHz to 1000MHz or the 10th harmonic of highest fundamental frequency ◦ "F" denotes fundamental frequency; "H" denotes spurious frequency. "E" denotes band edge frequency. (This judgment method includes the Band Edge Requirement.)
- (3) Radiated emissions measured in frequency range above 1000MHz were made with an instrument using Peak detector mode and AV detector mode of the emission ◦
- (4) Data of measurement within this frequency range shown " \* " in the table above means the reading of emissions are attenuated more than 20dB below the permissible limits or the field strength is too small to be measured.
- (5) A preamp and high pass filter were used for this test in order to provide sufficient measurement sensitivity.
- (6) EUT Orthogonal Axis :  
"X" - denotes Laid on Table ; "Y" - denotes Vertical Stand ; "Z" - denotes Side Stand
- (7) During the measurements above 1 GHz it is taken care of that the EUT is always within the 3 dB cone of radiation BW of the used antenna



TX CH03 (Above 1000 MHz, Vertical)

110.0 dBuV/m

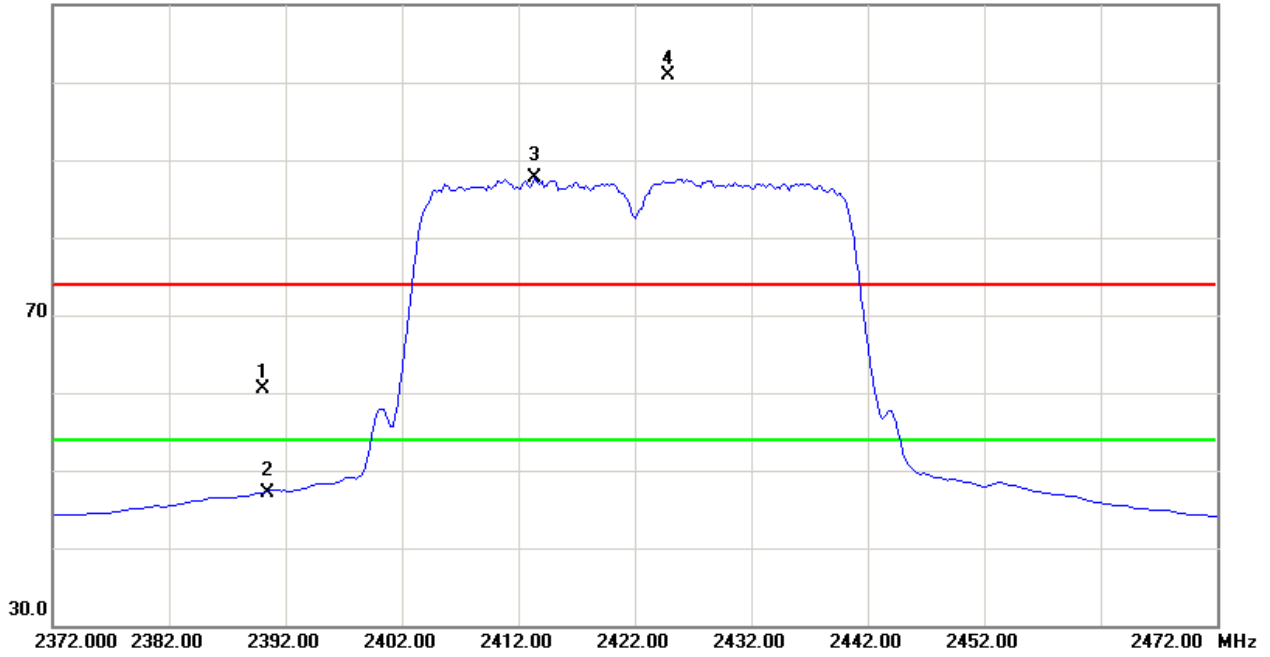

80.0 dBuV/m

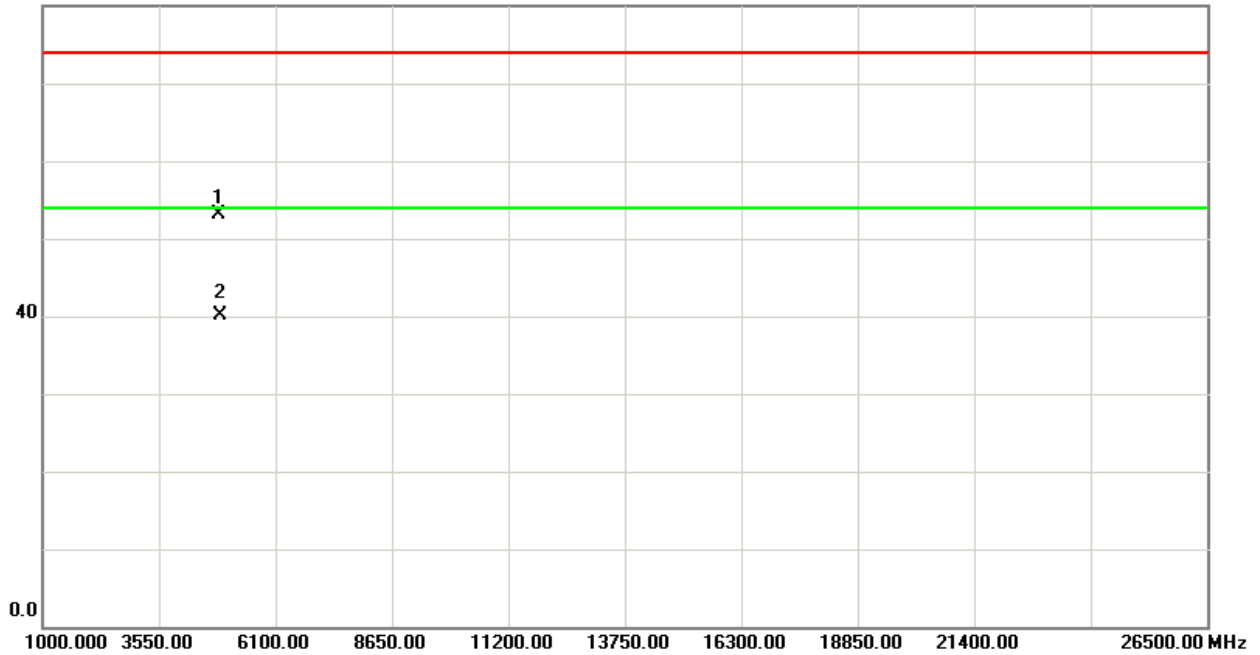



EUT :	Wireless N300 Home Router	Model Name :	W303R
Temperature :	24 °C	Relative Humidity :	51 %
Pressure :	1010 hPa	Test Voltage :	AC 120V/60Hz
Test Mode :	TX N-40M MODE 2422MHz		

Freq.	Ant.Pol.	Reading		Ant./CF	Act.		Limit		Note
		Peak	AV		Peak	AV	Peak	AV	
(MHz)	H/V	(dBuV)	(dBuV)	CF(dB)	(dBuV/m)	(dBuV/m)	(dBuV/m)	(dBuV/m)	
2390.00	H	28.54	15.10	32.28	60.82	47.38	74.00	54.00	X/E
<b>2415.60</b>	<b>H</b>	<b>70.80</b>	<b>56.66</b>	<b>32.25</b>	<b>103.05</b>	<b>88.91</b>			<b>X/F</b>
4844.10	H	44.72	32.68	5.36	50.08	38.04	74.00	54.00	X/H

Remark :

- (1) All readings are Peak unless otherwise stated QP in column of 『Note』 . Peak denotes that the Peak reading compliance with the QP Limits and then QP Mode measurement didn't perform ◦
- (2) Measuring frequency range from 30MHz to 1000MHz or the 10th harmonic of highest fundamental frequency ◦ "F" denotes fundamental frequency; "H" denotes spurious frequency. "E" denotes band edge frequency. (This judgment method includes the Band Edge Requirement.)
- (3) Radiated emissions measured in frequency range above 1000MHz were made with an instrument using Peak detector mode and AV detector mode of the emission ◦
- (4) Data of measurement within this frequency range shown " \* " in the table above means the reading of emissions are attenuated more than 20dB below the permissible limits or the field strength is too small to be measured.
- (5) A preamp and high pass filter were used for this test in order to provide sufficient measurement sensitivity.
- (6) EUT Orthogonal Axis :  
"X" - denotes Laid on Table ; "Y" - denotes Vertical Stand ; "Z" - denotes Side Stand
- (7) During the measurements above 1 GHz it is taken care of that the EUT is always within the 3 dB cone of radiation BW of the used antenna



TX CH03 (Above 1000 MHz, Horizontal)

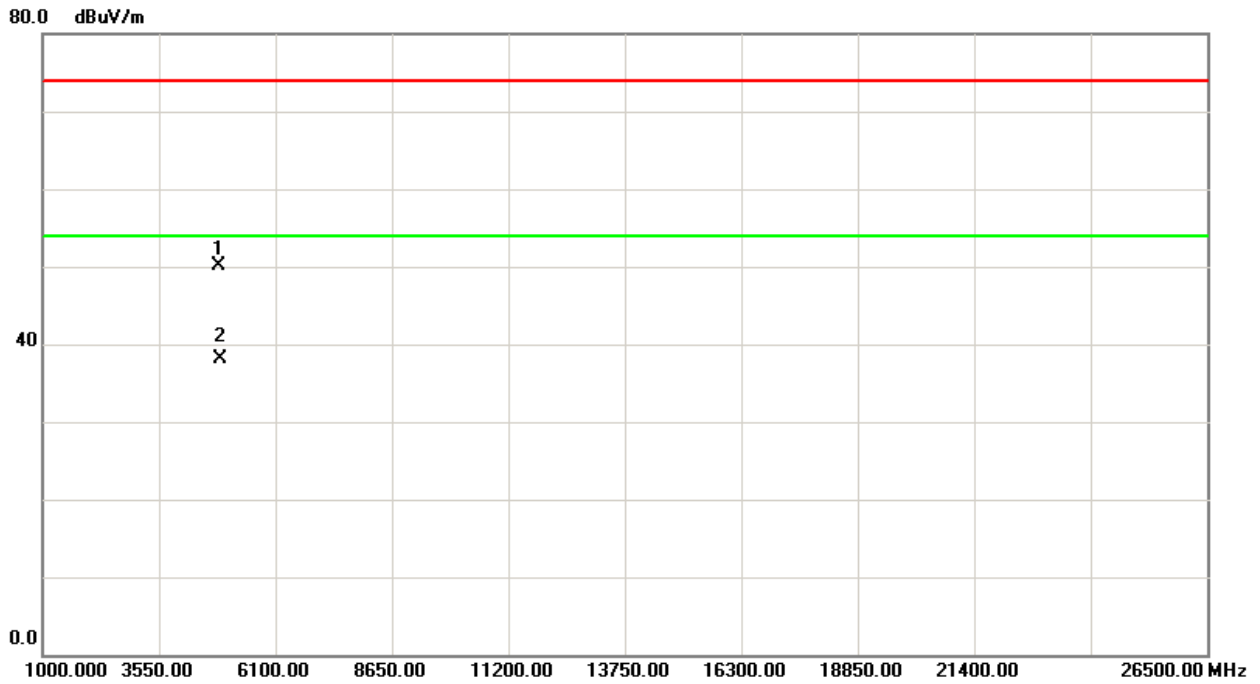
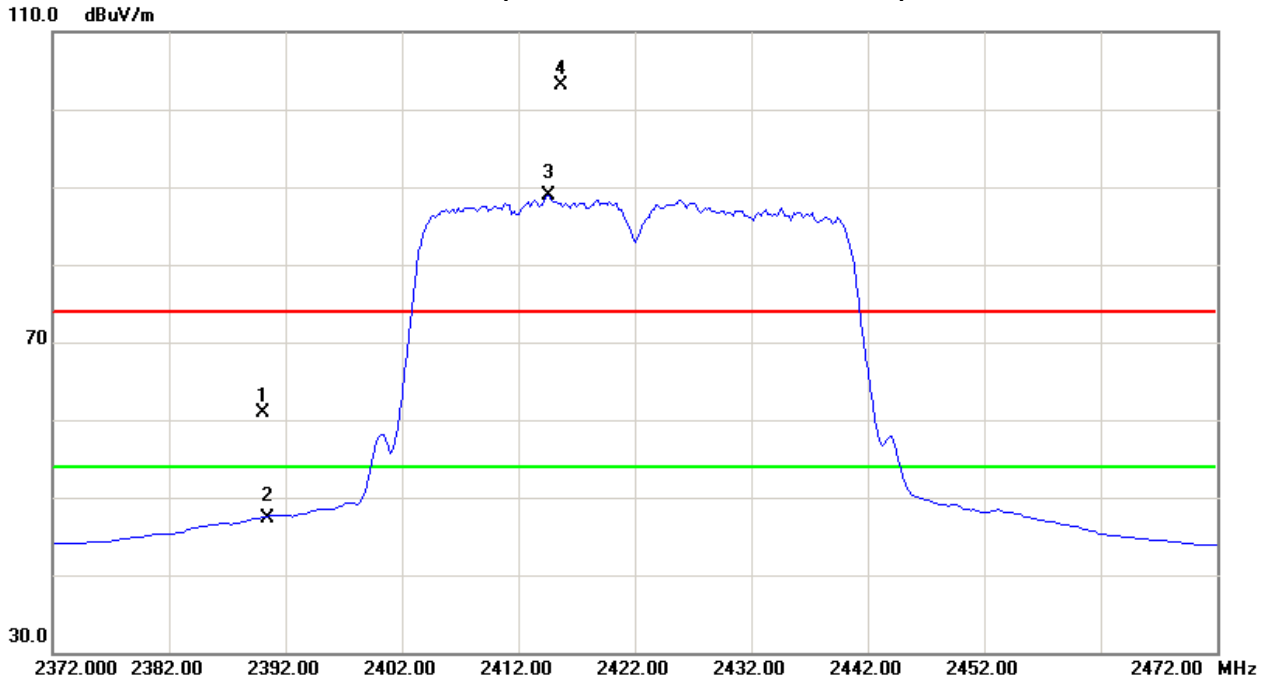



EUT :	Wireless N300 Home Router	Model Name :	W303R
Temperature :	24 °C	Relative Humidity :	51 %
Pressure :	1010 hPa	Test Voltage :	AC 120V/60Hz
Test Mode :	TX N-40M MODE 2437MHz		

Freq.	Ant.Pol.	Reading		Ant./CF	Act.		Limit		Note
		Peak	AV		Peak	AV	Peak	AV	
(MHz)	H/V	(dBuV)	(dBuV)	CF(dB)	(dBuV/m)	(dBuV/m)	(dBuV/m)	(dBuV/m)	
<b>2426.00</b>	<b>V</b>	<b>68.96</b>	<b>55.18</b>	<b>32.24</b>	<b>101.20</b>	<b>87.42</b>			<b>X/F</b>
4873.99	V	47.98	34.29	5.47	53.45	39.76	74.00	54.00	X/H

Remark :

- (1) All readings are Peak unless otherwise stated QP in column of 『Note』 . Peak denotes that the Peak reading compliance with the QP Limits and then QP Mode measurement didn't perform ◦
- (2) Measuring frequency range from 30MHz to 1000MHz or the 10th harmonic of highest fundamental frequency ◦ "F" denotes fundamental frequency; "H" denotes spurious frequency. "E" denotes band edge frequency. (This judgment method includes the Band Edge Requirement.)
- (3) Radiated emissions measured in frequency range above 1000MHz were made with an instrument using Peak detector mode and AV detector mode of the emission ◦
- (4) Data of measurement within this frequency range shown " \* " in the table above means the reading of emissions are attenuated more than 20dB below the permissible limits or the field strength is too small to be measured.
- (5) A preamp and high pass filter were used for this test in order to provide sufficient measurement sensitivity.
- (6) EUT Orthogonal Axis :  
 "X" - denotes Laid on Table ; "Y" - denotes Vertical Stand ; "Z" - denotes Side Stand
- (7) During the measurements above 1 GHz it is taken care of that the EUT is always within the 3 dB cone of radiation BW of the used antenna





TX CH06 (Above 1000 MHz, Vertical)

110.0 dBuV/m

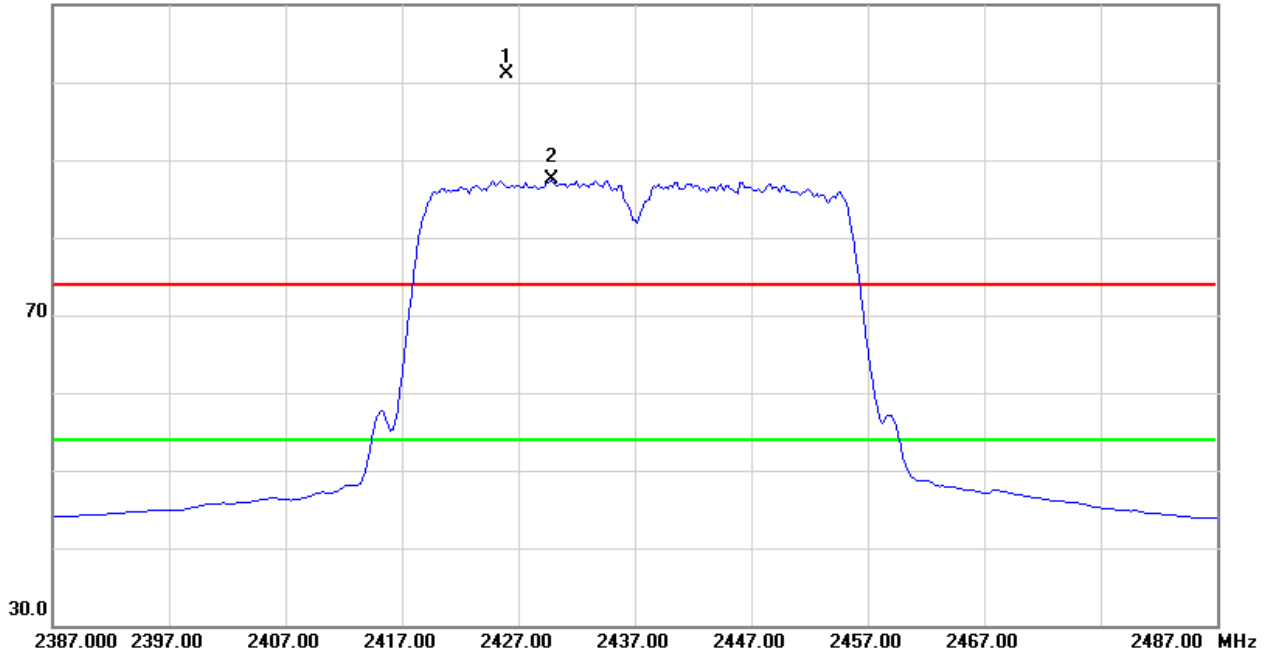

80.0 dBuV/m

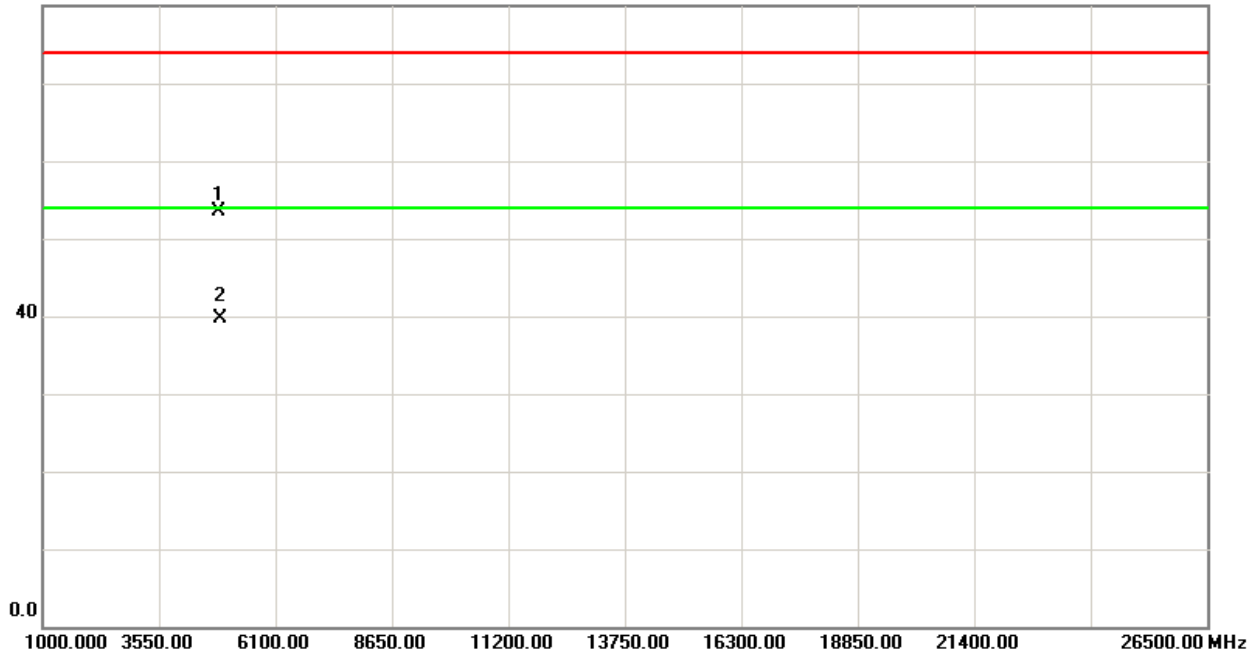



EUT :	Wireless N300 Home Router	Model Name :	W303R
Temperature :	24 °C	Relative Humidity :	51 %
Pressure :	1010 hPa	Test Voltage :	AC 120V/60Hz
Test Mode :	TX N-40M MODE 2437MHz		

Freq.	Ant.Pol.	Reading		Ant./CF	Act.		Limit		Note
		Peak	AV		Peak	AV	Peak	AV	
(MHz)	H/V	(dBuV)	(dBuV)	CF(dB)	(dBuV/m)	(dBuV/m)	(dBuV/m)	(dBuV/m)	
<b>2425.80</b>	<b>H</b>	<b>70.24</b>	<b>56.15</b>	<b>32.24</b>	<b>102.48</b>	<b>88.39</b>			<b>X/F</b>
4873.96	H	45.86	33.11	5.47	51.33	38.58	74.00	54.00	X/H

Remark :

- (1) All readings are Peak unless otherwise stated QP in column of 『Note』 . Peak denotes that the Peak reading compliance with the QP Limits and then QP Mode measurement didn't perform ◦
- (2) Measuring frequency range from 30MHz to 1000MHz or the 10th harmonic of highest fundamental frequency ◦ "F" denotes fundamental frequency; "H" denotes spurious frequency. "E" denotes band edge frequency. (This judgment method includes the Band Edge Requirement.)
- (3) Radiated emissions measured in frequency range above 1000MHz were made with an instrument using Peak detector mode and AV detector mode of the emission ◦
- (4) Data of measurement within this frequency range shown " \* " in the table above means the reading of emissions are attenuated more than 20dB below the permissible limits or the field strength is too small to be measured.
- (5) A preamp and high pass filter were used for this test in order to provide sufficient measurement sensitivity.
- (6) EUT Orthogonal Axis :  
 "X" - denotes Laid on Table ; "Y" - denotes Vertical Stand ; "Z" - denotes Side Stand
- (7) During the measurements above 1 GHz it is taken care of that the EUT is always within the 3 dB cone of radiation BW of the used antenna



TX CH06 (Above 1000 MHz, Horizontal)

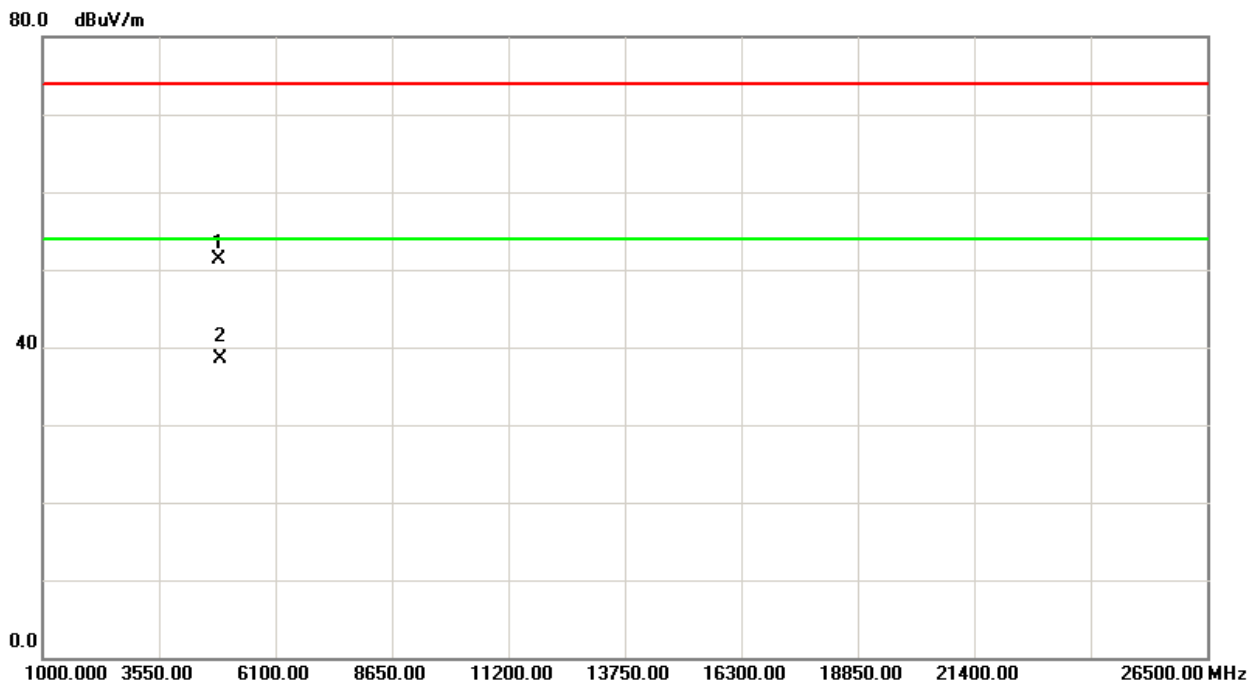
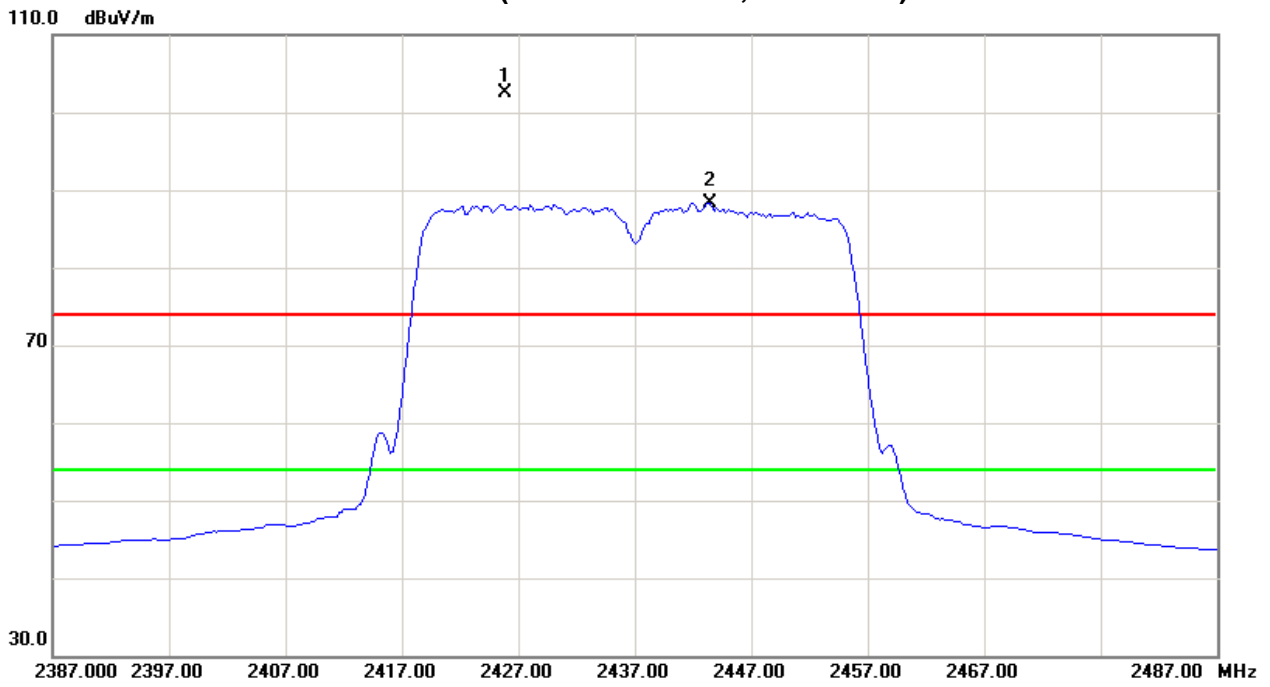



## Neutron Engineering Inc.

EUT :	Wireless N300 Home Router	Model Name :	W303R
Temperature :	24 °C	Relative Humidity :	51 %
Pressure :	1010 hPa	Test Voltage :	AC 120V/60Hz
Test Mode :	TX N-40M MODE 2452MHz		

Freq.	Ant.Pol.	Reading		Ant./CF	Act.		Limit		Note
		Peak	AV		Peak	AV	Peak	AV	
(MHz)	H/V	(dBuV)	(dBuV)	CF(dB)	(dBuV/m)	(dBuV/m)	(dBuV/m)	(dBuV/m)	
<b>2445.60</b>	<b>V</b>	<b>68.93</b>	<b>56.07</b>	<b>32.22</b>	<b>101.15</b>	<b>88.29</b>			<b>X/F</b>
2483.50	V	26.08	14.35	32.17	58.25	46.52	74.00	54.00	X/E
4904.10	V	46.53	32.86	5.58	52.11	38.44	74.00	54.00	X/H

### Remark :

- (1) All readings are Peak unless otherwise stated QP in column of 『Note』 . Peak denotes that the Peak reading compliance with the QP Limits and then QP Mode measurement didn't perform ◦
- (2) Measuring frequency range from 30MHz to 1000MHz or the 10th harmonic of highest fundamental frequency ◦ "F" denotes fundamental frequency; "H" denotes spurious frequency. "E" denotes band edge frequency. (This judgment method includes the Band Edge Requirement.)
- (3) Radiated emissions measured in frequency range above 1000MHz were made with an instrument using Peak detector mode and AV detector mode of the emission ◦
- (4) Data of measurement within this frequency range shown " \* " in the table above means the reading of emissions are attenuated more than 20dB below the permissible limits or the field strength is too small to be measured.
- (5) A preamp and high pass filter were used for this test in order to provide sufficient measurement sensitivity.
- (6) EUT Orthogonal Axis :  
"X" - denotes Laid on Table ; "Y" - denotes Vertical Stand ; "Z" - denotes Side Stand
- (7) During the measurements above 1 GHz it is taken care of that the EUT is always within the 3 dB cone of radiation BW of the used antenna



TX CH09 (Above 1000 MHz, Vertical)

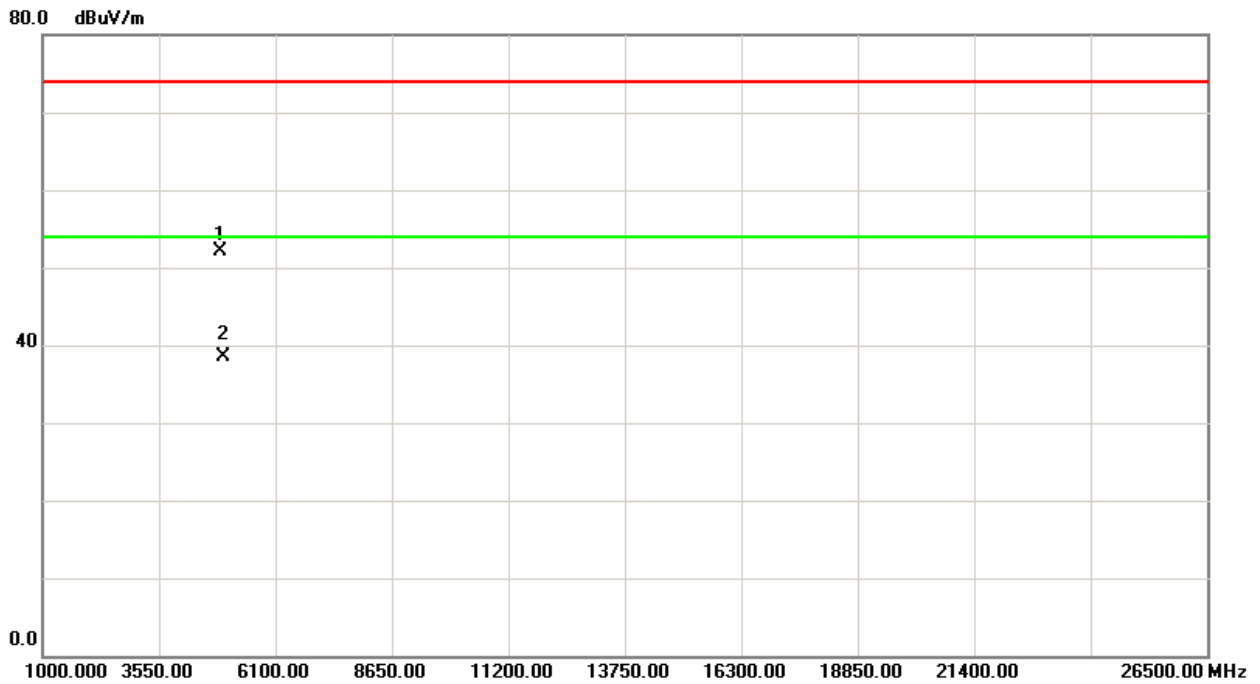
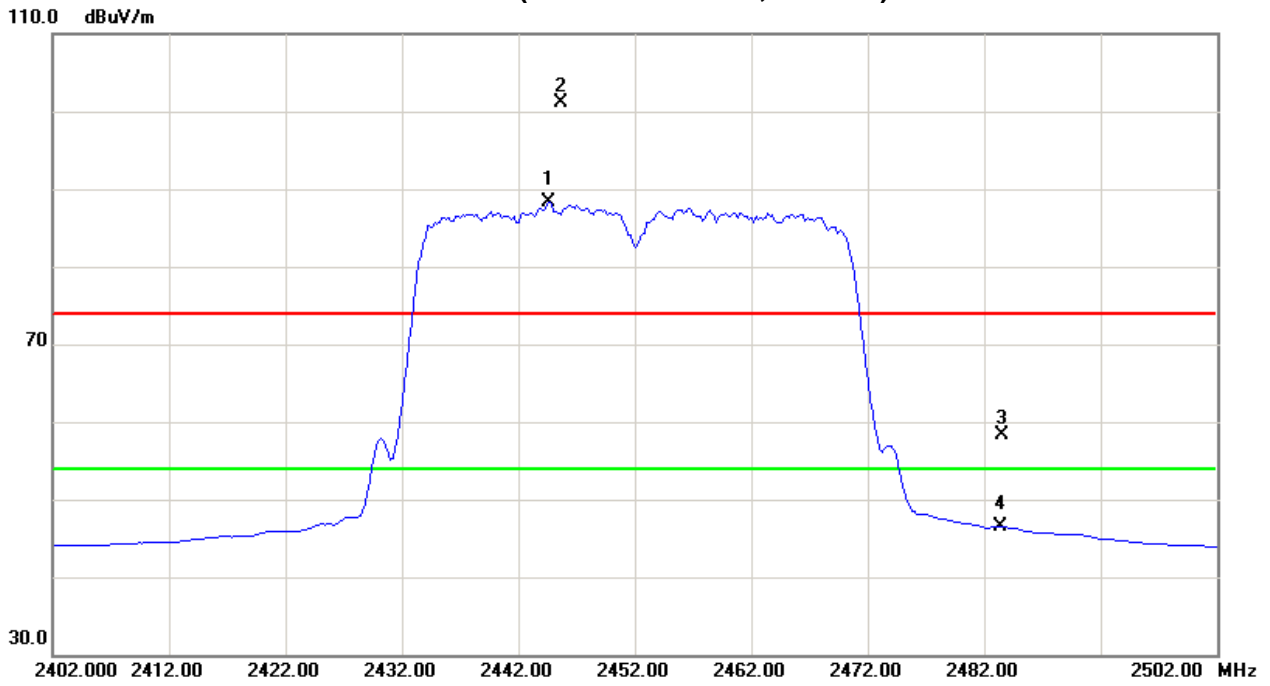



EUT :	Wireless N300 Home Router	Model Name :	W303R
Temperature :	24 °C	Relative Humidity :	51 %
Pressure :	1010 hPa	Test Voltage :	AC 120V/60Hz
Test Mode :	TX N-40M MODE 2452MHz		

Freq.	Ant.Pol.	Reading		Ant./CF	Act.		Limit		Note
		Peak	AV		Peak	AV	Peak	AV	
(MHz)	H/V	(dBuV)	(dBuV)	CF(dB)	(dBuV/m)	(dBuV/m)	(dBuV/m)	(dBuV/m)	
<b>2447.80</b>	<b>H</b>	<b>72.09</b>	<b>56.37</b>	<b>32.21</b>	<b>104.30</b>	<b>88.58</b>			<b>X/F</b>
2483.50	H	28.11	14.89	32.17	60.28	47.06	74.00	54.00	X/E
4903.84	H	42.24	30.32	5.58	47.82	35.90	74.00	54.00	X/H

Remark :

- (1) All readings are Peak unless otherwise stated QP in column of 『Note』 . Peak denotes that the Peak reading compliance with the QP Limits and then QP Mode measurement didn't perform ◦
- (2) Measuring frequency range from 30MHz to 1000MHz or the 10th harmonic of highest fundamental frequency ◦ "F" denotes fundamental frequency; "H" denotes spurious frequency. "E" denotes band edge frequency. (This judgment method includes the Band Edge Requirement.)
- (3) Radiated emissions measured in frequency range above 1000MHz were made with an instrument using Peak detector mode and AV detector mode of the emission ◦
- (4) Data of measurement within this frequency range shown " \* " in the table above means the reading of emissions are attenuated more than 20dB below the permissible limits or the field strength is too small to be measured.
- (5) A preamp and high pass filter were used for this test in order to provide sufficient measurement sensitivity.
- (6) EUT Orthogonal Axis :  
"X" - denotes Laid on Table ; "Y" - denotes Vertical Stand ; "Z" - denotes Side Stand
- (7) During the measurements above 1 GHz it is taken care of that the EUT is always within the 3 dB cone of radiation BW of the used antenna



TX CH09 (Above 1000 MHz, Horizontal)

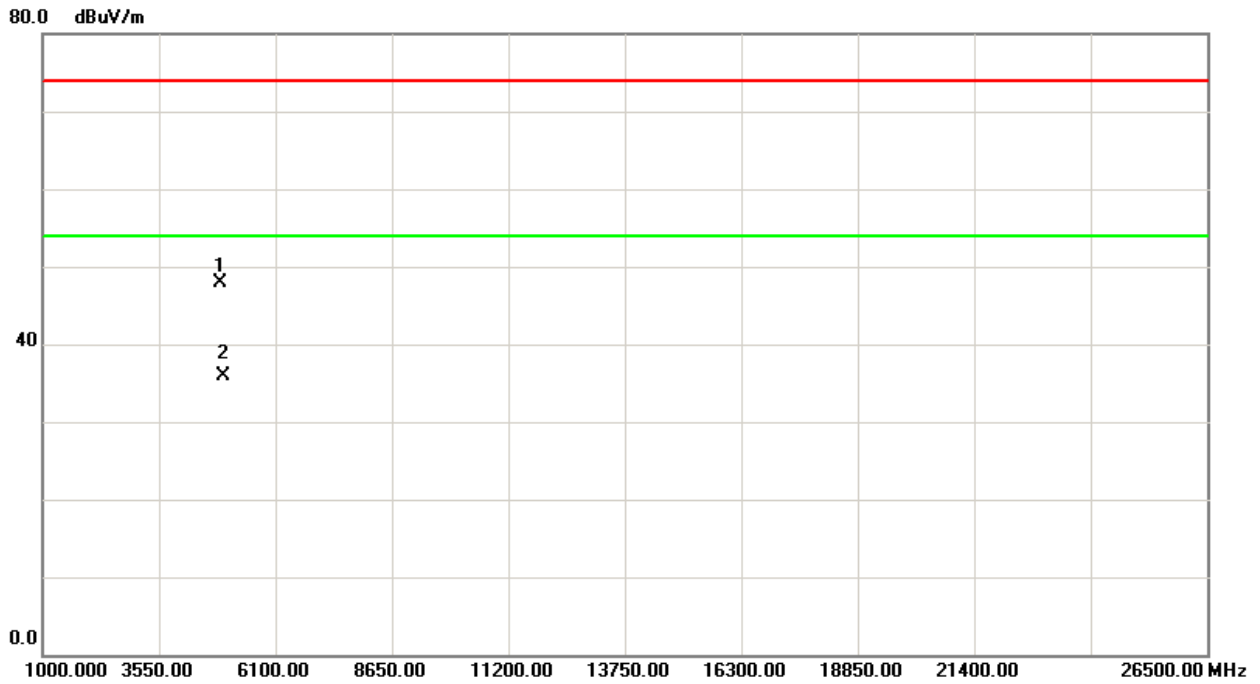
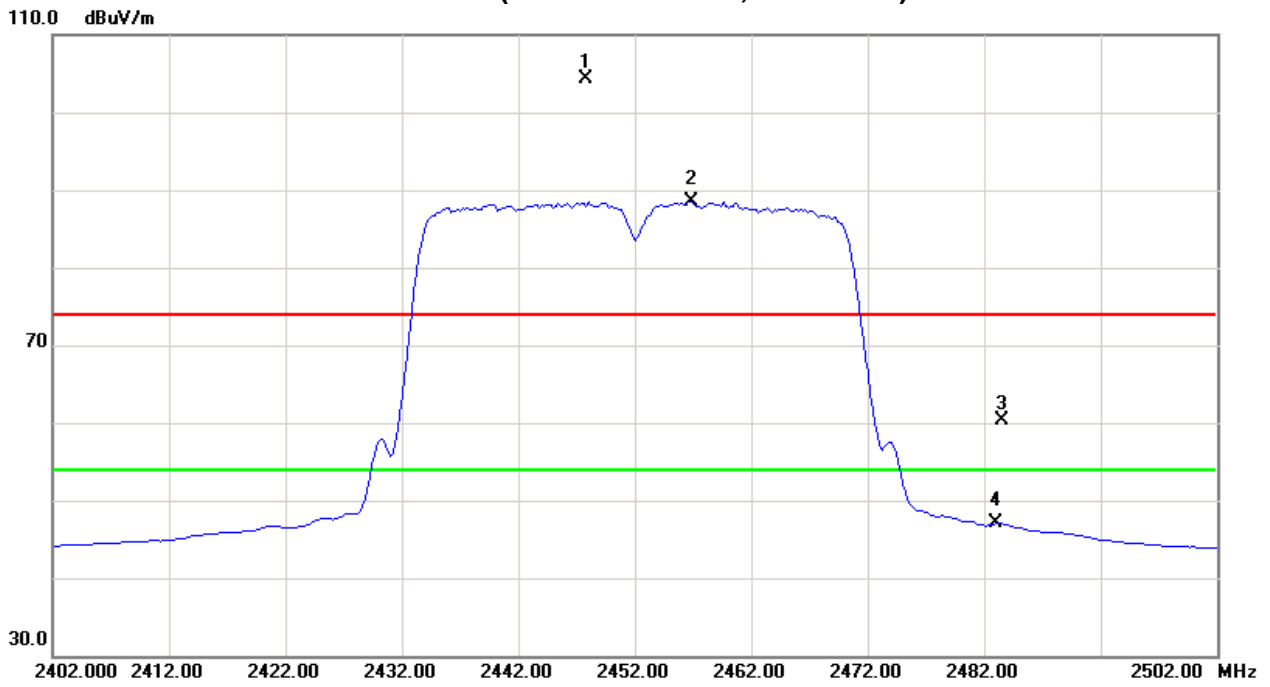



**5. BANDWIDTH TEST**

**5.1 Applied procedures / limit**

FCC Part15 (15.247) , Subpart C			
Section	Test Item	Frequency Range (MHz)	Result
15.247(a)(2)	Bandwidth	2400-2483.5	PASS

**5.1.1 MEASUREMENT INSTRUMENTS LIST**

Item	Kind of Equipment	Manufacturer	Type No.	Serial No.	Last Calibration	Next Calibration
1	Spectrum Analyzer	R&S	FSP_40	100185	Nov. 17.2012	Nov.16, 2013

Remark: "N/A" denotes no model name, serial no. or calibration specified.  
 All calibration period of equipment list is one year.

**5.1.2 TEST PROCEDURE**

- a. The EUT was directly connected to the spectrum analyzer and antenna output port as show in the block diagram below,
- b. Spectrum Setting : RBW= 100KHz, VBW=300KHz, Sweep time = 2.5 ms.

**5.1.3 DEVIATION FROM STANDARD**

No deviation.

**5.1.4 TEST SETUP**



**5.1.5 EUT OPERATION CONDITIONS**

The EUT tested system was configured as the statements of 4.1.6 Unless otherwise a special operating condition is specified in the follows during the testing.





**5.1.6 TEST RESULTS**

EUT :	Wireless N300 Home Router	Model Name. :	W303R
Temperature :	24 °C	Relative Humidity :	60 %
Pressure :	1016 hPa	Test Voltage :	AC 120V/60Hz
Test Mode :	TX B MODE /CH01, CH06, CH11		

Test Channel	Frequency (MHz)	Bandwidth (MHz)	Result
CH01	2412	10.20	PASS
CH06	2437	10.16	PASS
CH11	2462	10.24	PASS

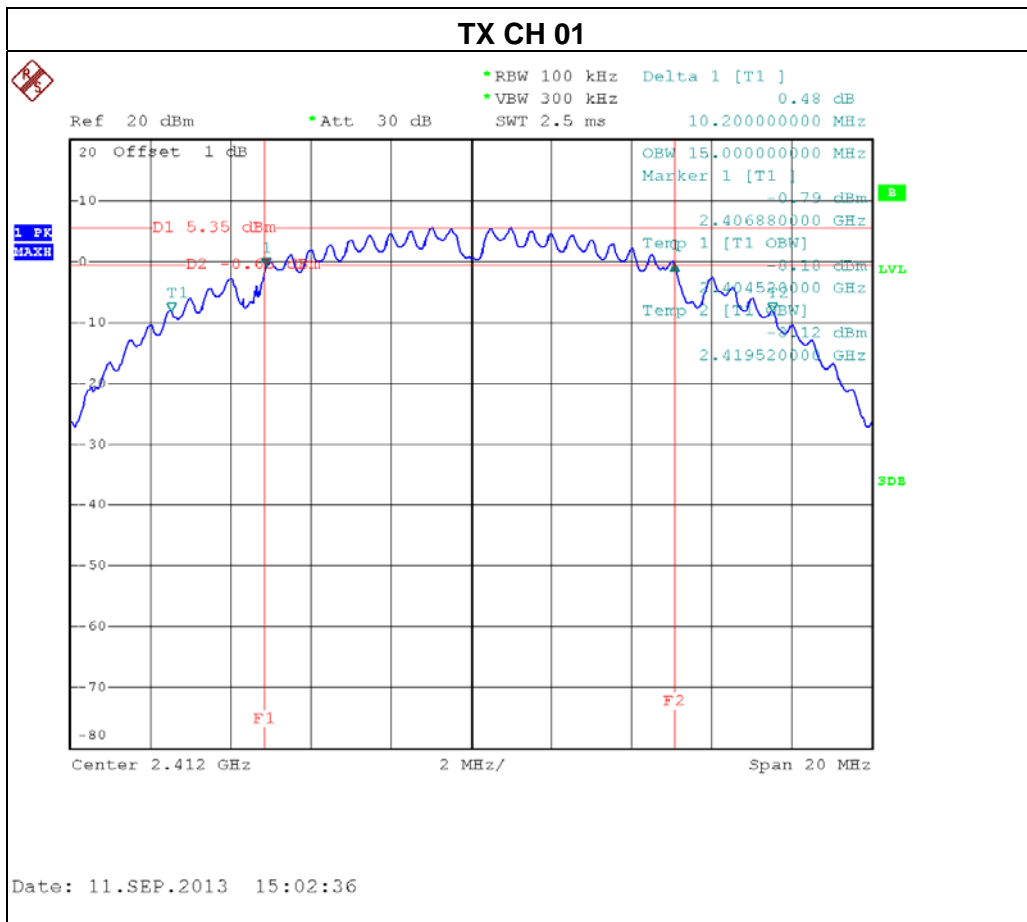

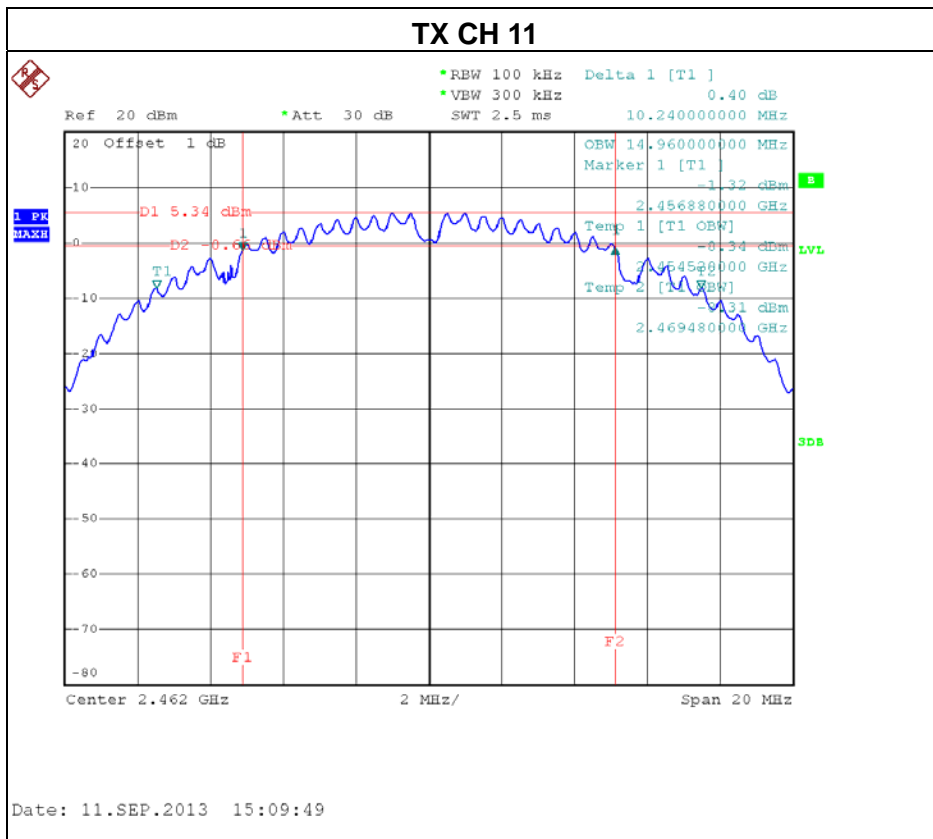
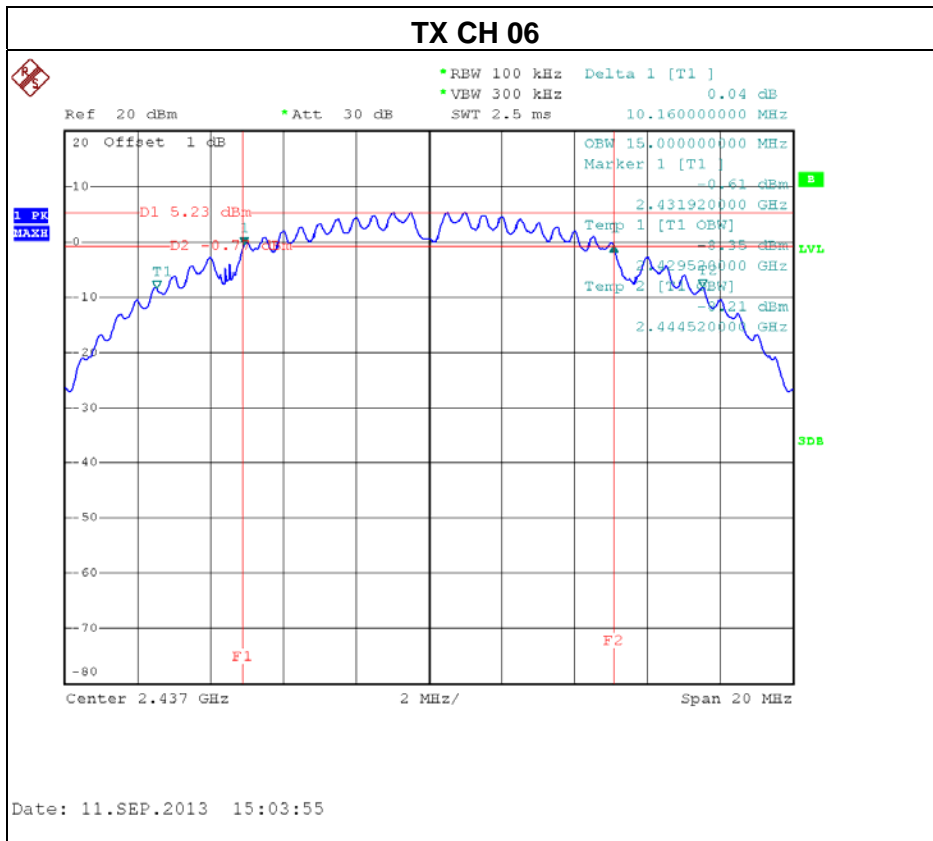



EUT :	Wireless N300 Home Router	Model Name. :	W303R
Temperature :	24 °C	Relative Humidity :	60 %
Pressure :	1016 hPa	Test Voltage :	AC 120V/60Hz
Test Mode :	TX G MODE /CH01, CH06, CH11		

Test Channel	Frequency (MHz)	Bandwidth (MHz)	Result
CH01	2412	16.48	PASS
CH06	2437	16.52	PASS
CH11	2462	16.60	PASS

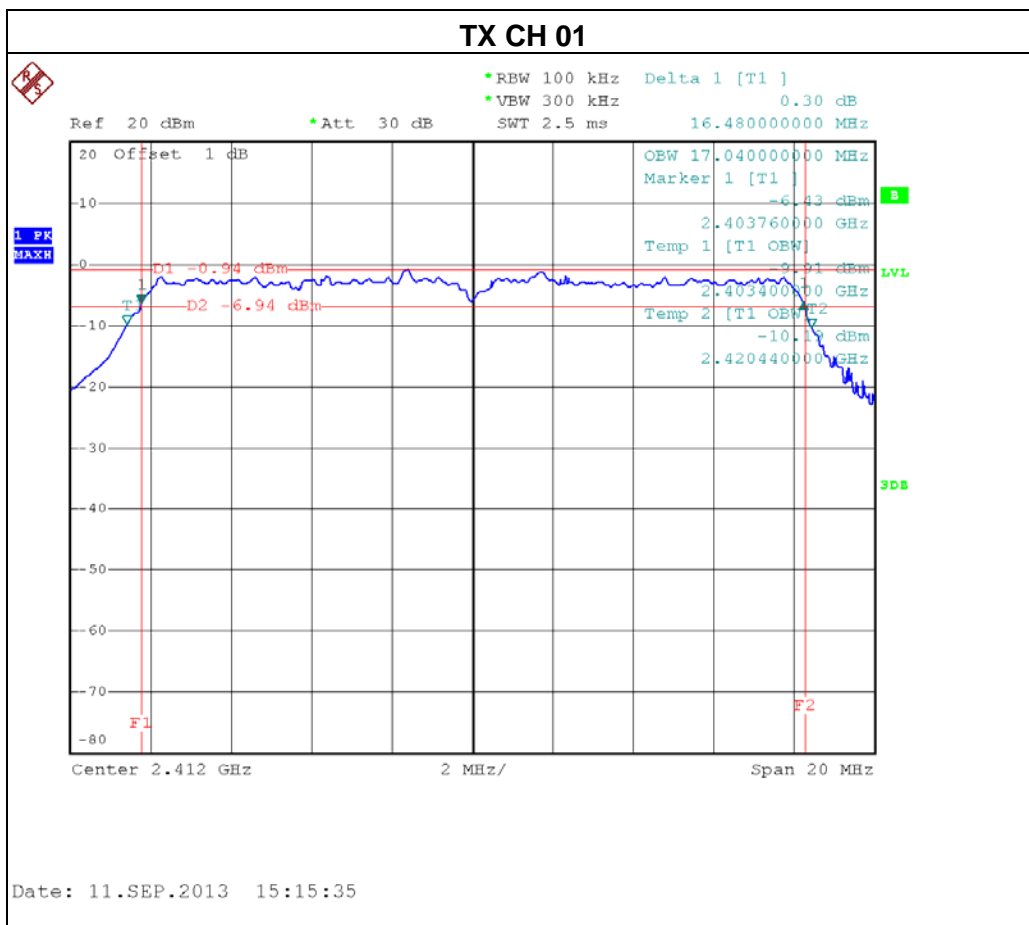

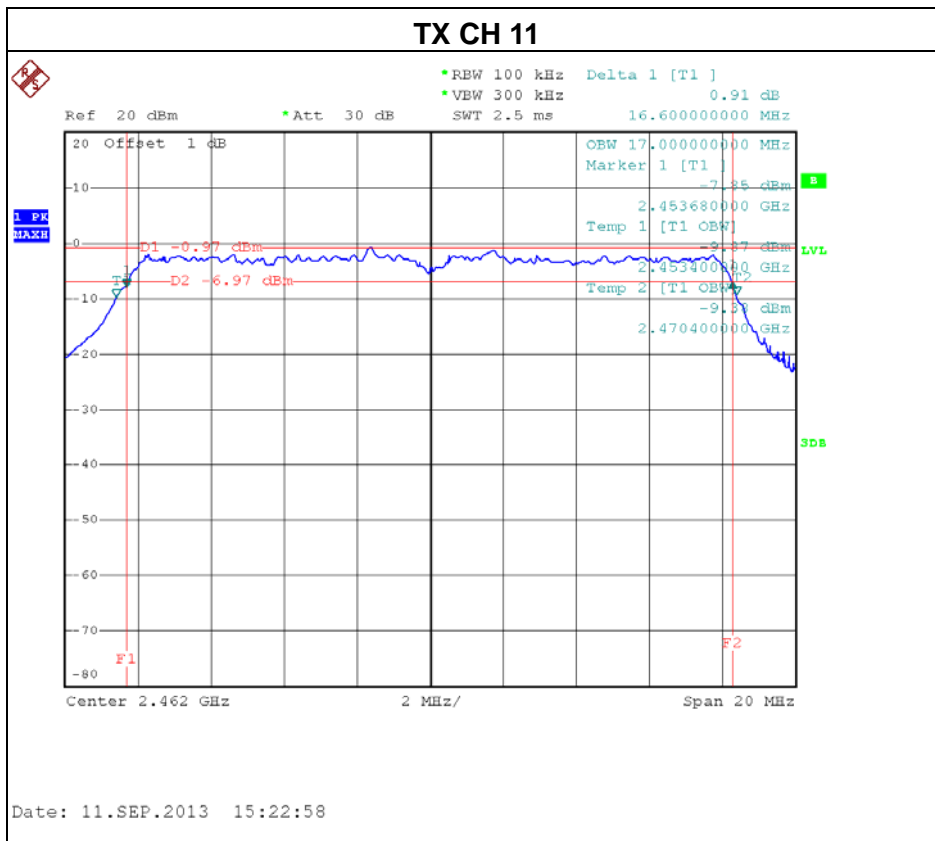
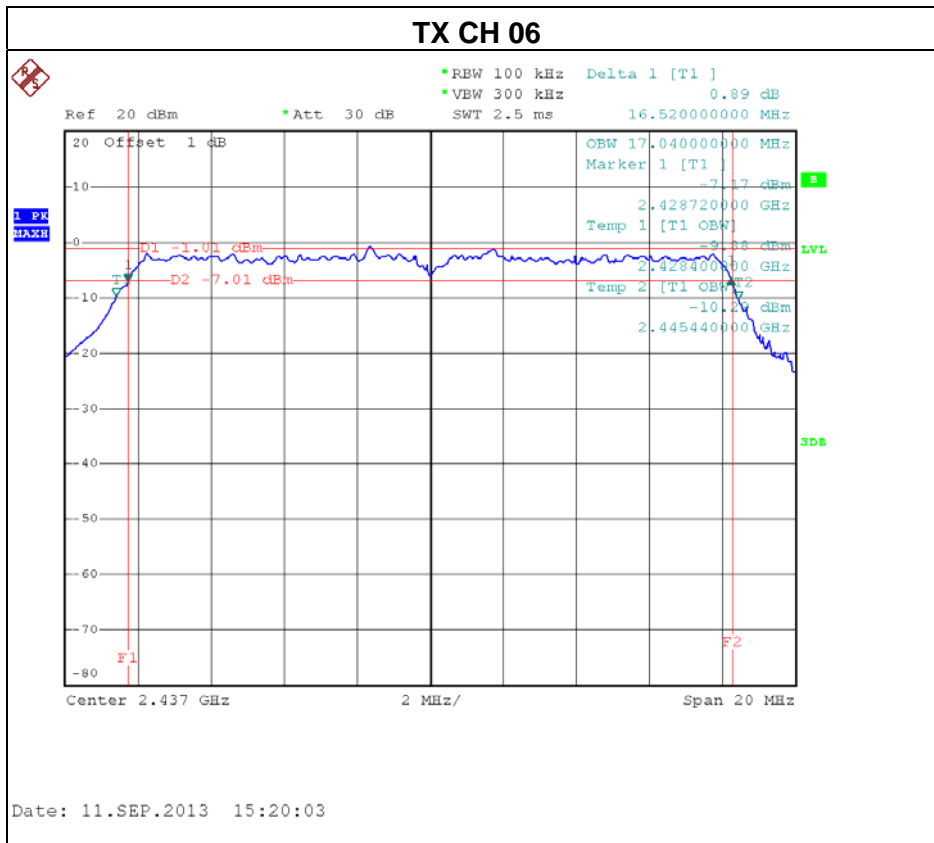



EUT :	Wireless N300 Home Router	Model Name. :	W303R
Temperature :	24 °C	Relative Humidity :	60 %
Pressure :	1016 hPa	Test Voltage :	AC 120V/60Hz
Test Mode :	TX N MODE -20MHz/ CH01, CH06, CH11-ANT 0		

Test Channel	Frequency (MHz)	Bandwidth (MHz)	Result
CH01	2412	17.88	PASS
CH06	2437	17.88	PASS
CH11	2462	17.92	PASS

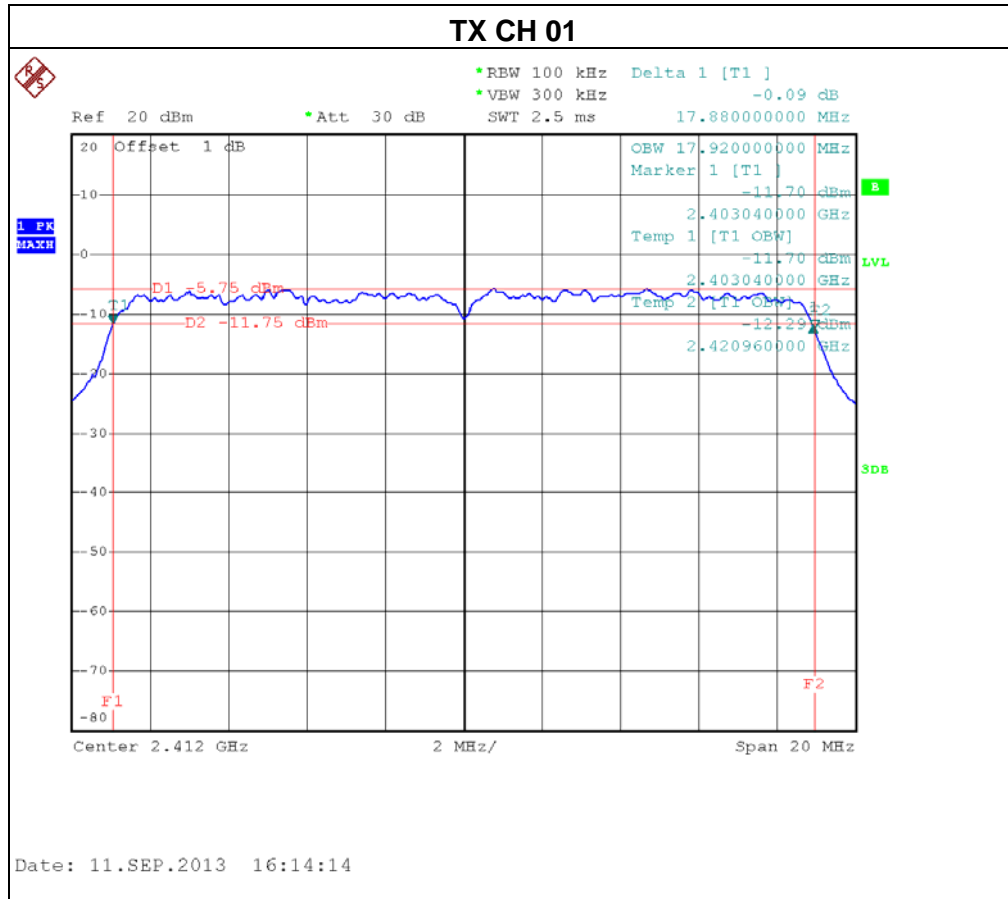

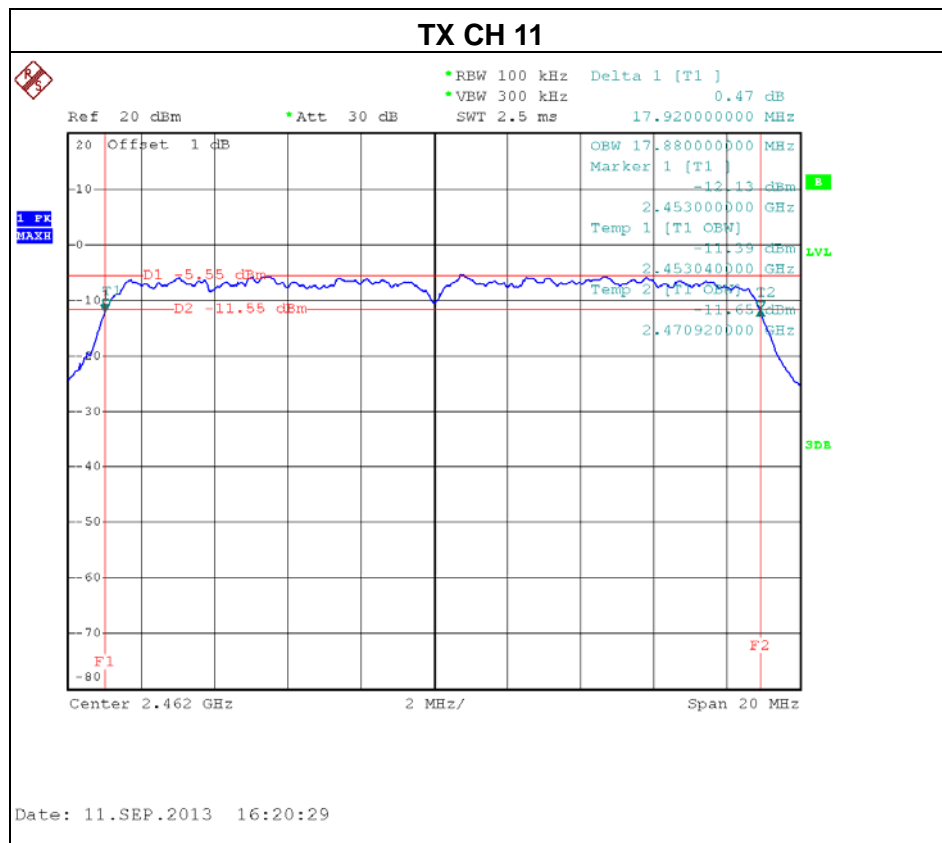
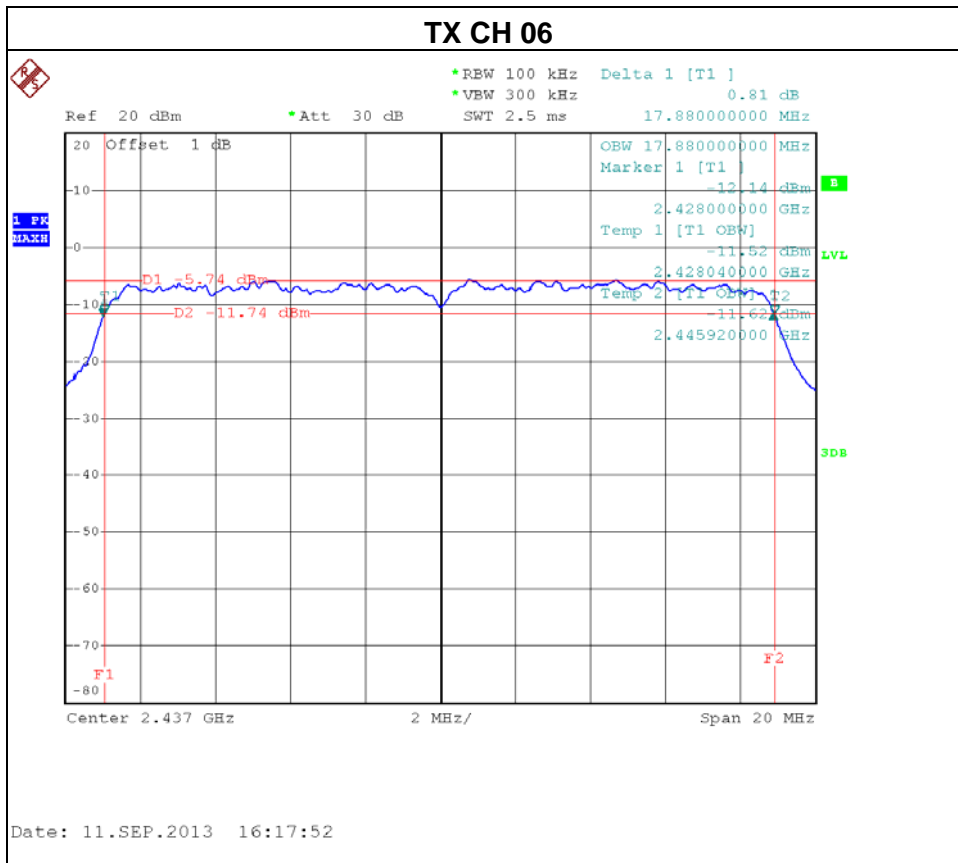



EUT :	Wireless N300 Home Router	Model Name. :	W303R
Temperature :	24 °C	Relative Humidity :	60 %
Pressure :	1016 hPa	Test Voltage :	AC 120V/60Hz
Test Mode :	TX N MODE -20MHz/ CH01, CH06, CH11-ANT 1		

Test Channel	Frequency (MHz)	Bandwidth (MHz)	Result
CH01	2412	17.88	PASS
CH06	2437	17.88	PASS
CH11	2462	17.88	PASS

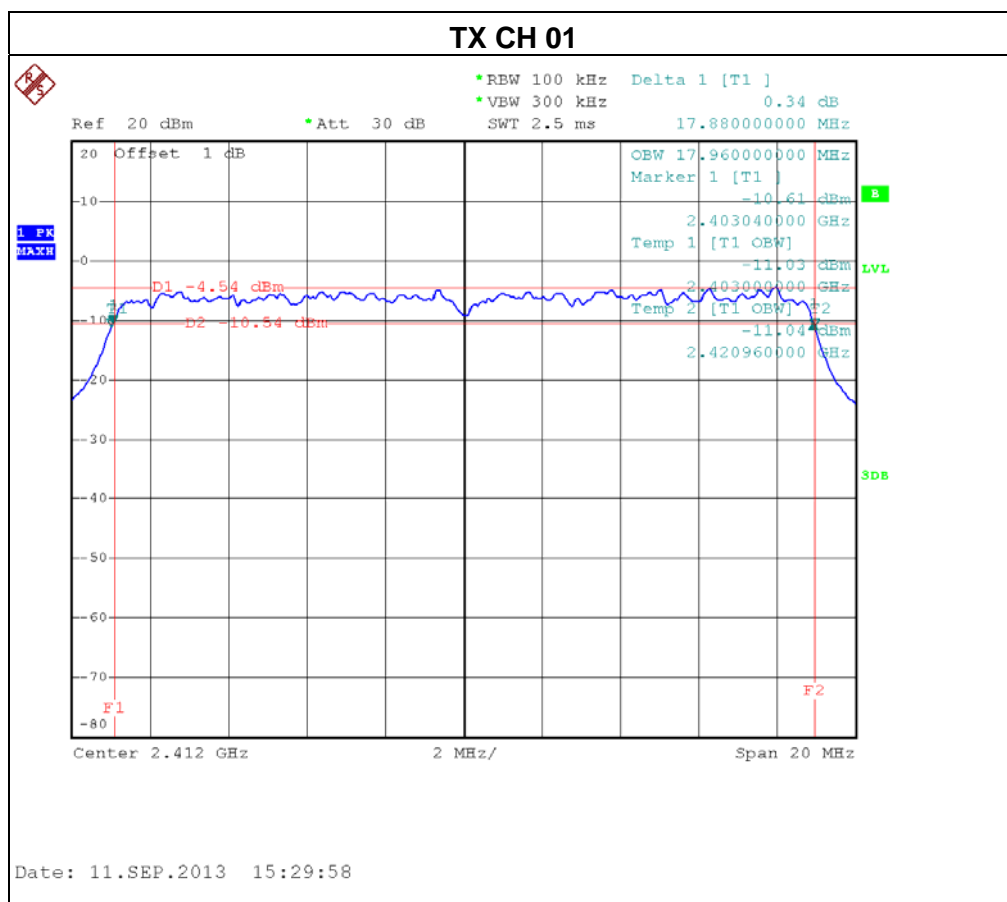

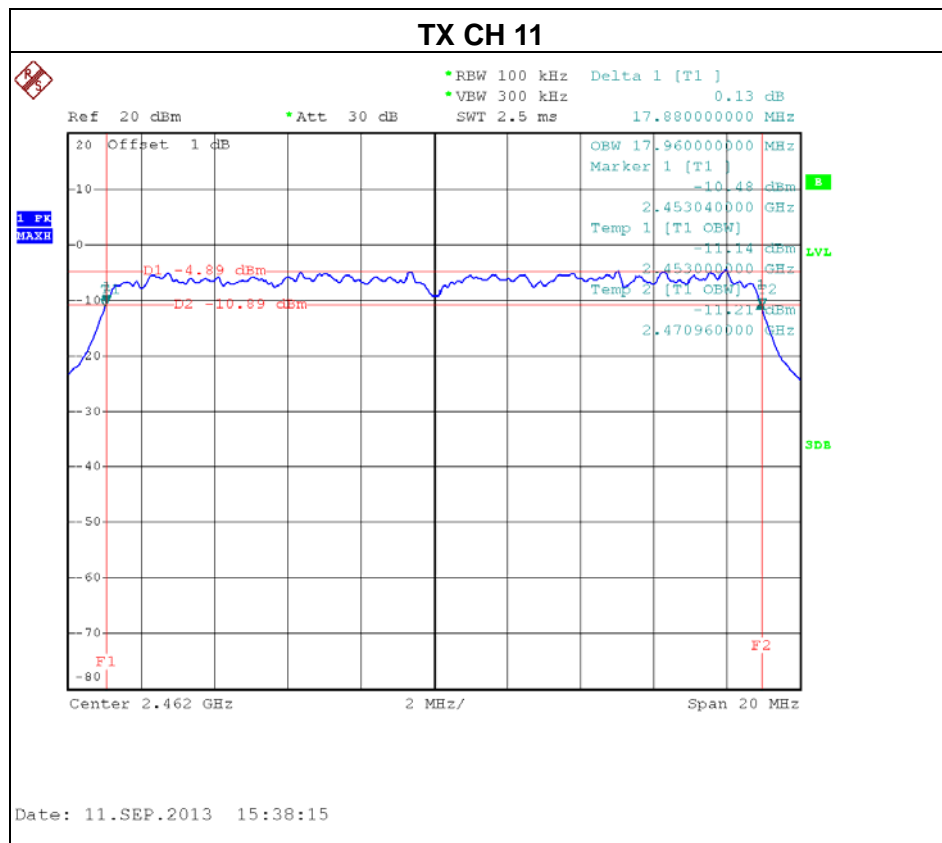
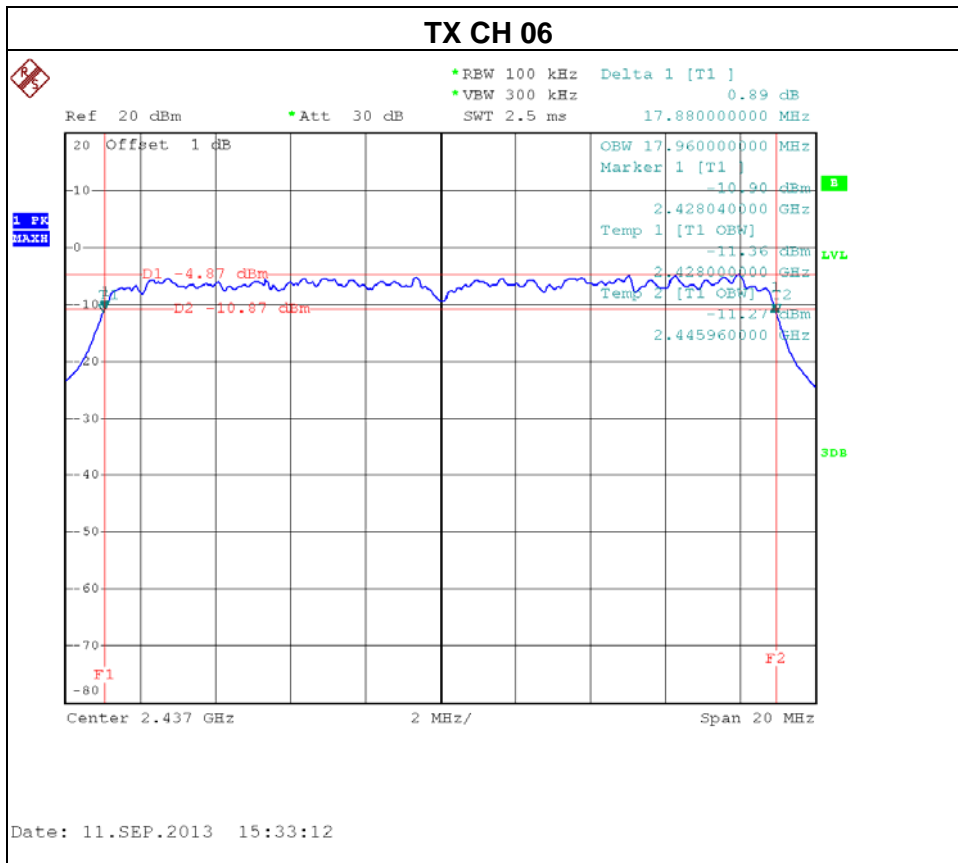





EUT :	Wireless N300 Home Router	Model Name. :	W303R
Temperature :	24 °C	Relative Humidity :	60 %
Pressure :	1016 hPa	Test Voltage :	AC 120V/60Hz
Test Mode :	TX N MODE -40MHz/ CH03, CH06, CH09-ANT 0		

Test Channel	Frequency (MHz)	Bandwidth (MHz)	Result
CH03	2422	36.48	PASS
CH06	2437	36.48	PASS
CH09	2452	36.56	PASS

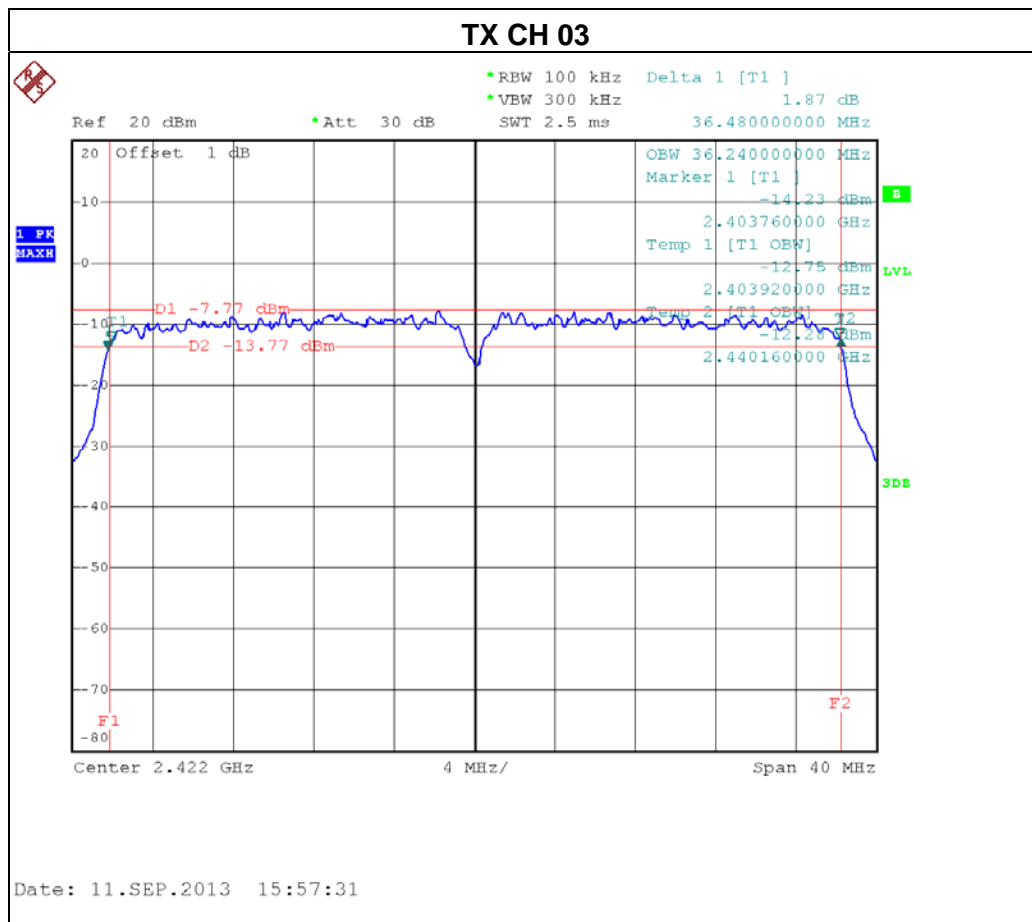

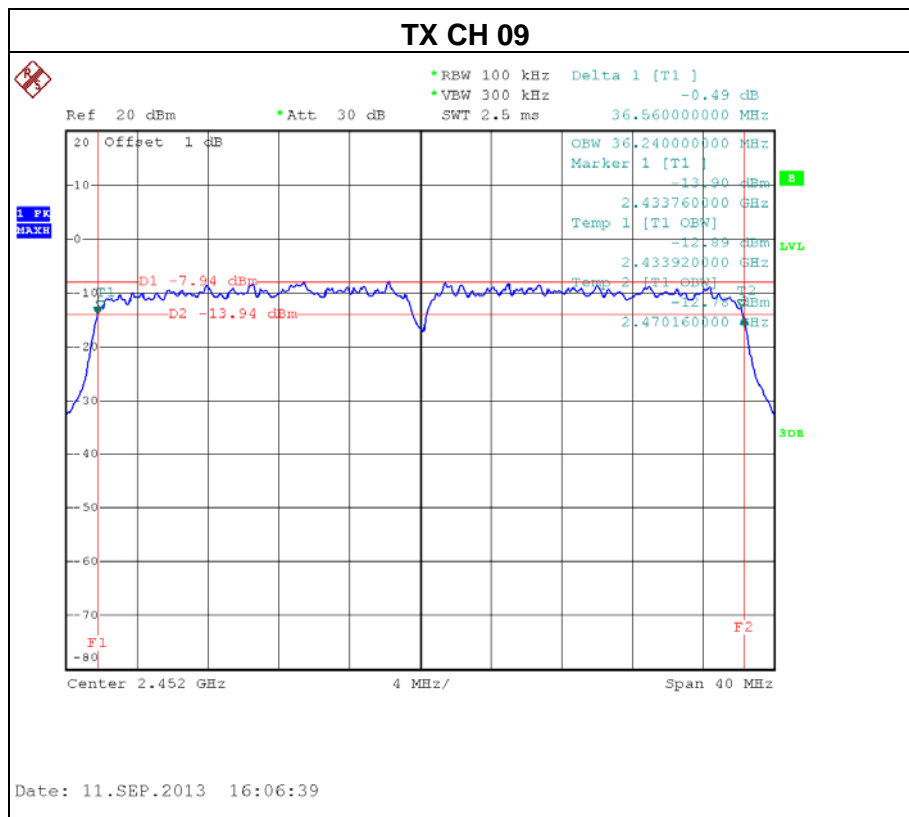
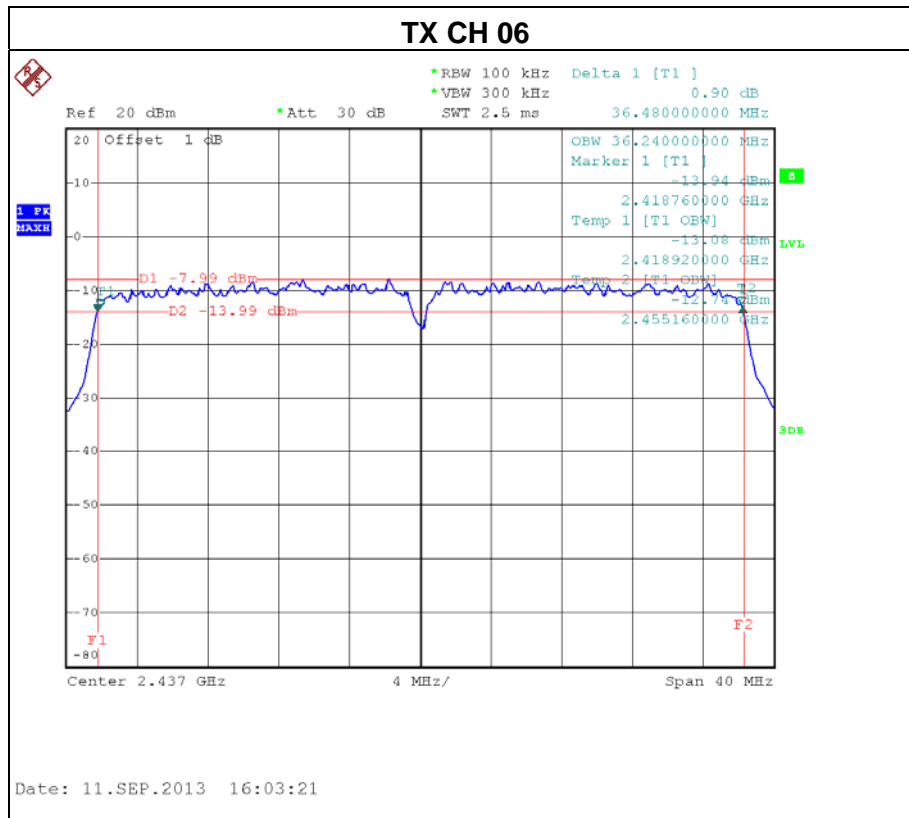



EUT :	Wireless N300 Home Router	Model Name. :	W303R
Temperature :	24 °C	Relative Humidity :	60 %
Pressure :	1016 hPa	Test Voltage :	AC 120V/60Hz
Test Mode :	TX N MODE -40MHz/ CH03, CH06, CH09-ANT 1		

Test Channel	Frequency (MHz)	Bandwidth (MHz)	Result
CH03	2422	36.16	PASS
CH06	2437	36.32	PASS
CH09	2452	36.40	PASS

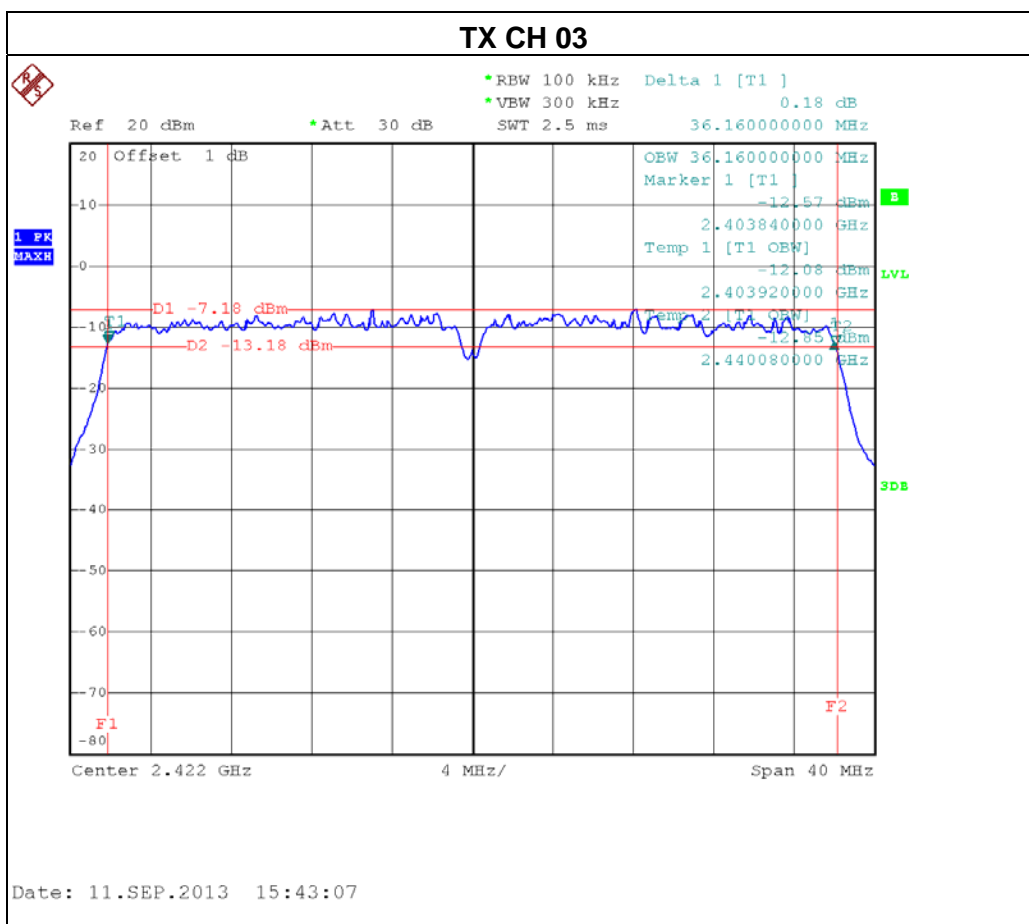

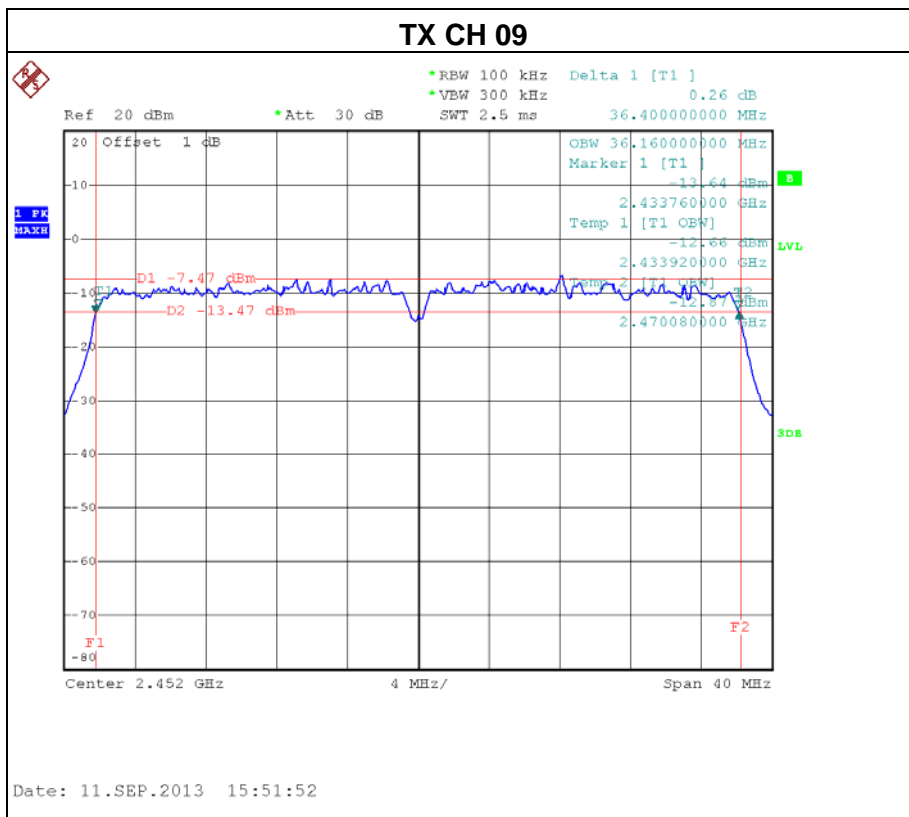
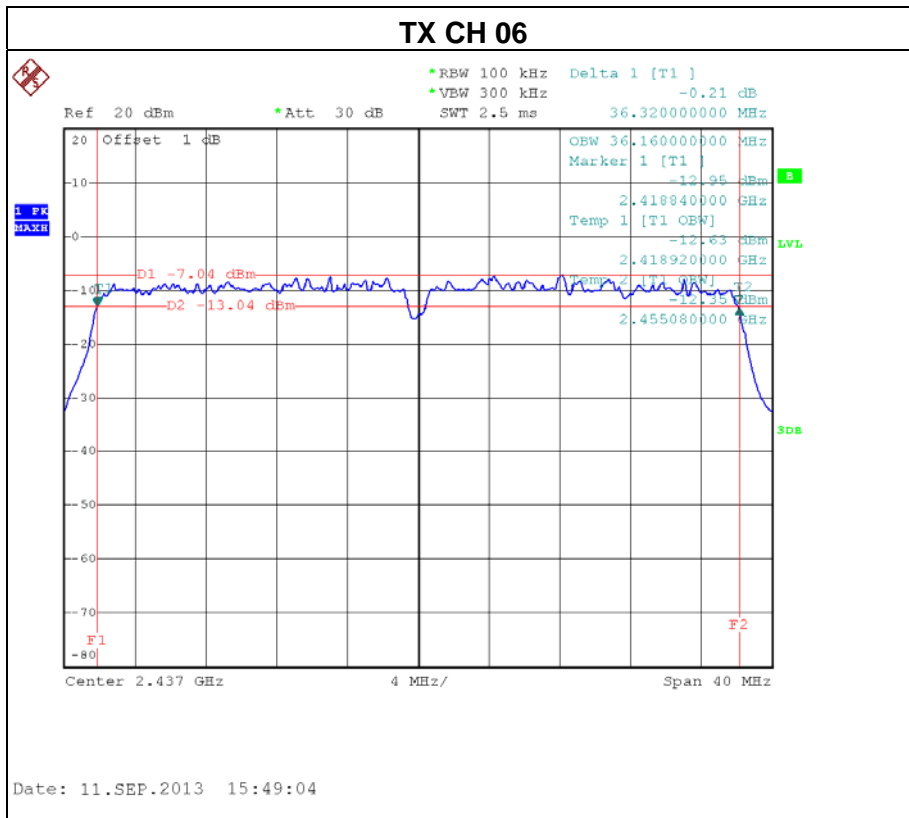



**6. MAXIMUM OUTPUT POWER TEST**

**6.1 Applied procedures / limit**

FCC Part15 (15.247) , Subpart C				
Section	Test Item	Limit	Frequency Range (MHz)	Result
15.247(b)(3)	Maximum Output Power	1 watt or 30dBm	2400-2483.5	PASS

**6.1.1 MEASUREMENT INSTRUMENTS LIST**

Item	Kind of Equipment	Manufacturer	Type No.	Serial No.	Last Calibration	Next Calibration
1	P-series Power meter	Agilent	N1911A	MY45100473	May.04.2013	Apr.25.2014
2	Wireband Power sensor	Agilent	N1921A	MY51100041	May.04.2013	Apr.25.2014

Remark: "N/A" denotes no model name, serial no. or calibration specified.  
 All calibration period of equipment list is one year.

**6.1.2 TEST PROCEDURE**

- a. The EUT was directly connected to the power meter and antenna output port as show in the block diagram below,
- b. The maximum peak conducted output power was performed in accordance with method 9.1.3 of FCC KDB 558074

**6.1.3 DEVIATION FROM STANDARD**

No deviation.

**6.1.4 TEST SETUP**



**6.1.5 EUT OPERATION CONDITIONS**

The EUT tested system was configured as the statements of 4.1.6 Unless otherwise a special operating condition is specified in the follows during the testing. Transmit output power was measured while the host equipment supply voltage was varied from 85 % to 115 % of the nominal rated supply voltage. No change in transmit output power was observed.



**6.1.6 TEST RESULTS**

EUT :	Wireless N300 Home Router	Model Name :	W303R
Temperature :	24 °C	Relative Humidity :	60 %
Pressure :	1016 hPa	Test Voltage :	AC 120V/60Hz
Test Mode :	TX B MODE /CH01, CH06, CH11		

Frequency (MHz)	Peak Output Power (dBm)	LIMIT (dBm)	LIMIT (W)
2412	18.23	30	1
2437	18.02	30	1
2462	18.53	30	1

EUT :	Wireless N300 Home Router	Model Name :	W303R
Temperature :	24 °C	Relative Humidity :	60 %
Pressure :	1016 hPa	Test Voltage :	AC 120V/60Hz
Test Mode :	TX G MODE /CH01, CH06, CH11		

Frequency (MHz)	Peak Output Power (dBm)	LIMIT (dBm)	LIMIT (W)
2412	20.93	30	1
2437	20.98	30	1
2462	21.01	30	1



EUT :	Wireless N300 Home Router	Model Name :	W303R
Temperature :	24 °C	Relative Humidity :	60 %
Pressure :	1016 hPa	Test Voltage :	AC 120V/60Hz
Test Mode :	TX N-20M MODE /CH01, CH06, CH11		

ANT 0			
Frequency (MHz)	Peak Output Power (dBm)	LIMIT (dBm)	LIMIT (W)
2412	21.48	30	1
2437	21.35	30	1
2462	21.12	30	1

ANT 1			
Frequency (MHz)	Peak Output Power (dBm)	LIMIT (dBm)	LIMIT (W)
2412	20.54	30	1
2437	20.63	30	1
2462	20.86	30	1

ANT 0 + ANT 1			
Frequency (MHz)	Peak Output Power (dBm)	LIMIT (dBm)	LIMIT (W)
2412	24.05	30	1
2437	24.02	30	1
2462	24.00	30	1

Note: The EUT incorporates a MIMO function. Physically, the EUT provides two completed transmitters and three receivers (2T3R).all transmit signals are completely uncorrelated, then, Direction gain =  $G_{ANT}$ , that is Directional gain=5.24.



EUT :	Wireless N300 Home Router	Model Name :	W303R
Temperature :	24 °C	Relative Humidity :	60 %
Pressure :	1016 hPa	Test Voltage :	AC 120V/60Hz
Test Mode :	TX N-40M MODE /CH03, CH06, CH09		

ANT 0			
Frequency (MHz)	Peak Output Power (dBm)	LIMIT (dBm)	LIMIT (W)
2422	20.35	30	1
2437	20.63	30	1
2452	20.31	30	1

ANT 1			
Frequency (MHz)	Peak Output Power (dBm)	LIMIT (dBm)	LIMIT (W)
2422	20.63	30	1
2437	20.45	30	1
2452	20.35	30	1

ANT 0 + ANT 1			
Frequency (MHz)	Peak Output Power (dBm)	LIMIT (dBm)	LIMIT (W)
2422	23.50	30	1
2437	23.55	30	1
2452	23.34	30	1

Note: The EUT incorporates a MIMO function. Physically, the EUT provides two completed transmitters and three receivers (2T3R).all transmit signals are completely uncorrelated, then, Direction gain =  $G_{ANT}$ , that is Directional gain=5.24.





**7. ANTENNA CONDUCTED SPURIOUS EMISSION**

**7.1 Applied procedures / limit**

20dBc in any 100 kHz bandwidth outside the operating frequency band. In case the emission fall within the restricted band specified on 15.205(a), then the 15.209(a) limit in the table below has to be followed.

Frequencies (MHz)	Field Strength (micorvolts/meter)	Measurement Distance (meters)
0.009~0.490	2400/F(KHz)	300
0.490~1.705	24000/F(KHz)	30
1.705~30.0	30	30
30~88	100	3
88~216	150	3
216~960	200	3
960~1000	500	3

**7.1.1 MEASUREMENT INSTRUMENTS LIST**

Item	Kind of Equipment	Manufacturer	Type No.	Serial No.	Last Calibration	Next Calibration
1	Spectrum Analyzer	R&S	FSP_40	100185	Nov. 17.2012	Nov.16, 2013

Remark: "N/A" denotes no model name, serial no. or calibration specified.

All calibration period of equipment list is one year.

**7.1.2 TEST PROCEDURE**

- a. The EUT was directly connected to the spectrum analyzer and antenna output port as show in the block diagram below,
- b. Spectrum Setting : RBW= 100KHz, VBW=300KHz, Sweep time = Auto.

**7.1.3 DEVIATION FROM STANDARD**

No deviation.

**7.1.4 TEST SETUP**

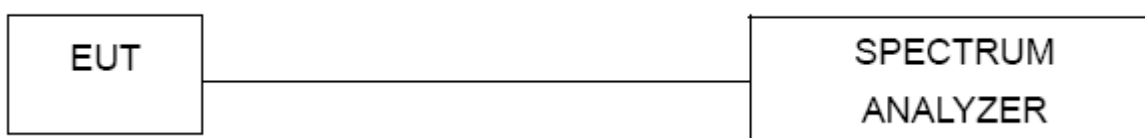

**7.1.5 EUT OPERATION CONDITIONS**

The EUT tested system was configured as the statements of 4.1.6 Unless otherwise a special operating condition is specified in the follows during the testing.



**7.1.6 TEST RESULTS**

EUT :	Wireless N300 Home Router	Model Name :	W303R
Temperature :	24 °C	Relative Humidity :	60 %
Pressure :	1016 hPa	Test Voltage :	AC 120V/60Hz
Test Mode :	TX B MODE /CH01, CH06 , CH11		

Channel of Worst Data: CH01			
The max. radio frequency power in any 100kHz bandwidth outside the frequency band		The max. radio frequency power in any 100 kHz bandwidth within the frequency band.	
FREQUENCY(MHz)	POWER(dBm)	FREQUENCY(MHz)	POWER(dBm)
2400.00	-32.30	2500.00	-47.40
Result			
In any 100kHz bandwidth outside the frequency band, the radio frequency power is at least 20dB below that in the 100kHz bandwidth within the band that contains the highest level of the desired power.			

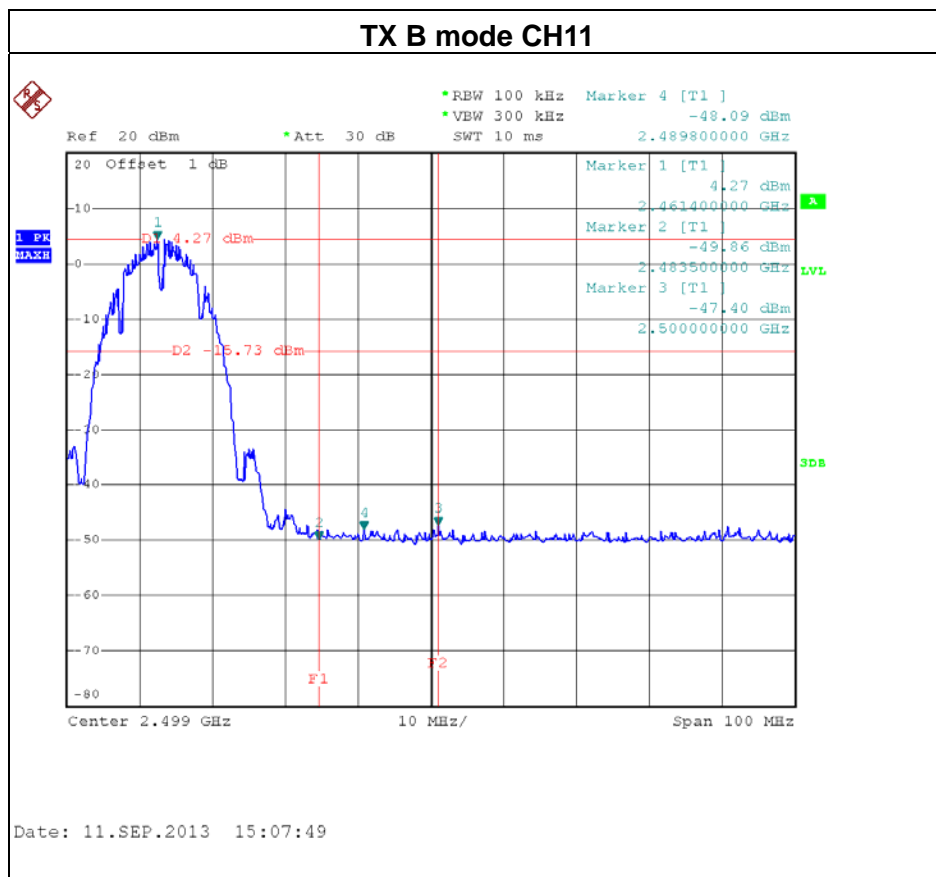
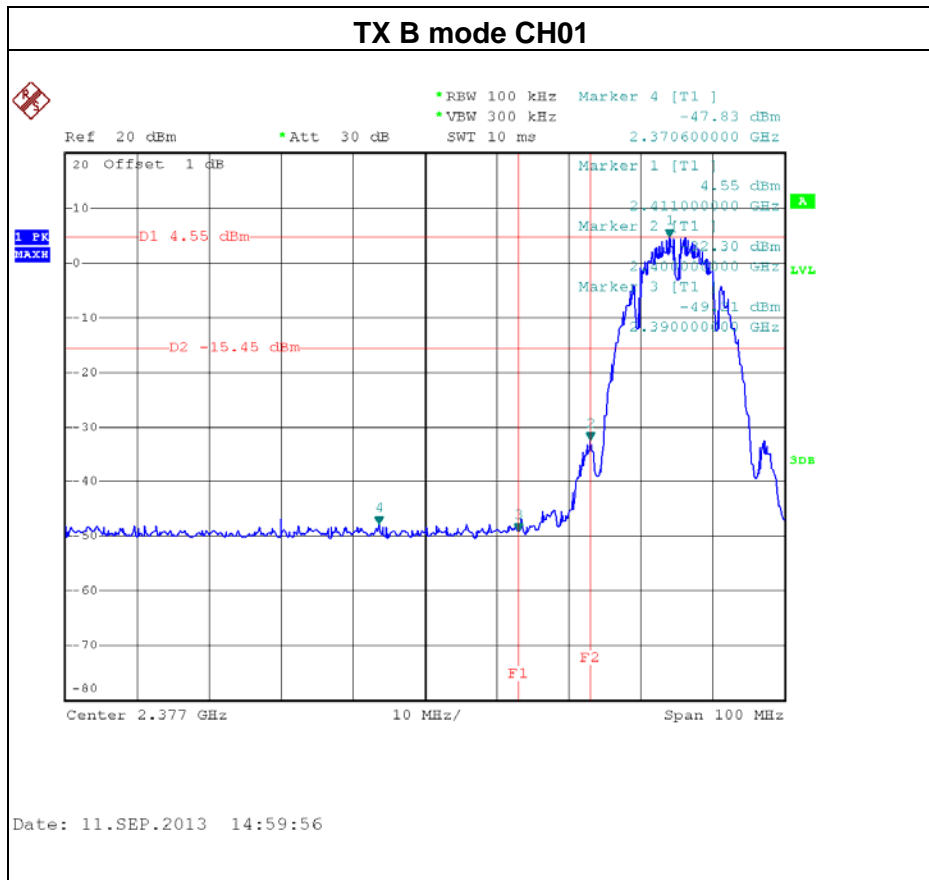

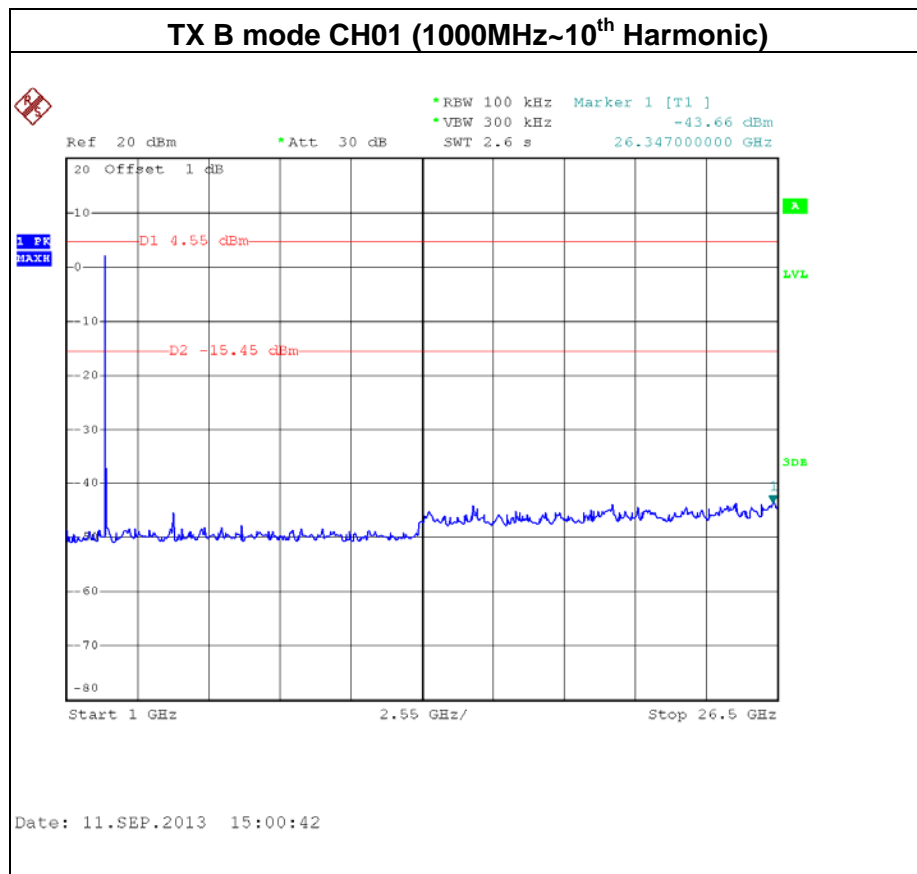
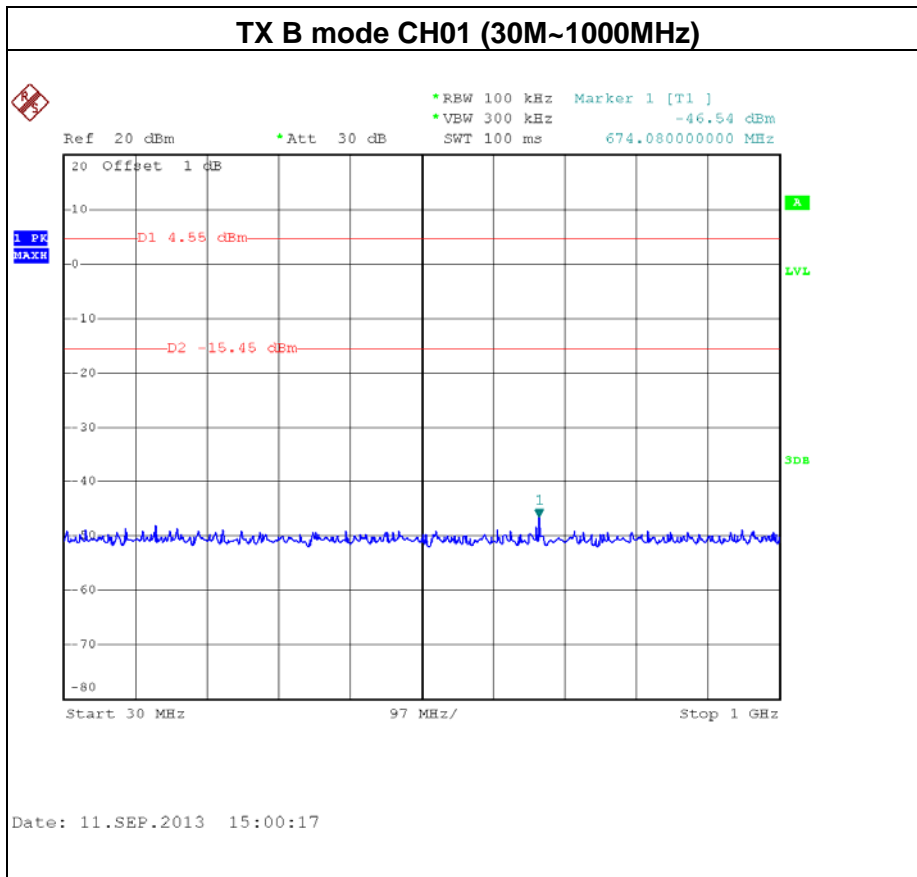

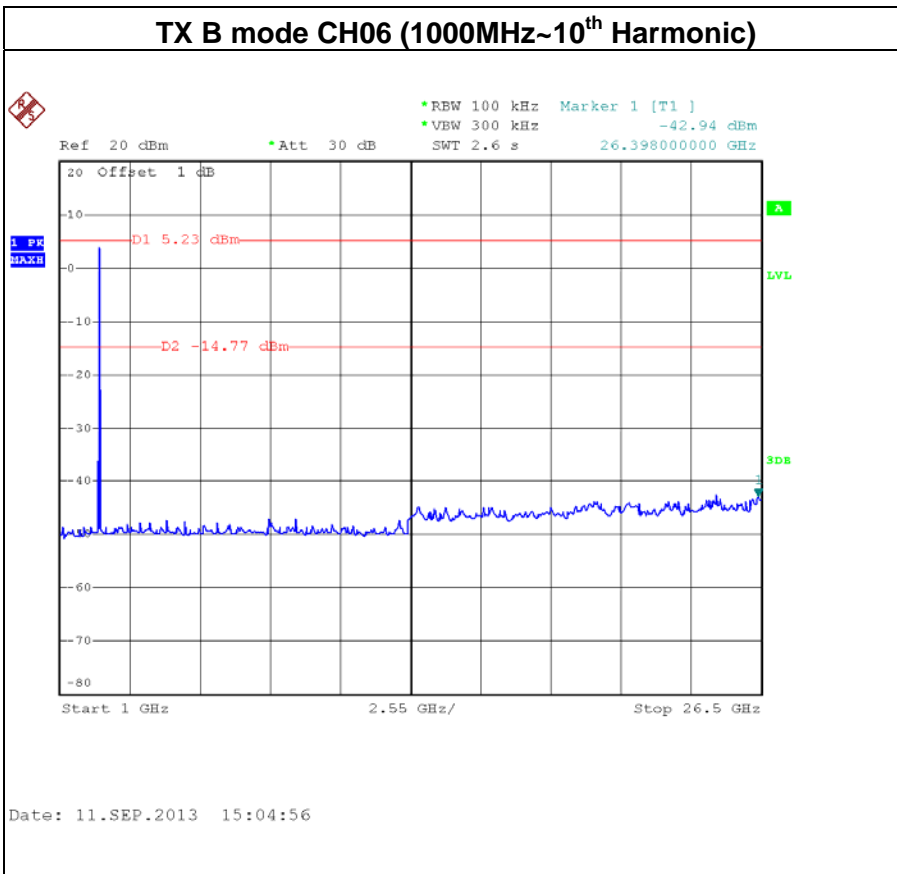
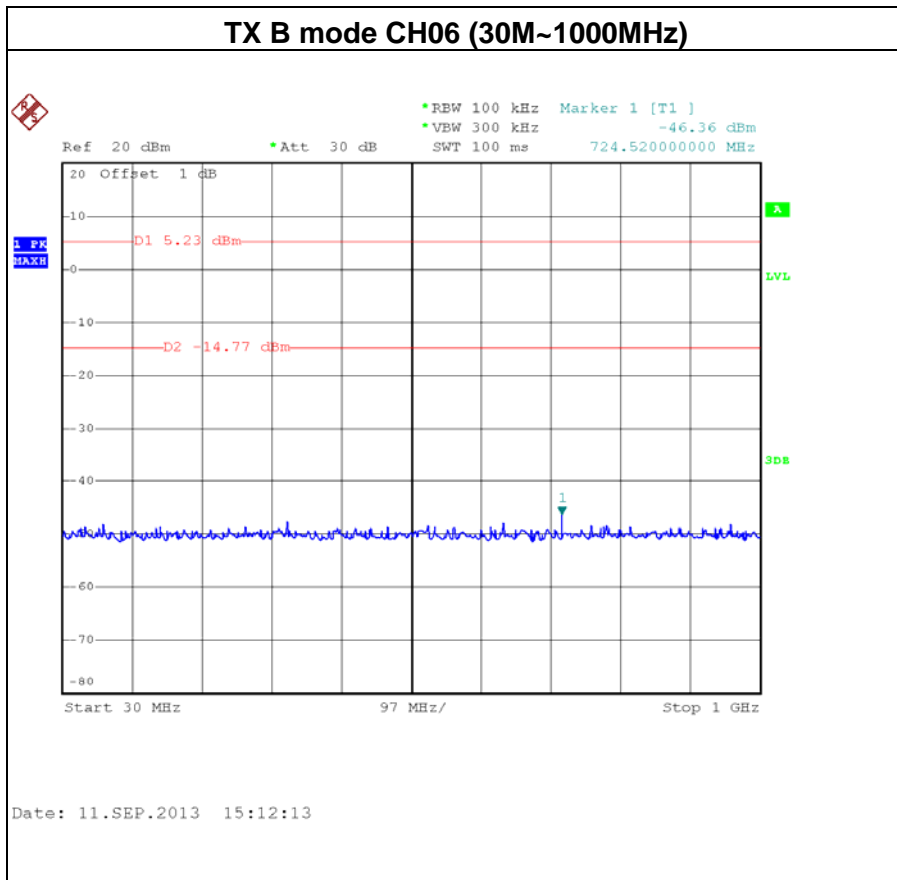

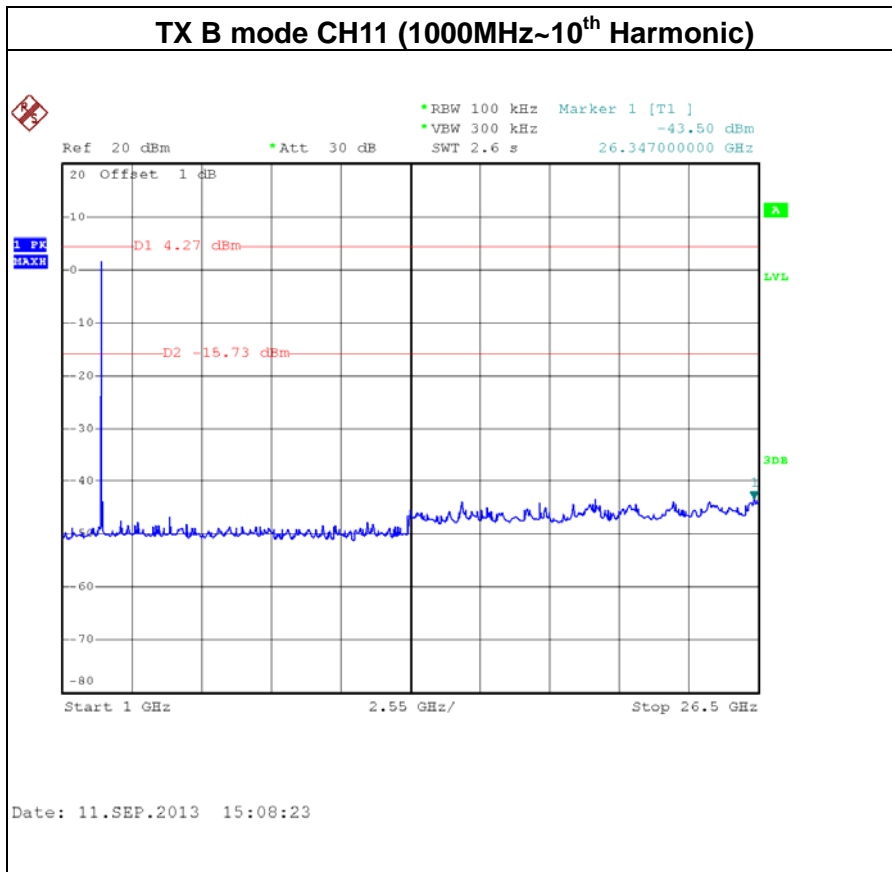
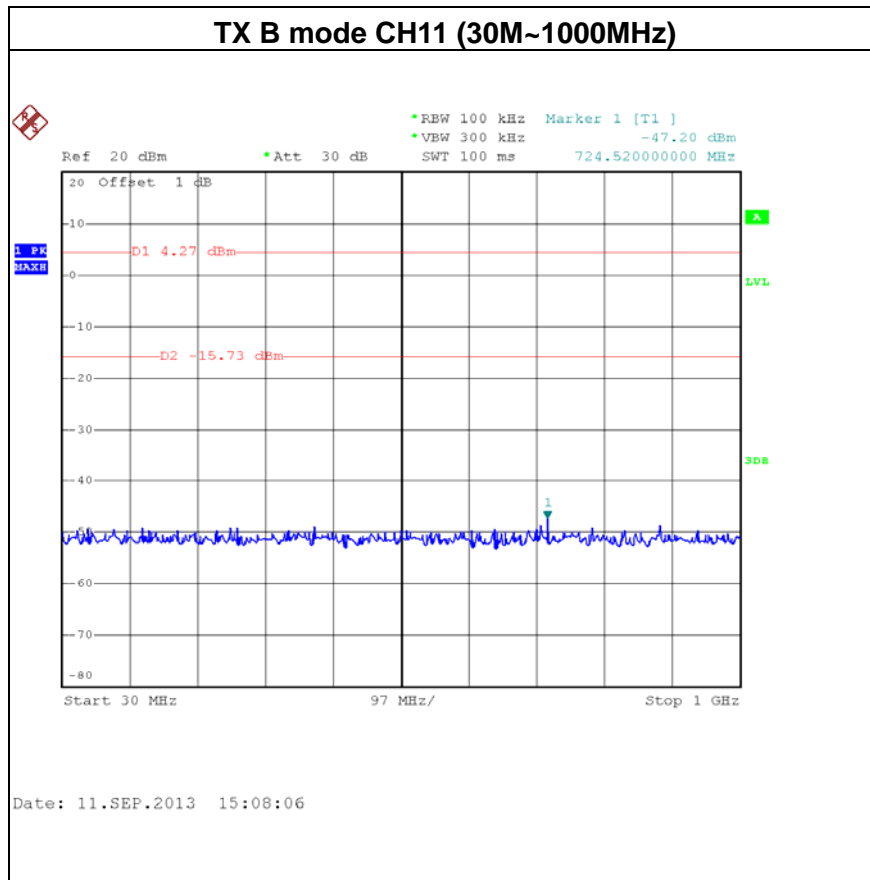



EUT :	Wireless N300 Home Router	Model Name :	W303R
Temperature :	24 °C	Relative Humidity :	60 %
Pressure :	1016 hPa	Test Voltage :	AC 120V/60Hz
Test Mode :	TX G MODE / CH01, CH06 , CH11		

Channel of Worst Data: CH01			
The max. radio frequency power in any 100kHz bandwidth outside the frequency band		The max. radio frequency power in any 100 kHz bandwidth within the frequency band.	
FREQUENCY(MHz)	POWER(dBm)	FREQUENCY(MHz)	POWER(dBm)
2400.00	-41.26	2487.92	-47.67
Result			
In any 100kHz bandwidth outside the frequency band, the radio frequency power is at least 20dB below that in the 100kHz bandwidth within the band that contains the highest level of the desired power.			

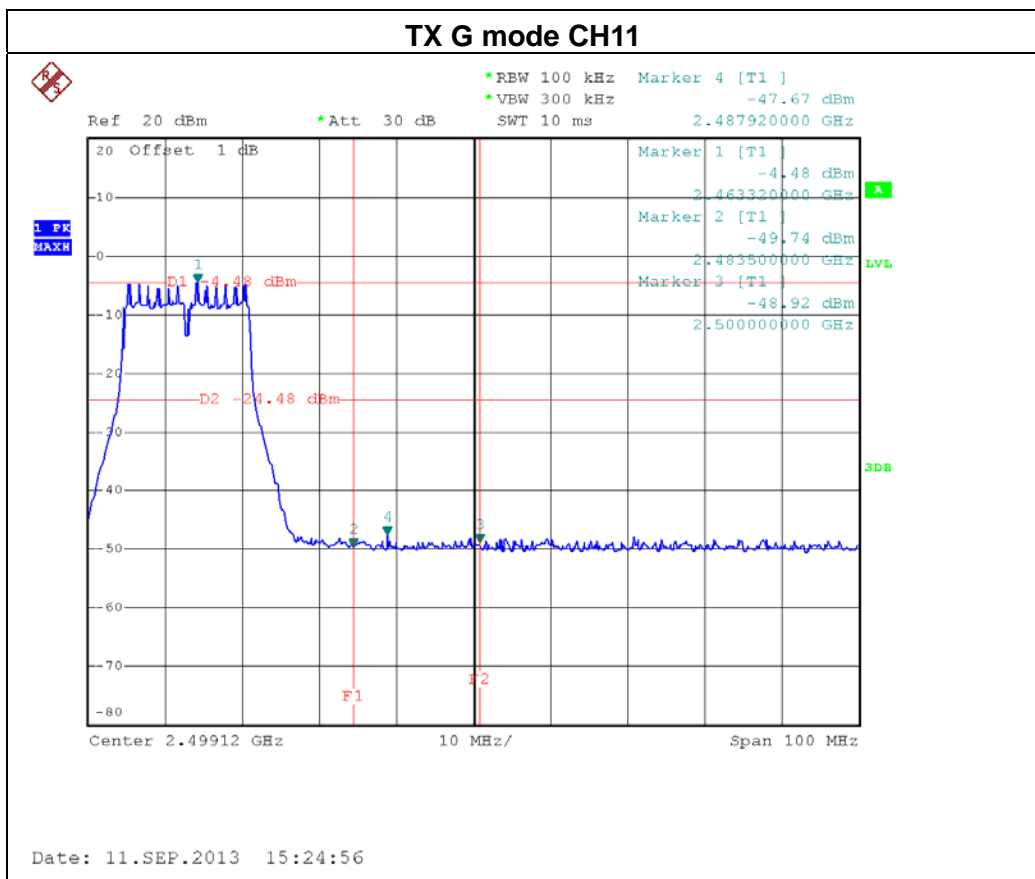
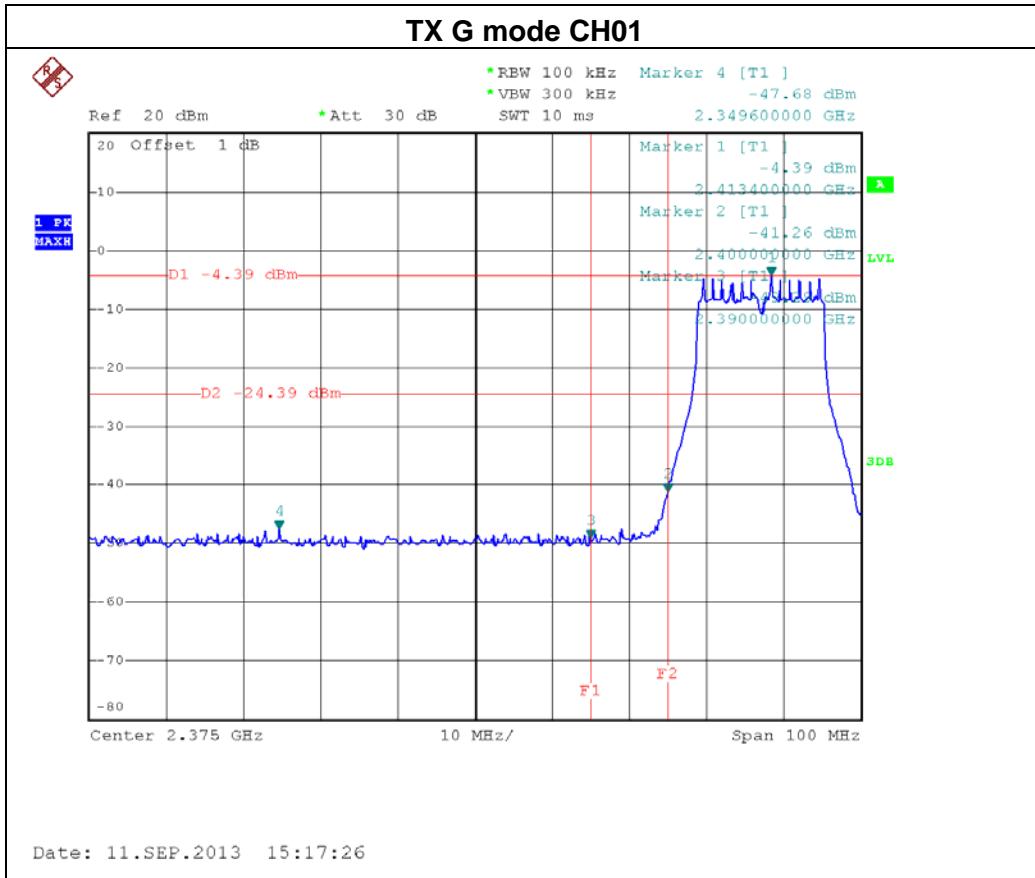



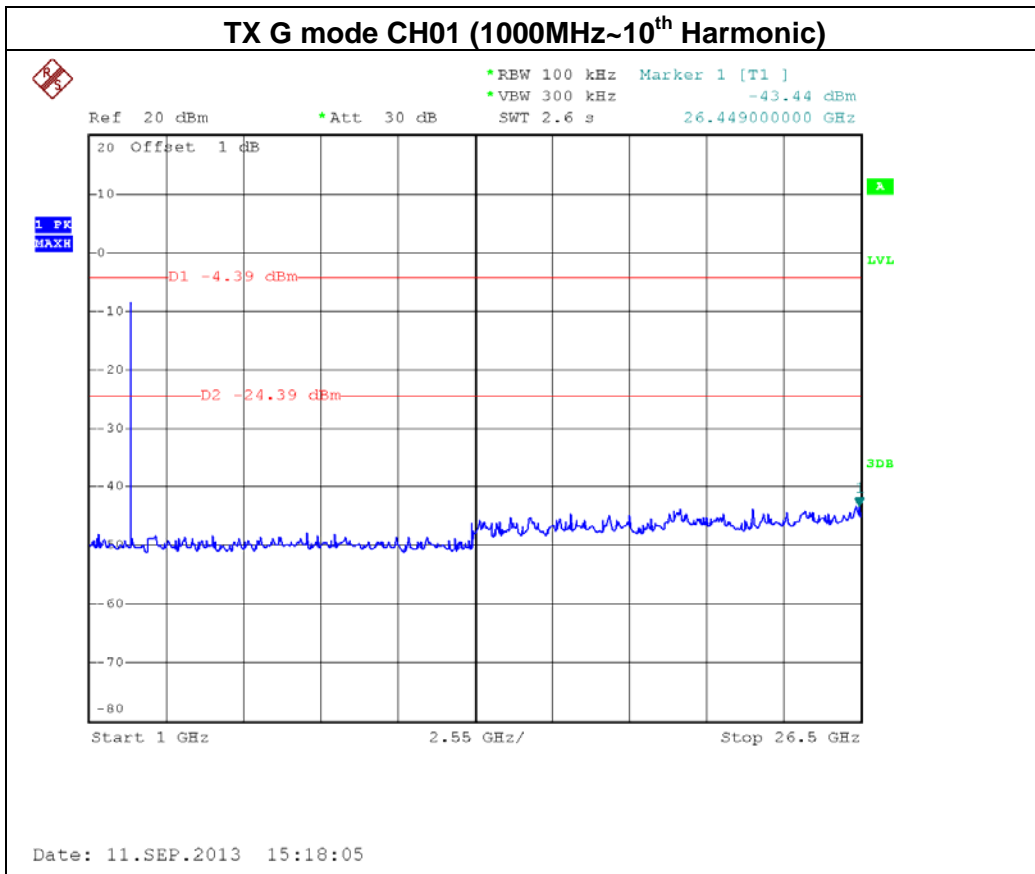
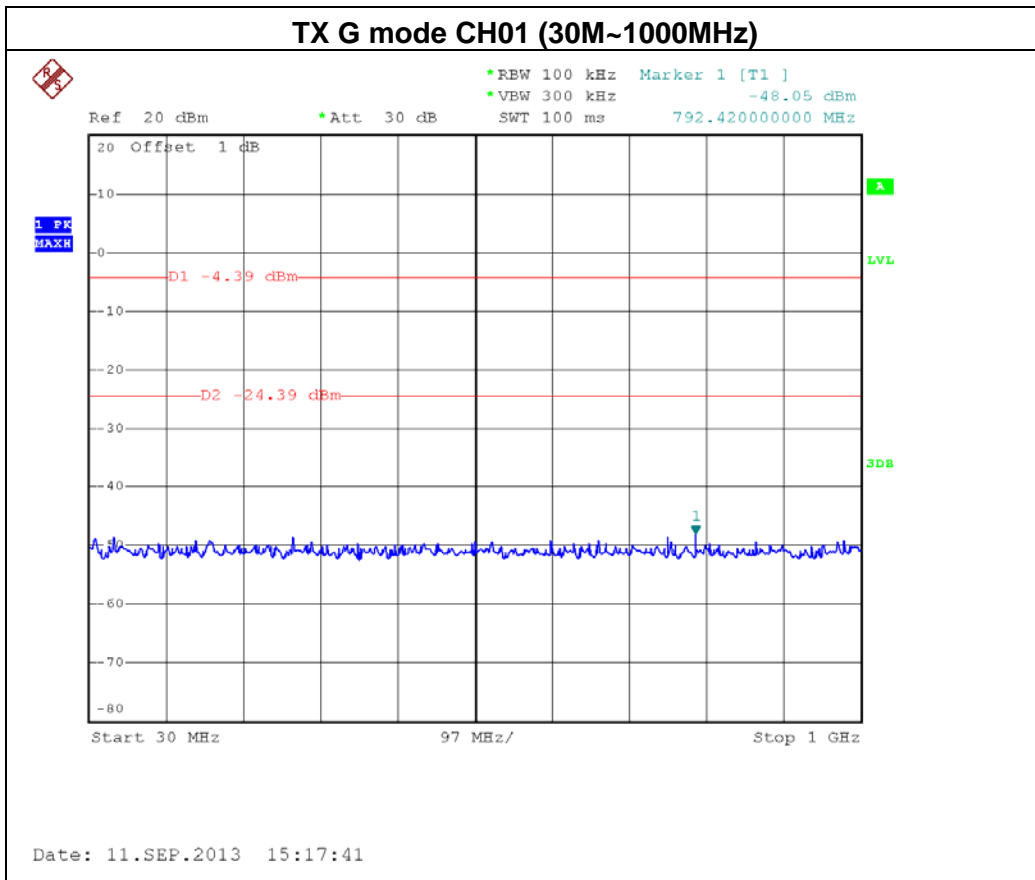

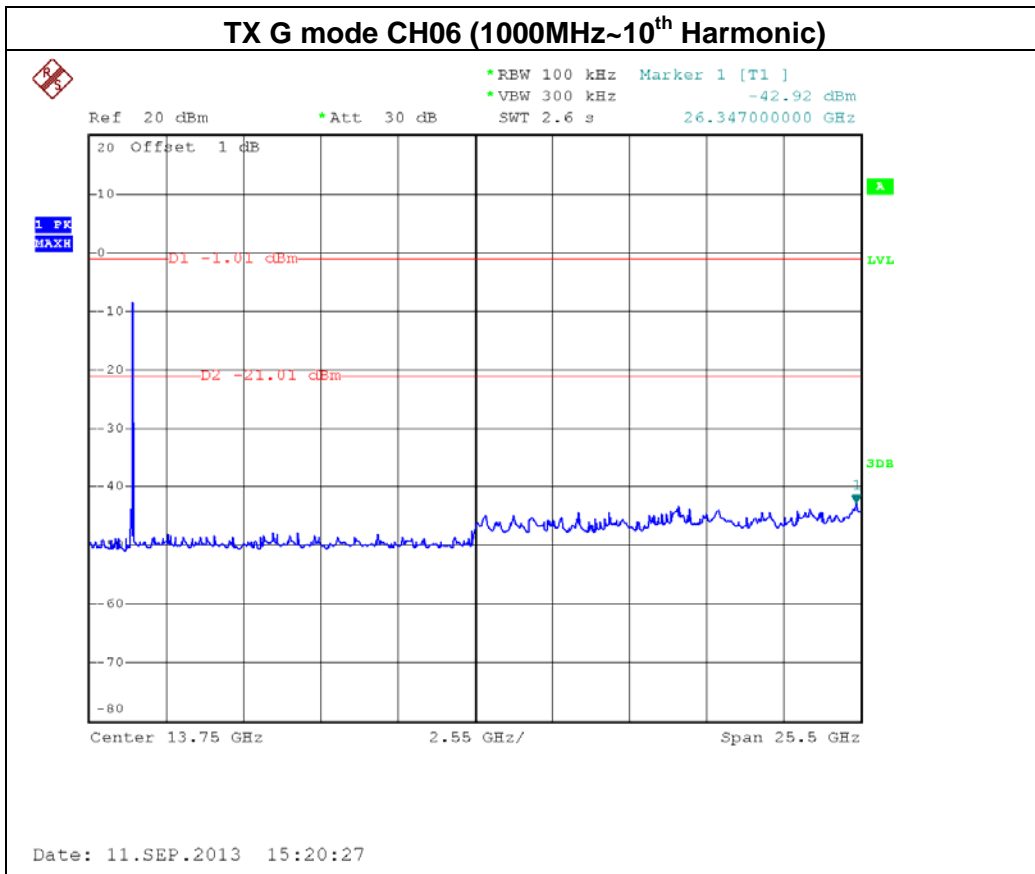
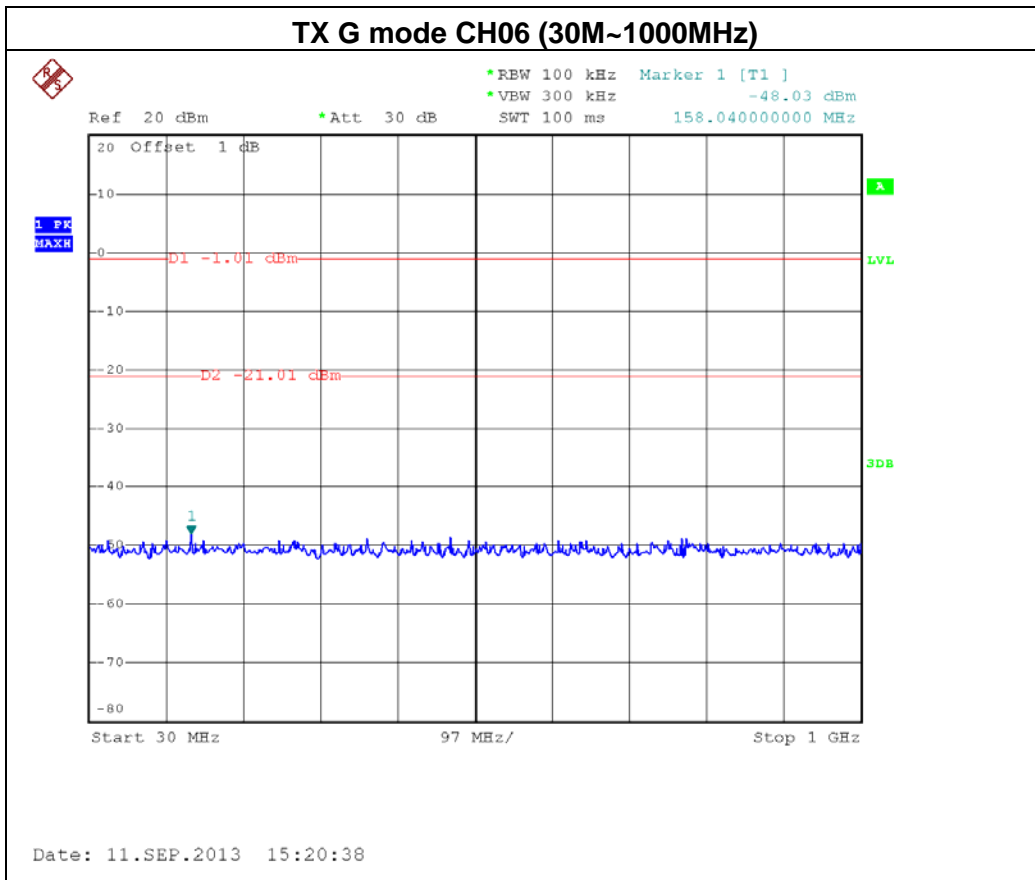

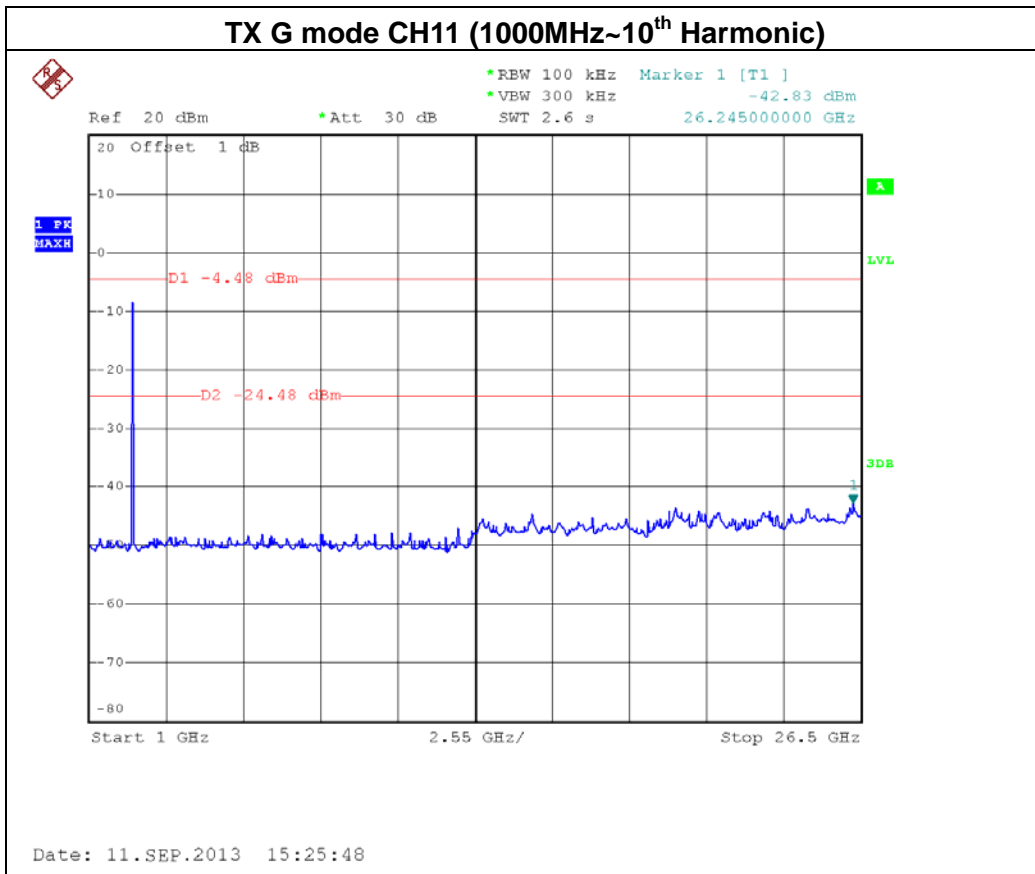
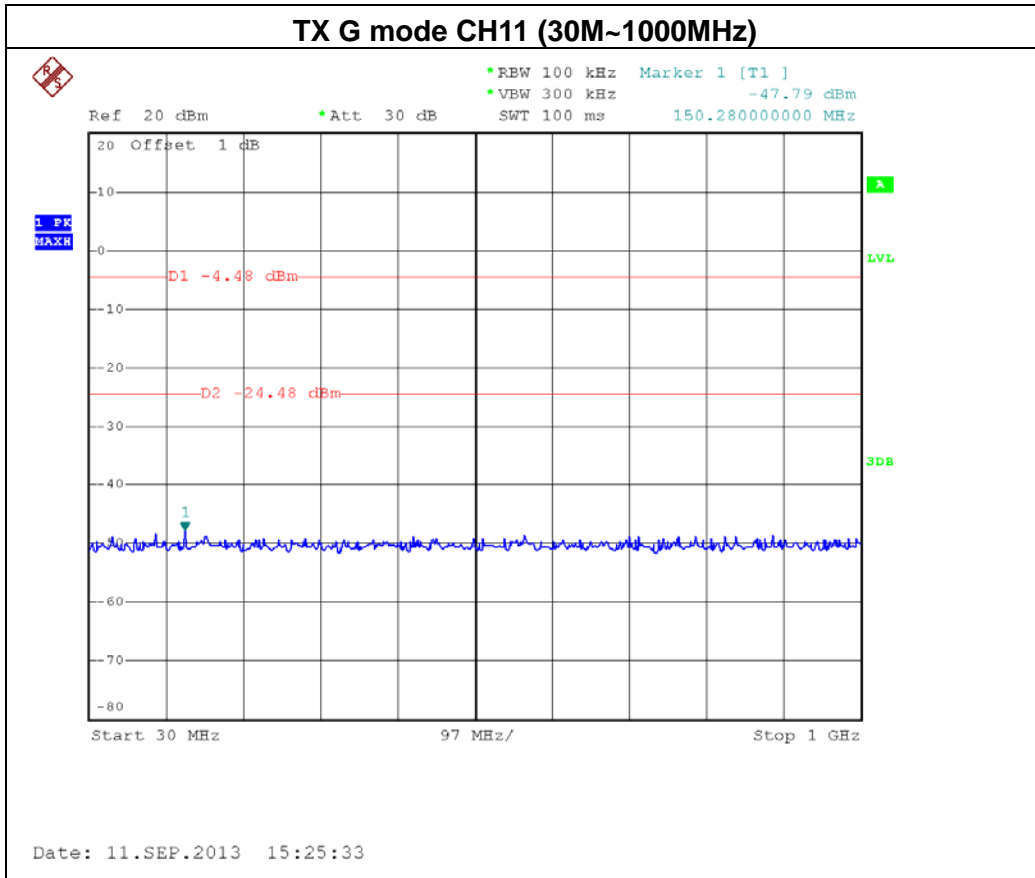



EUT :	Wireless N300 Home Router	Model Name :	W303R
Temperature :	24 °C	Relative Humidity :	60 %
Pressure :	1016 hPa	Test Voltage :	AC 120V/60Hz
Test Mode :	TX N-20M MODE / CH01, CH06 , CH11-ANT 0		

Channel of Worst Data: CH01			
The max. radio frequency power in any 100kHz bandwidth outside the frequency band		The max. radio frequency power in any 100 kHz bandwidth within the frequency band.	
FREQUENCY(MHz)	POWER(dBm)	FREQUENCY(MHz)	POWER(dBm)
2400.00	-43.65	2489.20	-48.05
Result			
In any 100kHz bandwidth outside the frequency band, the radio frequency power is at least 20dB below that in the 100kHz bandwidth within the band that contains the highest level of the desired power.			

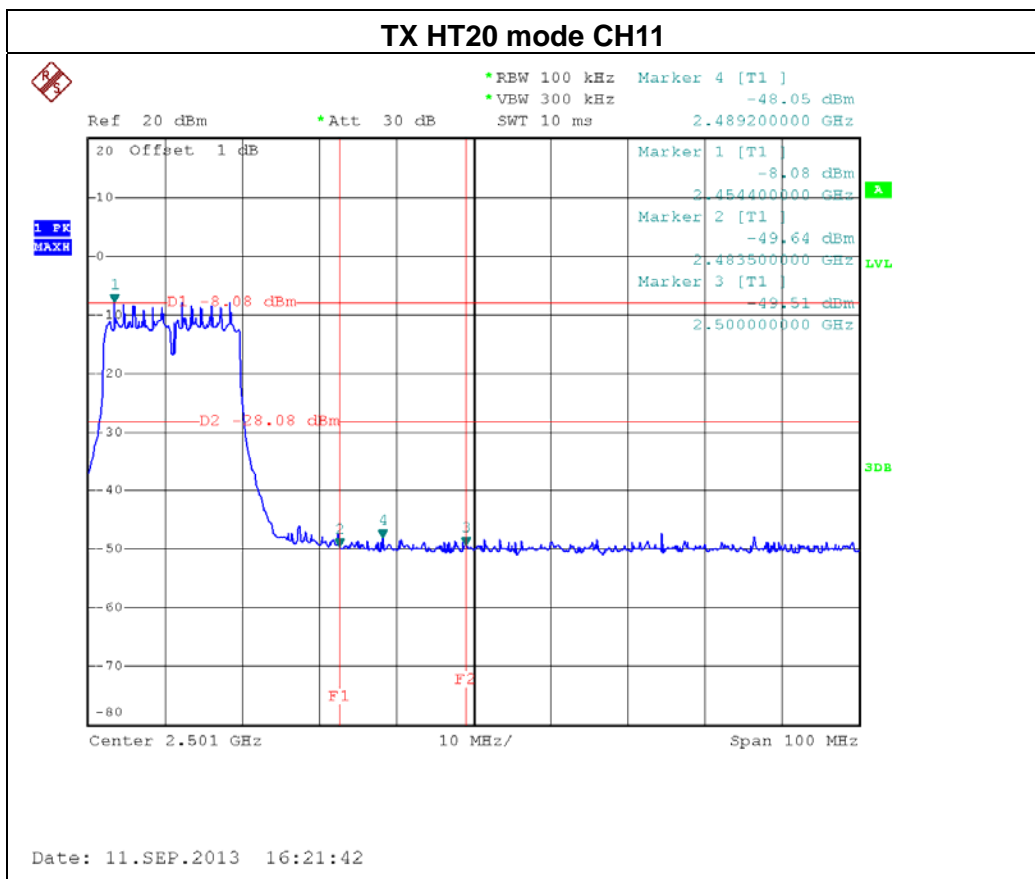
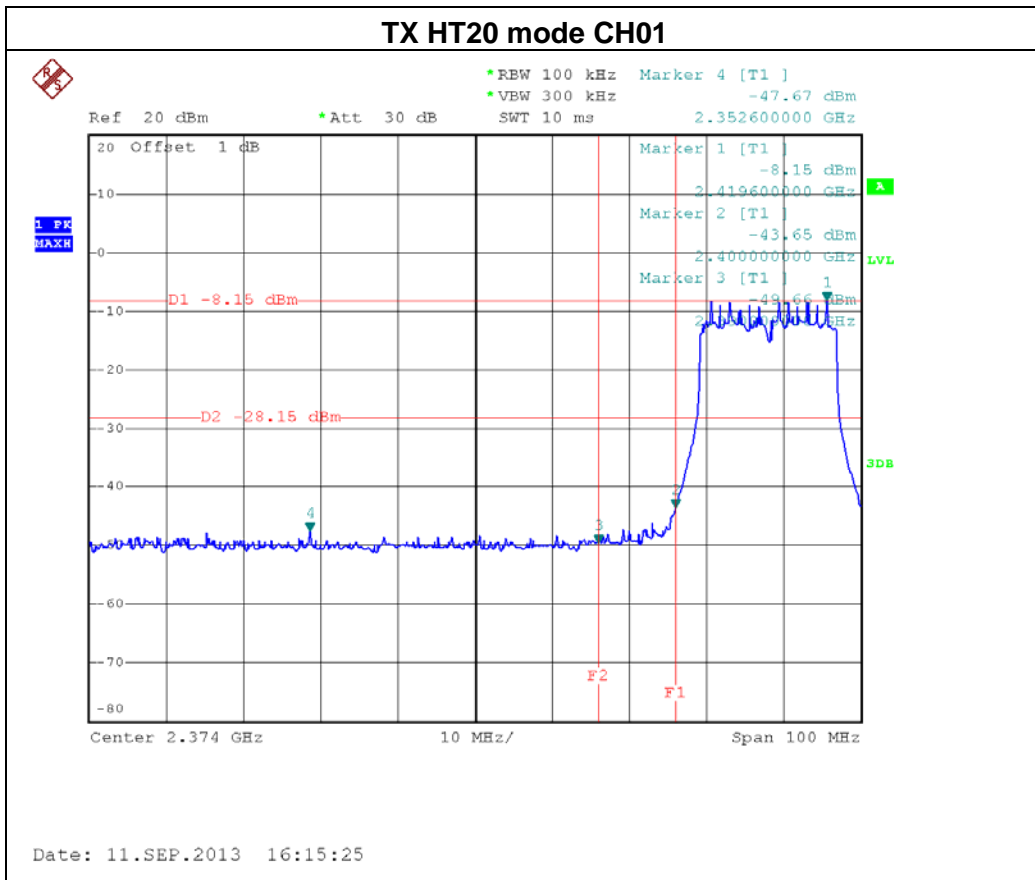

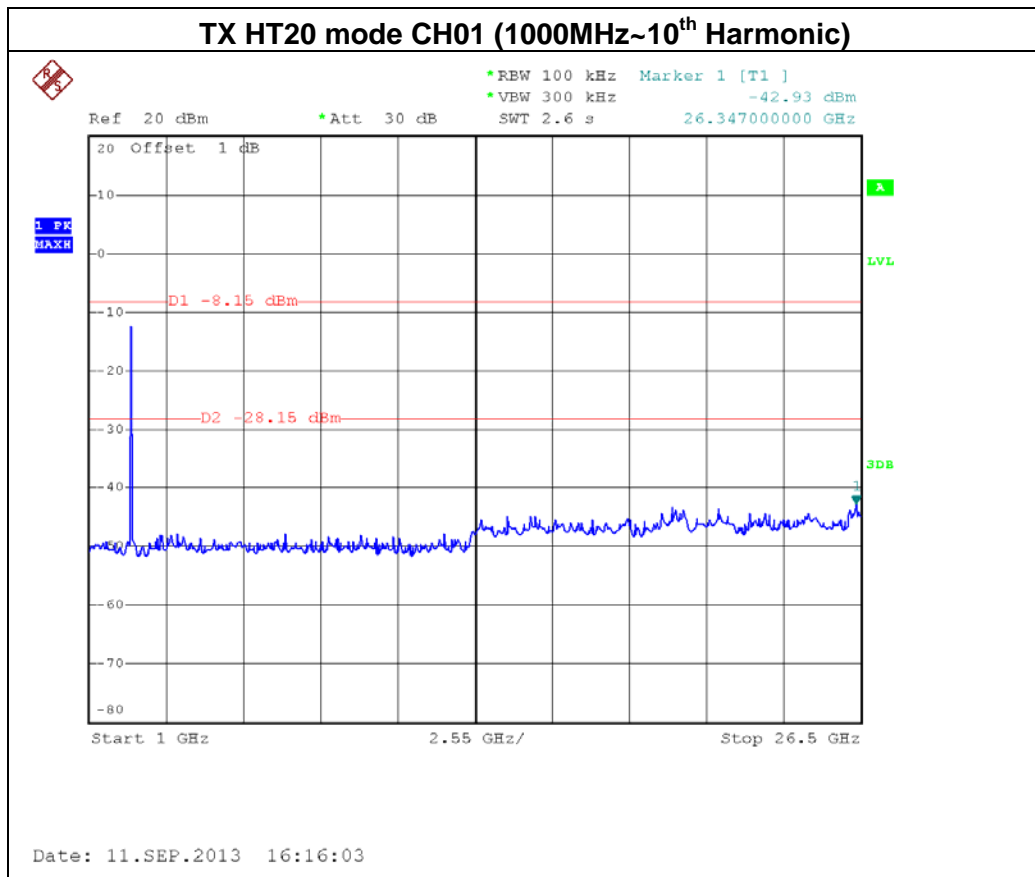
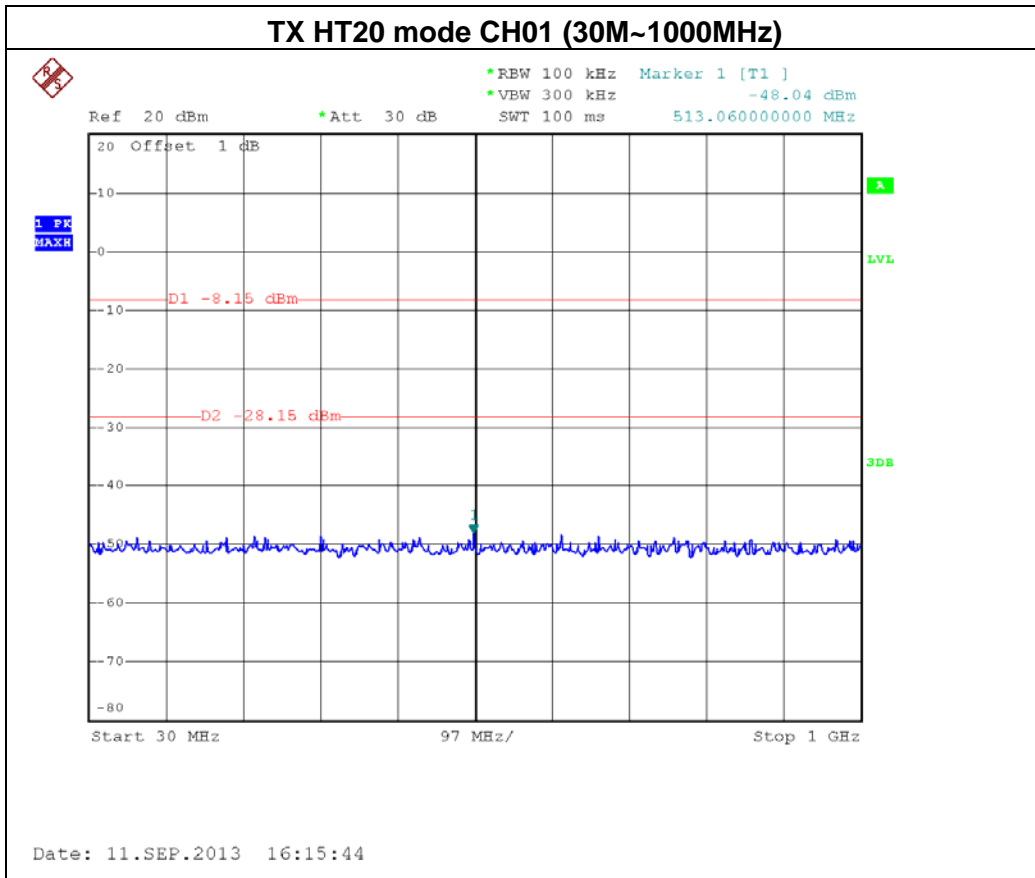

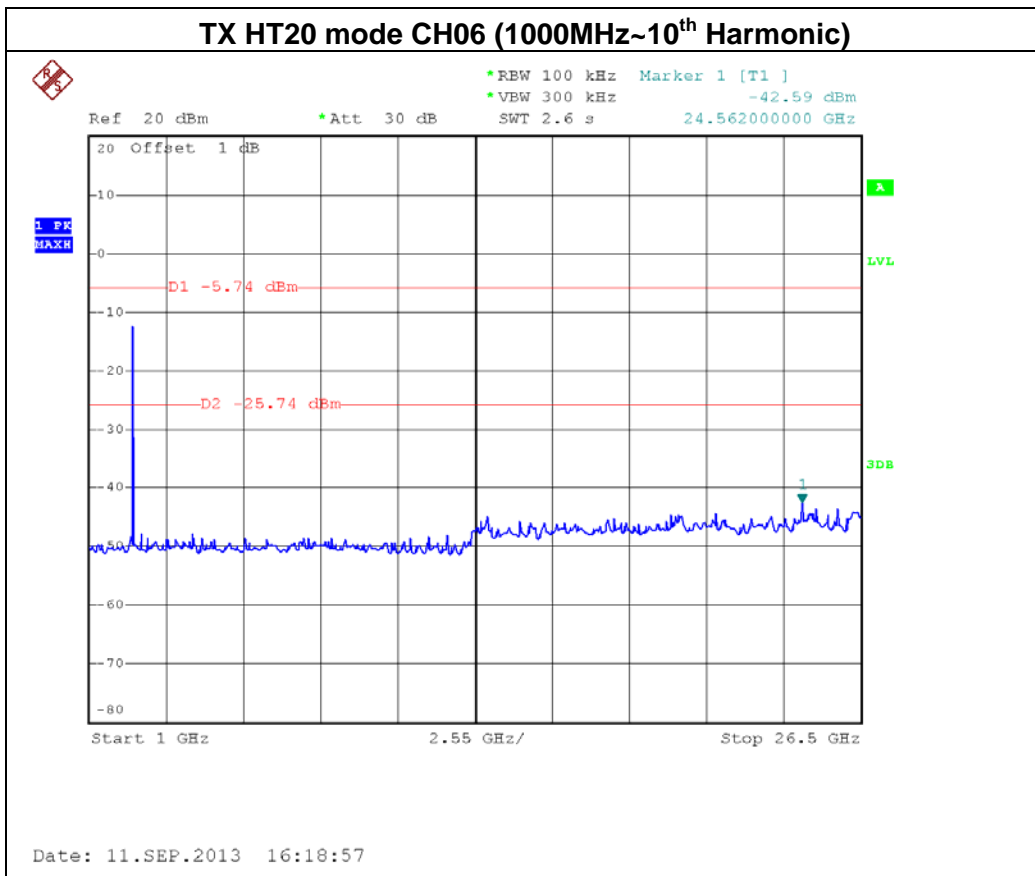
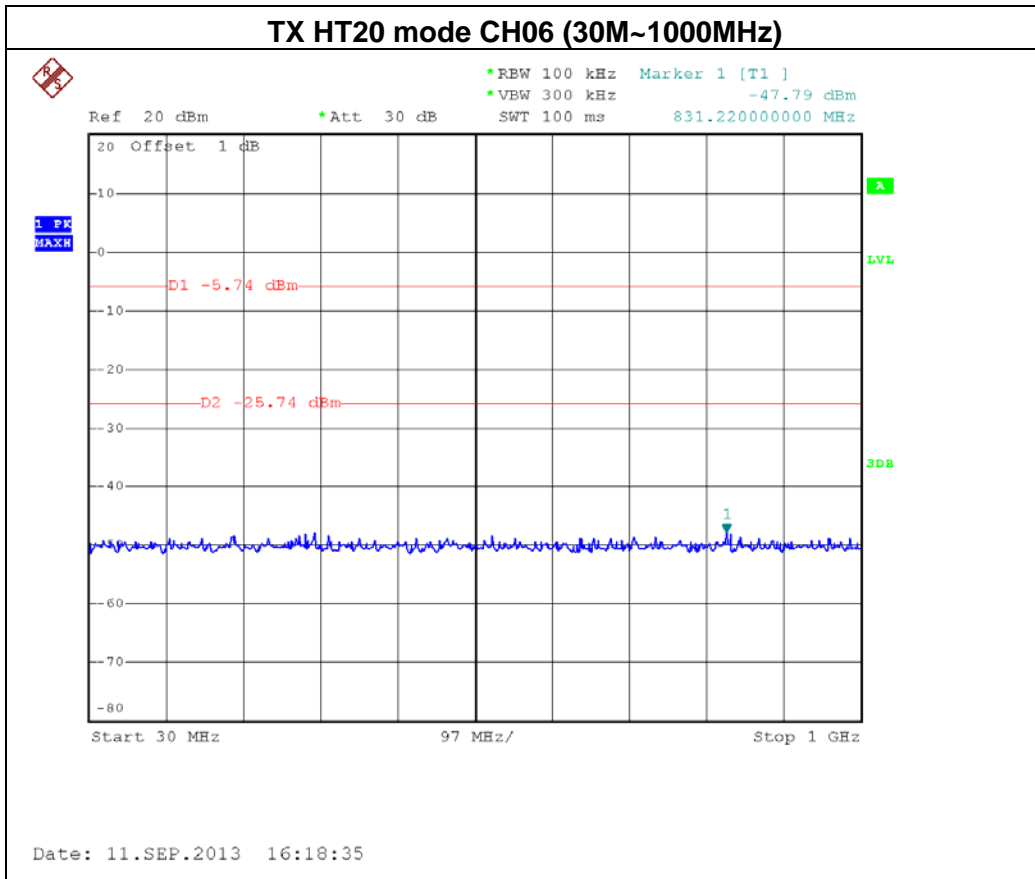

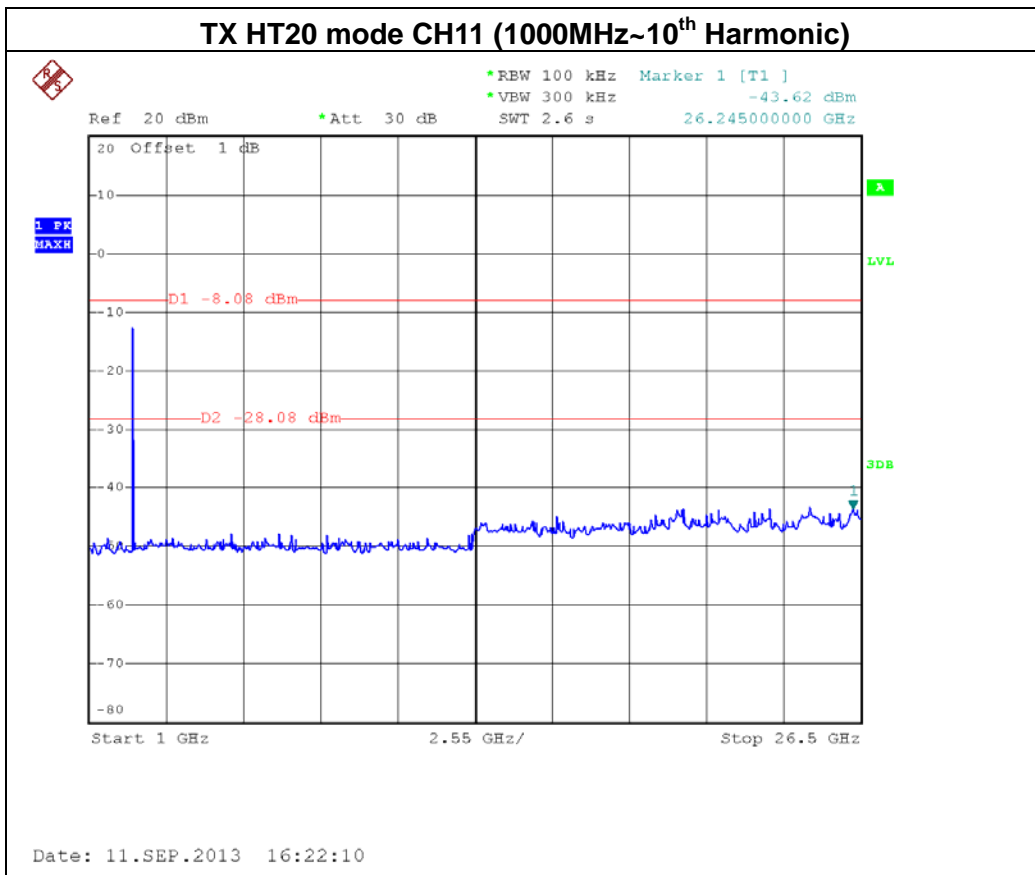
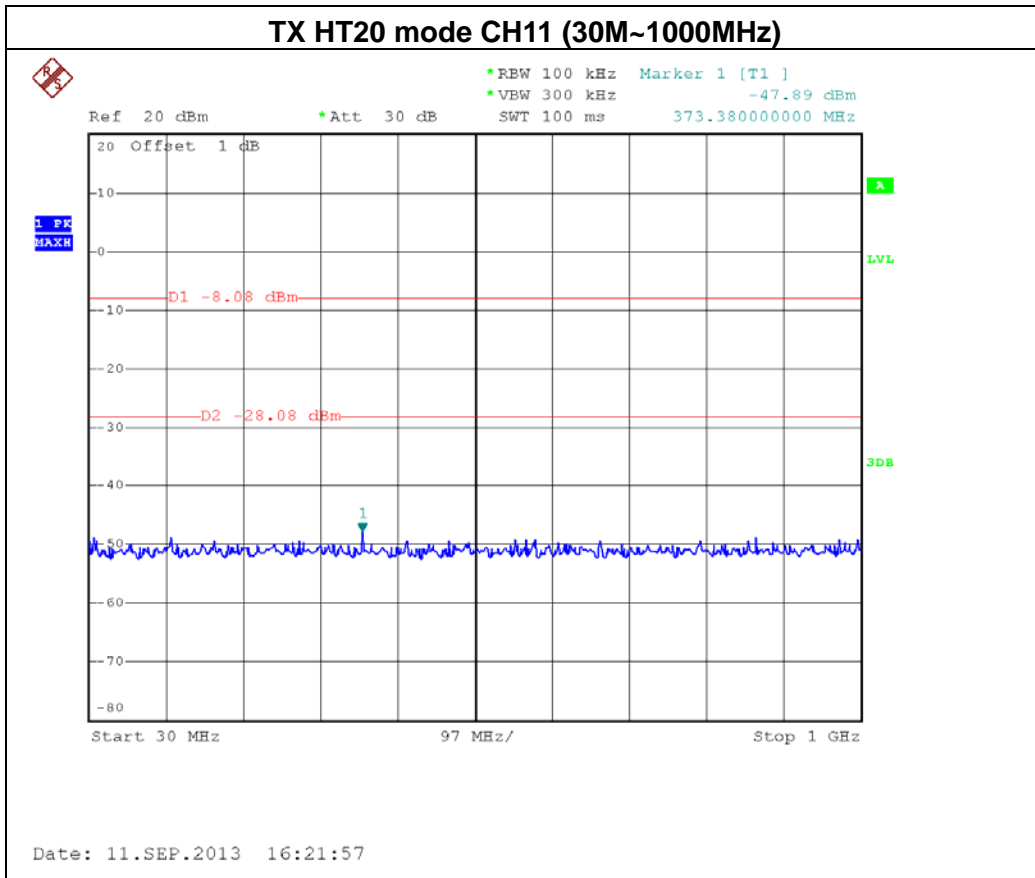





EUT :	Wireless N300 Home Router	Model Name :	W303R
Temperature :	24 °C	Relative Humidity :	60 %
Pressure :	1016 hPa	Test Voltage :	AC 120V/60Hz
Test Mode :	TX N-20M MODE / CH01, CH06 , CH11-ANT 1		

Channel of Worst Data: CH01			
The max. radio frequency power in any 100kHz bandwidth outside the frequency band		The max. radio frequency power in any 100 kHz bandwidth within the frequency band.	
FREQUENCY(MHz)	POWER(dBm)	FREQUENCY(MHz)	POWER(dBm)
2400.00	-42.01	2488.20	-48.58
Result			
In any 100kHz bandwidth outside the frequency band, the radio frequency power is at least 20dB below that in the 100kHz bandwidth within the band that contains the highest level of the desired power.			

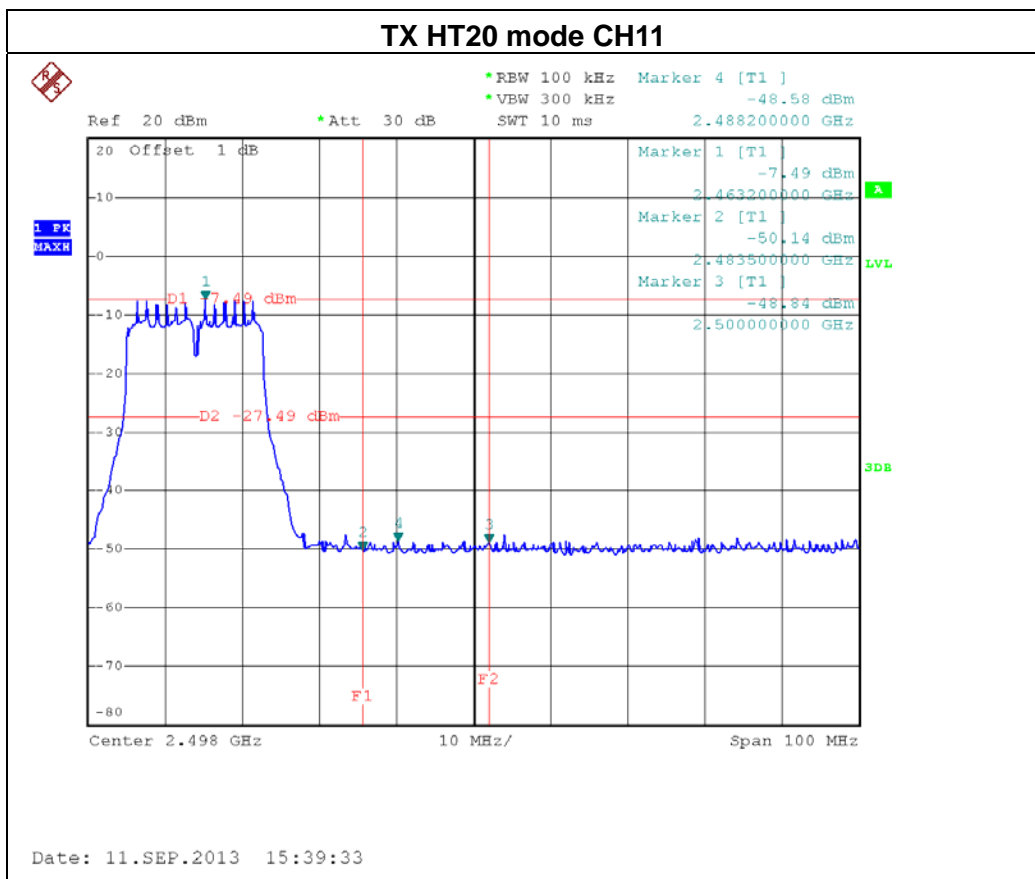
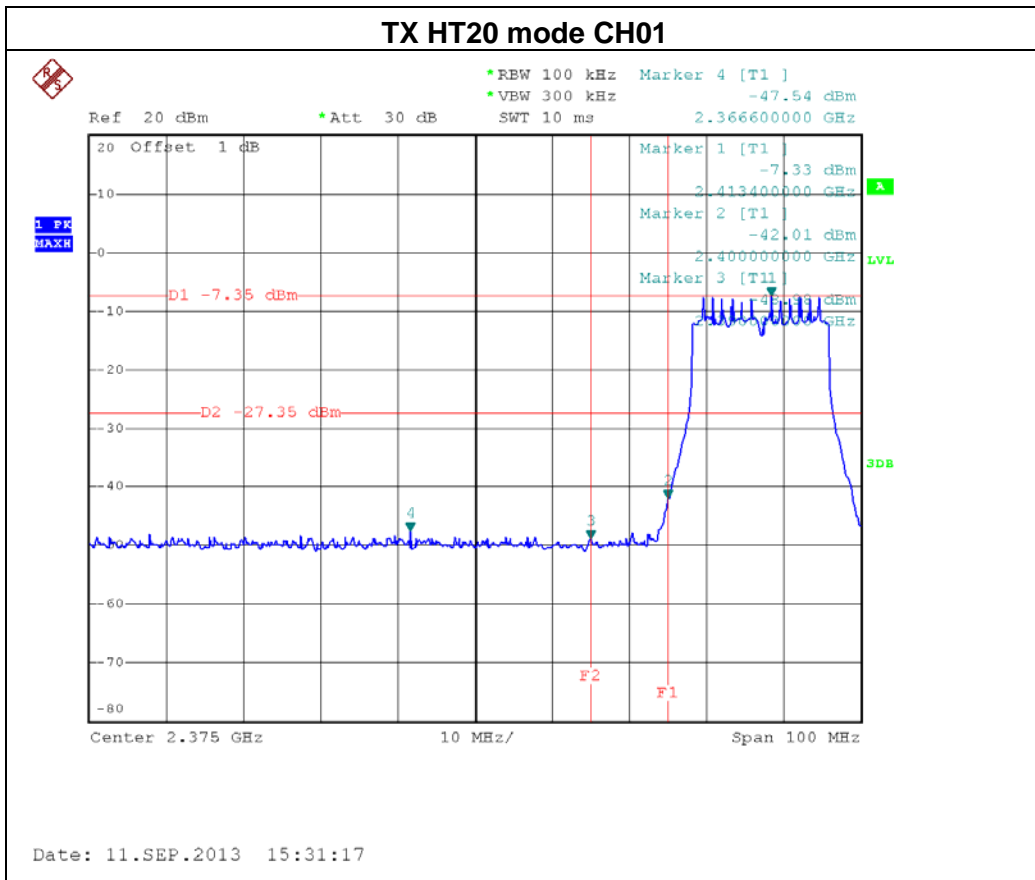

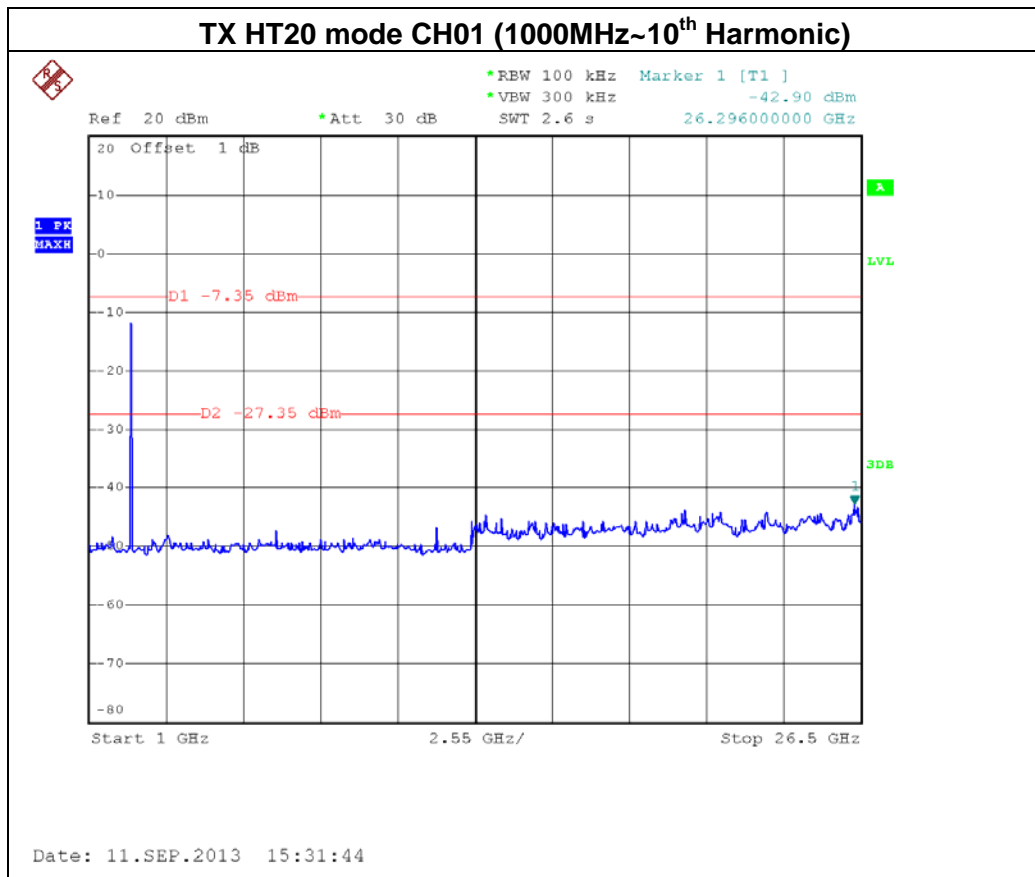
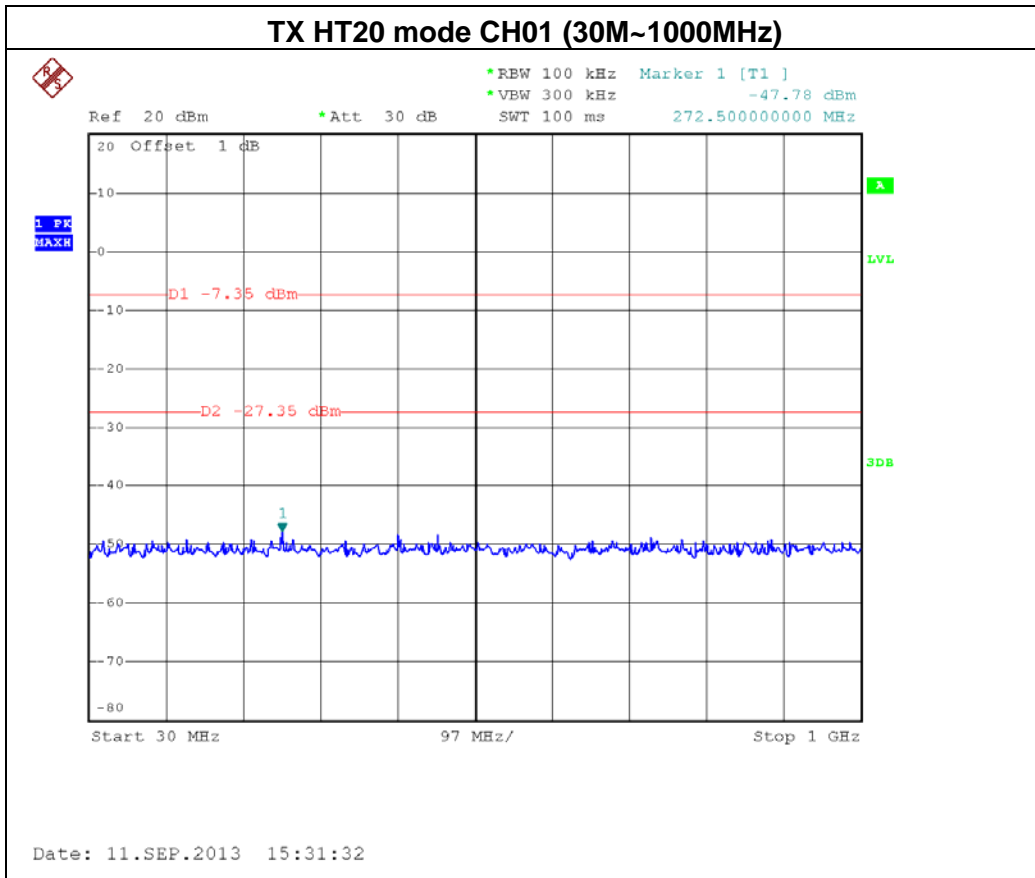



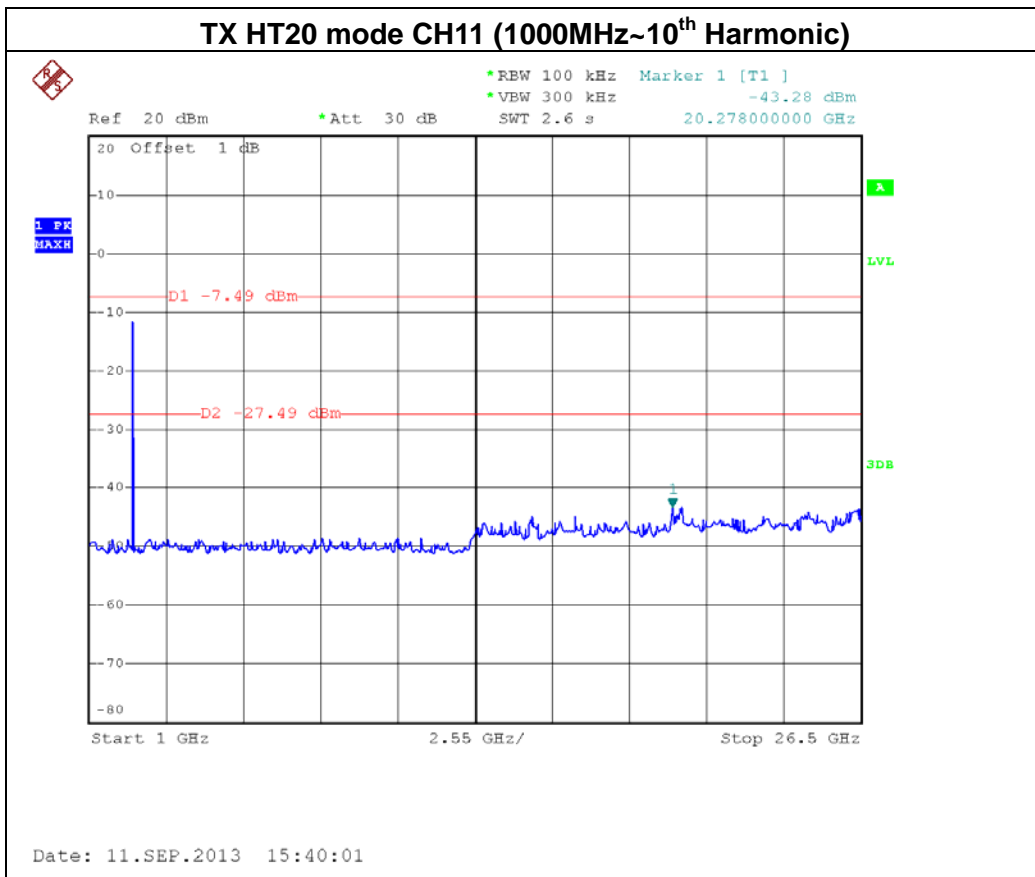
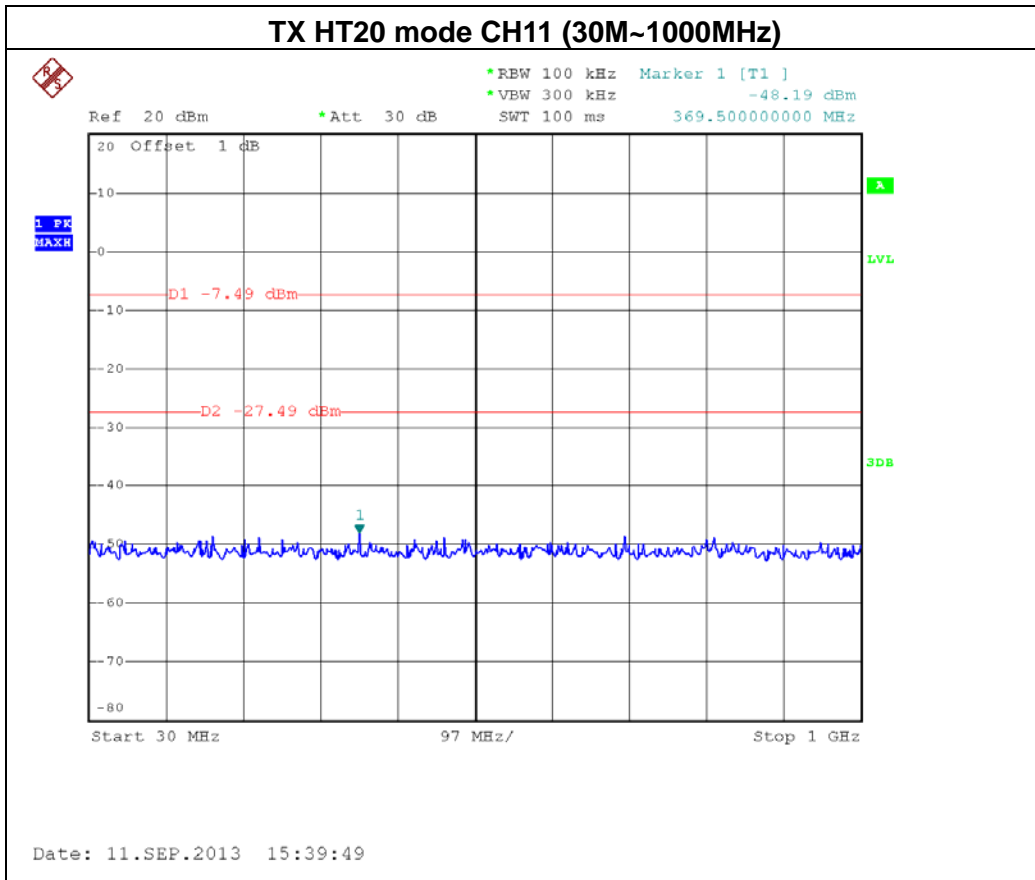



EUT :	Wireless N300 Home Router	Model Name :	W303R
Temperature :	24 °C	Relative Humidity :	60 %
Pressure :	1016 hPa	Test Voltage :	AC 120V/60Hz
Test Mode :	TX N-40M MODE / CH03, CH06 , CH09-ANT 0		

Channel of Worst Data: CH09			
The max. radio frequency power in any 100kHz bandwidth outside the frequency band		The max. radio frequency power in any 100 kHz bandwidth within the frequency band.	
FREQUENCY(MHz)	POWER(dBm)	FREQUENCY(MHz)	POWER(dBm)
2400.00	-44.99	2484.51	-44.88
Result			
In any 100kHz bandwidth outside the frequency band, the radio frequency power is at least 20dB below that in the 100kHz bandwidth within the band that contains the highest level of the desired power.			

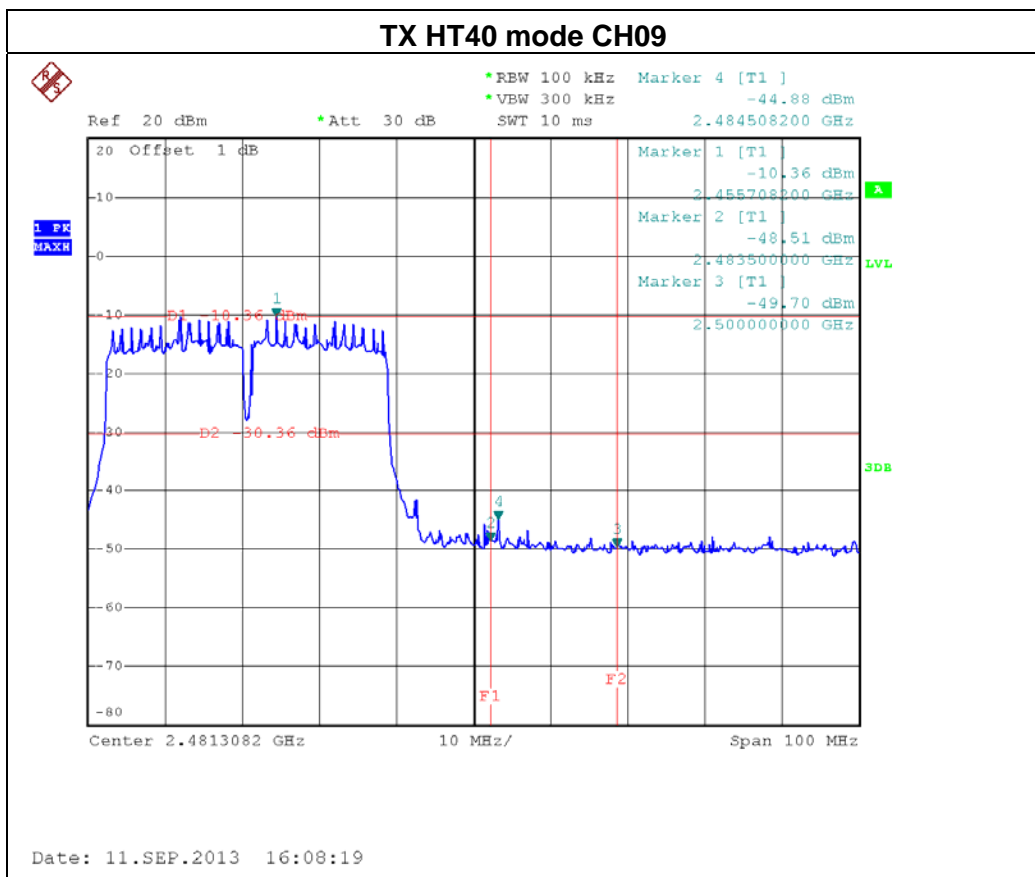
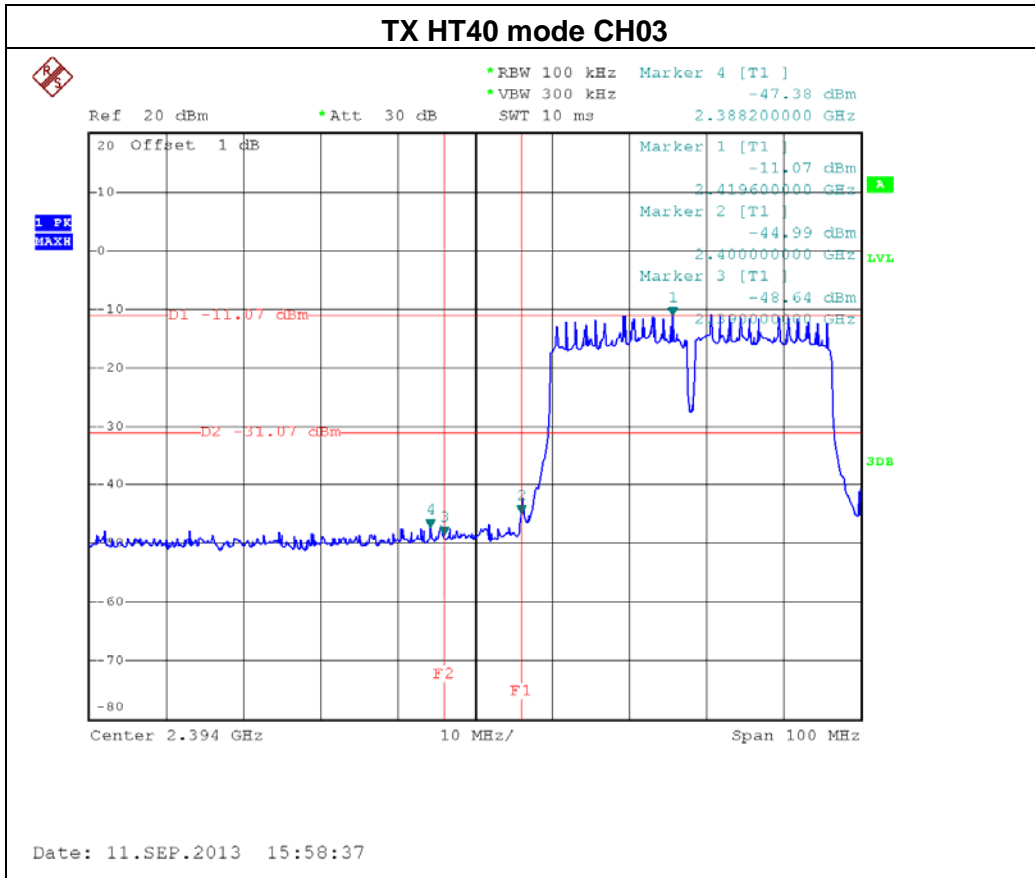

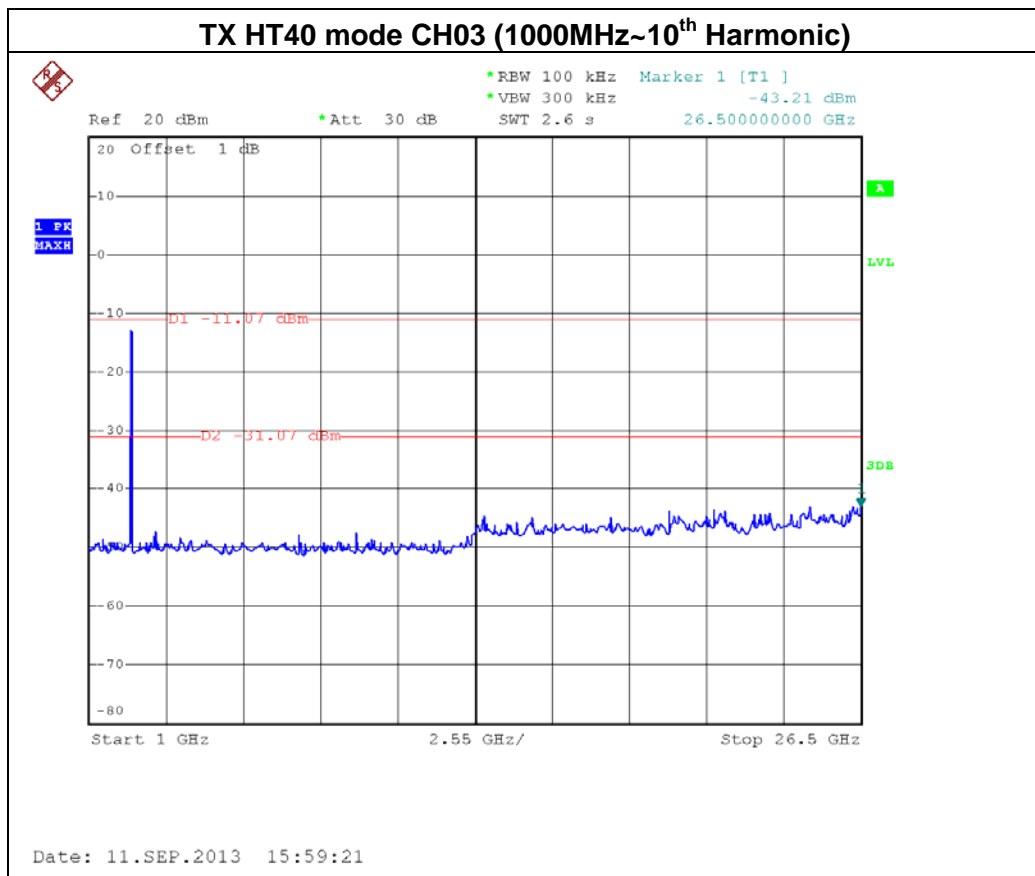
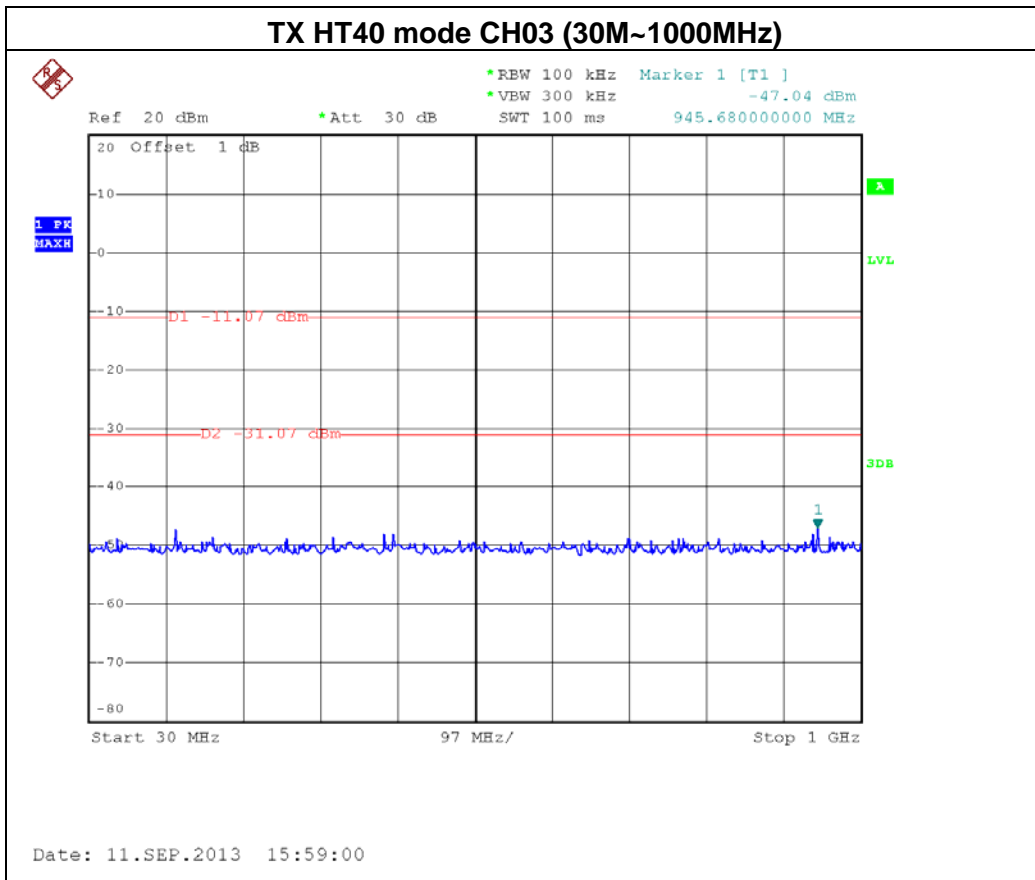



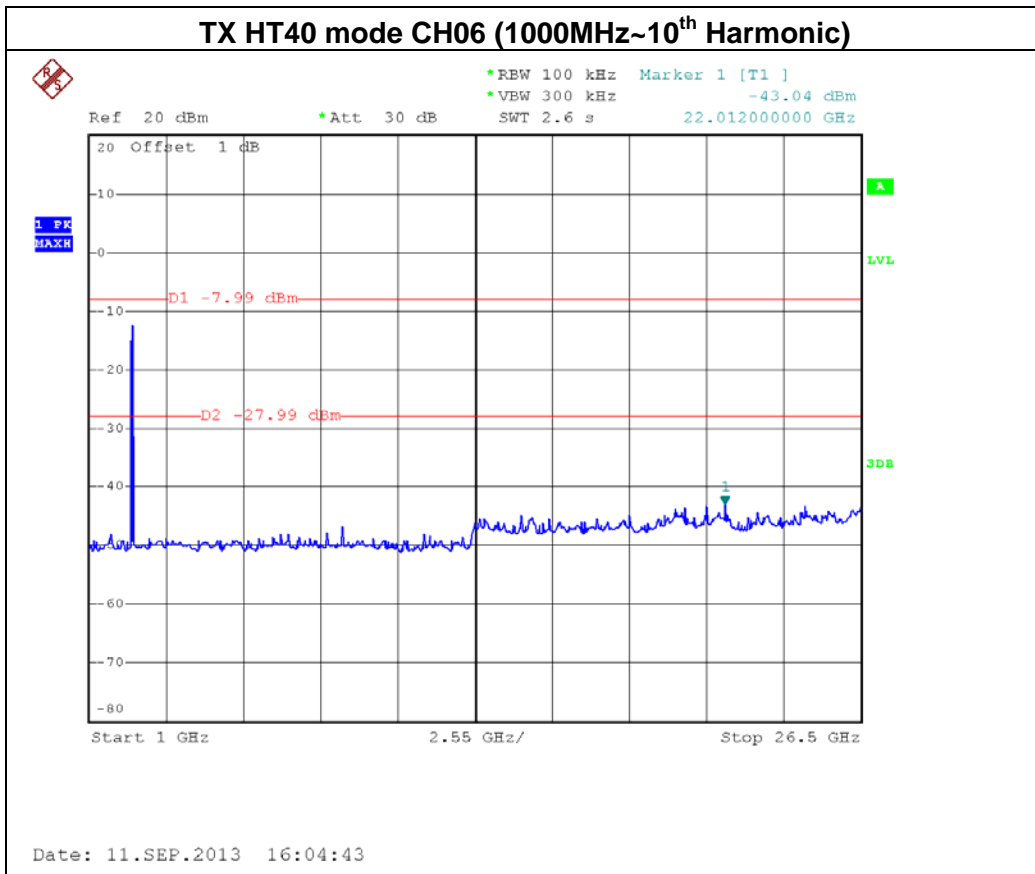
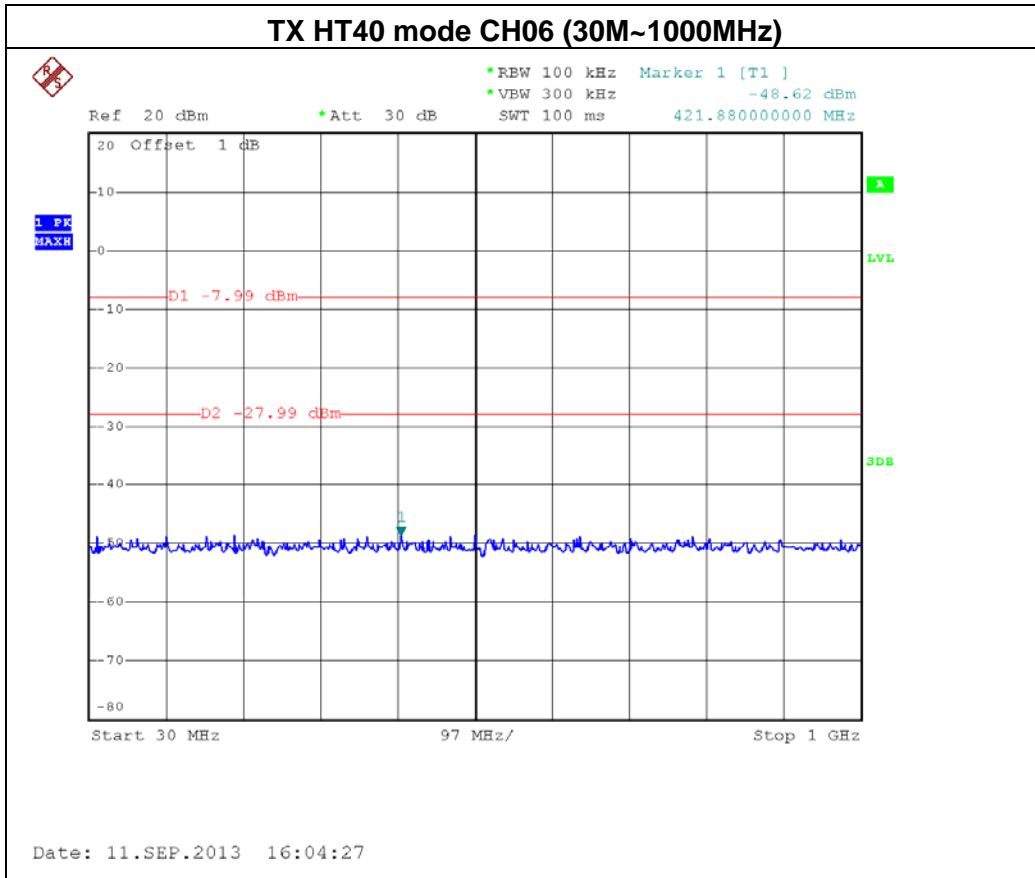

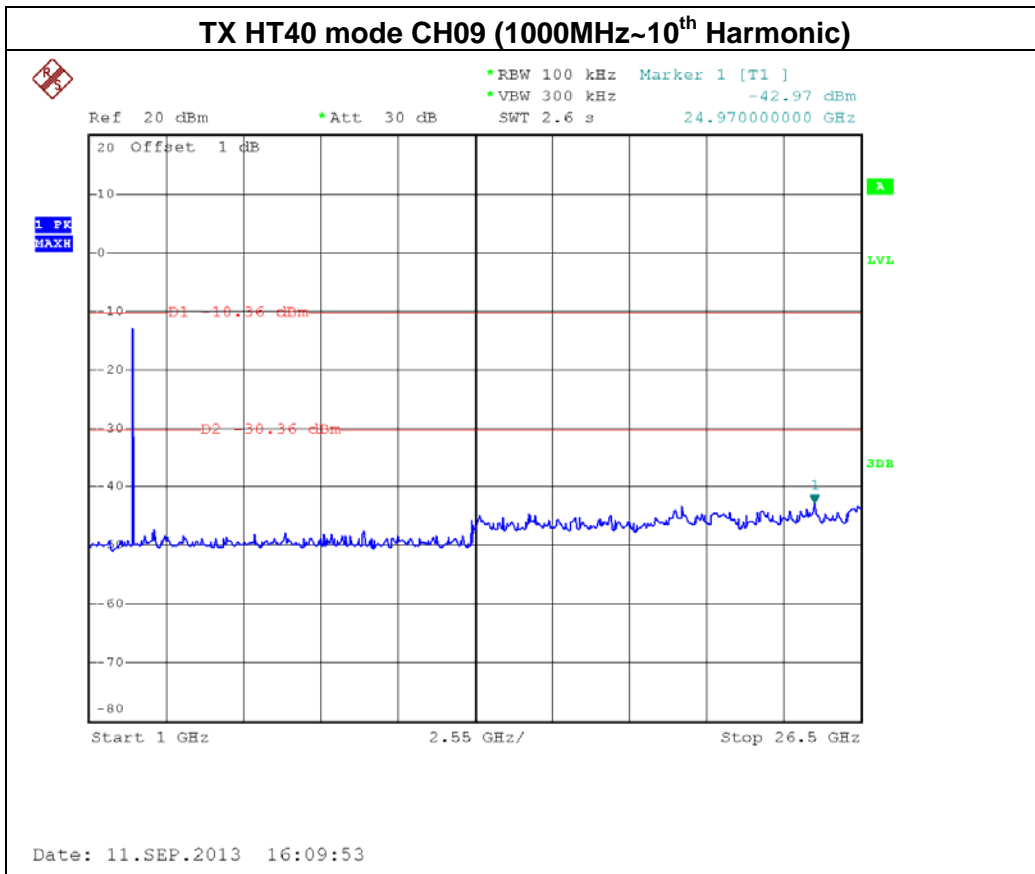
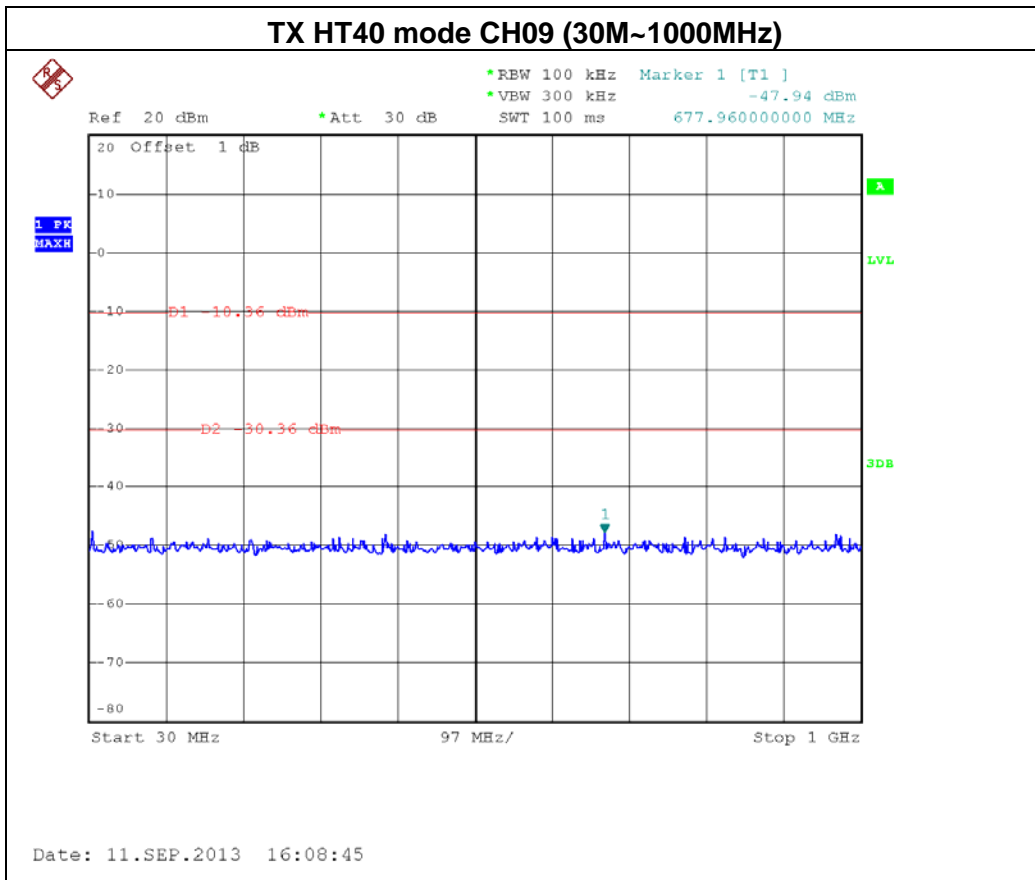



EUT :	Wireless N300 Home Router	Model Name :	W303R
Temperature :	24 °C	Relative Humidity :	60 %
Pressure :	1016 hPa	Test Voltage :	AC 120V/60Hz
Test Mode :	TX N-40M MODE / CH03, CH06 , CH09-ANT 1		

Channel of Worst Data: CH09			
The max. radio frequency power in any 100kHz bandwidth outside the frequency band		The max. radio frequency power in any 100 kHz bandwidth within the frequency band.	
FREQUENCY(MHz)	POWER(dBm)	FREQUENCY(MHz)	POWER(dBm)
2400.00	-44.72	2493.60	-48.48
Result			
In any 100kHz bandwidth outside the frequency band, the radio frequency power is at least 20dB below that in the 100kHz bandwidth within the band that contains the highest level of the desired power.			

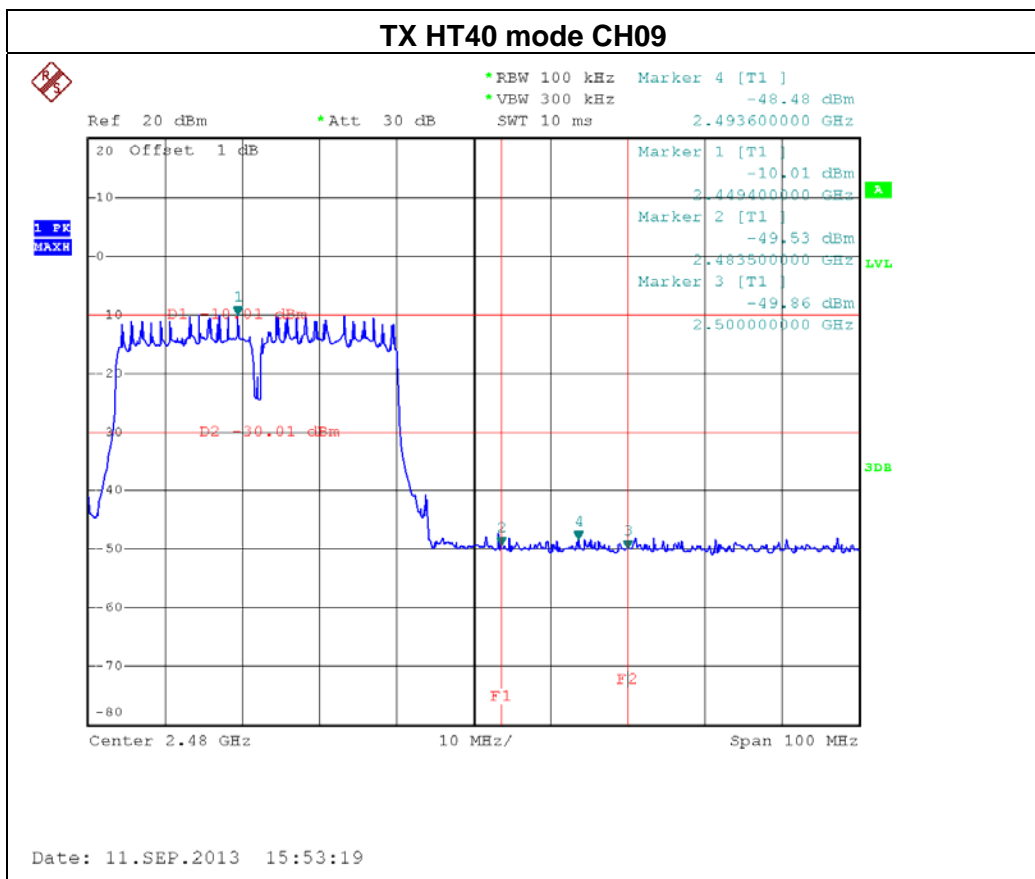
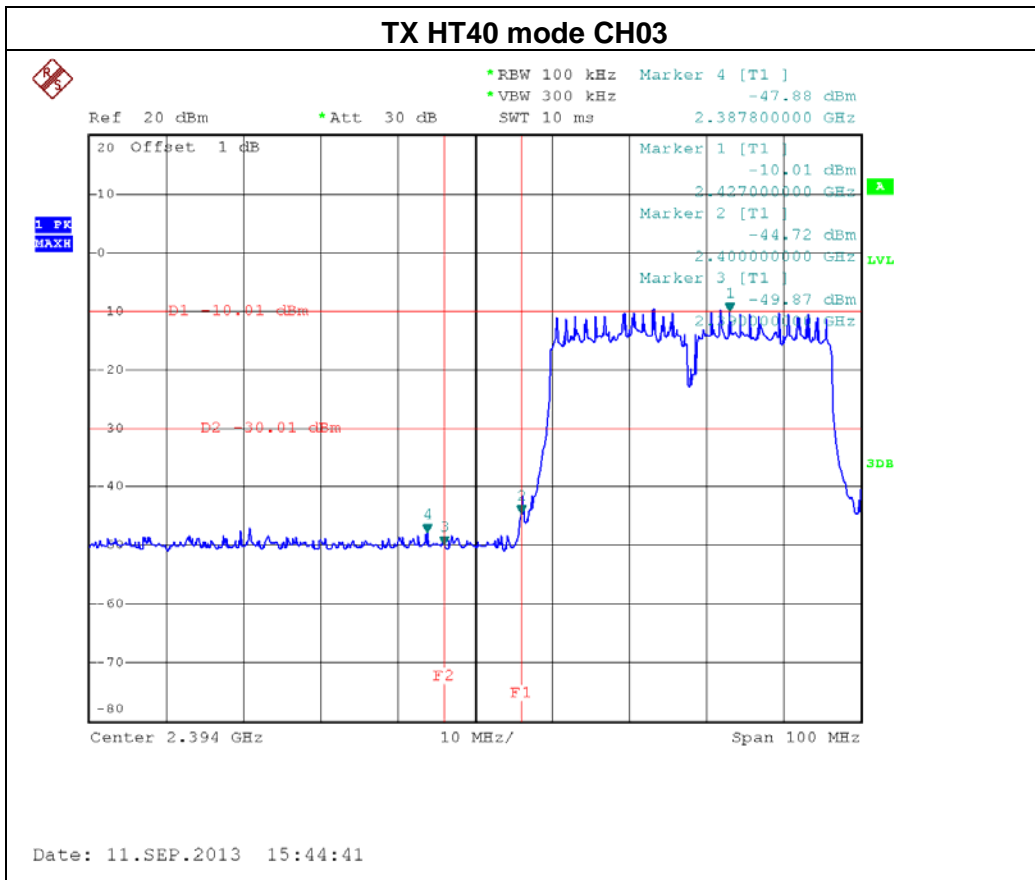

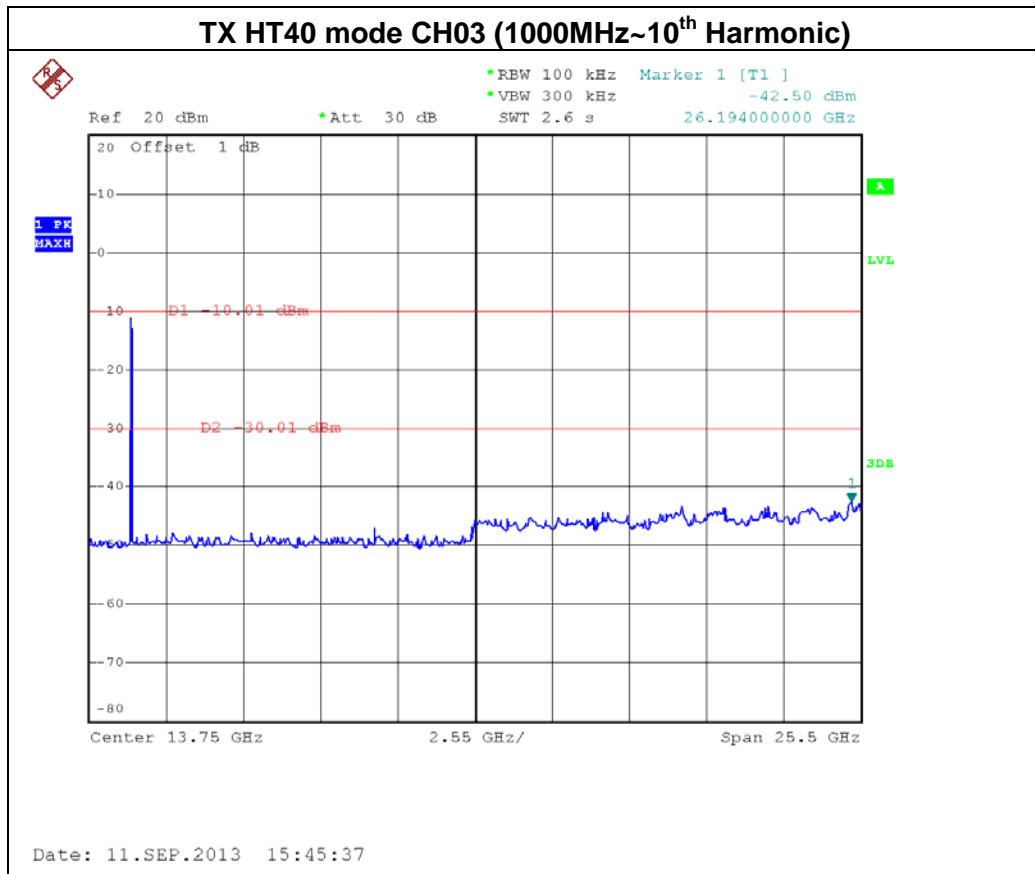
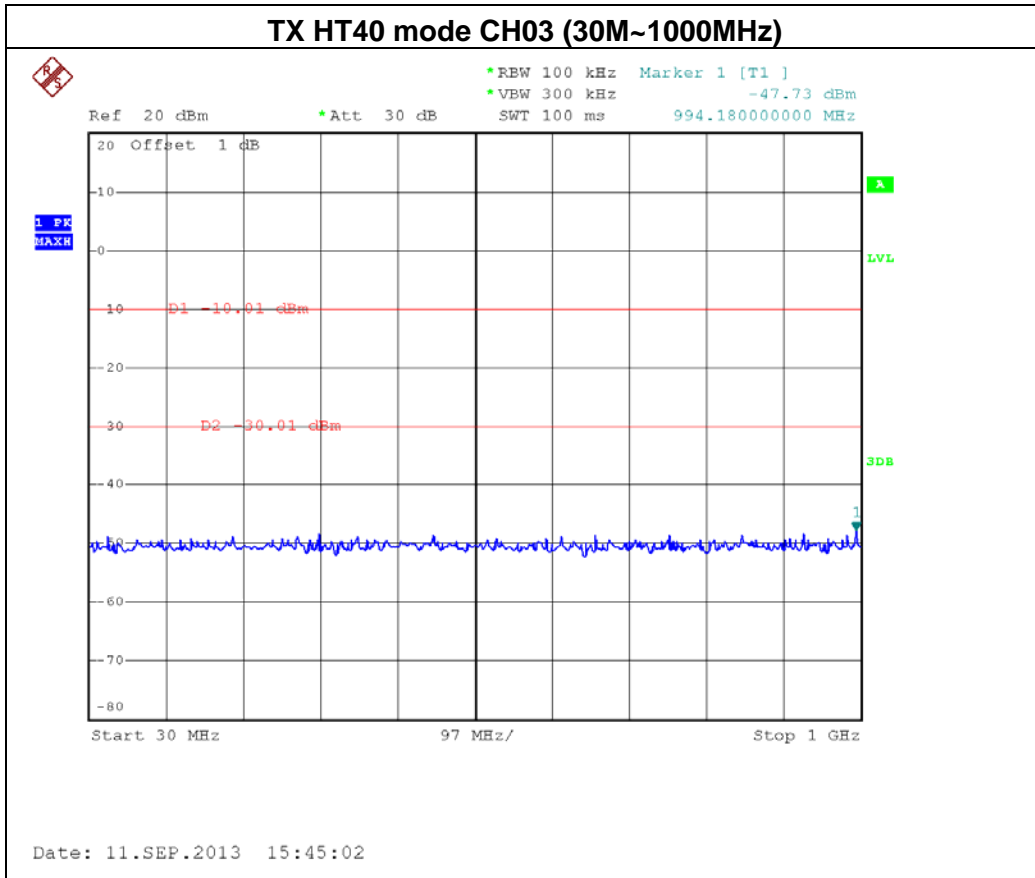

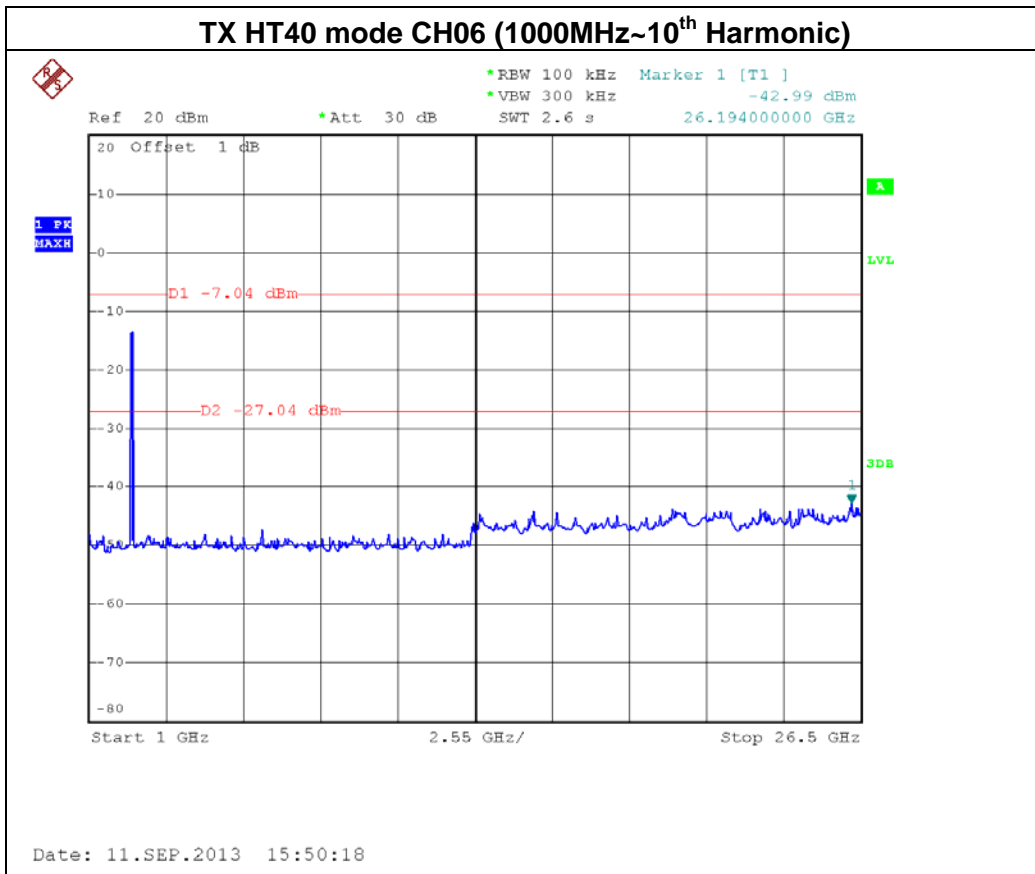
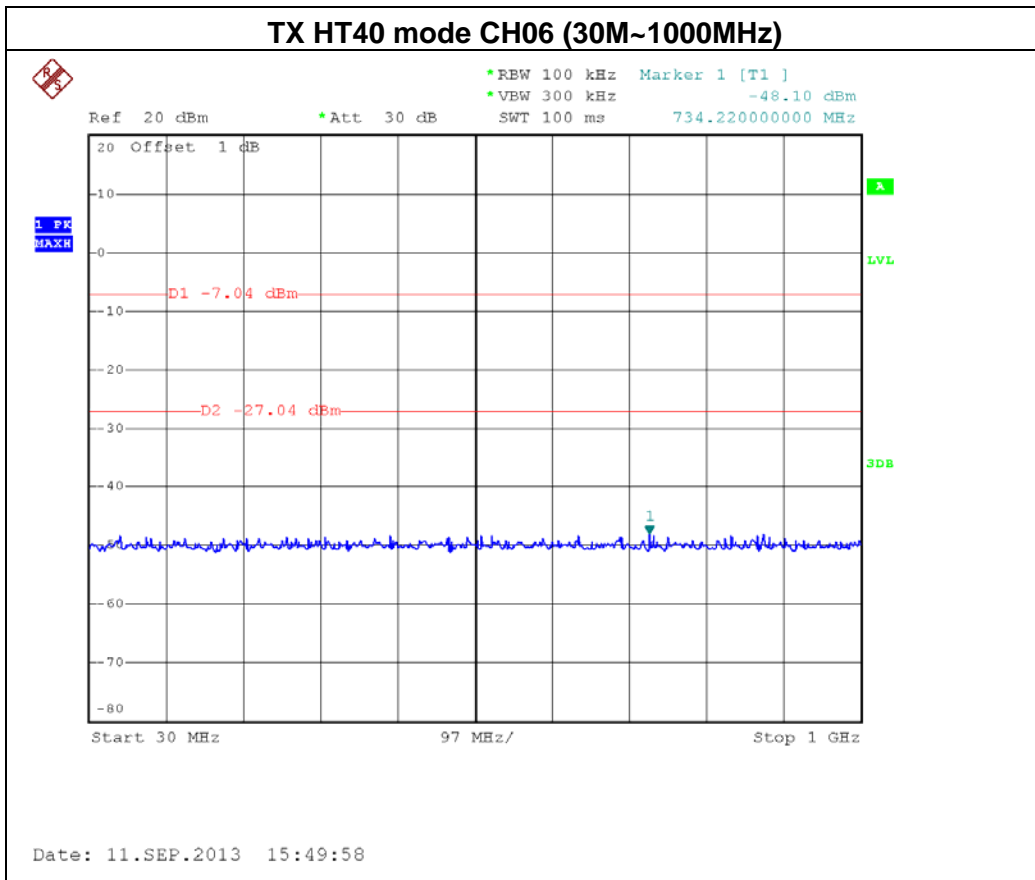

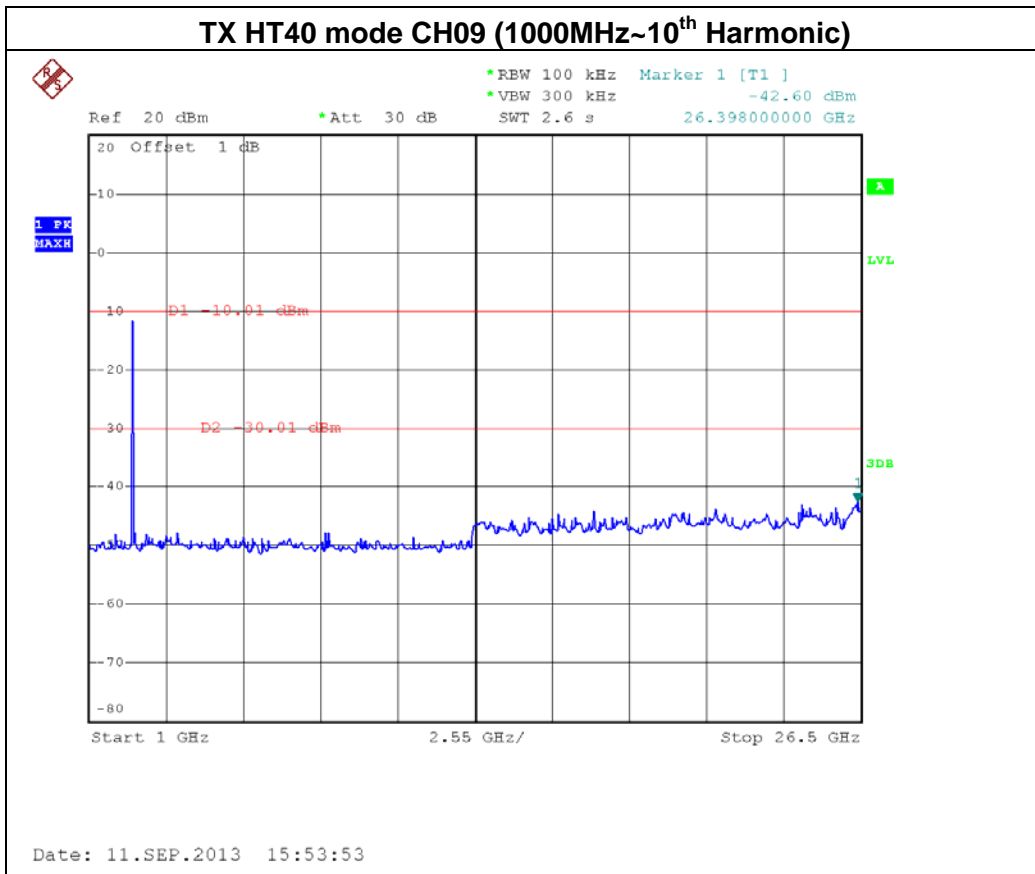
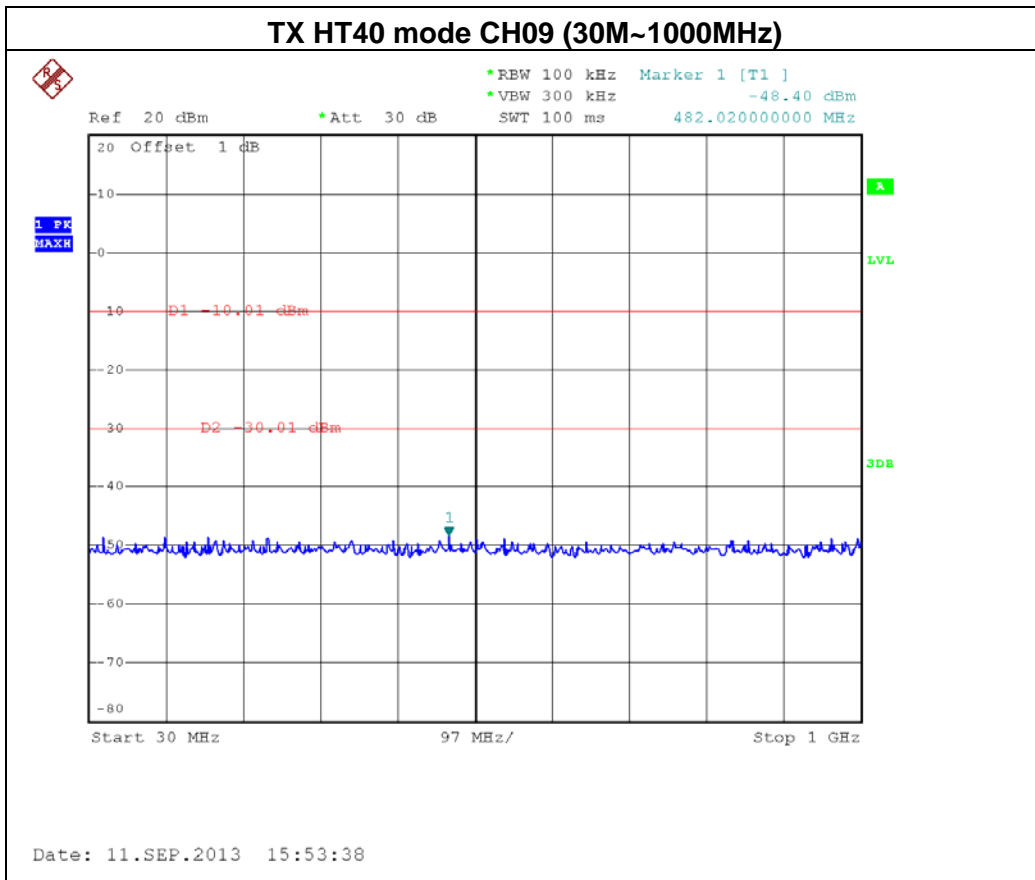



**8. POWER SPECTRAL DENSITY TEST**

**8.1 Applied procedures / limit**

FCC Part15 (15.247) , Subpart C				
Section	Test Item	Limit	Frequency Range (MHz)	Result
15.247(e)	Power Spectral Density	8 dBm (in any 3KHz)	2400-2483.5	PASS

**8.1.1 MEASUREMENT INSTRUMENTS LIST**

Item	Kind of Equipment	Manufacturer	Type No.	Serial No.	Last Calibration	Next Calibration
1	Spectrum Analyzer	R&S	FSP_40	100185	Nov. 17.2012	Nov.16, 2013

Remark: "N/A" denotes no model name, serial no. or calibration specified.  
 All calibration period of equipment list is one year.

**8.1.2 TEST PROCEDURE**

- a. The EUT was directly connected to the spectrum analyzer and antenna output port as show in the block diagram below,
- b. Spectrum Setting: RBW=3KHz, VBW=10 KHz, Sweep time = Auto.

**8.1.3 DEVIATION FROM STANDARD**

No deviation.

**8.1.4 TEST SETUP**

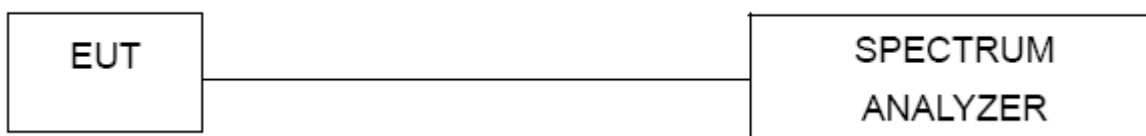

**8.1.5 EUT OPERATION CONDITIONS**

The EUT tested system was configured as the statements of 4.1.6 Unless otherwise a special operating condition is specified in the follows during the testing.





**8.1.6 TEST RESULTS**

EUT :	Wireless N300 Home Router	Model Name :	W303R
Temperature :	24 °C	Relative Humidity :	60 %
Pressure :	1016 hPa	Test Voltage :	AC 120V/60Hz
Test Mode :	TX B MODE /CH01, CH06, CH11		

Test Channel	Frequency (MHz)	Power Density (dBm)	LIMIT (dBm)
CH01	2412	-11.13	8
CH06	2437	-11.35	8
CH11	2462	-11.32	8

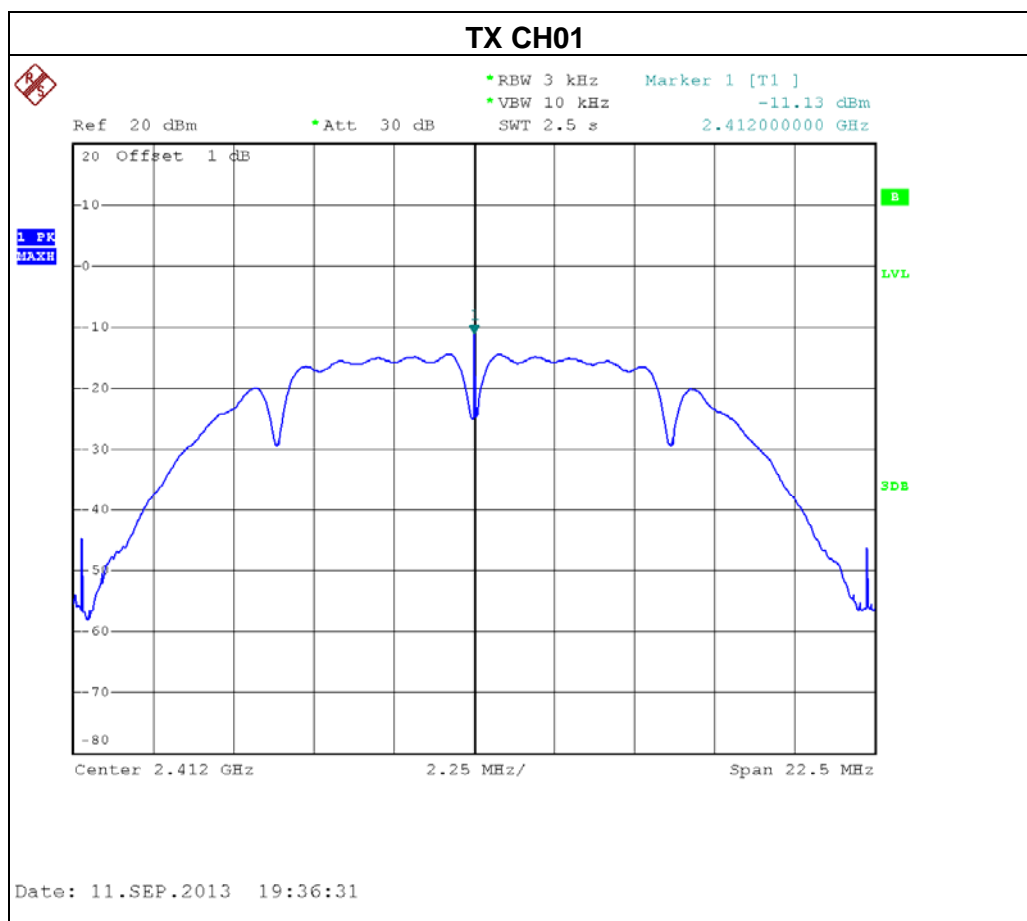

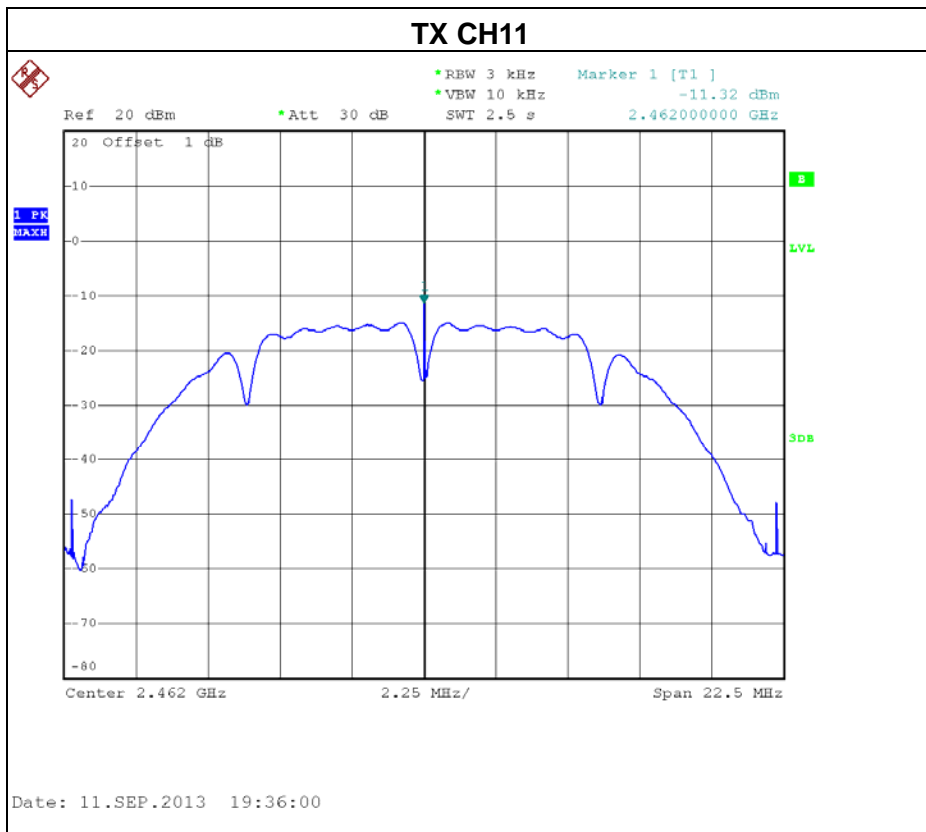
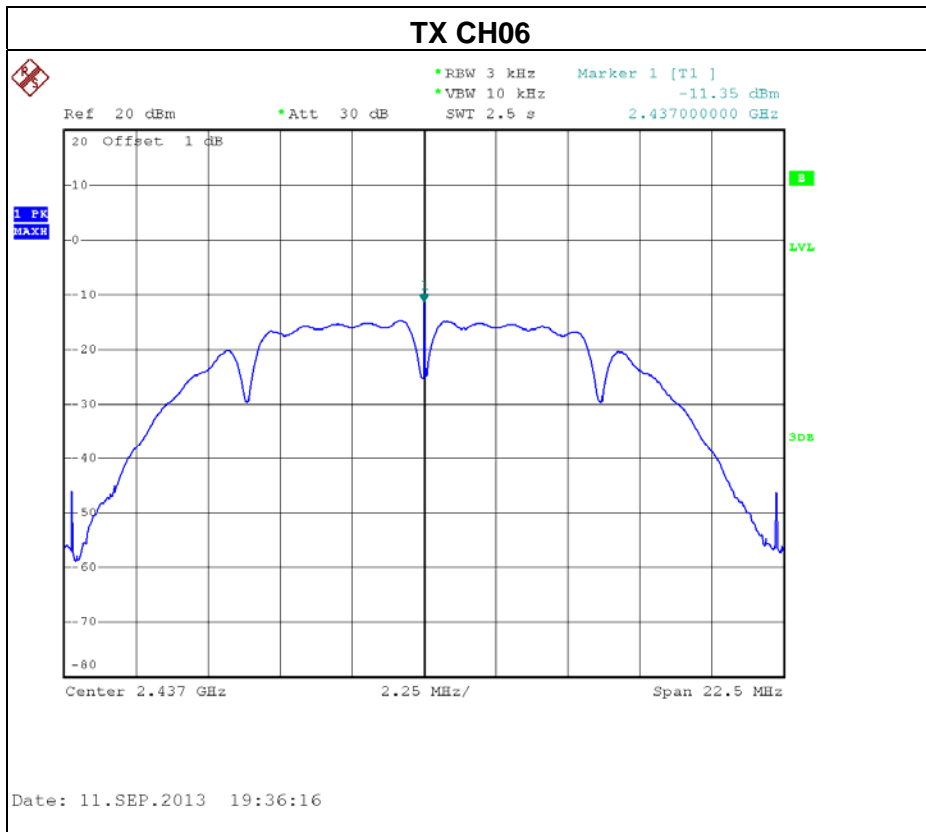



EUT :	Wireless N300 Home Router	Model Name :	W303R
Temperature :	24 °C	Relative Humidity :	60 %
Pressure :	1016 hPa	Test Voltage :	AC 120V/60Hz
Test Mode :	TX G MODE /CH01, CH06, CH11		

Test Channel	Frequency (MHz)	Power Density (dBm)	LIMIT (dBm)
CH01	2412	-11.34	8
CH06	2437	-11.47	8
CH11	2462	-11.55	8

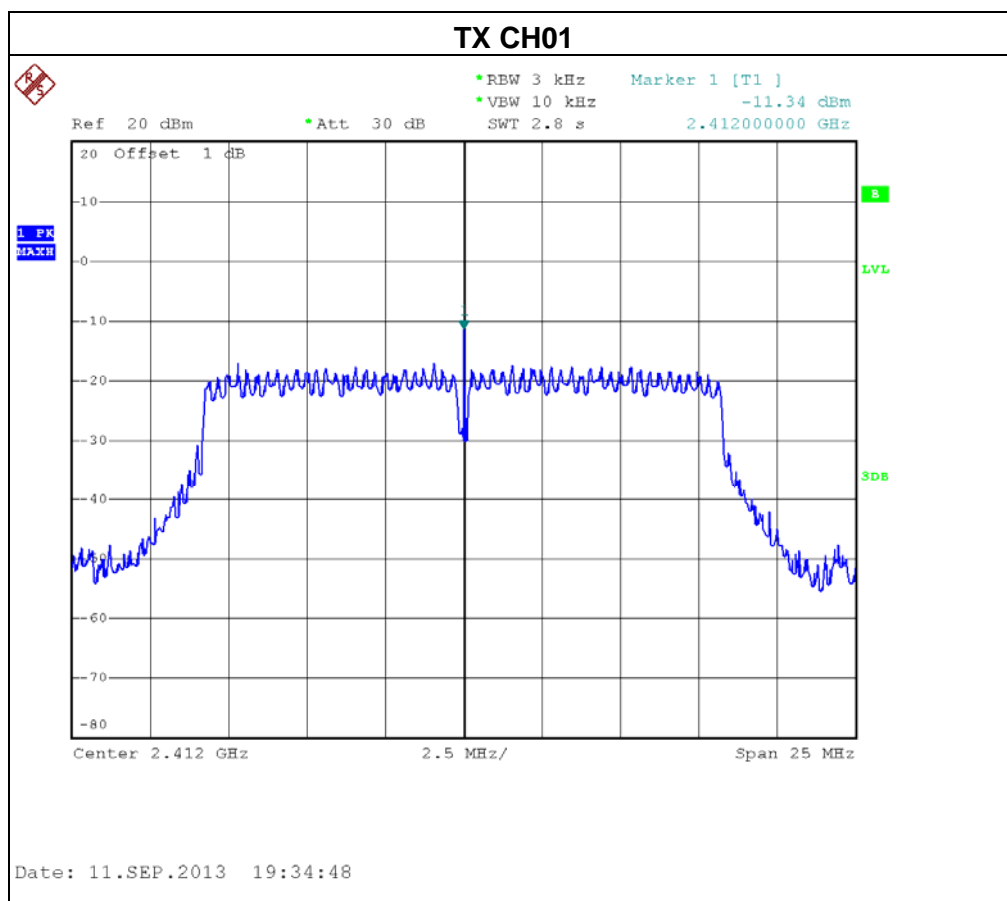

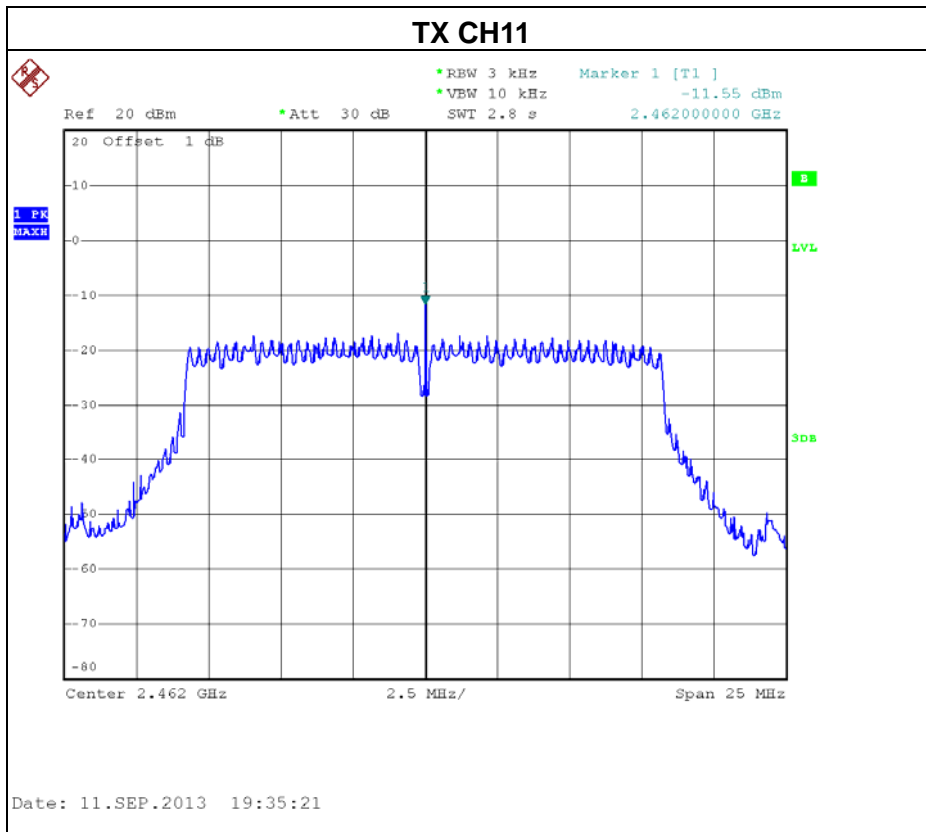
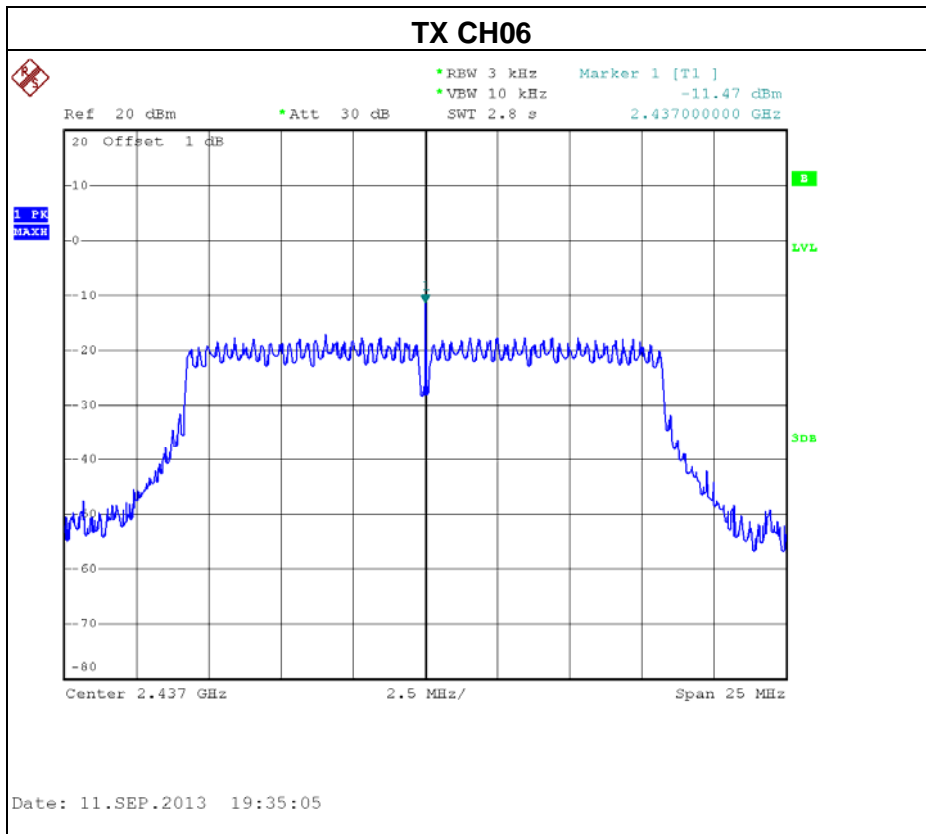



EUT :	Wireless N300 Home Router	Model Name :	W303R
Temperature :	24 °C	Relative Humidity :	60 %
Pressure :	1016 hPa	Test Voltage :	AC 120V/60Hz
Test Mode :	TX N MODE-20MHz /CH01, CH06, CH11-ANT 0		

Test Channel	Frequency (MHz)	Power Density (dBm)	LIMIT (dBm)
CH01	2412	-12.19	8
CH06	2437	-12.90	8
CH11	2462	-12.39	8

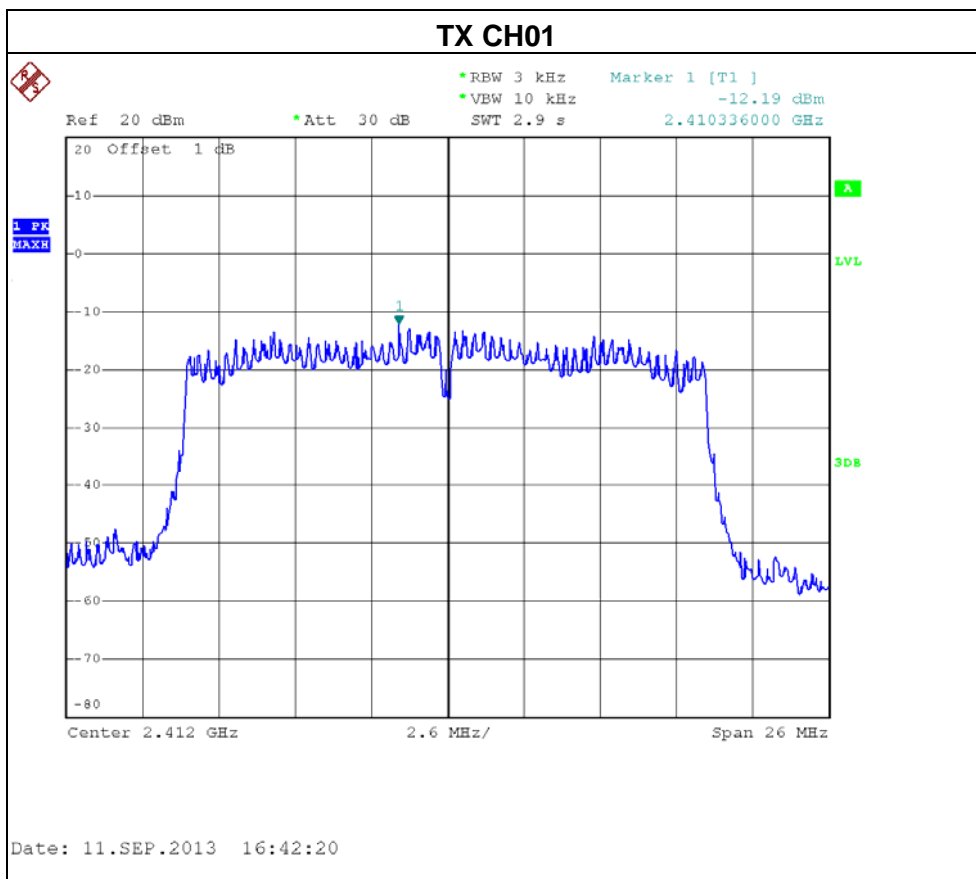

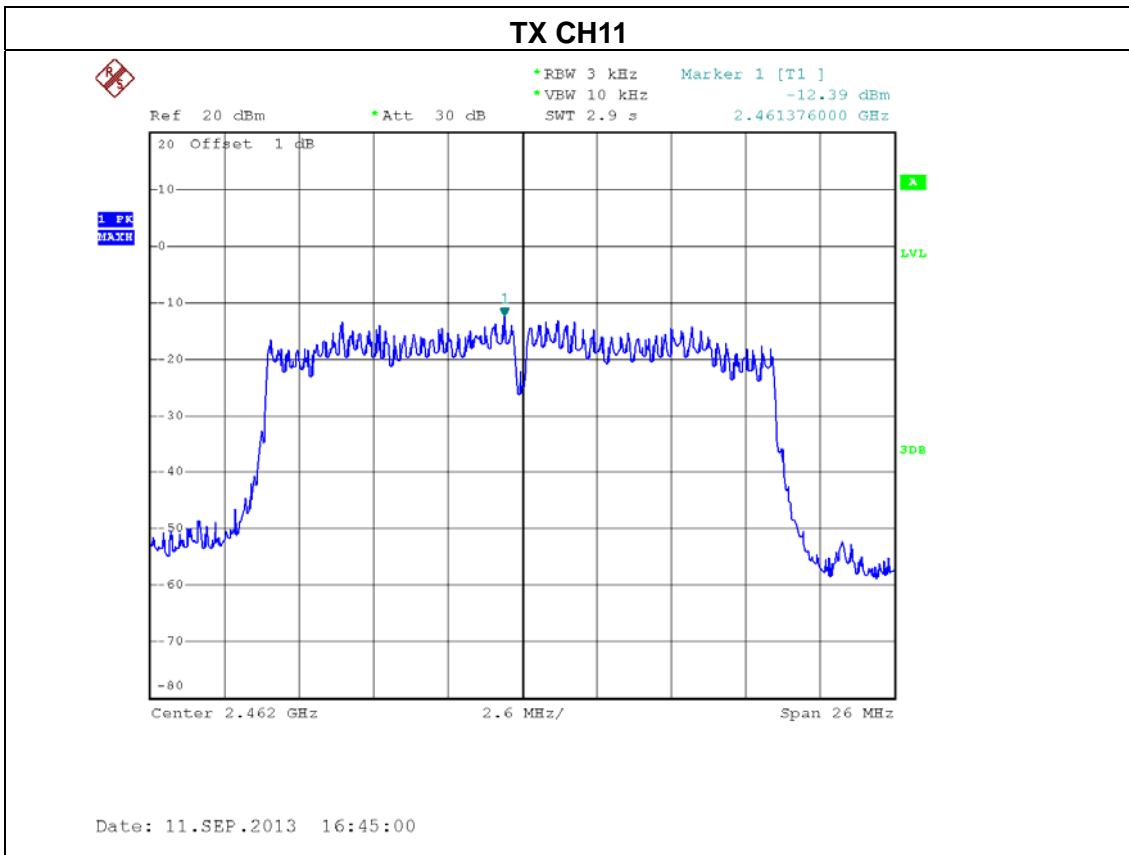
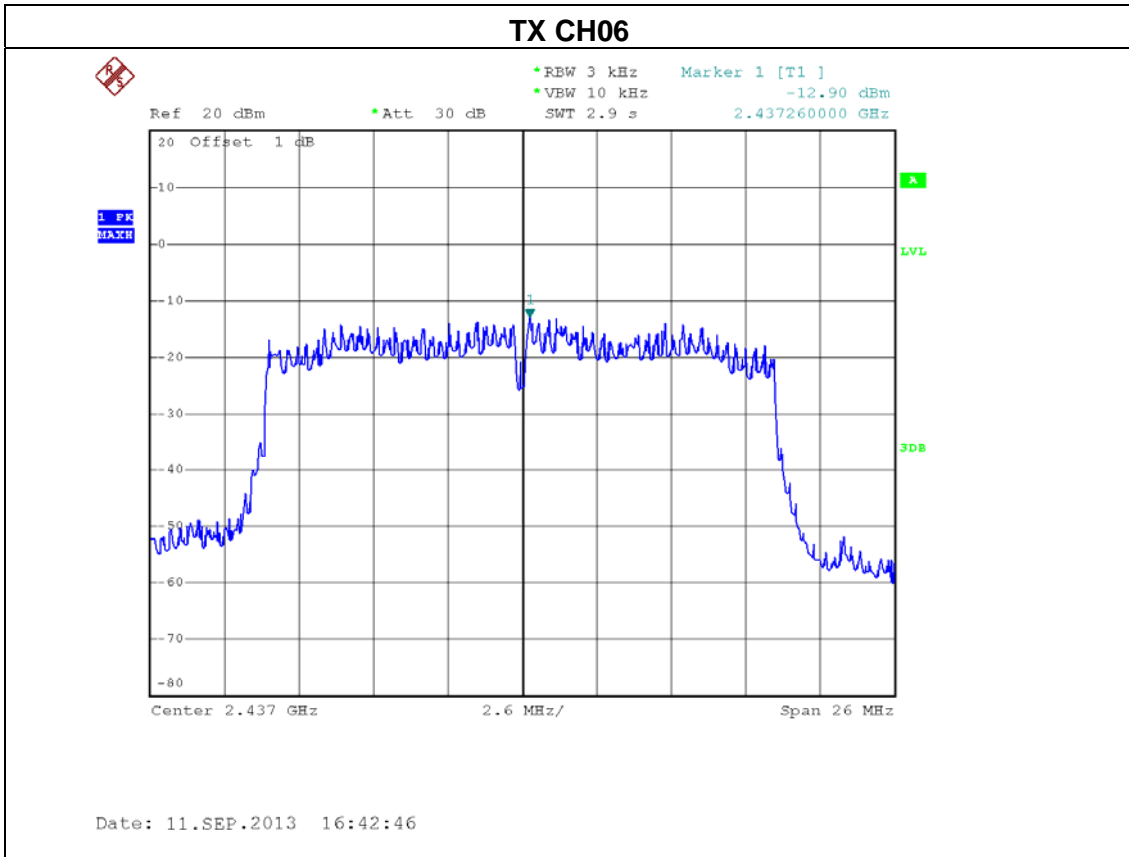



EUT :	Wireless N300 Home Router	Model Name :	W303R
Temperature :	24 °C	Relative Humidity :	60 %
Pressure :	1016 hPa	Test Voltage :	AC 120V/60Hz
Test Mode :	TX N MODE-20MHz /CH01, CH06, CH11-ANT 1		

Test Channel	Frequency (MHz)	Power Density (dBm)	LIMIT (dBm)
CH01	2412	-11.36	8
CH06	2437	-12.89	8
CH11	2462	-12.47	8

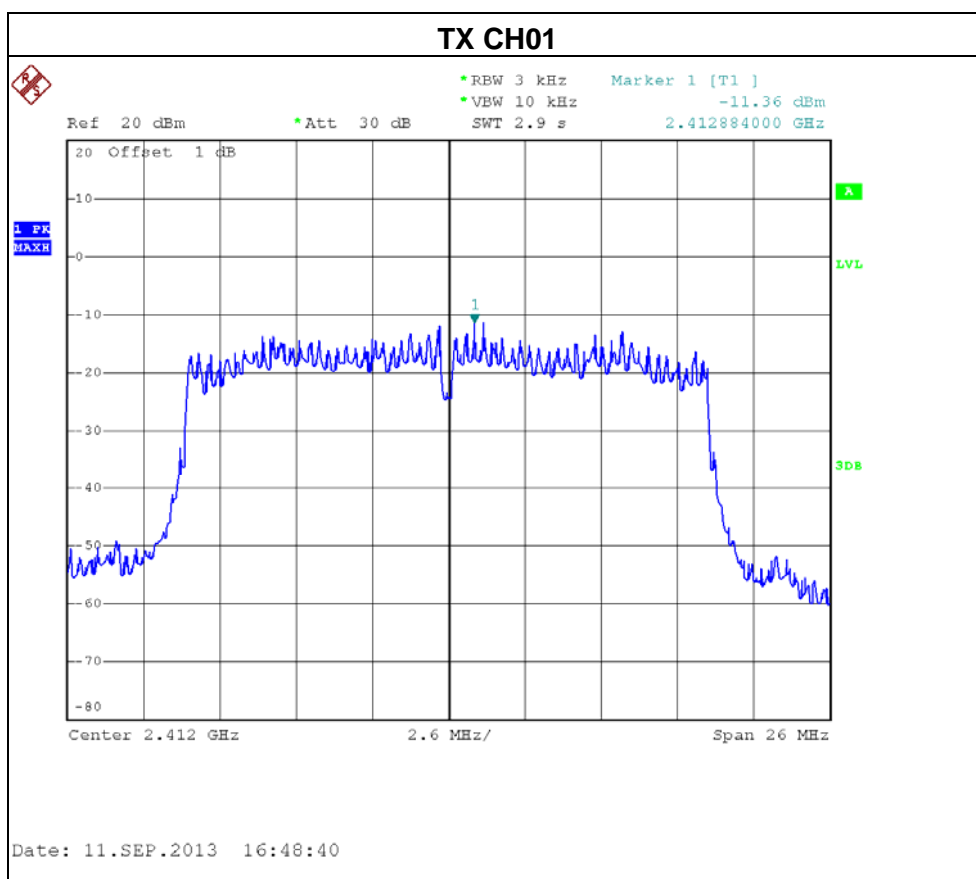

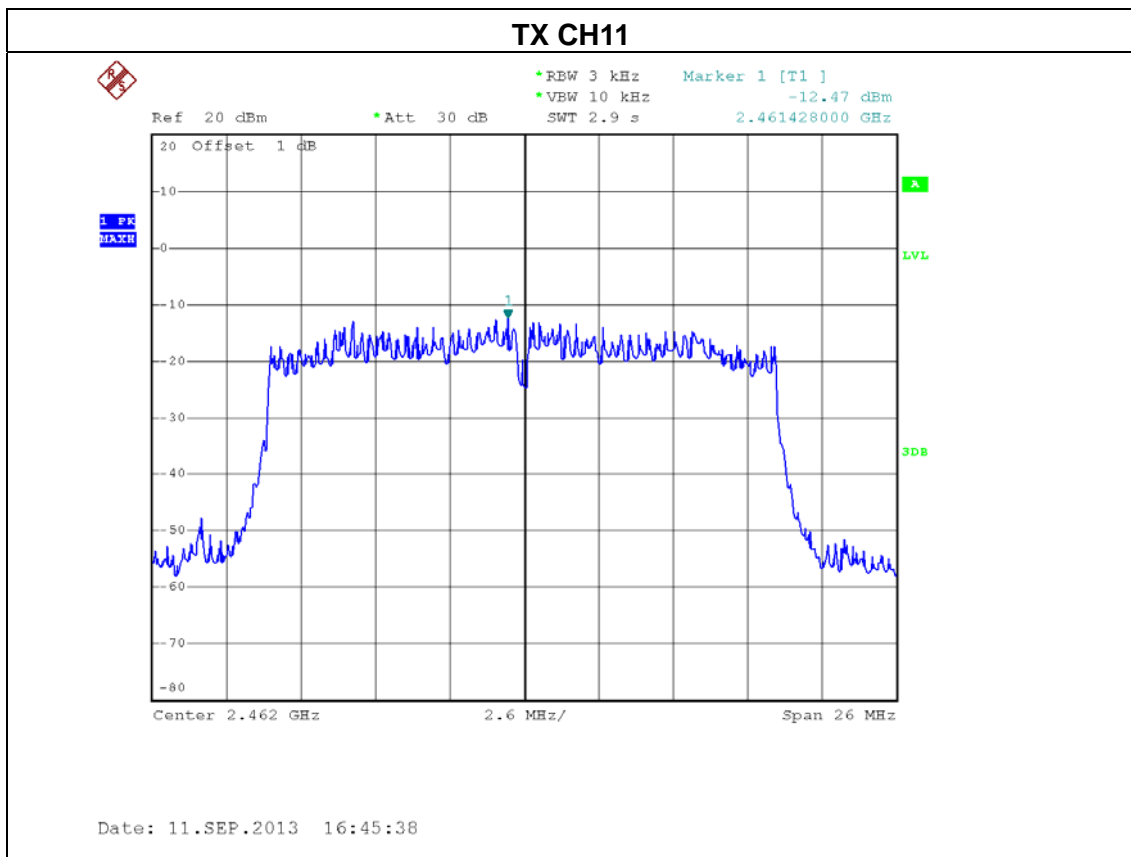
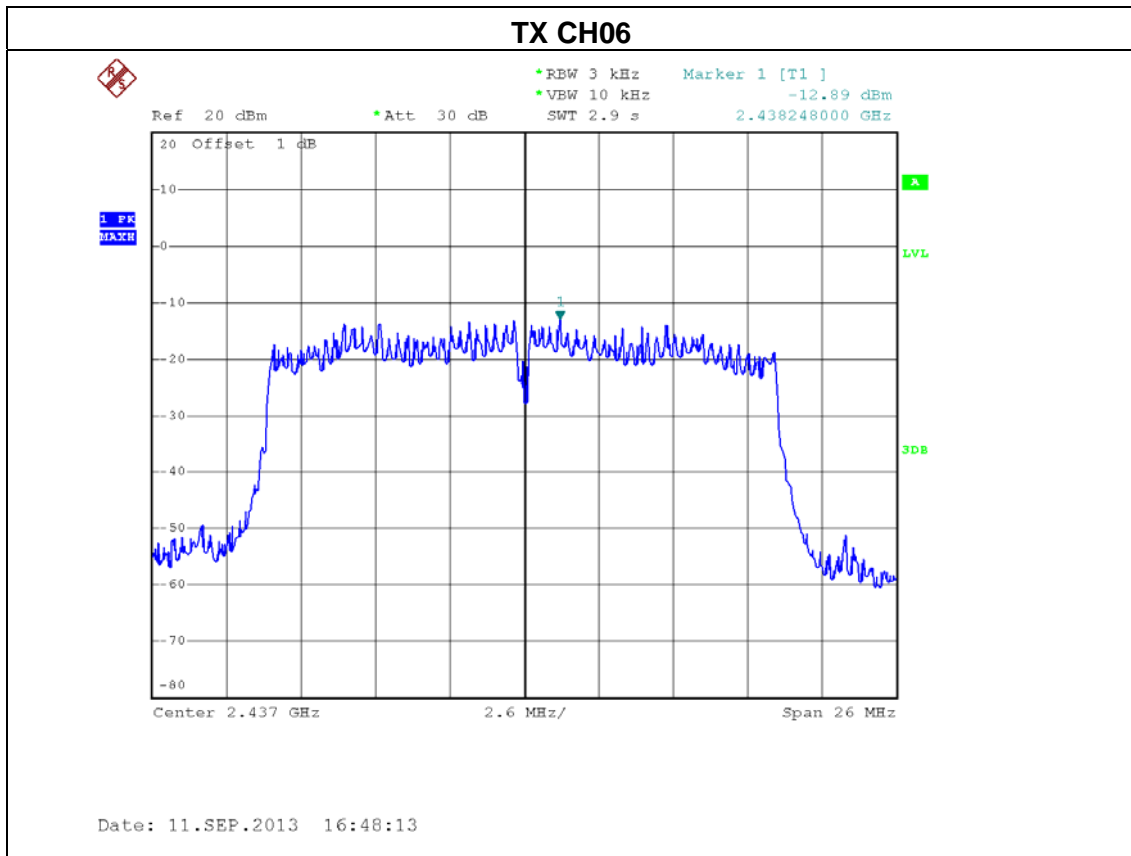





EUT :	Wireless N300 Home Router	Model Name :	W303R
Temperature :	24 °C	Relative Humidity :	60 %
Pressure :	1016 hPa	Test Voltage :	AC 120V/60Hz
Test Mode :	TX N MODE-20MHz /CH01, CH06, CH11-ANT 0+ANT 1+ANT 2		

Test Channel	Frequency (MHz)	Power Density (dBm)	LIMIT (dBm)
CH01	2412	-8.74	8
CH06	2437	-9.88	8
CH11	2462	-9.42	8

Note: The EUT incorporates a MIMO function. Physically, the EUT provides two completed transmitters and three receivers (2T3R).all transmit signals are completely uncorrelated, then, Direction gain =  $G_{ANT}$ , that is Directional gain=5.24.



EUT :	Wireless N300 Home Router	Model Name :	W303R
Temperature :	24 °C	Relative Humidity :	60 %
Pressure :	1016 hPa	Test Voltage :	AC 120V/60Hz
Test Mode :	TX N MODE-40MHz /CH03, CH06, CH09-ANT 0		

Test Channel	Frequency (MHz)	Power Density (dBm)	LIMIT (dBm)
CH03	2422	-15.60	8
CH06	2437	-15.22	8
CH09	2452	-14.66	8

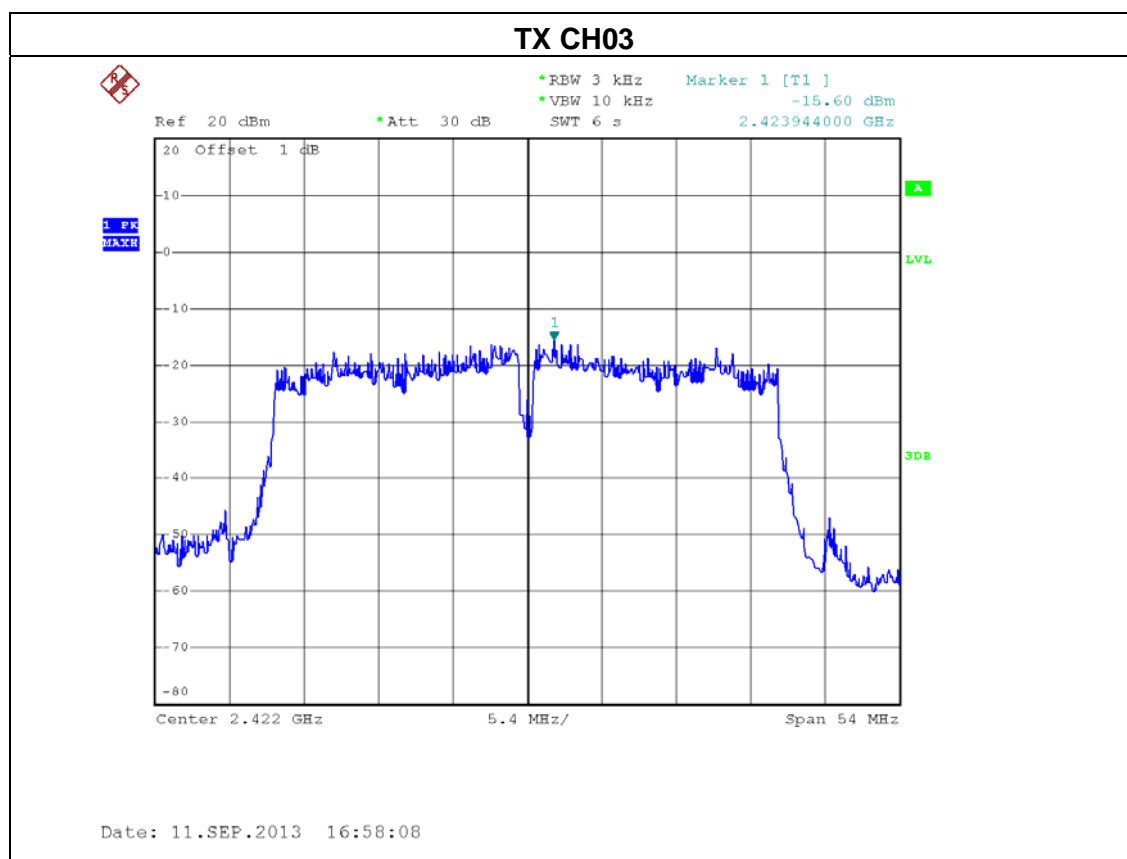

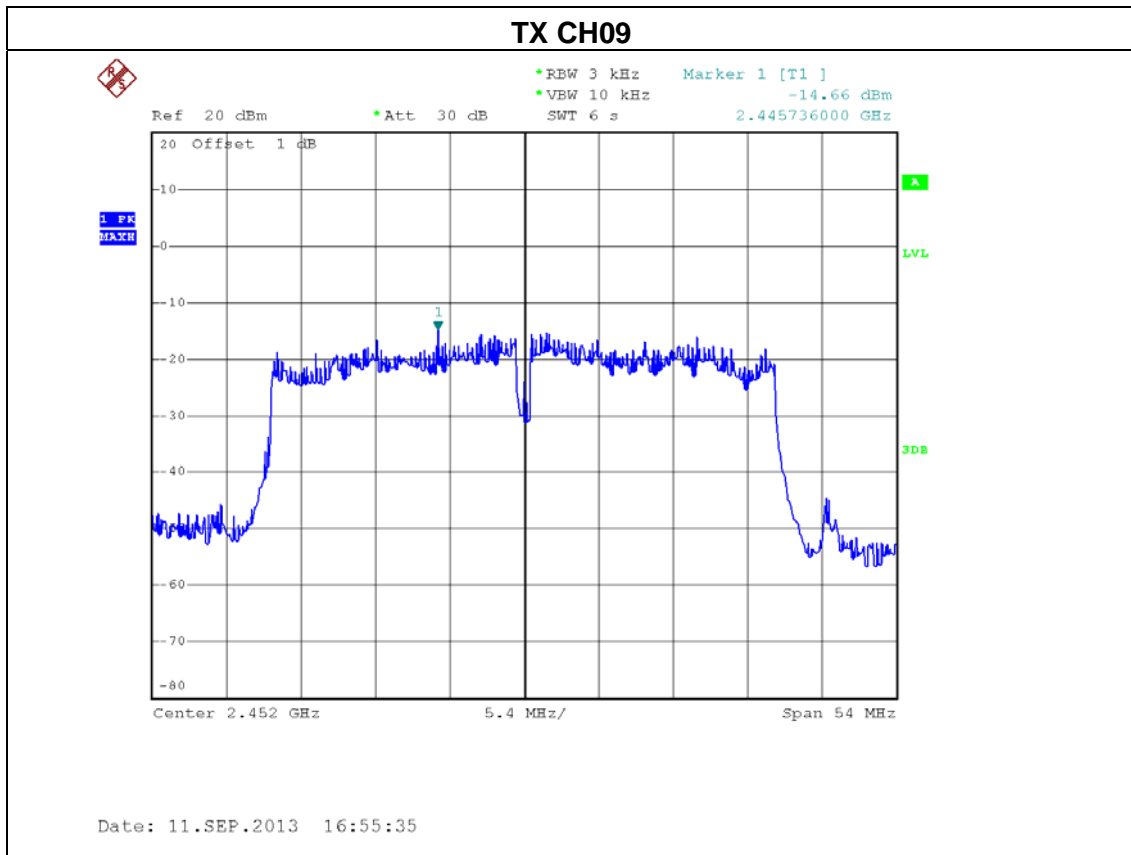
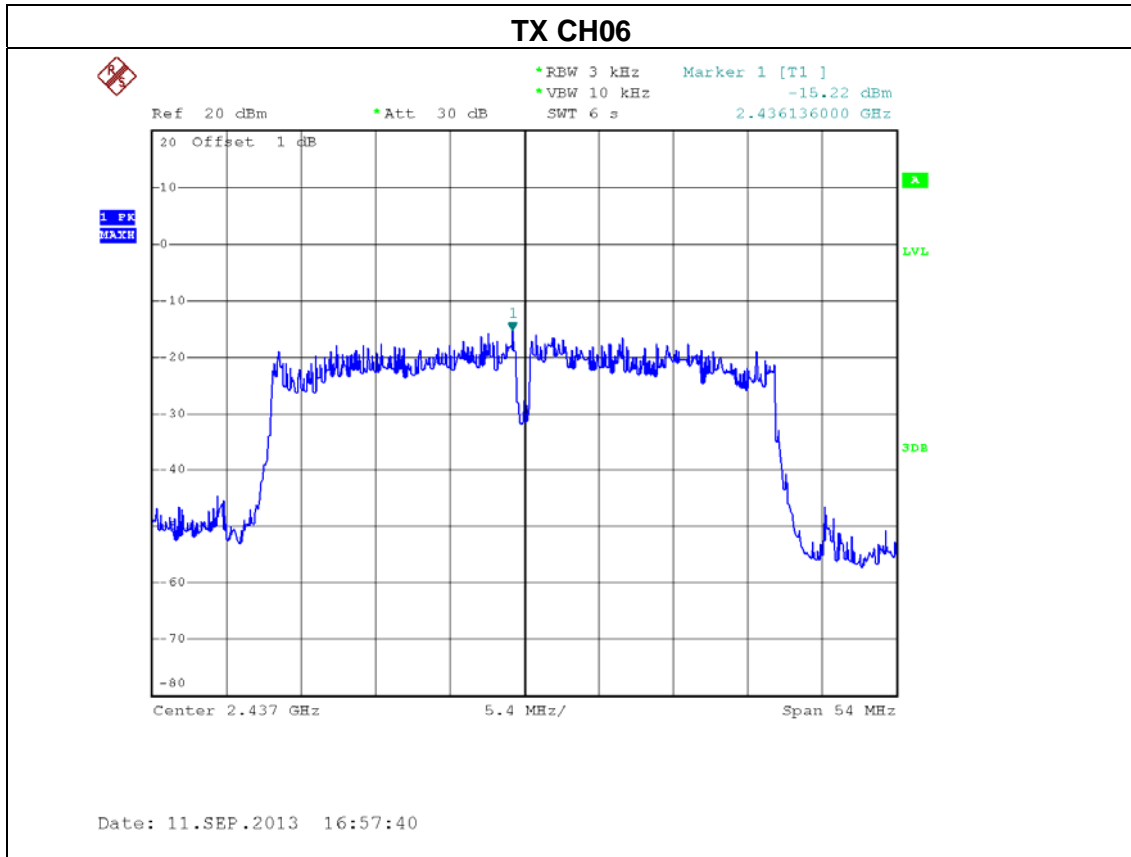



EUT :	Wireless N300 Home Router	Model Name :	W303R
Temperature :	24 °C	Relative Humidity :	60 %
Pressure :	1016 hPa	Test Voltage :	AC 120V/60Hz
Test Mode :	TX N MODE-40MHz /CH03, CH06, CH09-ANT 1		

Test Channel	Frequency (MHz)	Power Density (dBm)	LIMIT (dBm)
CH03	2422	-15.47	8
CH06	2437	-15.85	8
CH09	2452	-15.59	8

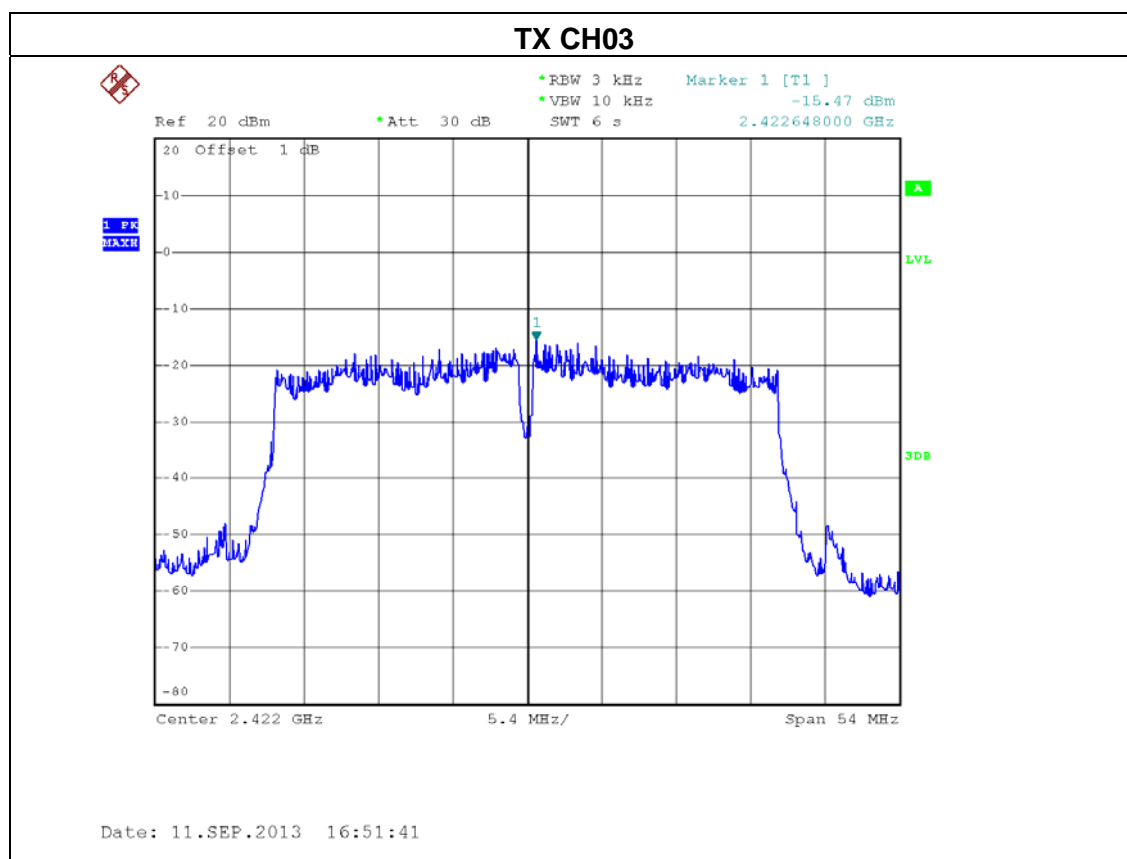

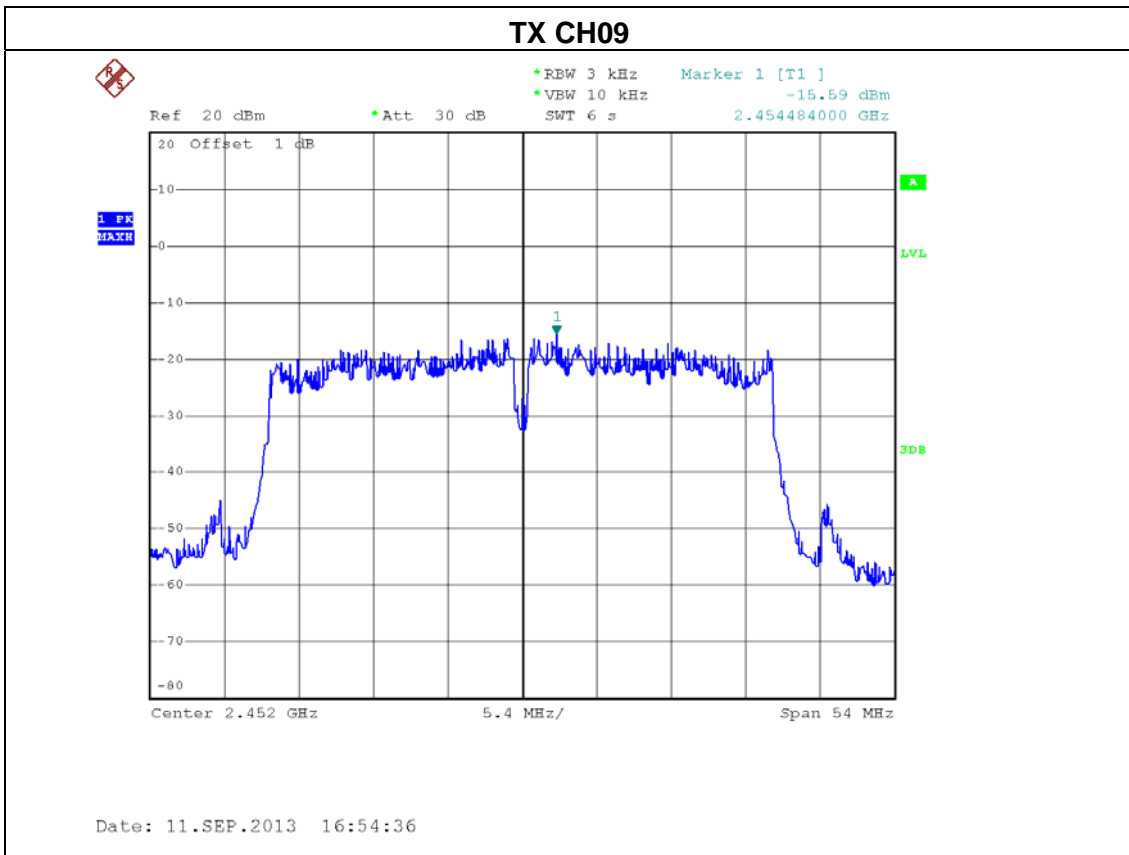
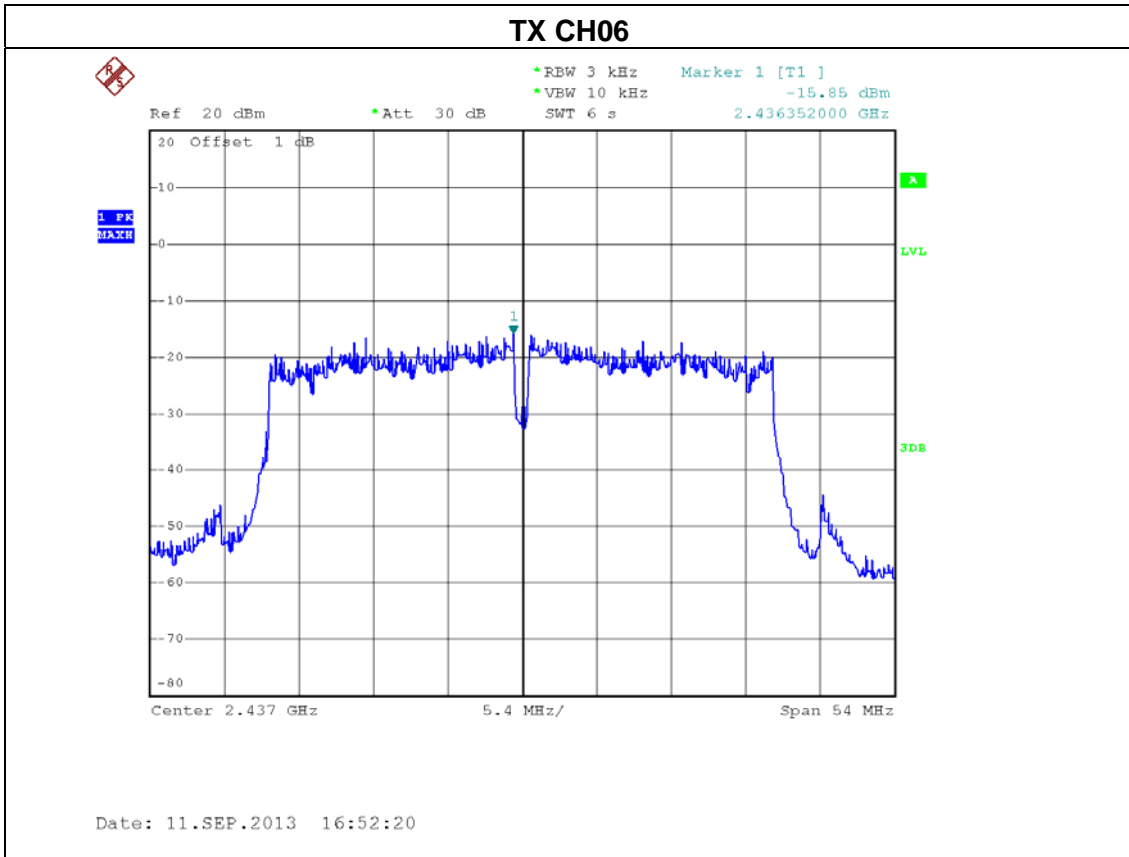



EUT :	Wireless N300 Home Router	Model Name :	W303R
Temperature :	24 °C	Relative Humidity :	60 %
Pressure :	1016 hPa	Test Voltage :	AC 120V/60Hz
Test Mode :	TX N MODE-40MHz /CH03, CH06, CH09-ANT 0+ANT 1+ANT 2		

Test Channel	Frequency (MHz)	Power Density (dBm)	LIMIT (dBm)
CH03	2422	-12.52	8
CH06	2437	-12.51	8
CH09	2452	-12.09	8

Note: The EUT incorporates a MIMO function. Physically, the EUT provides two completed transmitters and three receivers (2T3R).all transmit signals are completely uncorrelated, then, Direction gain =  $G_{ANT}$ , that is Directional gain=5.24.



**9. EUT TEST PHOTO**

**Conducted Measurement Photos**



**Radiated Measurement Photos**

