



FCC PART 15.247

TEST REPORT

For

SHENZHEN TENDA TECHNOLOGY CO.,LTD.

Tenda Industrial Park, No. 34-1, Shilong Rd., Shiyan Town, Bao'an District, Shenzhen, P.R.China

FCC ID: V7TW1800R

Report Type: Original Report	Product Type: Wireless AC1750 Dual-band Gigabit Router
Test Engineer: Leon Chen	<i>leon chen</i>
Report Number: R2DG130130005-00C	
Report Date: 2013-03-13	
Reviewed By: Ivan Cao RF Leader	<i>Ivan Cao</i>
Test Laboratory: Bay Area Compliance Laboratories Corp. (Dongguan) No.69 Pulongcun, Puxinhu Industrial Zone, Tangxia, Dongguan, Guangdong, China Tel: +86-769-86858888 Fax: +86-769-86858891 www.baclcorp.com.cn	

Note: This test report is prepared for the customer shown above and for the device described herein. It may not be duplicated or used in part without prior written consent from Bay Area Compliance Laboratories Corp. (Dongguan).

TABLE OF CONTENTS

GENERAL INFORMATION.....	4
PRODUCT DESCRIPTION FOR EQUIPMENT UNDER TEST (EUT).....	4
OBJECTIVE	4
RELATED SUBMITTAL(S)/GRANT(S).....	4
TEST METHODOLOGY	4
TEST FACILITY	5
SYSTEM TEST CONFIGURATION.....	6
DESCRIPTION OF TEST CONFIGURATION	6
EUT EXERCISE SOFTWARE	6
EQUIPMENT MODIFICATIONS	6
SUPPORT EQUIPMENT LIST AND DETAILS	7
EXTERNAL CABLE.....	7
BLOCK DIAGRAM OF TEST SETUP	7
SUMMARY OF TEST RESULTS	8
FCC §15.247 (i) & §1.1307 (b) (1) & §2.1091- MAXIMUM PERMISSIBLE EXPOSURE (MPE).....	9
APPLICABLE STANDARD	9
FCC §15.203 - ANTENNA REQUIREMENT.....	10
APPLICABLE STANDARD	10
ANTENNA CONNECTOR CONSTRUCTION	10
FCC §15.207 (a) – AC LINE CONDUCTED EMISSIONS	11
APPLICABLE STANDARD	11
MEASUREMENT UNCERTAINTY.....	11
EUT SETUP	12
EMI TEST RECEIVER SETUP.....	12
TEST PROCEDURE	12
CORRECTED AMPLITUDE & MARGIN CALCULATION	13
TEST EQUIPMENT LIST AND DETAILS.....	13
TEST RESULTS SUMMARY	13
TEST DATA	13
FCC §15.209, §15.205 & §15.247(d) - SPURIOUS EMISSIONS.....	16
APPLICABLE STANDARD	16
MEASUREMENT UNCERTAINTY.....	16
EUT SETUP	16
EMI TEST RECEIVER & SPECTRUM ANALYZER SETUP	17
TEST PROCEDURE	17
CORRECTED AMPLITUDE & MARGIN CALCULATION	18
TEST EQUIPMENT LIST AND DETAILS.....	18
TEST RESULTS SUMMARY	18
TEST DATA	18
FCC §15.247(a) (2) – 6 dB EMISSION BANDWIDTH.....	35
APPLICABLE STANDARD	35
TEST PROCEDURE	35
TEST EQUIPMENT LIST AND DETAILS.....	35
TEST DATA	35
FCC §15.247(b) (3) - MAXIMUM PEAK OUTPUT POWER	49

APPLICABLE STANDARD49
TEST PROCEDURE49
TEST EQUIPMENT LIST AND DETAILS.....49
TEST DATA49

FCC §15.247(d) – 100 kHz BANDWIDTH OF FREQUENCY BAND EDGE.....64
APPLICABLE STANDARD64
TEST PROCEDURE64
TEST EQUIPMENT LIST AND DETAILS.....64
TEST DATA64

FCC §15.247(e) - POWER SPECTRAL DENSITY74
APPLICABLE STANDARD74
TEST PROCEDURE74
TEST EQUIPMENT LIST AND DETAILS.....74
TEST DATA74

GENERAL INFORMATION

Product Description for Equipment under Test (EUT)

The *SHENZHEN TENDA TECHNOLOGY CO.,LTD.*'s product, model number: W1800R (*FCC ID: V7T W1800R*) or ("EUT") in this report is a Wireless AC1750 Dual-band Gigabit Router, which was measured approximately: 34.5 cm (L) x22.0 cm (W) x3.5 cm (H), rated input voltage: DC 12V from adapter.

Adapter information: Honor
Model: ADS-40FSG-12 12030 GPCU
Input: AC 100-240V, 50/60Hz, Max.1.0A
Output: DC 12V, 2.5A

** All measurement and test data in this report was gathered from production sample serial number: 130130005 (Assigned by BAACL, Dongguan). The EUT was received on 2013-01-30.*

Objective

This report is prepared on behalf of *SHENZHEN TENDA TECHNOLOGY CO.,LTD.* accordance with Part 2-Subpart J, Part 15-Subparts A, B and C of the Federal Communication Commissions rules.

The tests were performed in order to determine the compliance of the EUT with FCC Part 15-Subpart C, section 15.203, 15.205, 15.207, 15.209 and 15.247 rules.

Related Submittal(s)/Grant(s)

FCC Part 15C DTS submissions with FCC ID: *V7TW1800R* for 5745-5825MHz band.
FCC Part 15E NII submissions with FCC ID: *V7TW1800R* for 5180-5240MHz band.
FCC Part 15B JBP submissions with FCC ID: *V7TW1800R*.

Test Methodology

All measurements contained in this report were conducted with ANSI C63.4-2003, American National Standard for Methods of Measurement of Radio-Noise Emissions from Low-Voltage Electrical and Electronic Equipment in the range of 9 kHz to 40 GHz.

All emissions measurement was performed and Bay Area Compliance Laboratories Corp. (Dongguan). The radiated testing was performed at an antenna-to-EUT distance of 3 meters.

The uncertainty of any RF tests which use conducted method measurement is ± 3.46 dB, the uncertainty of any radiation on emissions measurement is:

30M~200MHz: 5.0 dB

200M~1GHz: 6.2 dB

1G~6GHz: 4.45 dB

6G~18GHz: 5.23 dB

And the uncertainty will not be taken into consideration for all test data recorded in the report.

Test Facility

The Test site used by Bay Area Compliance Laboratories Corp. (Dongguan) to collect test data is located on the No.69 Pulongcun, Puxinhu Industrial Zone, Tangxia, Dongguan, Guangdong, China

Test site at Bay Area Compliance Laboratories Corp. (Dongguan) has been fully described in reports submitted to the Federal Communication Commission (FCC). The details of these reports have been found to be in compliance with the requirements of Section 2.948 of the FCC Rules on February 02, 2012. The facility also complies with the radiated and AC line conducted test site criteria set forth in ANSI C63.4-2003.

The Federal Communications Commission has the reports on file and is listed under FCC Registration No.: 273710. The test site has been approved by the FCC for public use and is listed in the FCC Public Access Link (PAL) database.

SYSTEM TEST CONFIGURATION

Description of Test Configuration

The system was configured for testing in testing mode, which was provided by manufacturer. For 2.4G band, 11 channels are provided to testing:

Channel	Frequency (MHz)	Channel	Frequency (MHz)
1	2412	7	2442
2	2417	8	2447
3	2422	9	2452
4	2427	10	2457
5	2432	11	2462
6	2437	/	/

For 802.11b, 802.11g, and 802.11n20 modes were tested with Channel 1, 6 and 11. For 802.11n40 mode were tested with Channel 3, 6 and 9.

The worst-case data rates are determined to be as follows for each mode based upon investigations by measuring the average power and PSD across all data rates bandwidths, and modulations.

EUT Exercise Software

The software 'Broadcom MTool 2.0.0.3' was used for testing, which was provided by manufacturer.

Equipment Modifications

No modification was made to the EUT tested.

Support Equipment List and Details

Manufacturer	Description	Model	Serial Number
HP	Printer	C3941A	JPTVOB2337
SAST	Modem	AEM-2100	0293
DELL	Keyboard	L100	CNORH656658907BL05DC
DELL	Laptop	PP11L	N/A
Kinston	Flash Disk	4G	/
DELL	PC	GX620	/

External Cable

Cable Description	Length (m)	From Port	To
Shielded Detachable Printer Cable	1.2	Parallel Port of Laptop	Printer
Shielded Detachable Serial Cable	1.2	Serial Port of Laptop	Modem
Shielded Detachable Keyboard Cable	1.5	Keyboard Port of Laptop	Keyboard
RJ 45 Cable	1.0	Laptop	EUT
RJ45 Cable*4	10	EUT	PC

Block Diagram of Test Setup

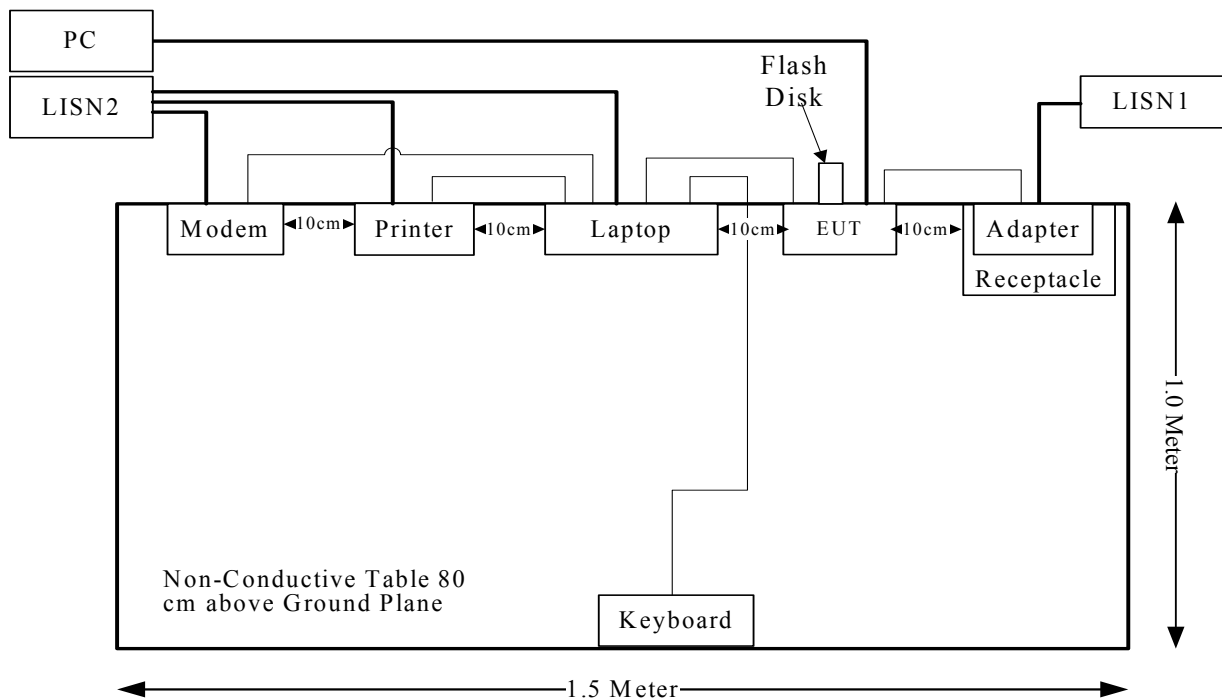

SUMMARY OF TEST RESULTS

FCC Rules	Description of Test	Result
FCC §15.247 (i) & §1.1307 (b) (1) & §2.1091	Maximum Permissible Exposure	Compliance
§15.203	Antenna Requirement	Compliance
§15.207 (a)	AC Line Conducted Emissions	Compliance
§15.247(d)	Spurious Emissions at Antenna Port	Compliance
§15.205, §15.209, §15.247(d)	Spurious Emissions	Compliance
§15.247 (a)(2)	6 dB Emission Bandwidth	Compliance
§15.247(b)(3)	Maximum Peak Output Power	Compliance
§15.247(d)	100 kHz Bandwidth of Frequency Band Edge	Compliance
§15.247(e)	Power Spectral Density	Compliance

FCC §15.247 (i) & §1.1307 (b) (1) & §2.1091- MAXIMUM PERMISSIBLE EXPOSURE (MPE)

Applicable Standard

According to subpart 15.247(i) and subpart §1.1307(b)(1), systems operating under the provisions of this section shall be operated in a manner that ensures that the public is not exposed to radio frequency energy level in excess of the Commission’s guidelines.

Limits for Maximum Permissible Exposure (MPE) (§1.1310, §2.1091)

(B) Limits for General Population/Uncontrolled Exposure				
Frequency Range (MHz)	Electric Field Strength (V/m)	Magnetic Field Strength (A/m)	Power Density (mW/cm ²)	Averaging Time (minutes)
0.3–1.34	614	1.63	*(100)	30
1.34–30	824/f	2.19/f	*(180/f ²)	30
30–300	27.5	0.073	0.2	30
300–1500	/	/	f/1500	30
1500–100,000	/	/	1.0	30

f = frequency in MHz; * = Plane-wave equivalent power density;

According to §1.1310 and §2.1091 RF exposure is calculated.

Calculated Formulary:

Predication of MPE limit at a given distance

$S = PG/4\pi R^2$ = power density (in appropriate units, e.g. mW/cm²);

P = power input to the antenna (in appropriate units, e.g., mW);

G = power gain of the antenna in the direction of interest relative to an isotropic radiator, the power gain factor, is normally numeric gain;

R = distance to the center of radiation of the antenna (appropriate units, e.g., cm);

Calculated Data:

Mode	Frequency (MHz)	Antenna Gain		Conducted Power		Evaluation Distance (cm)	Power Density (mW/cm ²)	MPE Limit (mW/cm ²)
		(dBi)	(numeric)	(dBm)	(mW)			
802.11b	2462	5	3.16	21.84	152.76	20.00	0.09615	1.0
802.11g	2412	5	3.16	17.53	56.62	20.00	0.03564	1.0
802.11n ht20	2462	5	3.16	17.07	50.93	20.00	0.03206	1.0
802.11n ht40	2462	5	3.16	17.30	53.70	20.00	0.03380	1.0

Result: The device meet FCC MPE at 20 cm distance

FCC §15.203 - ANTENNA REQUIREMENT

Applicable Standard

According to § 15.203, an intentional radiator shall be designed to ensure that no antenna other than that furnished by the responsible party shall be used with the device. The use of a permanently attached antenna or of an antenna that uses a unique coupling to the intentional radiator shall be considered sufficient to comply with the provisions of this section. The manufacturer may design the unit so that a broken antenna can be replaced by the user, but the user of a standard antenna jack or electrical connector is prohibited. The structure and application of the EUT were analyzed to determine compliance with section §15.203 of the rules. §15.203 state that the subject device must meet the following criteria:

- a. Antenna must be permanently attached to the unit.
- b. Antenna must use a unique type of connector to attach to the EUT.

Unit must be professionally installed, and installer shall be responsible for verifying that the correct antenna is employed with the unit.

Antenna Connector Construction

The EUT has 3 dipole antennas, which were using unique type of connector to attach to the EUT, and the maximum gain is 5.0dBi, please refer to the internal photos.

Result: Compliance.

FCC §15.207 (a) – AC LINE CONDUCTED EMISSIONS

Applicable Standard

FCC§15.207

Measurement Uncertainty

Compliance or non-compliance with a disturbance limit shall be determined in the following manner:

If U_{lab} is less than or equal to U_{cispr} of Table 1, then:

- compliance is deemed to occur if no measured disturbance level exceeds the disturbance limit;
- non-compliance is deemed to occur if any measured disturbance level exceeds the disturbance limit.

If U_{lab} is greater than U_{cispr} of Table 1, then:

- compliance is deemed to occur if no measured disturbance level, increased by $(U_{lab} - U_{cispr})$, exceeds the disturbance limit;
- non-compliance is deemed to occur if any measured disturbance level, increased by $(U_{lab} - U_{cispr})$, exceeds the disturbance limit.

Based on CISPR 16-4-2-2011, measurement uncertainty of conducted disturbance at mains port using AMN at Bay Area Compliance Laboratories Corp. (Dongguan) is 3.46 dB (150 kHz to 30 MHz).

Table 1 – Values of U_{cispr}

Measurement	U_{cispr}
Conducted disturbance at mains port using AMN (150 kHz to 30 MHz)	3.4 dB

EUT Setup

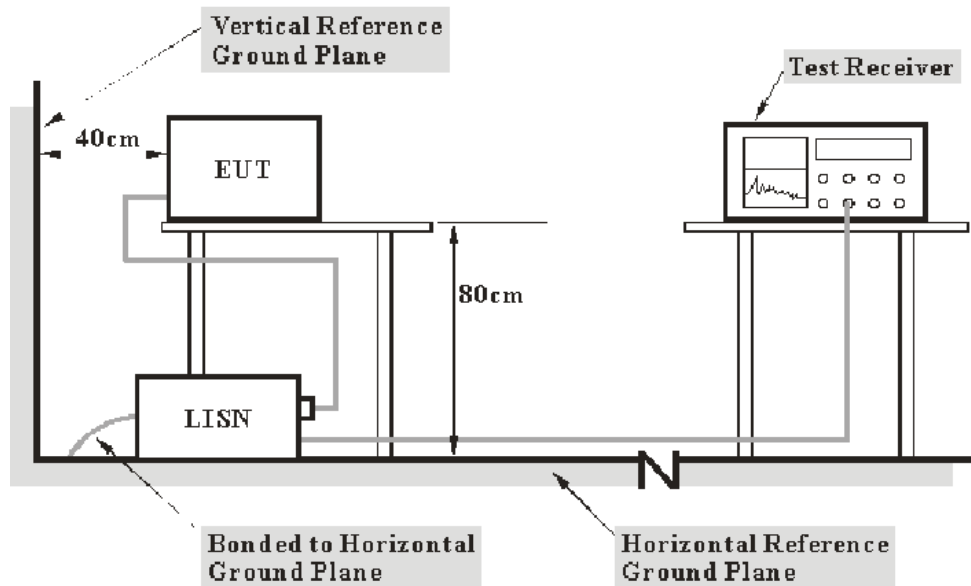

- Note:**
1. Support units were connected to second LISN.
 2. Both of LISNs (AMN) 80 cm from EUT and at the least 80 cm from other units and other metal planes support units.

The setup of EUT is according with per ANSI C63.4-2003 measurement procedure. The specification used was with the FCC Part 15.207 limits.

The spacing between the peripherals was 10 cm.

The adapter was connected to a 120 VAC/60 Hz power source

EMI Test Receiver Setup

The EMI test receiver was set to investigate the spectrum from 150 kHz to 30 MHz.

During the conducted emission test, the EMI test receiver was set with the following configurations:

<u>Frequency Range</u>	<u>IF B/W</u>
150 kHz – 30 MHz	9 kHz

Test Procedure

During the conducted emission test, the adapter was connected to the outlet of the first LISN and the other support equipments were connected to the outlet of the second LISN.

Maximizing procedure was performed on the six (6) highest emissions of the EUT.

All data was recorded in the Quasi-peak and average detection mode.

Corrected Amplitude & Margin Calculation

The basic equation is as follows:

$$V_C = V_R + A_C + VDF$$

$$C_f = A_C + VDF$$

Herein,

V_C (cord. Reading): corrected voltage amplitude

V_R : reading voltage amplitude

A_C : attenuation caused by cable loss

VDF: voltage division factor of AMN

C_f : Correction Factor

The “**Margin**” column of the following data tables indicates the degree of compliance within the applicable limit. For example, a margin of 7dB means the emission is 7dB below the maximum limit. The equation for margin calculation is as follows:

$$\text{Margin} = \text{Limit} - \text{Corrected Amplitude}$$

Test Equipment List and Details

Manufacturer	Description	Model	Serial Number	Calibration Date	Calibration Due Date
R&S	EMI Test Receiver	ESCS 30	830245/006	2012-11-29	2013-11-28
R&S	LISN1	ESH3-Z5	843331/015	2012-09-17	2013-09-16
R&S	LISN2	ESH3-Z5	100113	2012-11-29	2013-11-28
BACL	Test Software	BACL-EMC	V1.0-2010	N/A	N/A

Test Results Summary

According to the recorded data in following table, the EUT complied with the FCC Part 15.207, with the worst margin reading of:

16.03 dB at 0.270 MHz in the Neutral conducted mode

Test Data

Environmental Conditions

Temperature:	24 ° C
Relative Humidity:	62 %
ATM Pressure:	101.3kPa

The testing was performed by Leon Chen on 2013-02-04.

Test Mode: Transmitting

120 V, 60 Hz, Line:

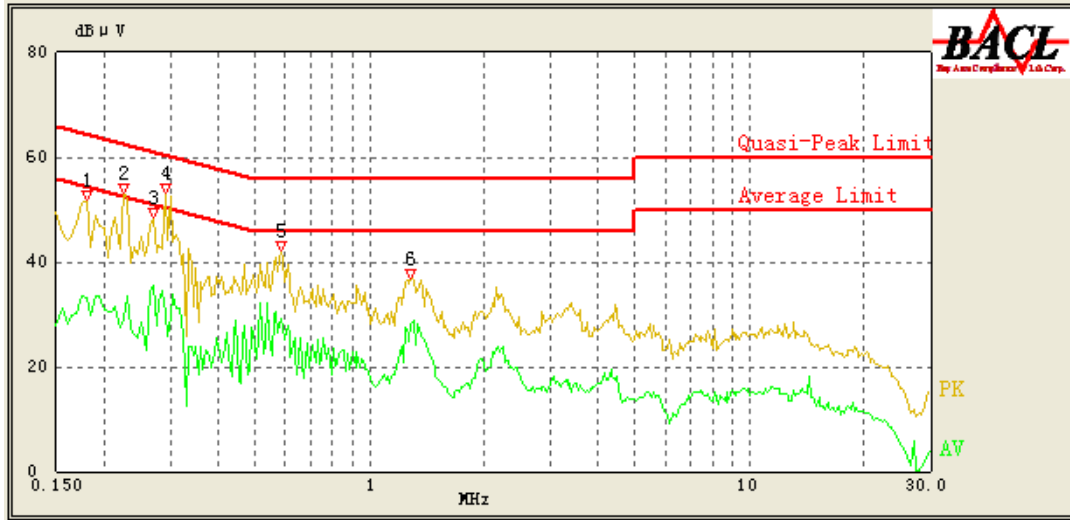

Frequency (MHz)	Cord. Reading (dBμV)	Correction Factor (dB)	Limit (dBμV)	Margin (dB)	Detector (PK/AV/QP)
0.180	42.97	1.01	65.14	22.17	QP
0.180	33.04	1.01	55.14	22.10	AV
0.225	41.90	0.93	63.86	21.96	QP
0.225	29.12	0.93	53.86	24.74	AV
0.270	45.04	0.86	62.57	17.53	QP
0.270	35.66	0.86	52.57	16.91	AV
0.290	41.00	0.83	62.00	21.00	QP
0.290	30.48	0.83	52.00	21.52	AV
0.585	35.52	0.49	56.00	20.48	QP
0.585	29.01	0.49	46.00	16.99	AV
1.285	32.97	0.33	56.00	23.03	QP
1.285	28.12	0.33	46.00	17.88	AV

120 V, 60 Hz, Neutral:



Frequency (MHz)	Cord. Reading (dBµV)	Correction Factor (dB)	Limit (dBµV)	Margin (dB)	Detector (PK/AV/QP)
0.195	47.23	1.61	64.71	17.48	QP
0.195	35.55	1.61	54.71	19.16	AV
0.210	44.96	1.53	64.29	19.33	QP
0.210	34.09	1.53	54.29	20.20	AV
0.270	44.97	1.22	62.57	17.60	QP
0.270	36.54	1.22	52.57	16.03	AV
0.305	41.57	1.06	61.57	20.00	QP
0.305	32.38	1.06	51.57	19.19	AV
0.565	36.47	0.51	56.00	19.53	QP
0.565	31.30	0.51	46.00	14.70	AV
1.310	33.71	0.24	56.00	22.29	QP
1.310	28.31	0.24	46.00	17.69	AV

FCC §15.209, §15.205 & §15.247(d) - SPURIOUS EMISSIONS

Applicable Standard

FCC §15.247 (d); §15.209; §15.205;

Measurement Uncertainty

Compliance or non-compliance with a disturbance limit shall be determined in the following manner:

If U_{lab} is less than or equal to U_{cispr} of Table 2, then:

- compliance is deemed to occur if no measured disturbance level exceeds the disturbance limit;
- non-compliance is deemed to occur if any measured disturbance level exceeds the disturbance limit.

If U_{lab} is greater than U_{cispr} of Table 2, then:

- compliance is deemed to occur if no measured disturbance level, increased by $(U_{lab} - U_{cispr})$, exceeds the disturbance limit;
- non-compliance is deemed to occur if any measured disturbance level, increased by $(U_{lab} - U_{cispr})$, exceeds the disturbance limit.

Based on CISPR 16-4-2-2011, measurement uncertainty of radiated emission at a distance of 3m at Bay Area Compliance Laboratories Corp. (Dongguan) is:

- 30M~200MHz: 5.0 dB
- 200M~1GHz: 6.2 dB
- 1G~6GHz: 4.45 dB
- 6G~18GHz: 5.23 dB

Table 2 – Values of U_{cispr}

Measurement	U_{cispr}
Radiated disturbance (electric field strength at an OATS or in a SAC) (30 MHz to 1000 MHz)	6.3 dB
Radiated disturbance (electric field strength in a FAR) (1 GHz to 6 GHz)	5.2 dB
Radiated disturbance (electric field strength in a FAR) (6 GHz to 18 GHz)	5.5 dB

EUT Setup

Below 1GHz:

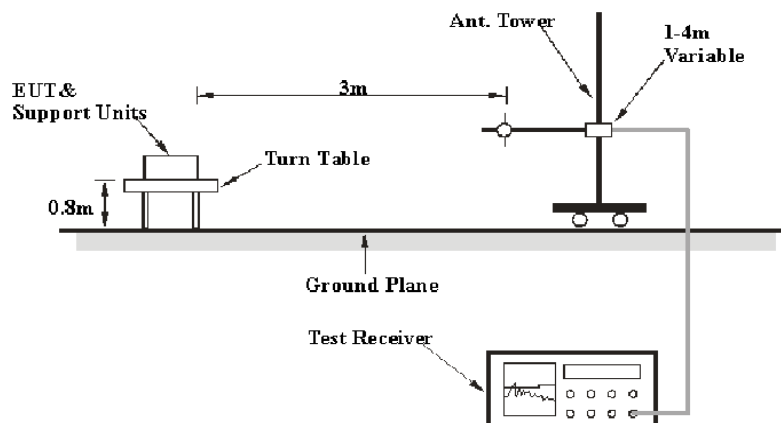

Above 1GHz:

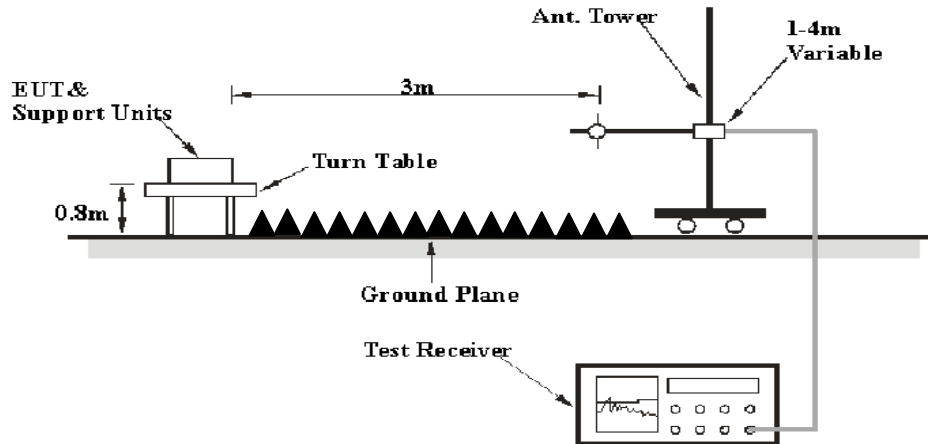

The radiated emission tests were performed in the 3 meters chamber test site, using the setup accordance with the ANSI C63.4-2003. The specification used was the FCC 15.209, and FCC 15.247 limits.

The external I/O cables were draped along the test table and formed a bundle 30 to 40 cm long in the middle.

The spacing between the peripherals was 10 cm.

The adapter was connected to a 120 VAC/60 Hz power source

EMI Test Receiver & Spectrum Analyzer Setup

The system was investigated from 30 MHz to 25 GHz.

During the radiated emission test, the EMI test receiver & Spectrum Analyzer Setup were set with the following configurations:

<i>Frequency Range</i>	<i>RBW</i>	<i>Video B/W</i>	<i>Detector</i>
30 MHz – 1000 MHz	120 kHz	300 kHz	QP
1000 MHz – 25 GHz	1 MHz	3 MHz	PK
1000 MHz – 25 GHz	1 MHz	10 Hz	Ave.

Test Procedure

During the radiated emission test, the adapter was connected to the first AC floor outlet and the other support equipments were connected to the second AC floor outlet.

Maximizing procedure was performed on the highest emissions to ensure that the EUT complied with all installation combinations.

Data was recorded in Quasi-peak detection mode for frequency range of 30 MHz-1 GHz, peak and Average detection modes for frequencies above 1 GHz.

Corrected Amplitude & Margin Calculation

The Corrected Amplitude is calculated by adding the Antenna Loss and Cable Loss, and subtracting the Amplifier Gain from the Meter Reading. The basic equation is as follows:

$$\text{Corrected Amplitude} = \text{Meter Reading} + \text{Antenna Loss} + \text{Cable Loss} - \text{Amplifier Gain}$$

The “**Margin**” column of the following data tables indicates the degree of compliance with the applicable limit. For example, a margin of 7dB means the emission is 7dB below the limit. The equation for margin calculation is as follows:

$$\text{Margin} = \text{Limit} - \text{Corrected Amplitude}$$

Test Equipment List and Details

Manufacturer	Description	Model	Serial Number	Calibration Date	Calibration Due Date
Rohde & Schwarz	EMI Test Receiver	ESCI	100035	2012-05-14	2013-05-13
Sunol Sciences	Hybrid Antennas	JB3	A060611-1	2011-09-06	2013-09-05
HP	Pre-amplifier	8447E	2434A02181	2012-10-08	2013-10-07
R&S	Spectrum Analyzer	FSEM 30	DE31388	2012-03-15	2013-03-14
ETS-LINDGREN	Horn Antenna	3115	000 527 35	2012-09-06	2014-09-05
Mini-Circuit	Amplifier	ZVA-213-S+	054201245	2013-01-30	2014-01-29

Test Results Summary

According to the recorded data in following table, the EUT complied with the FCC Title 47, Part 15, Section 15.205, 15.209 and 15.247, with the worst margin reading of:

2.43 dB at 2390 MHz in the **Vertical** polarization for 802.11b Mode

Test Data

Environmental Conditions

Temperature:	23.9 °C~24.6 °C
Relative Humidity:	47 %~48 %
ATM Pressure:	101.4kPa~101.7kPa

The testing was performed by Leon Chen from 2013-02-23 to 2013-02-25.

Mode: Transmitting
802.11b Mode

Frequency (MHz)	Receiver		Rx Antenna		Cable loss (dB)	Amplifier Gain (dB)	Corrected Amplitude (dBµV/m)	FCC 15.247	
	Reading (dBµV)	Detector (PK/QP/AV)	Polar (H/V)	Factor (dB)				Limit (dBµV/m)	Margin (dB)
Low Channel: 2412 MHz									
2390	22.12	AV	V	25.61	3.84	0.00	51.57	54.00	2.43
9648	31.67	AV	V	36.06	8.70	26.06	50.37	54.00	3.63
4824	38.88	AV	V	30.64	4.73	27.26	46.99	54.00	7.01
2390	33.92	PK	V	25.61	3.84	0.00	63.37	74.00	10.63
3643.89	35.69	AV	V	29.12	4.80	27.44	42.17	54.00	11.83
7236	22.41	AV	V	34.17	6.56	26.36	36.78	54.00	17.22
9648	37.15	PK	V	36.06	8.70	26.06	55.85	74.00	18.15
327.82	30.28	QP	V	15.51	2.30	21.66	26.43	46.00	19.57
4824	43.61	PK	V	30.64	4.73	27.26	51.72	74.00	22.28
7236	34.27	PK	V	34.17	6.56	26.36	48.64	74.00	25.36
3643.89	40.26	PK	V	29.12	4.80	27.44	46.74	74.00	27.26
2412	72.48	PK	H	25.67	3.93	0.00	102.08	N/A	N/A
2412	66.34	AV	H	25.67	3.93	0.00	95.94	N/A	N/A
2412	85.17	PK	V	25.67	3.93	0.00	114.77	N/A	N/A
2412	78.44	AV	V	25.67	3.93	0.00	108.04	N/A	N/A
Middle Channel: 2437 MHz									
9748	31.71	AV	V	36.30	8.60	25.68	50.93	54.00	3.07
4874	38.84	AV	V	30.77	4.76	27.26	47.11	54.00	6.89
3643.89	35.54	AV	V	29.12	4.80	27.44	42.02	54.00	11.98
3282.5	36.04	AV	V	28.10	4.82	27.41	41.55	54.00	12.45
402.11	32.84	QP	V	16.26	2.43	21.78	29.75	46.00	16.25
7311	22.37	AV	V	34.35	6.70	26.51	36.91	54.00	17.09
9748	37.15	PK	V	36.30	8.60	25.68	56.37	74.00	17.63
4874	43.58	PK	V	30.77	4.76	27.26	51.85	74.00	22.15
7311	34.42	PK	V	34.35	6.70	26.51	48.96	74.00	25.04
3643.89	40.16	PK	V	29.12	4.80	27.44	46.64	74.00	27.36
3282.5	40.52	PK	V	28.10	4.82	27.41	46.03	74.00	27.97
2437	72.18	PK	H	25.74	3.98	0.00	101.90	N/A	N/A
2437	66.11	AV	H	25.74	3.98	0.00	95.83	N/A	N/A
2437	84.91	PK	V	25.74	3.98	0.00	114.63	N/A	N/A
2437	78.07	AV	V	25.74	3.98	0.00	107.79	N/A	N/A
High Channel: 2462 MHz									
2483.5	21.68	AV	V	25.86	3.80	0.00	51.34	54.00	2.66
9848	31.61	AV	V	36.54	8.49	25.49	51.15	54.00	2.85
4924	38.81	AV	V	30.90	4.70	27.27	47.14	54.00	6.86
2483.5	34.98	PK	V	25.86	3.80	0.00	64.64	74.00	9.36
3643.9	35.67	AV	V	29.12	4.80	27.44	42.15	54.00	11.85
7386	22.35	AV	V	34.53	6.84	26.66	37.06	54.00	16.94
9848	37.02	PK	V	36.54	8.49	25.49	56.56	74.00	17.44
329.61	29.67	QP	V	15.77	2.35	21.72	26.07	46.00	19.93
4924	43.35	PK	V	30.90	4.70	27.27	51.68	74.00	22.32
7386	34.16	PK	V	34.53	6.84	26.66	48.87	74.00	25.13
3643.9	40.24	PK	V	29.12	4.80	27.44	46.72	74.00	27.28
2462	72.33	PK	H	25.80	3.93	0.00	102.06	N/A	N/A
2462	66.23	AV	H	25.80	3.93	0.00	95.96	N/A	N/A
2462	84.87	PK	V	25.80	3.93	0.00	114.60	N/A	N/A
2462	78.04	AV	V	25.80	3.93	0.00	107.77	N/A	N/A

802.11g Mode

Frequency (MHz)	Receiver		Rx Antenna		Cable loss (dB)	Amplifier Gain (dB)	Corrected Amplitude (dBµV/m)	FCC 15.247	
	Reading (dBµV)	Detector (PK/QP/AV)	Polar (H/V)	Factor (dB)				Limit (dBµV/m)	Margin (dB)
Low Channel: 2412 MHz									
2390	19.98	AV	V	25.61	3.84	0.00	49.43	54.00	4.57
2390	36.28	PK	V	25.61	3.84	0.00	65.73	74.00	8.27
3643.89	35.35	AV	V	29.12	4.80	27.44	41.83	54.00	12.17
9648	18.04	AV	V	36.06	8.70	26.06	36.74	54.00	17.26
327.82	29.35	QP	V	15.51	2.30	21.66	25.50	46.00	20.50
7236	17.82	AV	V	34.17	6.56	26.36	32.19	54.00	21.81
9648	32.26	PK	V	36.06	8.70	26.06	50.96	74.00	23.04
4824	18.83	AV	V	30.64	4.73	27.26	26.94	54.00	27.06
3643.89	40.26	PK	V	29.12	4.80	27.44	46.74	74.00	27.26
7236	31.55	PK	V	34.17	6.56	26.36	45.92	74.00	28.08
4824	31.69	PK	V	30.64	4.73	27.26	39.80	74.00	34.20
2412	66.91	PK	H	25.67	3.93	0.00	96.51	N/A	N/A
2412	52.73	AV	H	25.67	3.93	0.00	82.33	N/A	N/A
2412	78.74	PK	V	25.67	3.93	0.00	108.34	N/A	N/A
2412	64.59	AV	V	25.67	3.93	0.00	94.19	N/A	N/A
Middle Channel: 2437 MHz									
9748	18.03	AV	V	36.30	8.60	25.68	37.25	54.00	16.75
7311	17.83	AV	V	34.35	6.70	26.51	32.37	54.00	21.63
4874	18.81	AV	V	30.77	4.76	27.26	27.08	54.00	26.92
3643.89	40.17	PK	V	29.12	4.80	27.44	46.65	74.00	27.35
7311	31.58	PK	V	34.35	6.70	26.51	46.12	74.00	27.88
3282.7	39.93	PK	V	28.10	4.82	27.41	45.44	74.00	28.56
4874	31.71	PK	V	30.77	4.76	27.26	39.98	74.00	34.02
3643.89	35.22	AV	V	29.12	4.80	27.44	41.70	54.00	12.30
3282.7	35.16	AV	V	28.10	4.82	27.41	40.67	54.00	13.33
402.11	31.6	QP	V	16.26	2.43	21.78	28.51	46.00	17.49
9748	32.28	PK	V	36.30	8.60	25.68	51.50	74.00	22.50
2437	66.84	PK	H	25.74	3.98	0.00	96.56	N/A	N/A
2437	52.67	AV	H	25.74	3.98	0.00	82.39	N/A	N/A
2437	78.61	PK	V	25.74	3.98	0.00	108.33	N/A	N/A
2437	64.57	AV	V	25.74	3.98	0.00	94.29	N/A	N/A
High Channel: 2462 MHz									
2483.5	20.34	AV	V	25.86	3.80	0.00	50.00	54.00	4.00
2483.5	37.2	PK	V	25.86	3.80	0.00	66.86	74.00	7.14
3643.89	35.29	AV	V	29.12	4.80	27.44	41.77	54.00	12.23
9848	17.98	AV	V	36.54	8.49	25.49	37.52	54.00	16.48
329.61	30.47	QP	V	15.77	2.35	21.72	26.87	46.00	19.13
7386	17.81	AV	V	34.53	6.84	26.66	32.52	54.00	21.48
9848	32.24	PK	V	36.54	8.49	25.49	51.78	74.00	22.22
4924	18.79	AV	V	30.90	4.70	27.27	27.12	54.00	26.88
3643.89	40.18	PK	V	29.12	4.80	27.44	46.66	74.00	27.34
7386	31.54	PK	V	34.53	6.84	26.66	46.25	74.00	27.75
4924	31.65	PK	V	30.90	4.70	27.27	39.98	74.00	34.02
2462	66.53	PK	H	25.80	3.93	0.00	96.26	N/A	N/A
2462	52.46	AV	H	25.80	3.93	0.00	82.19	N/A	N/A
2462	78.16	PK	V	25.80	3.93	0.00	107.89	N/A	N/A
2462	64.15	AV	V	25.80	3.93	0.00	93.88	N/A	N/A

802.11 n20 Mode

Frequency (MHz)	Receiver		Rx Antenna		Cable loss (dB)	Amplifier Gain (dB)	Corrected Amplitude (dBµV/m)	FCC 15.247	
	Reading (dBµV)	Detector (PK/QP/AV)	Polar (H/V)	Factor (dB)				Limit (dBµV/m)	Margin (dB)
Low Channel: 2412 MHz									
2390	17.13	AV	V	25.61	3.84	0.00	46.58	54.00	7.42
3643.89	35.11	AV	V	29.12	4.80	27.44	41.59	54.00	12.41
2390	30.37	PK	V	25.61	3.84	0.00	59.82	74.00	14.18
9648	18.03	AV	V	36.06	8.70	26.06	36.73	54.00	17.27
327.82	31.46	QP	V	15.51	2.30	21.66	27.61	46.00	18.39
7236	17.83	AV	V	34.17	6.56	26.36	32.20	54.00	21.80
9648	32.31	PK	V	36.06	8.70	26.06	51.01	74.00	22.99
4824	18.81	AV	V	30.64	4.73	27.26	26.92	54.00	27.08
3643.89	40.19	PK	V	29.12	4.80	27.44	46.67	74.00	27.33
7236	31.63	PK	V	34.17	6.56	26.36	46.00	74.00	28.00
4824	31.72	PK	V	30.64	4.73	27.26	39.83	74.00	34.17
2412	63.81	PK	H	25.67	3.93	0.00	93.41	N/A	N/A
2412	49.55	AV	H	25.67	3.93	0.00	79.15	N/A	N/A
2412	74.72	PK	V	25.67	3.93	0.00	104.32	N/A	N/A
2412	60.49	AV	V	25.67	3.93	0.00	90.09	N/A	N/A
Middle Channel: 2437 MHz									
3643.89	35.38	AV	V	29.12	4.80	27.44	41.86	54.00	12.14
3282.7	35.17	AV	V	28.10	4.82	27.41	40.68	54.00	13.32
9748	18.04	AV	V	36.30	8.60	25.68	37.26	54.00	16.74
402.11	29.77	QP	V	16.26	2.43	21.78	26.68	46.00	19.32
7311	17.83	AV	V	34.35	6.70	26.51	32.37	54.00	21.63
9748	32.26	PK	V	36.30	8.60	25.68	51.48	74.00	22.52
4874	18.79	AV	V	30.77	4.76	27.26	27.06	54.00	26.94
3643.89	40.31	PK	V	29.12	4.80	27.44	46.79	74.00	27.21
7311	31.58	PK	V	34.35	6.70	26.51	46.12	74.00	27.88
3282.7	40.29	PK	V	28.10	4.82	27.41	45.80	74.00	28.20
4874	31.65	PK	V	30.77	4.76	27.26	39.92	74.00	34.08
2437	63.77	PK	H	25.74	3.98	0.00	93.49	N/A	N/A
2437	49.57	AV	H	25.74	3.98	0.00	79.29	N/A	N/A
2437	74.83	PK	V	25.74	3.98	0.00	104.55	N/A	N/A
2437	60.58	AV	V	25.74	3.98	0.00	90.30	N/A	N/A
High Channel: 2462 MHz									
2483.5	16.75	AV	V	25.86	3.80	0.00	46.41	54.00	7.59
3643.89	35.26	AV	V	29.12	4.80	27.44	41.74	54.00	12.26
2483.5	29.89	PK	V	25.86	3.80	0.00	59.55	74.00	14.45
9848	18.13	AV	V	36.54	8.49	25.49	37.67	54.00	16.33
329.61	30.14	QP	V	15.77	2.35	21.72	26.54	46.00	19.46
7386	17.88	AV	V	34.53	6.84	26.66	32.59	54.00	21.41
9848	32.31	PK	V	36.54	8.49	25.49	51.85	74.00	22.15
4924	18.89	AV	V	30.90	4.70	27.27	27.22	54.00	26.78
3643.89	40.34	PK	V	29.12	4.80	27.44	46.82	74.00	27.18
7386	31.85	PK	V	34.53	6.84	26.66	46.56	74.00	27.44
4924	31.87	PK	V	30.90	4.70	27.27	40.20	74.00	33.80
2462	63.54	PK	H	25.80	3.93	0.00	93.27	N/A	N/A
2462	49.37	AV	H	25.80	3.93	0.00	79.10	N/A	N/A
2462	74.33	PK	V	25.80	3.93	0.00	104.06	N/A	N/A
2462	60.14	AV	V	25.80	3.93	0.00	89.87	N/A	N/A

802.11 n40 Mode

Frequency (MHz)	Receiver		Rx Antenna		Cable loss (dB)	Amplifier Gain (dB)	Corrected Amplitude (dBµV/m)	FCC 15.247	
	Reading (dBµV)	Detector (PK/QP/AV)	Polar (H/V)	Factor (dB)				Limit (dBµV/m)	Margin (dB)
Low Channel: 2422 MHz									
2390	15.13	AV	V	25.61	3.84	0.00	44.58	54.00	9.42
3643.89	35.39	AV	V	29.12	4.80	27.44	41.87	54.00	12.13
2390	28.47	PK	V	25.61	3.84	0.00	57.92	74.00	16.08
9688	18.05	AV	V	36.15	8.66	25.91	36.95	54.00	17.05
327.82	31.08	QP	V	15.51	2.30	21.66	27.23	46.00	18.77
7266	17.96	AV	V	34.24	6.62	26.42	32.40	54.00	21.60
9688	32.61	PK	V	36.15	8.66	25.91	51.51	74.00	22.49
4844	18.94	AV	V	30.69	4.78	27.26	27.15	54.00	26.85
3643.89	40.26	PK	V	29.12	4.80	27.44	46.74	74.00	27.26
7266	31.49	PK	V	34.24	6.62	26.42	45.93	74.00	28.07
4844	31.66	PK	V	30.69	4.78	27.26	39.87	74.00	34.13
2422	62.99	PK	H	25.70	3.95	0.00	92.64	N/A	N/A
2422	49.07	AV	H	25.70	3.95	0.00	78.72	N/A	N/A
2422	73.76	PK	V	25.70	3.95	0.00	103.41	N/A	N/A
2422	60.27	AV	V	25.70	3.95	0.00	89.92	N/A	N/A
Middle Channel: 2437 MHz									
3643.89	35.27	AV	V	29.12	4.80	27.44	41.75	54.00	12.25
3282.7	35.61	AV	V	28.10	4.82	27.41	41.12	54.00	12.88
9748	18.06	AV	V	36.30	8.60	25.68	37.28	54.00	16.72
402.11	30.27	QP	V	16.26	2.43	21.78	27.18	46.00	18.82
7311	18.01	AV	V	34.35	6.70	26.51	32.55	54.00	21.45
9748	32.64	PK	V	36.30	8.60	25.68	51.86	74.00	22.14
4874	18.89	AV	V	30.77	4.76	27.26	27.16	54.00	26.84
3643.89	40.16	PK	V	29.12	4.80	27.44	46.64	74.00	27.36
7311	31.79	PK	V	34.35	6.70	26.51	46.33	74.00	27.67
3282.7	40.45	PK	V	28.10	4.82	27.41	45.96	74.00	28.04
4874	31.61	PK	V	30.77	4.76	27.26	39.88	74.00	34.12
2437	62.91	PK	H	25.74	3.98	0.00	92.63	N/A	N/A
2437	49.15	AV	H	25.74	3.98	0.00	78.87	N/A	N/A
2437	73.87	PK	V	25.74	3.98	0.00	103.59	N/A	N/A
2437	60.33	AV	V	25.74	3.98	0.00	90.05	N/A	N/A
High Channel: 2452 MHz									
2483.5	15.31	AV	V	25.86	3.80	0.00	44.97	54.00	9.03
3643.89	35.64	AV	V	29.12	4.80	27.44	42.12	54.00	11.88
2483.5	28.78	PK	V	25.86	3.80	0.00	58.44	74.00	15.56
9808	18.09	AV	V	36.44	8.53	25.48	37.58	54.00	16.42
329.61	30.15	QP	V	15.77	2.35	21.72	26.55	46.00	19.45
7356	17.97	AV	V	34.45	6.79	26.60	32.61	54.00	21.39
9808	32.19	PK	V	36.44	8.53	25.48	51.68	74.00	22.32
4904	18.91	AV	V	30.85	4.72	27.27	27.21	54.00	26.79
3643.89	40.29	PK	V	29.12	4.80	27.44	46.77	74.00	27.23
7356	31.58	PK	V	34.45	6.79	26.60	46.22	74.00	27.78
4904	31.67	PK	V	30.85	4.72	27.27	39.97	74.00	34.03
2452	62.81	PK	H	25.78	4.00	0.00	92.58	N/A	N/A
2452	48.93	AV	H	25.78	4.00	0.00	78.70	N/A	N/A
2452	73.58	PK	V	25.78	4.00	0.00	103.35	N/A	N/A
2452	59.68	AV	V	25.78	4.00	0.00	89.45	N/A	N/A

Conducted Spurious Emissions at Antenna Port

802.11b Low Channel

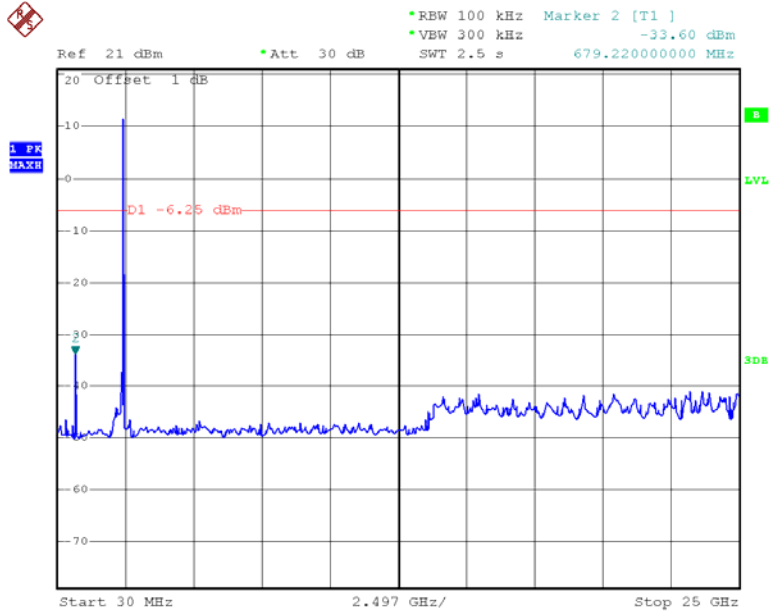

Date: 23.FEB.2013 13:27:24

802.11b Middle Channel

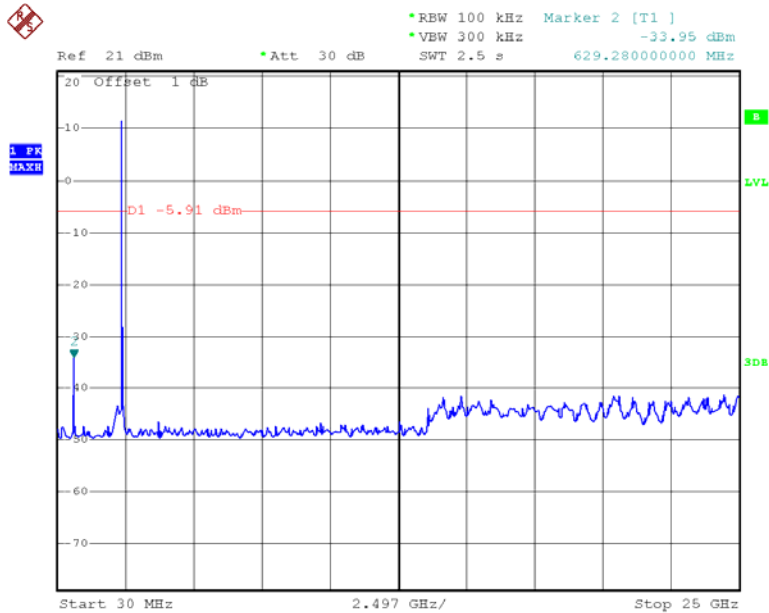

Date: 23.FEB.2013 13:30:22

802.11b High Channel

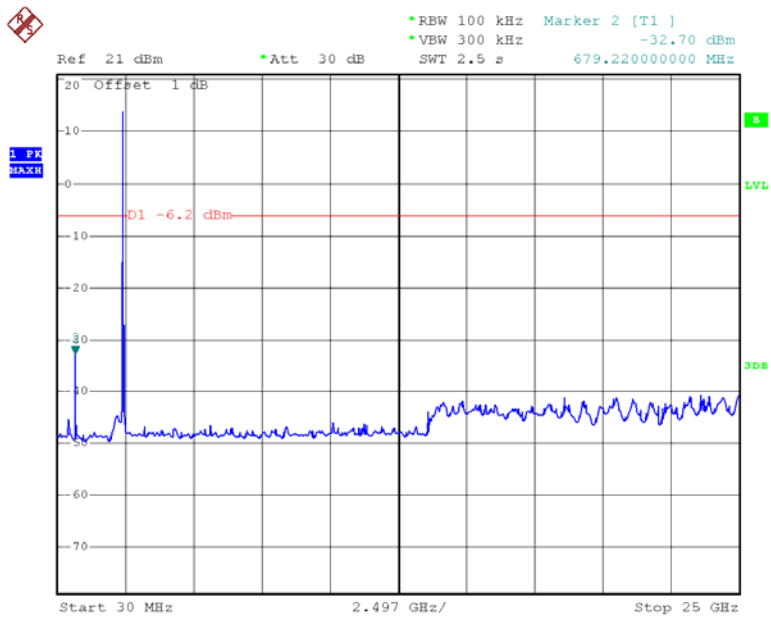

Date: 23.FEB.2013 13:35:17

802.11g Low Channel

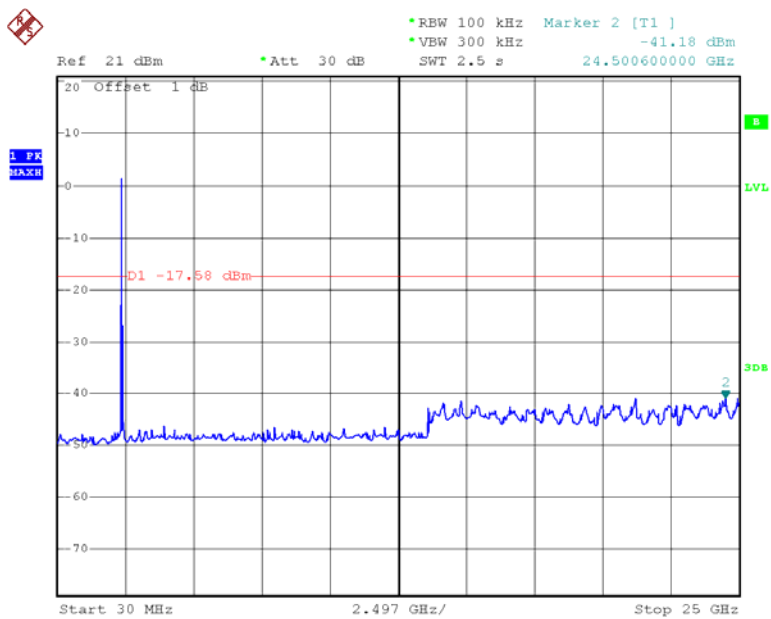

Date: 23.FEB.2013 13:44:08

802.11g Middle Channel

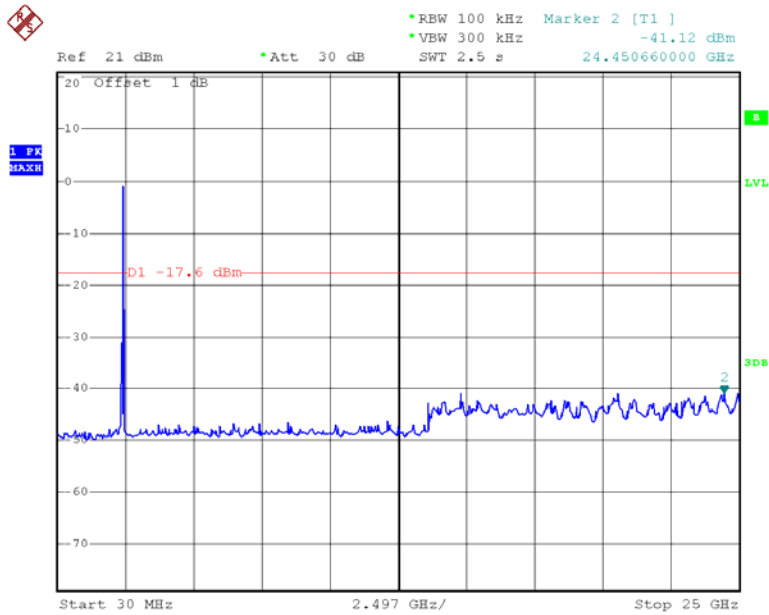

Date: 23.FEB.2013 13:50:15

802.11g High Channel

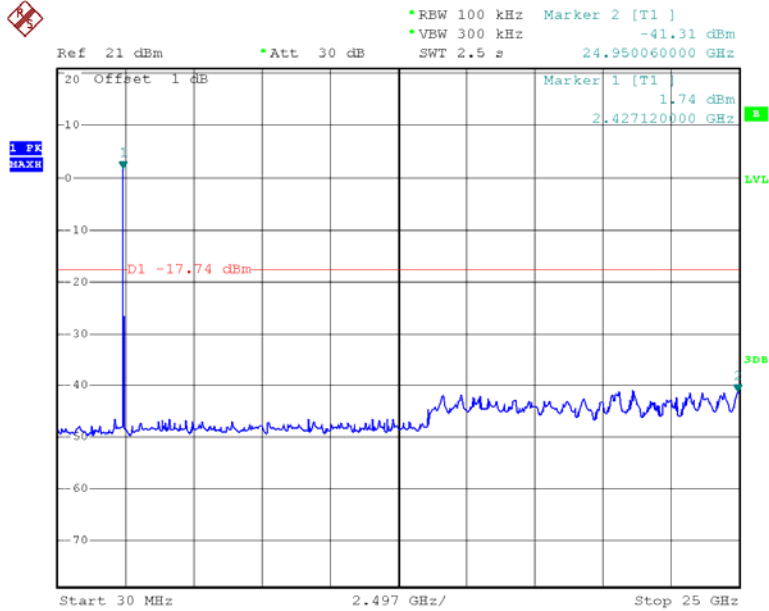

Date: 23.FEB.2013 13:55:24

Chain 0: 802.11n20 Low Channel

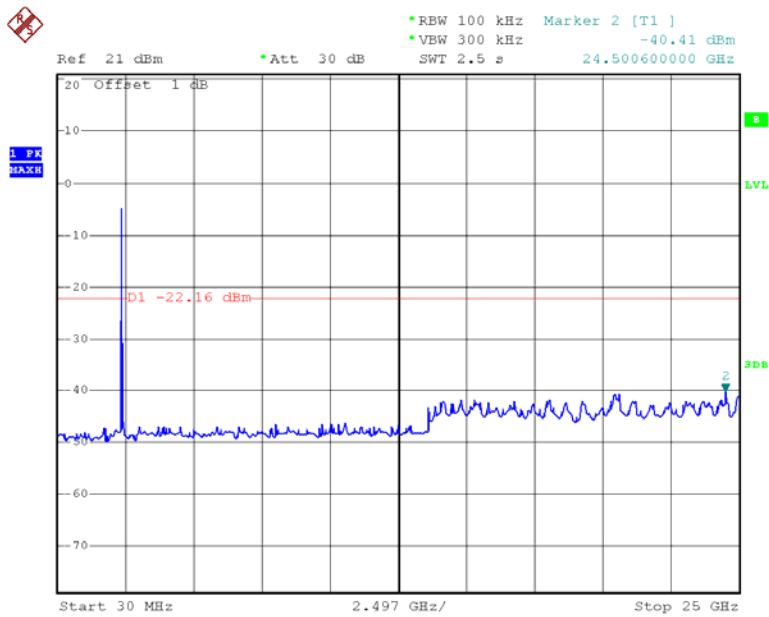

Date: 23.FEB.2013 14:15:49

Chain 0: 802.11n20 Middle Channel

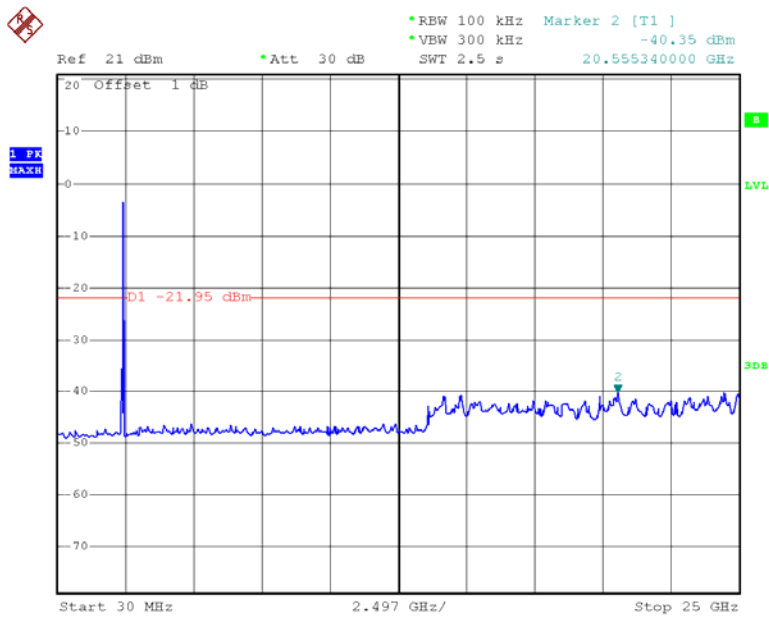

Date: 23.FEB.2013 14:39:49

Chain 0: 802.11n20 High Channel

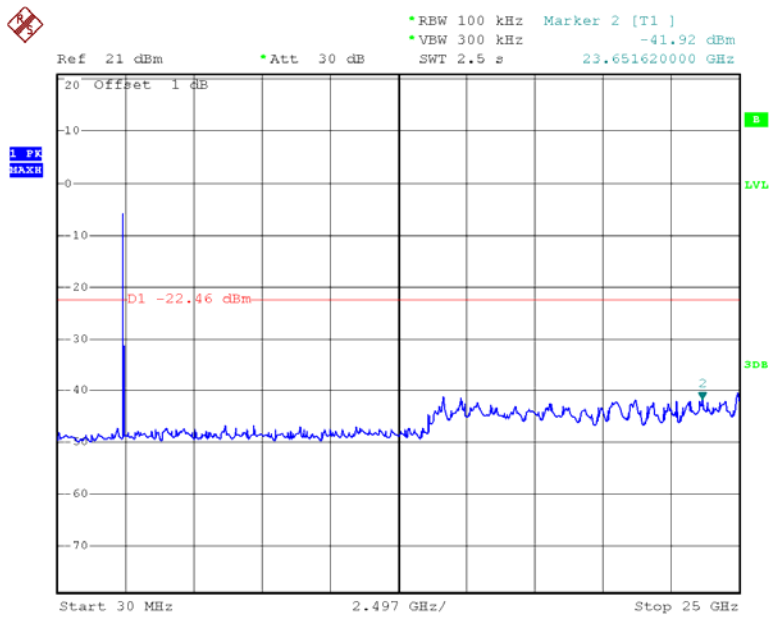

Date: 23.FEB.2013 14:50:33

Chain 1: 802.11n20 Low Channel

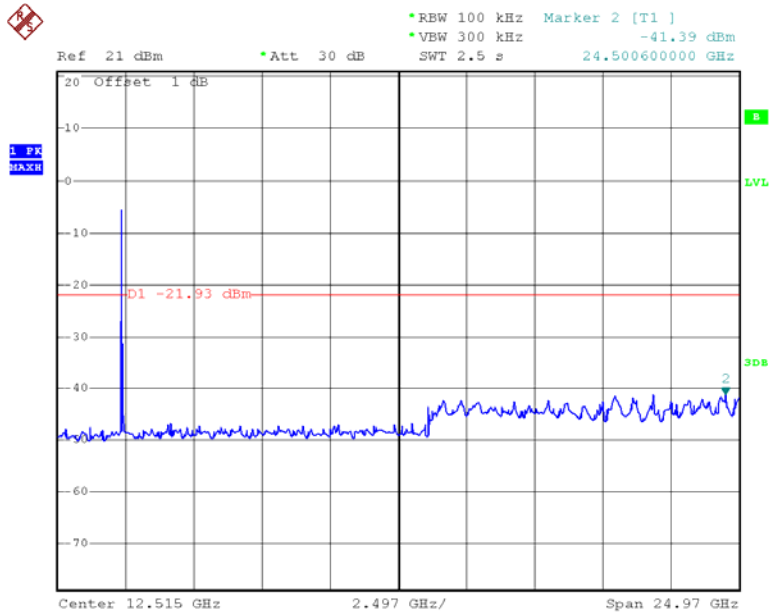

Date: 23.FEB.2013 14:17:44

Chain 1: 802.11n20 Middle Channel

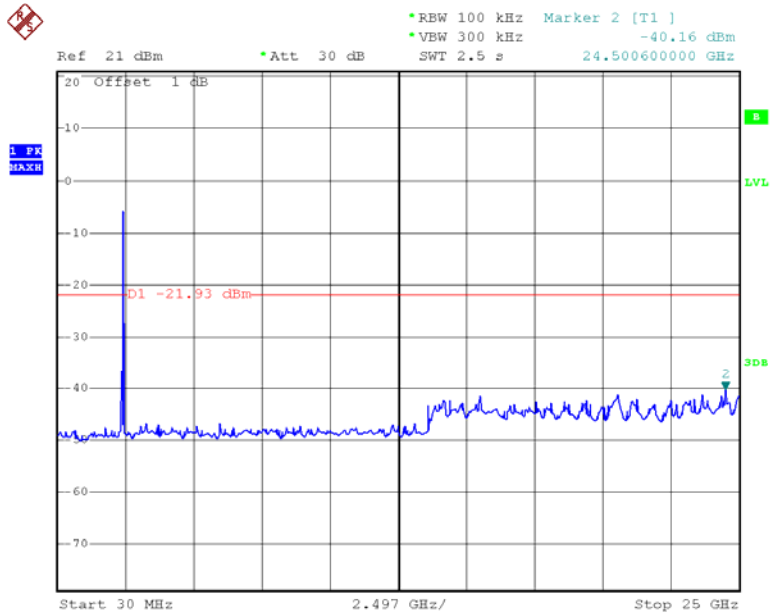

Date: 23.FEB.2013 14:40:20

Chain 1: 802.11n20 High Channel

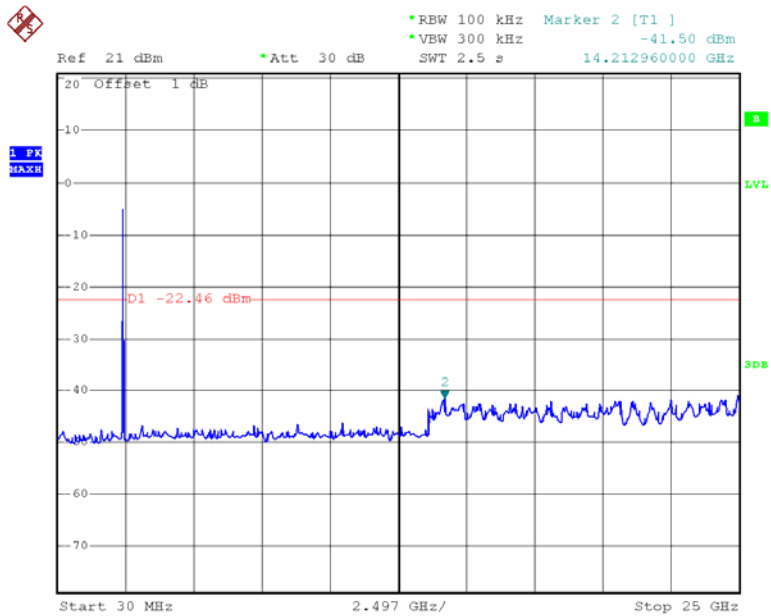

Date: 23.FEB.2013 14:51:12

Chain 2: 802.11n20 Low Channel

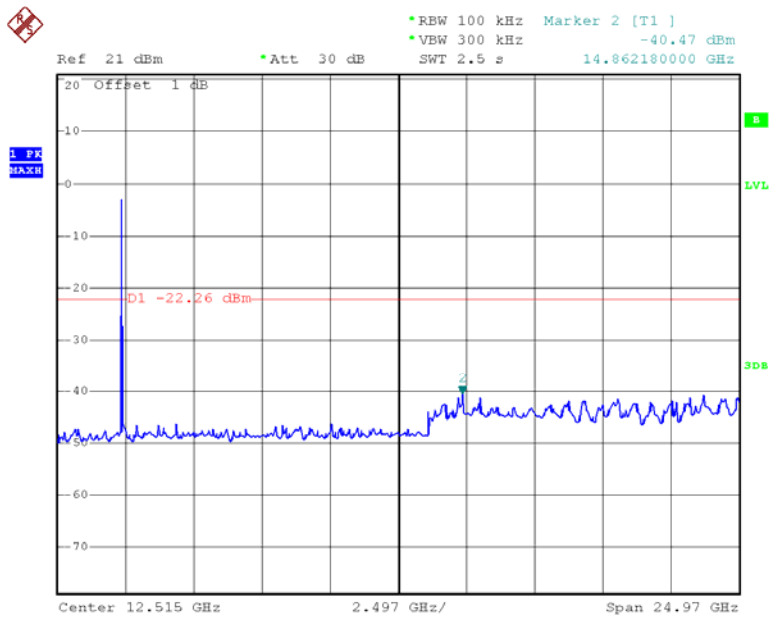

Date: 23.FEB.2013 14:19:03

Chain 2: 802.11n20 Middle Channel

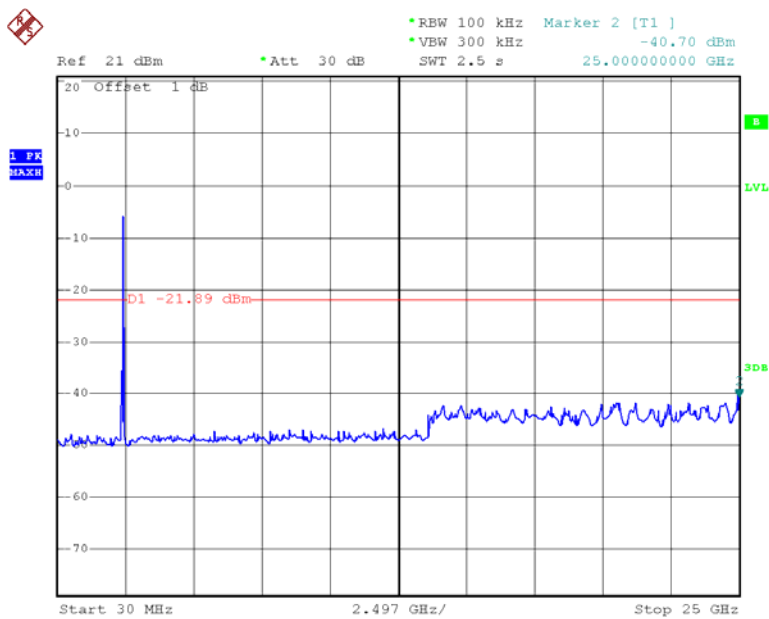

Date: 23.FEB.2013 14:40:50

Chain 2: 802.11n20 High Channel

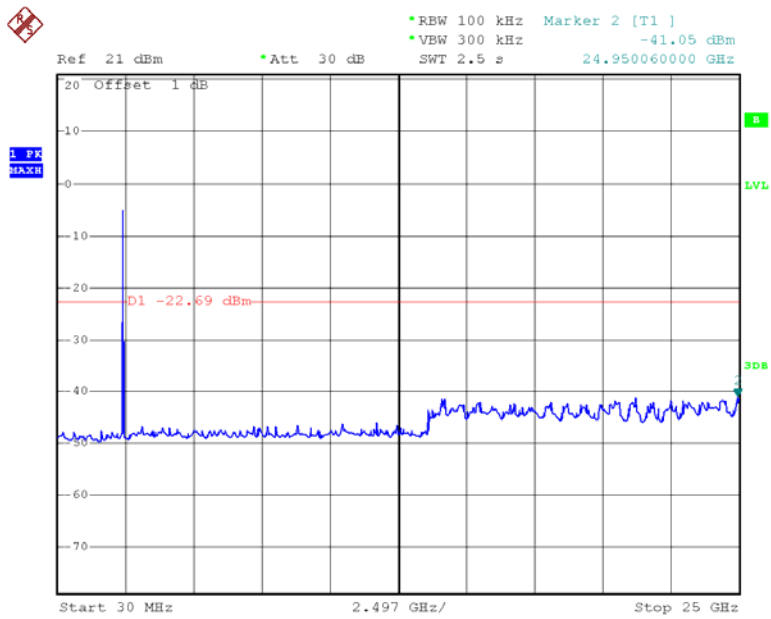

Date: 23.FEB.2013 14:51:39

Chain 0: 802.11n40 Low Channel

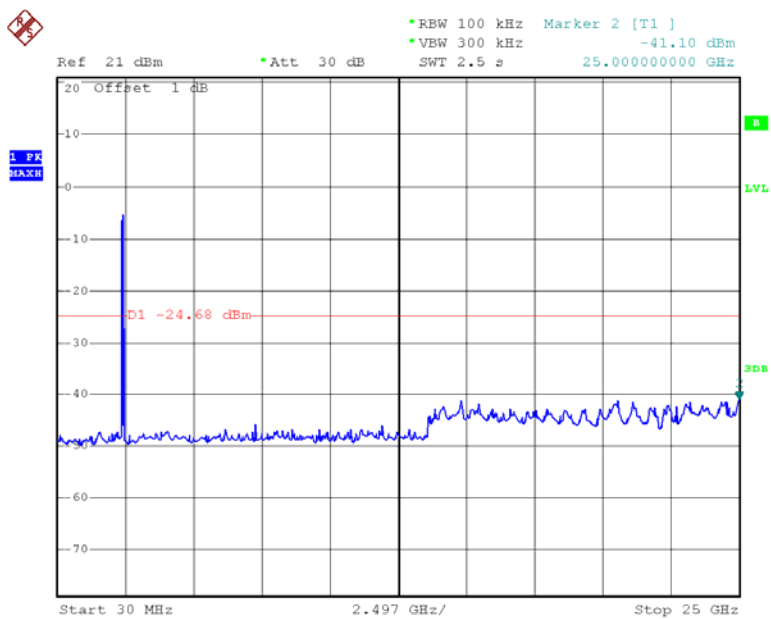

Date: 23.FEB.2013 15:04:29

Chain 0: 802.11n40 Middle Channel

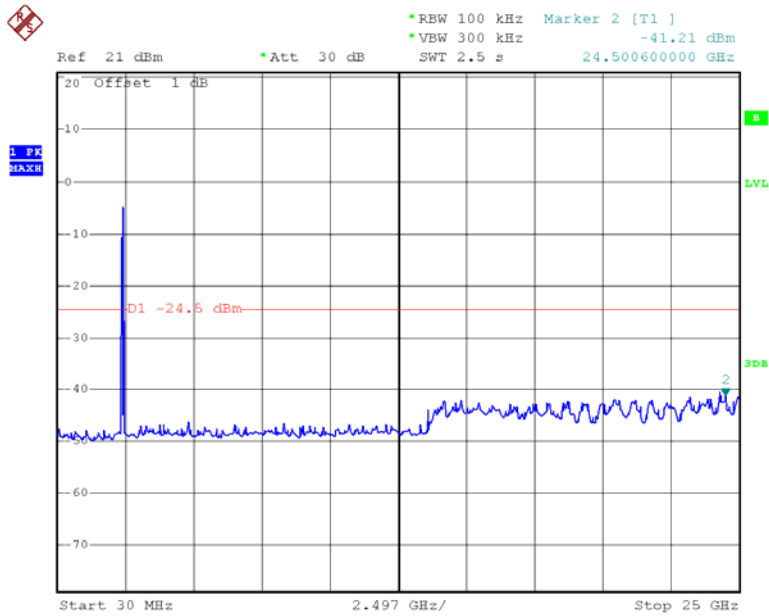

Date: 23.FEB.2013 15:16:23

Chain 0: 802.11n40 High Channel

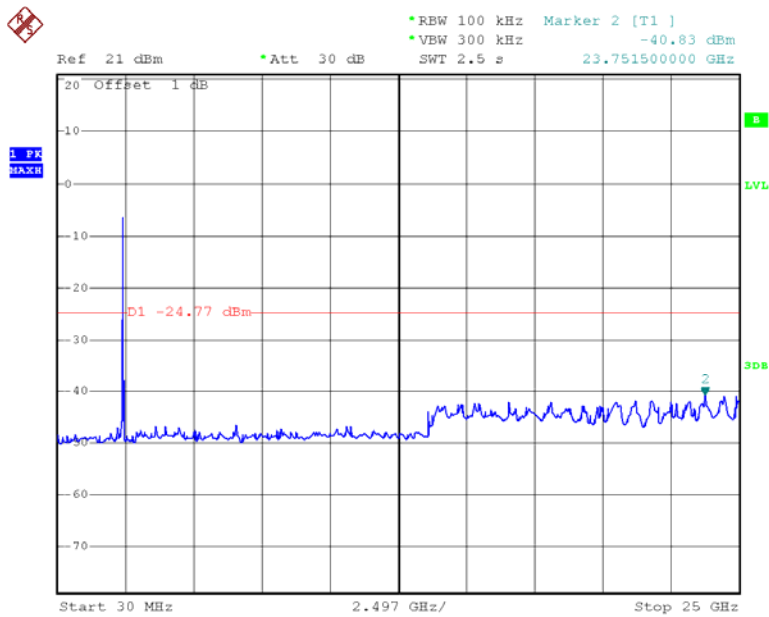

Date: 23.FEB.2013 15:24:52

Chain 1: 802.11n40 Low Channel

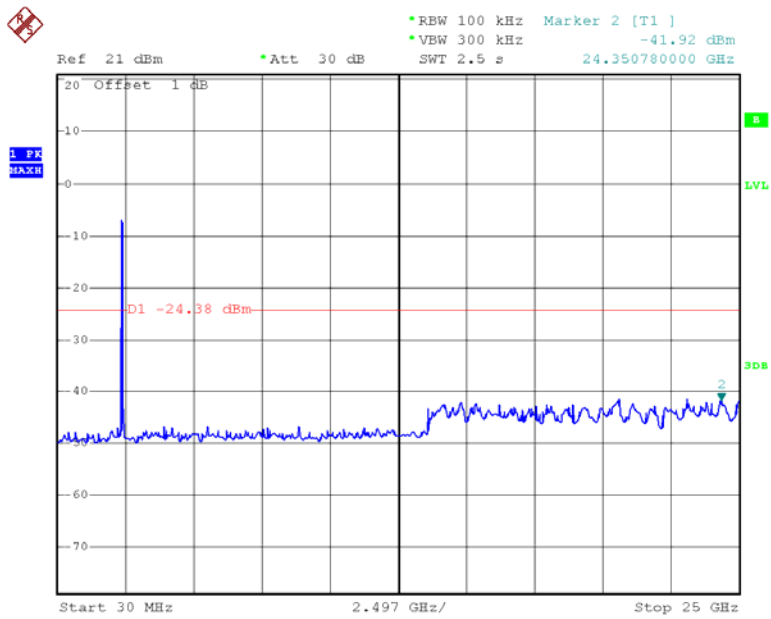

Date: 23.FEB.2013 15:05:11

Chain 1: 802.11n40 Middle Channel

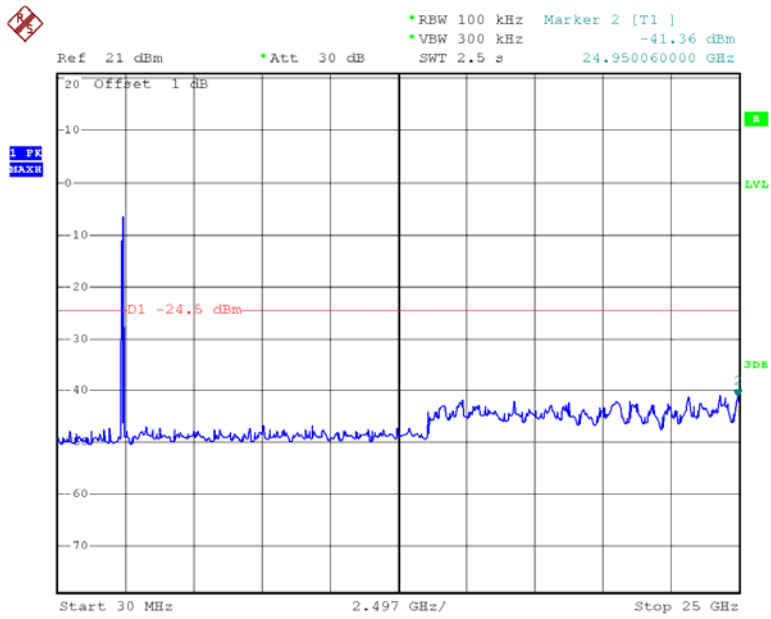

Date: 23.FEB.2013 15:16:44

Chain 1: 802.11n40 High Channel

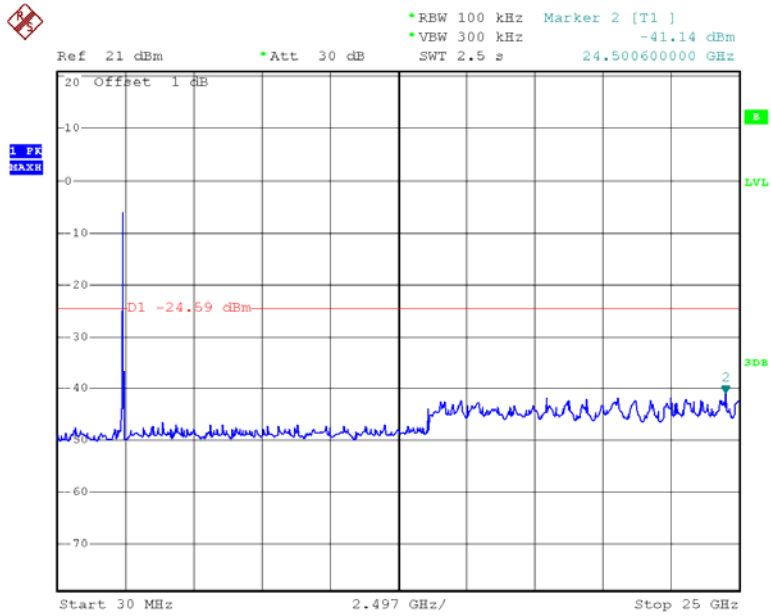

Date: 23.FEB.2013 15:25:22

Chain 2: 802.11n40 Low Channel

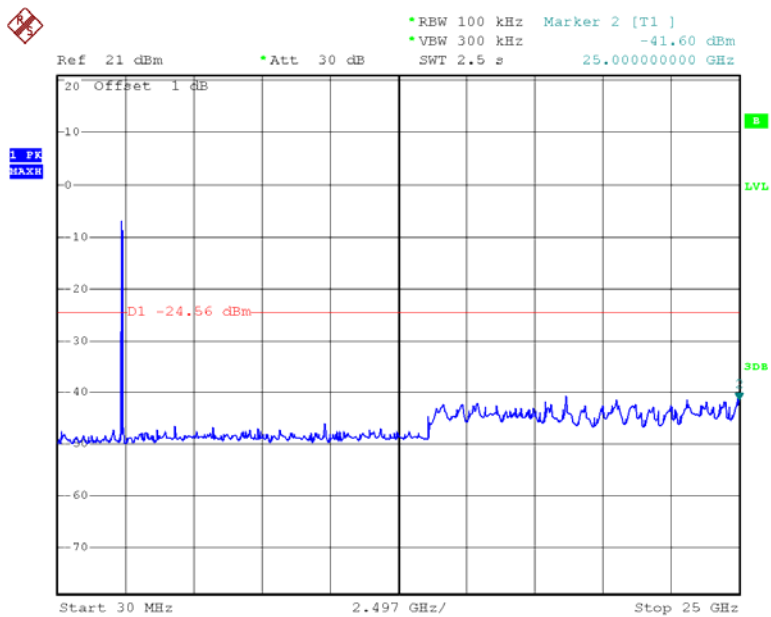

Date: 23.FEB.2013 15:05:47

Chain 2: 802.11n40 Middle Channel

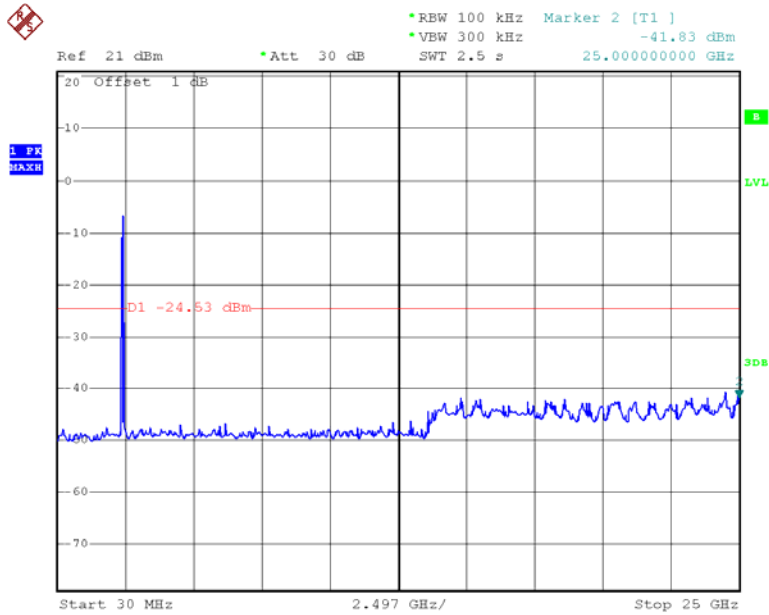

Date: 23.FEB.2013 15:17:08

Chain 2: 802.11n40 High Channel

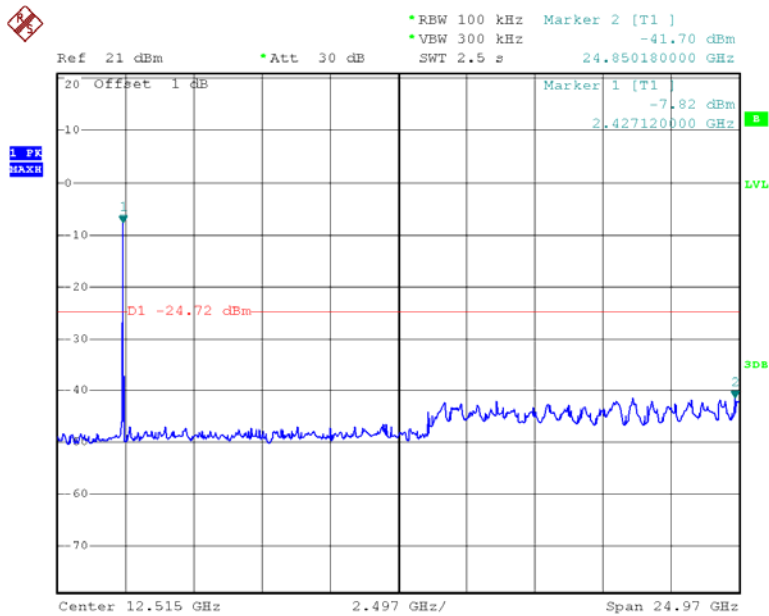

Date: 23.FEB.2013 15:25:49

FCC §15.247(a) (2) – 6 dB EMISSION BANDWIDTH

Applicable Standard

Systems using digital modulation techniques may operate in the 902–928 MHz, 2400–2483.5 MHz, and 5725–5850 MHz bands. The minimum 6 dB bandwidth shall be at least 500 kHz.

Test Procedure

1. Check the calibration of the measuring instrument using either an internal calibrator or a known signal from an external generator.
2. Position the EUT without connection to measurement instrument. Turn on the EUT and connect it to measurement instrument. Then set it to any one convenient frequency within its operating range. Set a reference level on the measuring instrument equal to the highest peak value.
3. Measure the frequency difference of two frequencies that were attenuated 6 dB from the reference level. Record the frequency difference as the emission bandwidth.
4. Repeat above procedures until all frequencies measured were complete.

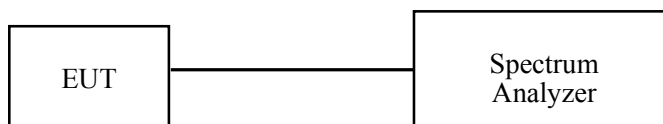

Test Equipment List and Details

Manufacturer	Description	Model	Serial Number	Calibration Date	Calibration Due Date
Rohde & Schwarz	Spectrum Analyzer	FSP38	100478	2012-5-14	2013-5-13

Test Data

Environmental Conditions

Temperature:	23.9 °C
Relative Humidity:	48%
ATM Pressure:	101.7kPa

The testing was performed by Leon Chen on 2013-02-23.

Test Result: Pass.

Please refer to the following tables and plots.

Channel	Frequency	6 dB Bandwidth	Limit
	(MHz)	(MHz)	(kHz)
802.11b mode			
Low	2412	8.24	>500
Middle	2437	8.32	>500
High	2462	8.32	>500
802.11g mode			
Low	2412	16.72	>500
Middle	2437	16.72	>500
High	2462	16.72	>500
chain 0: 802.11n20 mode			
Low	2412	17.76	>500
Middle	2437	17.84	>500
High	2462	17.84	>500
chain 1: 802.11n20 mode			
Low	2412	17.84	>500
Middle	2437	17.84	>500
High	2462	17.84	>500
chain 2: 802.11n20 mode			
Low	2412	17.84	>500
Middle	2437	17.84	>500
High	2462	17.84	>500
chain 0: 802.11n40 mode			
Low	2422	36.80	>500
Middle	2437	36.80	>500
High	2452	36.80	>500
chain 1: 802.11n40 mode			
Low	2422	36.80	>500
Middle	2437	36.80	>500
High	2452	36.80	>500
chain 2: 802.11n40 mode			
Low	2422	36.80	>500
Middle	2437	36.80	>500
High	2452	36.80	>500

802.11b Low Channel

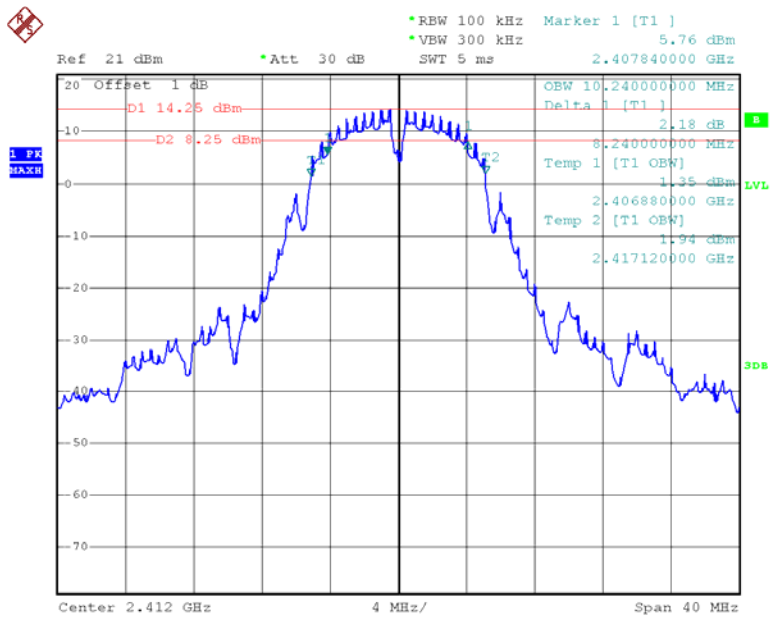

Date: 23.FEB.2013 11:50:30

802.11b Middle Channel

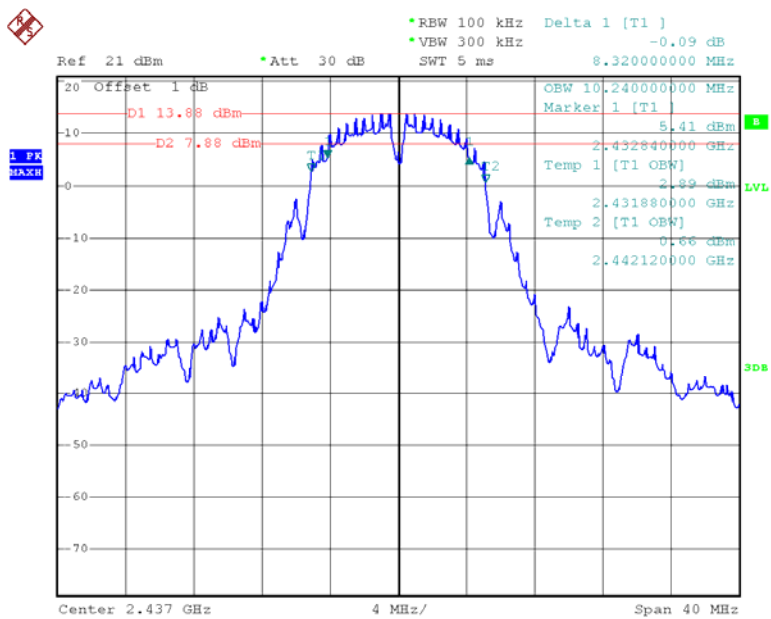

Date: 23.FEB.2013 13:06:36

802.11b High Channel

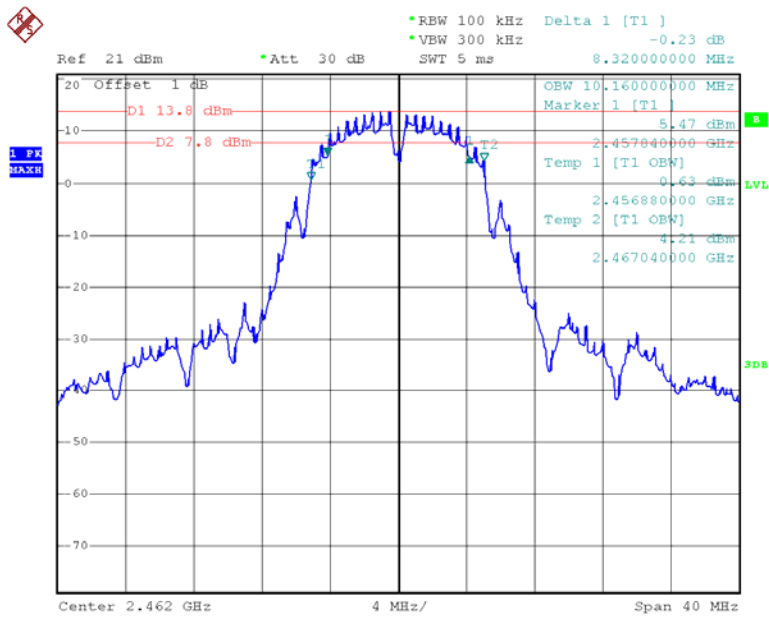

Date: 23.FEB.2013 13:32:40

802.11g Low Channel

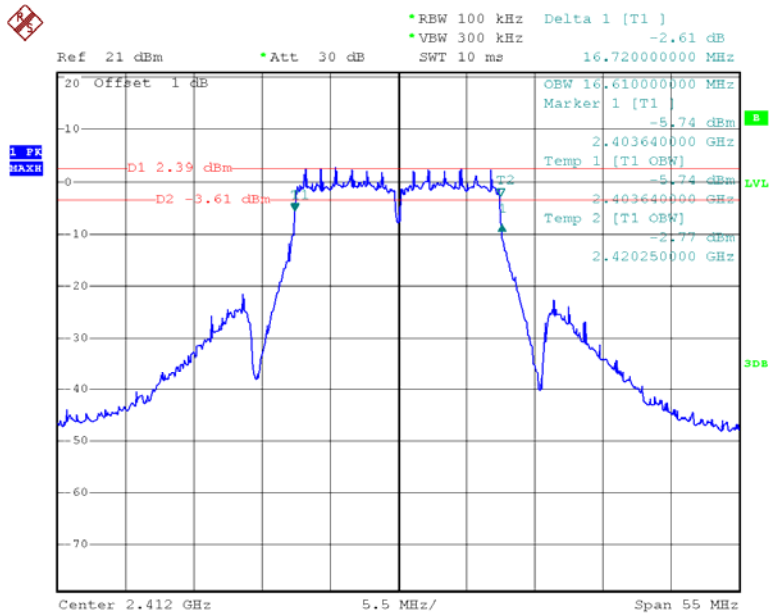

Date: 23.FEB.2013 13:40:57

802.11g Middle Channel

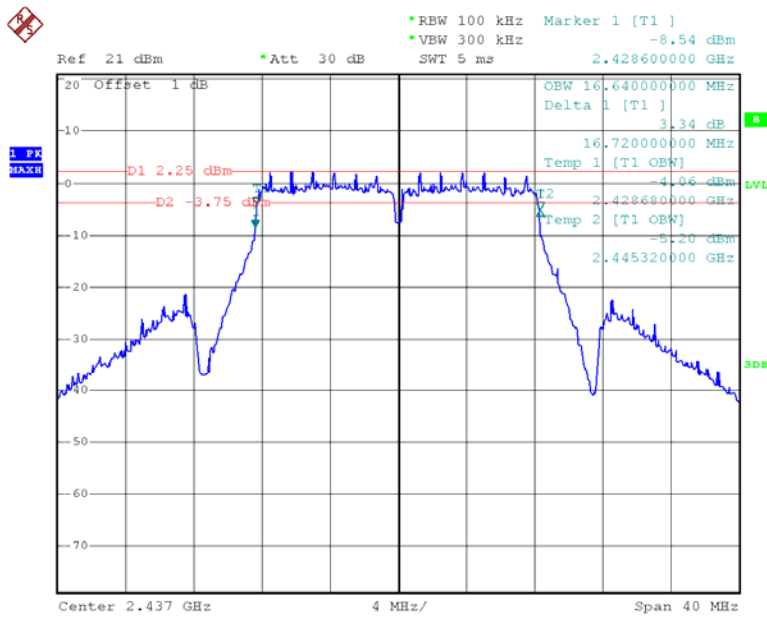

Date: 23.FEB.2013 13:47:19

802.11g High Channel

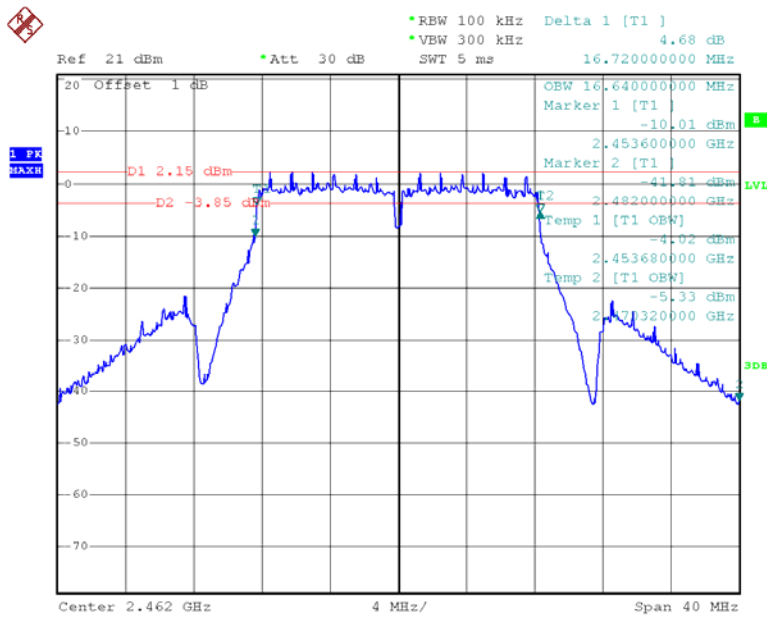

Date: 23.FEB.2013 13:51:47

Chain 0: 802.11n20 Low Channel

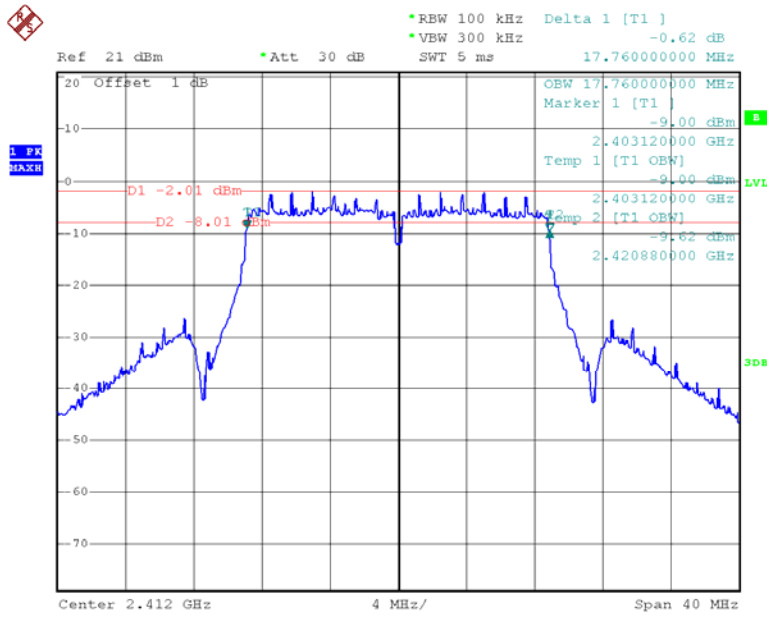

Date: 23.FEB.2013 14:06:36

Chain 0: 802.11n20 Middle Channel

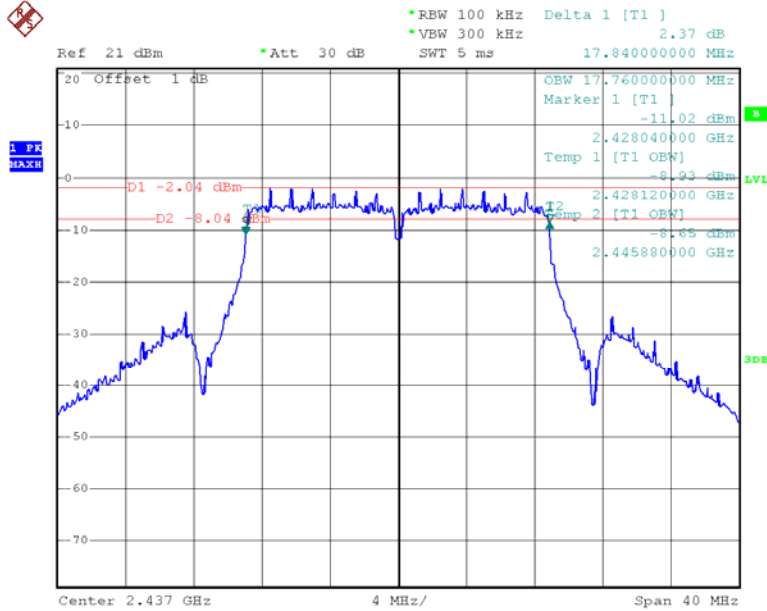

Date: 23.FEB.2013 14:28:59

Chain 0: 802.11n20 High Channel

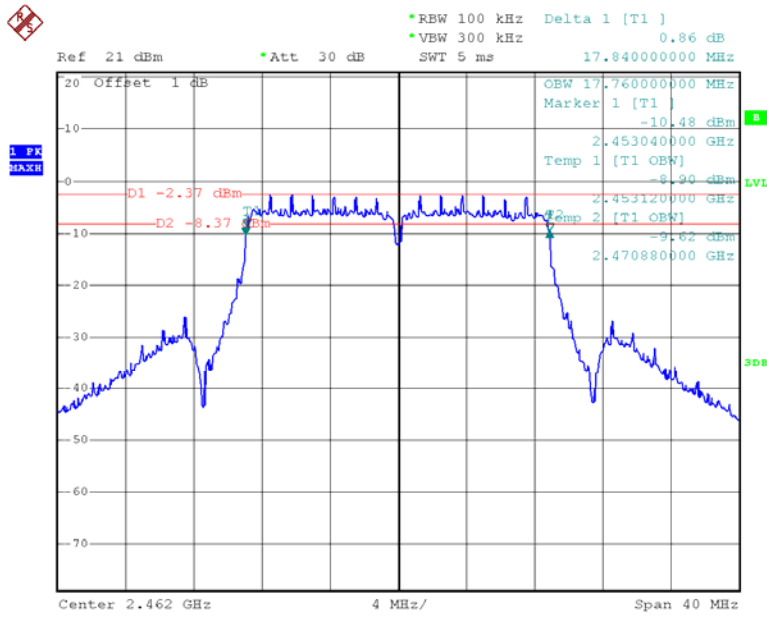

Date: 23.FEB.2013 14:42:58

Chain 1: 802.11n20 Low Channel

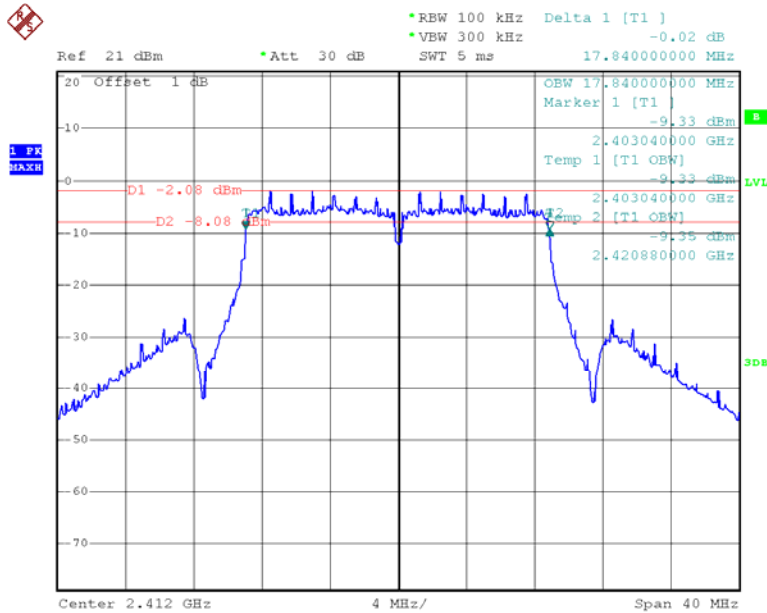

Date: 23.FEB.2013 14:07:59

Chain 1: 802.11n20 Middle Channel

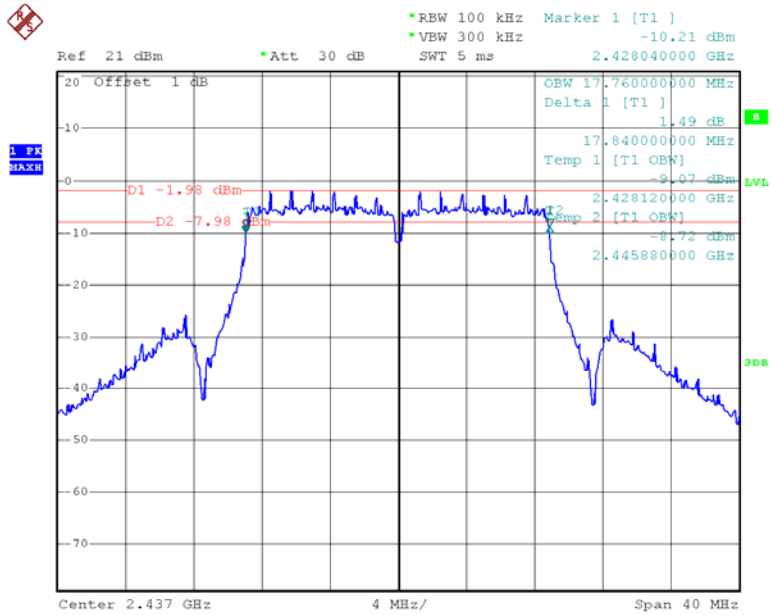

Date: 23.FEB.2013 14:30:29

Chain 1: 802.11n20 High Channel

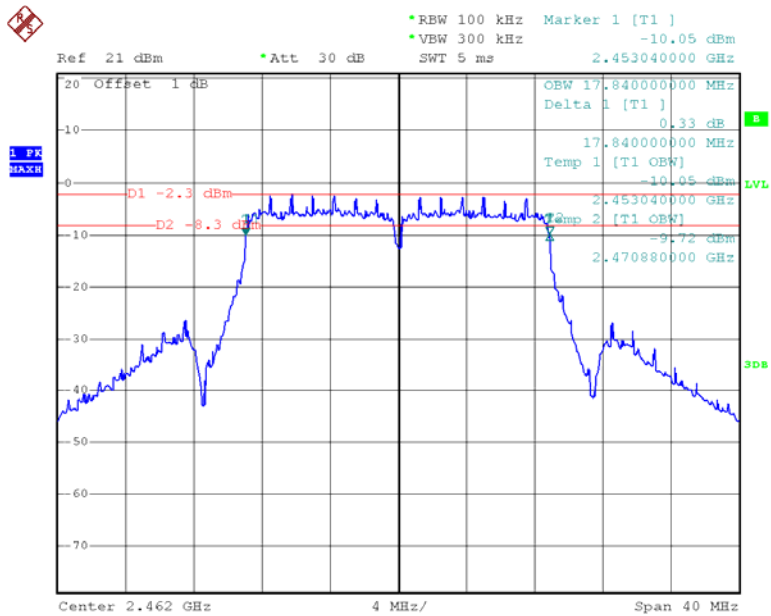

Date: 23.FEB.2013 14:44:24

Chain 2: 802.11n20 Low Channel

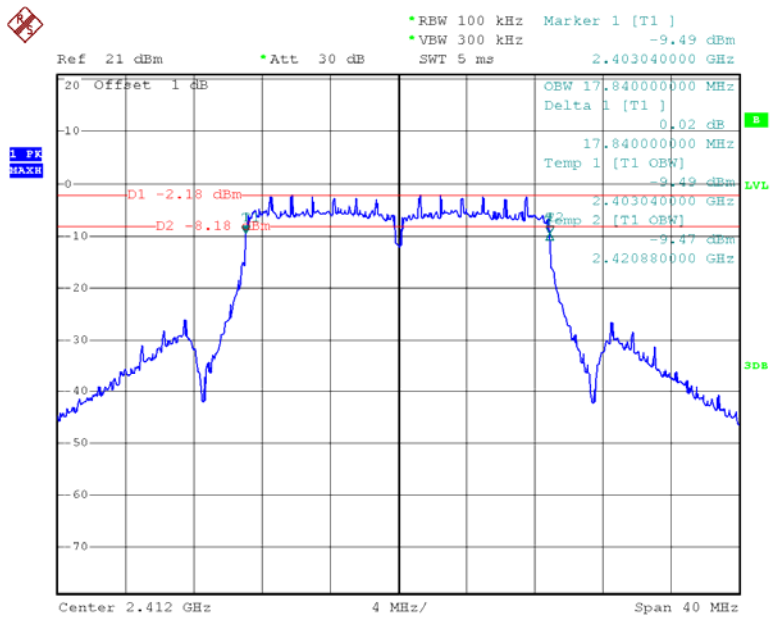

Date: 23.FEB.2013 14:09:32

Chain 2: 802.11n20 Middle Channel

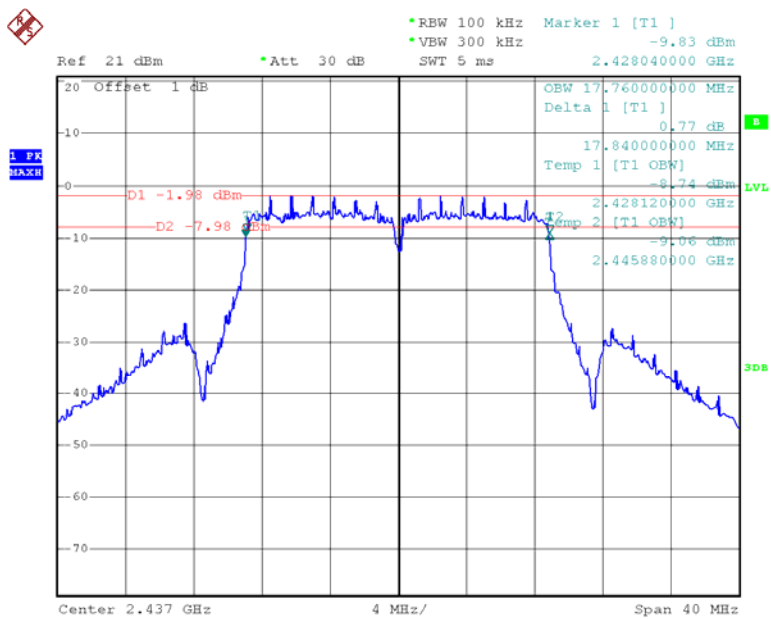

Date: 23.FEB.2013 14:31:27

Chain 2: 802.11n20 High Channel

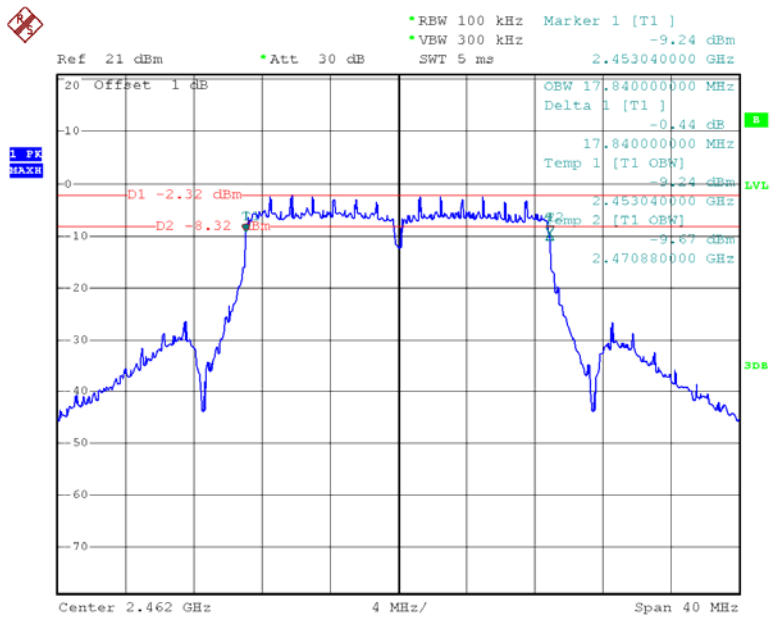

Date: 23.FEB.2013 14:45:23

Chain 0: 802.11n40 Low Channel

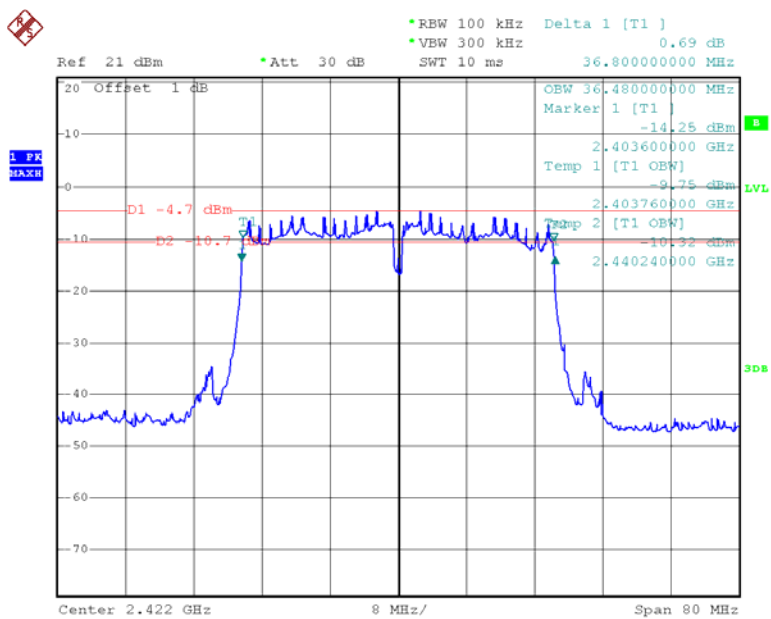

Date: 23.FEB.2013 14:57:35

Chain 0: 802.11n40 Middle Channel

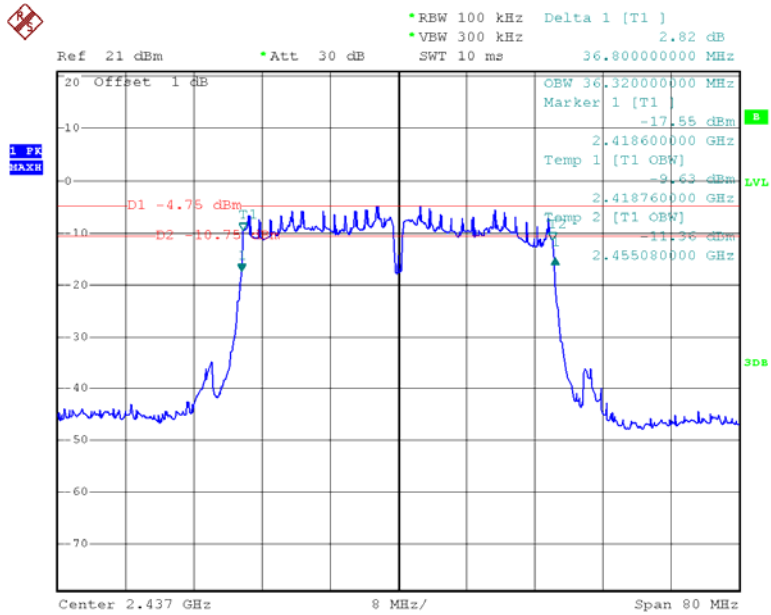

Date: 23.FEB.2013 15:09:34

Chain 0: 802.11n40 High Channel

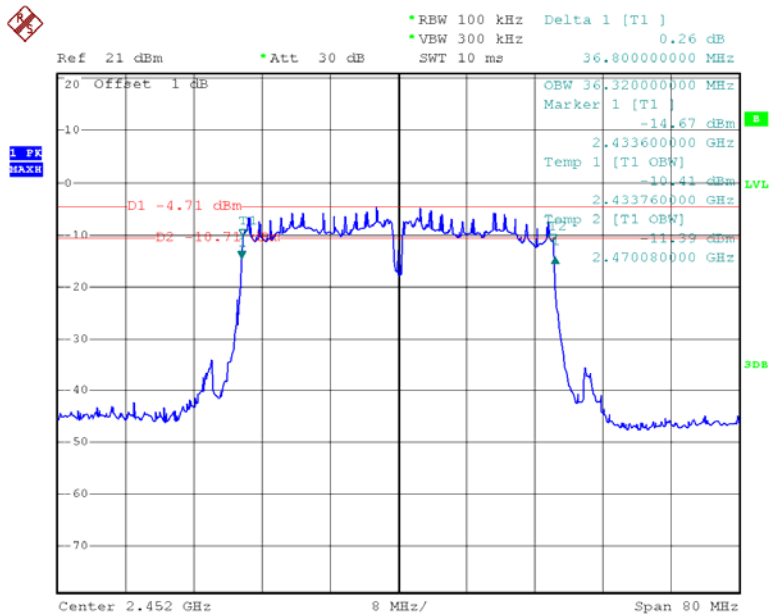

Date: 23.FEB.2013 15:18:34

Chain 1: 802.11n40 Low Channel

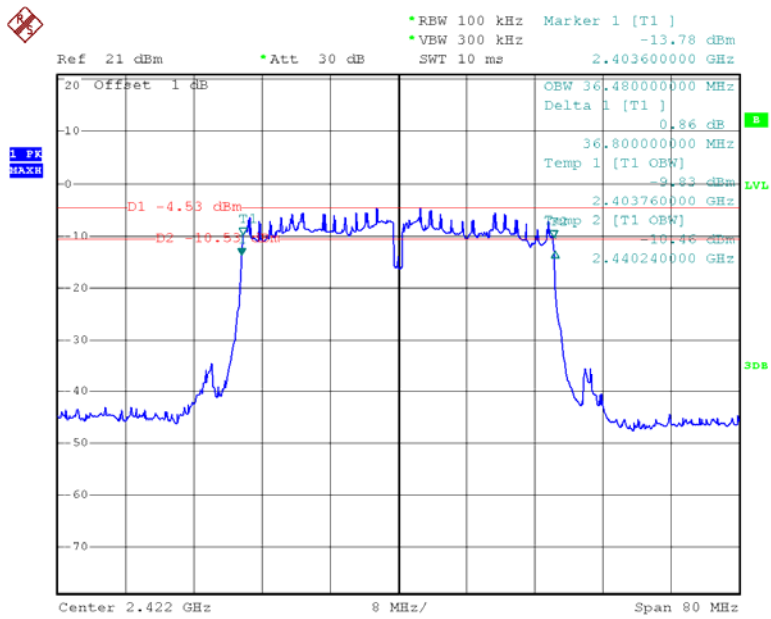

Date: 23.FEB.2013 14:58:28

Chain 1: 802.11n40 Middle Channel

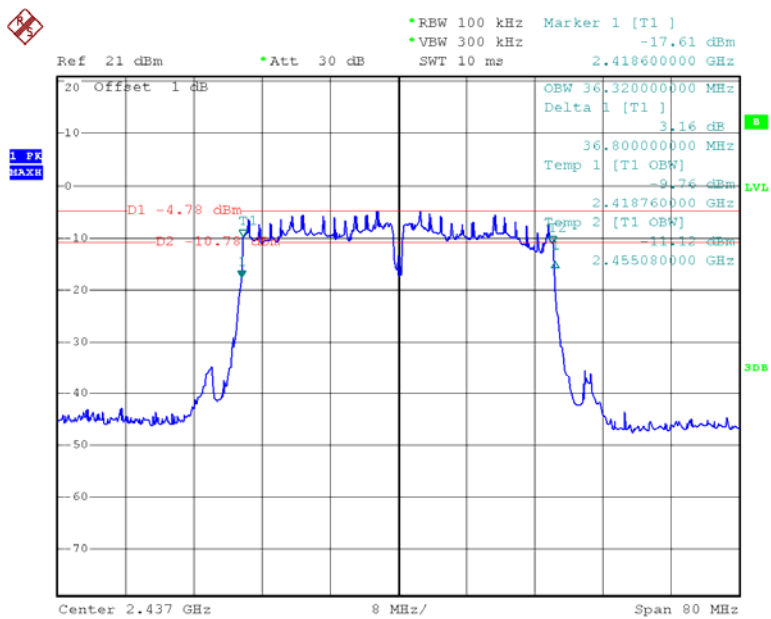

Date: 23.FEB.2013 15:10:20

Chain 1: 802.11n40 High Channel

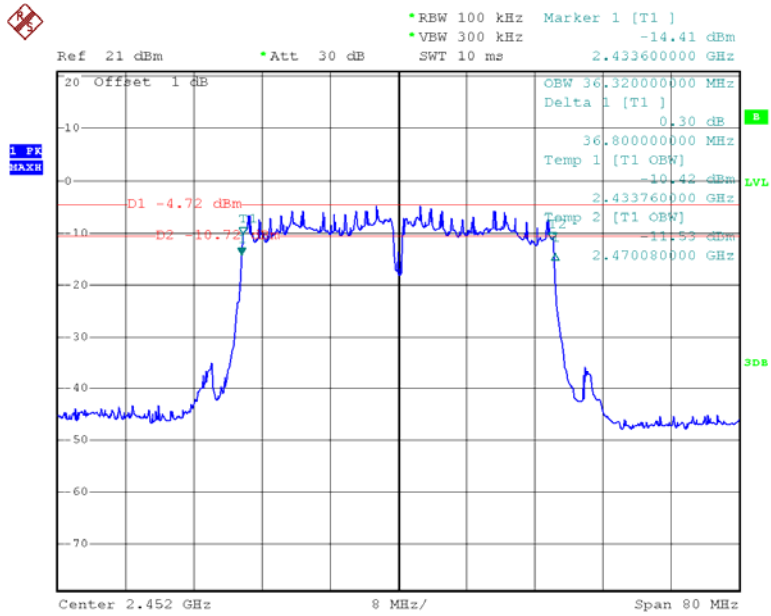

Date: 23.FEB.2013 15:19:15

Chain 2: 802.11n40 Low Channel

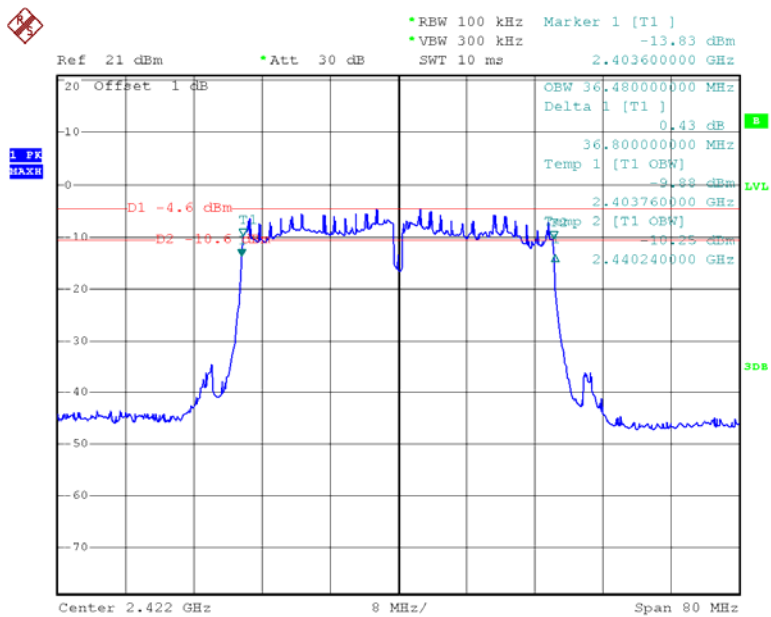

Date: 23.FEB.2013 14:59:17

Chain 2: 802.11n40 Middle Channel

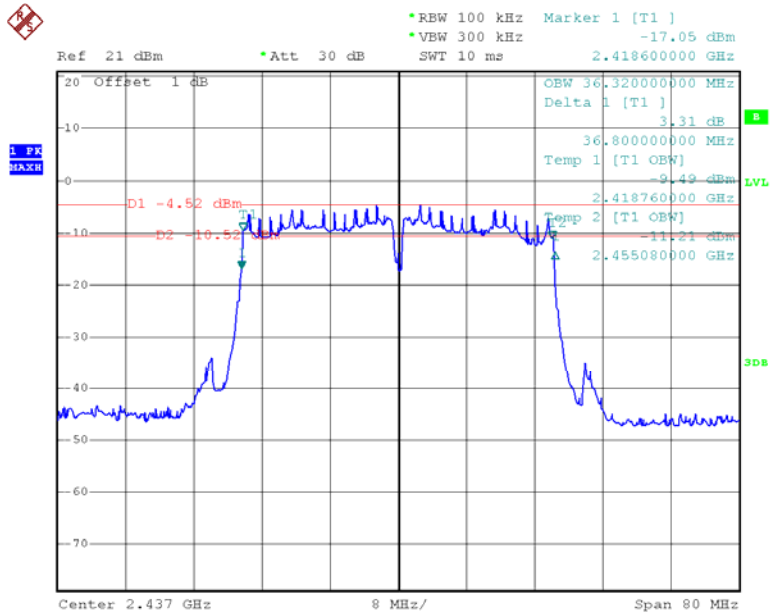

Date: 23.FEB.2013 15:11:02

Chain 2: 802.11n40 High Channel

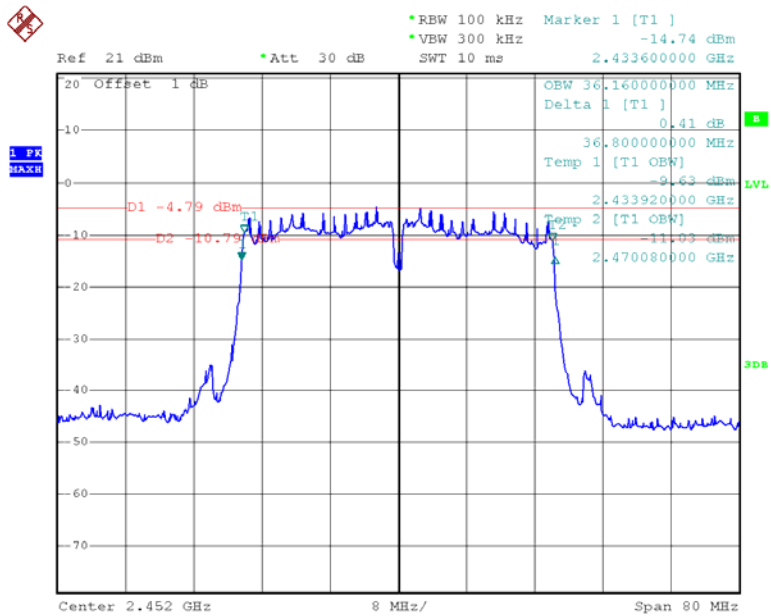

Date: 23.FEB.2013 15:20:01

FCC §15.247(b) (3) - MAXIMUM PEAK OUTPUT POWER

Applicable Standard

According to FCC §15.247(b) (3), for systems using digital modulation in the 902-928 MHz, 2400-2483.5 MHz, and 5725-5850 MHz bands: 1 Watt. As an alternative to a peak power measurement, compliance with the one Watt limit can be based on a measurement of the maximum conducted output power. Maximum Conducted Output Power is defined as the total transmit power delivered to all antennas and antenna elements averaged across all symbols in the signaling alphabet when the transmitter is operating at its maximum power control level. Power must be summed across all antennas and antenna elements. The average must not include any time intervals during which the transmitter is off or is transmitting at a reduced power level. If multiple modes of operation are possible (e.g., alternative modulation methods), the maximum conducted output power is the highest total transmit power occurring in any mode.

Test Procedure

1. Place the EUT on a bench and set it in transmitting mode.
2. Remove the antenna from the EUT and then connect a low loss RF cable from the antenna port to an EMI Test Receiver.
3. Add a correction factor to the display.

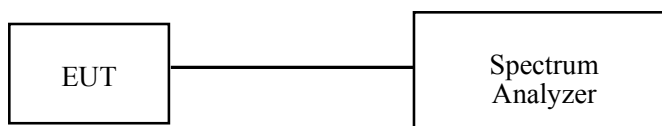

Test Equipment List and Details

Manufacturer	Description	Model	Serial Number	Calibration Date	Calibration Due Date
Rohde & Schwarz	Spectrum Analyzer	FSP38	100478	2012-5-14	2013-5-13

Test Data

Environmental Conditions

Temperature:	23.9° C
Relative Humidity:	48 %
ATM Pressure:	101.7kPa

The testing was performed by Leon Chen on 2013-03-13.

Test Mode: Transmitting

Channel	Frequency	Conducted Output Power	Limit	Result
	(MHz)	(dBm)	(dBm)	
802.11b mode				
Low	2412 MHz	21.51	30	PASS
Middle	2437 MHz	21.69	30	PASS
High	2462 MHz	21.84	30	PASS
802.11g mode				
Low	2412 MHz	17.53	30	PASS
Middle	2437 MHz	17.44	30	PASS
High	2462 MHz	17.47	30	PASS
chain 0: 802.11n20 mode				
Low	2412 MHz	12.22	30	PASS
Middle	2437 MHz	12.21	30	PASS
High	2462 MHz	12.36	30	PASS
chain 1: 802.11n20 mode				
Low	2412 MHz	12.01	30	PASS
Middle	2437 MHz	12.25	30	PASS
High	2462 MHz	12.29	30	PASS
chain 2: 802.11n20 mode				
Low	2412 MHz	12.06	30	PASS
Middle	2437 MHz	12.33	30	PASS
High	2462 MHz	12.23	30	PASS
chain 0+1+2: 802.11n20 mode				
Low	2412 MHz	16.87	30	PASS
Middle	2437 MHz	17.04	30	PASS
High	2462 MHz	17.07	30	PASS
chain 0: 802.11n40 mode				
Low	2422 MHz	12.26	30	PASS
Middle	2437 MHz	12.35	30	PASS
High	2452 MHz	12.53	30	PASS
chain 1: 802.11n40 mode				
Low	2422 MHz	12.33	30	PASS
Middle	2437 MHz	12.42	30	PASS
High	2452 MHz	12.52	30	PASS

chain 2: 802.11n40 mode				
Low	2422 MHz	12.34	30	PASS
Middle	2437 MHz	12.35	30	PASS
High	2452 MHz	12.55	30	PASS
chain 0+1+2: 802.11n40 mode				
Low	2422 MHz	17.08	30	PASS
Middle	2437 MHz	17.14	30	PASS
High	2452 MHz	17.30	30	PASS

Please refer to the following plots

802.11b RF Output Power, Low Channel

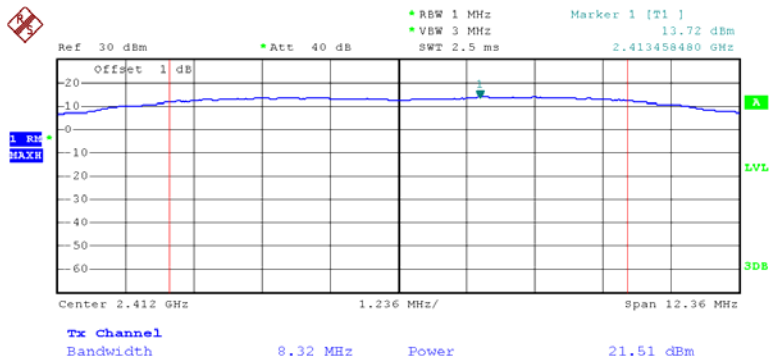

Date: 13.MAR.2013 17:19:50

802.11b RF Output Power, Middle Channel

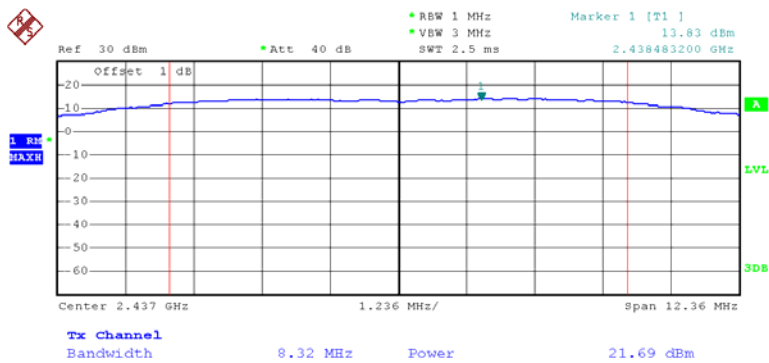

Date: 13.MAR.2013 17:20:15

802.11b RF Output Power, High Channel

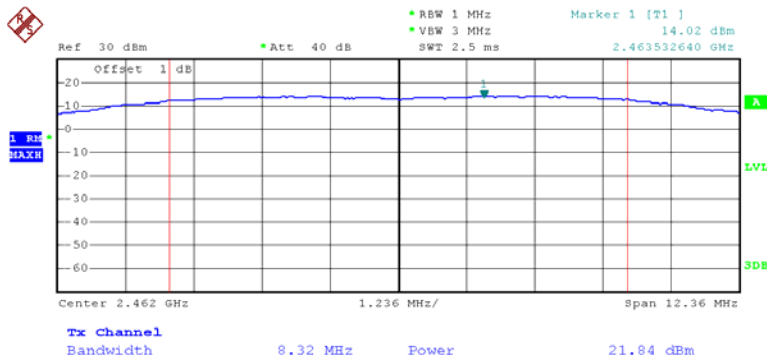

Date: 13.MAR.2013 17:20:44

802.11g RF Output Power, Low Channel

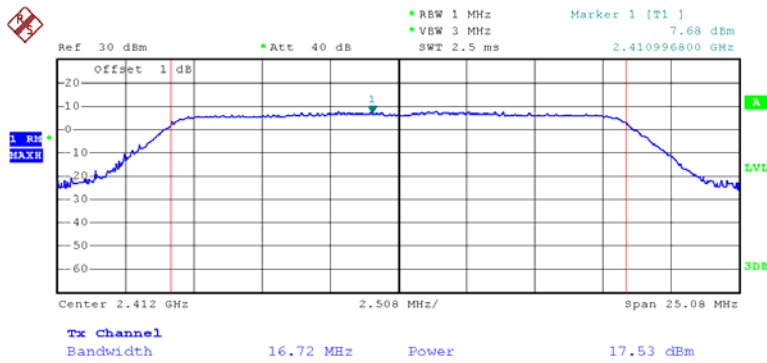

Date: 13.MAR.2013 17:23:52

802.11g RF Output Power, Middle Channel

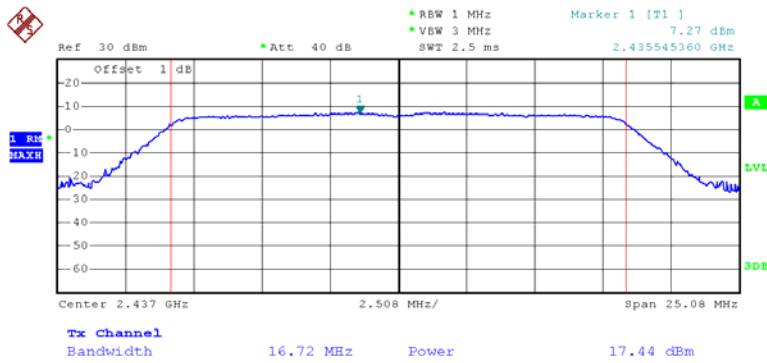

Date: 13.MAR.2013 17:24:10

802.11g RF Output Power, High Channel

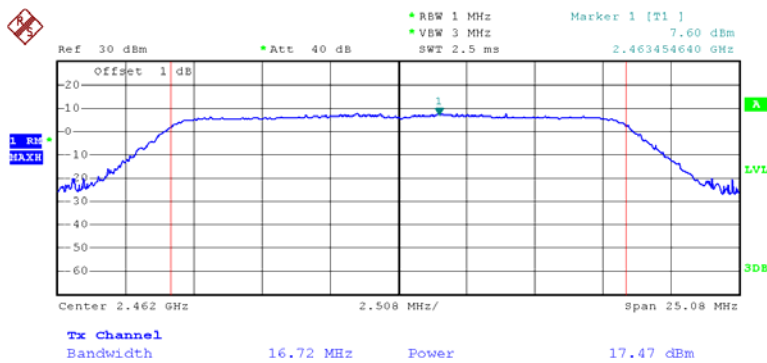

Date: 13.MAR.2013 17:24:35

Chain 0: 802.11n20 RF Output Power, Low Channel

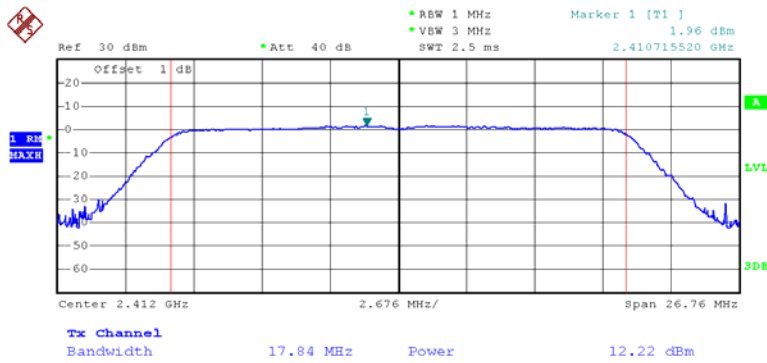

Date: 13.MAR.2013 17:26:51

Chain 0: 802.11n20 RF Output Power, Middle Channel

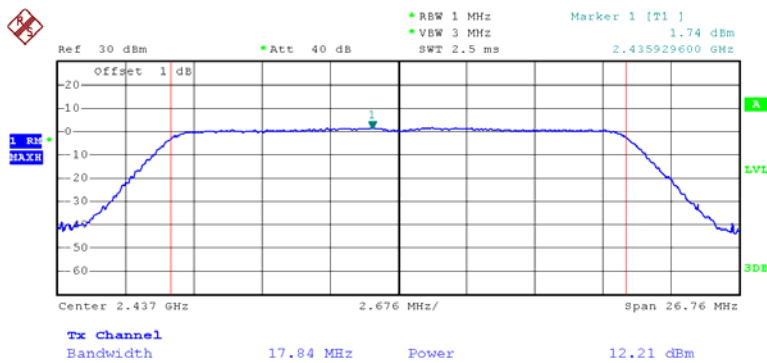

Date: 13.MAR.2013 17:30:04

Chain 0: 802.11n20 RF Output Power, High Channel

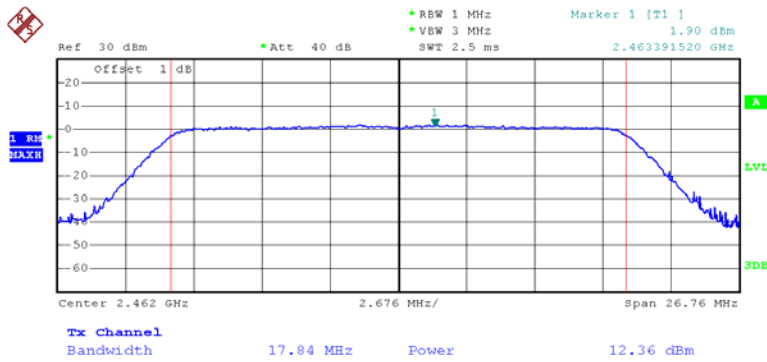

Date: 13.MAR.2013 17:30:21

Chain 1: 802.11n20 RF Output Power, Low Channel

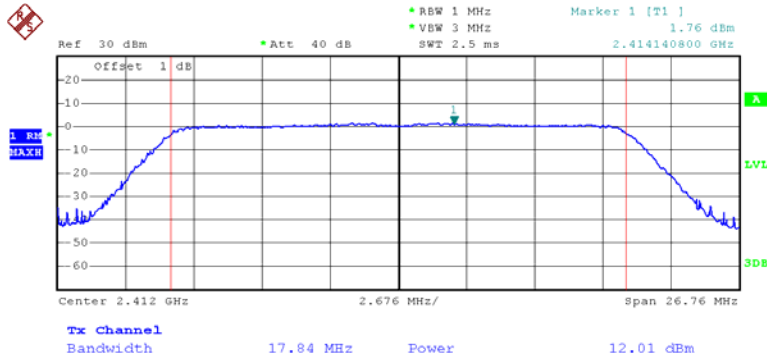

Date: 13.MAR.2013 17:26:59

Chain 1: 802.11n20 RF Output Power, Middle Channel

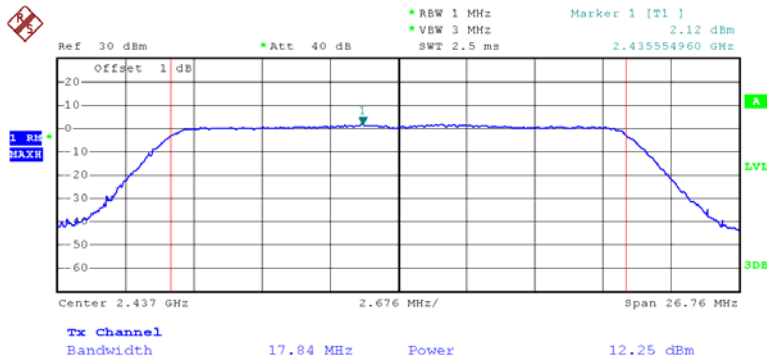

Date: 13.MAR.2013 17:29:48

Chain 1: 802.11n20 RF Output Power, High Channel

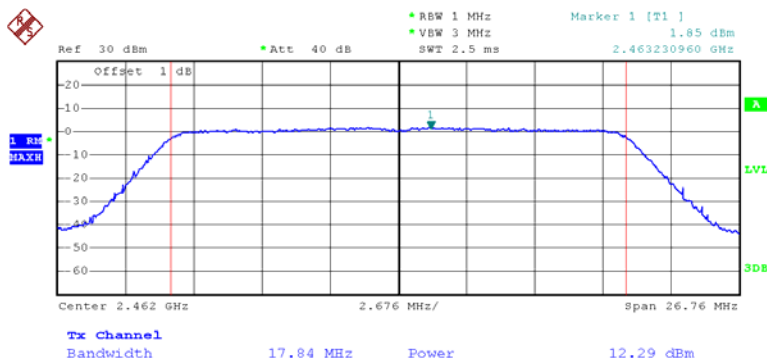

Date: 13.MAR.2013 17:30:26

Chain 2: 802.11n20 RF Output Power, Low Channel

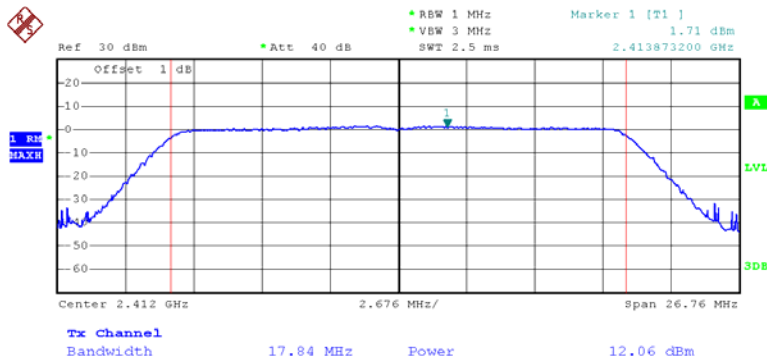

Date: 13.MAR.2013 17:27:08

Chain 2: 802.11n20 RF Output Power, Middle Channel

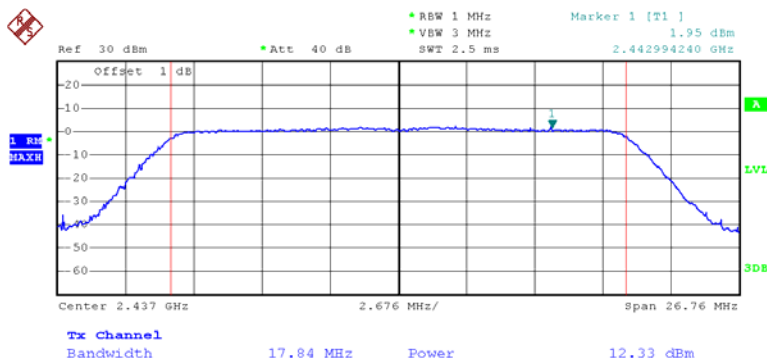

Date: 13.MAR.2013 17:29:57

Chain 2: 802.11n20 RF Output Power, High Channel

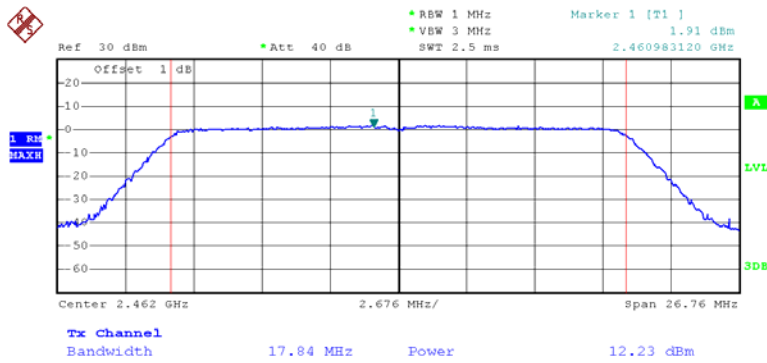

Date: 13.MAR.2013 17:30:31

Chain 0: 802.11n40 RF Output Power, Low Channel

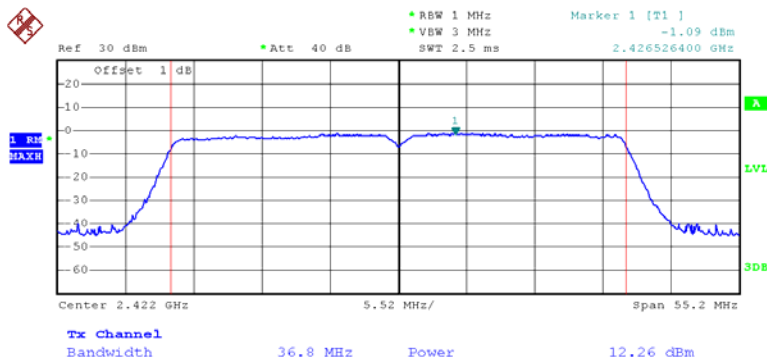

Date: 13.MAR.2013 17:32:29

Chain 0: 802.11n40 RF Output Power, Middle Channel

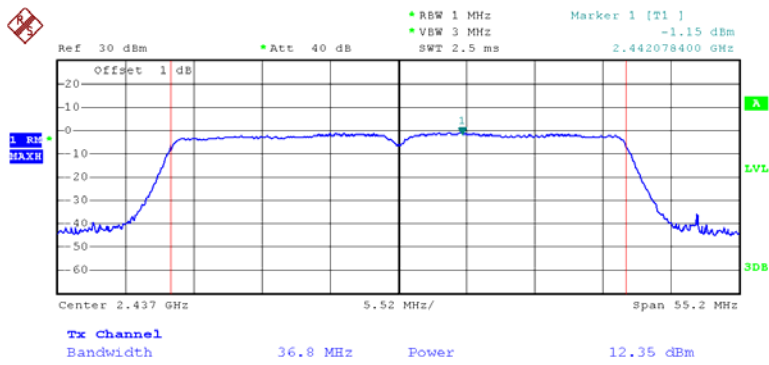

Date: 13.MAR.2013 17:33:13

Chain 0: 802.11n40 RF Output Power, High Channel

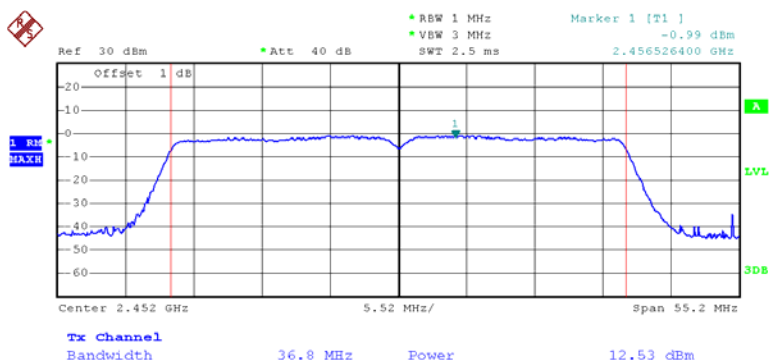

Date: 13.MAR.2013 17:33:55

Chain 1: 802.11n40 RF Output Power, Low Channel

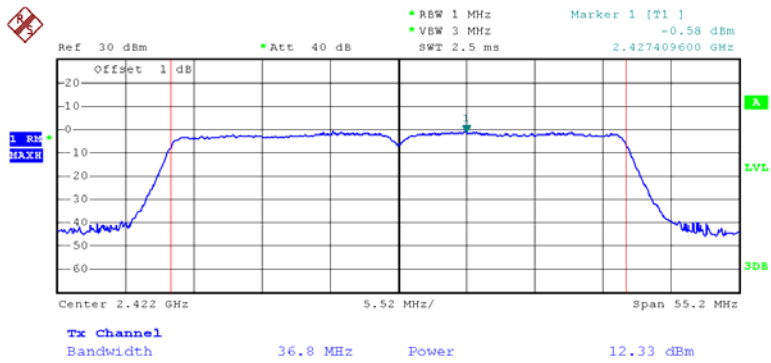

Date: 13.MAR.2013 17:32:13

Chain 1: 802.11n40 RF Output Power, Middle Channel

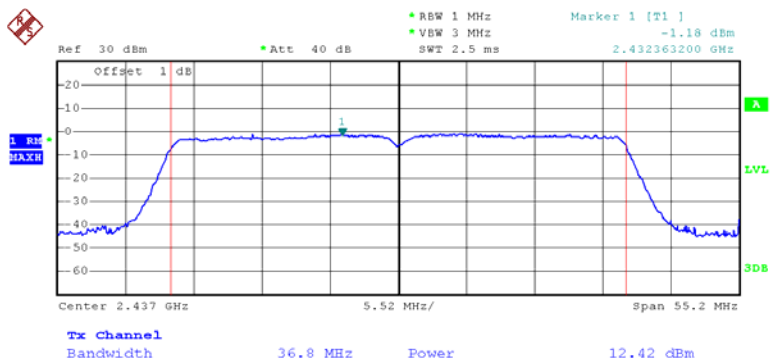

Date: 13.MAR.2013 17:32:53

Chain 1: 802.11n40 RF Output Power, High Channel

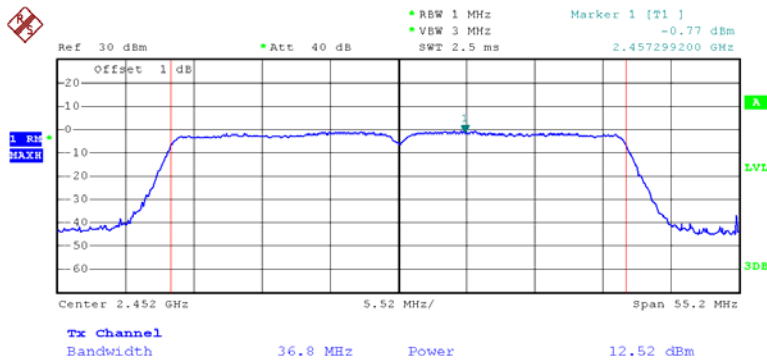

Date: 13.MAR.2013 17:33:34

Chain 2: 802.11n40 RF Output Power, Low Channel

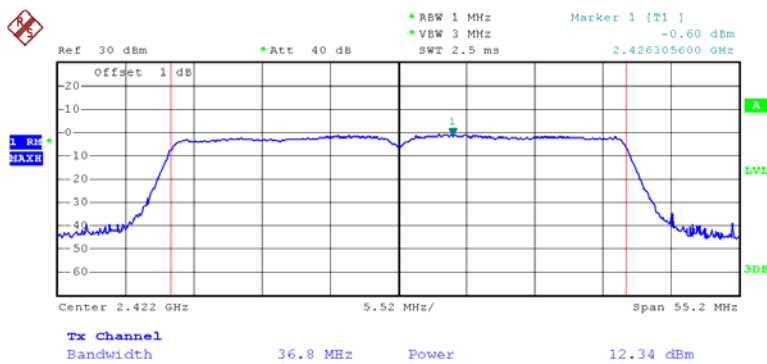

Date: 13.MAR.2013 17:32:21

Chain 2: 802.11n40 RF Output Power, Middle Channel

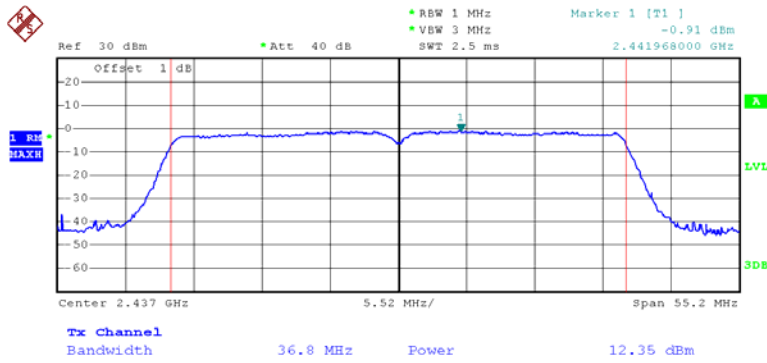

Date: 13.MAR.2013 17:33:02

Chain 2: 802.11n40 RF Output Power, High Channel

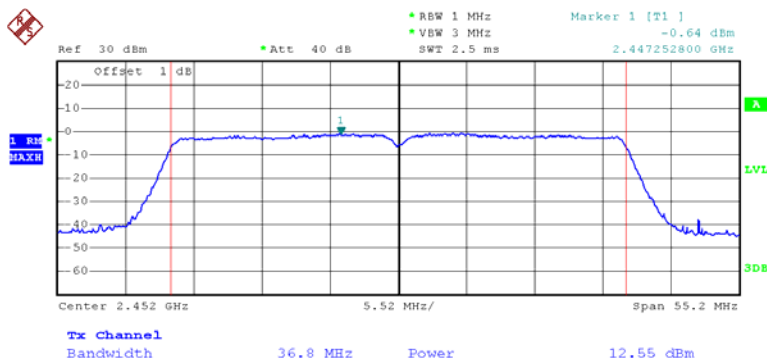

Date: 13.MAR.2013 17:33:45

FCC §15.247(d) – 100 kHz BANDWIDTH OF FREQUENCY BAND EDGE

Applicable Standard

In any 100 kHz bandwidth outside the frequency band in which the spread spectrum or digitally modulated intentional radiator is operating, the radio frequency power that is produced by the intentional radiator shall be at least 20 dB below that in the 100 kHz bandwidth within the band that contains the highest level of the desired power, based on either an RF conducted or a radiated measurement, provided the transmitter demonstrates compliance with the peak conducted power limits. If the transmitter complies with the conducted power limits based on the use of RMS averaging over a time interval, as permitted under paragraph (b)(3) of this section, the attenuation required under this paragraph shall be 30 dB instead of 20 dB. Attenuation below the general limits specified in §15.209(a) is not required. In addition, radiated emissions which fall in the restricted bands, as defined in §15.205(a), must also comply with the radiated emission limits specified in §15.209(a) (see §15.205(c)).

Test Procedure

1. Check the calibration of the measuring instrument using either an internal calibrator or a known signal from an external generator.
2. Position the EUT without connection to measurement instrument. Turn on the EUT and connect its antenna terminal to measurement instrument via a low loss cable. Then set it to any one measured frequency within its operating range, and make sure the instrument is operated in its linear range.
3. Set RBW to 100 kHz and VBW of spectrum analyzer to 300 kHz with a convenient frequency span including 100 kHz bandwidth from band edge.
4. Measure the highest amplitude appearing on spectral display and set it as a reference level. Plot the graph with marking the highest point and edge frequency.
5. Repeat above procedures until all measured frequencies were complete.

Test Equipment List and Details

Manufacturer	Description	Model	Serial Number	Calibration Date	Calibration Due Date
Rohde & Schwarz	Spectrum Analyzer	FSP38	100478	2012-5-14	2013-5-13

Test Data

Environmental Conditions

Temperature:	24.9 °C~25 °C
Relative Humidity:	60 %~65 %
ATM Pressure:	100.8kPa~101.1kPa

The testing was performed by Leon Chen from 2013-02-06 to 2013-02-07.

Test Result: *Compliance*

Test mode: *Transmitting*

Please refer to following table and plots.

Band edge	Delta Peak to Band Emission (dBc)	Limit (dBc)	Result
802.11b			
Left	45.95	20	PASS
Right	54.58	20	PASS
802.11g			
Left	24.25	20	PASS
Right	45.34	20	PASS
802.11n20 Chain 0			
Left	26.50	20	PASS
Right	40.56	20	PASS
802.11n20 Chain 1			
Left	24.63	20	PASS
Right	42.02	20	PASS
802.11n20 Chain 2			
Left	24.03	20	PASS
Right	40.87	20	PASS
802.11n40 Chain 0			
Left	41.16	20	PASS
Right	41.92	20	PASS
802.11n40 Chain 1			
Left	32.02	20	PASS
Right	38.25	20	PASS
802.11n40 Chain 2			
Left	31.41	20	PASS
Right	38.92	20	PASS

802.11b: Band Edge, Left Side

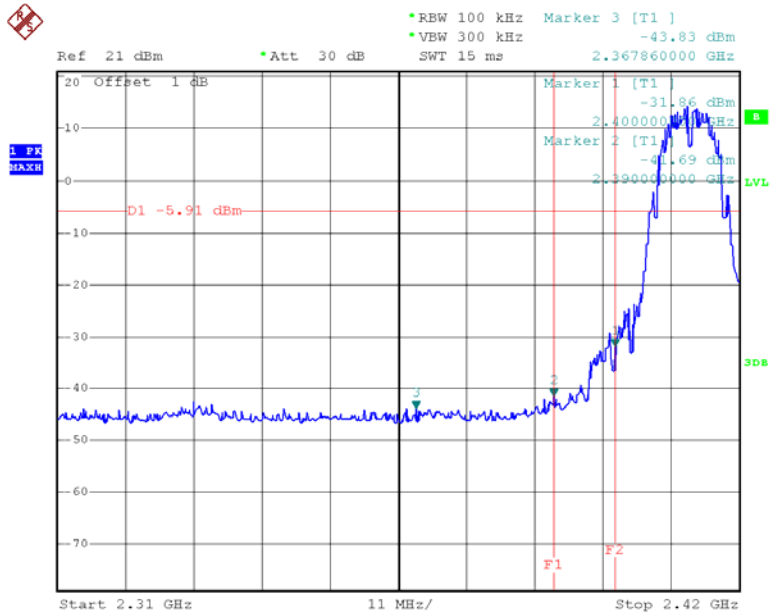

Date: 23.FEB.2013 13:30:58

802.11b: Band Edge, Right Side



Date: 23.FEB.2013 13:36:08

802.11g: Band Edge, Left Side

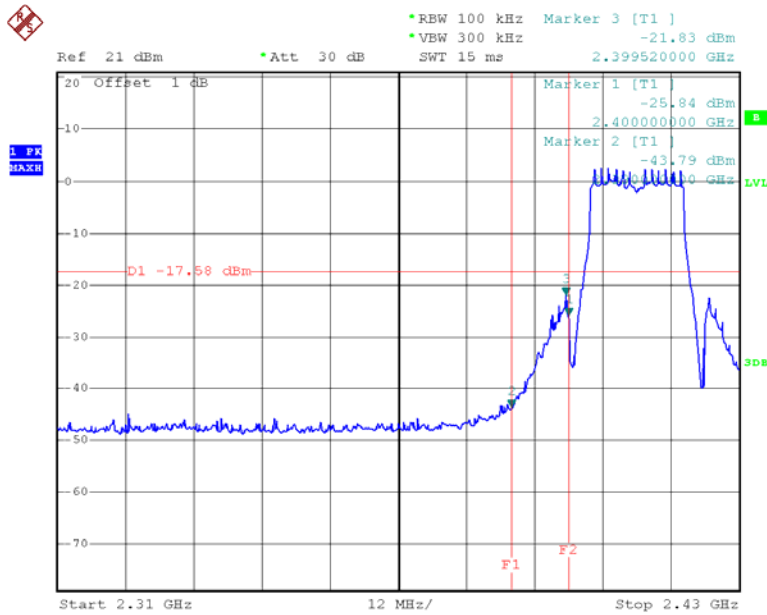

Date: 23.FEB.2013 13:45:25

802.11g: Band Edge, Right Side

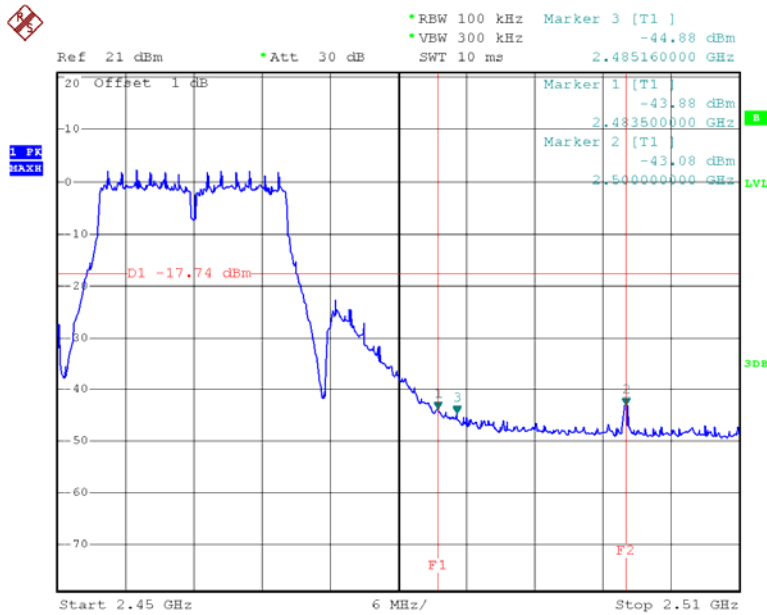

Date: 23.FEB.2013 13:56:16

Chain 0: 802.11n20 Band Edge, Left Side

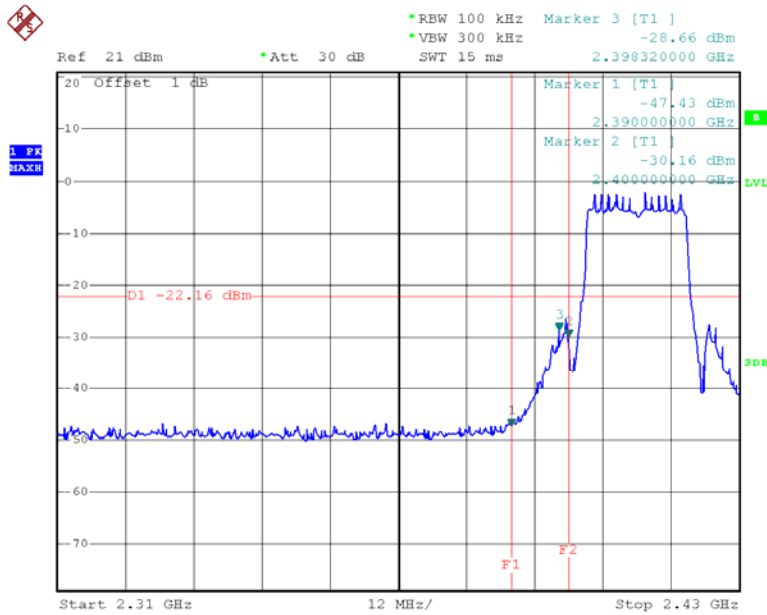

Date: 23.FEB.2013 14:22:00

Chain 0: 802.11n20 Band Edge, Right Side

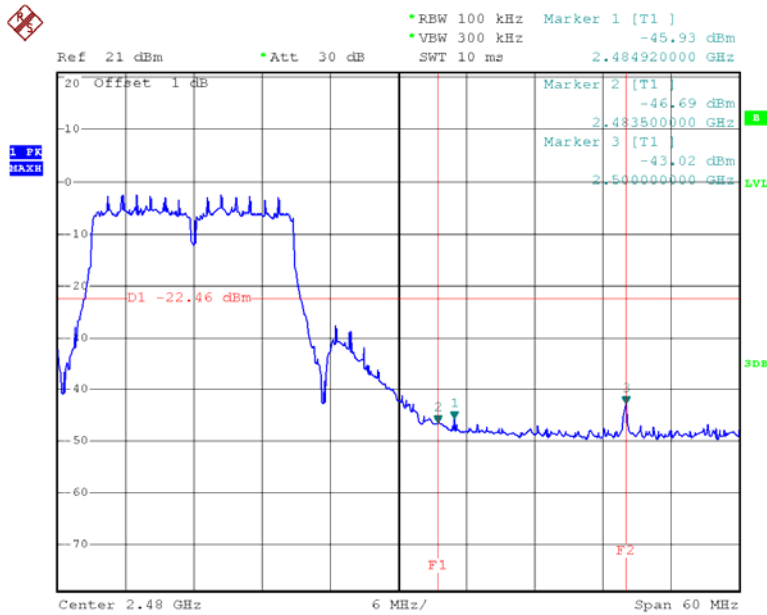

Date: 23.FEB.2013 14:53:10

Chain 1: 802.11n20 Band Edge, Left Side

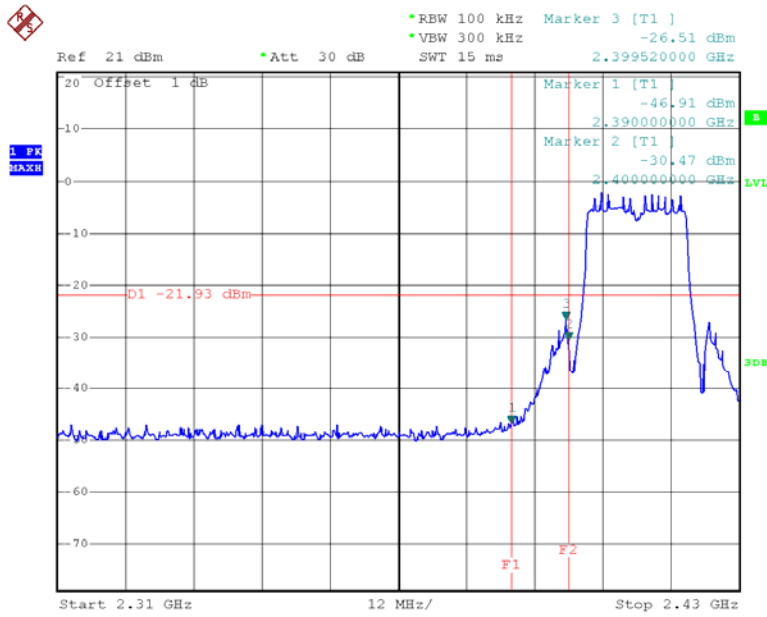

Date: 23.FEB.2013 14:21:08

Chain 1: 802.11n20 Band Edge, Right Side

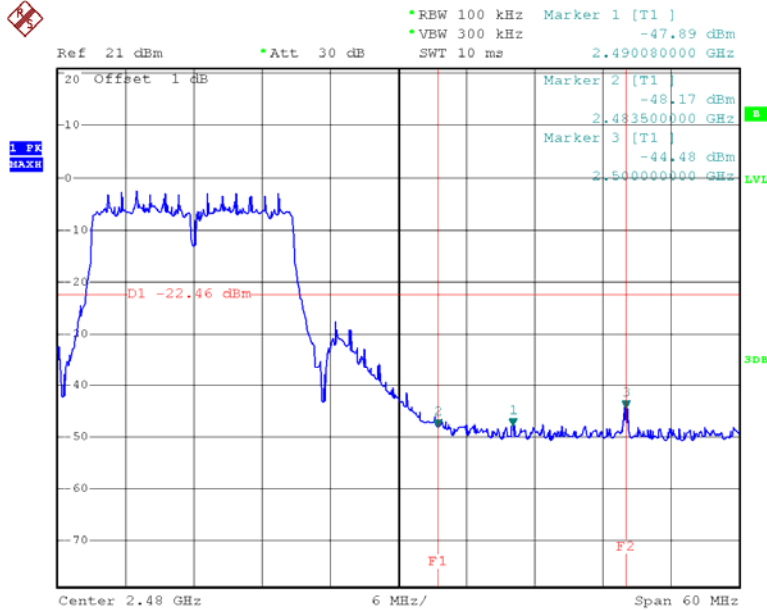

Date: 23.FEB.2013 14:53:25

Chain 2: 802.11n20 Band Edge, Left Side

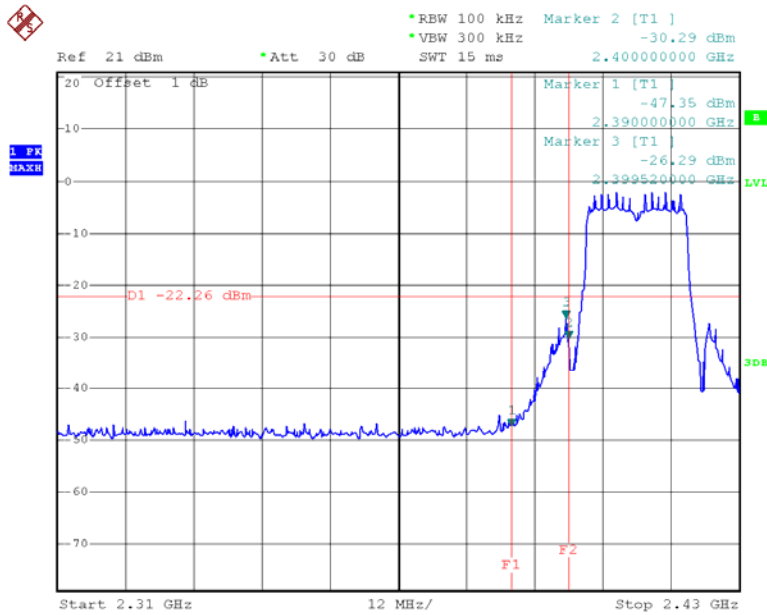

Date: 23.FEB.2013 14:20:28

Chain 2: 802.11n20 Band Edge, Right Side

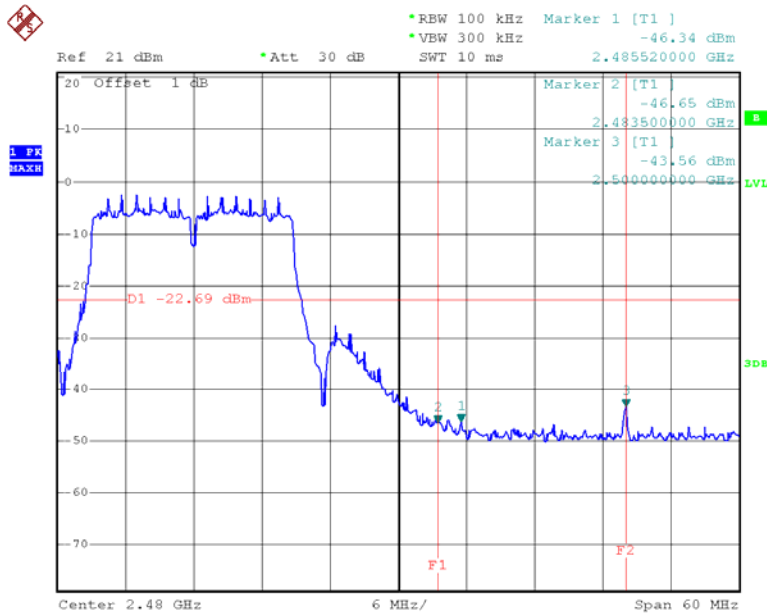

Date: 23.FEB.2013 14:53:40

Chain 0: 802.11n40 Band Edge, Left Side

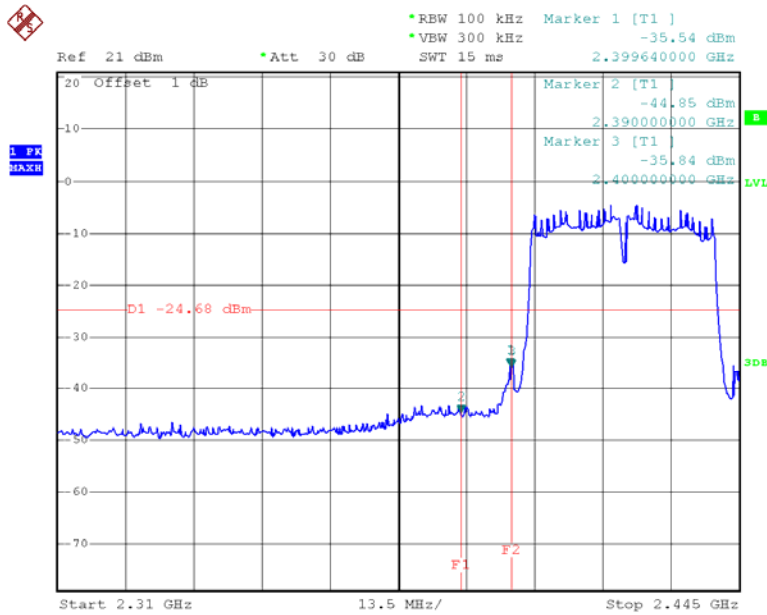

Date: 23.FEB.2013 15:07:19

Chain 0: 802.11n40 Band Edge, Right Side

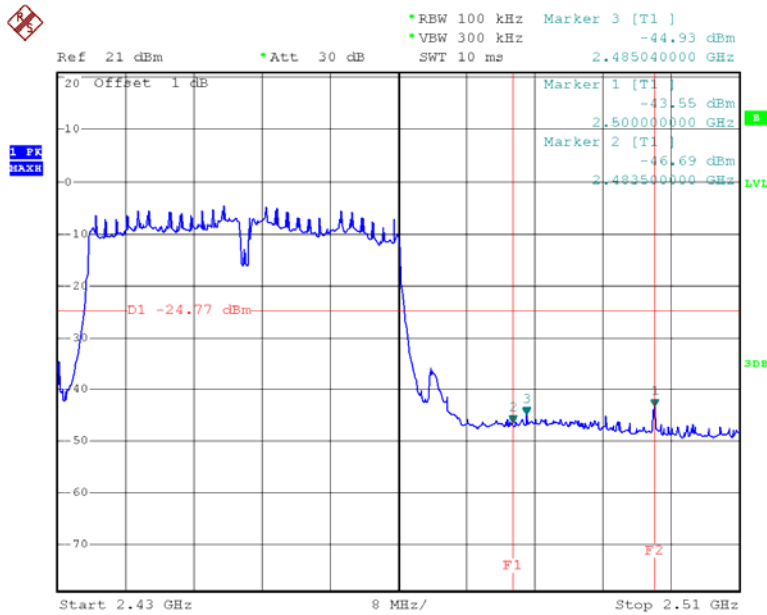

Date: 23.FEB.2013 15:27:02

Chain 1: 802.11n40 Band Edge, Left Side

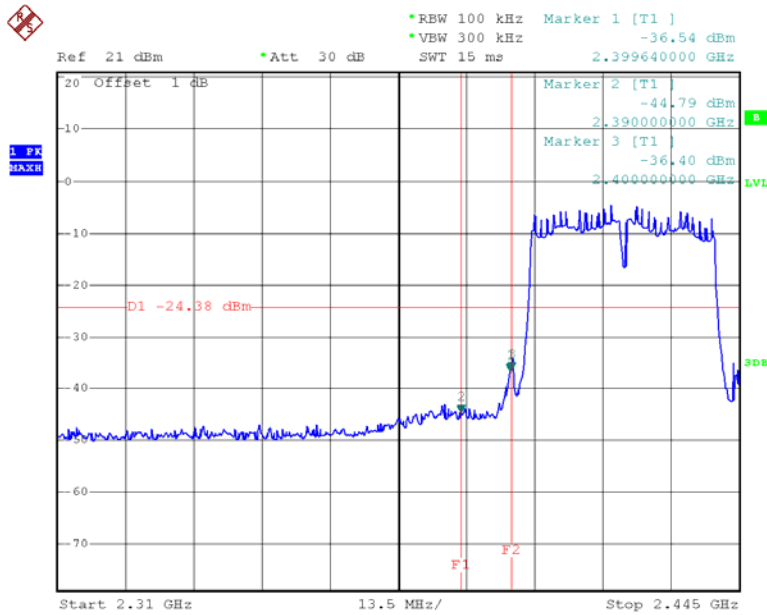

Date: 23.FEB.2013 15:07:48

Chain 1: 802.11n40 Band Edge, Right Side

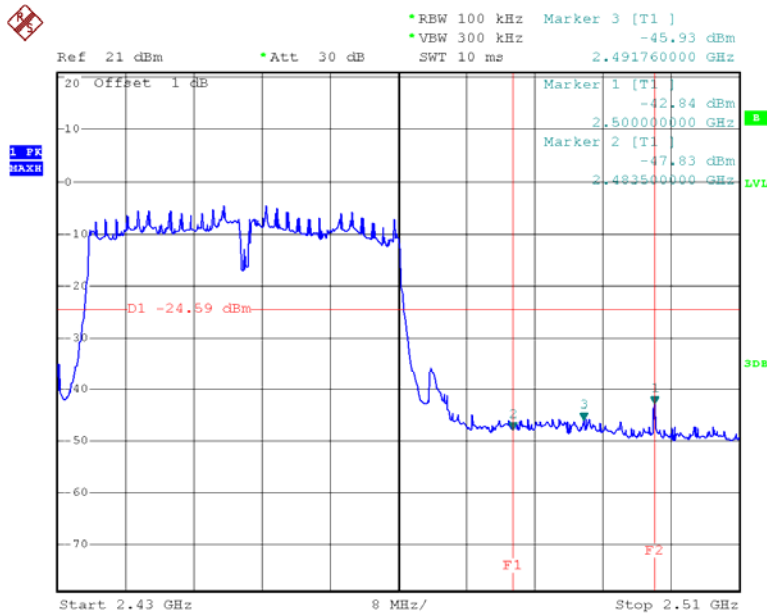

Date: 23.FEB.2013 15:27:25

Chain 2: 802.11n40 Band Edge, Left Side

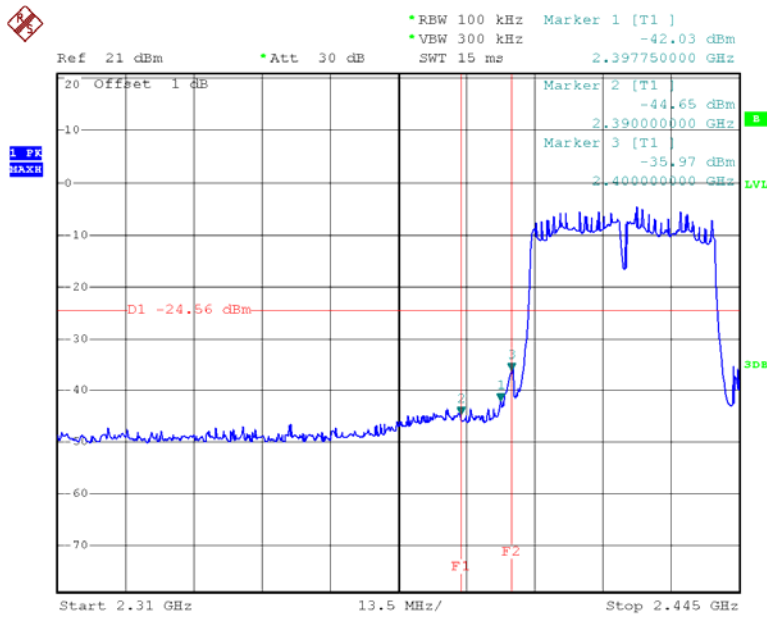

Date: 23.FEB.2013 15:08:17

Chain 2: 802.11n40 Band Edge, Right Side

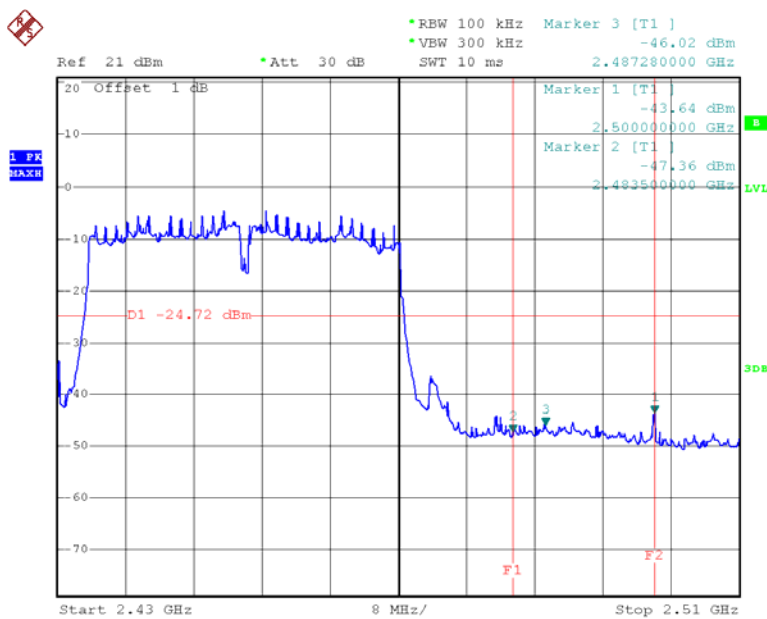

Date: 23.FEB.2013 15:27:53

FCC §15.247(e) - POWER SPECTRAL DENSITY

Applicable Standard

For digitally modulated systems, the power spectral density conducted from the intentional radiator to the antenna shall not be greater than 8 dBm in any 3 kHz band during any time interval of continuous transmission. This power spectral density shall be determined in accordance with the provisions of paragraph (b) of this section. The same method of determining the conducted output power shall be used to determine the power spectral density.

Test Procedure

1. Check the calibration of the measuring instrument using either an internal calibrator or a known signal from an external generator.
2. Position the EUT was set without connection to measurement instrument. Turn on the EUT and connect its antenna terminal to measurement instrument via a low loss cable. Then set it to any one measured frequency within its operating range, and make sure the instrument is operated in its linear range.
3. According to KDB 558074 D01 DTS Meas Guidance v02, set the RBW = 3 kHz, VBW = 30 kHz, Set the span to 1.5 times the DTS channel bandwidth.
4. Use the peak marker function to determine the maximum power level in any 3 kHz band segment within the fundamental EBW.

Test Equipment List and Details

Manufacturer	Description	Model	Serial Number	Calibration Date	Calibration Due Date
Rohde & Schwarz	Spectrum Analyzer	FSP38	100478	2012-5-14	2013-5-13

Test Data

Environmental Conditions

Temperature:	23.9° C
Relative Humidity:	48 %
ATM Pressure:	101.7kPa

The testing was performed by Leon Chen on 2013-02-23.

Test Mode: Transmitting

Test Result: Pass

Channel	PSD	Limit	Result
	(dBm/3kHz)	(dBm/3kHz)	
802.11b mode			
Low	-0.17	8	PASS
Middle	1.73	8	PASS
High	0.53	8	PASS
802.11g mode			
Low	-10.92	8	PASS
Middle	-11.05	8	PASS
High	-11.77	8	PASS
chain 0: 802.11n20 mode			
Low	-16.07	8	PASS
Middle	-15.16	8	PASS
High	-15.71	8	PASS
chain 1: 802.11n20 mode			
Low	-16.25	8	PASS
Middle	-16.27	8	PASS
High	-17.22	8	PASS
chain 2: 802.11n20 mode			
Low	-16.23	8	PASS
Middle	-15.68	8	PASS
High	-15.97	8	PASS
chain 0+1+2: 802.11n20 mode			
Low	-11.41	8	PASS
Middle	-10.91	8	PASS
High	-11.48	8	PASS
chain 0: 802.11n40 mode			
Low	-19.20	8	PASS
Middle	-18.97	8	PASS
High	-16.91	8	PASS
chain 1: 802.11n40 mode			
Low	-18.67	8	PASS
Middle	-18.99	8	PASS
High	-19.32	8	PASS
chain 2: 802.11n40 mode			
Low	-17.79	8	PASS
Middle	-19.16	8	PASS
High	-18.54	8	PASS
chain 0+1+2: 802.11n40 mode			
Low	-13.74	8	PASS
Middle	-14.27	8	PASS
High	-13.37	8	PASS

Please refer to the following plots

Power Spectral Density, 802.11b Low Channel

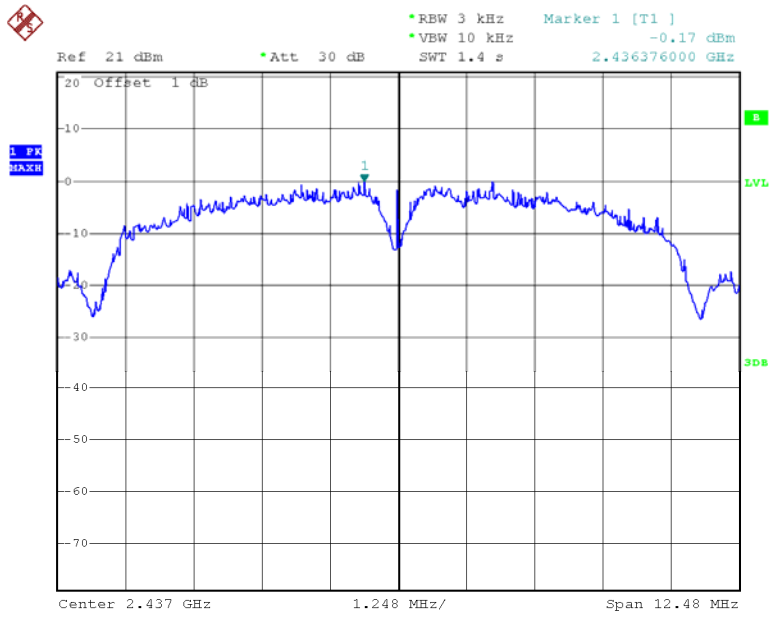

Date: 23.FEB.2013 13:09:17

Power Spectral Density, 802.11b Middle Channel

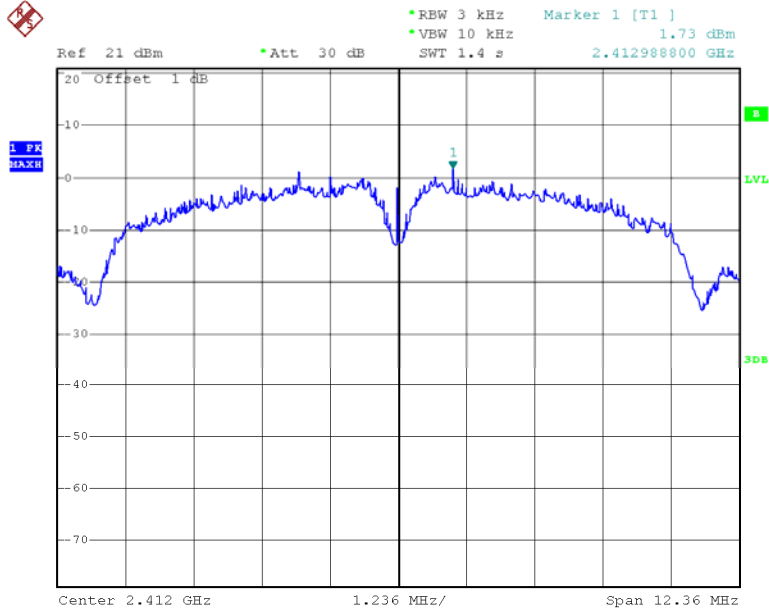

Date: 23.FEB.2013 13:29:04

Power Spectral Density, 802.11b High Channel

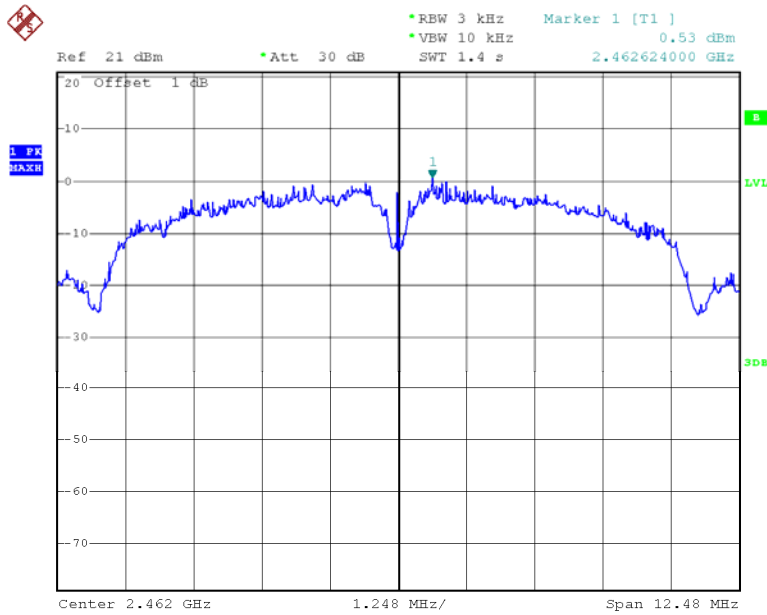

Date: 23.FEB.2013 13:33:53

Power Spectral Density, 802.11g Low Channel

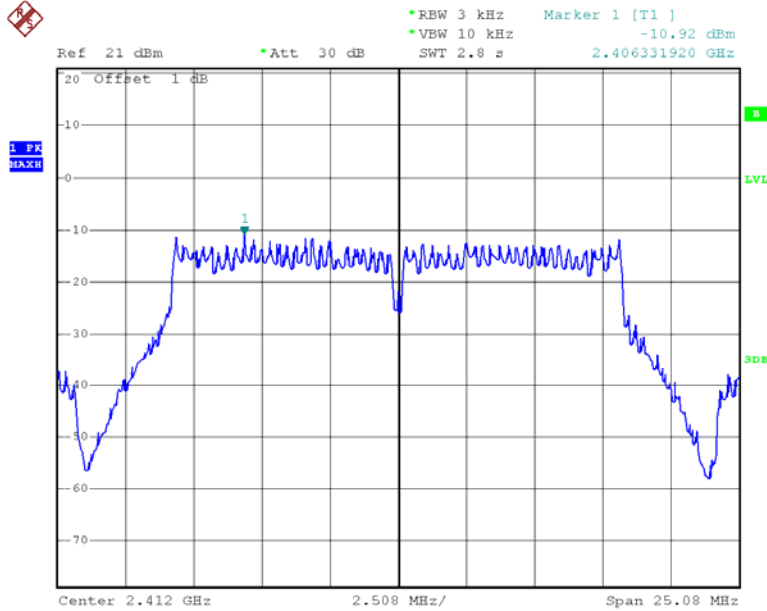

Date: 23.FEB.2013 13:42:27

Power Spectral Density, 802.11g Middle Channel

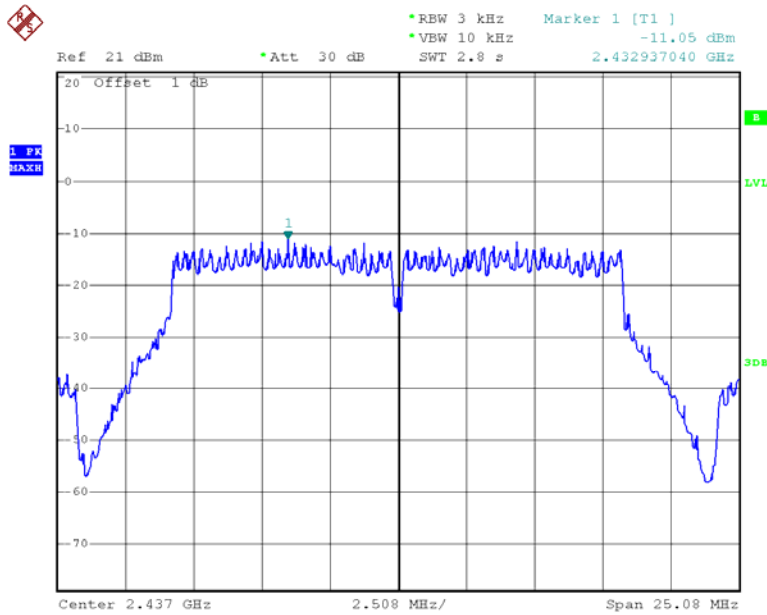

Date: 23.FEB.2013 13:48:52

Power Spectral Density, 802.11g High Channel

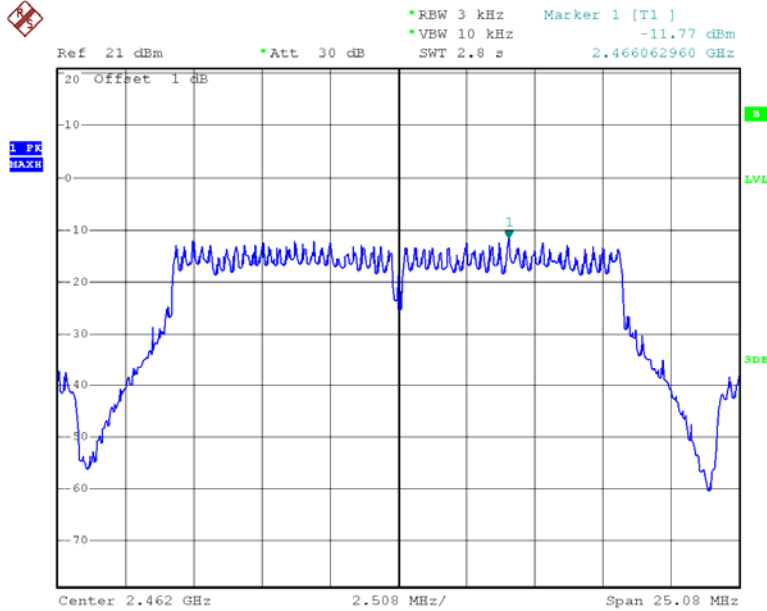

Date: 23.FEB.2013 13:53:57

Chain 0: Power Spectral Density, 802.11n20 Low Channel

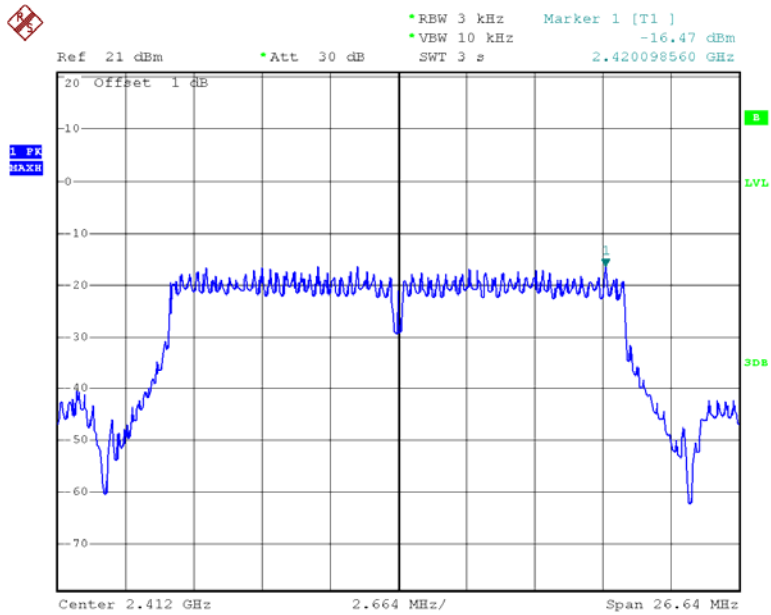

Date: 23.FEB.2013 14:12:01

Chain 0: Power Spectral Density, 802.11n20 Middle Channel

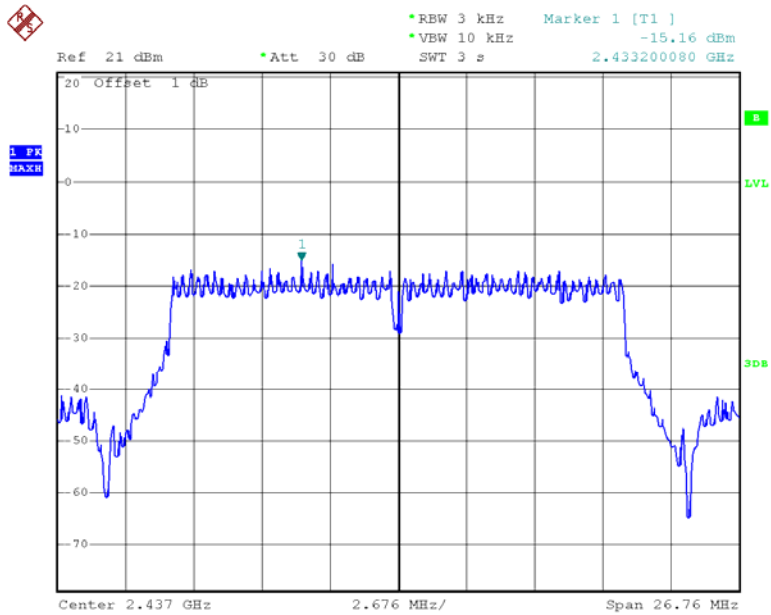

Date: 23.FEB.2013 14:33:24

Chain 1: Power Spectral Density, 802.11n20 Middle Channel

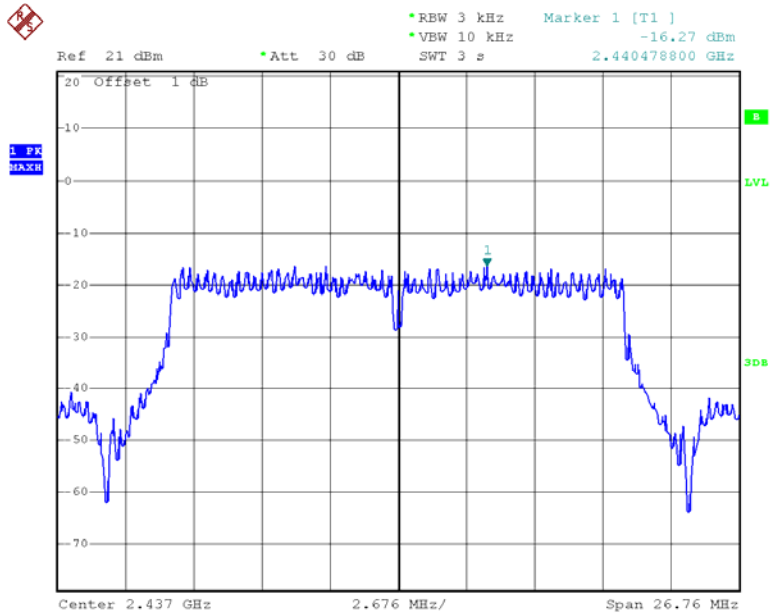

Date: 23.FEB.2013 14:34:18

Chain 1: Power Spectral Density, 802.11n20 High Channel

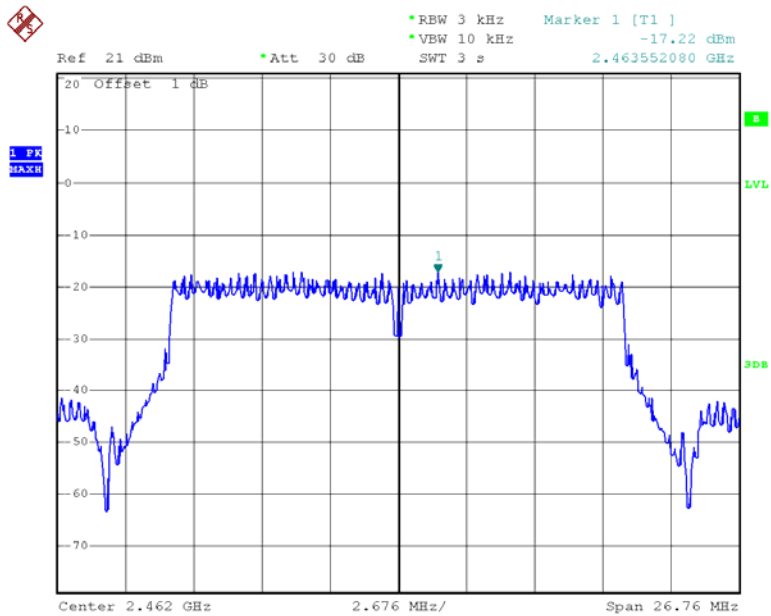

Date: 23.FEB.2013 14:48:12

Chain 2: Power Spectral Density, 802.11n20 Low Channel

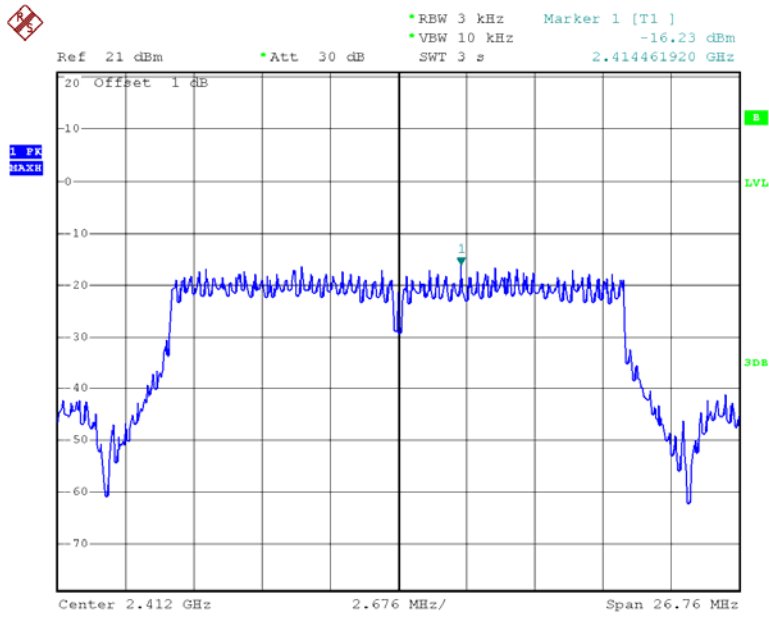

Date: 23.FEB.2013 14:13:05

Chain 2: Power Spectral Density, 802.11n20 Middle Channel

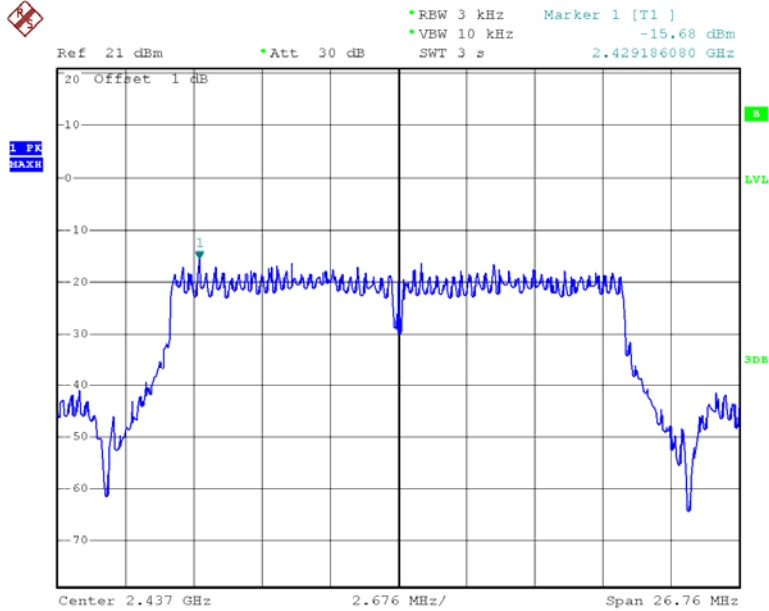

Date: 23.FEB.2013 14:34:47

Chain 2: Power Spectral Density, 802.11n20 High Channel

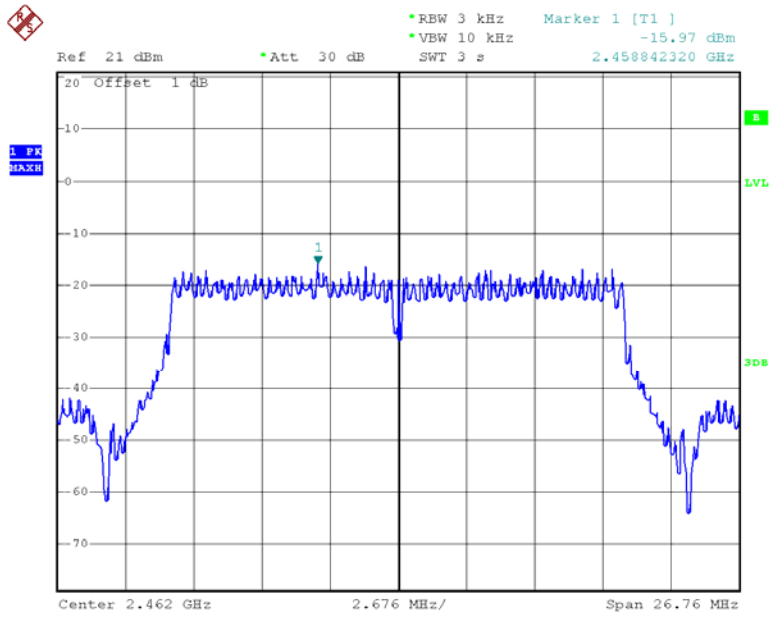

Date: 23.FEB.2013 14:48:39

Chain 0: Power Spectral Density, 802.11n40 Low Channel

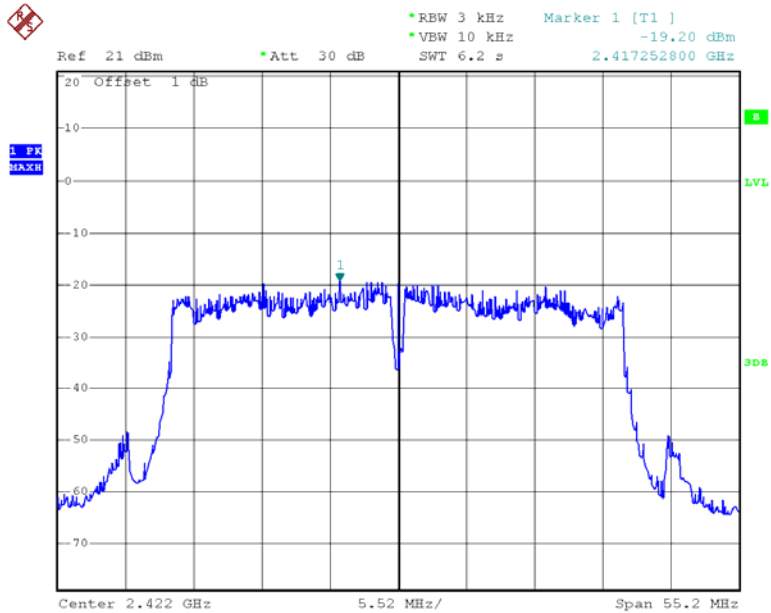

Date: 23.FEB.2013 15:01:28

Chain 0: Power Spectral Density, 802.11n40 Middle Channel

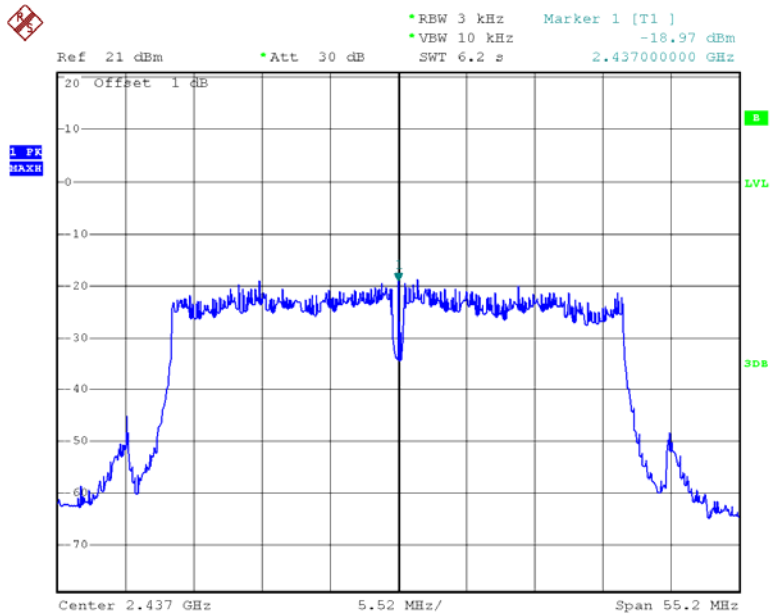

Date: 23.FEB.2013 15:13:57

Chain 0: Power Spectral Density, 802.11n40 High Channel

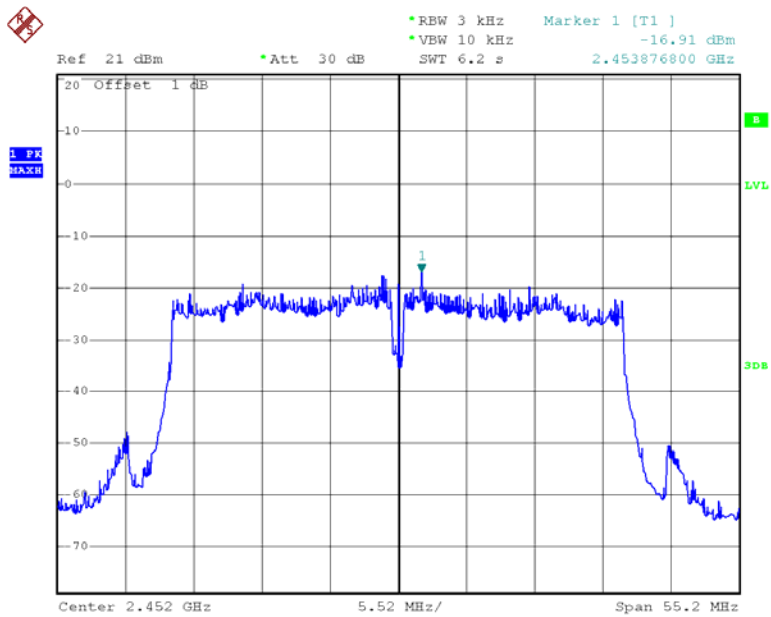

Date: 23.FEB.2013 15:22:28

Chain 1: Power Spectral Density, 802.11n40 Low Channel

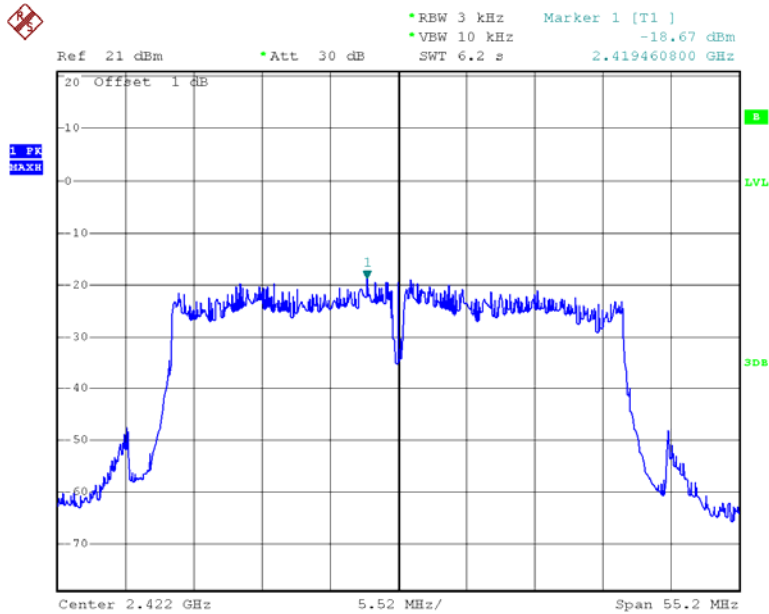

Date: 23.FEB.2013 15:01:58

Chain 1: Power Spectral Density, 802.11n40 Middle Channel

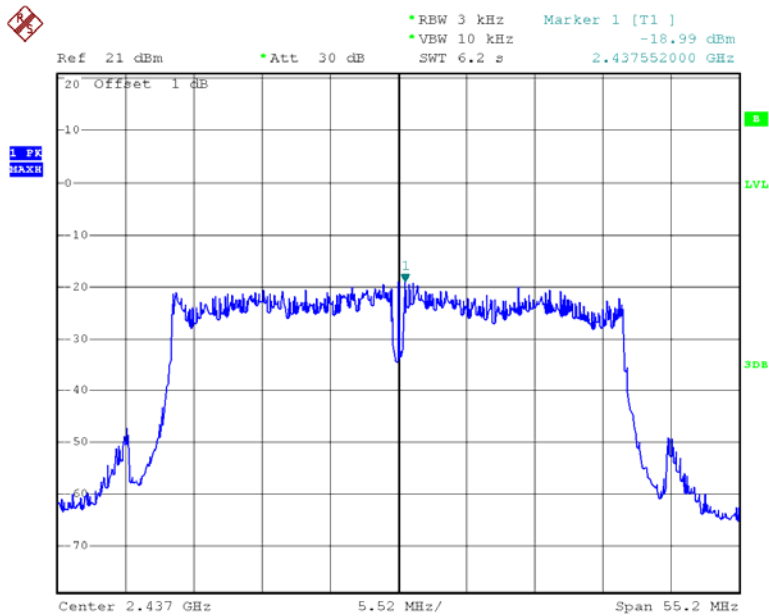

Date: 23.FEB.2013 15:14:29

Chain 1: Power Spectral Density, 802.11n40 High Channel

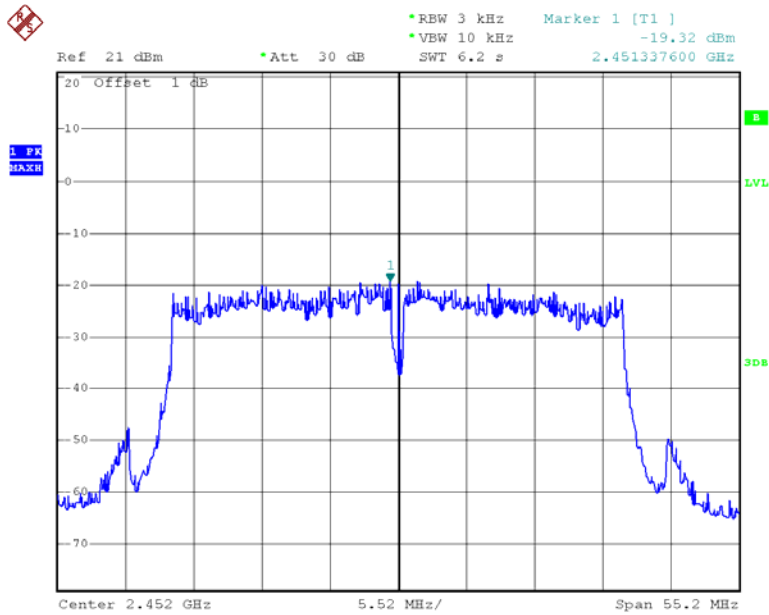

Date: 23.FEB.2013 15:22:53

Chain 2: Power Spectral Density, 802.11n40 Low Channel

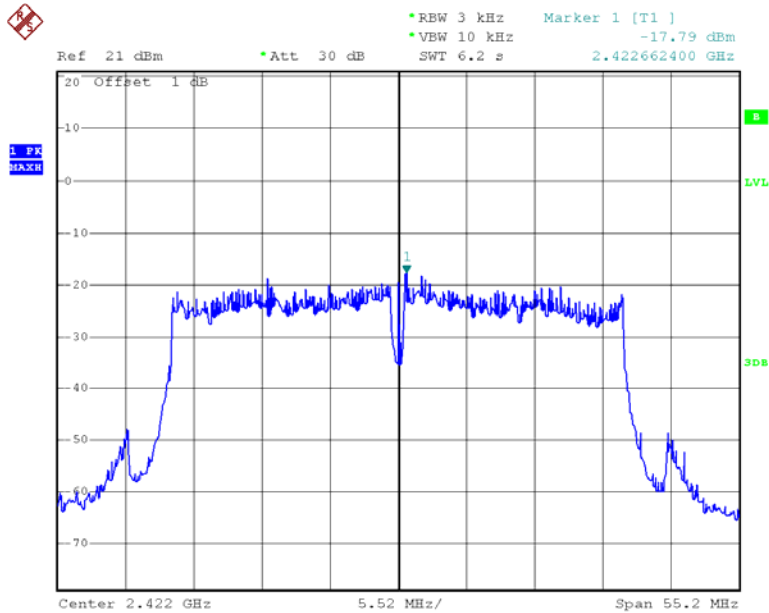

Date: 23.FEB.2013 15:02:26

Chain 2: Power Spectral Density, 802.11n40 Middle Channel

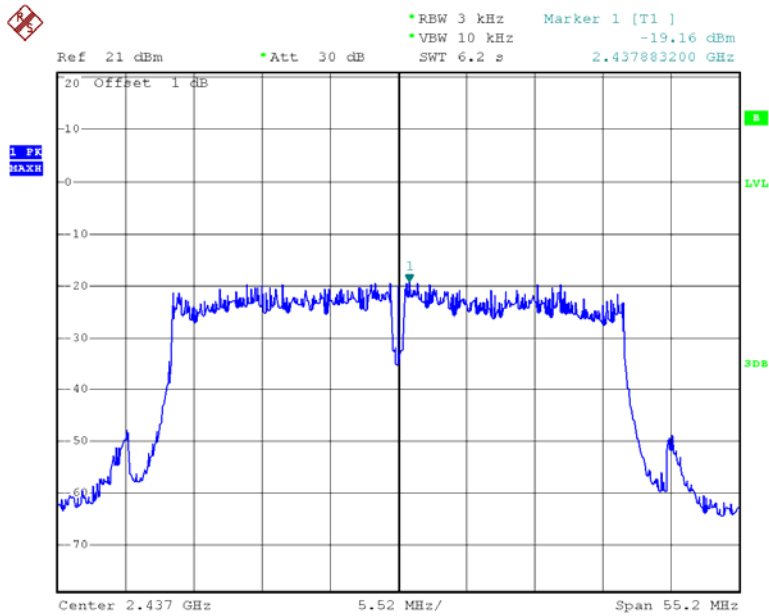

Date: 23.FEB.2013 15:15:07

Chain 2: Power Spectral Density, 802.11n40 High Channel

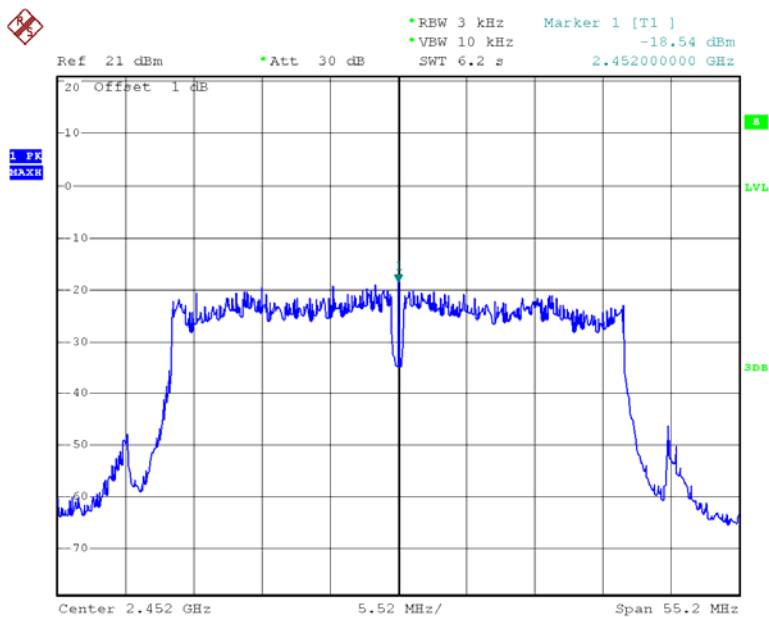

Date: 23.FEB.2013 15:23:17

***** END OF REPORT *****