

ANTENNA TEST REPORT

Manufacture: SHENZHEN TENDA TECHNOLOGY CO.,LTD.

ADD:6-8 Floor, Tower E3, No. 1001, Zhongshanyuan Road,

Nanshan District, Shenzhen, China. 518052

Product Name	U11
--------------	-----

Product picture

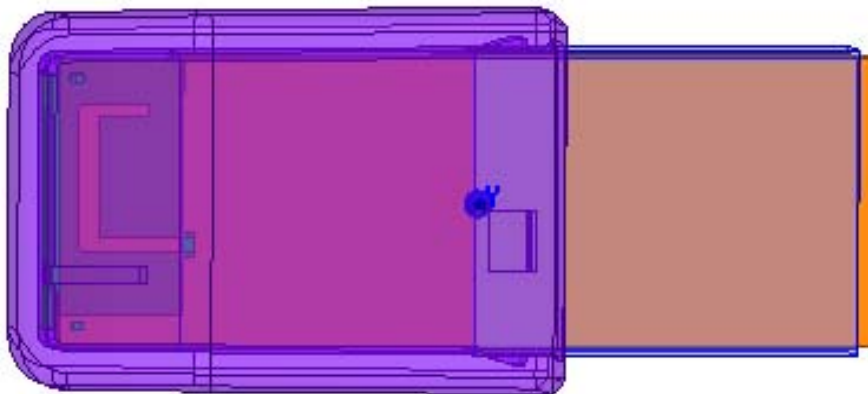

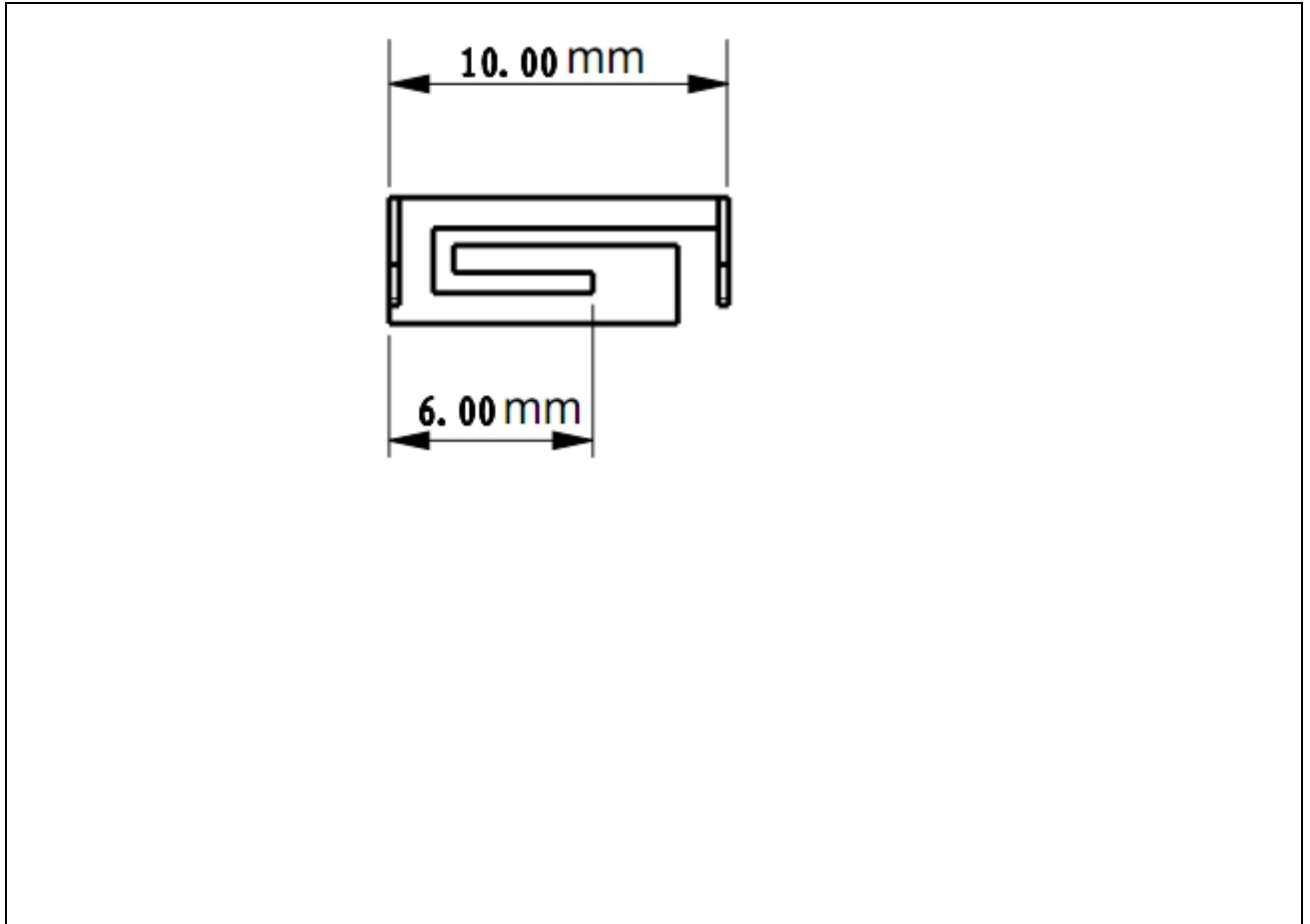

Electrical performance test results

Number	Inspection item	unit	Performance requirements	Inspection result		
1	Frequency range	MHz	2400-2500	2400-2500		OK
2	Gain	dBi	1.4	2412	1.4	OK
				2450	1.0	OK
				2483	0.6	OK
4	Return loss	dB	≤ -6	2400	-9	OK
				2450	-11	OK
				2483	-10	OK

Number	Inspection item	unit	Performance requirements	Inspection result		
1	Frequency range	MHz	5150-5850	5150-5850		OK

2	gain	dBi	0.5	5150	0.5	OK
				5500	0.4	OK
				5850	0.3	OK
4	Return loss	dB	≤ -6	5150	-21	OK
				5500	-14	OK
				5850	-11	OK

S11	
Frequency-MHz	2400-2500/5150-5850

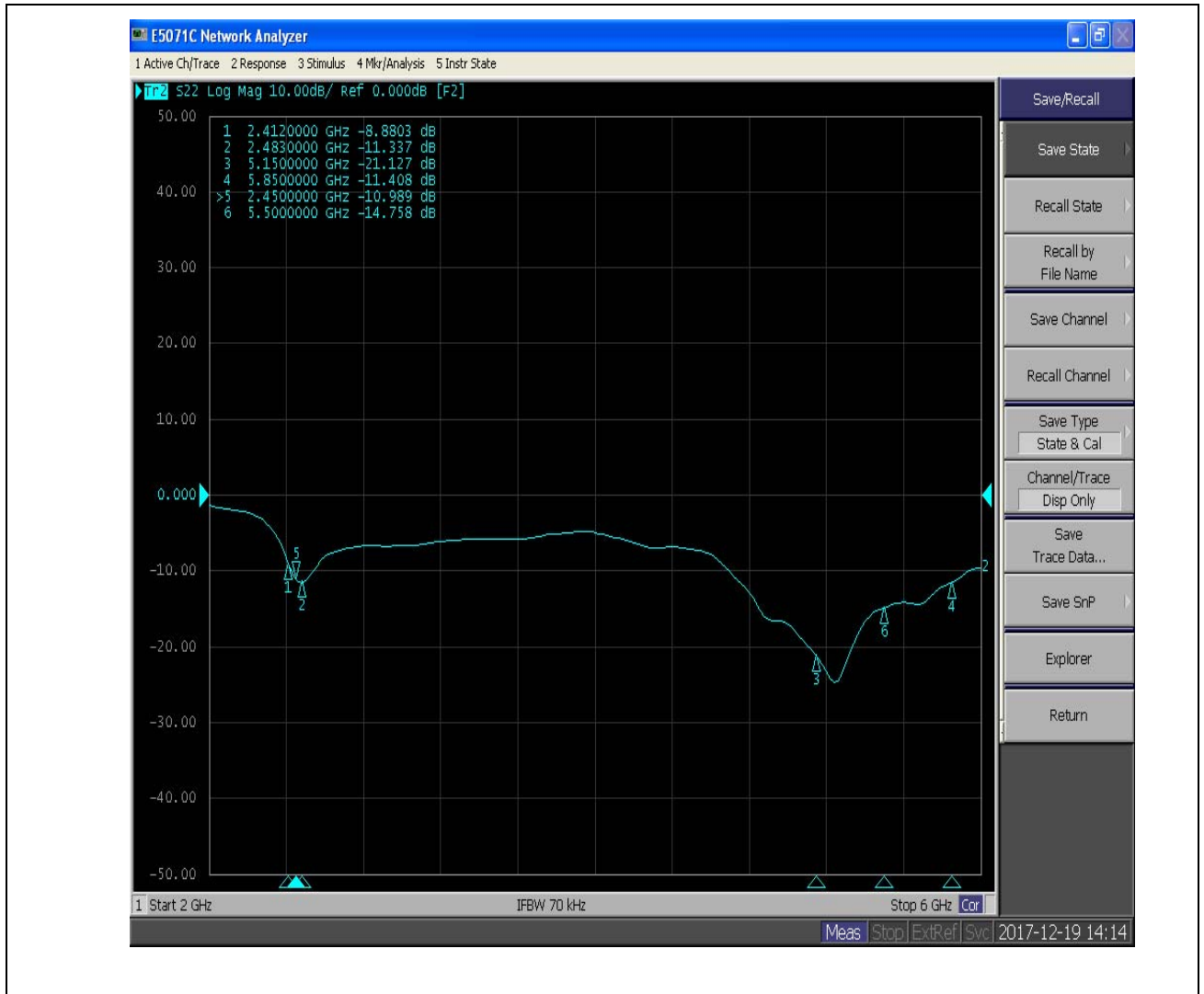

3D radiation pattern (2.4G)

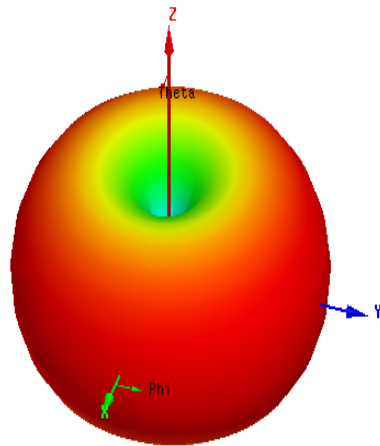
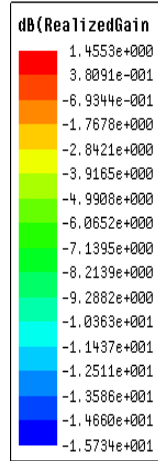

2D radiation pattern (2.4G) V-plane

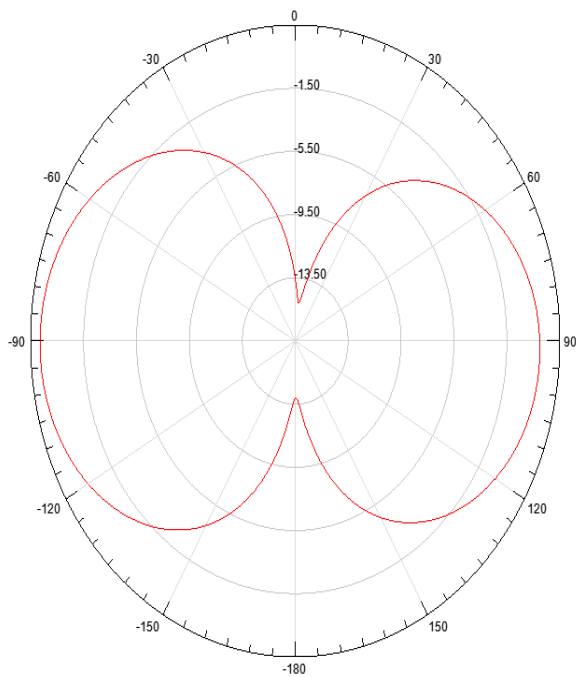

2D radiation pattern (2.4G) H-plane

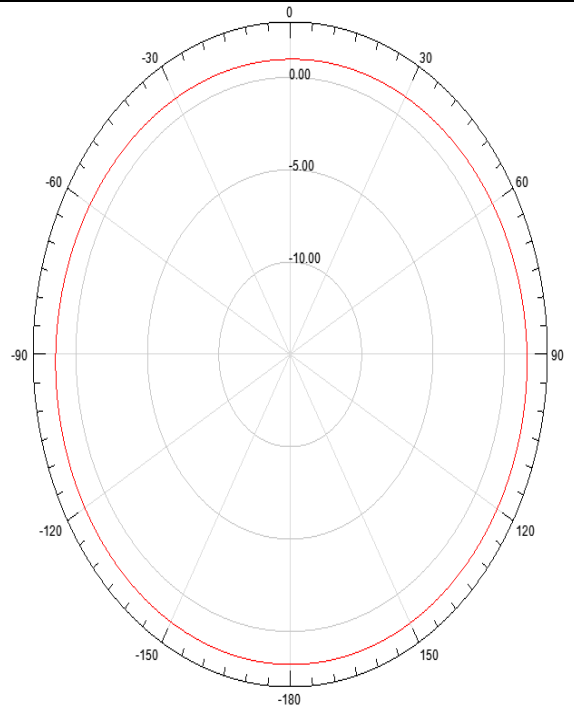

3D radiation pattern (5G)

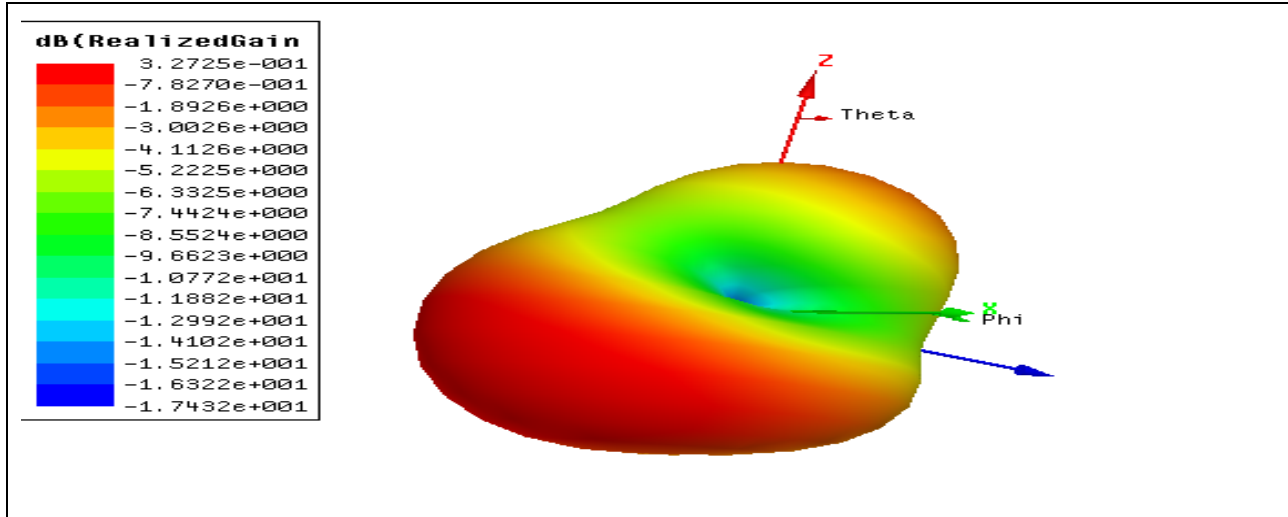

2D radiation pattern (5.5G) V-plane

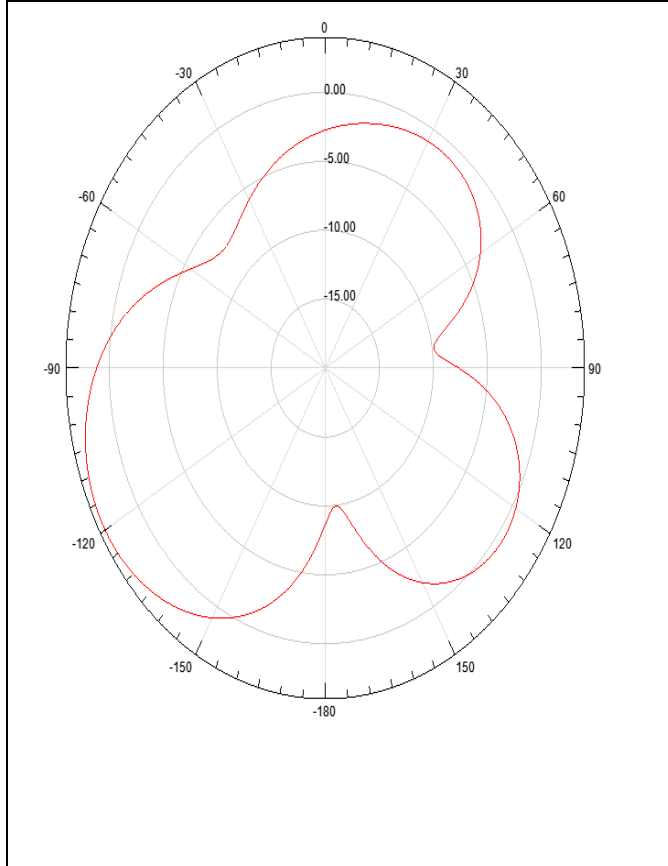

2D radiation pattern (5.5G) H-plane

