

FCC Radio Test Report

FCC ID: V7TTX3

This report concerns: Original Grant

Project No. : 2011C009
Equipment : AX1800 Dual Band Gigabit Wi-Fi 6 Router
Brand Name : Tenda
Test Model : TX3
Series Model : RX3
Applicant : SHENZHEN TENDA TECHNOLOGY CO.,LTD
Address : 6-8 Floor, Tower E3, No. 1001, Zhongshanyuan Road, Nanshan District, Shenzhen, China. 518052
Manufacturer : SHENZHEN TENDA TECHNOLOGY CO.,LTD
Address : 6-8 Floor, Tower E3, No. 1001, Zhongshanyuan Road, Nanshan District, Shenzhen, China. 518052
Date of Receipt : Nov. 02, 2020
Date of Test : Nov. 03, 2020 ~ Dec. 04, 2020
Issued Date : Dec. 11, 2020
Report Version : R00
Test Sample : Engineering Sample No.: DG2020110287 for conducted, DG2020110290 for radiated
Standard(s) : FCC Part15, Subpart C (15.247)
ANSI C63.10-2013
FCC KDB 558074 D01 15.247 Meas Guidance v05r02

The above equipment has been tested and found compliance with the requirement of the relative standards by BTL Inc.

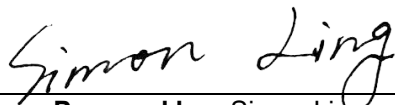

Prepared by : Simon Ling



Approved by : Ethan Ma



Certificate #5123.02

Add: No.3, Jinshagang 1st Road, Shixia, Dalang Town, Dongguan, Guangdong, China.

Tel: +86-769-8318-3000

Web: www.newbtl.com

Declaration

BTL represents to the client that testing is done in accordance with standard procedures as applicable and that test instruments used has been calibrated with standards traceable to international standard(s) and/or national standard(s).

BTL's reports apply only to the specific samples tested under conditions. It is manufacture's responsibility to ensure that additional production units of this model are manufactured with the identical electrical and mechanical components. **BTL** shall have no liability for any declarations, inferences or generalizations drawn by the client or others from **BTL** issued reports.

The report must not be used by the client to claim product certification, approval, or endorsement by NVLAP, NIST, A2LA, or any agency of the U.S. Government.

This report is the confidential property of the client. As a mutual protection to the clients, the public and ourselves, the test report shall not be reproduced, except in full, without our written approval.

BTL's laboratory quality assurance procedures are in compliance with the **ISO/IEC 17025** requirements, and accredited by the conformity assessment authorities listed in this test report.

BTL is not responsible for the sampling stage, so the results only apply to the sample as received.

The information, data and test plan are provided by manufacturer which may affect the validity of results, so it is manufacturer's responsibility to ensure that the apparatus meets the essential requirements of applied standards and in all the possible configurations as representative of its intended use.

Limitation

For the use of the authority's logo is limited unless the Test Standard(s)/Scope(s)/Item(s) mentioned in this test report is (are) included in the conformity assessment authorities acceptance respective.

Please note that the measurement uncertainty is provided for informational purpose only and are not use in determining the Pass/Fail results.

Table of Contents	Page
REPORT ISSUED HISTORY	6
1 . SUMMARY OF TEST RESULTS	7
1.1 TEST FACILITY	8
1.2 MEASUREMENT UNCERTAINTY	8
1.3 TEST ENVIRONMENT CONDITIONS	9
2 . GENERAL INFORMATION	10
2.1 GENERAL DESCRIPTION OF EUT	10
2.2 DESCRIPTION OF TEST MODES	13
2.3 PARAMETERS OF TEST SOFTWARE	16
2.4 DUTY CYCLE	17
2.5 BLOCK DIAGRAM SHOWING THE CONFIGURATION OF SYSTEM TESTED	19
2.6 SUPPORT UNITS	19
3 . AC POWER LINE CONDUCTED EMISSIONS TEST	20
3.1 LIMIT	20
3.2 TEST PROCEDURE	20
3.3 DEVIATION FROM TEST STANDARD	20
3.4 TEST SETUP	21
3.5 EUT OPERATION CONDITIONS	21
3.6 TEST RESULTS	21
4 . RADIATED EMISSIONS TEST	22
4.1 LIMIT	22
4.2 TEST PROCEDURE	23
4.3 DEVIATION FROM TEST STANDARD	23
4.4 TEST SETUP	24
4.5 EUT OPERATION CONDITIONS	25
4.6 TEST RESULTS - 9 KHZ TO 30 MHZ	25
4.7 TEST RESULTS - 30 MHZ TO 1000 MHZ	25
4.8 TEST RESULTS - ABOVE 1000 MHZ	25
5 . BANDWIDTH TEST	26
5.1 LIMIT	26
5.2 TEST PROCEDURE	26
5.3 DEVIATION FROM STANDARD	26

Table of Contents	Page
5.4 TEST SETUP	26
5.5 EUT OPERATION CONDITIONS	26
5.6 TEST RESULTS	26
6 . MAXIMUM OUTPUT POWER TEST	27
6.1 LIMIT	27
6.2 TEST PROCEDURE	27
6.3 DEVIATION FROM STANDARD	27
6.4 TEST SETUP	27
6.5 EUT OPERATION CONDITIONS	27
6.6 TEST RESULTS	27
7 . CONDUCTED SPURIOUS EMISSIONS	28
7.1 LIMIT	28
7.2 TEST PROCEDURE	28
7.3 DEVIATION FROM STANDARD	28
7.4 TEST SETUP	28
7.5 EUT OPERATION CONDITIONS	28
7.6 TEST RESULTS	28
8 . POWER SPECTRAL DENSITY TEST	29
8.1 LIMIT	29
8.2 TEST PROCEDURE	29
8.3 DEVIATION FROM STANDARD	29
8.4 TEST SETUP	29
8.5 EUT OPERATION CONDITIONS	29
8.6 TEST RESULTS	29
9 . MEASUREMENT INSTRUMENTS LIST	30
10 . EUT TEST PHOTO	32
APPENDIX A - AC POWER LINE CONDUCTED EMISSIONS	36
APPENDIX B - RADIATED EMISSION - 9 KHZ TO 30 MHZ	41
APPENDIX C - RADIATED EMISSION - 30 MHZ TO 1000 MHZ	46
APPENDIX D - RADIATED EMISSION- ABOVE 1000 MHZ	49
APPENDIX E - BANDWIDTH	124
APPENDIX F - MAXIMUM OUTPUT POWER	131

Table of Contents**Page****APPENDIX G - CONDUCTED SPURIOUS EMISSIONS****145****APPENDIX H - POWER SPECTRAL DENSITY****156**

REPORT ISSUED HISTORY

Report Version	Description	Issued Date
R00	Original Issue.	Dec. 11, 2020

1. SUMMARY OF TEST RESULTS

Test procedures according to the technical standard(s):

FCC Part15, Subpart C (15.247)				
Standard(s) Section	Test Item	Test Result	Judgment	Remark
15.207	AC Power Line Conducted Emissions	APPENDIX A	PASS	-----
15.247(d) 15.205(a) 15.209(a)	Radiated Emissions	APPENDIX B APPENDIX C APPENDIX D	PASS	-----
15.247(a)(2)	Bandwidth	APPENDIX E	PASS	-----
15.247(b)(3)	Maximum Output Power	APPENDIX F	PASS	-----
15.247(d)	Conducted Spurious Emissions	APPENDIX G	PASS	-----
15.247(e)	Power Spectral Density	APPENDIX H	PASS	-----
15.203	Antenna Requirement	-----	PASS	Note(2)

Note:

- (1) "N/A" denotes test is not applicable in this test report.
- (2) The device what use a permanently attached antenna were considered sufficient to comply with the provisions of 15.203.

1.1 TEST FACILITY

The test facilities used to collect the test data in this report is at the location of No.3,Jinshagang 1st Road, Shixia, Dalang Town, Dongguan, Guangdong, China.

BTL's Test Firm Registration Number for FCC: 357015

BTL's Designation Number for FCC: CN1240

1.2 MEASUREMENT UNCERTAINTY

ISO/IEC 17025 requires that an estimate of the measurement uncertainties associated with the emissions test results be included in the report. The measurement uncertainties given below are based on a 95% confidence level (based on a coverage factor (k=2))

The BTL measurement uncertainty as below table:

A. AC power line conducted emissions test:

Test Site	Method	Measurement Frequency Range	U, (dB)
DG-C02	CISPR	150kHz ~ 30MHz	2.68

B. Radiated emissions test:

Test Site	Method	Measurement Frequency Range	Ant. H / V	U, (dB)
DG-CB03	CISPR	9kHz ~ 30MHz	-	3.02
		30MHz ~ 200MHz	V	4.26
		30MHz ~ 200MHz	H	3.38
		200MHz ~ 1,000MHz	V	3.98
		200MHz ~ 1,000MHz	H	3.94
		1GHz ~ 6GHz	-	3.96
		6GHz ~ 18GHz	-	5.24
		18GHz ~ 26.5GHz	-	3.62
		26.5GHz ~ 40GHz	-	4.00

C. Other Measurement:

Test Item	Uncertainty
Bandwidth	±3.8 %
Maximum Output Power	±0.95 dB
Conducted Spurious Emission	±2.71 dB
Power Spectral Density	±0.86 dB
Temperature	±0.08 °C
Humidity	±1.5%

Note: Unless specifically mentioned, the uncertainty of measurement has not been taken into account to declare the compliance or non-compliance to the specification.

1.3 TEST ENVIRONMENT CONDITIONS

Test Item	Temperature	Humidity	Test Voltage	Tested By
AC Power Line Conducted Emissions	25°C	53%	AC 120V/60Hz AC 230V/50Hz	Hand Huang
Radiated Emissions-9K-30MHz	25°C	60%	AC 120V/60Hz	Kwok Guo
Radiated Emissions-30 MHz to 1GHz	26°C	52%	AC 120V/60Hz	Kwok Guo
Radiated Emissions-Above 1000 MHz	26°C	52%	AC 120V/60Hz	Kwok Guo
Bandwidth	25°C	48%	DC 12V	Jesse Wang
Maximum output power	25°C	48%	DC 12V	Jesse Wang
Conducted Spurious Emissions	25°C	48%	DC 12V	Jesse Wang
Power Spectral Density	25°C	48%	DC 12V	Jesse Wang

2. GENERAL INFORMATION

2.1 GENERAL DESCRIPTION OF EUT

Equipment	AX1800 Dual Band Gigabit Wi-Fi 6 Router
Brand Name	Tenda
Test Model	TX3
Series Model	RX3
Model Difference(s)	Only differ in model name.
Power Source	DC voltage supplied from AC adapter. Model: BN073-A12012U
Power Rating	I/P: 100-240V ~50/60Hz 0.4A O/P: 12V \equiv 1A
Operation Frequency	2412 MHz ~ 2462 MHz
Modulation Type	IEEE 802.11b: DSSS IEEE 802.11g: OFDM IEEE 802.11n: OFDM IEEE vht: 256QAM IEEE 802.11ax: OFDMA
Bit Rate of Transmitter	IEEE 802.11b: 11/5.5/2/1 Mbps IEEE 802.11g: 54/48/36/24/18/12/9/6 Mbps IEEE 802.11n: up to 300 Mbps IEEE vht: up to 400 Mbps IEEE 802.11ax: up to 573.6 Mbps
Maximum Peak Output Power_Non Beamforming	IEEE 802.11b: 22.14 dBm (0.1637 W) IEEE 802.11g: 28.11 dBm (0.6471 W) IEEE 802.11n (HT20): 29.83 dBm (0.9616 W) IEEE 802.11n (HT40): 29.61 dBm (0.9141 W) IEEE vht20: 29.78 dBm (0.9506 W) IEEE vht40: 29.56 dBm (0.9036 W) IEEE 802.11ax(HE20): 29.74 dBm (0.9419 W) IEEE 802.11ax(HE40): 29.38 dBm (0.8670 W)
Maximum Peak Output Power_Beamforming	IEEE 802.11n (HT20): 27.96 dBm (0.6252 W) IEEE 802.11n (HT40): 27.90 dBm (0.6166 W) IEEE vht20: 27.87 dBm (0.6124 W) IEEE vht40: 27.93 dBm (0.6209 W) IEEE 802.11ax(HE20): 27.82 dBm (0.6053 W) IEEE 802.11ax(HE40): 27.92 dBm (0.6194 W)
Maximum Average Output Power_Non Beamforming	IEEE 802.11b: 18.86 dBm (0.0769 W) IEEE 802.11g: 21.60 dBm (0.1445 W) IEEE 802.11n (HT20): 19.53 dBm (0.0897 W) IEEE 802.11n (HT40): 19.21 dBm (0.0834 W) IEEE vht20: 19.51 dBm (0.0893 W) IEEE vht40: 19.12 dBm (0.0817 W) IEEE 802.11ax(HE20): 20.18 dBm (0.1042 W) IEEE 802.11ax(HE40): 20.03 dBm (0.1007 W)
Maximum Average Output Power_Beamforming	IEEE 802.11n (HT20): 18.53 dBm (0.0713 W) IEEE 802.11n (HT40): 18.46 dBm (0.0701 W) IEEE vht20: 18.22 dBm (0.0664 W) IEEE vht40: 18.43 dBm (0.0697 W) IEEE 802.11ax(HE20): 19.18 dBm (0.0828 W) IEEE 802.11ax(HE40): 19.03 dBm (0.0800 W)

Note:

1. For a more detailed features description, please refer to the manufacturer's specifications or the user's manual.

2. Channel List:

CH01 - CH11 for IEEE 802.11b, IEEE 802.11g, IEEE 802.11n (HT20), IEEE vht20, IEEE 802.11ax(HE20)							
CH03 - CH09 for IEEE 802.11n (HT40), IEEE vht40, IEEE 802.11ax(HE40)							
Channel	Frequency (MHz)	Channel	Frequency (MHz)	Channel	Frequency (MHz)	Channel	Frequency (MHz)
01	2412	04	2427	07	2442	10	2457
02	2417	05	2432	08	2447	11	2462
03	2422	06	2437	09	2452		

3. RU Configuration:

IEEE 802.11ax(HE20)	Resource Unit	242 Tone(20M)
	Specific Resource Unit	61
IEEE 802.11ax(HE40)	Resource Unit	484 Tone(40M)
	Specific Resource Unit	65

Remark: IEEE 802.11ax mode only supports the highest tone, so the highest tone was evaluated and measured inside report.

4. Table for Filed Antenna:

Ant.	Brand	Model Name	Antenna Type	Connector	Gain (dBi)
1	N/A	N/A	Dipole	N/A	5
2	N/A	N/A	Dipole	N/A	5

Note:

- This EUT supports CDD, and all antennas have the same gain, Directional gain = $G_{ANT} + \text{Array Gain}$. For power measurements, Array Gain=0dB ($N_{ANT} \leq 4$), so the Directional gain=5. For power spectral density measurements, $N_{ANT}=2$, $N_{SS} = 1$. So the Directional gain= $G_{ANT} + \text{Array Gain} = G_{ANT} + 10\log(N_{ANT}/N_{SS})\text{dBi} = 5 + 10\log(2/1)\text{dBi} = 8.01$. Then, the power spectral density limit is $8 - (8.01 - 6) = 5.99$.
- Beamforming Gain: 3 dB. So Directional gain= $5 + 3 = 8$. Then, the power limit is $30 - (8 - 6) = 28.00$.
- The antenna gain is provided by the manufacturer.

5. Table for Antenna Configuration:
 For Non Beamforming:

Operating Mode	TX Mode	1TX	2TX
IEEE 802.11b		V (Ant. 1)	-
IEEE 802.11g		V (Ant. 1)	-
IEEE 802.11n(HT20)		-	V (Ant. 1+Ant. 2)
IEEE 802.11n(HT40)		-	V (Ant. 1+Ant. 2)
IEEE vht20		-	V (Ant. 1+Ant. 2)
IEEE vht40		-	V (Ant. 1+Ant. 2)
IEEE 802.11ax(HE20)		-	V (Ant. 1+Ant. 2)
IEEE 802.11ax(HE40)		-	V (Ant. 1+Ant. 2)

For Beamforming:

Operating Mode	TX Mode	2TX
IEEE 802.11n(HT20)		V (Ant. 1+Ant. 2)
IEEE 802.11n(HT40)		V (Ant. 1+Ant. 2)
IEEE vht20		V (Ant. 1+Ant. 2)
IEEE vht40		V (Ant. 1+Ant. 2)
IEEE 802.11ax(HE20)		V (Ant. 1+Ant. 2)
IEEE 802.11ax(HE40)		V (Ant. 1+Ant. 2)

2.2 DESCRIPTION OF TEST MODES

The test system was pre-tested based on the consideration of all possible combinations of EUT operation mode.

Pretest Mode	Description
Mode 1	TX B Mode Channel 01/06/11
Mode 2	TX G Mode Channel 01/06/11
Mode 3	TX N-20 MHz Mode Channel 01/06/11
Mode 4	TX N-40 MHz Mode Channel 03/06/09
Mode 5	TX vht20 Mode Channel 01/06/11
Mode 6	TX vht40 Mode Channel 03/06/09
Mode 7	TX AX-20 MHz Mode Channel 01/06/11
Mode 8	TX AX-40 MHz Mode Channel 03/06/09
Mode 9	TX N-20 MHz Mode Channel 01

Following mode(s) was (were) found to be the worst case(s) and selected for the final test.

AC power line conducted emissions test	
Final Test Mode	Description
Mode 9	TX N-20 MHz Mode Channel 01

Radiated emissions test - Below 1GHz	
Final Test Mode	Description
Mode 9	TX N-20 MHz Mode Channel 01

Radiated emissions test- Above 1GHz_Non Beamforming	
Final Test Mode	Description
Mode 1	TX B Mode Channel 01/06/11
Mode 2	TX G Mode Channel 01/06/11
Mode 3	TX N-20 MHz Mode Channel 01/06/11
Mode 4	TX N-40 MHz Mode Channel 03/06/09
Mode 7	TX AX-20 MHz Mode Channel 01/06/11
Mode 8	TX AX-40 MHz Mode Channel 03/06/09

Maximum Output Power_Non Beamforming	
Final Test Mode	Description
Mode 1	TX B Mode Channel 01/06/11
Mode 2	TX G Mode Channel 01/06/11
Mode 3	TX N-20 MHz Mode Channel 01/06/11
Mode 4	TX N-40 MHz Mode Channel 03/06/09
Mode 5	TX vht20 Mode Channel 01/06/11
Mode 6	TX vht40 Mode Channel 03/06/09
Mode 7	TX AX-20 MHz Mode Channel 01/06/11
Mode 8	TX AX-40 MHz Mode Channel 03/06/09

Maximum Output Power_Beamforming	
Final Test Mode	Description
Mode 3	TX N-20 MHz Mode Channel 01/06/11
Mode 4	TX N-40 MHz Mode Channel 03/06/09
Mode 5	TX vht20 Mode Channel 01/06/11
Mode 6	TX vht40 Mode Channel 03/06/09
Mode 7	TX AX-20 MHz Mode Channel 01/06/11
Mode 8	TX AX-40 MHz Mode Channel 03/06/09

Other Conducted test_Non Beamforming	
Final Test Mode	Description
Mode 1	TX B Mode Channel 01/06/11
Mode 2	TX G Mode Channel 01/06/11
Mode 3	TX N-20 MHz Mode Channel 01/06/11
Mode 4	TX N-40 MHz Mode Channel 03/06/09
Mode 7	TX AX-20 MHz Mode Channel 01/06/11
Mode 8	TX AX-40 MHz Mode Channel 03/06/09

NOTE:

- (1) The measurements are performed at the high, middle, low available channels.
- (2) All the bit rate of transmitter have been tested and found the lowest rate is found to be the worst case and recorded.
- (3) For radiated emission below 1 GHz test, the IEEE 802.11n20 Channel 01 is found to be the worst case and recorded.
- (4) For radiated emission above 1 GHz test, 1GHz~26.5GHz have been pre-tested and in this report only recorded the worst case. The remaining spurious points are all below the limit value of 20dB.
- (5) The measurements for Power were tested, the worst cases were IEEE 802.11b mode, IEEE 802.11g mode, IEEE 802.11n(HT20) mode, IEEE 802.11n(HT40) mode, IEEE 802.11ax(HE20) mode and IEEE 802.11ax(HE40) mode, only the worst cases were documented for other test items.
- (6) The measurements for Power were tested, the Non Beamforming and Beamforming are recorded in the report. The worst case was Non Beamforming and only worst case were documented for other test items.
- (7) For radiated emissions, the TX WLAN 2.4G G Mode 2437MHz + WLAN 5G AX20 Mode 5240MHz was found the worst case of simultaneous transmission and recorded.

2.3 PARAMETERS OF TEST SOFTWARE
Non Beamforming

Test Software	accessMTool V3_1_0_6		
Frequency (MHz)	2412	2437	2462
IEEE 802.11b	69	75	73
IEEE 802.11g	70	86	73
IEEE 802.11n (HT20)	65	65	65
IEEE vht20	65	65	65
IEEE 802.11ax(HE20)	67	67	65
Frequency (MHz)	2422	2437	2452
IEEE 802.11n (HT40)	65	65	65
IEEE vht40	65	65	65
IEEE 802.11ax(HE40)	63	67	65

Beamforming

Test Software	accessMTool V3_1_0_6		
Frequency (MHz)	2412	2437	2462
IEEE 802.11n (HT20)	57	58	58
IEEE vht20	57	57	56
IEEE 802.11ax(HE20)	60	60	58
Frequency (MHz)	2422	2437	2452
IEEE 802.11n (HT40)	58	58	58
IEEE vht40	58	58	58
IEEE 802.11ax(HE40)	57	59	58

2.4 DUTY CYCLE

If duty cycle is $\geq 98\%$, duty factor is not required.
 If duty cycle is $< 98\%$, duty factor shall be considered.
 The output power = measured power + duty factor.

IEEE 802.11b

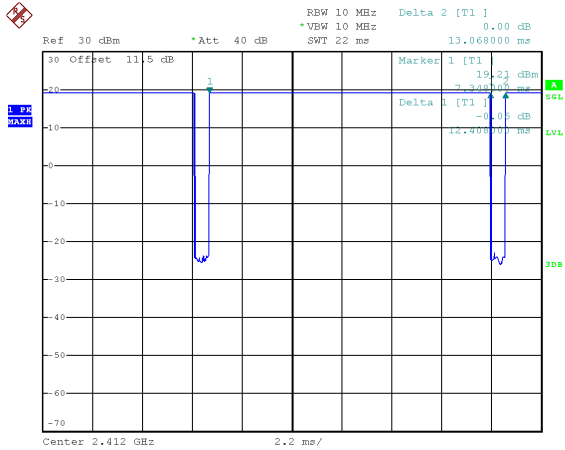

Date: 5.NOV.2020 15:36:01

Duty cycle = 12.408 ms / 13.068 ms = 94.95%
 Duty Factor = $10 \log(1/\text{Duty cycle}) = 0.23$

IEEE 802.11g

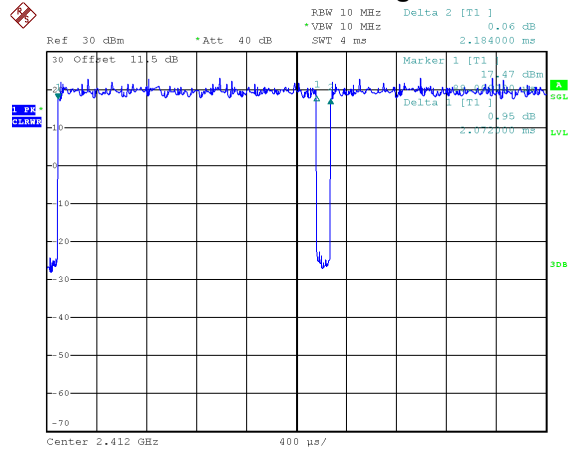

Date: 5.NOV.2020 15:36:27

Duty cycle = 2.072 ms / 2.184 ms = 94.87%
 Duty Factor = $10 \log(1/\text{Duty cycle}) = 0.23$

IEEE 802.11n (HT20)

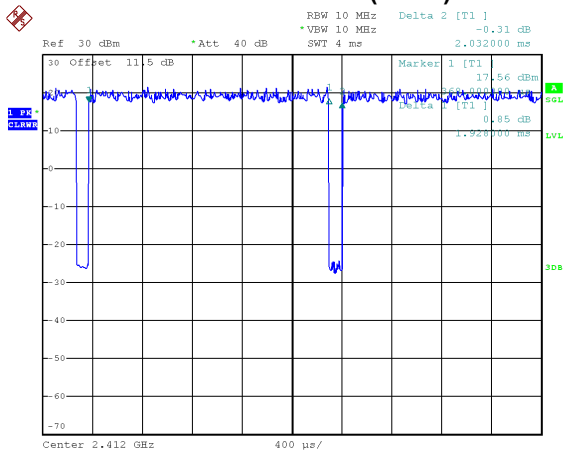

Date: 5.NOV.2020 15:36:47

Duty cycle = 1.928 ms / 2.032 ms = 94.88%
 Duty Factor = $10 \log(1/\text{Duty cycle}) = 0.23$

IEEE 802.11n (HT40)

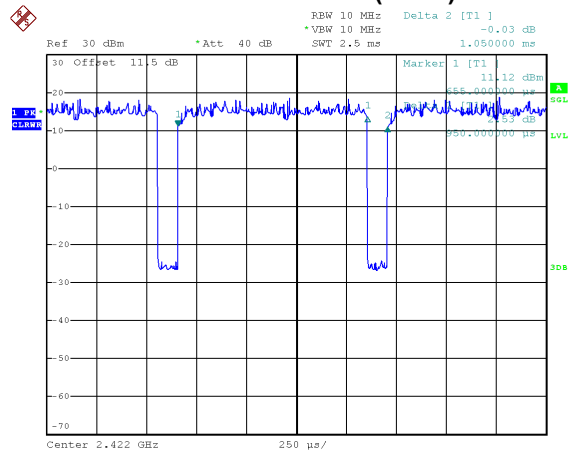

Date: 5.NOV.2020 15:37:08

Duty cycle = 0.950 ms / 1.050 ms = 90.48%
 Duty Factor = $10 \log(1/\text{Duty cycle}) = 0.43$

IEEE vht20

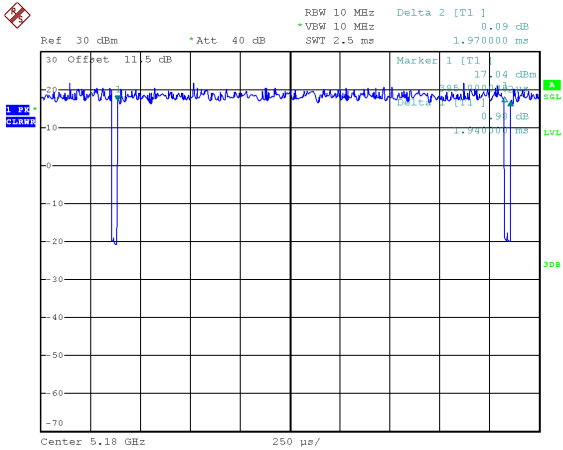

Date: 5.NOV.2020 15:44:53

Duty cycle = 1.940 ms / 1.970 ms = 98.48%
 Duty Factor = 10 log(1/Duty cycle) = 0.00

IEEE vht20

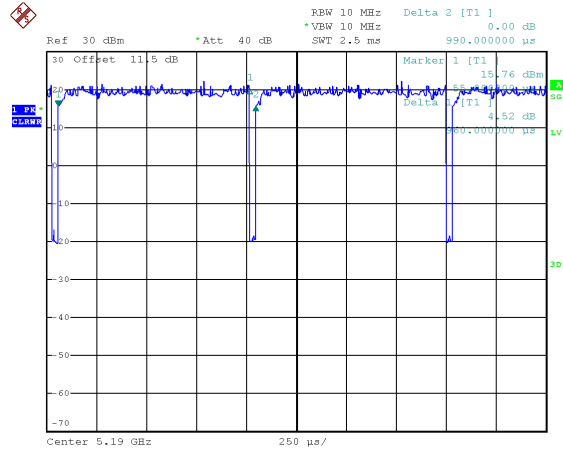

Date: 5.NOV.2020 15:46:49

Duty cycle = 0.960 ms / 0.990 ms = 96.97%
 Duty Factor = 10 log(1/Duty cycle) = 0.13

IEEE 802.11ax(HE20)

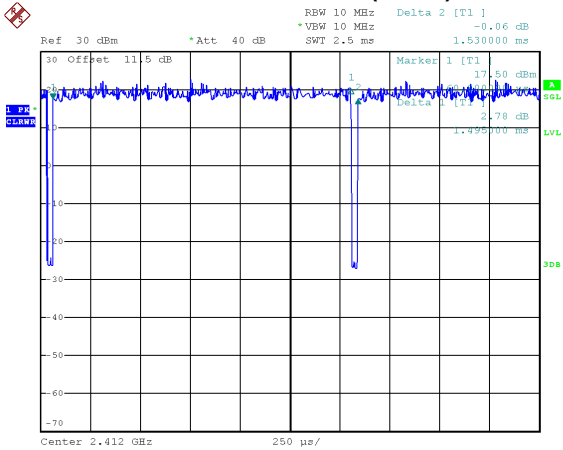

Date: 5.NOV.2020 15:37:50

Duty cycle = 1.495 ms / 1.530 ms = 97.71%
 Duty Factor = 10 log(1/Duty cycle) = 0.10

IEEE 802.11ax(HE40)

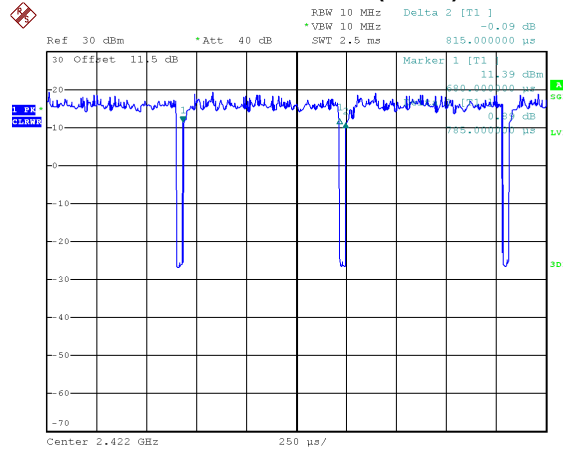

Date: 5.NOV.2020 15:38:10

Duty cycle = 0.785 ms / 0.815 ms = 96.32%
 Duty Factor = 10 log(1/Duty cycle) = 0.16

NOTE:

For IEEE 802.11b, IEEE 802.11g, IEEE 802.11n (HT20), IEEE vht20 and IEEE 802.11ax(HE20):
 For radiated emissions frequency above 1 GHz, the resolution bandwidth of test receiver/spectrum analyzer is 1 MHz and the video bandwidth is 1 kHz (Duty cycle < 98%).

For IEEE 802.11n (HT40), IEEE vht40 and IEEE 802.11ax(HE40):
 For radiated emissions frequency above 1 GHz, the resolution bandwidth of test receiver/spectrum analyzer is 1 MHz and the video bandwidth is 2 kHz (Duty cycle < 98%).

2.5 BLOCK DIAGRAM SHOWING THE CONFIGURATION OF SYSTEM TESTED

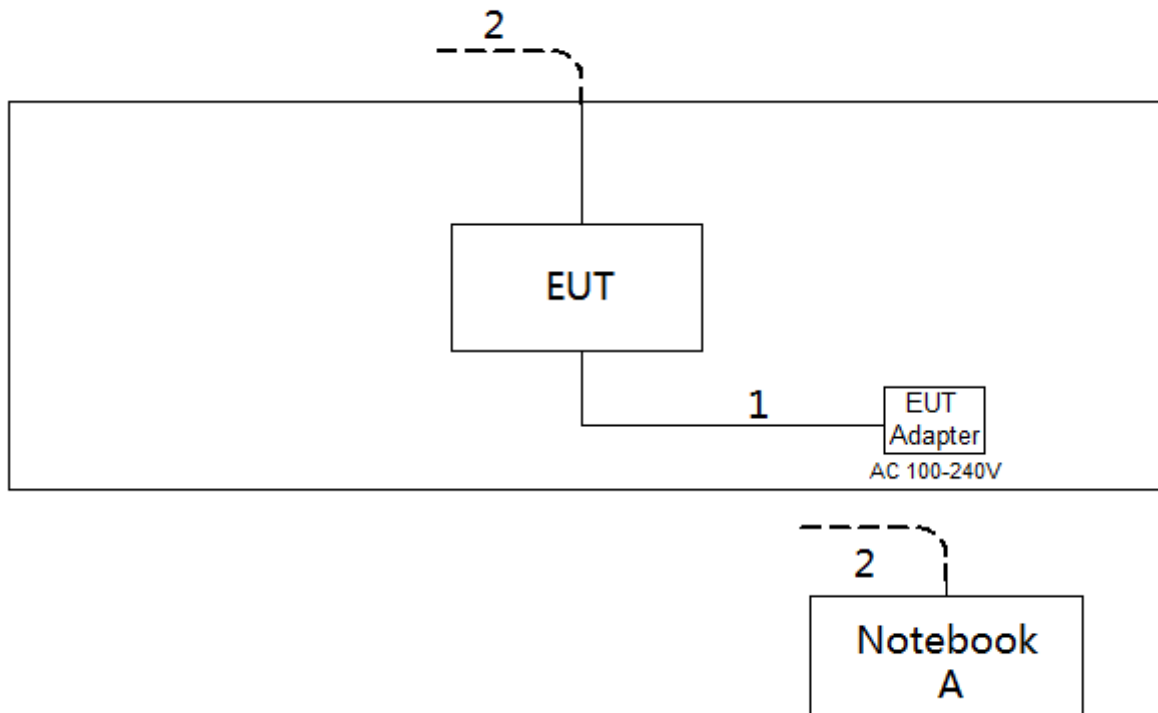

2.6 SUPPORT UNITS

Item	Equipment	Brand	Model No.	Series No.
A	Notebook	Dell	Inspiron 15-7559	N/A

Item	Cable Type	Shielded Type	Ferrite Core	Length
1	DC Cable	NO	NO	1.5m
2	RJ45 Cable	NO	NO	10m

3. AC POWER LINE CONDUCTED EMISSIONS TEST

3.1 LIMIT

Frequency of Emission (MHz)	Limit (dB μ V)	
	Quasi-peak	Average
0.15 - 0.5	66 to 56*	56 to 46*
0.5 - 5.0	56	46
5.0 - 30.0	60	50

NOTE:

- (1) The tighter limit applies at the band edges.
- (2) The limit of "*" marked band means the limitation decreases linearly with the logarithm of the frequency in the range.

The following table is the setting of the receiver

Receiver Parameters	Setting
Attenuation	10 dB
Start Frequency	0.15 MHz
Stop Frequency	30 MHz
IF Bandwidth	9 kHz

3.2 TEST PROCEDURE

- a. The EUT was placed 0.8 meters from the horizontal ground plane with EUT being connected to the power mains through a line impedance stabilization network (LISN). All other support equipment powered from additional LISN(s). The LISN provide 50 Ohm/ 50uH of coupling impedance for the measuring instrument.
- b. Interconnecting cables that hang closer than 40 cm to the ground plane shall be folded back and forth in the center forming a bundle 30 to 40 cm long.
- c. I/O cables that are not connected to a peripheral shall be bundled in the center. The end of the cable may be terminated, if required, using the correct terminating impedance. The overall length shall not exceed 1 m.
- d. LISN at least 80 cm from nearest part of EUT chassis.
- e. For the actual test configuration, please refer to the related Item -EUT Test Photos.

3.3 DEVIATION FROM TEST STANDARD

No deviation

3.4 TEST SETUP

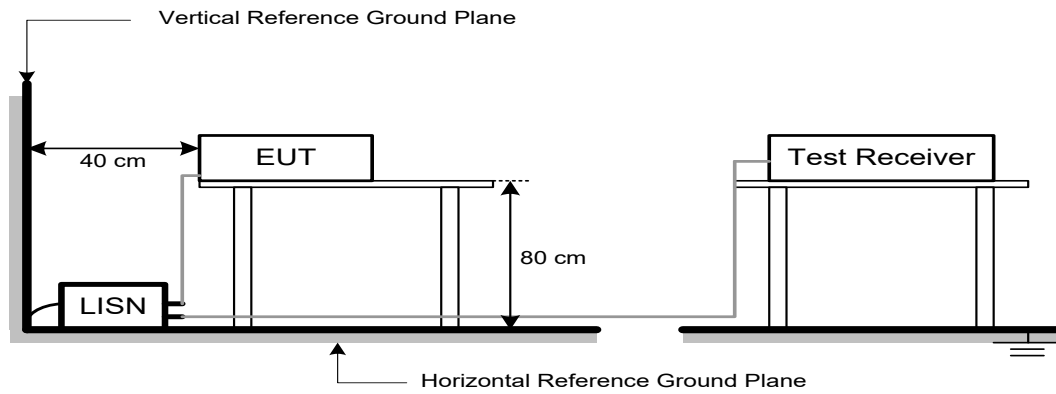

3.5 EUT OPERATION CONDITIONS

EUT was programmed to be in continuously transmitting mode.

3.6 TEST RESULTS

Please refer to the APPENDIX A.

4. RADIATED EMISSIONS TEST

4.1 LIMIT

In case the emission fall within the restricted band specified on 15.205(a), then the 15.209(a) limit in the table below has to be followed.

LIMITS OF RADIATED EMISSION MEASUREMENT (9 kHz-1000 MHz)

Frequency (MHz)	Field Strength (microvolts/meter)	Measurement Distance (meters)
0.009-0.490	2400/F(kHz)	300
0.490-1.705	24000/F(kHz)	30
1.705-30.0	30	30
30-88	100	3
88-216	150	3
216-960	200	3
Above 960	500	3

LIMITS OF RADIATED EMISSION MEASUREMENT (Above 1000 MHz)

Frequency (MHz)	(dBuV/m at 3 m)	
	Peak	Average
Above 1000	74	54

NOTE:

- (1) The limit for radiated test was performed according to FCC PART 15C.
- (2) The tighter limit applies at the band edges.
- (3) Emission level (dBuV/m)=20log Emission level (uV/m).

Spectrum Parameter	Setting
Attenuation	Auto
Start Frequency	1000 MHz
Stop Frequency	10th carrier harmonic
RBW / VBW (Emission in restricted band)	1 MHz / 3 MHz for Peak, 1 MHz / 1/T for Average

Receiver Parameter	Setting
Attenuation	Auto
Start ~ Stop Frequency	9 kHz~90 kHz for PK/AVG detector
Start ~ Stop Frequency	90 kHz~110 kHz for QP detector
Start ~ Stop Frequency	110 kHz~490 kHz for PK/AVG detector
Start ~ Stop Frequency	490 kHz~30 MHz for QP detector
Start ~ Stop Frequency	30 MHz~1000 MHz for QP detector

4.2 TEST PROCEDURE

- a. The measuring distance of 3 m shall be used for measurements. The EUT was placed on the top of a rotating table 0.8 meter above the ground at a 3 meter semi-anechoic chamber. The table was rotated 360 degrees to determine the position of the highest radiation.(below 1 GHz)
- b. The measuring distance of 3 m shall be used for measurements. The EUT was placed on the top of a rotating table 1.5 meter above the ground at a 3 meter semi-anechoic chamber. The table was rotated 360 degrees to determine the position of the highest radiation.(above 1 GHz)
- c. The height of the equipment or of the substitution antenna shall be 0.8m or 1.5m; the height of the test antenna shall vary between 1 m to 4 m. Both horizontal and vertical polarizations of the antenna are set to make the measurement.
- d. For each suspected emission, the EUT was arranged to its worst case and then the antenna was tuned to heights find the maximum reading (used Bore sight function).
- e. The receiver system was set to peak and average detect function and specified bandwidth with maximum hold mode when the test frequency is above 1 GHz.
- f. The initial step in collecting radiated emission data is a receiver peak detector mode pre-scanning the measurement frequency range. Significant peaks are then marked and then Quasi Peak detector mode re-measured.
- g. All readings are Peak unless otherwise stated QP in column of Note. Peak denotes that the Peak reading compliance with the QP Limits and then QP Mode measurement didn't perform.
(below 1 GHz)
- h. All readings are Peak Mode value unless otherwise stated AVG in column of Note. If the Peak Mode Measured value compliance with the Peak Limits and lower than AVG Limits, the EUT shall be deemed to meet both Peak & AVG Limits and then only Peak Mode was measured, but AVG Mode didn't perform. (above 1 GHz)
- i. For the actual test configuration, please refer to the related Item -EUT Test Photos.

4.3 DEVIATION FROM TEST STANDARD

No deviation

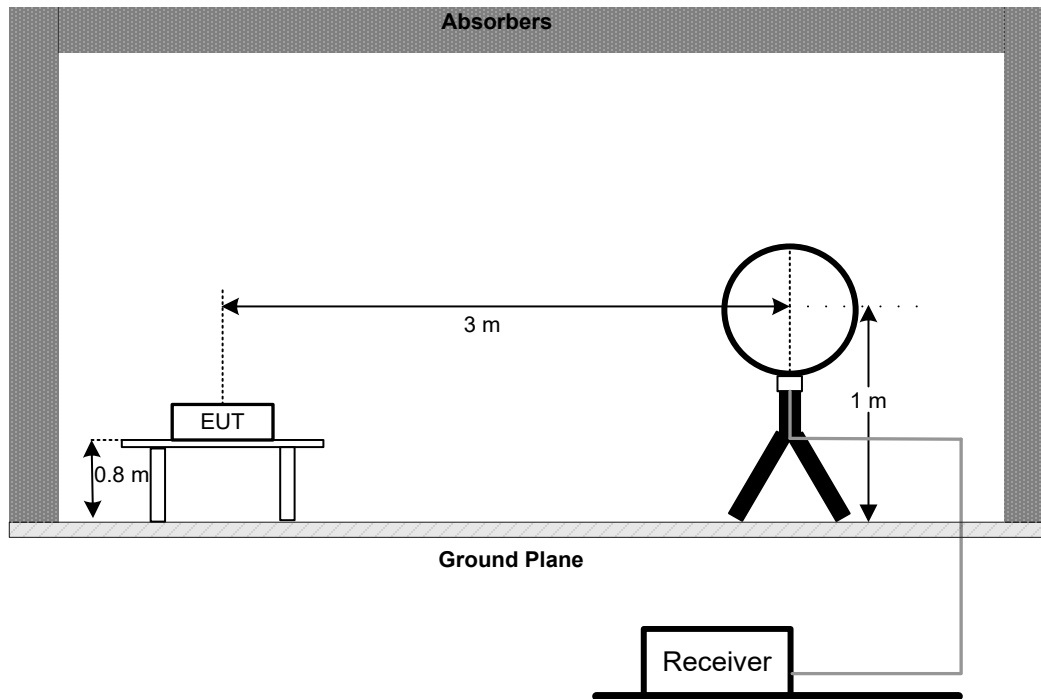
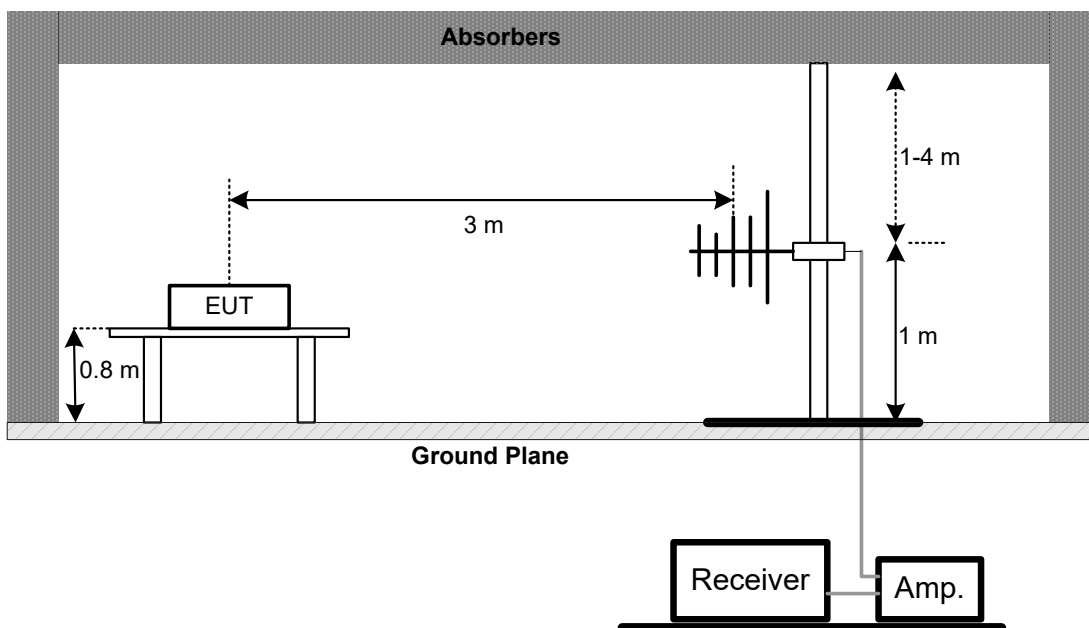
4.4 TEST SETUP**9 kHz-30 MHz****30 MHz to 1 GHz**

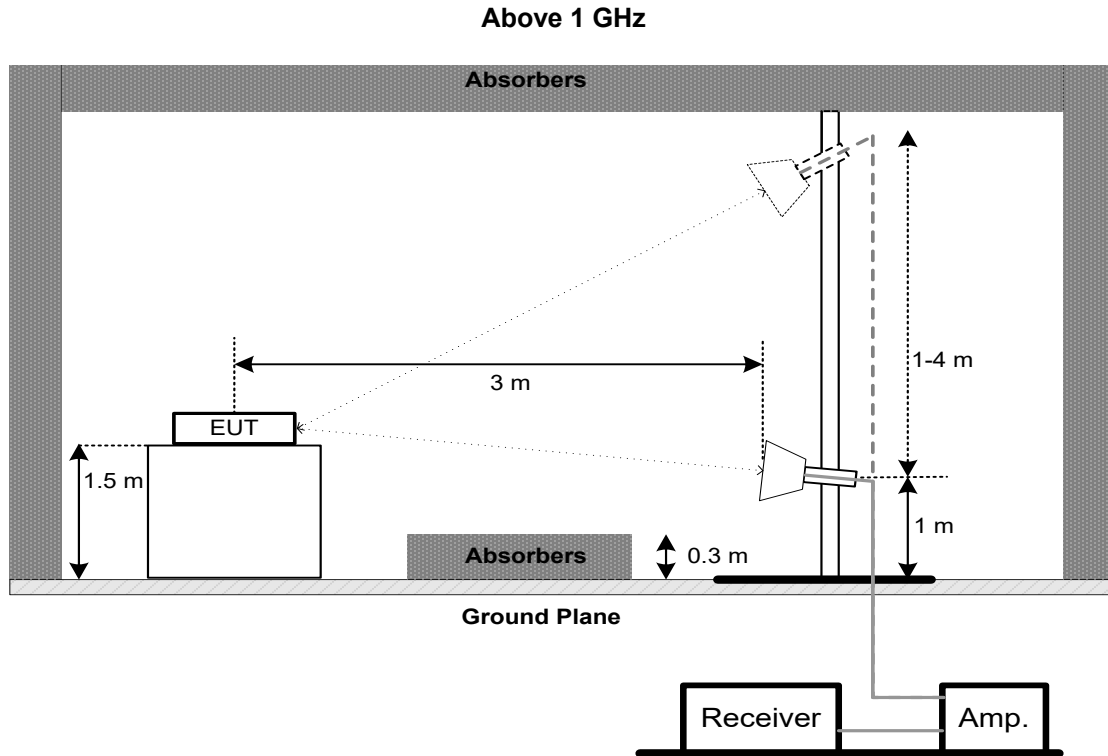

4.5 EUT OPERATION CONDITIONS

The EUT was programmed to be in continuously transmitting mode.

4.6 TEST RESULTS - 9 KHZ TO 30 MHZ

Please refer to the APPENDIX B

Remark:

- (1) Distance extrapolation factor = $40 \log (\text{specific distance} / \text{test distance})$ (dB).
- (2) Limit line = specific limits (dBuV) + distance extrapolation factor.

4.7 TEST RESULTS - 30 MHZ TO 1000 MHZ

Please refer to the APPENDIX C.

4.8 TEST RESULTS - ABOVE 1000 MHZ

Please refer to the APPENDIX D.

Remark:

- (1) No limit: This is fundamental signal, the judgment is not applicable.
For fundamental signal judgment was referred to Peak output test.

5. BANDWIDTH TEST

5.1 LIMIT

FCC Part15, Subpart C (15.247)		
Section	Test Item	Limit
15.247(a)(2)	6 dB Bandwidth	Minimum 500 kHz
	99% Emission Bandwidth	-

5.2 TEST PROCEDURE

- a. The EUT was directly connected to the spectrum analyzer and antenna output port as show in the block diagram below.
- b. Spectrum Setting:
 - For 6 dB Bandwidth: RBW= 100 kHz, VBW=300 kHz, Sweep time = auto.
 - For 99% Emission Bandwidth B/G/N-20/vht20/AX-20 Mode: RBW= 300 KHz, VBW=1 MHz, Sweep time = 2.5 ms.
 - For 99% Emission Bandwidth N-40/vht40/AX-40 Mode: RBW= 1 MHz, VBW=3 MHz, Sweep time = 2.5 ms.
- c. The bandwidth was performed in accordance with method 11.8.1 of ANSI C63.10-2013.

5.3 DEVIATION FROM STANDARD

No deviation.

5.4 TEST SETUP

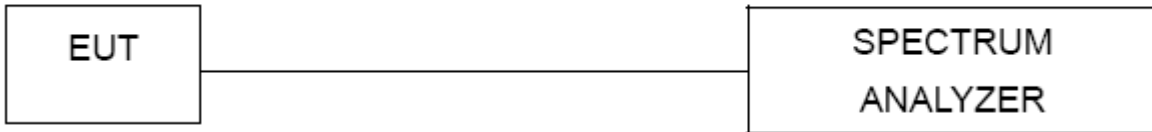

5.5 EUT OPERATION CONDITIONS

The EUT was programmed to be in continuously transmitting mode.

5.6 TEST RESULTS

Please refer to the APPENDIX E.

6. MAXIMUM OUTPUT POWER TEST

6.1 LIMIT

FCC Part15, Subpart C (15.247)		
Section	Test Item	Limit
15.247(b)(3)	Maximum Output Power	1 Watt or 30dBm

6.2 TEST PROCEDURE

- The EUT was directly connected to the power meter and antenna output port as show in the block diagram below.
- The maximum conducted output power was performed in accordance with method 11.9.1.3 and 11.9.2.3.1 of ANSI C63.10-2013.

6.3 DEVIATION FROM STANDARD

No deviation.

6.4 TEST SETUP



6.5 EUT OPERATION CONDITIONS

The EUT was programmed to be in continuously transmitting mode.

6.6 TEST RESULTS

Please refer to the APPENDIX F.

7. CONDUCTED SPURIOUS EMISSIONS

7.1 LIMIT

In any 100 kHz bandwidth outside the frequency band in which the spread spectrum or digitally modulated intentional radiator is operating, the radio frequency power that is produced by the intentional radiator shall be at least 20 dB below that in the 100 kHz bandwidth within the band that contains the highest level of the desired power, based on either an RF conducted or a radiated measurement, provided the transmitter demonstrates compliance with the peak Output Power limits. If the transmitter complies with the Output Power limits based on the use of RMS averaging over a time interval, as permitted under paragraph (b)(3) of this section, the attenuation required under this paragraph shall be 30 dB instead of 20 dB. Attenuation below the general limits specified in Section 15.209(a) is not required.

7.2 TEST PROCEDURE

- a. The EUT was directly connected to the spectrum analyzer and antenna output port as show in the block diagram below.
- b. Spectrum Setting: RBW= 100 kHz, VBW=300 kHz, Sweep time = Auto.

7.3 DEVIATION FROM STANDARD

No deviation.

7.4 TEST SETUP

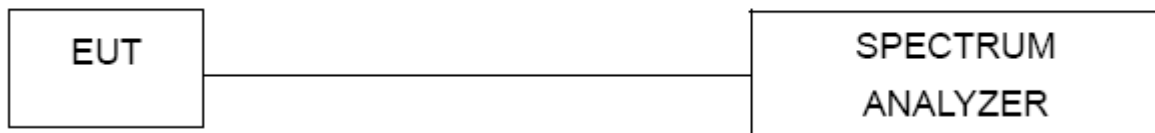

7.5 EUT OPERATION CONDITIONS

The EUT was programmed to be in continuously transmitting mode.

7.6 TEST RESULTS

Please refer to the APPENDIX G.

8. POWER SPECTRAL DENSITY TEST

8.1 LIMIT

FCC Part15, Subpart C (15.247)		
Section	Test Item	Limit
15.247(e)	Power Spectral Density	8 dBm (in any 3 kHz)

8.2 TEST PROCEDURE

- The EUT was directly connected to the spectrum analyzer and antenna output port as show in the block diagram below.
- Spectrum Setting: RBW=3 kHz, VBW=10 kHz, Sweep time = Auto.
- The Power Spectral Density was performed in accordance with method 11.10.2 of ANSI C63.10-2013.

8.3 DEVIATION FROM STANDARD

No deviation.

8.4 TEST SETUP

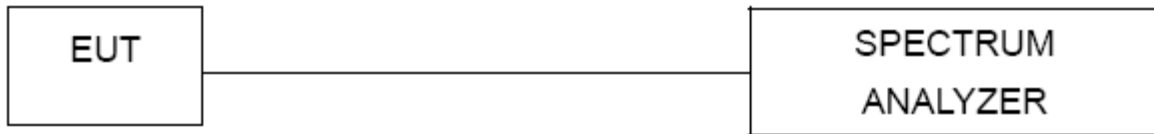

8.5 EUT OPERATION CONDITIONS

The EUT was programmed to be in continuously transmitting mode.

8.6 TEST RESULTS

Please refer to the APPENDIX H.

9. MEASUREMENT INSTRUMENTS LIST

AC Power Line Conducted Emissions					
Item	Kind of Equipment	Manufacturer	Type No.	Serial No.	Calibrated until
1	EMI Test Receiver	R&S	ESCI	100382	Feb. 28, 2021
2	LISN	EMCO	3816/2	52765	Mar. 01, 2021
3	TWO-LINE V-NETWORK	R&S	ENV216	101447	Feb. 28, 2021
4	50Ω Terminator	SHX	TF5-3	15041305	Mar. 01, 2021
5	Measurement Software	Farad	EZ-EMC Ver.NB-03A1-01	N/A	N/A
6	Cable	N/A	RG223	12m	Mar. 10, 2021
7	643 Shield Room	ETS	6*4*3m	N/A	N/A

Radiated Emissions - 9 kHz to 30 MHz					
Item	Kind of Equipment	Manufacturer	Type No.	Serial No.	Calibrated until
1	Antenna	EM	EM-6876-1	230	Apr. 16, 2021
2	Cable	N/A	RG 213/U	N/A	May 29, 2021
3	EMI Test Receiver	R&S	ESCI	100895	Feb. 28, 2021
4	Measurement Software	Farad	EZ-EMC Ver.NB-03A1-01	N/A	N/A
5	966 Chambe Room	RM	9*6*6m	N/A	Jul. 25, 2021

Radiated Emissions - 30 MHz to 1 GHz					
Item	Kind of Equipment	Manufacturer	Type No.	Serial No.	Calibrated until
1	Antenna	Schwarzbeck	VULB9160	9160-3232	Mar. 09, 2021
2*	Amplifier	HP	8447D	2944A09673	Aug. 11, 2021
3	Receiver	Agilent	N9038A	MY52130039	Jul. 25, 2021
4	Cable	emci	LMR-400(30MHz-1 GHz)(8m+5m)	N/A	May 22, 2021
5	Controller	CT	SC100	N/A	N/A
6	Controller	MF	MF-7802	MF780208416	N/A
7	Measurement Software	Farad	EZ-EMC Ver.NB-03A1-01	N/A	N/A
8	966 Chambe Room	RM	9*6*6m	N/A	Jul. 25, 2021

Radiated Emissions - Above 1 GHz					
Item	Kind of Equipment	Manufacturer	Type No.	Serial No.	Calibrated until
1	Double Ridged Guide Antenna	ETS	3115	75789	May 12, 2021
2	Broad-Band Horn Antenna	Schwarzbeck	BBHA 9170	9170319	Jul. 07, 2021
3	Amplifier	Agilent	8449B	3008A02333	Mar. 01, 2021
4	Microwave Preamplifier With Adaptor	EMC INSTRUMENT	EMC2654045	980039 & HA01	Mar. 07, 2021
5	Receiver	Agilent	N9038A	MY52130039	Jul. 25, 2021
6	Controller	CT	SC100	N/A	N/A
7	Controller	MF	MF-7802	MF780208416	N/A
8	Cable	N/A	EMC104-SM-SM-6000	N/A	May 09, 2021
9	Measurement Software	Farad	EZ-EMC Ver.NB-03A1-01	N/A	N/A
10	Filter	STI	STI15-9912	N/A	Jul. 25, 2021
11	966 Chambe Room	RM	9*6*6m	N/A	Jul. 25, 2021

Bandwidth & Antenna Conducted Spurious Emissions & Power Spectral Density					
Item	Kind of Equipment	Manufacturer	Type No.	Serial No.	Calibrated until
1	Spectrum Analyzer	R&S	FSP40	100185	Jul. 25, 2021
2	RF Cable	Tongkaichuan	N/A	N/A	N/A
3	DC Block	Mini	N/A	N/A	N/A
4	Attenuator	WOKEN	6SM3502	VAS1214NL	Feb. 11, 2021

Maximum Output Power					
Item	Kind of Equipment	Manufacturer	Type No.	Serial No.	Calibrated until
1	Peak Power Analyzer	Keysight	8990B	MY51000506	Aug. 07, 2021
2	Wideband power sensor	Keysight	N1923A	MY58310004	Jul. 25, 2021
3	Attenuator	WOKEN	6SM3502	VAS1214NL	Feb. 11, 2021
4	RF Cable	Tongkaichuan	N/A	N/A	N/A

Remark: "N/A" denotes no model name, serial no. or calibration specified.

"**" calibration period of equipment list is three year.

Except * item, all calibration period of equipment list is one year.

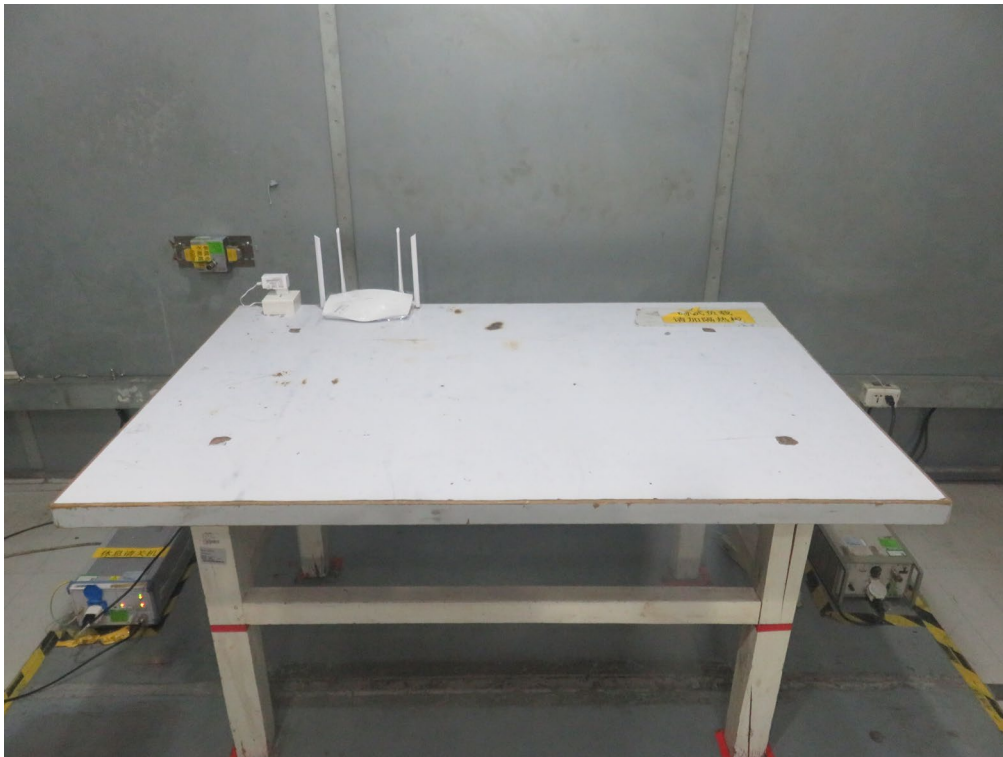
10. EUT TEST PHOTO**AC Power Line Conducted Emissions Test Photos**

Radiated Emissions Test Photos**9 kHz to 30 MHz**

Radiated Emissions Test Photos

30 MHz to 1 GHz

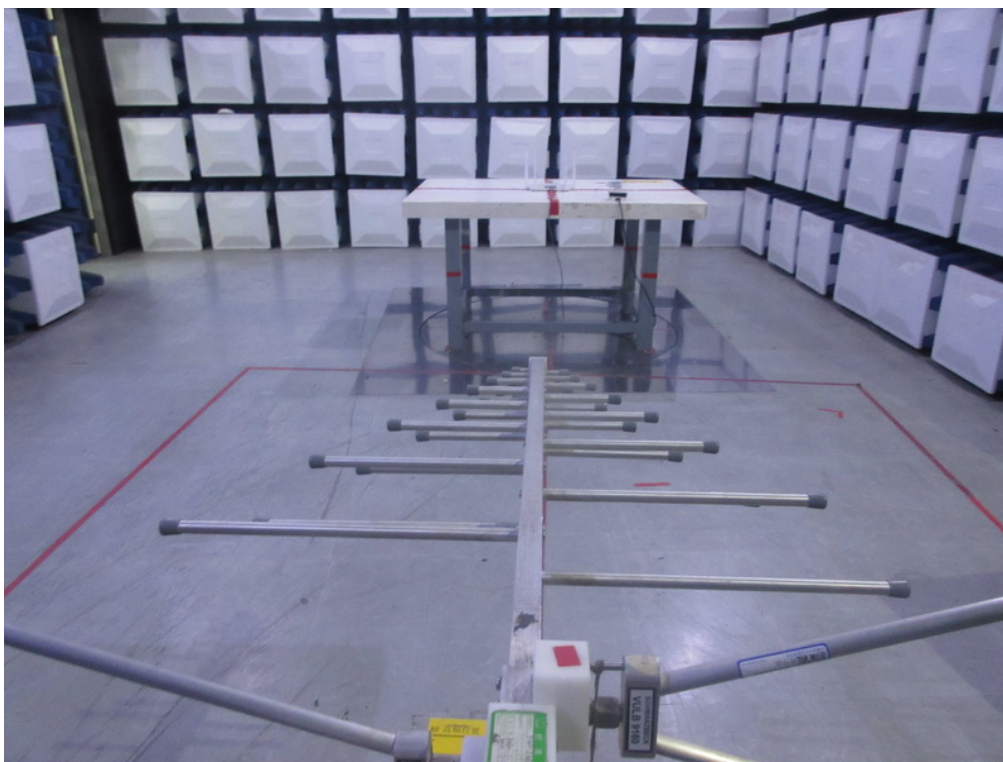
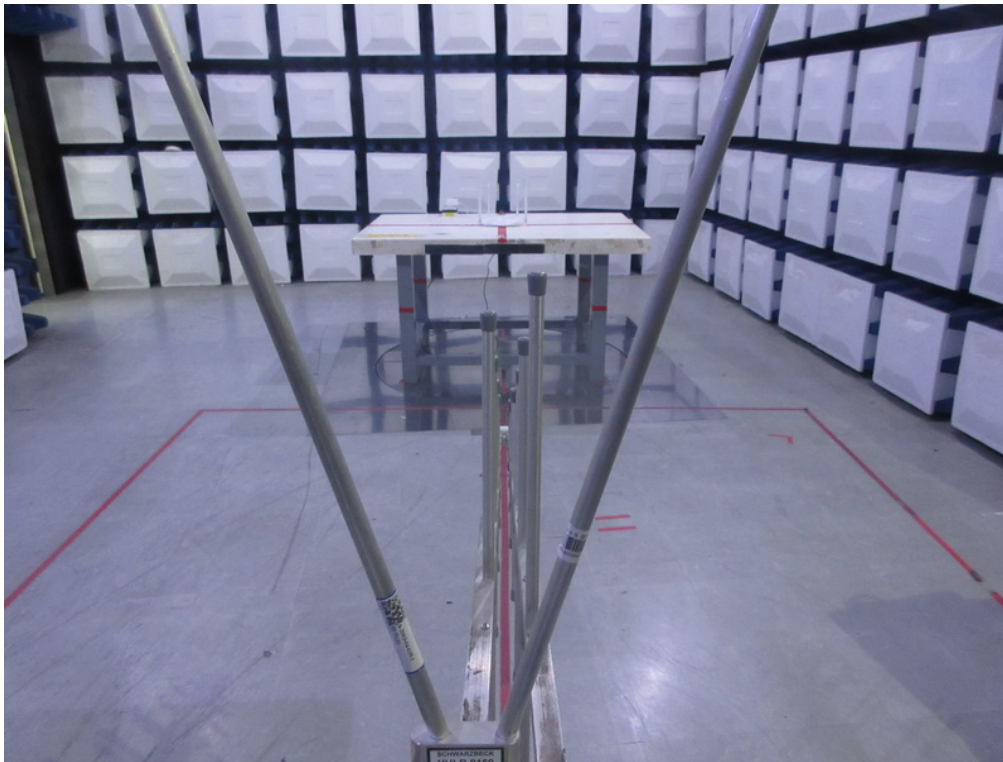

Radiated Emissions Test Photos

Above 1 GHz



APPENDIX A - AC POWER LINE CONDUCTED EMISSIONS

Test Voltage	AC 120V/60Hz
Test Mode:	TX N20 Mode Channel 01

Line

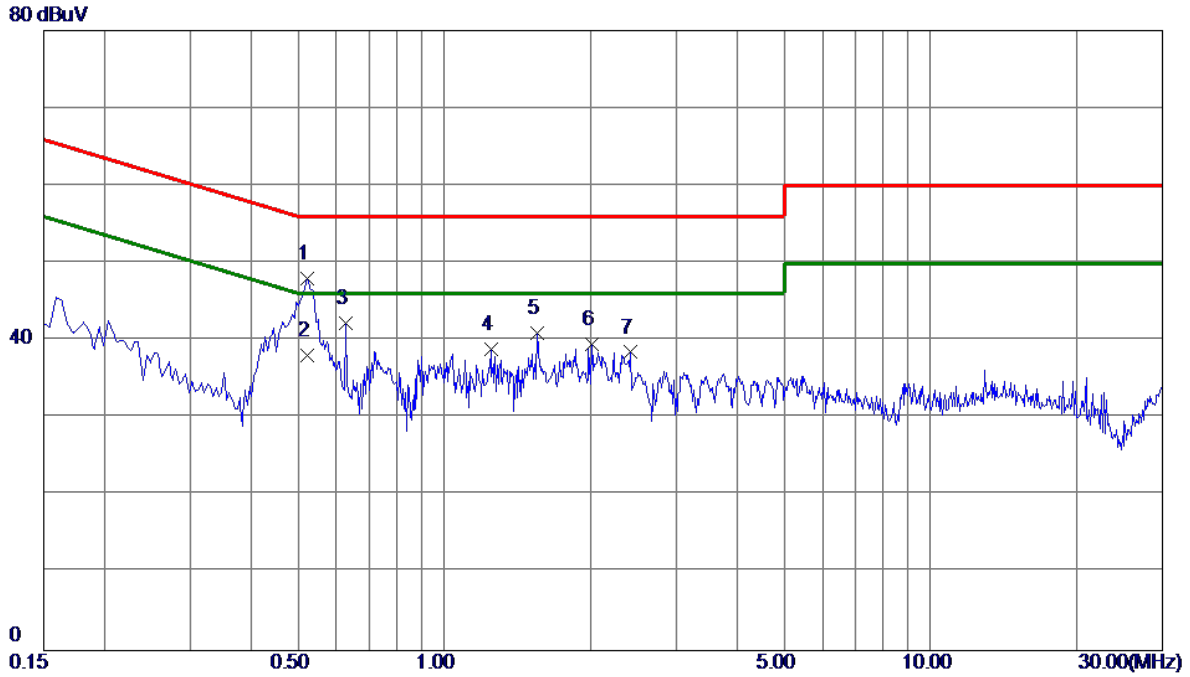

No.	Freq. MHz	Reading Level dBuV	Correct Factor dB	Measure ment dBuV	Limit dBuV	Margin dB	Detector	Comment
1	0.5235	38.08	9.95	48.03	56.00	-7.97	Peak	
2 *	0.5235	28.20	9.95	38.15	46.00	-7.85	AVG	
3	0.6270	32.24	9.94	42.18	56.00	-13.82	Peak	
4	1.2480	28.88	10.03	38.91	56.00	-17.09	Peak	
5	1.5540	30.90	10.05	40.95	56.00	-15.05	Peak	
6	2.0085	29.42	10.09	39.51	56.00	-16.49	Peak	
7	2.4135	28.35	10.13	38.48	56.00	-17.52	Peak	

REMARKS:

- (1) Measurement Value = Reading Level + Correct Factor.
- (2) Margin Level = Measurement Value - Limit Value.

Test Voltage	AC 120V/60Hz
Test Mode:	TX N20 Mode Channel 01

Neutral

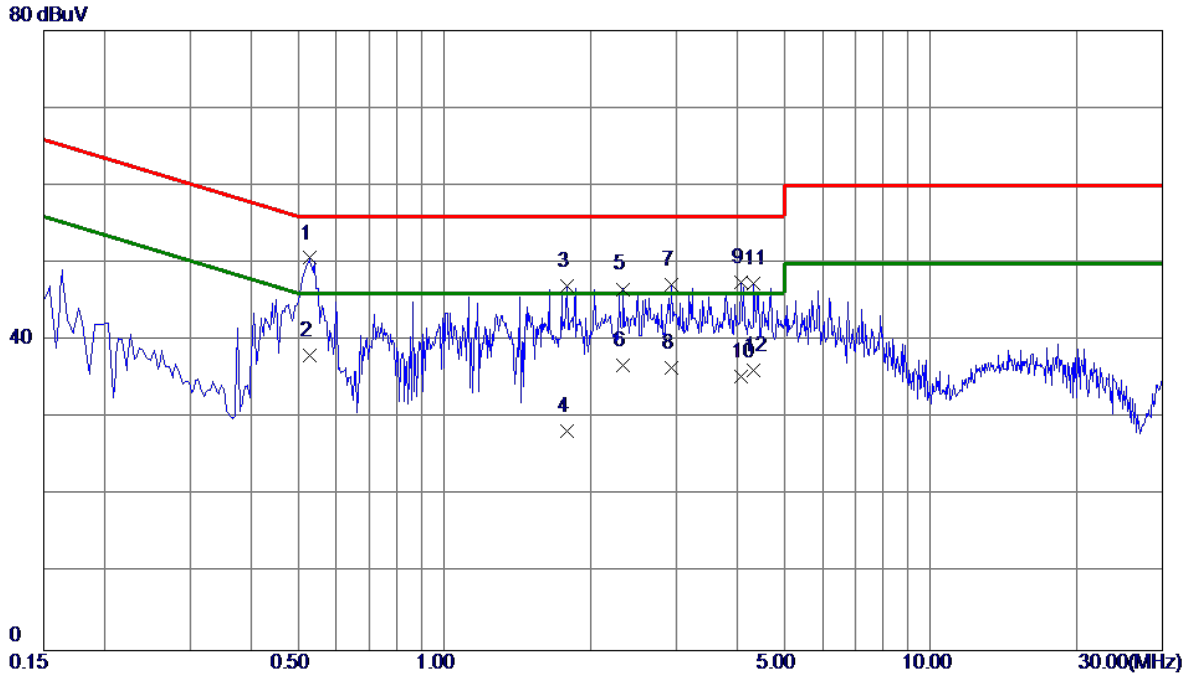

No.	Freq. MHz	Reading Level dBuV	Correct Factor dB	Measure ment dBuV	Limit dBuV	Margin dB	Detector	Comment
1 *	0.5280	40.49	10.15	50.64	56.00	-5.36	Peak	
2	0.5280	28.00	10.15	38.15	46.00	-7.85	AVG	
3	1.7835	36.70	10.40	47.10	56.00	-8.90	Peak	
4	1.7835	17.99	10.40	28.39	46.00	-17.61	AVG	
5	2.3370	36.19	10.45	46.64	56.00	-9.36	Peak	
6	2.3370	26.30	10.45	36.75	46.00	-9.25	AVG	
7	2.9355	36.76	10.51	47.27	56.00	-8.73	Peak	
8	2.9355	25.91	10.51	36.42	46.00	-9.58	AVG	
9	4.0875	36.90	10.60	47.50	56.00	-8.50	Peak	
10	4.0875	24.69	10.60	35.29	46.00	-10.71	AVG	
11	4.3260	36.72	10.62	47.34	56.00	-8.66	Peak	
12	4.3260	25.59	10.62	36.21	46.00	-9.79	AVG	

REMARKS:

- (1) Measurement Value = Reading Level + Correct Factor.
- (2) Margin Level = Measurement Value - Limit Value.

Test Voltage	AC 230V/50Hz
Test Mode:	TX N20 Mode Channel 01

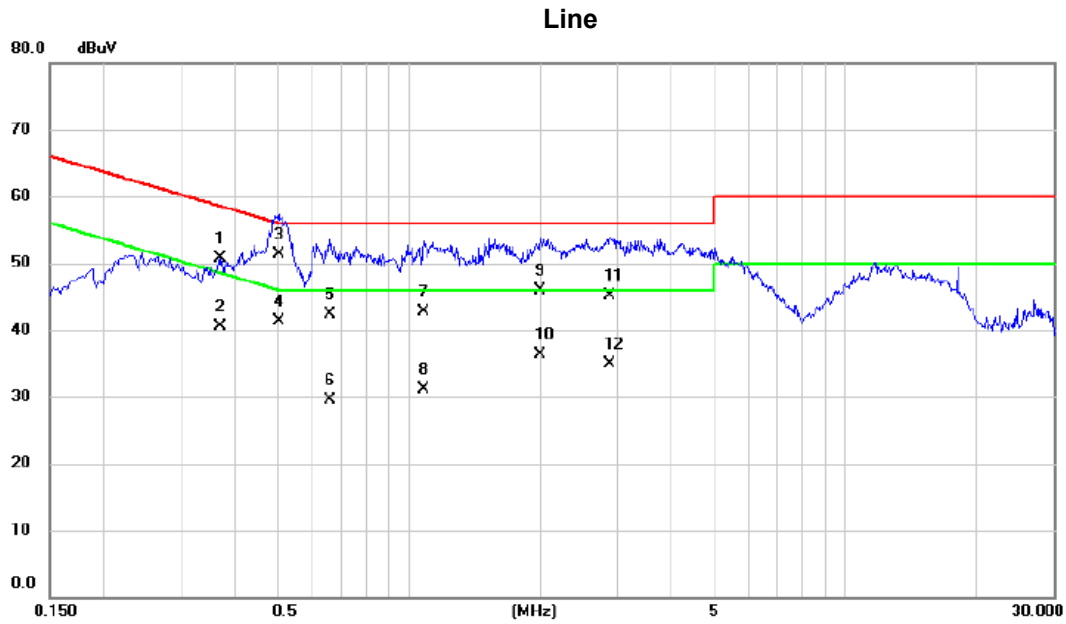

No. Mk.	Freq. MHz	Reading Level dBuV	Correct Factor dB	Measurement dBuV	Limit dBuV	Margin dB	Detector	Comment
1	0.3704	40.56	10.12	50.68	58.49	-7.81	QP	
2	0.3704	30.40	10.12	40.52	48.49	-7.97	AVG	
3	0.5032	41.10	10.13	51.23	56.00	-4.77	QP	
4 *	0.5032	31.20	10.13	41.33	46.00	-4.67	AVG	
5	0.6607	32.20	10.15	42.35	56.00	-13.65	QP	
6	0.6607	19.40	10.15	29.55	46.00	-16.45	AVG	
7	1.0837	32.60	10.19	42.79	56.00	-13.21	QP	
8	1.0837	21.00	10.19	31.19	46.00	-14.81	AVG	
9	1.9928	35.60	10.25	45.85	56.00	-10.15	QP	
10	1.9928	26.10	10.25	36.35	46.00	-9.65	AVG	
11	2.8883	34.70	10.32	45.02	56.00	-10.98	QP	
12	2.8883	24.60	10.32	34.92	46.00	-11.08	AVG	

REMARKS:

(1) Measurement Value = Reading Level + Correct Factor.

(2) Margin Level = Measurement Value - Limit Value.

Test Voltage	AC 230V/50Hz
Test Mode:	TX N20 Mode Channel 01

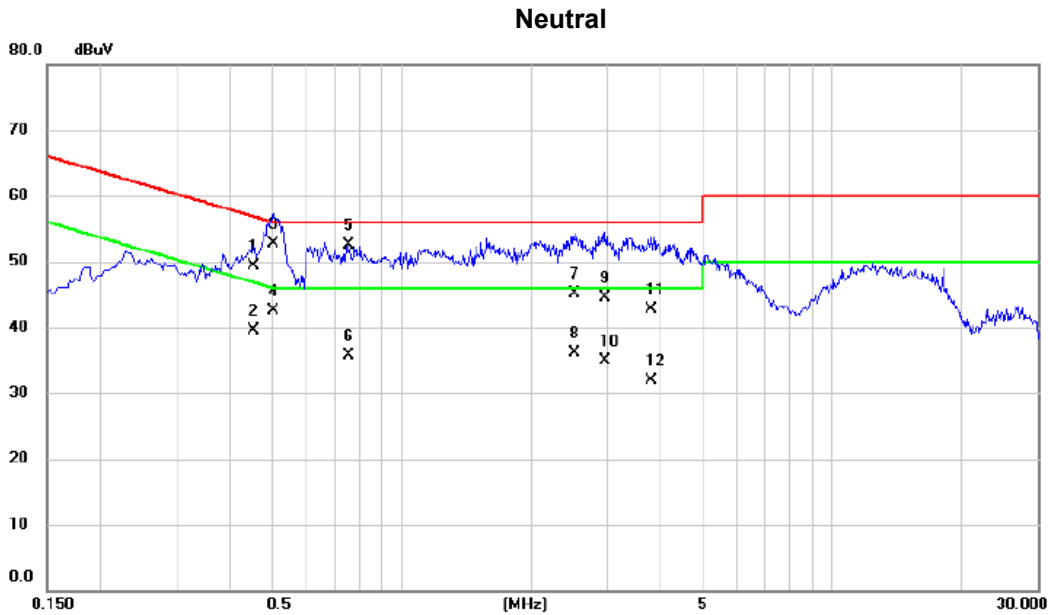

No.	Mk.	Freq. MHz	Reading Level dBuV	Correct Factor dB	Measure- ment dBuV	Limit dBuV	Margin dB	Detector	Comment
1		0.4537	39.30	10.05	49.35	56.81	-7.46	QP	
2		0.4537	29.50	10.05	39.55	46.81	-7.26	AVG	
3	*	0.5032	42.60	10.05	52.65	56.00	-3.35	QP	
4		0.5032	32.50	10.05	42.55	46.00	-3.45	AVG	
5		0.7552	42.37	10.08	52.45	56.00	-3.55	QP	
6		0.7552	25.60	10.08	35.68	46.00	-10.32	AVG	
7		2.5148	34.80	10.21	45.01	56.00	-10.99	QP	
8		2.5148	25.80	10.21	36.01	46.00	-9.99	AVG	
9		2.9603	34.20	10.24	44.44	56.00	-11.56	QP	
10		2.9603	24.60	10.24	34.84	46.00	-11.16	AVG	
11		3.7995	32.50	10.30	42.80	56.00	-13.20	QP	
12		3.7995	21.60	10.30	31.90	46.00	-14.10	AVG	

REMARKS:

- (1) Measurement Value = Reading Level + Correct Factor.
- (2) Margin Level = Measurement Value - Limit Value.

APPENDIX B - RADIATED EMISSION - 9 KHZ TO 30 MHZ

Test Mode: TX N20 Mode Channel 01

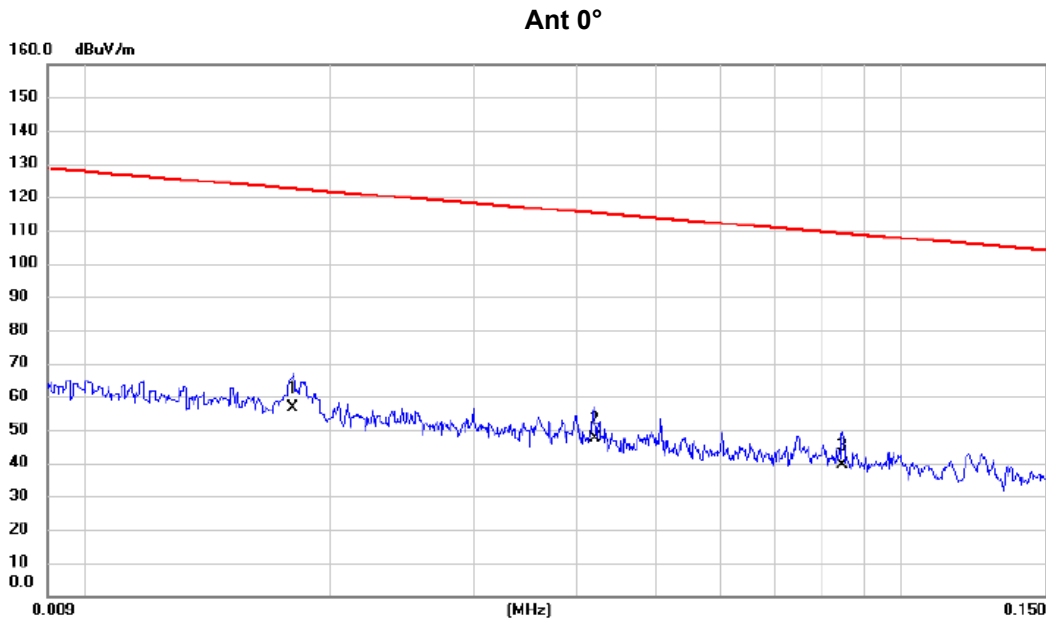

No.	Mk.	Freq. MHz	Reading Level dBuV	Correct Factor dB	Measure- ment dBuV/m	Limit dBuV/m	Margin dB	Detector	Comment
1	*	0.0180	42.58	13.84	56.42	122.50	-66.08	AVG	
2		0.0421	34.61	12.63	47.24	115.12	-67.88	AVG	
3		0.0847	26.74	12.63	39.37	109.05	-69.68	AVG	

REMARKS:

- (1) Measurement Value = Reading Level + Correct Factor.
- (2) Margin Level = Measurement Value - Limit Value.

Test Mode: TX N20 Mode Channel 01

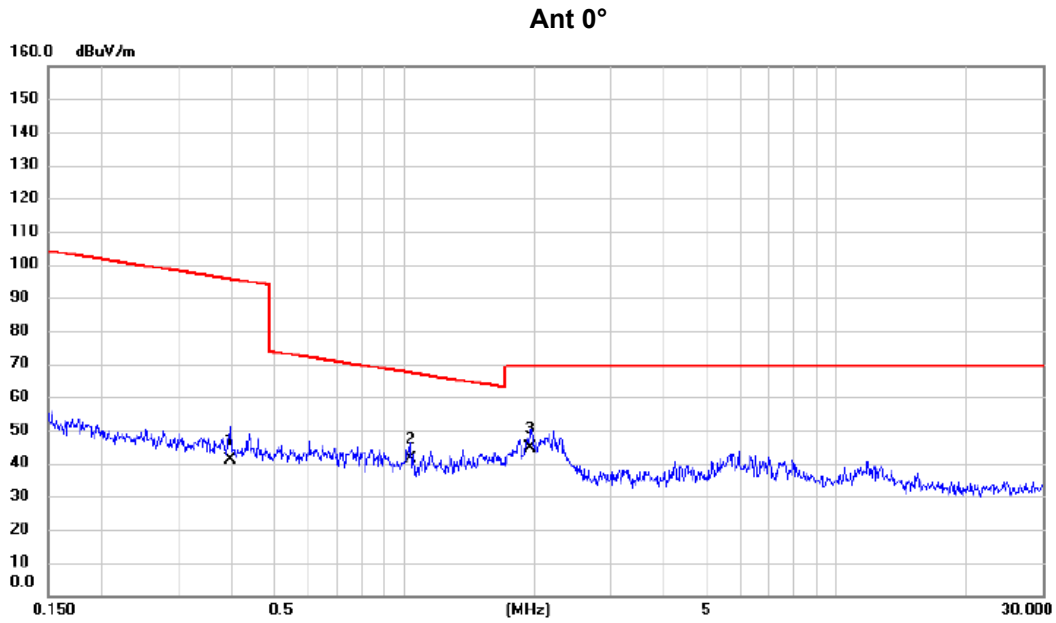

No.	Mk.	Freq. MHz	Reading Level dBuV	Correct Factor dB	Measure- ment dBuV/m	Limit dBuV/m	Margin dB	Detector	Comment
1		0.3976	28.69	12.27	40.96	95.62	-54.66	AVG	
2		1.0320	29.74	11.78	41.52	67.33	-25.81	QP	
3	*	1.9593	33.20	11.32	44.52	69.54	-25.02	QP	

REMARKS:

- (1) Measurement Value = Reading Level + Correct Factor.
- (2) Margin Level = Measurement Value - Limit Value.

Test Mode: TX N20 Mode Channel 01

Ant 90°

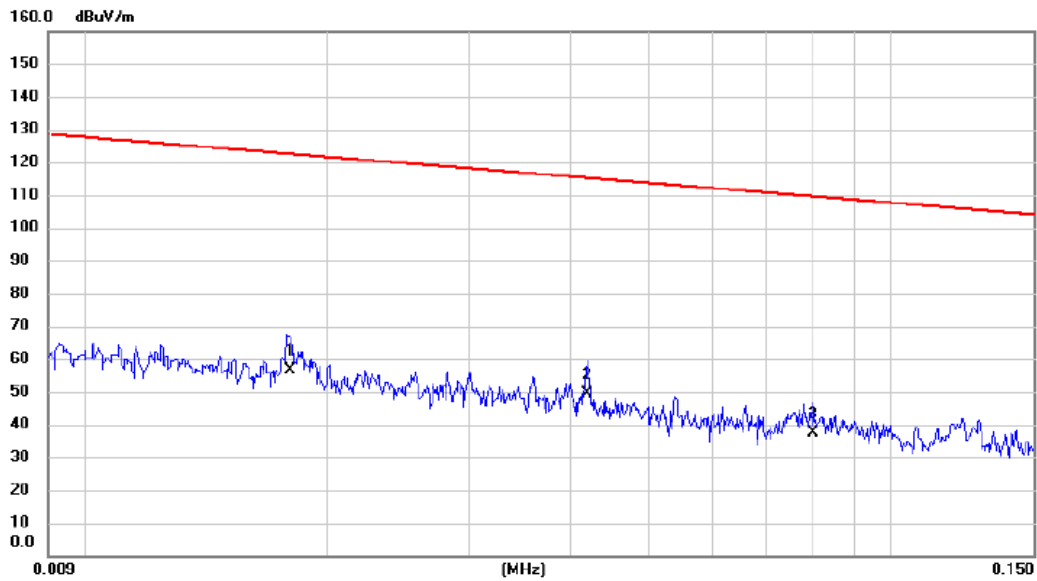

No.	Mk.	Freq. MHz	Reading Level dBuV	Correct Factor dB	Measure- ment dBuV/m	Limit dBuV/m	Margin dB	Detector	Comment
1		0.0180	42.88	13.84	56.72	122.50	-65.78	AVG	
2	*	0.0420	36.95	12.63	49.58	115.14	-65.56	AVG	
3		0.0801	24.78	12.60	37.38	109.53	-72.15	AVG	

REMARKS:

- (1) Measurement Value = Reading Level + Correct Factor.
- (2) Margin Level = Measurement Value - Limit Value.

Test Mode: TX N20 Mode Channel 01

Ant 90°

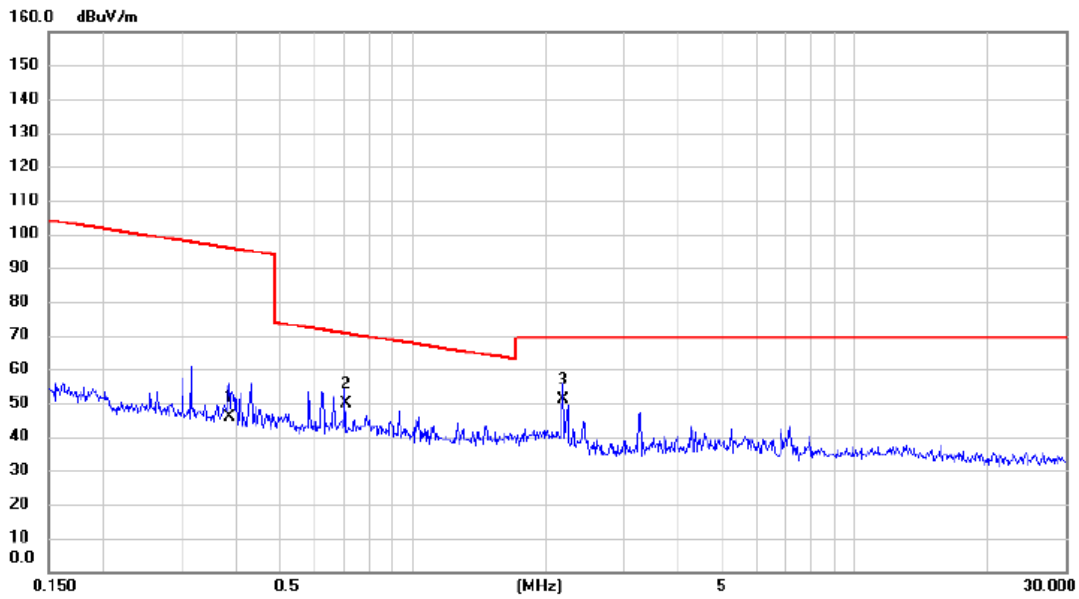

No.	Mk.	Freq. MHz	Reading Level dBuV	Correct Factor dB	Measure- ment dBuV/m	Limit dBuV/m	Margin dB	Detector	Comment
1		0.3852	33.59	12.29	45.88	95.89	-50.01	AVG	
2		0.7047	37.85	11.93	49.78	70.64	-20.86	QP	
3	*	2.1898	39.67	11.21	50.88	69.54	-18.66	QP	

REMARKS:

- (1) Measurement Value = Reading Level + Correct Factor.
- (2) Margin Level = Measurement Value - Limit Value.

APPENDIX C - RADIATED EMISSION - 30 MHZ TO 1000 MHZ

Test Mode: TX N20 Mode Channel 01

Vertical

80 dBuV/m

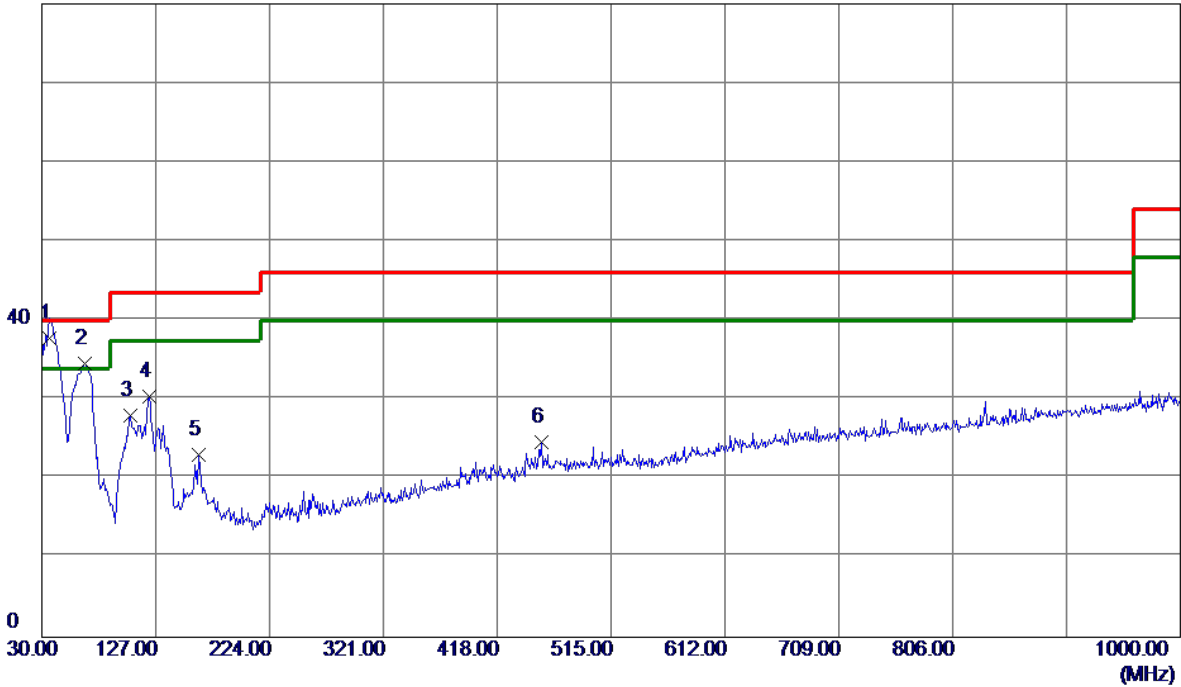

No.	Freq. MHz	Reading Level dBuV/m	Correct Factor dB	Measurement dBuV/m	Limit dBuV/m	Margin dB	Detector	Comment
1 *	36.7900	52.00	-14.28	37.72	40.00	-2.28	QP	
2	66.8600	49.78	-15.25	34.53	40.00	-5.47	Peak	
3	105.6600	42.50	-14.53	27.97	43.50	-15.53	Peak	
4	121.1800	43.20	-12.74	30.46	43.50	-13.04	Peak	
5	163.8600	34.28	-11.21	23.07	43.50	-20.43	Peak	
6	455.8300	32.25	-7.59	24.66	46.00	-21.34	Peak	

REMARKS:

- (1) Measurement Value = Reading Level + Correct Factor.
- (2) Margin Level = Measurement Value - Limit Value.

Test Mode: TX N20 Mode Channel 01

Horizontal

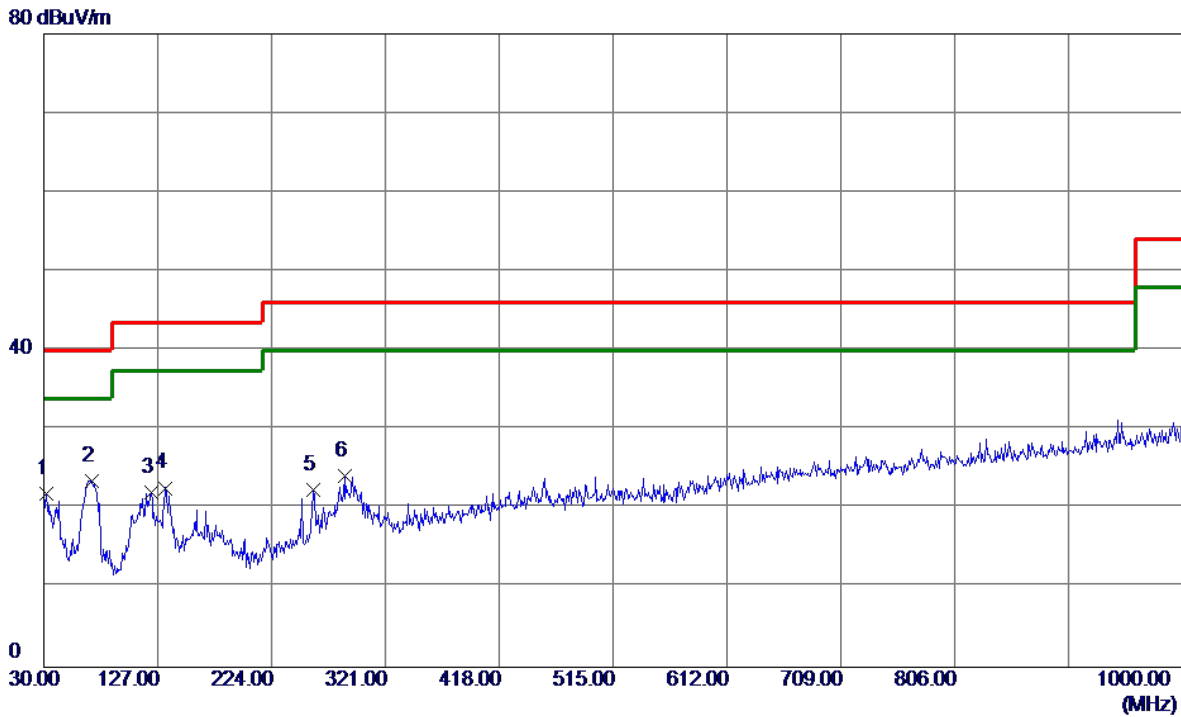

No.	Freq. MHz	Reading Level dBuV/m	Correct Factor dB	Measure ment dBuV/m	Limit dBuV/m	Margin dB	Detector	Comment
1	31.9400	36.39	-14.44	21.95	40.00	-18.05	Peak	
2 *	70.7400	39.59	-16.04	23.55	40.00	-16.45	Peak	
3	121.1800	34.87	-12.74	22.13	43.50	-21.37	Peak	
4	133.7899	35.31	-12.67	22.64	43.50	-20.86	Peak	
5	259.8900	34.59	-12.23	22.36	46.00	-23.64	Peak	
6	286.0799	35.92	-11.75	24.17	46.00	-21.83	Peak	

REMARKS:

- (1) Measurement Value = Reading Level + Correct Factor.
- (2) Margin Level = Measurement Value - Limit Value.

APPENDIX D - RADIATED EMISSION- ABOVE 1000 MHZ

Test Mode: TX B Mode 2412 MHz

Vertical

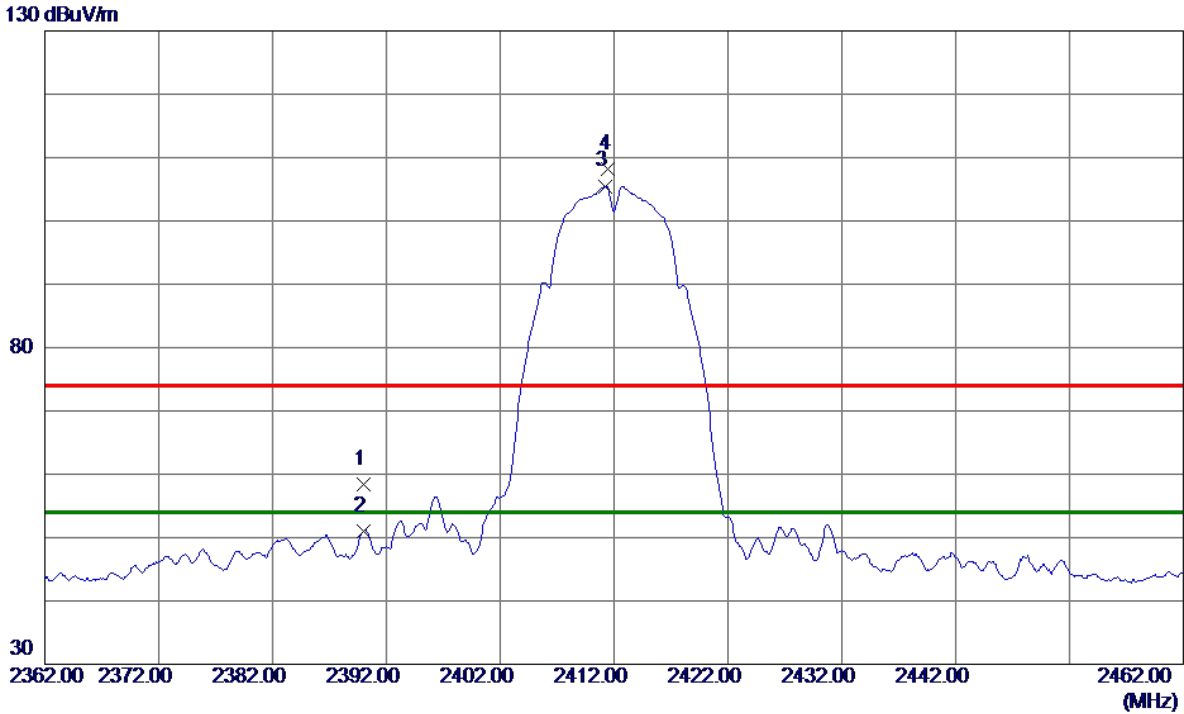

No.	Freq. MHz	Reading Level dBuV/m	Correct Factor dB	Measure ment dBuV/m	Limit dBuV/m	Margin dB	Detector	Comment
1	2390.0000	51.08	7.26	58.34	74.00	-15.66	Peak	
2	2390.0000	43.72	7.26	50.98	54.00	-3.02	AVG	
3 *	2411.2000	98.24	7.26	105.50	54.00	51.50	AVG	No Limit
4	2411.5000	100.98	7.26	108.24	74.00	34.24	Peak	No Limit

REMARKS:

- (1) Measurement Value = Reading Level + Correct Factor.
- (2) Margin Level = Measurement Value - Limit Value.

Test Mode: TX B Mode 2412 MHz

Vertical

80 dBuV/m

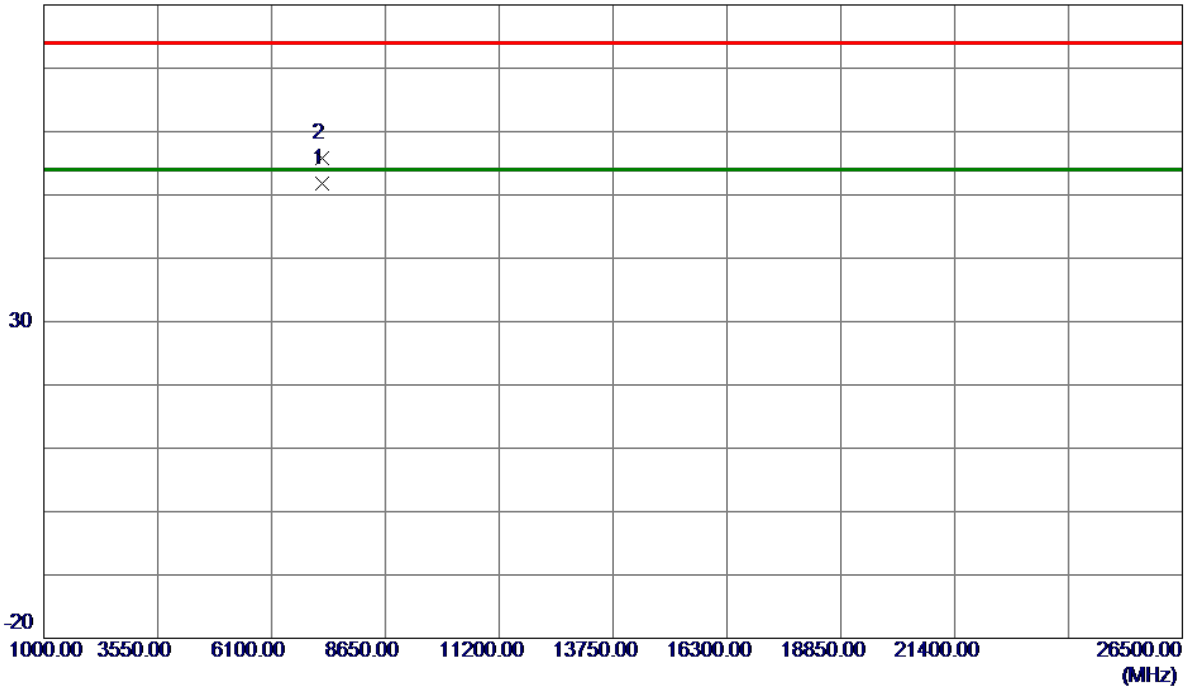

No.	Freq. MHz	Reading Level dBuV/m	Correct Factor dB	Measure ment dBuV/m	Limit dBuV/m	Margin dB	Detector	Comment
1 *	7234.9800	41.57	10.19	51.76	54.00	-2.24	AVG	
2	7235.0500	45.69	10.19	55.88	74.00	-18.12	Peak	

REMARKS:

- (1) Measurement Value = Reading Level + Correct Factor.
- (2) Margin Level = Measurement Value - Limit Value.

Test Mode: TX B Mode 2412 MHz

Horizontal

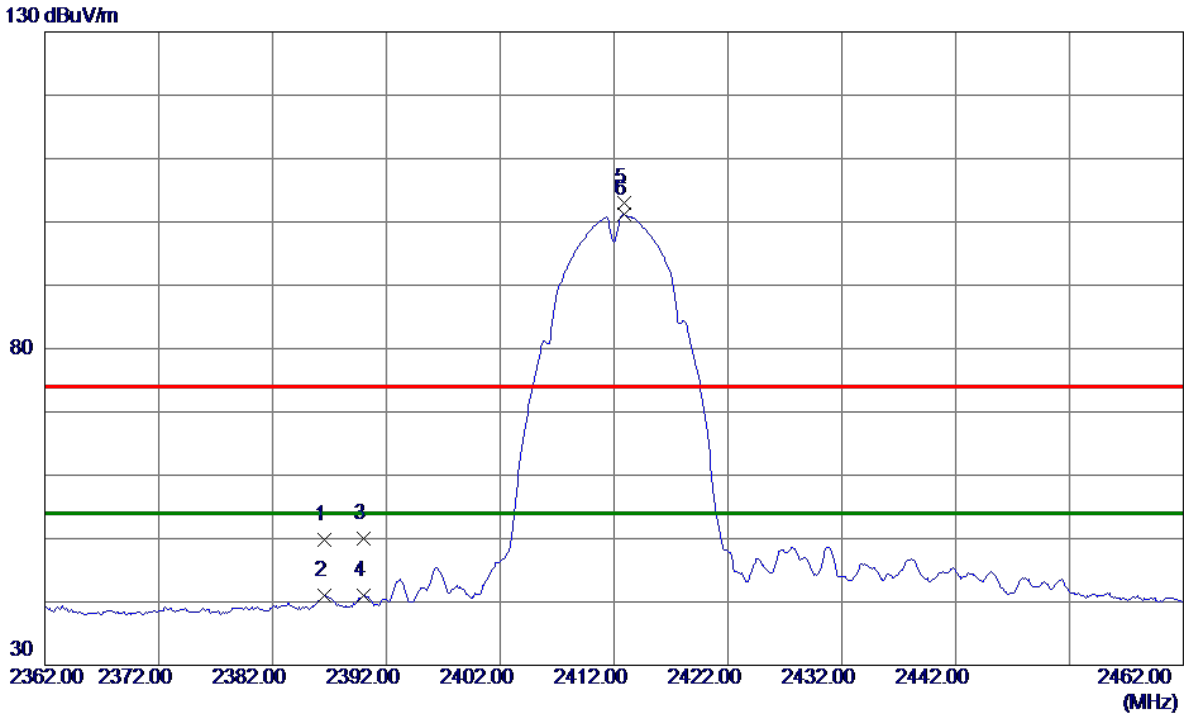

No.	Freq. MHz	Reading Level dBuV/m	Correct Factor dB	Measure ment dBuV/m	Limit dBuV/m	Margin dB	Detector	Comment
1	2386.6000	42.56	7.26	49.82	74.00	-24.18	Peak	
2	2386.6000	33.77	7.26	41.03	54.00	-12.97	AVG	
3	2390.0000	42.66	7.26	49.92	74.00	-24.08	Peak	
4	2390.0000	33.75	7.26	41.01	54.00	-12.99	AVG	
5	2412.9000	95.76	7.26	103.02	74.00	29.02	Peak	No Limit
6 *	2412.9000	93.92	7.26	101.18	54.00	47.18	AVG	No Limit

REMARKS:

- (1) Measurement Value = Reading Level + Correct Factor.
- (2) Margin Level = Measurement Value - Limit Value.

Test Mode: TX B Mode 2412 MHz

Horizontal

80 dBuV/m

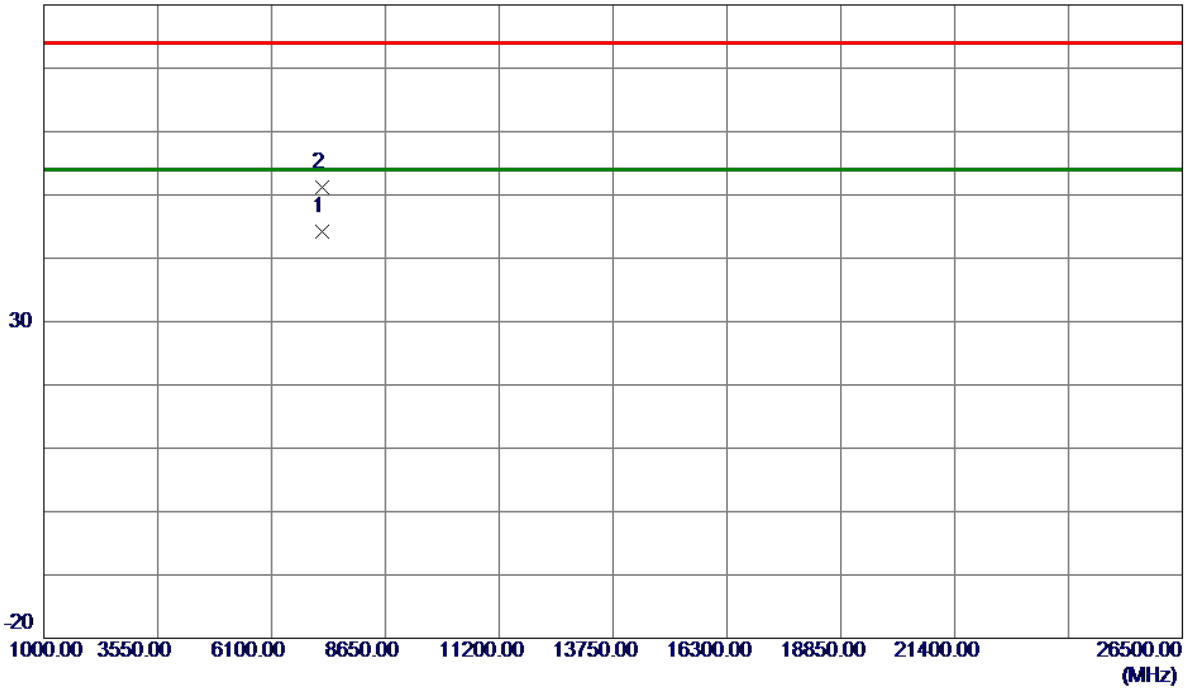

No.	Freq. MHz	Reading Level dBuV/m	Correct Factor dB	Measure ment dBuV/m	Limit dBuV/m	Margin dB	Detector	Comment
1 *	7235.0100	34.06	10.19	44.25	54.00	-9.75	AVG	
2	7236.3400	41.09	10.19	51.28	74.00	-22.72	Peak	

REMARKS:

- (1) Measurement Value = Reading Level + Correct Factor.
- (2) Margin Level = Measurement Value - Limit Value.

Test Mode: TX B Mode 2437 MHz

Vertical

130 dBuV/m

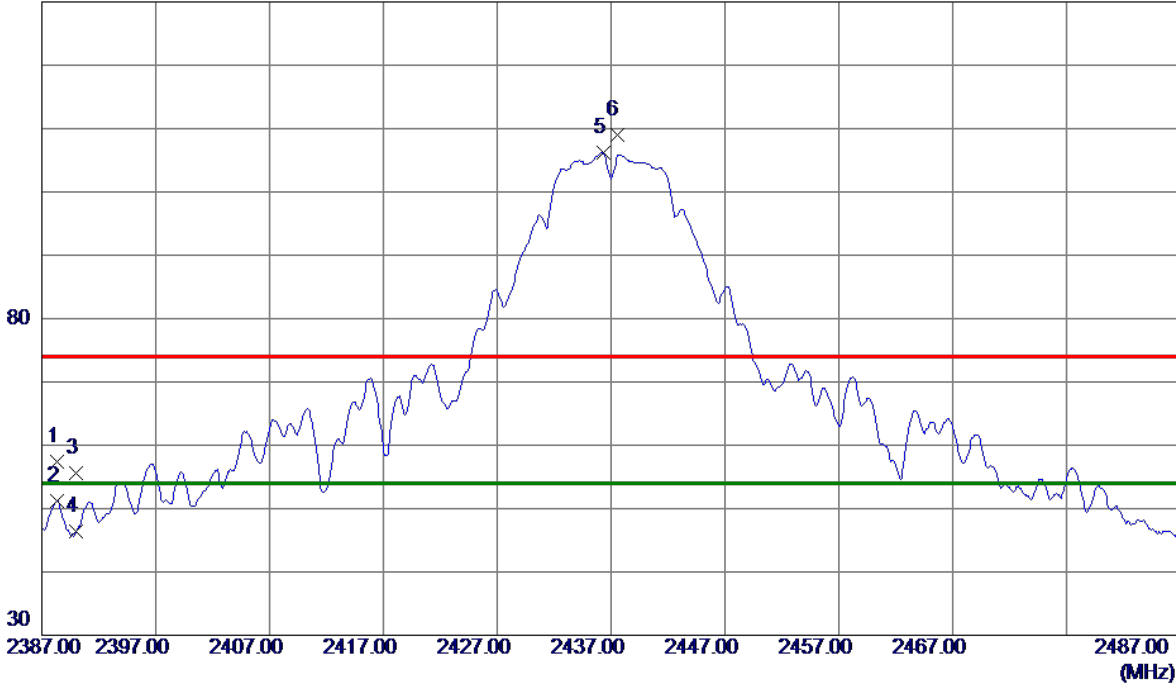

No.	Freq. MHz	Reading Level dBuV/m	Correct Factor dB	Measure ment dBuV/m	Limit dBuV/m	Margin dB	Detector	Comment
1	2388.3000	50.06	7.26	57.32	74.00	-16.68	Peak	
2	2388.3000	43.96	7.26	51.22	54.00	-2.78	AVG	
3	2390.0000	48.35	7.26	55.61	74.00	-18.39	Peak	
4	2390.0000	39.11	7.26	46.37	54.00	-7.63	AVG	
5 *	2436.3000	98.94	7.25	106.19	54.00	52.19	AVG	No Limit
6	2437.5000	101.72	7.25	108.97	74.00	34.97	Peak	No Limit

REMARKS:

- (1) Measurement Value = Reading Level + Correct Factor.
- (2) Margin Level = Measurement Value - Limit Value.

Test Mode: TX B Mode 2437 MHz

Vertical

80 dBuV/m

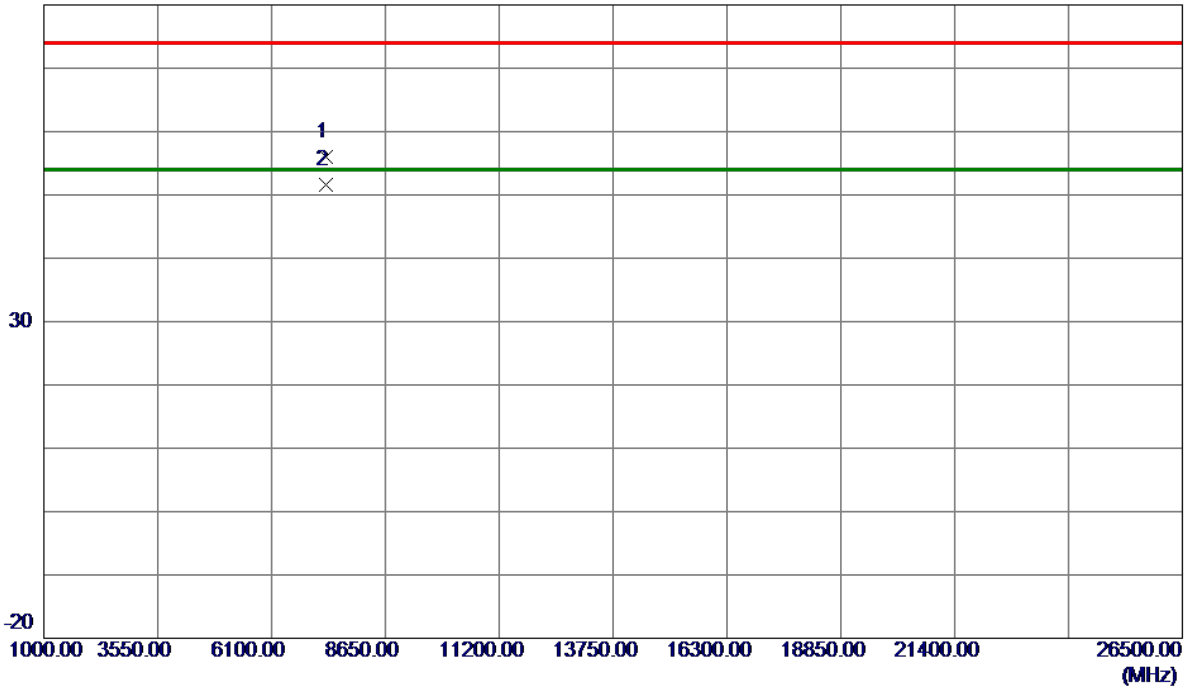

No.	Freq. MHz	Reading Level dBuV/m	Correct Factor dB	Measure ment dBuV/m	Limit dBuV/m	Margin dB	Detector	Comment
1	7310.2000	45.66	10.32	55.98	74.00	-18.02	Peak	
2 *	7310.2100	41.19	10.32	51.51	54.00	-2.49	AVG	

REMARKS:

- (1) Measurement Value = Reading Level + Correct Factor.
- (2) Margin Level = Measurement Value - Limit Value.

Test Mode: TX B Mode 2437 MHz

Horizontal

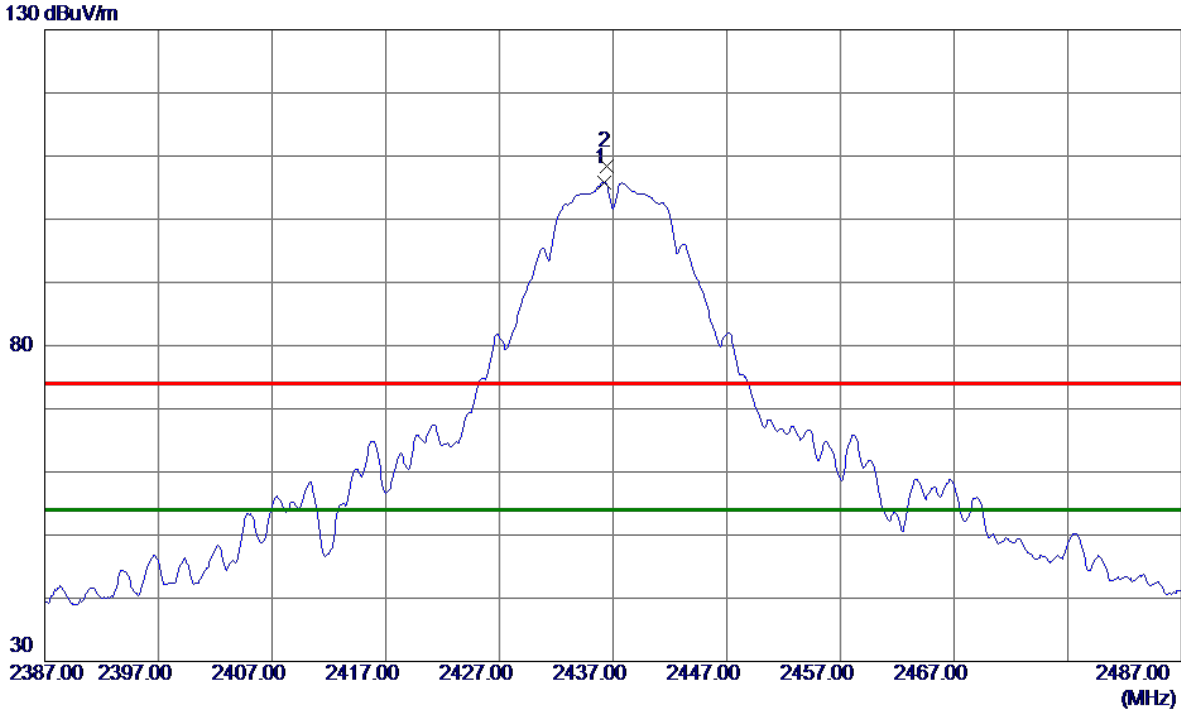

No.	Freq. MHz	Reading Level dBuV/m	Correct Factor dB	Measure ment dBuV/m	Limit dBuV/m	Margin dB	Detector	Comment
1 *	2436.2000	98.58	7.25	105.83	54.00	51.83	AVG	No Limit
2	2436.5000	101.22	7.25	108.47	74.00	34.47	Peak	No Limit

REMARKS:

- (1) Measurement Value = Reading Level + Correct Factor.
- (2) Margin Level = Measurement Value - Limit Value.

Test Mode: TX B Mode 2437 MHz

Horizontal

80 dBuV/m

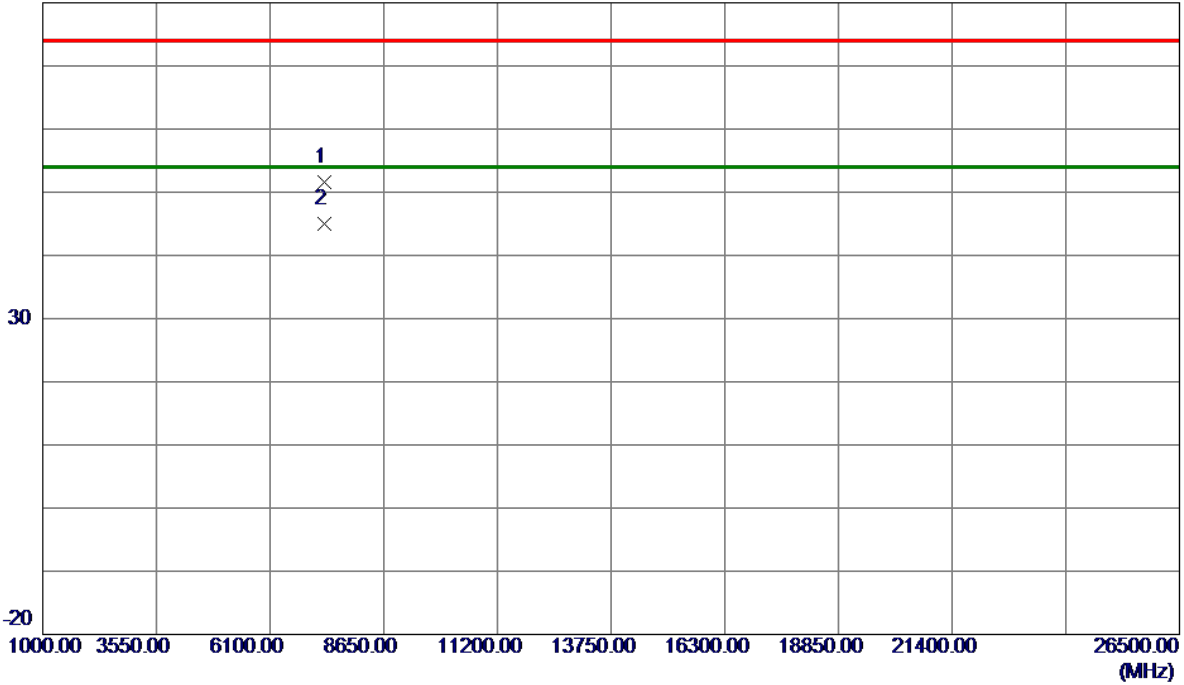

No.	Freq. MHz	Reading Level dBuV/m	Correct Factor dB	Measure ment dBuV/m	Limit dBuV/m	Margin dB	Detector	Comment
1	7310.0100	41.31	10.32	51.63	74.00	-22.37	Peak	
2 *	7310.0600	34.66	10.32	44.98	54.00	-9.02	AVG	

REMARKS:

(1) Measurement Value = Reading Level + Correct Factor.

(2) Margin Level = Measurement Value - Limit Value.

Test Mode: TX B Mode 2462 MHz

Vertical

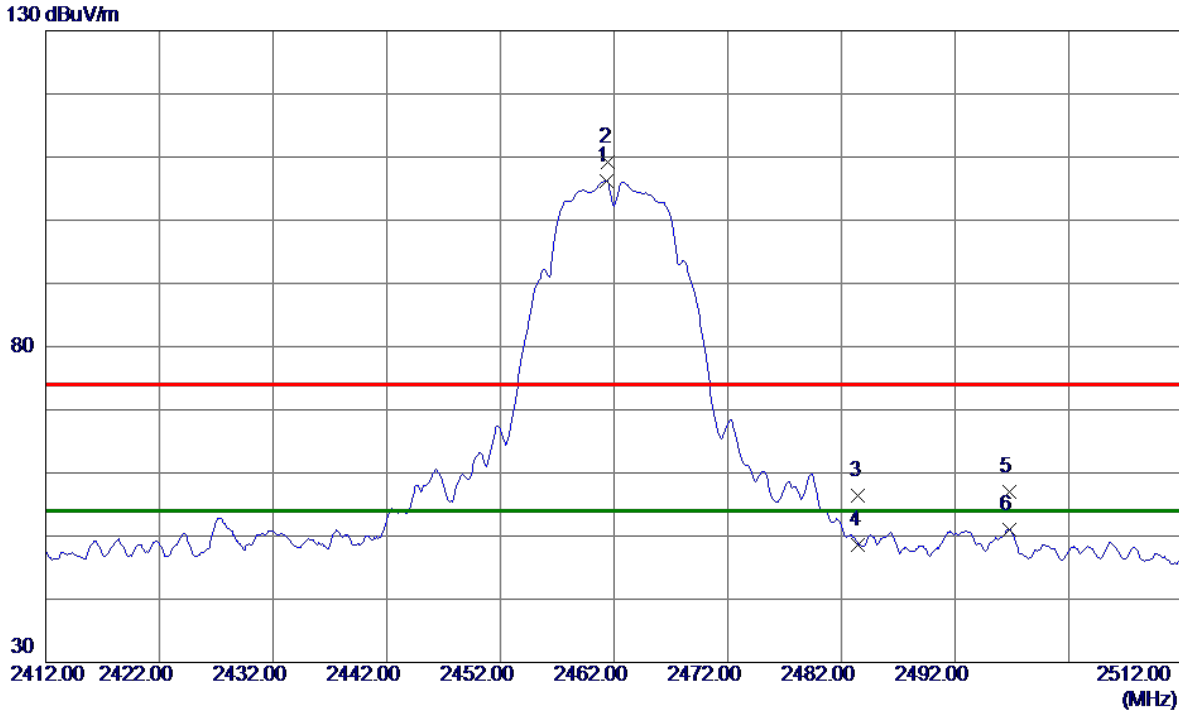

No.	Freq. MHz	Reading Level dBuV/m	Correct Factor dB	Measure ment dBuV/m	Limit dBuV/m	Margin dB	Detector	Comment
1 *	2461.3000	99.04	7.25	106.29	54.00	52.29	AVG	No Limit
2	2461.5000	101.88	7.25	109.13	74.00	35.13	Peak	No Limit
3	2483.5000	49.10	7.25	56.35	74.00	-17.65	Peak	
4	2483.5000	41.41	7.25	48.66	54.00	-5.34	AVG	
5	2496.8000	49.72	7.25	56.97	74.00	-17.03	Peak	
6	2496.8000	43.77	7.25	51.02	54.00	-2.98	AVG	

REMARKS:

- (1) Measurement Value = Reading Level + Correct Factor.
- (2) Margin Level = Measurement Value - Limit Value.

Test Mode: TX B Mode 2462 MHz

Vertical

80 dBuV/m

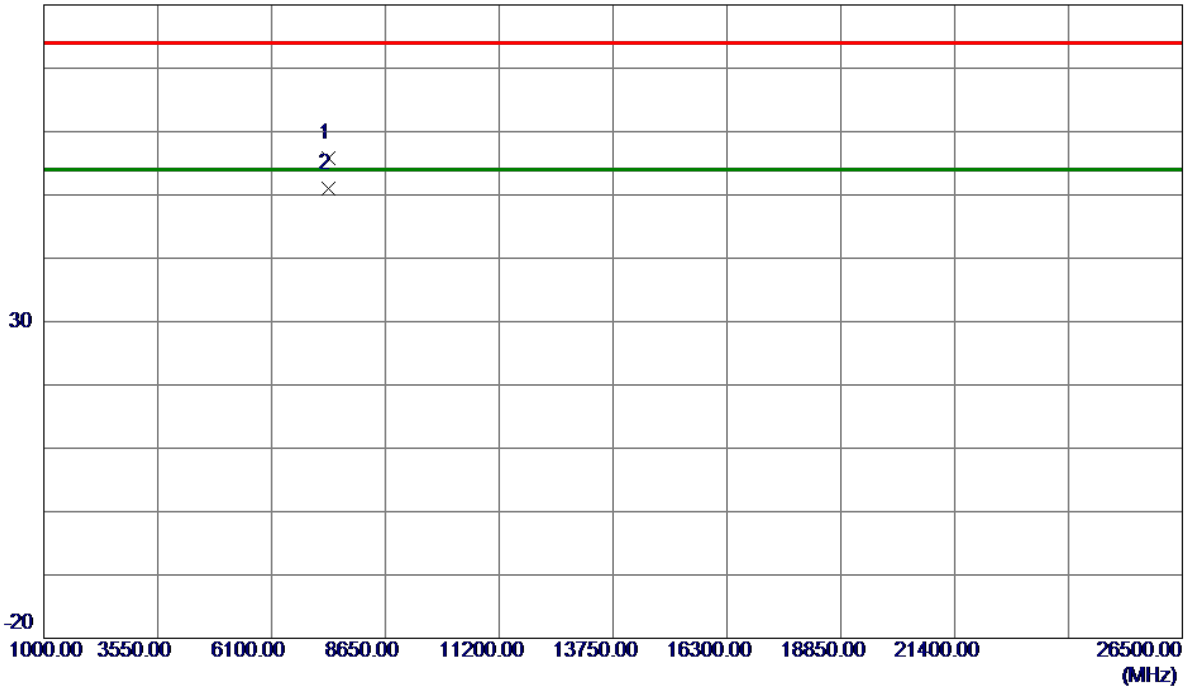

No.	Freq. MHz	Reading Level dBuV/m	Correct Factor dB	Measure ment dBuV/m	Limit dBuV/m	Margin dB	Detector	Comment
1	7385.1300	45.37	10.44	55.81	74.00	-18.19	Peak	
2 *	7386.7600	40.52	10.45	50.97	54.00	-3.03	AVG	

REMARKS:

- (1) Measurement Value = Reading Level + Correct Factor.
- (2) Margin Level = Measurement Value - Limit Value.

Test Mode: TX B Mode 2462 MHz

Horizontal

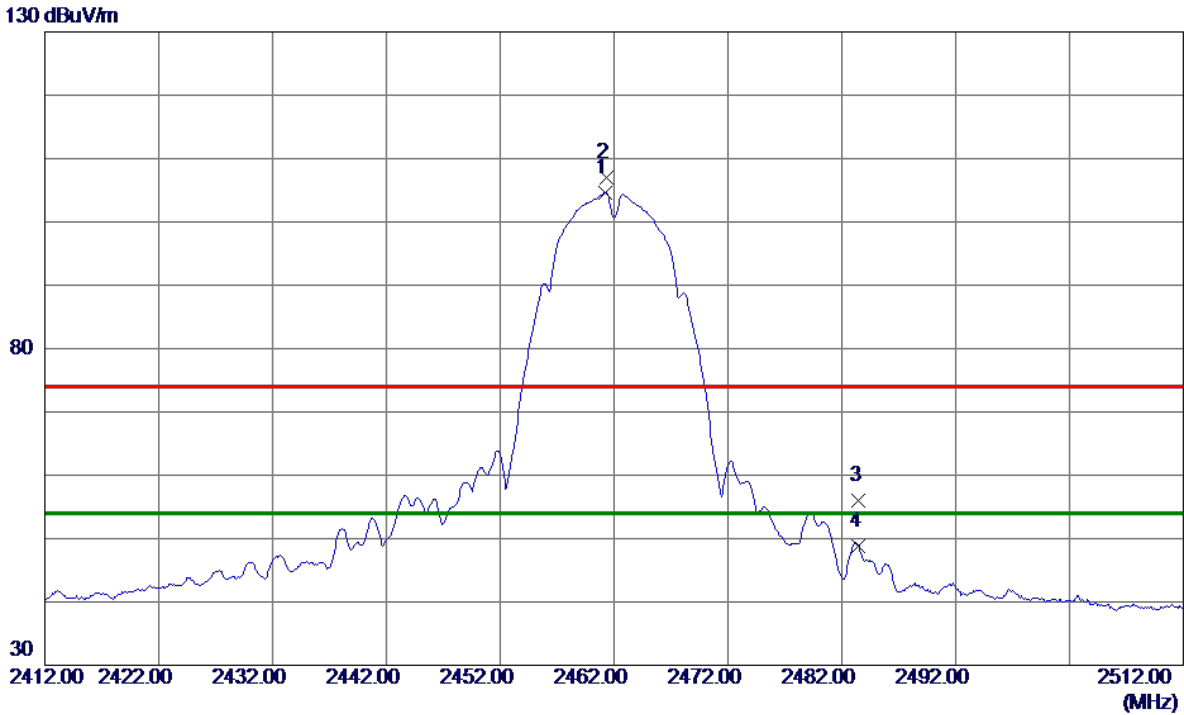

No.	Freq. MHz	Reading Level dBuV/m	Correct Factor dB	Measure ment dBuV/m	Limit dBuV/m	Margin dB	Detector	Comment
1 *	2461.2000	97.37	7.25	104.62	54.00	50.62	AVG	No Limit
2	2461.3000	99.69	7.25	106.94	74.00	32.94	Peak	No Limit
3	2483.5000	48.72	7.25	55.97	74.00	-18.03	Peak	
4	2483.5000	41.48	7.25	48.73	54.00	-5.27	AVG	

REMARKS:

- (1) Measurement Value = Reading Level + Correct Factor.
- (2) Margin Level = Measurement Value - Limit Value.

Test Mode: TX B Mode 2462 MHz

Horizontal

80 dBuV/m

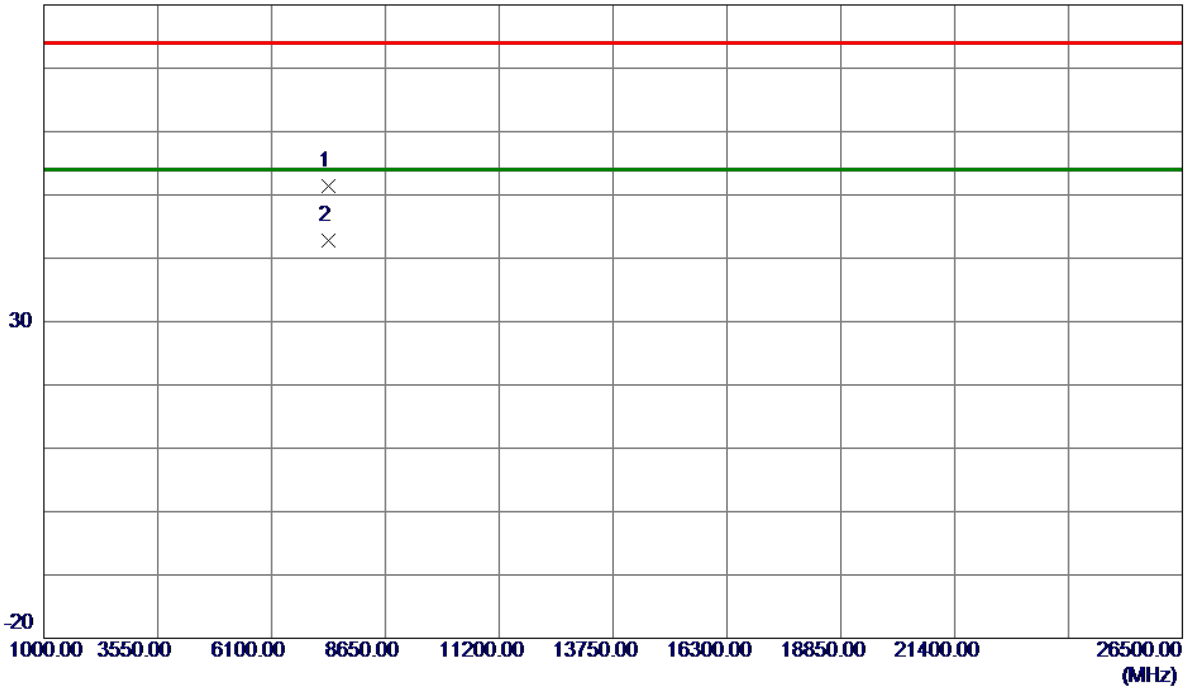

No.	Freq. MHz	Reading Level dBuV/m	Correct Factor dB	Measure ment dBuV/m	Limit dBuV/m	Margin dB	Detector	Comment
1	7385.9400	41.00	10.45	51.45	74.00	-22.55	Peak	
2 *	7386.8400	32.36	10.45	42.81	54.00	-11.19	AVG	

REMARKS:

- (1) Measurement Value = Reading Level + Correct Factor.
- (2) Margin Level = Measurement Value - Limit Value.

Test Mode: TX G Mode 2412 MHz

Vertical

130 dBuV/m

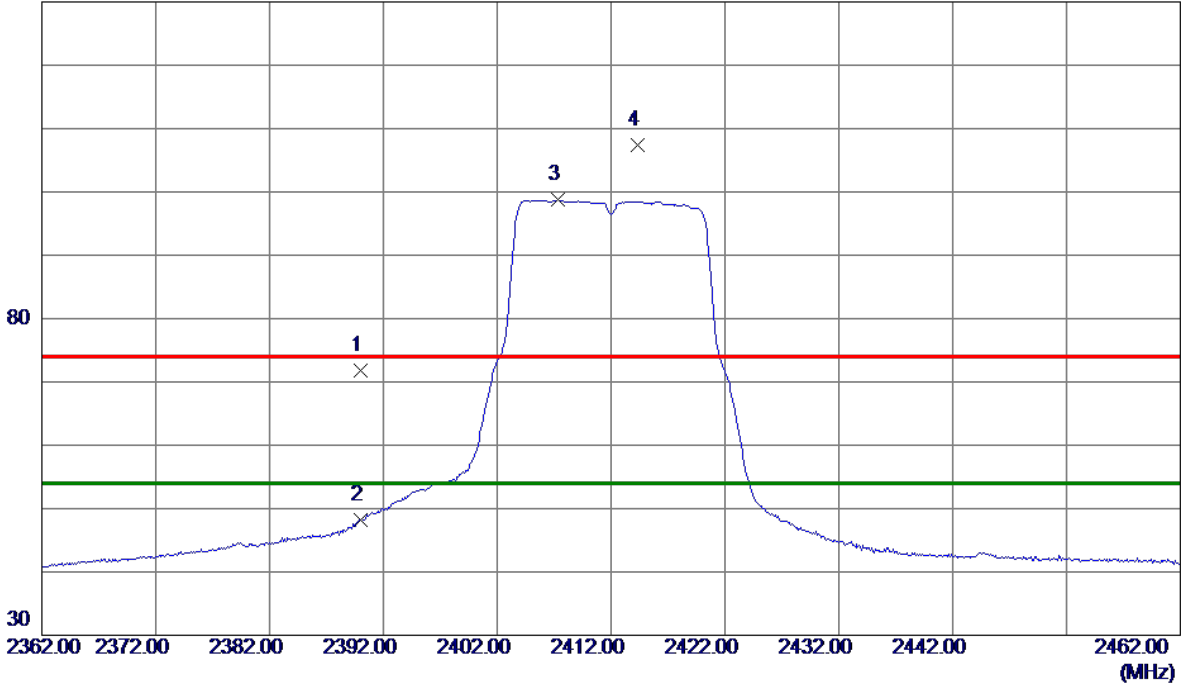

No.	Freq. MHz	Reading Level dBuV/m	Correct Factor dB	Measure ment dBuV/m	Limit dBuV/m	Margin dB	Detector	Comment
1	2390.0000	64.45	7.26	71.71	74.00	-2.29	Peak	
2	2390.0000	41.01	7.26	48.27	54.00	-5.73	AVG	
3 *	2407.3000	91.45	7.26	98.71	54.00	44.71	AVG	No Limit
4	2414.3000	100.05	7.26	107.31	74.00	33.31	Peak	No Limit

REMARKS:

- (1) Measurement Value = Reading Level + Correct Factor.
- (2) Margin Level = Measurement Value - Limit Value.

Test Mode: TX G Mode 2412 MHz

Vertical

80 dBuV/m

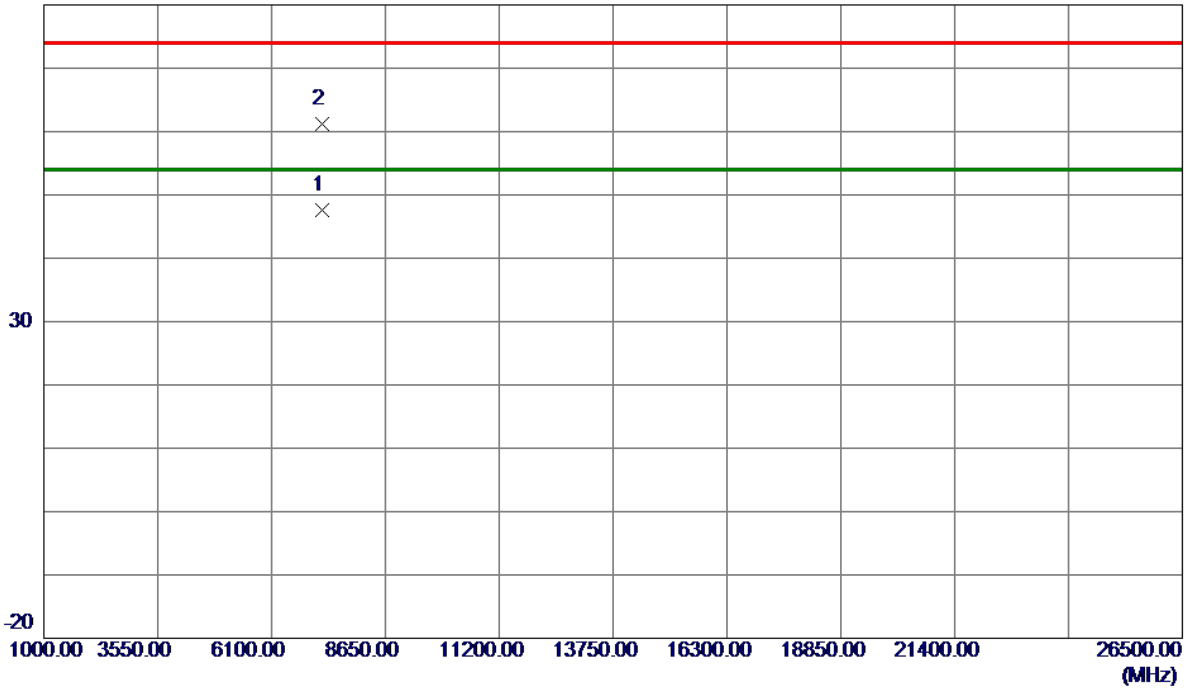

No.	Freq. MHz	Reading Level dBuV/m	Correct Factor dB	Measure ment dBuV/m	Limit dBuV/m	Margin dB	Detector	Comment
1 *	7237.0750	37.33	10.19	47.52	54.00	-6.48	AVG	
2	7237.1500	50.95	10.19	61.14	74.00	-12.86	Peak	

REMARKS:

- (1) Measurement Value = Reading Level + Correct Factor.
- (2) Margin Level = Measurement Value - Limit Value.

Test Mode: TX G Mode 2412 MHz

Horizontal

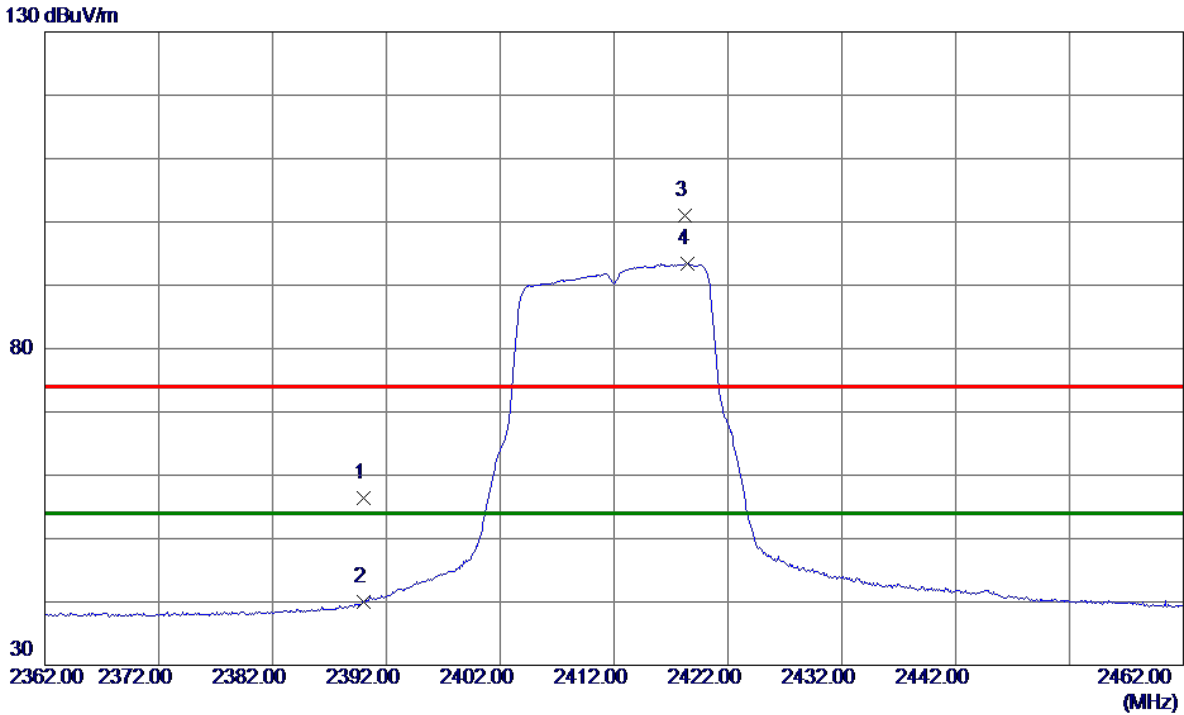

No.	Freq. MHz	Reading Level dBuV/m	Correct Factor dB	Measure ment dBuV/m	Limit dBuV/m	Margin dB	Detector	Comment
1	2390.0000	49.19	7.26	56.45	74.00	-17.55	Peak	
2	2390.0000	32.82	7.26	40.08	54.00	-13.92	AVG	
3	2418.2000	93.65	7.26	100.91	74.00	26.91	Peak	No Limit
4 *	2418.4000	86.12	7.26	93.38	54.00	39.38	AVG	No Limit

REMARKS:

- (1) Measurement Value = Reading Level + Correct Factor.
- (2) Margin Level = Measurement Value - Limit Value.

Test Mode: TX G Mode 2412 MHz

Horizontal

80 dBuV/m

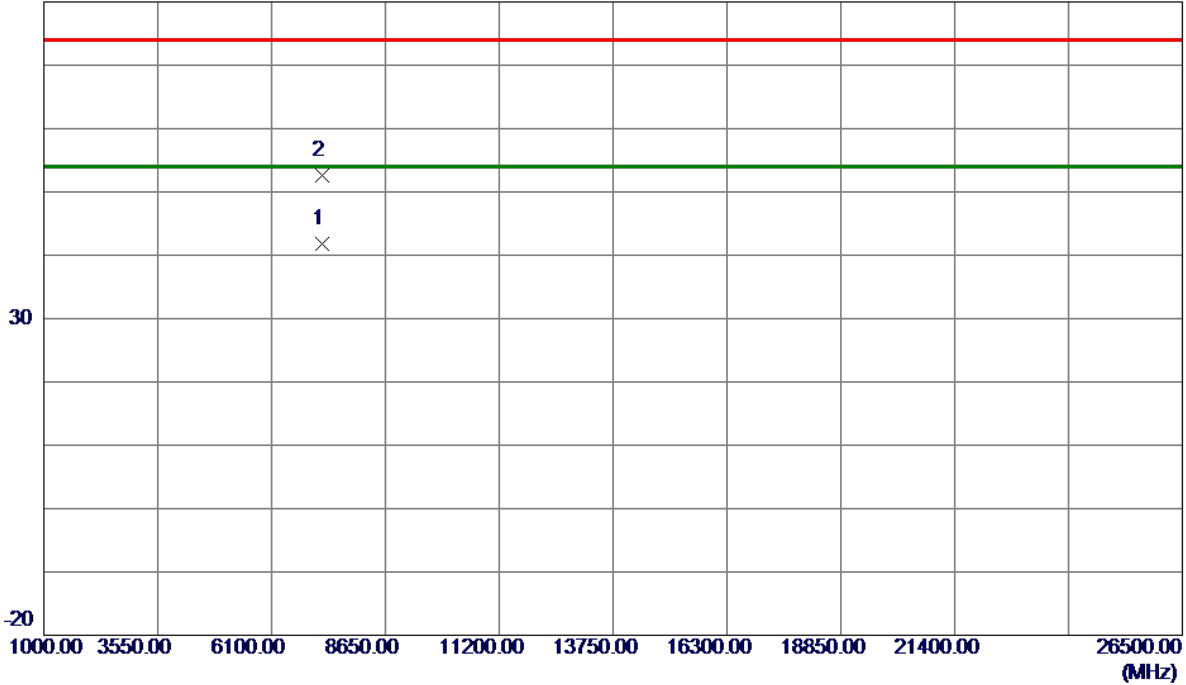

No.	Freq. MHz	Reading Level dBuV/m	Correct Factor dB	Measure ment dBuV/m	Limit dBuV/m	Margin dB	Detector	Comment
1 *	7236.1250	31.52	10.19	41.71	54.00	-12.29	AVG	
2	7241.7000	42.38	10.20	52.58	74.00	-21.42	Peak	

REMARKS:

(1) Measurement Value = Reading Level + Correct Factor.

(2) Margin Level = Measurement Value - Limit Value.

Test Mode: TX G Mode 2437 MHz

Vertical

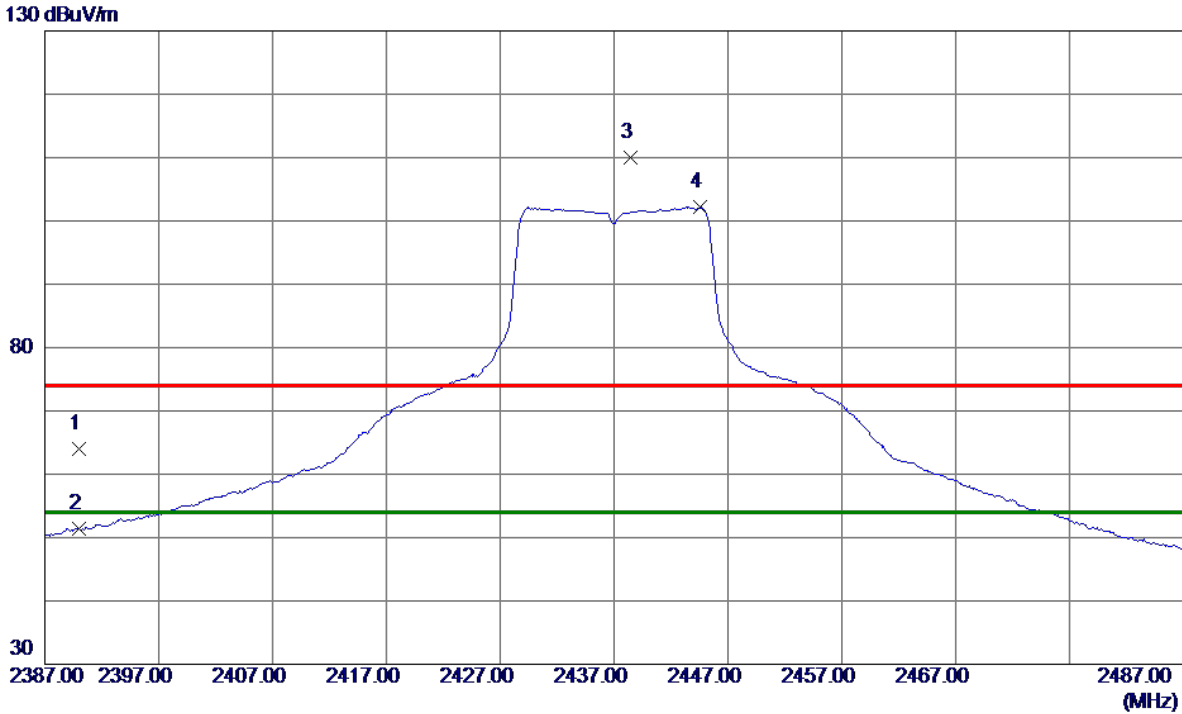

No.	Freq. MHz	Reading Level dBuV/m	Correct Factor dB	Measure ment dBuV/m	Limit dBuV/m	Margin dB	Detector	Comment
1	2390.0000	56.68	7.26	63.94	74.00	-10.06	Peak	
2	2390.0000	44.15	7.26	51.41	54.00	-2.59	AVG	
3	2438.4000	102.81	7.25	110.06	74.00	36.06	Peak	No Limit
4 *	2444.6000	94.91	7.25	102.16	54.00	48.16	AVG	No Limit

REMARKS:

- (1) Measurement Value = Reading Level + Correct Factor.
- (2) Margin Level = Measurement Value - Limit Value.

Test Mode: TX G Mode 2437 MHz

Vertical

80 dBuV/m

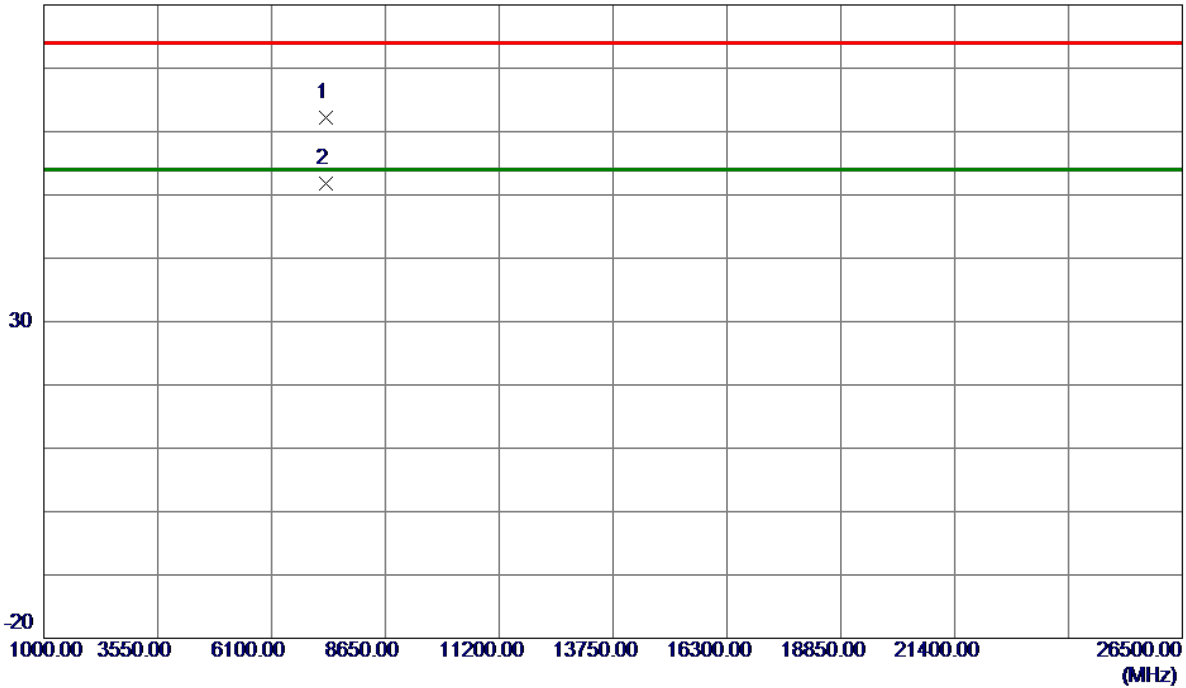

No.	Freq. MHz	Reading Level dBuV/m	Correct Factor dB	Measure ment dBuV/m	Limit dBuV/m	Margin dB	Detector	Comment
1	7306.3250	51.88	10.31	62.19	74.00	-11.81	Peak	
2 *	7312.1750	41.45	10.32	51.77	54.00	-2.23	AVG	

REMARKS:

- (1) Measurement Value = Reading Level + Correct Factor.
- (2) Margin Level = Measurement Value - Limit Value.

Test Mode: TX G Mode 2437 MHz

Horizontal

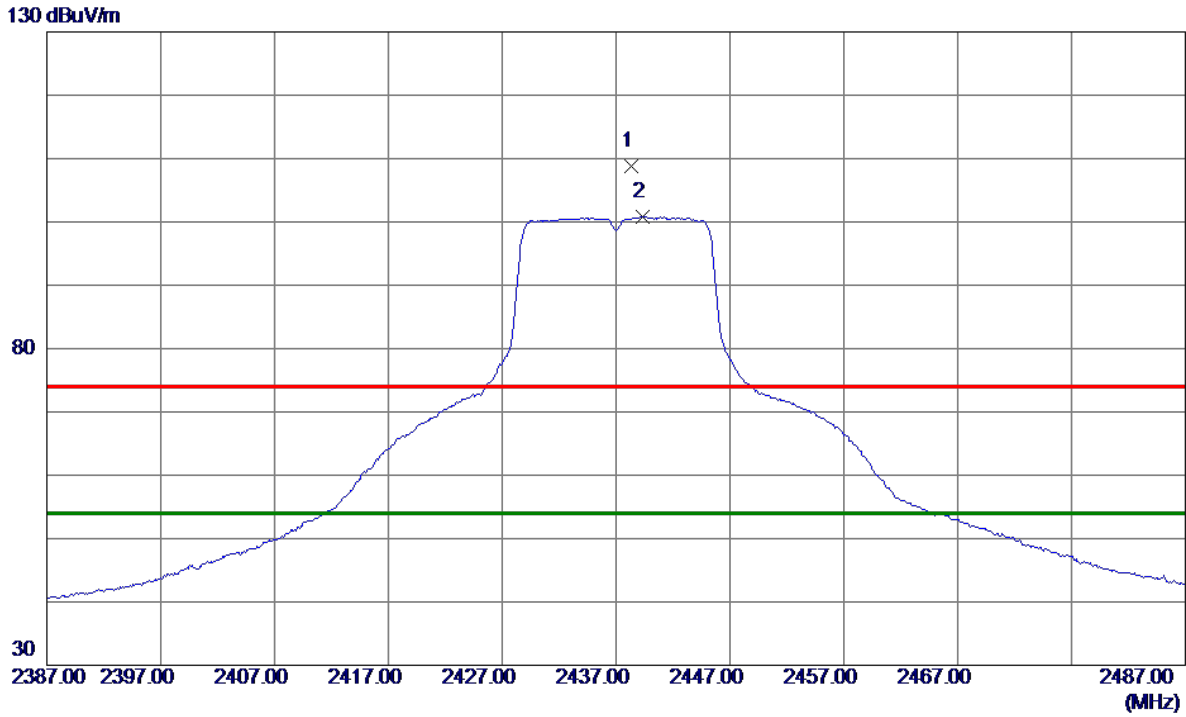

No.	Freq. MHz	Reading Level dBuV/m	Correct Factor dB	Measure ment dBuV/m	Limit dBuV/m	Margin dB	Detector	Comment
1	2438.3000	101.50	7.25	108.75	74.00	34.75	Peak	No Limit
2 *	2439.3000	93.53	7.25	100.78	54.00	46.78	AVG	No Limit

REMARKS:

- (1) Measurement Value = Reading Level + Correct Factor.
- (2) Margin Level = Measurement Value - Limit Value.

Test Mode: TX G Mode 2437 MHz

Horizontal

80 dBuV/m

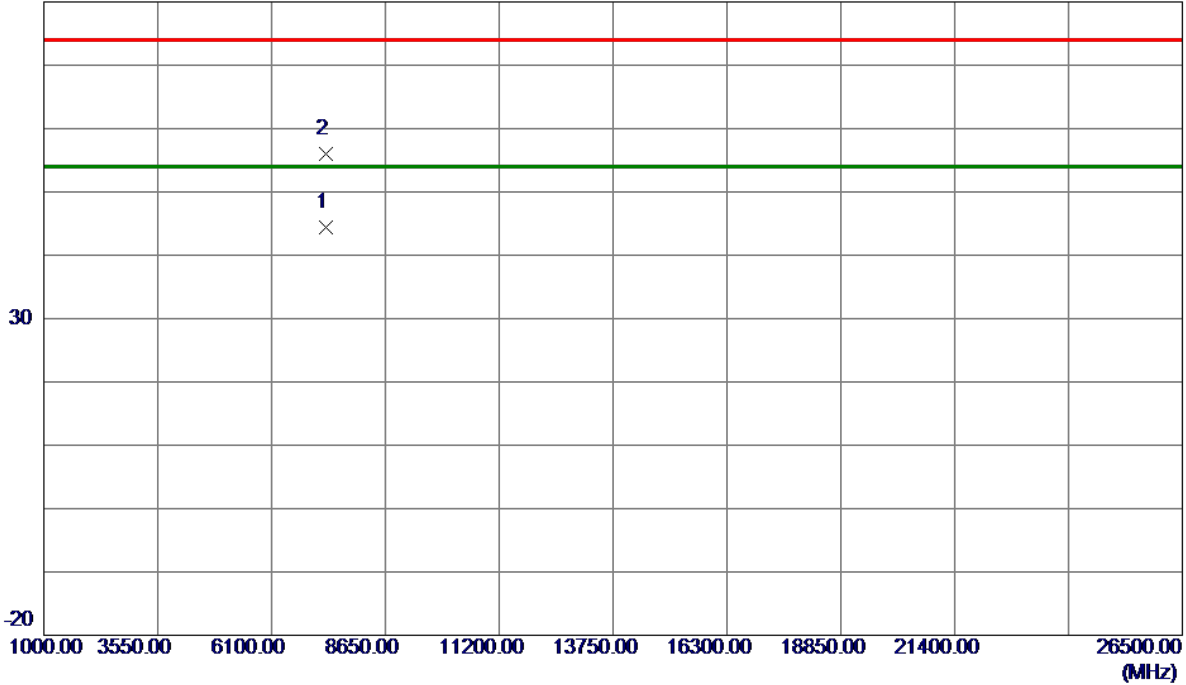

No.	Freq. MHz	Reading Level dBuV/m	Correct Factor dB	Measure ment dBuV/m	Limit dBuV/m	Margin dB	Detector	Comment
1 *	7312.4500	34.16	10.32	44.48	54.00	-9.52	AVG	
2	7312.5250	45.74	10.32	56.06	74.00	-17.94	Peak	

REMARKS:

(1) Measurement Value = Reading Level + Correct Factor.

(2) Margin Level = Measurement Value - Limit Value.

Test Mode: TX G Mode 2462 MHz

Vertical

130 dBuV/m

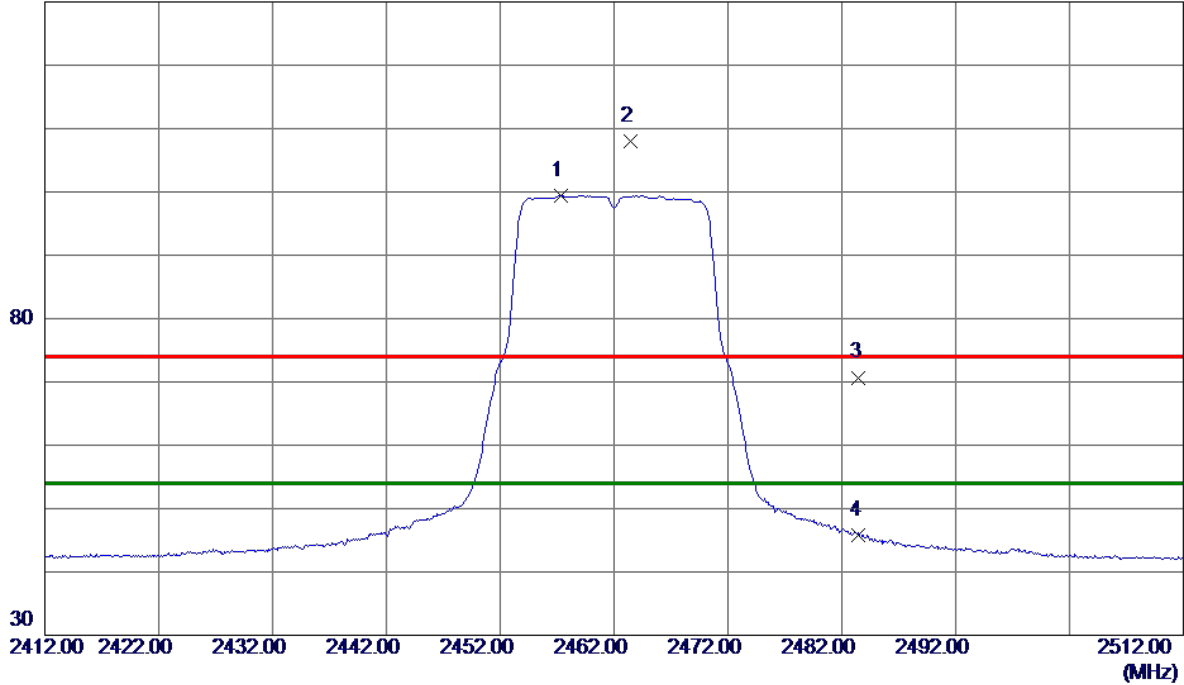

No.	Freq. MHz	Reading Level dBuV/m	Correct Factor dB	Measure ment dBuV/m	Limit dBuV/m	Margin dB	Detector	Comment
1 *	2457.3000	92.15	7.25	99.40	54.00	45.40	AVG	No Limit
2	2463.4000	100.83	7.25	108.08	74.00	34.08	Peak	No Limit
3	2483.5000	63.45	7.25	70.70	74.00	-3.30	Peak	
4	2483.5000	38.60	7.25	45.85	54.00	-8.15	AVG	

REMARKS:

- (1) Measurement Value = Reading Level + Correct Factor.
- (2) Margin Level = Measurement Value - Limit Value.

Test Mode: TX G Mode 2462 MHz

Vertical

80 dBuV/m

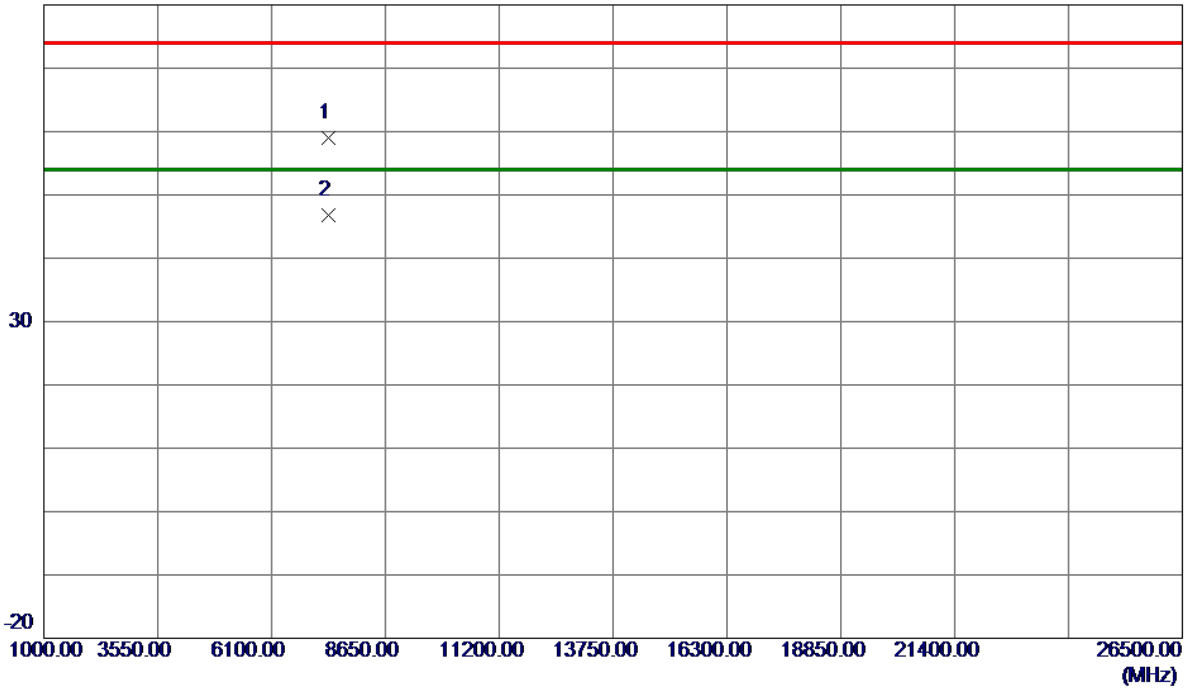

No.	Freq. MHz	Reading Level dBuV/m	Correct Factor dB	Measure ment dBuV/m	Limit dBuV/m	Margin dB	Detector	Comment
1	7380.5500	48.60	10.44	59.04	74.00	-14.96	Peak	
2 *	7387.3000	36.31	10.45	46.76	54.00	-7.24	AVG	

REMARKS:

- (1) Measurement Value = Reading Level + Correct Factor.
- (2) Margin Level = Measurement Value - Limit Value.

Test Mode: TX G Mode 2462 MHz

Horizontal

130 dBuV/m

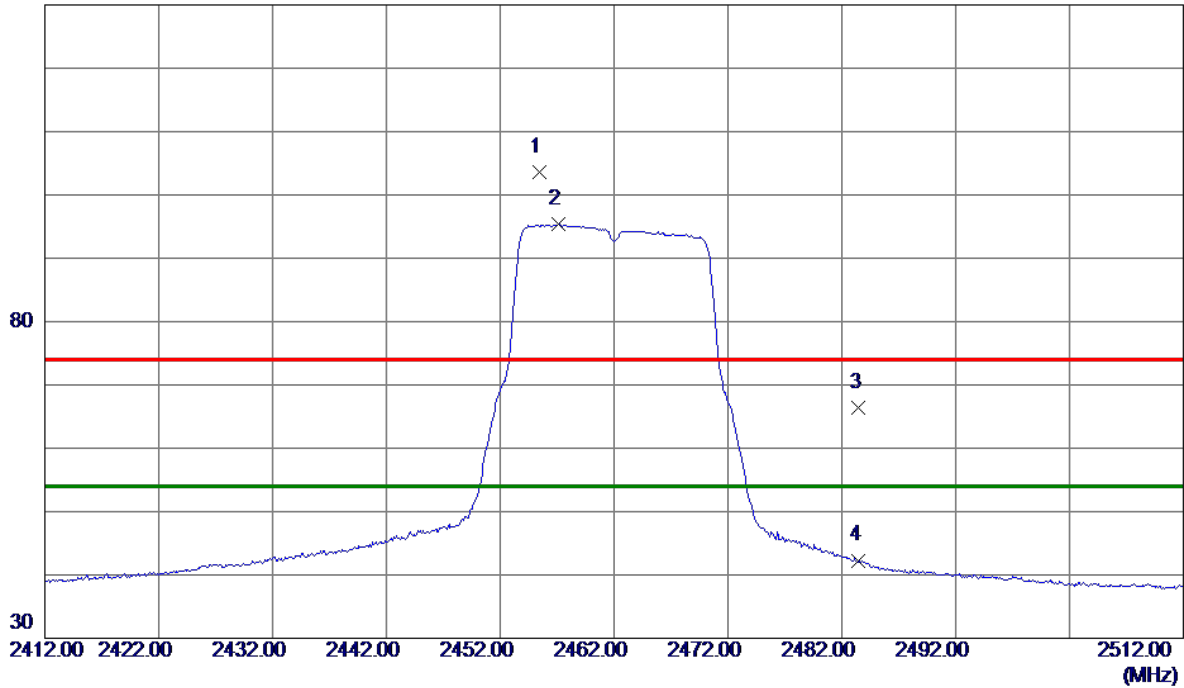

No.	Freq. MHz	Reading Level dBuV/m	Correct Factor dB	Measure ment dBuV/m	Limit dBuV/m	Margin dB	Detector	Comment
1	2455.4000	96.37	7.25	103.62	74.00	29.62	Peak	No Limit
2 *	2457.1000	88.10	7.25	95.35	54.00	41.35	AVG	No Limit
3	2483.5000	59.07	7.25	66.32	74.00	-7.68	Peak	
4	2483.5000	35.05	7.25	42.30	54.00	-11.70	AVG	

REMARKS:

(1) Measurement Value = Reading Level + Correct Factor.

(2) Margin Level = Measurement Value - Limit Value.

Test Mode: TX G Mode 2462 MHz

Horizontal

80 dBuV/m

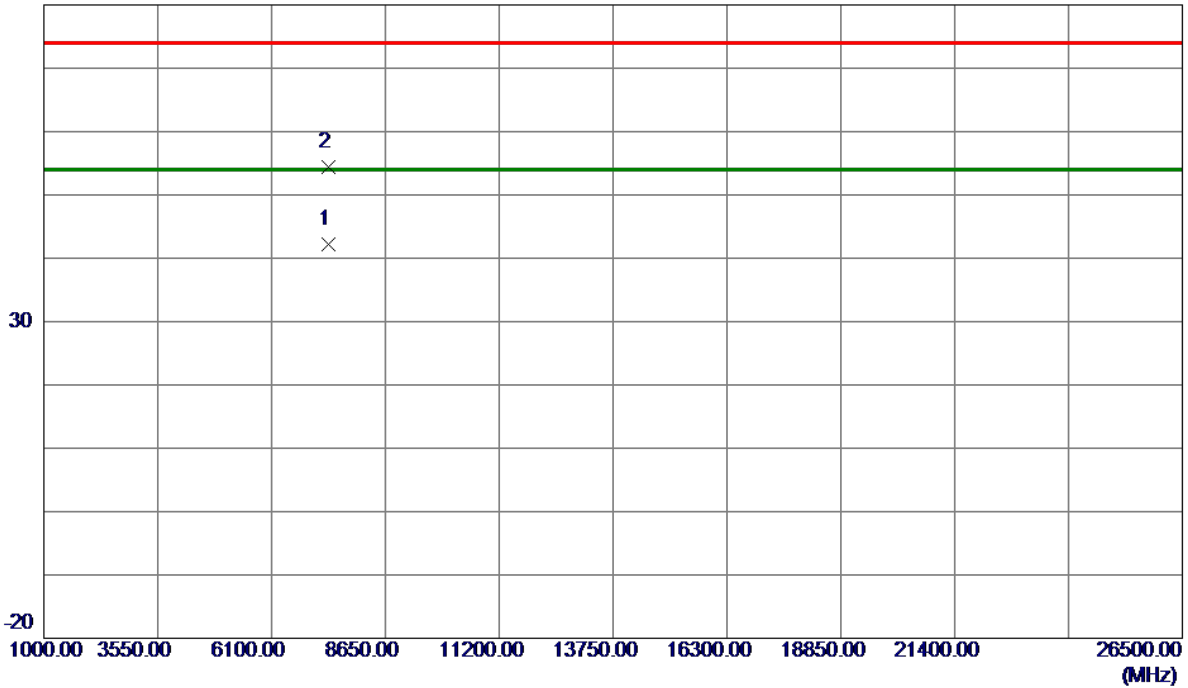

No.	Freq. MHz	Reading Level dBuV/m	Correct Factor dB	Measure ment dBuV/m	Limit dBuV/m	Margin dB	Detector	Comment
1 *	7387.5750	31.69	10.45	42.14	54.00	-11.86	AVG	
2	7387.7750	43.96	10.45	54.41	74.00	-19.59	Peak	

REMARKS:

- (1) Measurement Value = Reading Level + Correct Factor.
- (2) Margin Level = Measurement Value - Limit Value.

Test Mode: TX N-20M Mode 2412 MHz

Vertical

130 dBuV/m

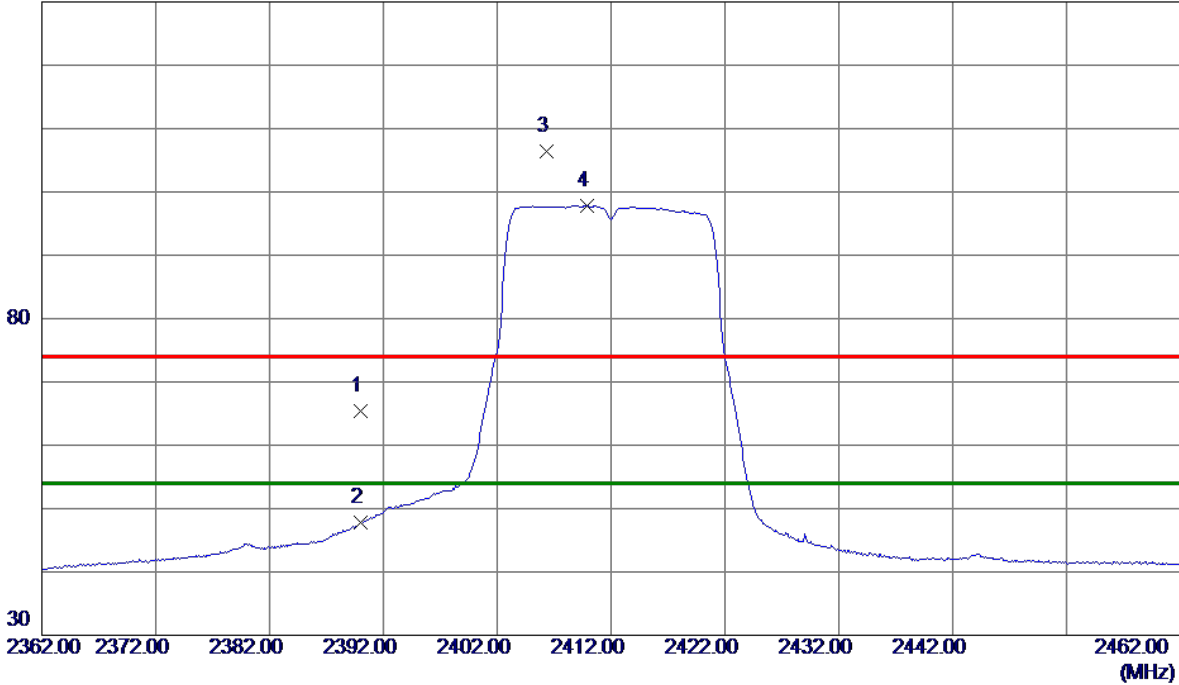

No.	Freq. MHz	Reading Level dBuV/m	Correct Factor dB	Measure ment dBuV/m	Limit dBuV/m	Margin dB	Detector	Comment
1	2390.0000	58.06	7.26	65.32	74.00	-8.68	Peak	
2	2390.0000	40.56	7.26	47.82	54.00	-6.18	AVG	
3	2406.3000	99.07	7.26	106.33	74.00	32.33	Peak	No Limit
4 *	2409.9000	90.56	7.26	97.82	54.00	43.82	AVG	No Limit

REMARKS:

- (1) Measurement Value = Reading Level + Correct Factor.
- (2) Margin Level = Measurement Value - Limit Value.

Test Mode: TX N-20M Mode 2412 MHz

Vertical

80 dBuV/m

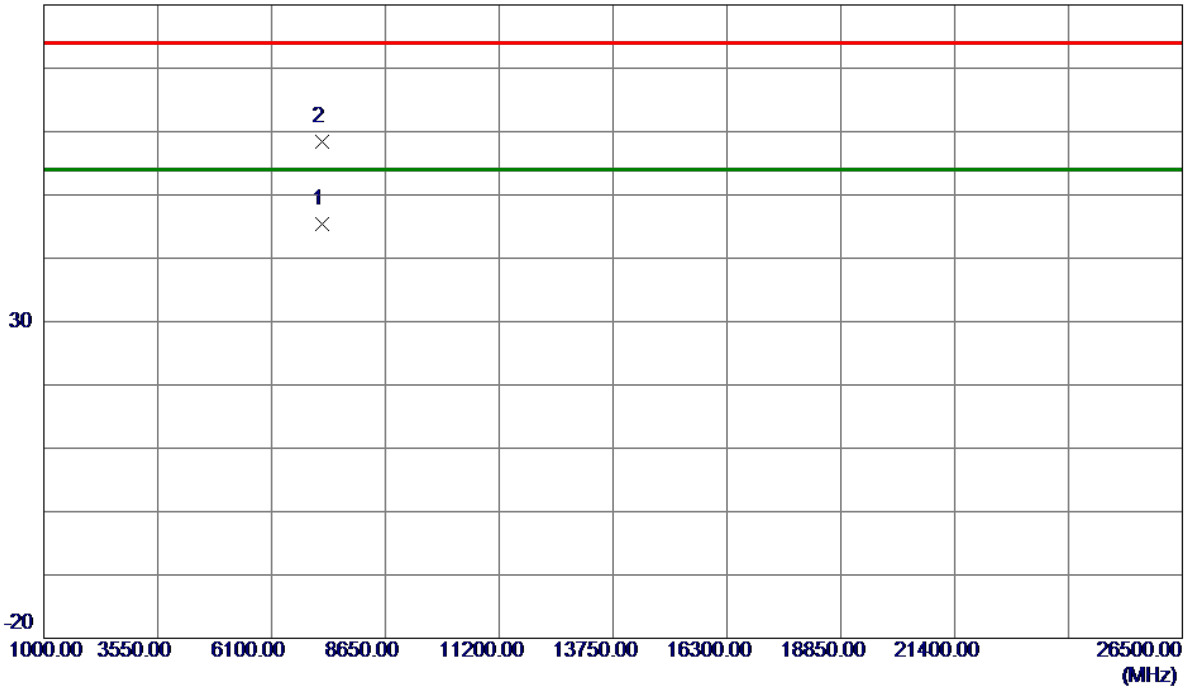

No.	Freq. MHz	Reading Level dBuV/m	Correct Factor dB	Measure ment dBuV/m	Limit dBuV/m	Margin dB	Detector	Comment
1 *	7235.8000	35.16	10.19	45.35	54.00	-8.65	AVG	
2	7237.0000	48.16	10.19	58.35	74.00	-15.65	Peak	

REMARKS:

- (1) Measurement Value = Reading Level + Correct Factor.
- (2) Margin Level = Measurement Value - Limit Value.

Test Mode: TX N-20M Mode 2412 MHz

Horizontal

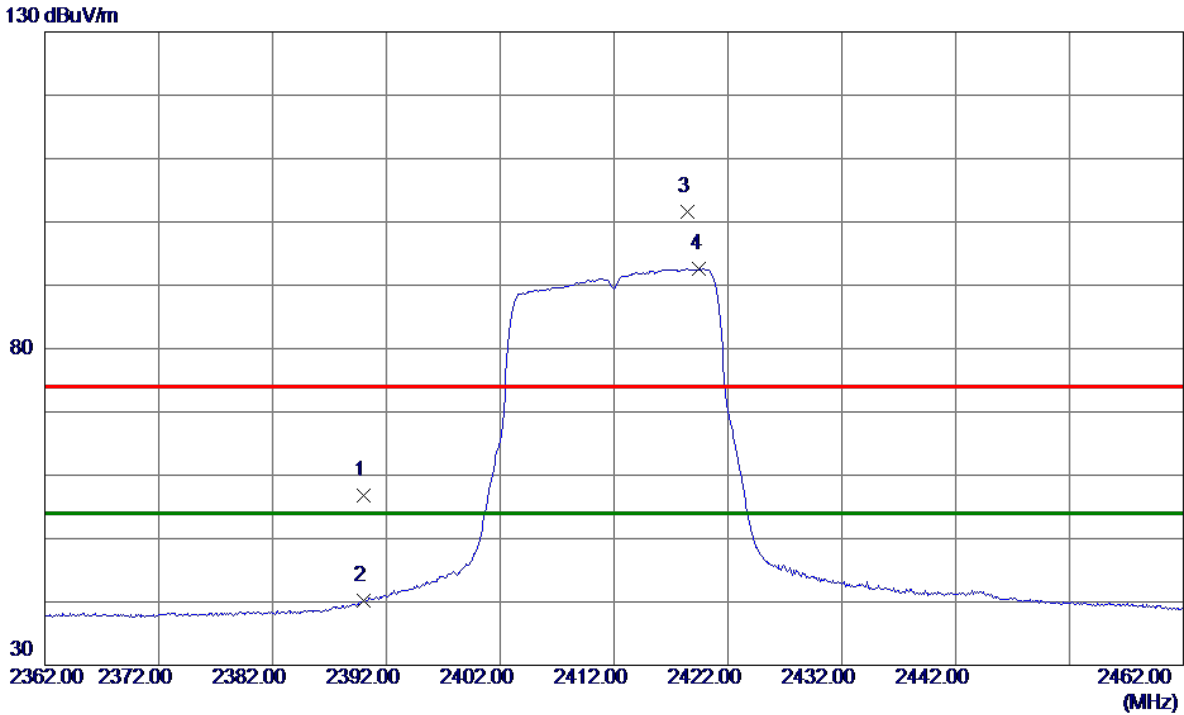

No.	Freq. MHz	Reading Level dBuV/m	Correct Factor dB	Measure ment dBuV/m	Limit dBuV/m	Margin dB	Detector	Comment
1	2390.0000	49.45	7.26	56.71	74.00	-17.29	Peak	
2	2390.0000	32.86	7.26	40.12	54.00	-13.88	AVG	
3	2418.4000	94.36	7.26	101.62	74.00	27.62	Peak	No Limit
4 *	2419.5000	85.33	7.26	92.59	54.00	38.59	AVG	No Limit

REMARKS:

(1) Measurement Value = Reading Level + Correct Factor.

(2) Margin Level = Measurement Value - Limit Value.

Test Mode: TX N-20M Mode 2412 MHz

Horizontal

80 dBuV/m

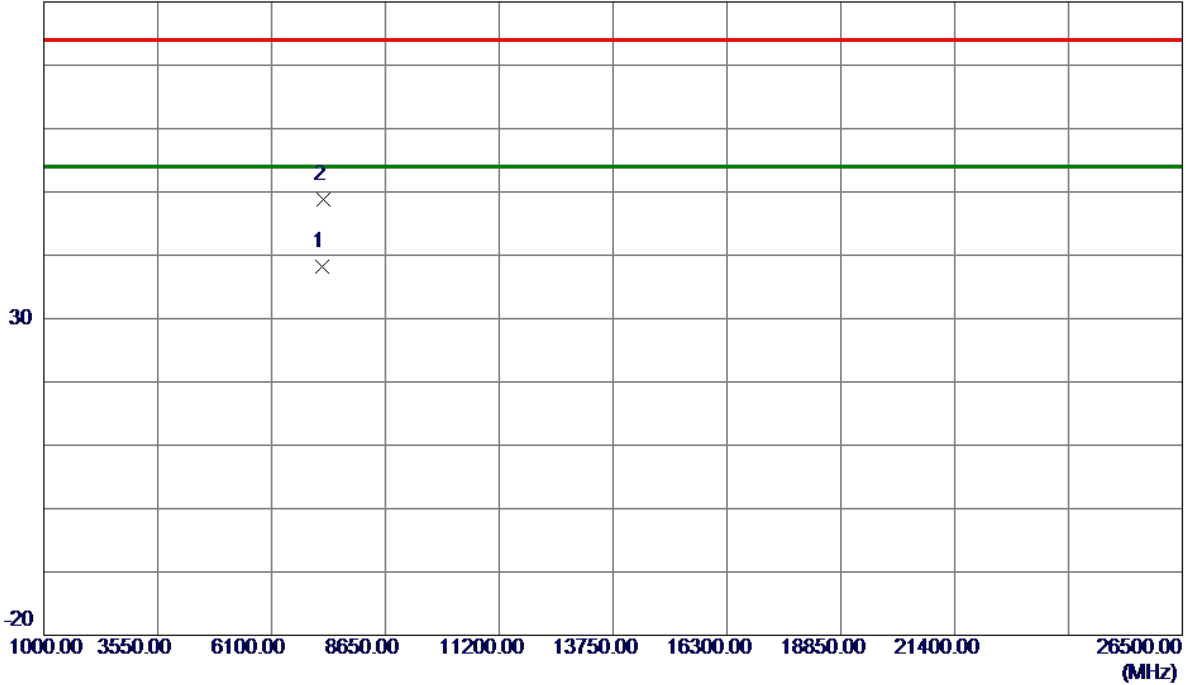

No.	Freq. MHz	Reading Level dBuV/m	Correct Factor dB	Measure ment dBuV/m	Limit dBuV/m	Margin dB	Detector	Comment
1 *	7233.7250	27.95	10.19	38.14	54.00	-15.86	AVG	
2	7251.9750	38.67	10.22	48.89	74.00	-25.11	Peak	

REMARKS:

- (1) Measurement Value = Reading Level + Correct Factor.
- (2) Margin Level = Measurement Value - Limit Value.

Test Mode: TX N-20M Mode 2437 MHz

Vertical

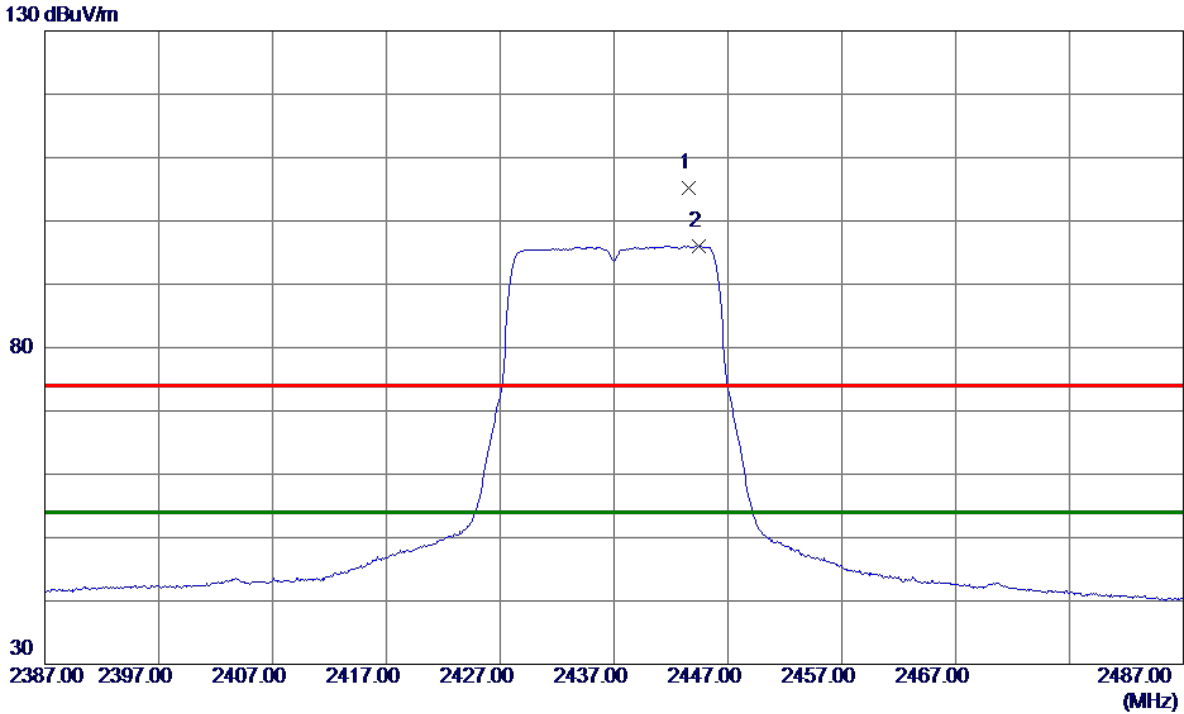

No.	Freq. MHz	Reading Level dBuV/m	Correct Factor dB	Measure ment dBuV/m	Limit dBuV/m	Margin dB	Detector	Comment
1	2443.6000	97.95	7.25	105.20	74.00	31.20	Peak	No Limit
2 *	2444.4000	88.76	7.25	96.01	54.00	42.01	AVG	No Limit

REMARKS:

- (1) Measurement Value = Reading Level + Correct Factor.
- (2) Margin Level = Measurement Value - Limit Value.

Test Mode: TX N-20M Mode 2437 MHz

Vertical

80 dBuV/m

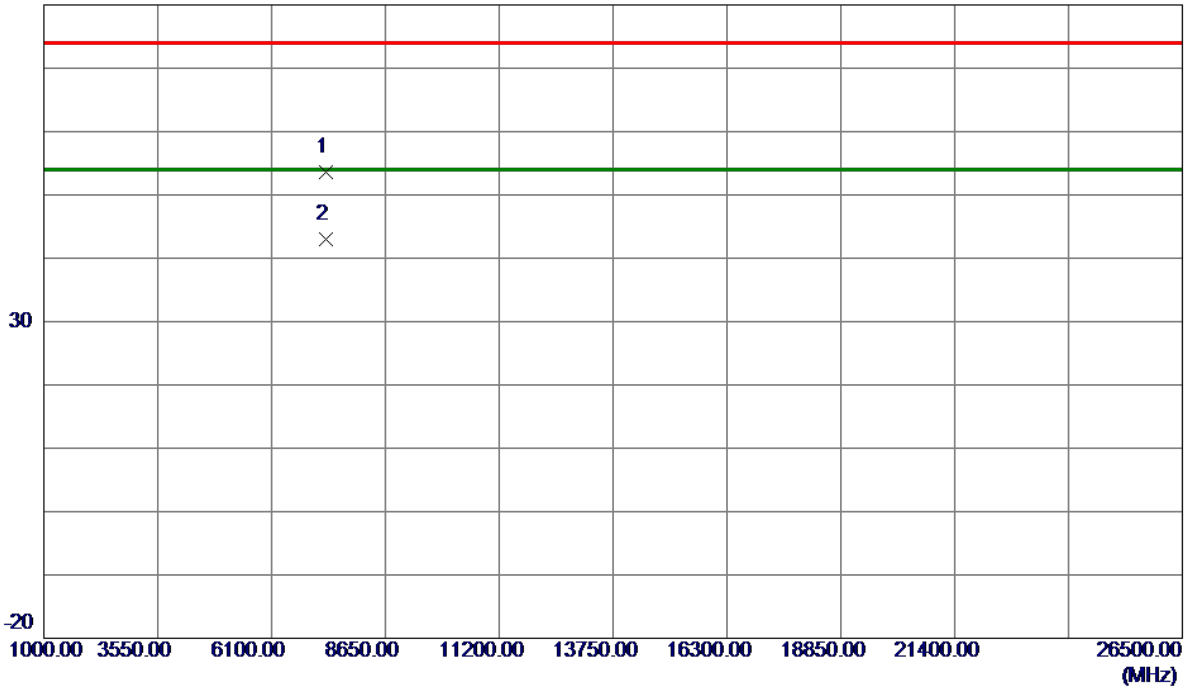

No.	Freq. MHz	Reading Level dBuV/m	Correct Factor dB	Measure ment dBuV/m	Limit dBuV/m	Margin dB	Detector	Comment
1	7306.5000	43.23	10.31	53.54	74.00	-20.46	Peak	
2 *	7310.8000	32.72	10.32	43.04	54.00	-10.96	AVG	

REMARKS:

- (1) Measurement Value = Reading Level + Correct Factor.
- (2) Margin Level = Measurement Value - Limit Value.

Test Mode: TX N-20M Mode 2437 MHz

Horizontal

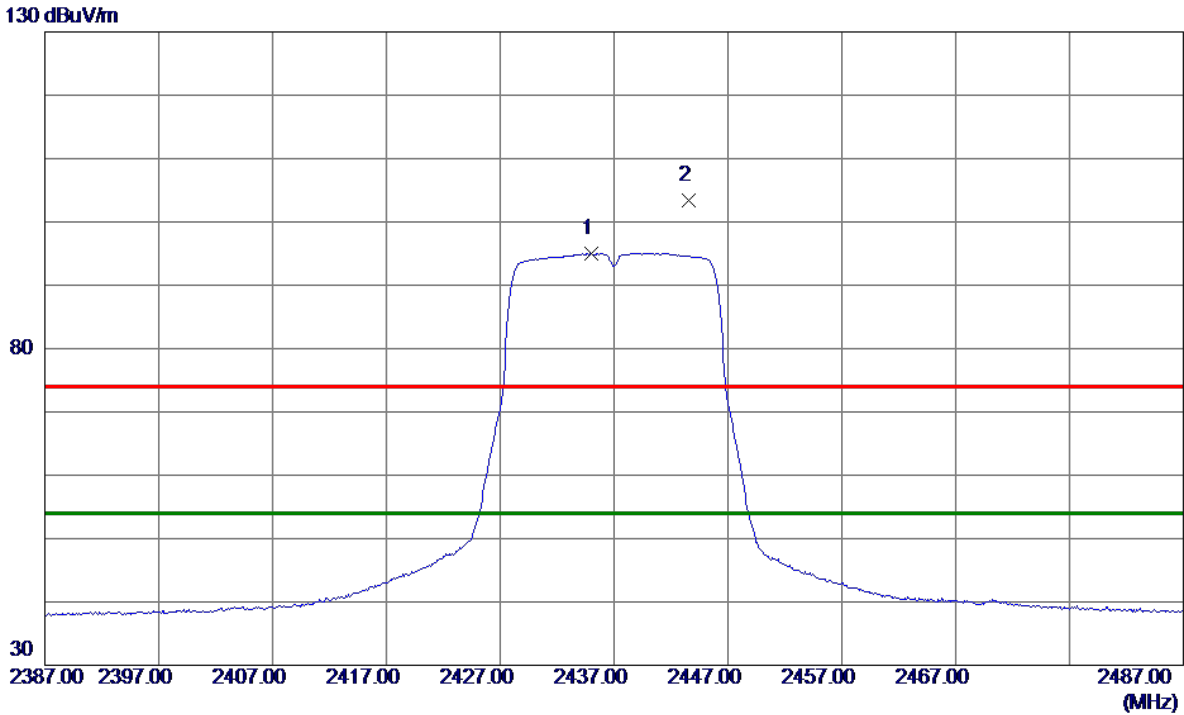

No.	Freq. MHz	Reading Level dBuV/m	Correct Factor dB	Measure ment dBuV/m	Limit dBuV/m	Margin dB	Detector	Comment
1 *	2435.0000	87.83	7.25	95.08	54.00	41.08	AVG	No Limit
2	2443.6000	96.16	7.25	103.41	74.00	29.41	Peak	No Limit

REMARKS:

(1) Measurement Value = Reading Level + Correct Factor.

(2) Margin Level = Measurement Value - Limit Value.

Test Mode: TX N-20M Mode 2437 MHz

Horizontal

80 dBuV/m

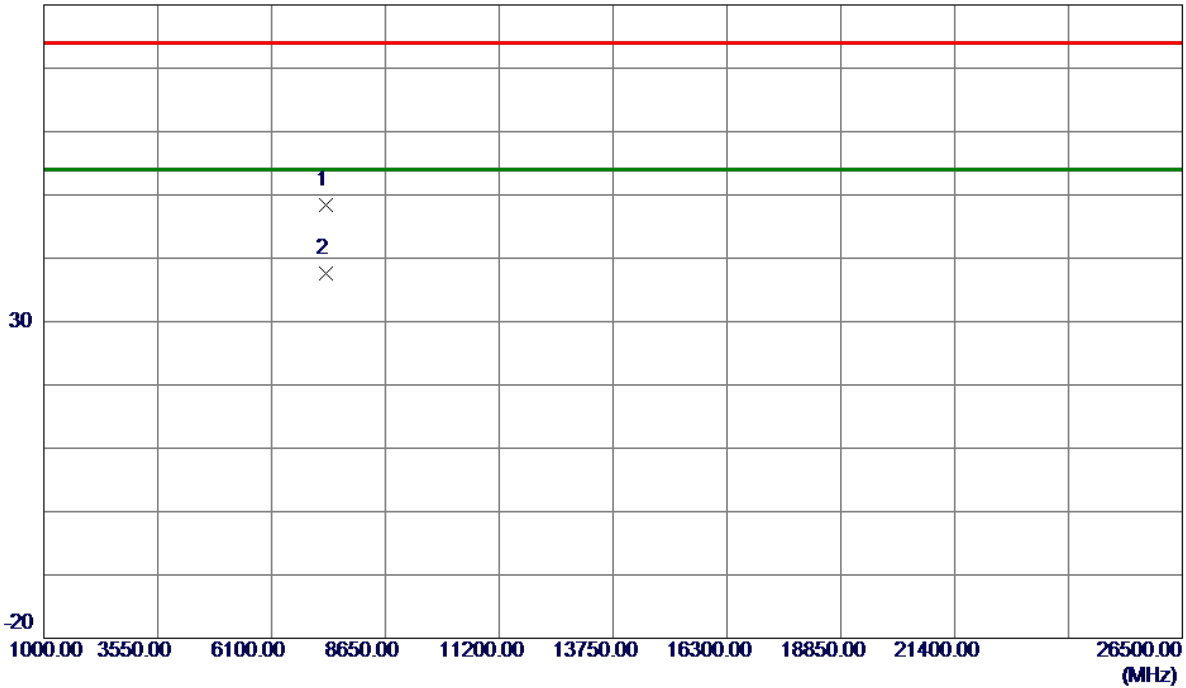

No.	Freq. MHz	Reading Level dBuV/m	Correct Factor dB	Measure ment dBuV/m	Limit dBuV/m	Margin dB	Detector	Comment
1	7306.7300	38.00	10.31	48.31	74.00	-25.69	Peak	
2 *	7312.2950	27.30	10.32	37.62	54.00	-16.38	AVG	

REMARKS:

- (1) Measurement Value = Reading Level + Correct Factor.
- (2) Margin Level = Measurement Value - Limit Value.

Test Mode: TX N-20M Mode 2462 MHz

Vertical

130 dBuV/m

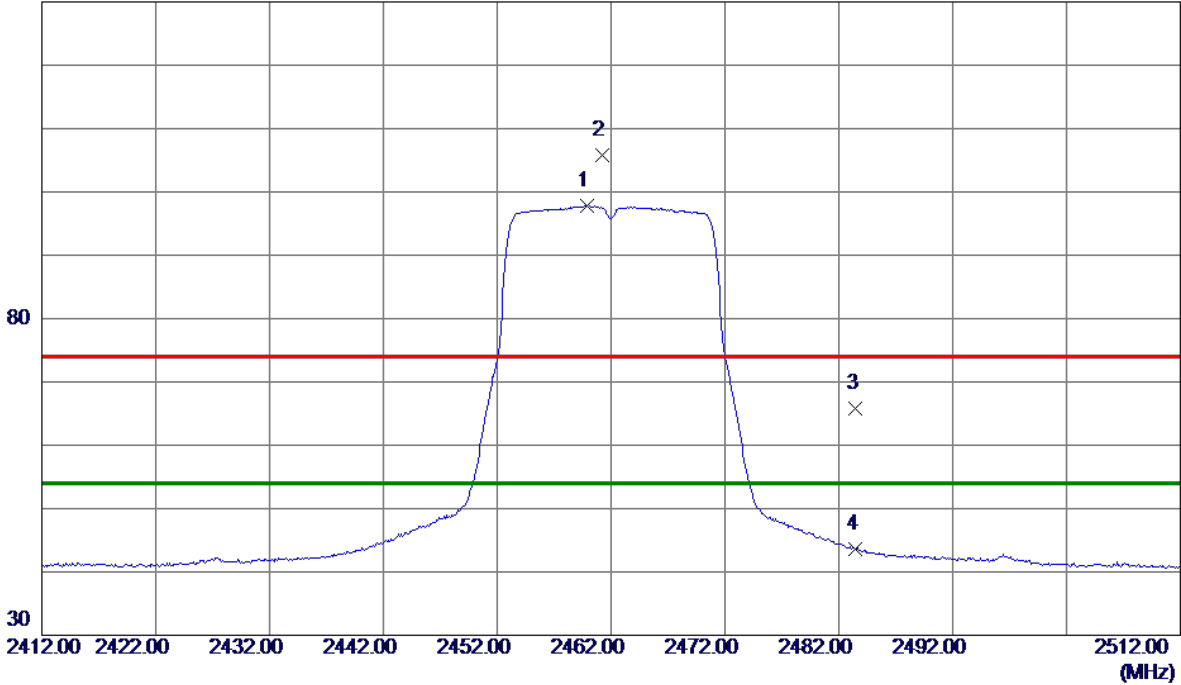

No.	Freq. MHz	Reading Level dBuV/m	Correct Factor dB	Measure ment dBuV/m	Limit dBuV/m	Margin dB	Detector	Comment
1 *	2459.9000	90.59	7.25	97.84	54.00	43.84	AVG	No Limit
2	2461.2000	98.61	7.25	105.86	74.00	31.86	Peak	No Limit
3	2483.5000	58.54	7.25	65.79	74.00	-8.21	Peak	
4	2483.5000	36.36	7.25	43.61	54.00	-10.39	AVG	

REMARKS:

- (1) Measurement Value = Reading Level + Correct Factor.
- (2) Margin Level = Measurement Value - Limit Value.

Test Mode: TX N-20M Mode 2462 MHz

Vertical

80 dBuV/m

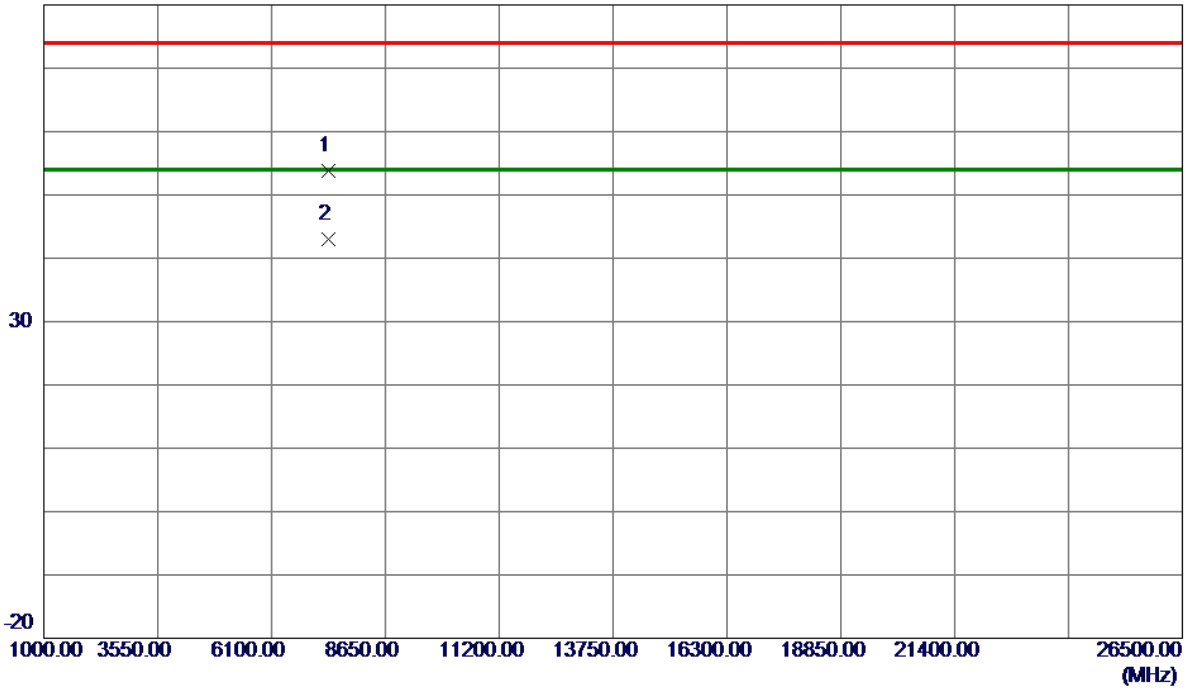

No.	Freq. MHz	Reading Level dBuV/m	Correct Factor dB	Measure ment dBuV/m	Limit dBuV/m	Margin dB	Detector	Comment
1	7381.5000	43.40	10.44	53.84	74.00	-20.16	Peak	
2 *	7387.0500	32.47	10.45	42.92	54.00	-11.08	AVG	

REMARKS:

- (1) Measurement Value = Reading Level + Correct Factor.
- (2) Margin Level = Measurement Value - Limit Value.

Test Mode: TX N-20M Mode 2462 MHz

Horizontal

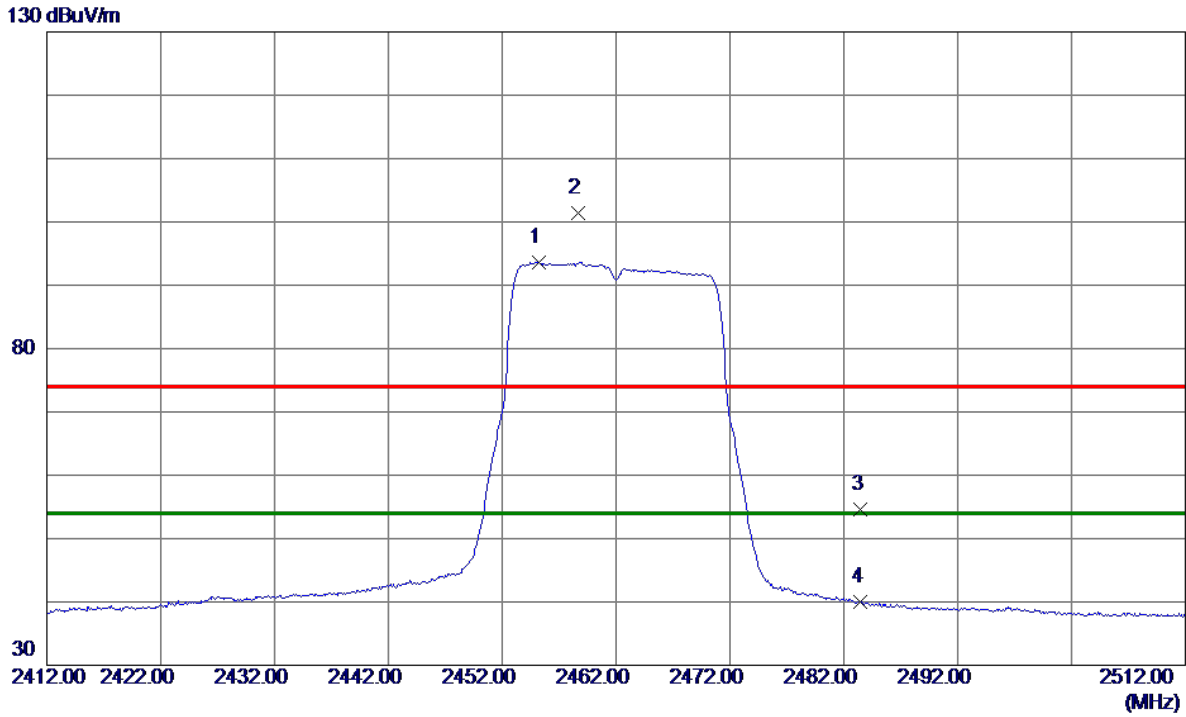

No.	Freq. MHz	Reading Level dBuV/m	Correct Factor dB	Measure ment dBuV/m	Limit dBuV/m	Margin dB	Detector	Comment
1 *	2455.2000	86.33	7.25	93.58	54.00	39.58	AVG	No Limit
2	2458.7000	94.11	7.25	101.36	74.00	27.36	Peak	No Limit
3	2483.5000	47.27	7.25	54.52	74.00	-19.48	Peak	
4	2483.5000	32.71	7.25	39.96	54.00	-14.04	AVG	

REMARKS:

- (1) Measurement Value = Reading Level + Correct Factor.
- (2) Margin Level = Measurement Value - Limit Value.

Test Mode: TX N-20M Mode 2462 MHz

Horizontal

80 dBuV/m

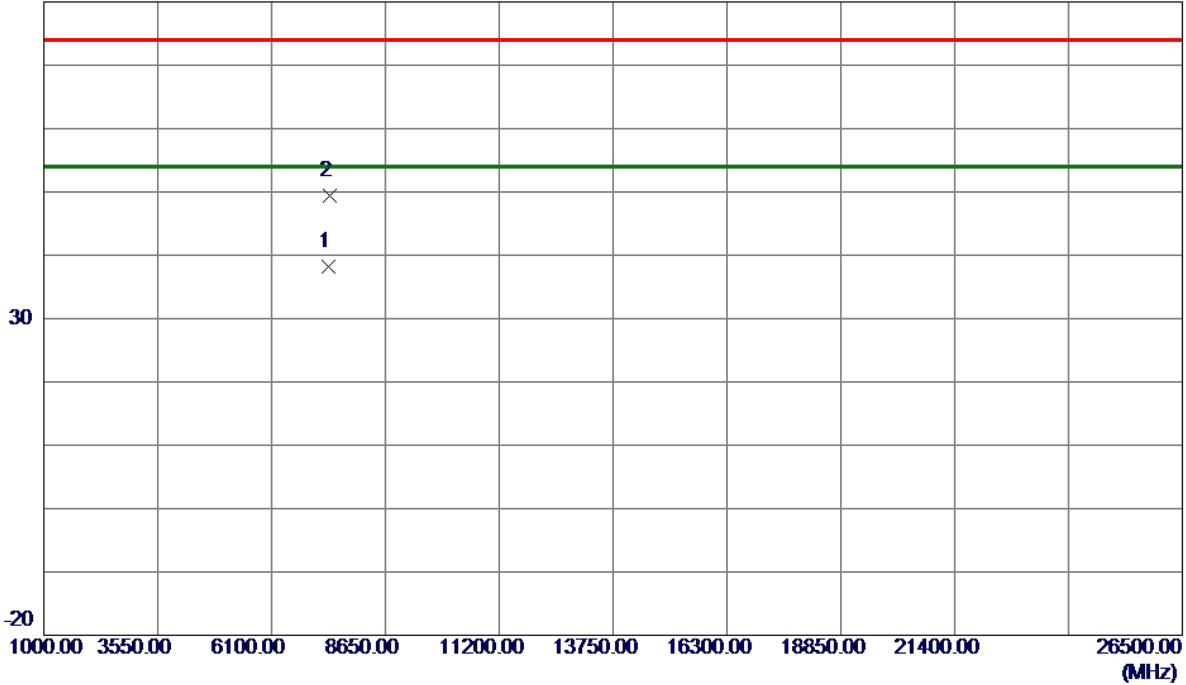

No.	Freq. MHz	Reading Level dBuV/m	Correct Factor dB	Measure ment dBuV/m	Limit dBuV/m	Margin dB	Detector	Comment
1 *	7382.2750	27.71	10.44	38.15	54.00	-15.85	AVG	
2	7390.7150	38.96	10.45	49.41	74.00	-24.59	Peak	

REMARKS:

- (1) Measurement Value = Reading Level + Correct Factor.
- (2) Margin Level = Measurement Value - Limit Value.

Test Mode: TX N-40M Mode 2422 MHz

Vertical

130 dBuV/m

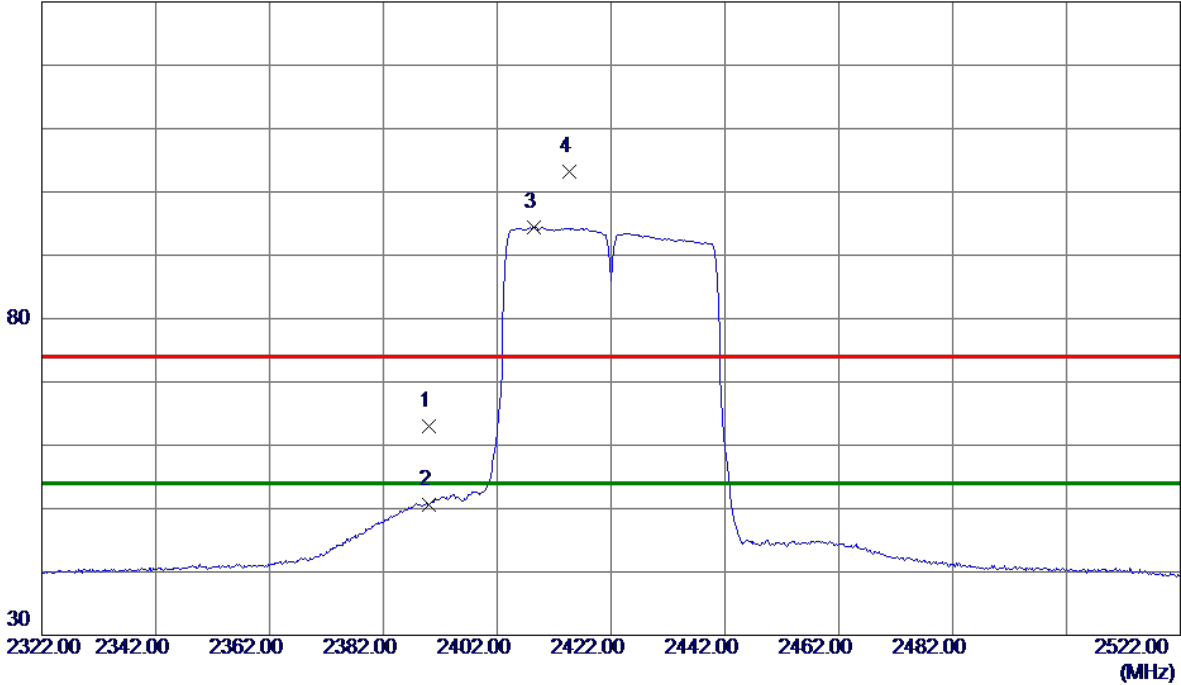

No.	Freq. MHz	Reading Level dBuV/m	Correct Factor dB	Measure ment dBuV/m	Limit dBuV/m	Margin dB	Detector	Comment
1	2390.0000	55.71	7.26	62.97	74.00	-11.03	Peak	
2	2390.0000	43.30	7.26	50.56	54.00	-3.44	AVG	
3 *	2408.4000	87.13	7.26	94.39	54.00	40.39	AVG	No Limit
4	2414.6000	96.00	7.26	103.26	74.00	29.26	Peak	No Limit

REMARKS:

- (1) Measurement Value = Reading Level + Correct Factor.
- (2) Margin Level = Measurement Value - Limit Value.

Test Mode: TX N-40M Mode 2422 MHz

Vertical

80 dBuV/m

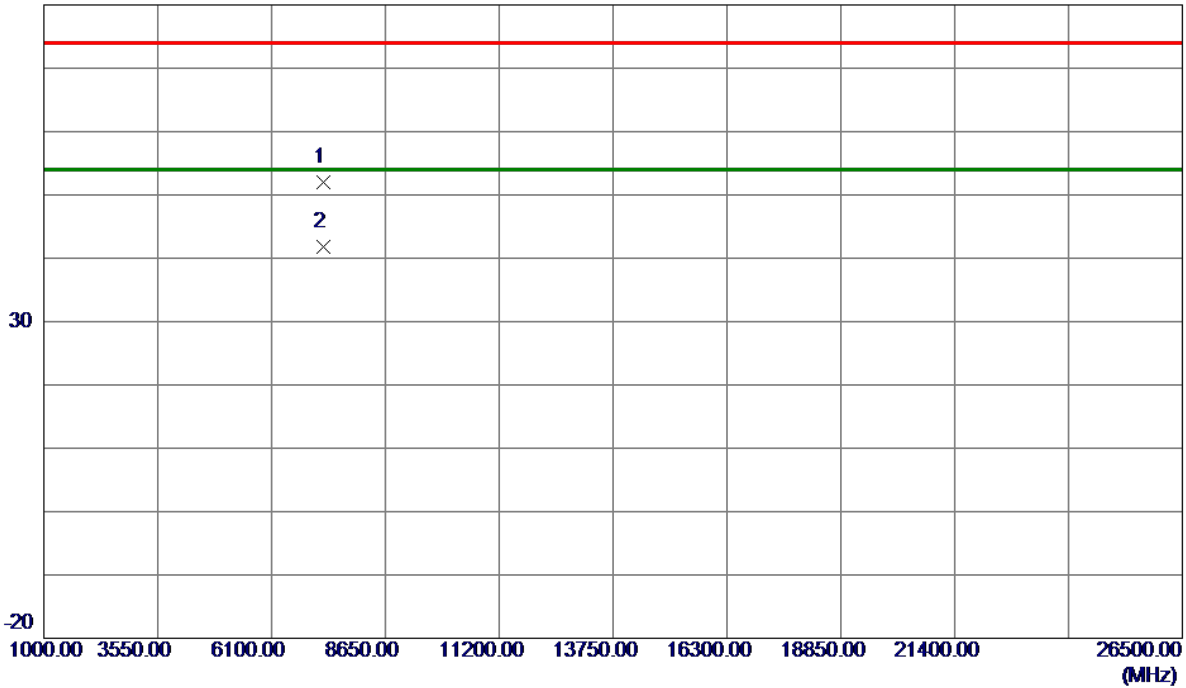

No.	Freq. MHz	Reading Level dBuV/m	Correct Factor dB	Measure ment dBuV/m	Limit dBuV/m	Margin dB	Detector	Comment
1	7259.6000	41.83	10.23	52.06	74.00	-21.94	Peak	
2 *	7265.8000	31.49	10.24	41.73	54.00	-12.27	AVG	

REMARKS:

- (1) Measurement Value = Reading Level + Correct Factor.
- (2) Margin Level = Measurement Value - Limit Value.

Test Mode: TX N-40M Mode 2422 MHz

Horizontal

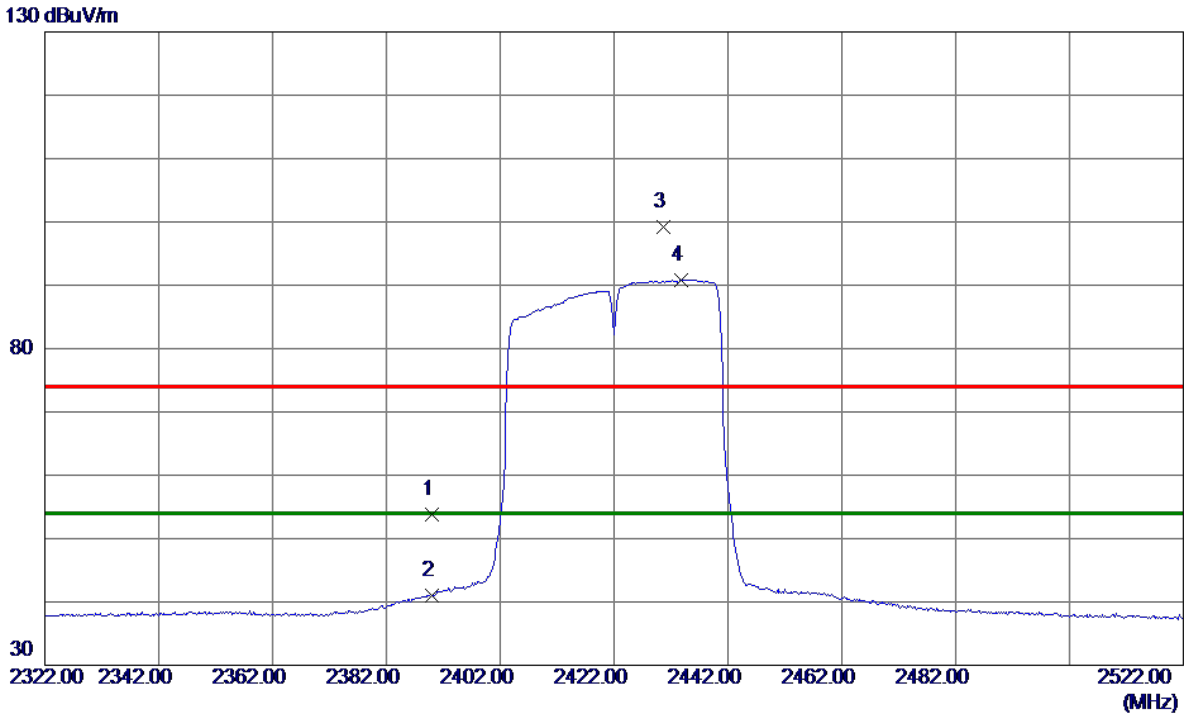

No.	Freq. MHz	Reading Level dBuV/m	Correct Factor dB	Measure ment dBuV/m	Limit dBuV/m	Margin dB	Detector	Comment
1	2390.0000	46.53	7.26	53.79	74.00	-20.21	Peak	
2	2390.0000	33.79	7.26	41.05	54.00	-12.95	AVG	
3	2430.6000	91.93	7.25	99.18	74.00	25.18	Peak	No Limit
4 *	2433.8000	83.59	7.25	90.84	54.00	36.84	AVG	No Limit

REMARKS:

(1) Measurement Value = Reading Level + Correct Factor.

(2) Margin Level = Measurement Value - Limit Value.

Test Mode: TX N-40M Mode 2422 MHz

Horizontal

80 dBuV/m

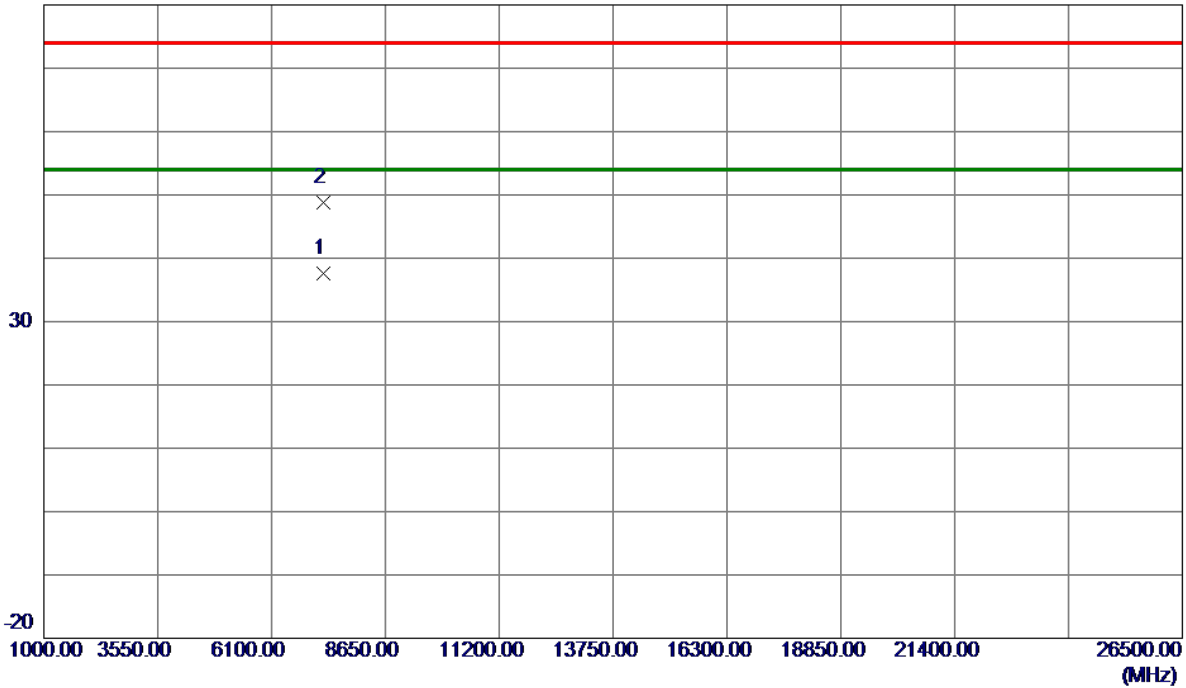

No.	Freq. MHz	Reading Level dBuV/m	Correct Factor dB	Measure ment dBuV/m	Limit dBuV/m	Margin dB	Detector	Comment
1 *	7264.1850	27.45	10.24	37.69	54.00	-16.31	AVG	
2	7265.1850	38.56	10.24	48.80	74.00	-25.20	Peak	

REMARKS:

- (1) Measurement Value = Reading Level + Correct Factor.
- (2) Margin Level = Measurement Value - Limit Value.

Test Mode: TX N-40M Mode 2437 MHz

Vertical

130 dBuV/m

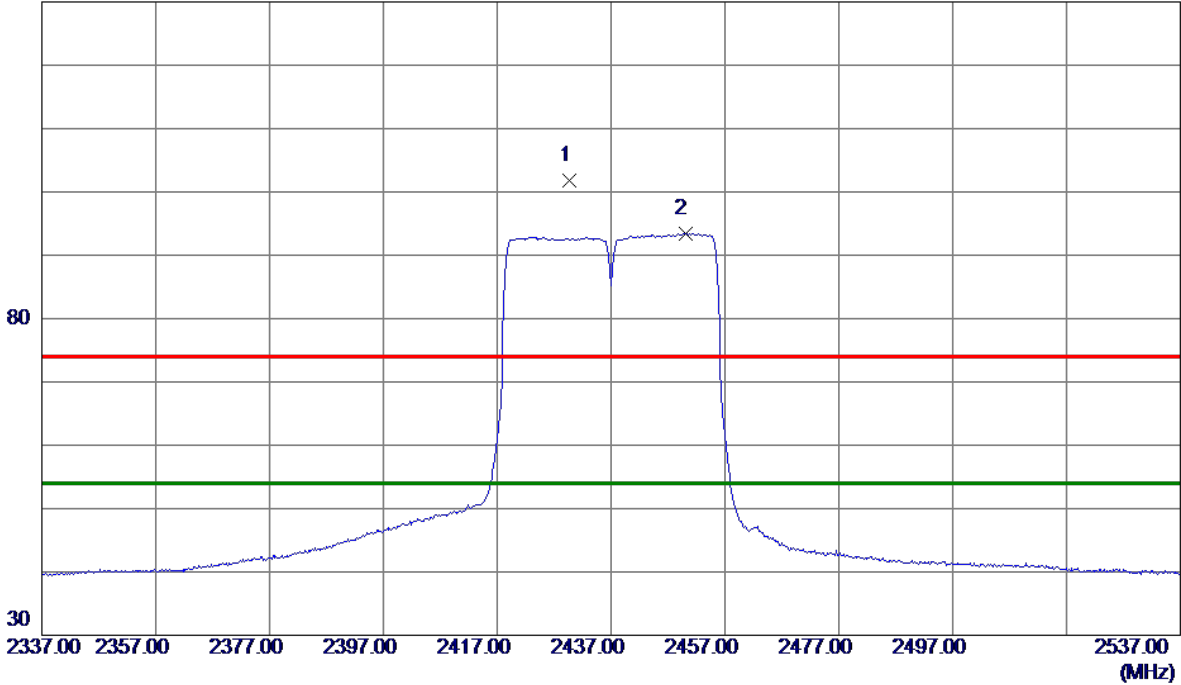

No.	Freq. MHz	Reading Level dBuV/m	Correct Factor dB	Measure ment dBuV/m	Limit dBuV/m	Margin dB	Detector	Comment
1	2429.6000	94.46	7.25	101.71	74.00	27.71	Peak	No Limit
2 *	2450.0000	86.15	7.25	93.40	54.00	39.40	AVG	No Limit

REMARKS:

- (1) Measurement Value = Reading Level + Correct Factor.
- (2) Margin Level = Measurement Value - Limit Value.

Test Mode: TX N-40M Mode 2437 MHz

Vertical

80 dBuV/m

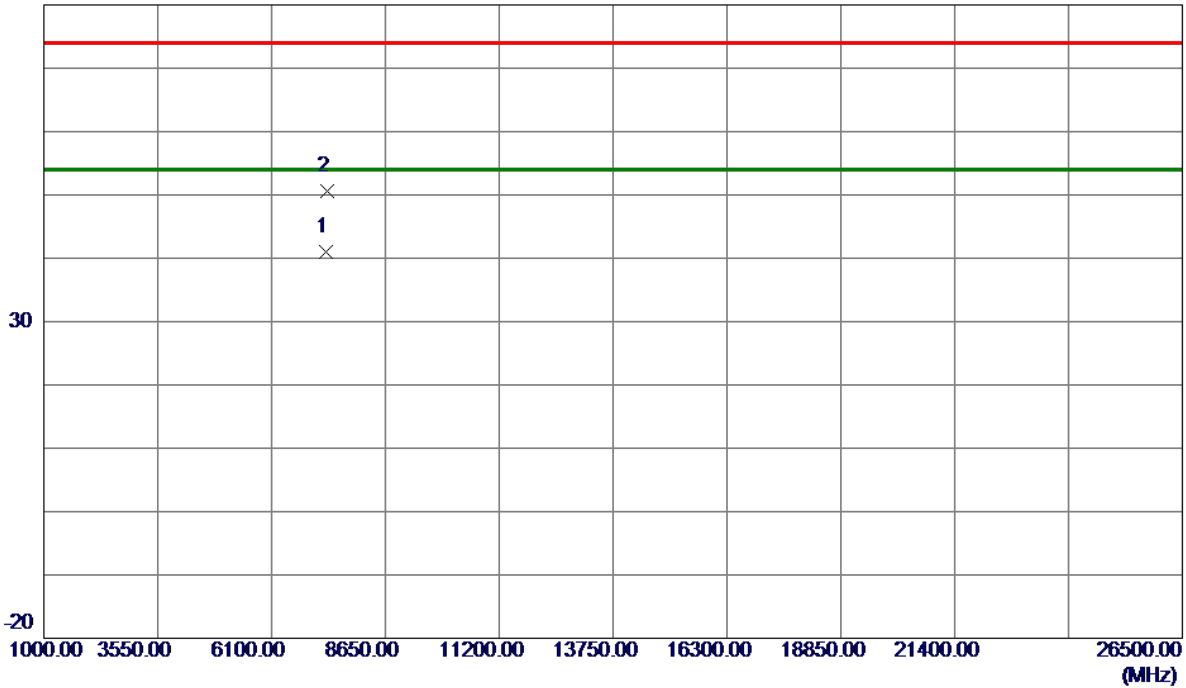

No.	Freq. MHz	Reading Level dBuV/m	Correct Factor dB	Measure ment dBuV/m	Limit dBuV/m	Margin dB	Detector	Comment
1 *	7310.9000	30.63	10.32	40.95	54.00	-13.05	AVG	
2	7339.4000	40.22	10.37	50.59	74.00	-23.41	Peak	

REMARKS:

- (1) Measurement Value = Reading Level + Correct Factor.
- (2) Margin Level = Measurement Value - Limit Value.

Test Mode: TX N-40M Mode 2437 MHz

Horizontal

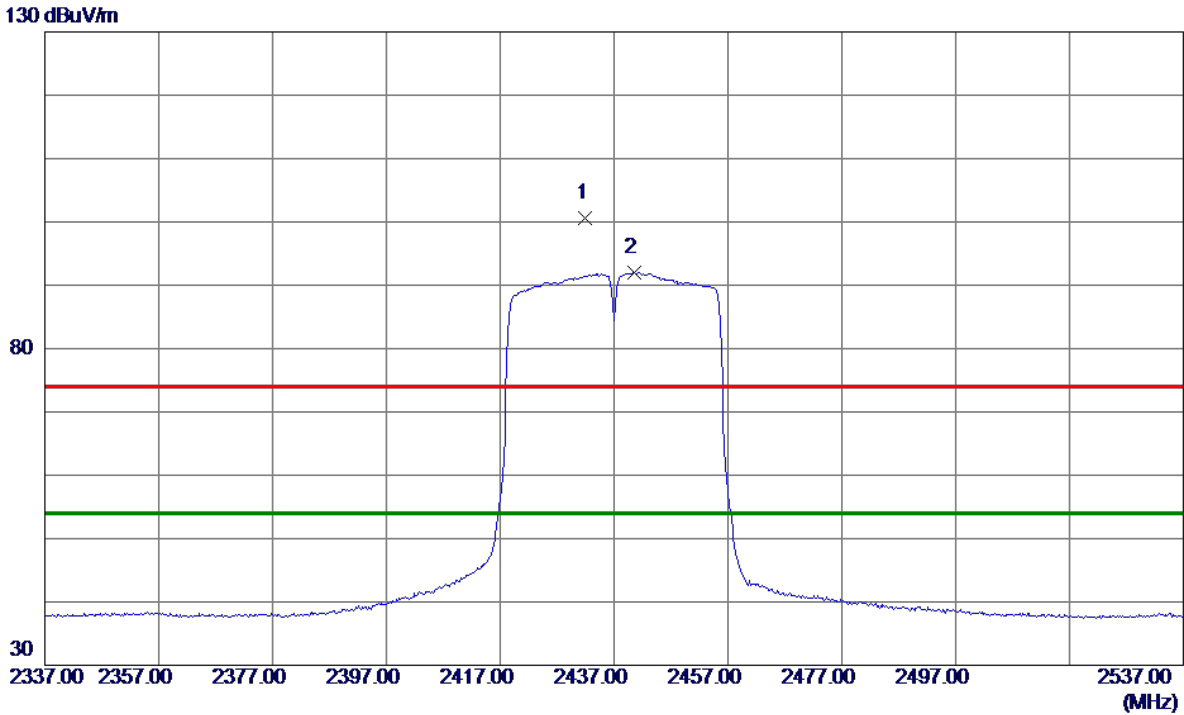

No.	Freq. MHz	Reading Level dBuV/m	Correct Factor dB	Measure ment dBuV/m	Limit dBuV/m	Margin dB	Detector	Comment
1	2432.0000	93.26	7.25	100.51	74.00	26.51	Peak	No Limit
2 *	2440.6000	84.80	7.25	92.05	54.00	38.05	AVG	No Limit

REMARKS:

(1) Measurement Value = Reading Level + Correct Factor.

(2) Margin Level = Measurement Value - Limit Value.

Test Mode: TX N-40M Mode 2437 MHz

Horizontal

80 dBuV/m

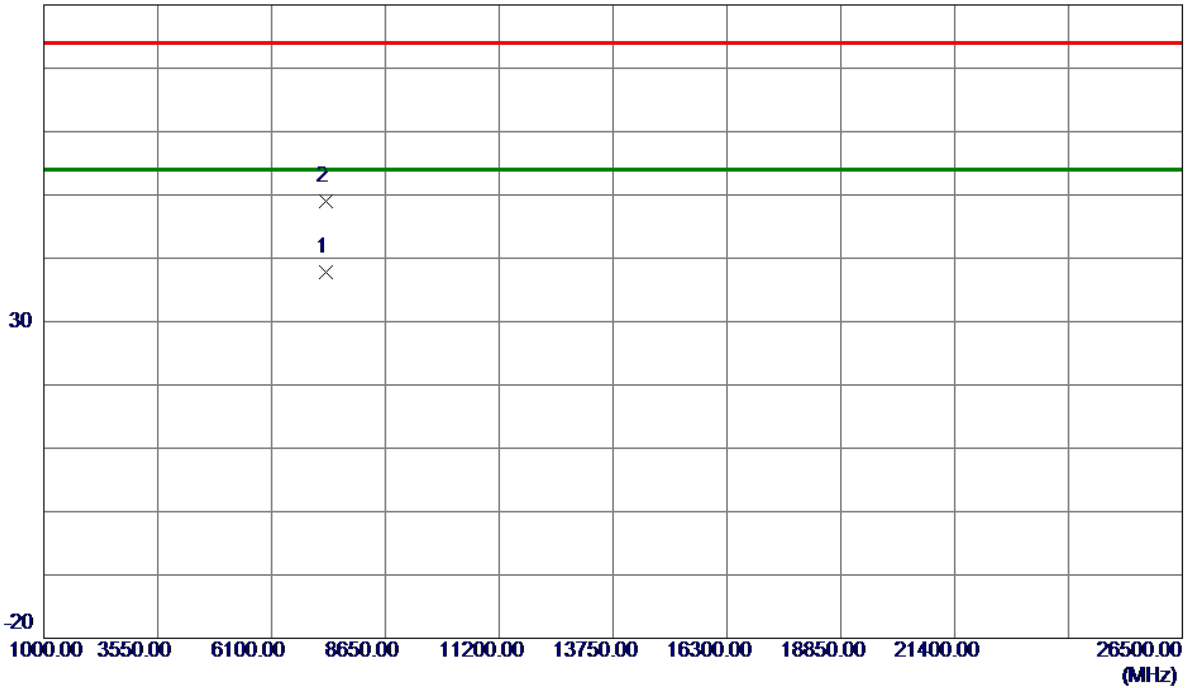

No.	Freq. MHz	Reading Level dBuV/m	Correct Factor dB	Measure ment dBuV/m	Limit dBuV/m	Margin dB	Detector	Comment
1 *	7307.0500	27.47	10.31	37.78	54.00	-16.22	AVG	
2	7308.3500	38.64	10.31	48.95	74.00	-25.05	Peak	

REMARKS:

- (1) Measurement Value = Reading Level + Correct Factor.
- (2) Margin Level = Measurement Value - Limit Value.

Test Mode: TX N-40M Mode 2452 MHz

Vertical

130 dBuV/m

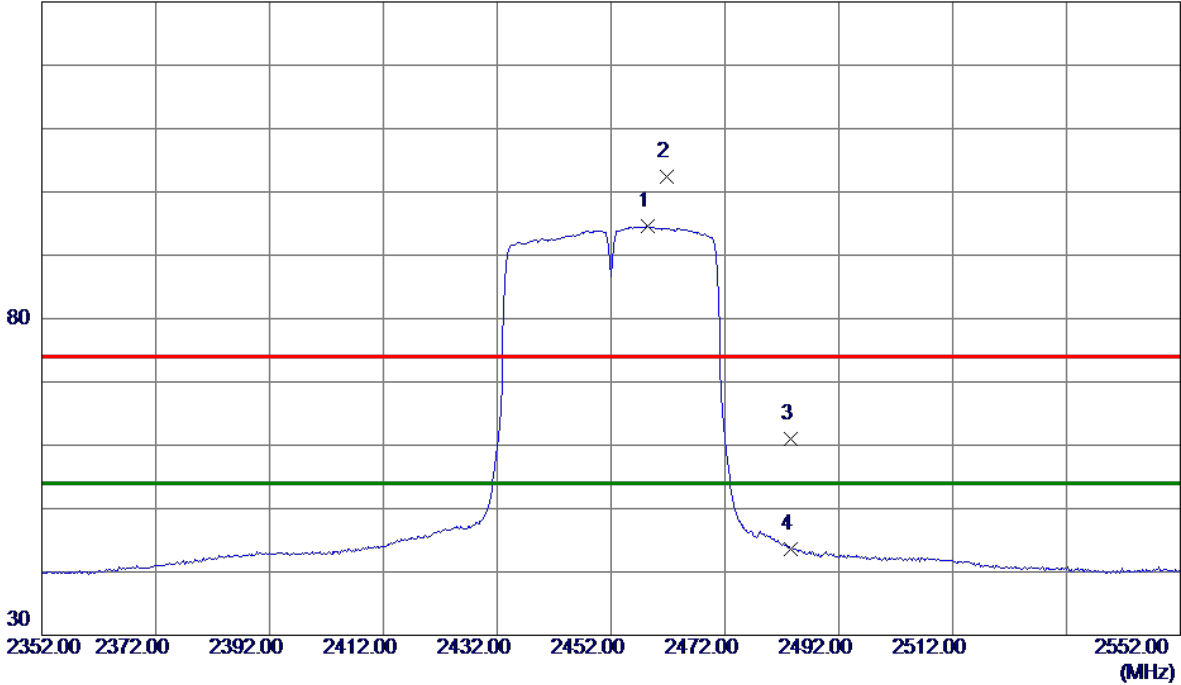

No.	Freq. MHz	Reading Level dBuV/m	Correct Factor dB	Measure ment dBuV/m	Limit dBuV/m	Margin dB	Detector	Comment
1 *	2458.4000	87.30	7.25	94.55	54.00	40.55	AVG	No Limit
2	2461.8000	95.10	7.25	102.35	74.00	28.35	Peak	No Limit
3	2483.5000	53.74	7.25	60.99	74.00	-13.01	Peak	
4	2483.5000	36.39	7.25	43.64	54.00	-10.36	AVG	

REMARKS:

- (1) Measurement Value = Reading Level + Correct Factor.
- (2) Margin Level = Measurement Value - Limit Value.

Test Mode: TX N-40M Mode 2452 MHz

Vertical

80 dBuV/m

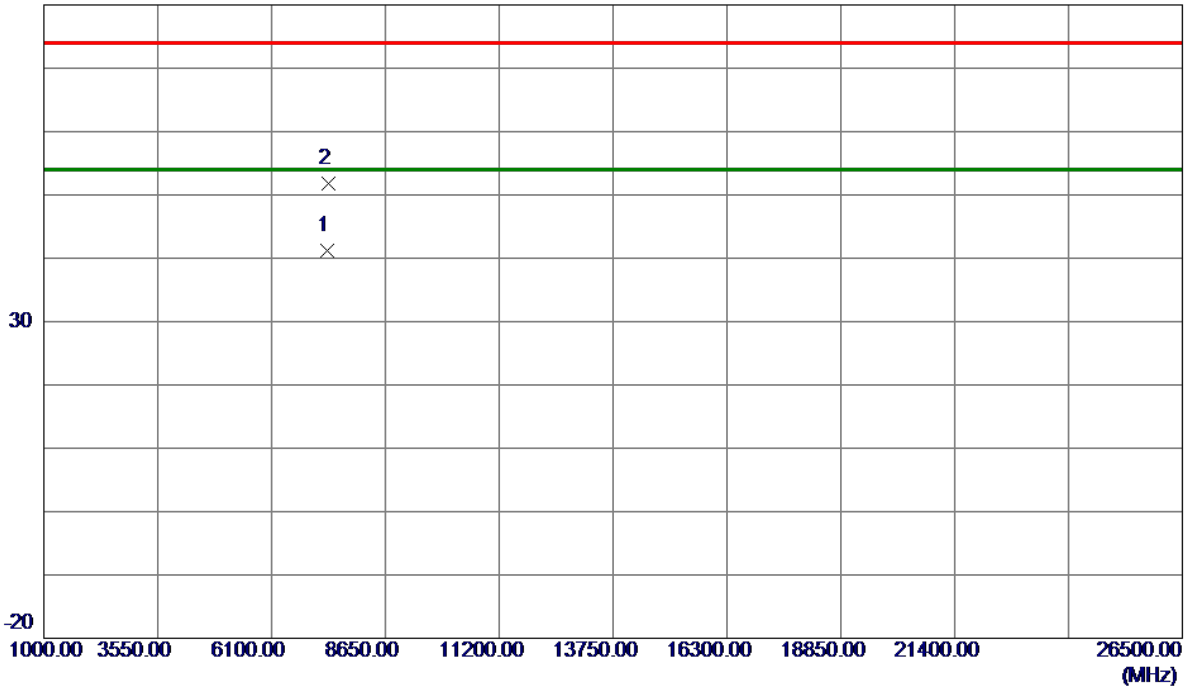

No.	Freq. MHz	Reading Level dBuV/m	Correct Factor dB	Measure ment dBuV/m	Limit dBuV/m	Margin dB	Detector	Comment
1 *	7355.1000	30.89	10.39	41.28	54.00	-12.72	AVG	
2	7360.9000	41.31	10.40	51.71	74.00	-22.29	Peak	

REMARKS:

- (1) Measurement Value = Reading Level + Correct Factor.
- (2) Margin Level = Measurement Value - Limit Value.

Test Mode: TX N-40M Mode 2452 MHz

Horizontal

130 dBuV/m

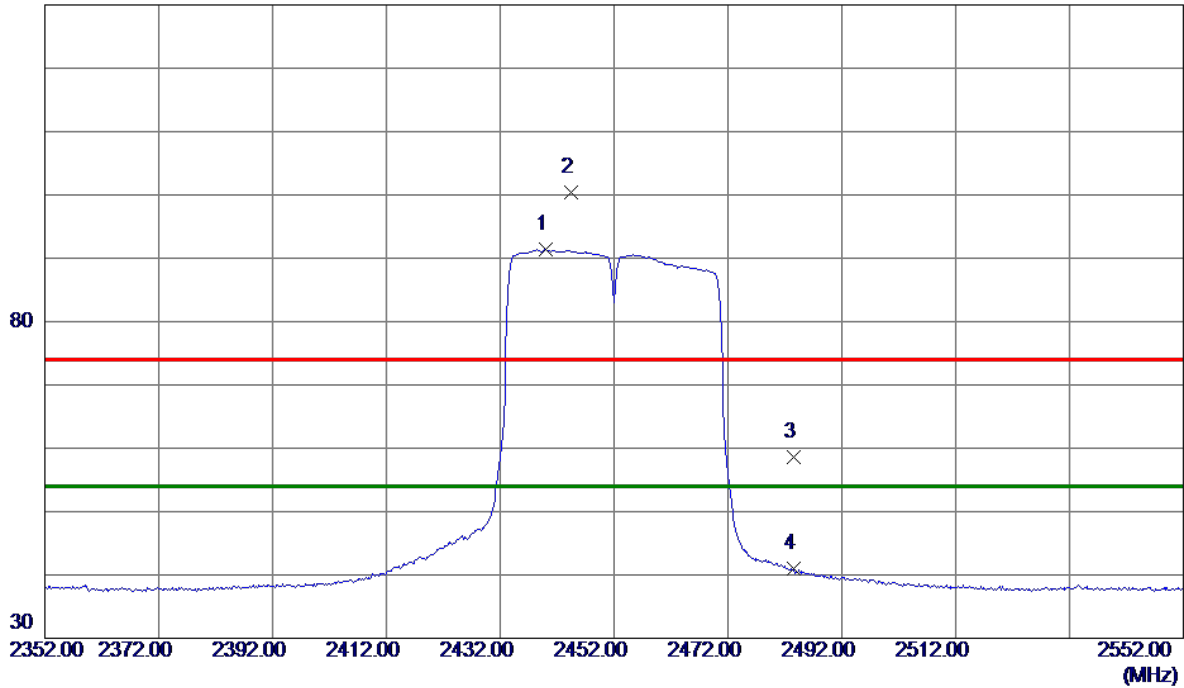

No.	Freq. MHz	Reading Level dBuV/m	Correct Factor dB	Measure ment dBuV/m	Limit dBuV/m	Margin dB	Detector	Comment
1 *	2440.0000	84.14	7.25	91.39	54.00	37.39	AVG	No Limit
2	2444.4000	93.11	7.25	100.36	74.00	26.36	Peak	No Limit
3	2483.5000	51.32	7.25	58.57	74.00	-15.43	Peak	
4	2483.5000	33.80	7.25	41.05	54.00	-12.95	AVG	

REMARKS:

(1) Measurement Value = Reading Level + Correct Factor.

(2) Margin Level = Measurement Value - Limit Value.

Test Mode: TX N-40M Mode 2452 MHz

Horizontal

80 dBuV/m

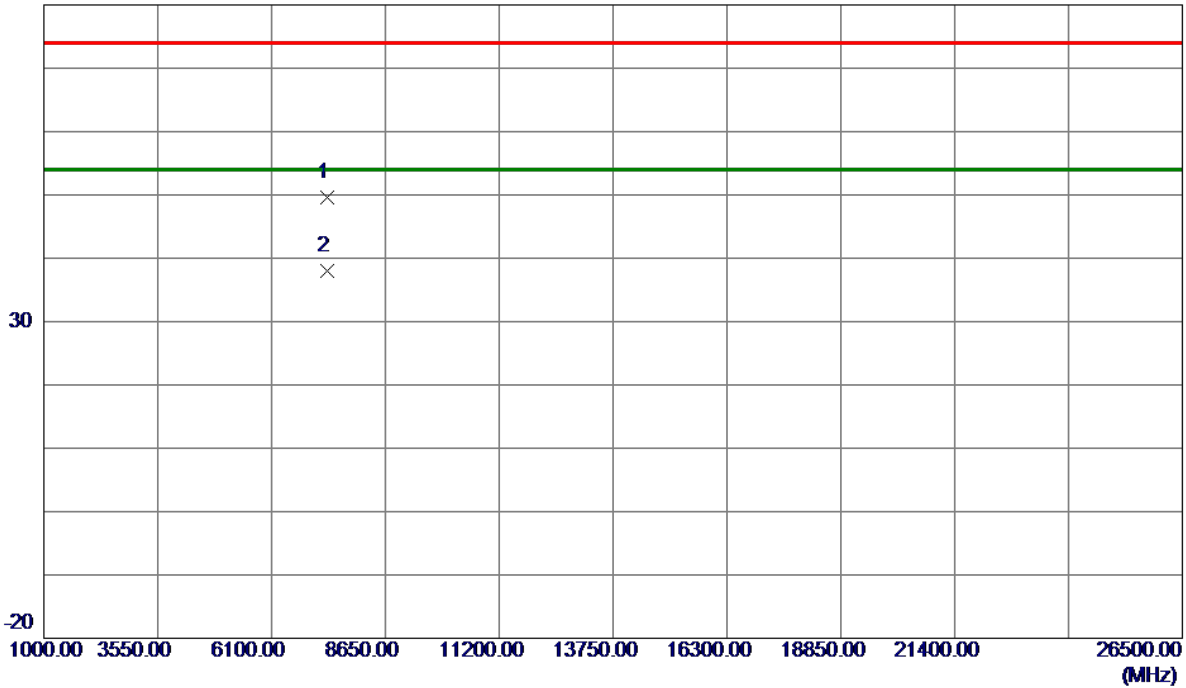

No.	Freq. MHz	Reading Level dBuV/m	Correct Factor dB	Measure ment dBuV/m	Limit dBuV/m	Margin dB	Detector	Comment
1	7351.6050	39.18	10.39	49.57	74.00	-24.43	Peak	
2 *	7353.5200	27.55	10.39	37.94	54.00	-16.06	AVG	

REMARKS:

- (1) Measurement Value = Reading Level + Correct Factor.
- (2) Margin Level = Measurement Value - Limit Value.

Test Mode: TX AX-20M Mode 2412 MHz

Vertical

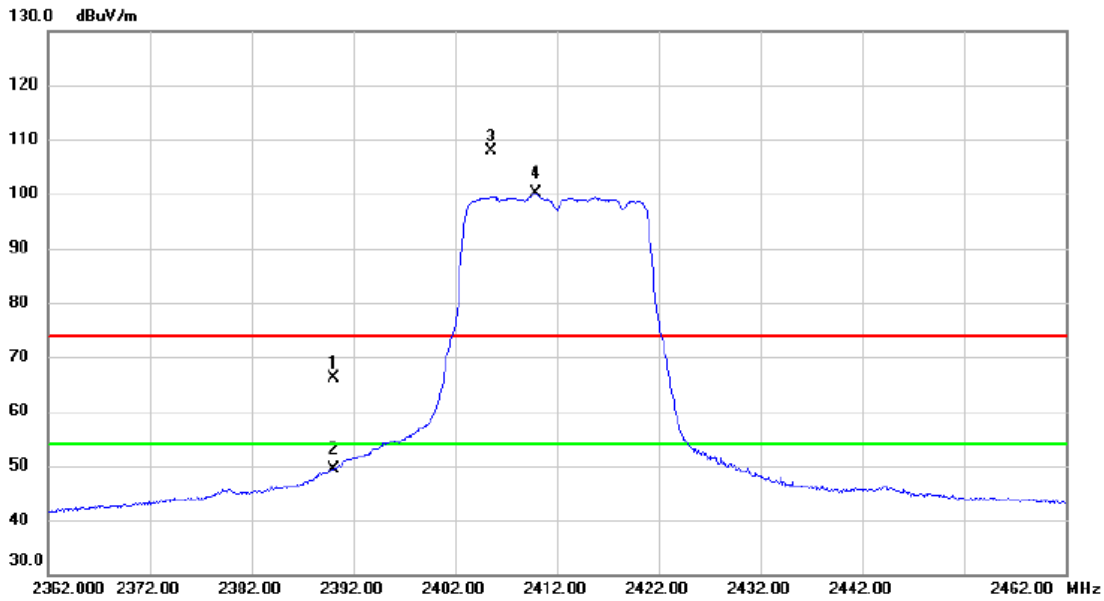

No.	Mk.	Freq. MHz	Reading Level dBuV	Correct Factor dB	Measure- ment dBuV/m	Limit dBuV/m	Margin dB	Detector	Comment
1		2390.000	58.89	7.26	66.15	74.00	-7.85	peak	
2		2390.000	42.16	7.26	49.42	54.00	-4.58	AVG	
3	X	2405.600	100.69	7.26	107.95	74.00	33.95	peak	No Limit
4	*	2409.900	92.94	7.25	100.19	54.00	46.19	AVG	No Limit

REMARKS:

- (1) Measurement Value = Reading Level + Correct Factor.
- (2) Margin Level = Measurement Value - Limit Value.

Test Mode: TX AX-20M Mode 2412 MHz

Vertical

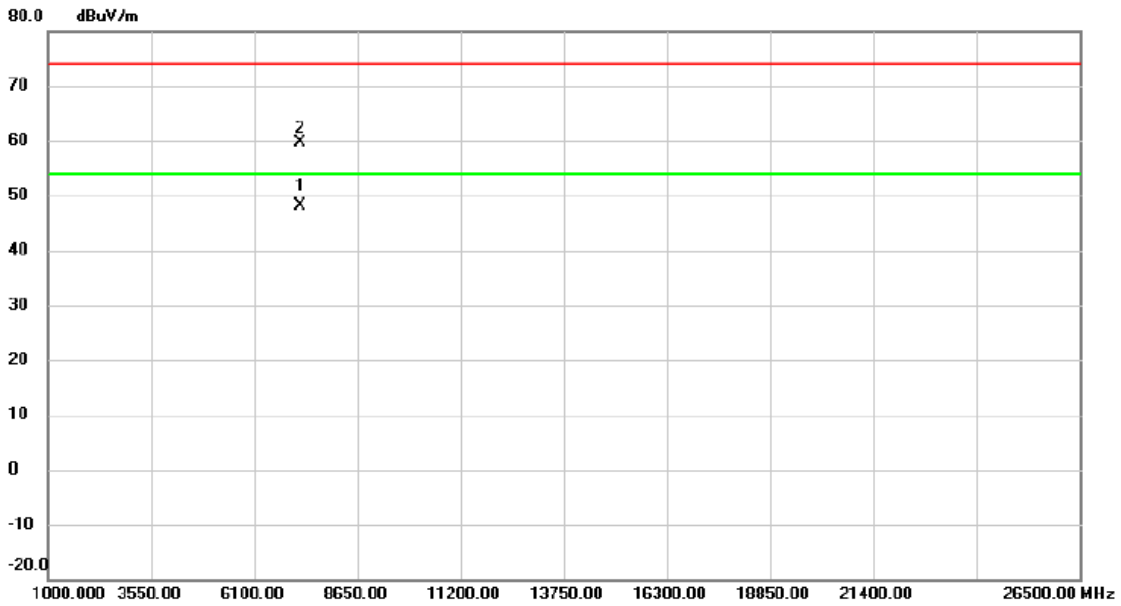

No.	Mk.	Freq. MHz	Reading Level dBuV	Correct Factor dB	Measure- ment dBuV/m	Limit dBuV/m	Margin dB	Detector	Comment
1	*	7235.650	38.01	10.19	48.20	54.00	-5.80	AVG	
2		7237.050	49.38	10.19	59.57	74.00	-14.43	peak	

REMARKS:

- (1) Measurement Value = Reading Level + Correct Factor.
- (2) Margin Level = Measurement Value - Limit Value.

Test Mode: TX AX-20M Mode 2412 MHz

Horizontal

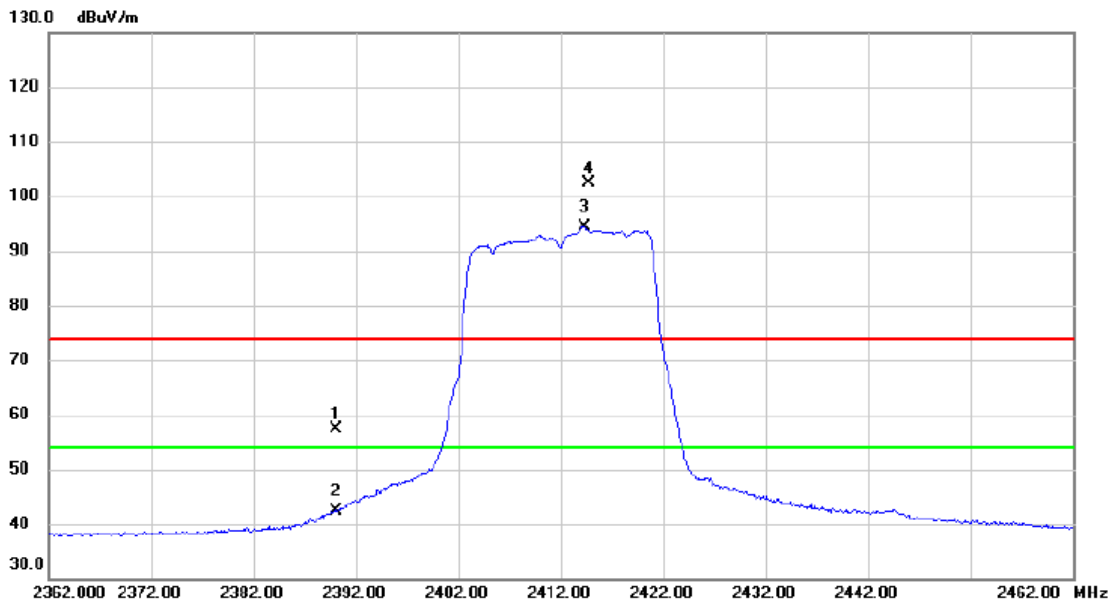

No.	Mk.	Freq. MHz	Reading Level dBuV	Correct Factor dB	Measure- ment dBuV/m	Limit dBuV/m	Margin dB	Detector	Comment
1		2390.000	50.17	7.26	57.43	74.00	-16.57	peak	
2		2390.000	35.03	7.26	42.29	54.00	-11.71	AVG	
3	*	2414.300	87.09	7.26	94.35	54.00	40.35	AVG	No Limit
4	X	2414.700	95.01	7.26	102.27	74.00	28.27	peak	No Limit

REMARKS:

- (1) Measurement Value = Reading Level + Correct Factor.
- (2) Margin Level = Measurement Value - Limit Value.

Test Mode: TX AX-20M Mode 2412 MHz

Horizontal

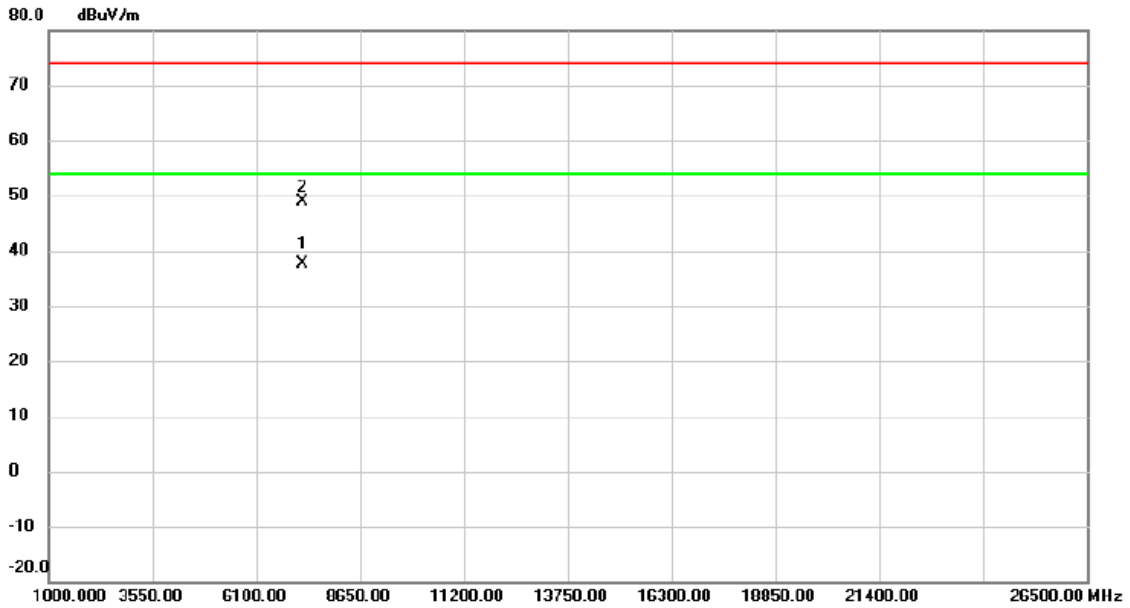

No.	Mk.	Freq. MHz	Reading Level dBuV	Correct Factor dB	Measure- ment dBuV/m	Limit dBuV/m	Margin dB	Detector	Comment
1	*	7234.005	27.55	10.19	37.74	54.00	-16.26	AVG	
2		7237.305	38.71	10.19	48.90	74.00	-25.10	peak	

REMARKS:

- (1) Measurement Value = Reading Level + Correct Factor.
- (2) Margin Level = Measurement Value - Limit Value.

Test Mode: TX AX-20M Mode 2437 MHz

Vertical

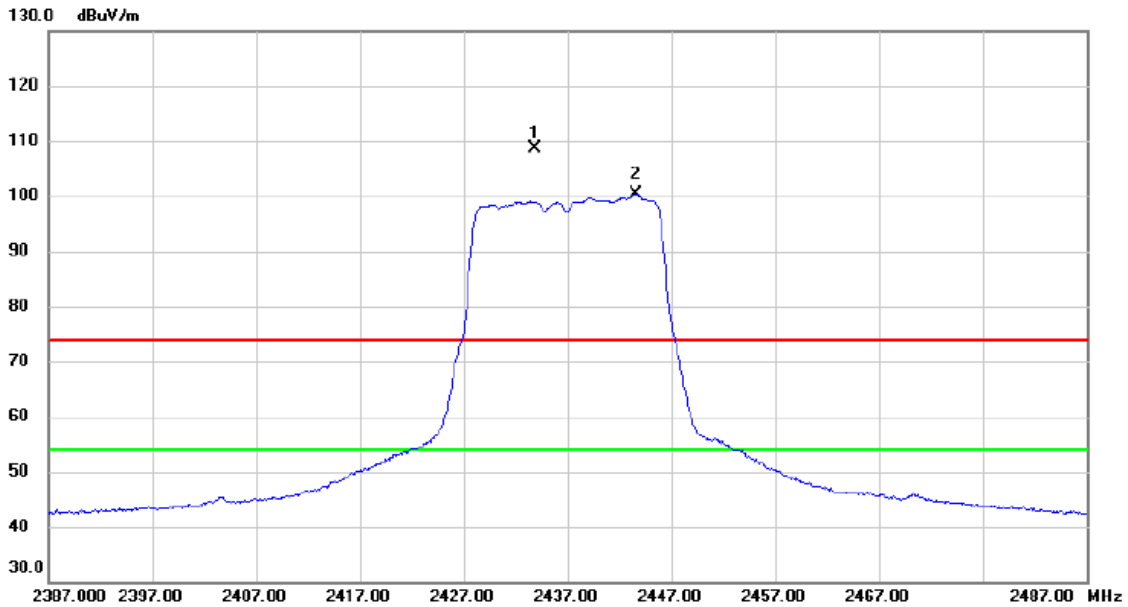

No.	Mk.	Freq. MHz	Reading Level dBuV	Correct Factor dB	Measure- ment dBuV/m	Limit dBuV/m	Margin dB	Detector	Comment
1	X	2433.800	101.47	7.26	108.73	74.00	34.73	peak	No Limit
2	*	2443.600	93.16	7.25	100.41	54.00	46.41	AVG	No Limit

REMARKS:

(1) Measurement Value = Reading Level + Correct Factor.

(2) Margin Level = Measurement Value - Limit Value.

Test Mode: TX AX-20M Mode 2437 MHz

Vertical

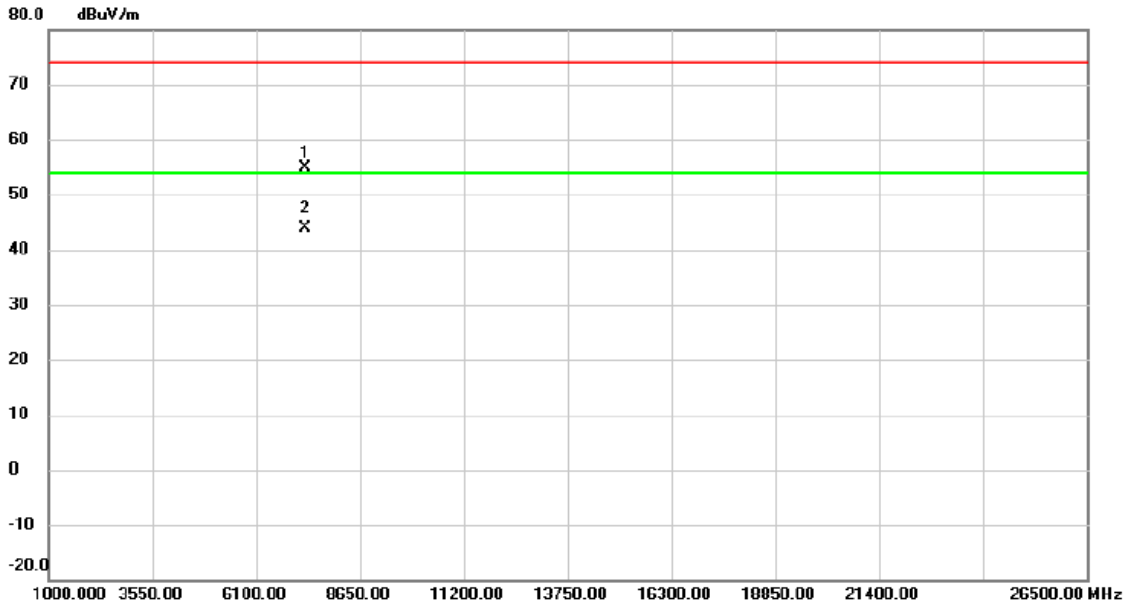

No.	Mk.	Freq. MHz	Reading Level dBuV	Correct Factor dB	Measure- ment dBuV/m	Limit dBuV/m	Margin dB	Detector	Comment
1		7305.200	44.57	10.31	54.88	74.00	-19.12	peak	
2	*	7310.600	33.50	10.31	43.81	54.00	-10.19	AVG	

REMARKS:

- (1) Measurement Value = Reading Level + Correct Factor.
- (2) Margin Level = Measurement Value - Limit Value.

Test Mode: TX AX-20M Mode 2437 MHz

Horizontal

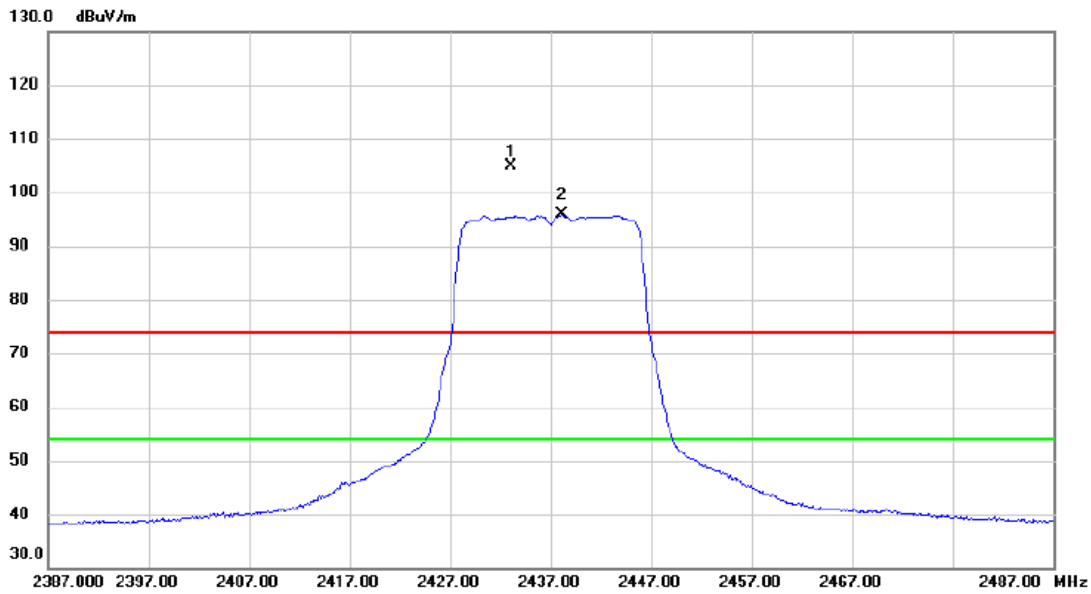

No.	Mk.	Freq.	Reading Level	Correct Factor	Measurement	Limit	Margin	Detector	Comment
		MHz	dBuV	dB	dBuV/m	dBuV/m	dB		
1	X	2433.100	97.61	7.25	104.86	74.00	30.86	peak	No Limit
2	*	2438.200	88.52	7.25	95.77	54.00	41.77	AVG	No Limit

REMARKS:

- (1) Measurement Value = Reading Level + Correct Factor.
- (2) Margin Level = Measurement Value - Limit Value.

Test Mode: TX AX-20M Mode 2437 MHz

Horizontal

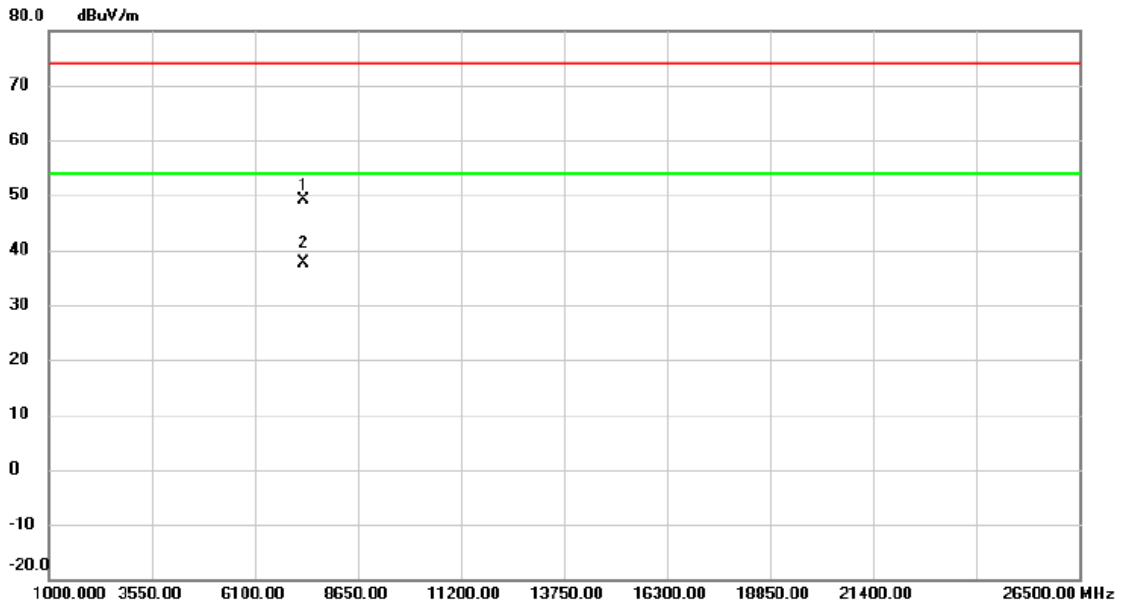

No. Mk.	Freq. MHz	Reading Level dBuV	Correct Factor dB	Measure- ment dBuV/m	Limit dBuV/m	Margin dB	Detector	Comment
1	7309.705	38.77	10.31	49.08	74.00	-24.92	peak	
2 *	7312.255	27.35	10.32	37.67	54.00	-16.33	AVG	

REMARKS:

(1) Measurement Value = Reading Level + Correct Factor.

(2) Margin Level = Measurement Value - Limit Value.

Test Mode: TX AX-20M Mode 2462 MHz

Vertical

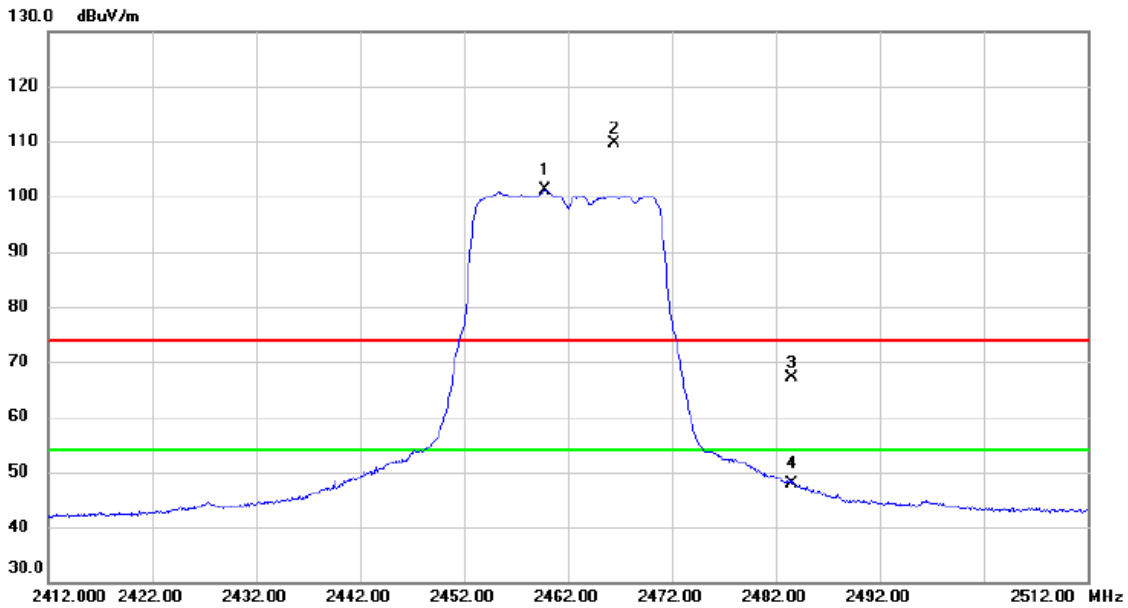

No.	Mk.	Freq. MHz	Reading Level dBuV	Correct Factor dB	Measure- ment dBuV/m	Limit dBuV/m	Margin dB	Detector	Comment
1	*	2459.800	93.99	7.26	101.25	54.00	47.25	AVG	No Limit
2	X	2466.400	102.33	7.25	109.58	74.00	35.58	peak	No Limit
3		2483.500	59.92	7.25	67.17	74.00	-6.83	peak	
4		2483.500	40.68	7.25	47.93	54.00	-6.07	AVG	

REMARKS:

- (1) Measurement Value = Reading Level + Correct Factor.
- (2) Margin Level = Measurement Value - Limit Value.

Test Mode: TX AX-20M Mode 2462 MHz

Vertical

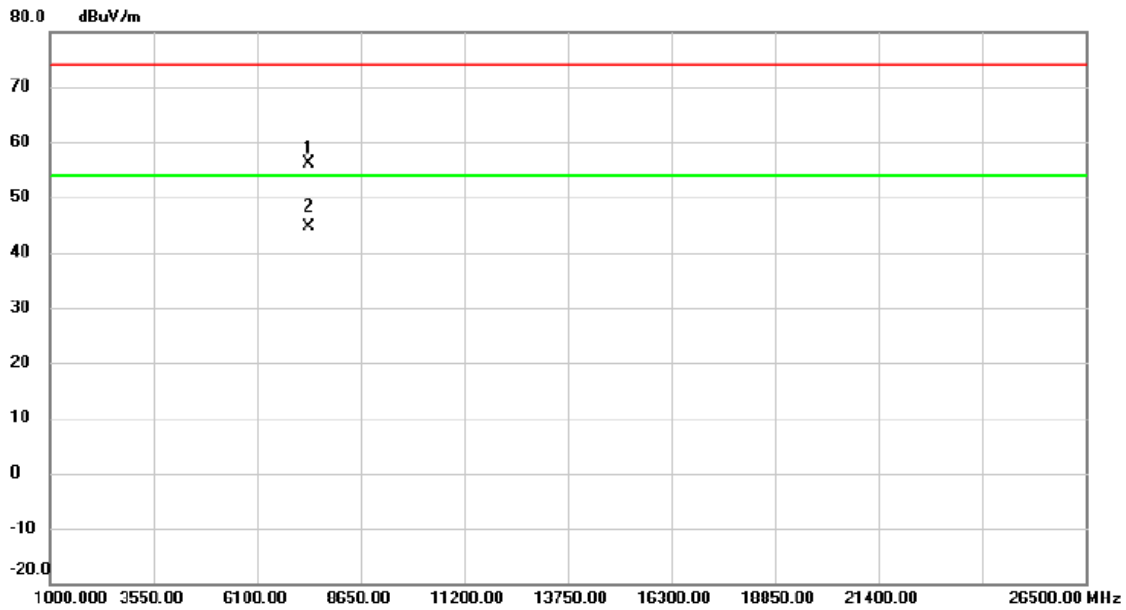

No.	Mk.	Freq.	Reading Level	Correct Factor	Measurement	Limit	Margin	Detector	Comment
		MHz	dBuV	dB	dBuV/m	dBuV/m	dB		
1		7382.750	45.56	10.45	56.01	74.00	-17.99	peak	
2	*	7386.150	34.17	10.45	44.62	54.00	-9.38	AVG	

REMARKS:

(1) Measurement Value = Reading Level + Correct Factor.

(2) Margin Level = Measurement Value - Limit Value.

Test Mode: TX AX-20M Mode 2462 MHz

Horizontal

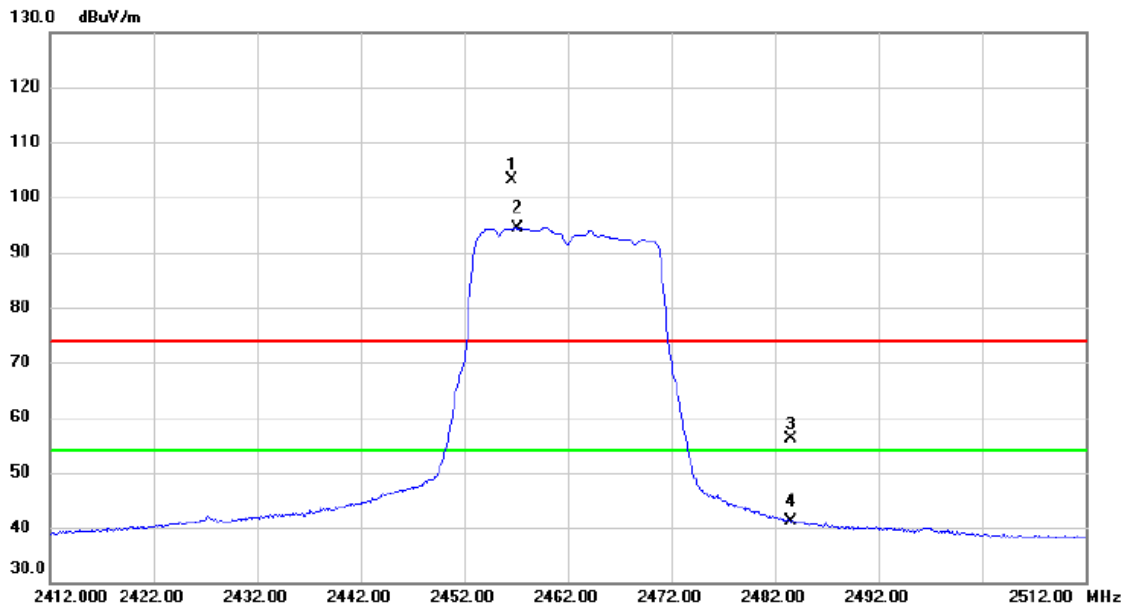

No.	Mk.	Freq. MHz	Reading Level dBuV	Correct Factor dB	Measure- ment dBuV/m	Limit dBuV/m	Margin dB	Detector	Comment
1	X	2456.600	95.83	7.26	103.09	74.00	29.09	peak	No Limit
2	*	2457.100	87.17	7.26	94.43	54.00	40.43	AVG	No Limit
3		2483.500	48.83	7.25	56.08	74.00	-17.92	peak	
4		2483.500	33.98	7.25	41.23	54.00	-12.77	AVG	

REMARKS:

(1) Measurement Value = Reading Level + Correct Factor.

(2) Margin Level = Measurement Value - Limit Value.

Test Mode: TX AX-20M Mode 2462 MHz

Horizontal

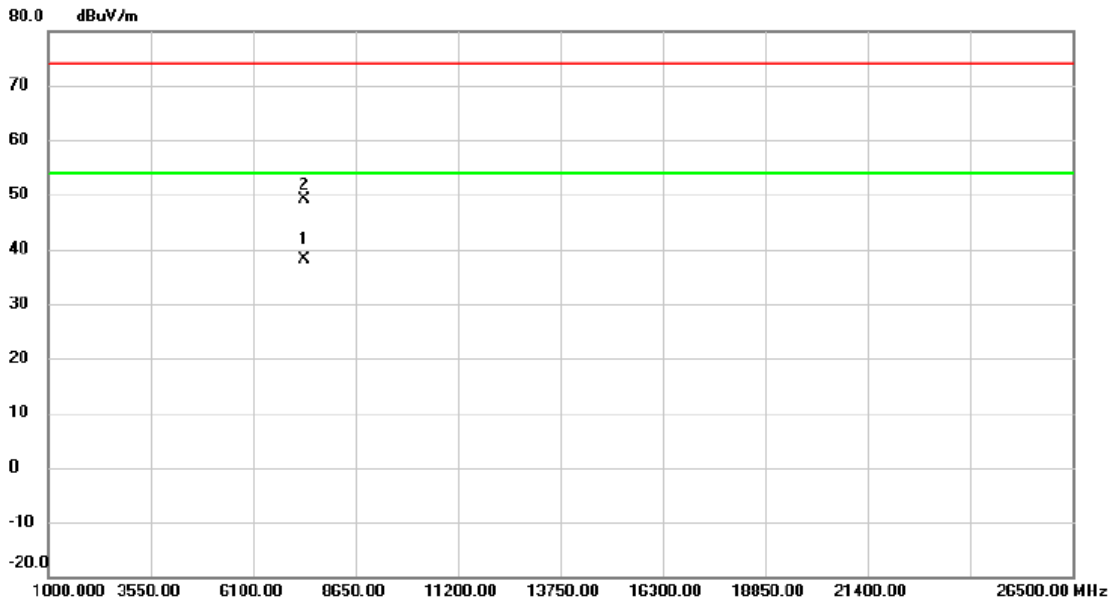

No.	Mk.	Freq. MHz	Reading Level dBuV	Correct Factor dB	Measure- ment dBuV/m	Limit dBuV/m	Margin dB	Detector	Comment
1	*	7381.770	27.80	10.44	38.24	54.00	-15.76	AVG	
2		7383.025	38.69	10.45	49.14	74.00	-24.86	peak	

REMARKS:

(1) Measurement Value = Reading Level + Correct Factor.

(2) Margin Level = Measurement Value - Limit Value.

Test Mode: TX AX-40M Mode 2422 MHz

Vertical

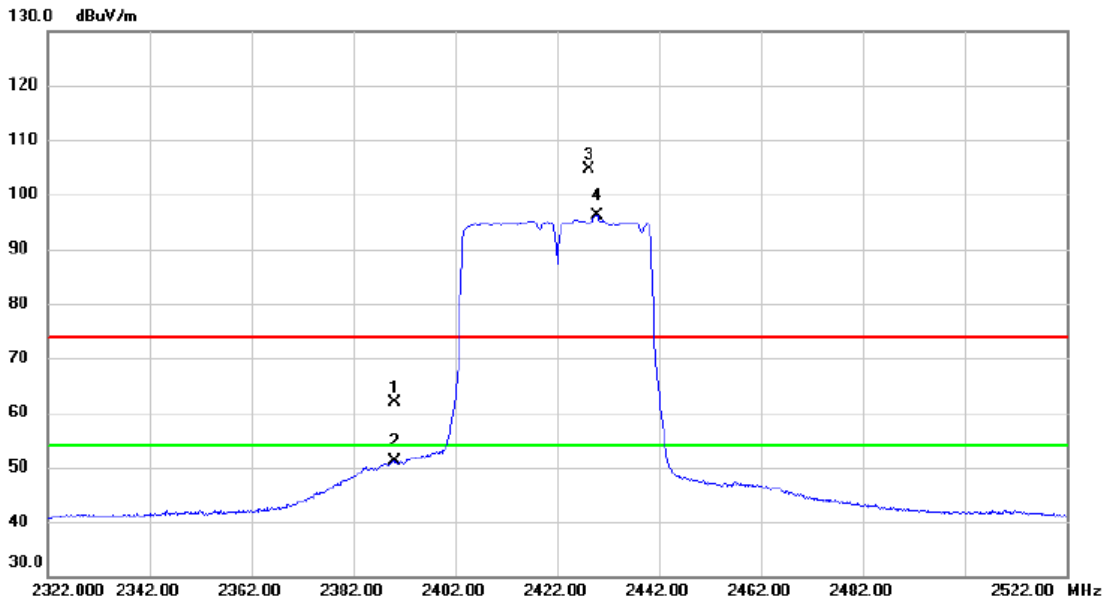

No. Mk.	Freq. MHz	Reading Level dBuV	Correct Factor dB	Measure- ment dBuV/m	Limit dBuV/m	Margin dB	Detector	Comment
1	2390.000	54.59	7.26	61.85	74.00	-12.15	peak	
2	2390.000	43.81	7.26	51.07	54.00	-2.93	AVG	
3 X	2428.200	97.46	7.25	104.71	74.00	30.71	peak	No Limit
4 *	2429.800	88.97	7.25	96.22	54.00	42.22	AVG	No Limit

REMARKS:

- (1) Measurement Value = Reading Level + Correct Factor.
- (2) Margin Level = Measurement Value - Limit Value.

Test Mode: TX AX-40M Mode 2422 MHz

Vertical

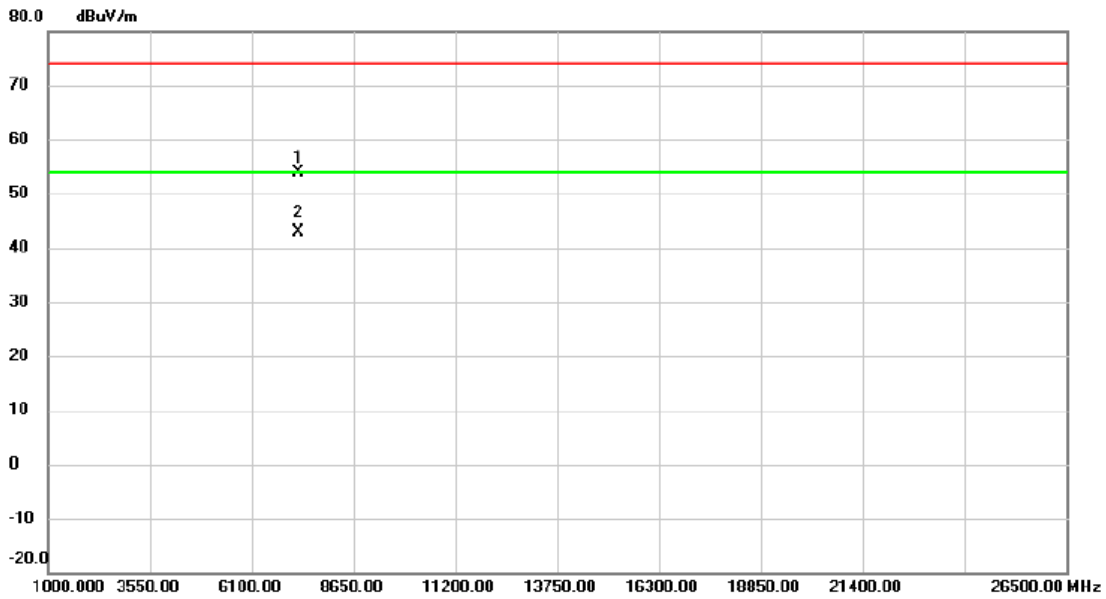

No.	Mk.	Freq. MHz	Reading Level dBuV	Correct Factor dB	Measure- ment dBuV/m	Limit dBuV/m	Margin dB	Detector	Comment
1		7260.300	43.69	10.23	53.92	74.00	-20.08	peak	
2	*	7275.700	32.57	10.27	42.84	54.00	-11.16	AVG	

REMARKS:

- (1) Measurement Value = Reading Level + Correct Factor.
- (2) Margin Level = Measurement Value - Limit Value.

Test Mode: TX AX-40M Mode 2422 MHz

Horizontal

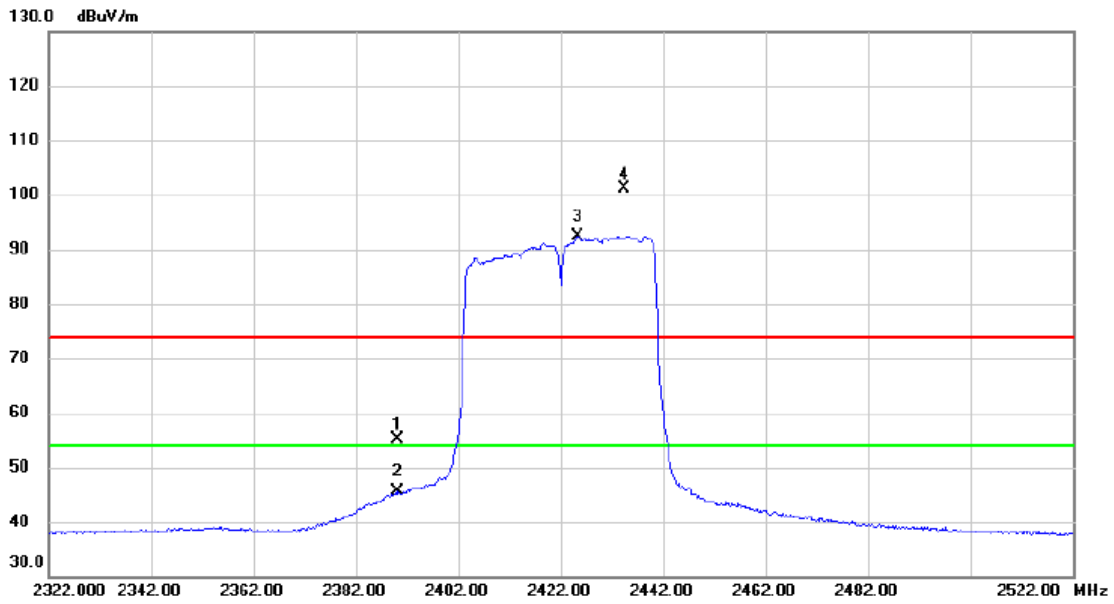

No.	Mk.	Freq. MHz	Reading Level dBuV	Correct Factor dB	Measure- ment dBuV/m	Limit dBuV/m	Margin dB	Detector	Comment
1		2390.000	47.76	7.26	55.02	74.00	-18.98	peak	
2		2390.000	38.26	7.26	45.52	54.00	-8.48	AVG	
3	*	2425.400	85.22	7.25	92.47	54.00	38.47	AVG	No Limit
4	X	2434.400	93.92	7.25	101.17	74.00	27.17	peak	No Limit

REMARKS:

(1) Measurement Value = Reading Level + Correct Factor.

(2) Margin Level = Measurement Value - Limit Value.

Test Mode: TX AX-40M Mode 2422 MHz

Horizontal

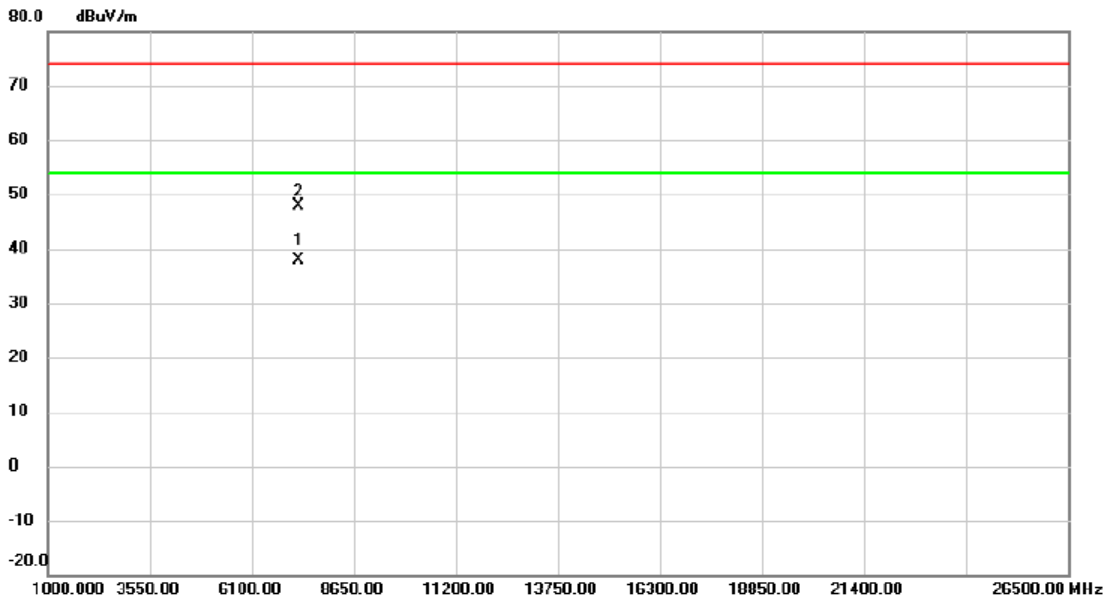

No. Mk.	Freq. MHz	Reading Level dBuV	Correct Factor dB	Measure- ment dBuV/m	Limit dBuV/m	Margin dB	Detector	Comment
1 *	7261.175	27.53	10.24	37.77	54.00	-16.23	AVG	
2	7269.410	37.70	10.25	47.95	74.00	-26.05	peak	

REMARKS:

- (1) Measurement Value = Reading Level + Correct Factor.
- (2) Margin Level = Measurement Value - Limit Value.

Test Mode: TX AX-40M Mode 2437 MHz

Vertical

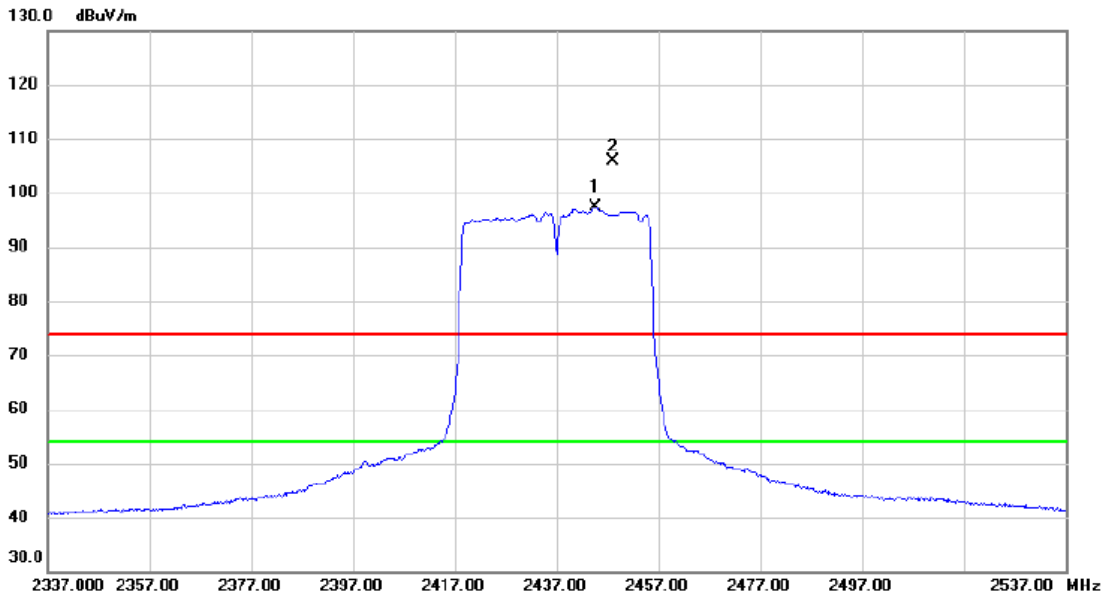

No.	Mk.	Freq. MHz	Reading Level dBuV	Correct Factor dB	Measure- ment dBuV/m	Limit dBuV/m	Margin dB	Detector	Comment
1	*	2444.600	90.21	7.25	97.46	54.00	43.46	AVG	No Limit
2	X	2448.200	98.75	7.25	106.00	74.00	32.00	peak	No Limit

REMARKS:

- (1) Measurement Value = Reading Level + Correct Factor.
- (2) Margin Level = Measurement Value - Limit Value.

Test Mode: TX AX-40M Mode 2437 MHz

Vertical

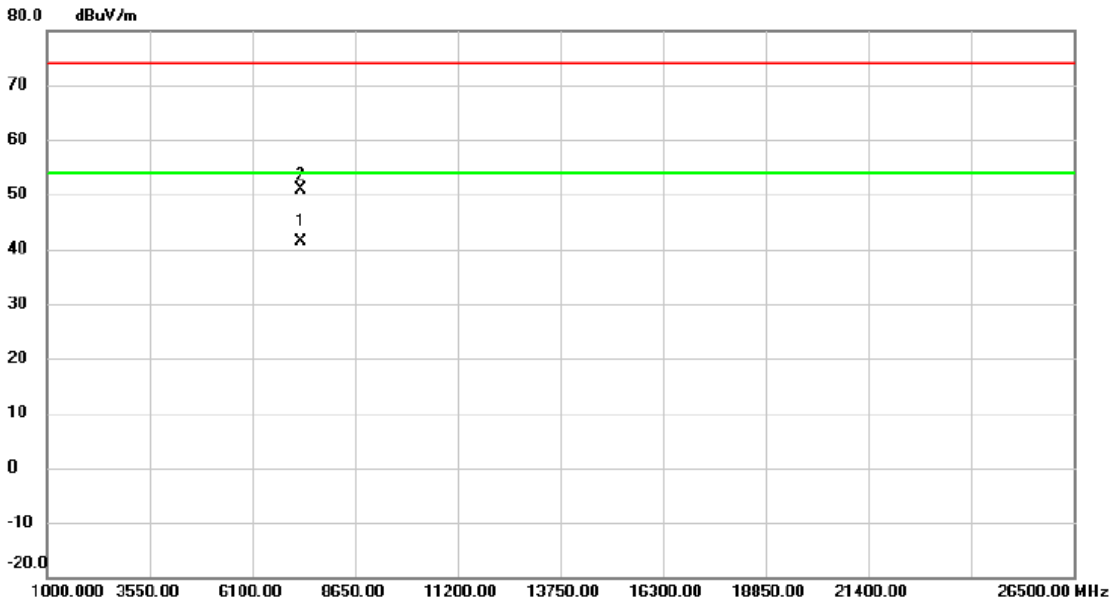

No.	Mk.	Freq. MHz	Reading Level dBuV	Correct Factor dB	Measure- ment dBuV/m	Limit dBuV/m	Margin dB	Detector	Comment
1	*	7310.800	31.00	10.32	41.32	54.00	-12.68	AVG	
2		7321.600	40.67	10.33	51.00	74.00	-23.00	peak	

REMARKS:

(1) Measurement Value = Reading Level + Correct Factor.

(2) Margin Level = Measurement Value - Limit Value.

Test Mode: TX AX-40M Mode 2437 MHz

Horizontal

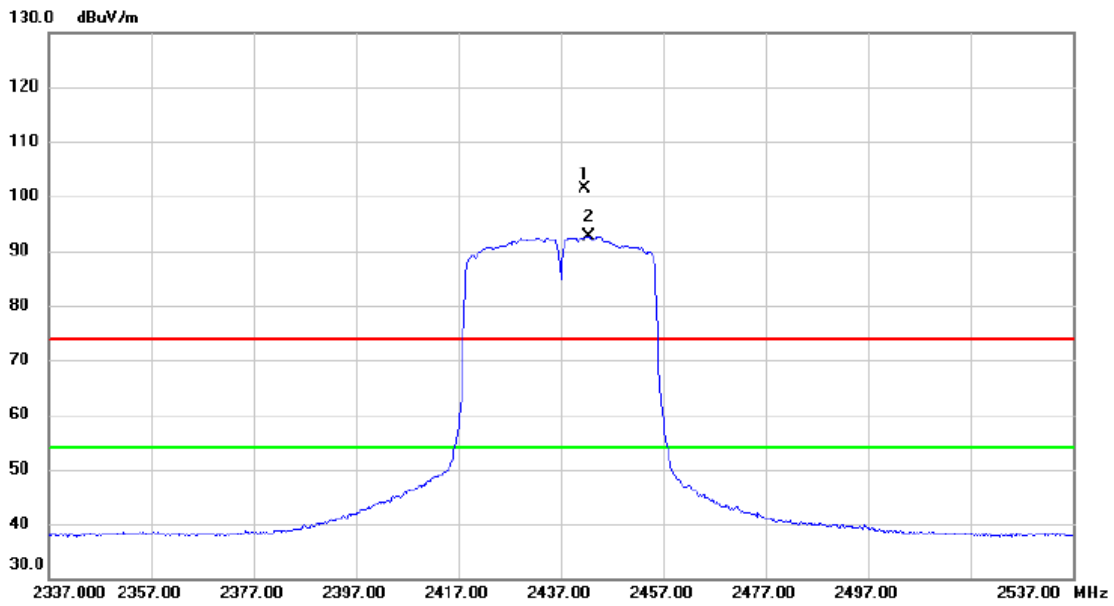

No.	Mk.	Freq. MHz	Reading Level dBuV	Correct Factor dB	Measure- ment dBuV/m	Limit dBuV/m	Margin dB	Detector	Comment
1	X	2441.600	94.13	7.25	101.38	74.00	27.38	peak	No Limit
2	*	2442.400	85.48	7.25	92.73	54.00	38.73	AVG	No Limit

REMARKS:

- (1) Measurement Value = Reading Level + Correct Factor.
- (2) Margin Level = Measurement Value - Limit Value.

Test Mode: TX AX-40M Mode 2437 MHz

Horizontal

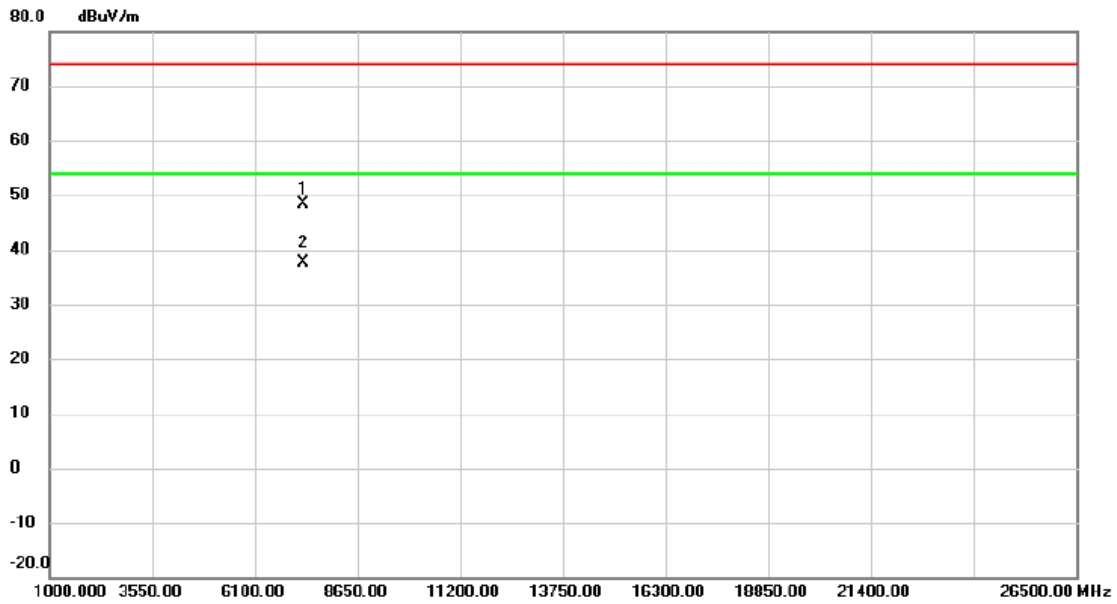

No.	Mk.	Freq. MHz	Reading Level dBuV	Correct Factor dB	Measure- ment dBuV/m	Limit dBuV/m	Margin dB	Detector	Comment
1		7308.425	37.96	10.31	48.27	74.00	-25.73	peak	
2	*	7310.500	27.28	10.31	37.59	54.00	-16.41	AVG	

REMARKS:

(1) Measurement Value = Reading Level + Correct Factor.

(2) Margin Level = Measurement Value - Limit Value.

Test Mode: TX AX-40M Mode 2452 MHz

Vertical

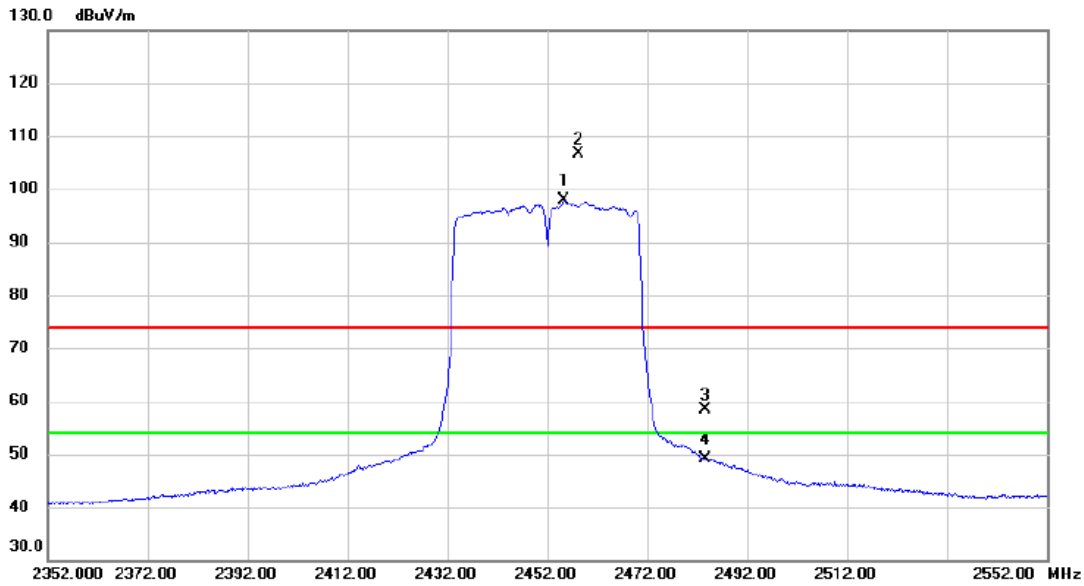

No.	Mk.	Freq. MHz	Reading Level dBuV	Correct Factor dB	Measure- ment dBuV/m	Limit dBuV/m	Margin dB	Detector	Comment
1	*	2455.400	90.60	7.25	97.85	54.00	43.85	AVG	No Limit
2	X	2458.200	99.36	7.26	106.62	74.00	32.62	peak	No Limit
3		2483.500	51.04	7.25	58.29	74.00	-15.71	peak	
4		2483.500	41.94	7.25	49.19	54.00	-4.81	AVG	

REMARKS:

- (1) Measurement Value = Reading Level + Correct Factor.
- (2) Margin Level = Measurement Value - Limit Value.

Test Mode: TX AX-40M Mode 2452 MHz

Vertical

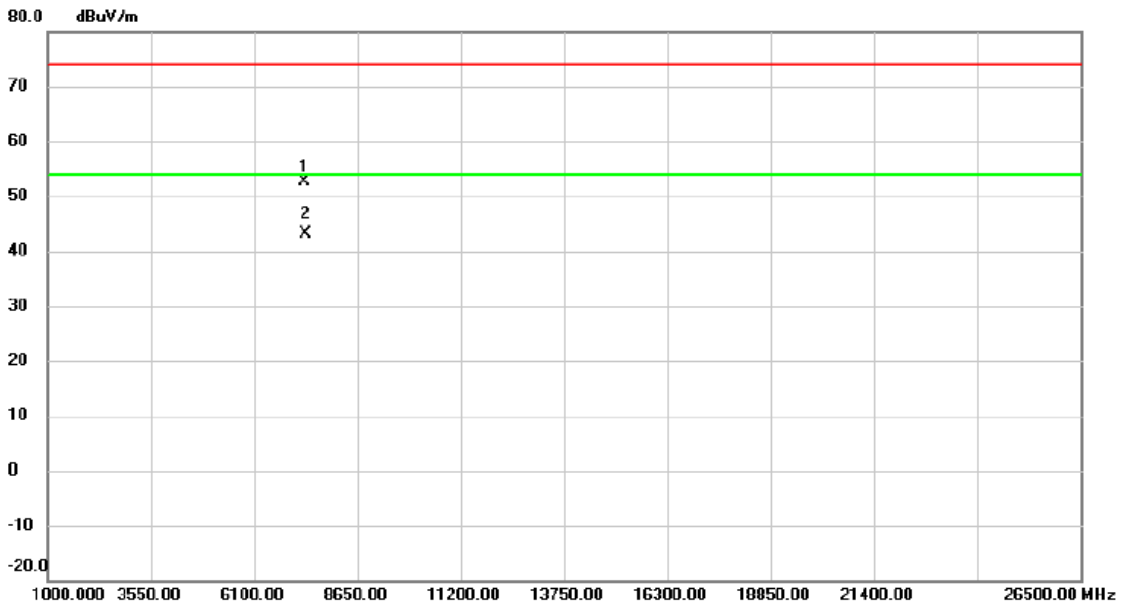

No.	Mk.	Freq. MHz	Reading Level dBuV	Correct Factor dB	Measure- ment dBuV/m	Limit dBuV/m	Margin dB	Detector	Comment
1		7357.200	42.16	10.40	52.56	74.00	-21.44	peak	
2	*	7365.600	32.72	10.41	43.13	54.00	-10.87	AVG	

REMARKS:

(1) Measurement Value = Reading Level + Correct Factor.

(2) Margin Level = Measurement Value - Limit Value.

Test Mode: TX AX-40M Mode 2452 MHz

Horizontal

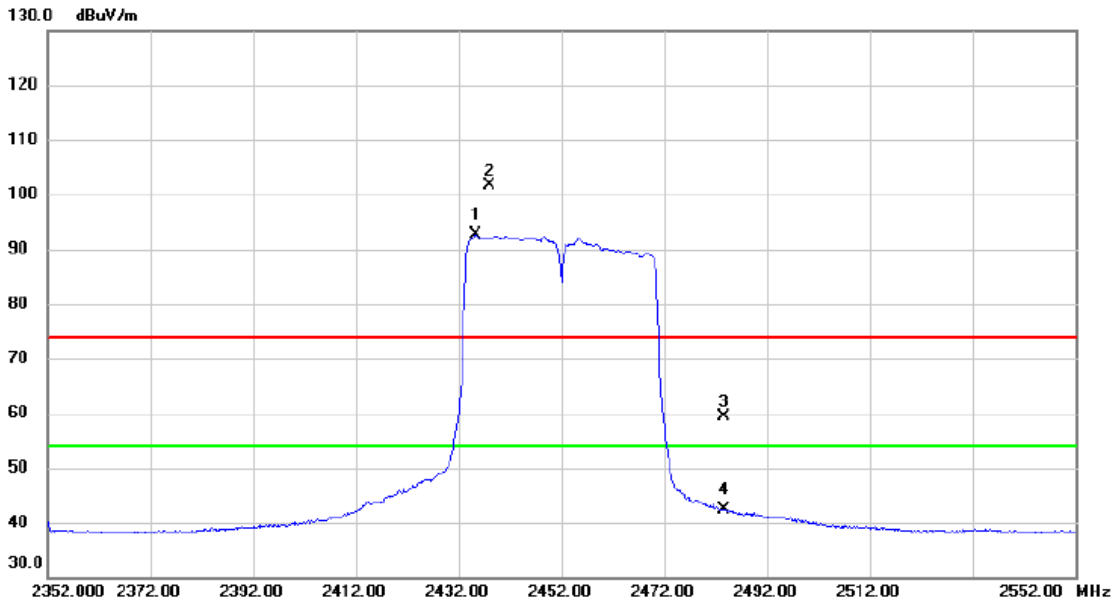

No.	Mk.	Freq. MHz	Reading Level dBuV	Correct Factor dB	Measure- ment dBuV/m	Limit dBuV/m	Margin dB	Detector	Comment
1	*	2435.400	85.44	7.25	92.69	54.00	38.69	AVG	No Limit
2	X	2438.000	94.28	7.25	101.53	74.00	27.53	peak	No Limit
3		2483.500	52.17	7.25	59.42	74.00	-14.58	peak	
4		2483.500	35.08	7.25	42.33	54.00	-11.67	AVG	

REMARKS:

(1) Measurement Value = Reading Level + Correct Factor.

(2) Margin Level = Measurement Value - Limit Value.

Test Mode: TX AX-40M Mode 2452 MHz

Horizontal

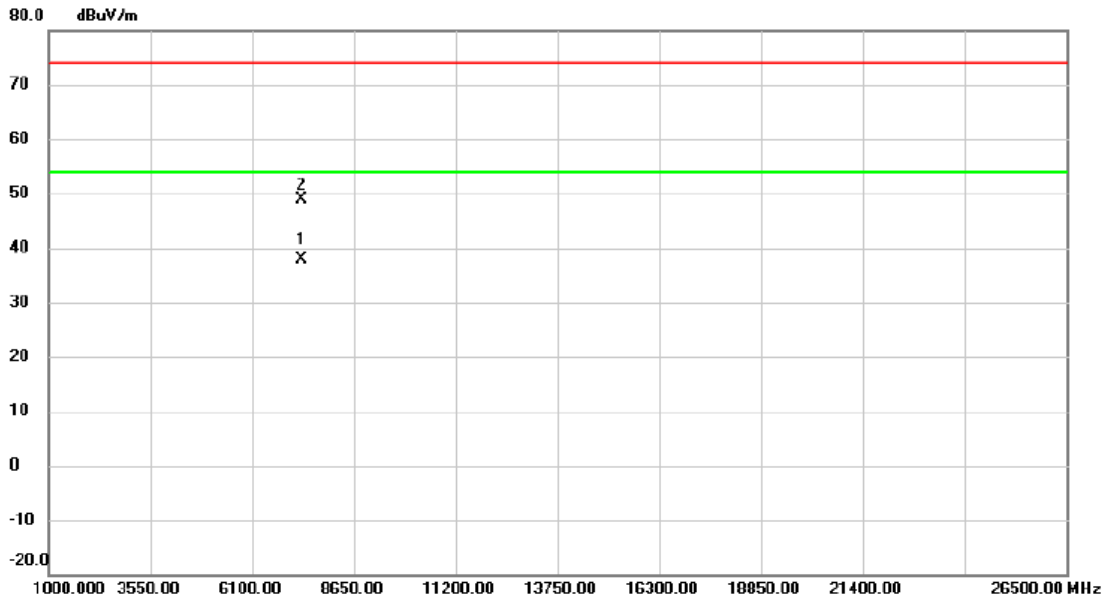

No. Mk.	Freq. MHz	Reading Level dBuV	Correct Factor dB	Measure- ment dBuV/m	Limit dBuV/m	Margin dB	Detector	Comment
1 *	7353.950	27.55	10.40	37.95	54.00	-16.05	AVG	
2	7354.190	38.52	10.40	48.92	74.00	-25.08	peak	

REMARKS:

(1) Measurement Value = Reading Level + Correct Factor.

(2) Margin Level = Measurement Value - Limit Value.

The worst case of simultaneous transmission:

Test Mode: TX WLAN 2.4G G Mode 2437MHz + WLAN 5G AX20 Mode 5240MHz

Vertical

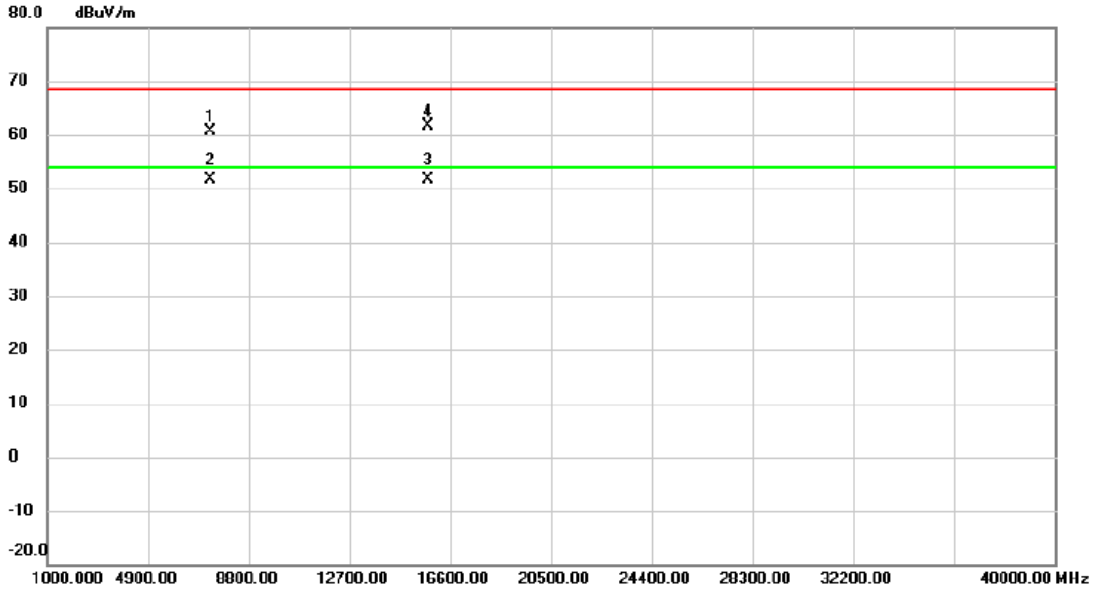

No.	Mk.	Freq. MHz	Reading Level dBuV	Correct Factor dB	Measure- ment dBuV/m	Limit dBuV/m	Margin dB	Detector	Comment
1		7311.000	48.60	12.09	60.69	68.30	-7.61	peak	
2	*	7312.300	39.56	12.09	51.65	54.00	-2.35	AVG	
3		15716.800	31.02	20.50	51.52	54.00	-2.48	AVG	
4		15717.400	41.25	20.50	61.75	68.30	-6.55	peak	

REMARKS:

- (1) Measurement Value = Reading Level + Correct Factor.
- (2) Margin Level = Measurement Value - Limit Value.

Test Mode: TX WLAN 2.4G G Mode 2437MHz + WLAN 5G AX20 Mode 5240MHz

Horizontal

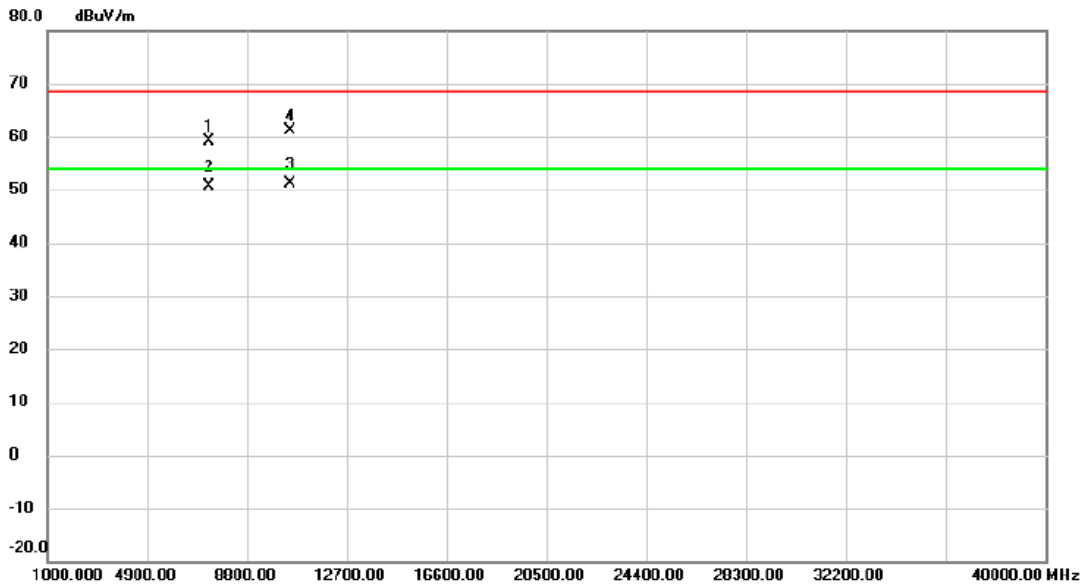

No.	Mk.	Freq. MHz	Reading Level dBuV	Correct Factor dB	Measure- ment dBuV/m	Limit dBuV/m	Margin dB	Detector	Comment
1		7312.000	46.98	12.09	59.07	68.30	-9.23	peak	
2		7312.000	38.65	12.09	50.74	54.00	-3.26	AVG	
3	*	10481.700	36.30	14.83	51.13	54.00	-2.87	AVG	
4		10482.200	46.35	14.83	61.18	68.30	-7.12	peak	

REMARKS:

- (1) Measurement Value = Reading Level + Correct Factor.
- (2) Margin Level = Measurement Value - Limit Value.

APPENDIX E - BANDWIDTH

Test Mode	TX B Mode
-----------	-----------

Channel	Frequency (MHz)	6 dB Bandwidth (MHz)	6 dB Bandwidth Min. Limit (kHz)	Result
01	2412	10.04	500	Complies
06	2437	9.60	500	Complies
11	2462	9.08	500	Complies

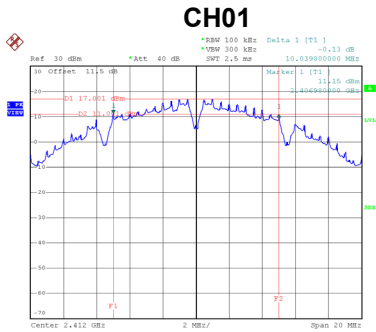

Date: 13.NOV.2020 11:46:28

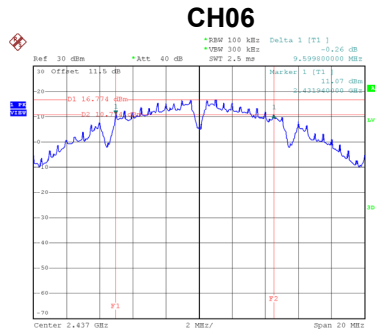

Date: 13.NOV.2020 11:48:31

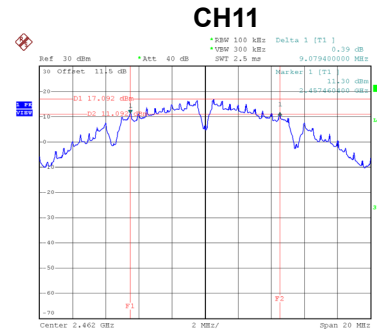

Date: 13.NOV.2020 11:50:32

Channel	Frequency (MHz)	99 % Emission Bandwidth (MHz)	Result
01	2412	15.92	Complies
06	2437	16.00	Complies
11	2462	15.68	Complies

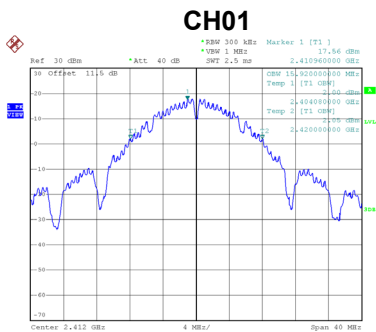

Date: 13.NOV.2020 11:46:36

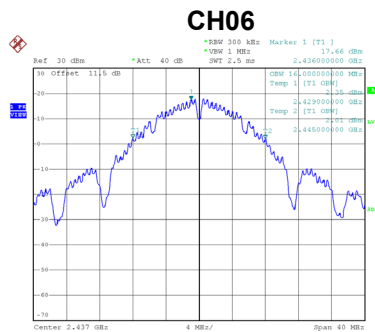

Date: 13.NOV.2020 11:48:38

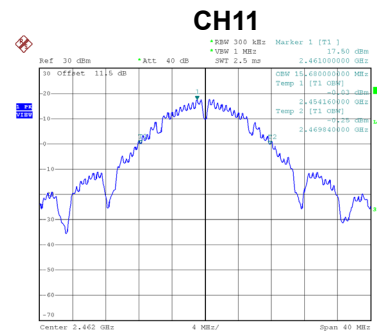

Date: 13.NOV.2020 11:50:40

Test Mode	TX G Mode
-----------	-----------

Channel	Frequency (MHz)	6 dB Bandwidth (MHz)	6 dB Bandwidth Min. Limit (kHz)	Result
01	2412	16.41	500	Complies
06	2437	16.36	500	Complies
11	2462	16.37	500	Complies

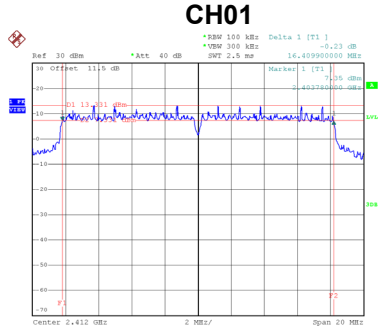

Date: 13.NOV.2020 11:59:21

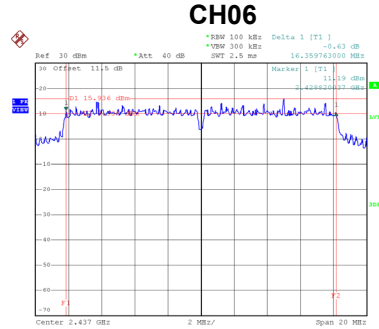

Date: 13.NOV.2020 13:37:47

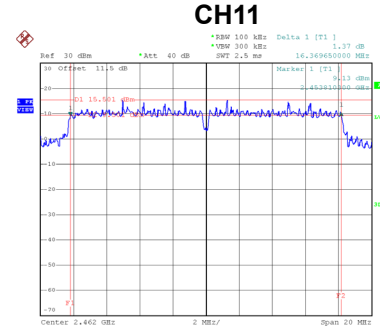

Date: 13.NOV.2020 13:39:23

Channel	Frequency (MHz)	99 % Emission Bandwidth (MHz)	Result
01	2412	25.44	Complies
06	2437	30.88	Complies
11	2462	30.16	Complies

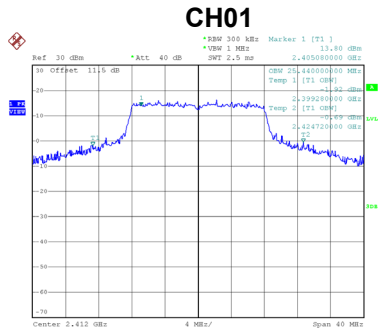

Date: 13.NOV.2020 11:59:28

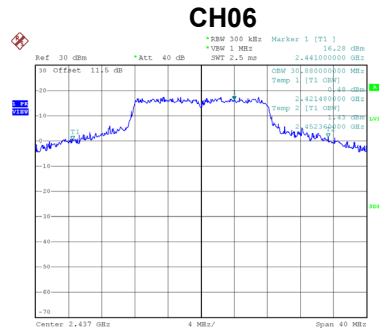

Date: 13.NOV.2020 13:37:57

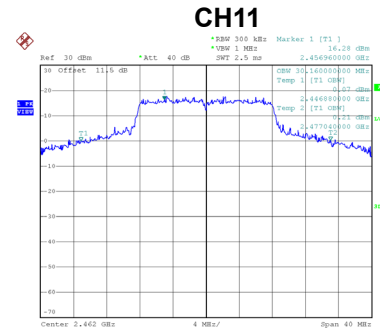

Date: 13.NOV.2020 13:39:31

Test Mode	TX N-20M Mode
-----------	---------------

Channel	Frequency (MHz)	6 dB Bandwidth (MHz)	6 dB Bandwidth Min. Limit (kHz)	Result
01	2412	17.63	500	Complies
06	2437	17.63	500	Complies
11	2462	17.63	500	Complies

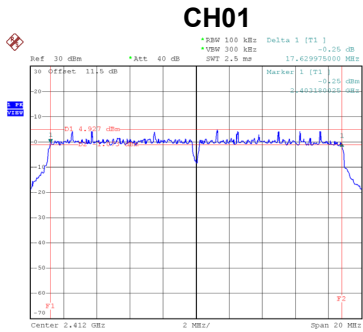

Date: 13.NOV.2020 13:42:15

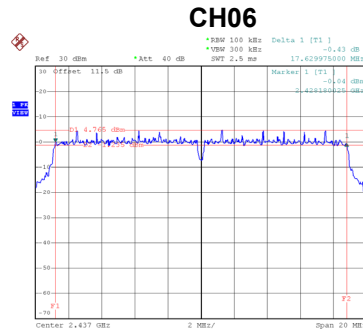

Date: 13.NOV.2020 13:44:01

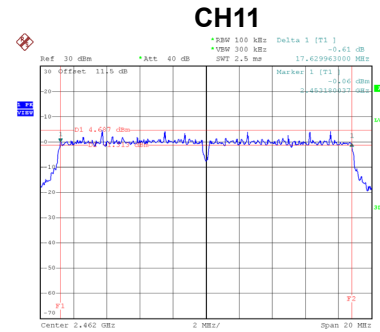

Date: 13.NOV.2020 13:45:32

Channel	Frequency (MHz)	99 % Emission Bandwidth (MHz)	Result
01	2412	18.24	Complies
06	2437	18.24	Complies
11	2462	18.24	Complies

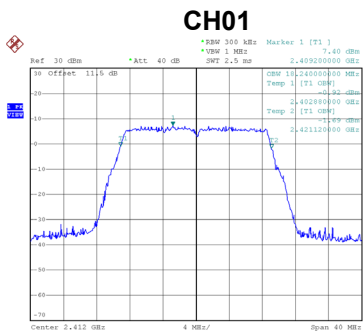

Date: 13.NOV.2020 13:42:23

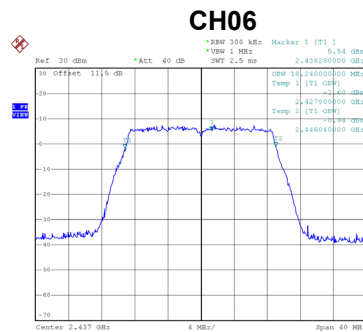

Date: 13.NOV.2020 13:44:09

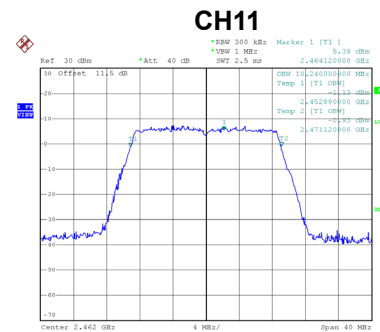

Date: 13.NOV.2020 13:45:40

Test Mode	TX N-40M Mode
-----------	---------------

Channel	Frequency (MHz)	6 dB Bandwidth (MHz)	6 dB Bandwidth Min. Limit (kHz)	Result
03	2422	36.36	500	Complies
06	2437	36.41	500	Complies
09	2452	36.44	500	Complies

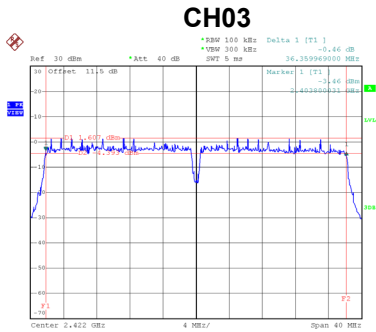

Date: 13.NOV.2020 13:47:29

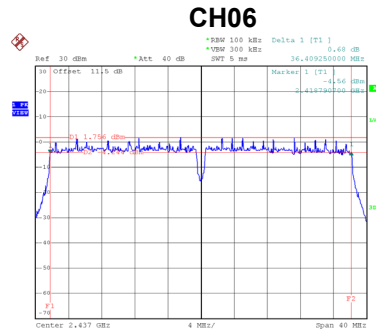

Date: 13.NOV.2020 13:49:28

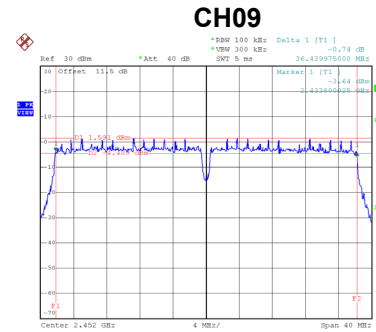

Date: 13.NOV.2020 13:51:13

Channel	Frequency (MHz)	99 % Emission Bandwidth (MHz)	Result
03	2422	36.80	Complies
06	2437	36.96	Complies
09	2452	36.80	Complies

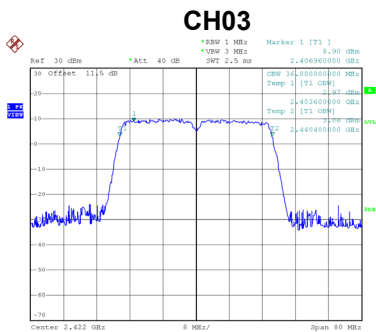

Date: 13.NOV.2020 13:47:37

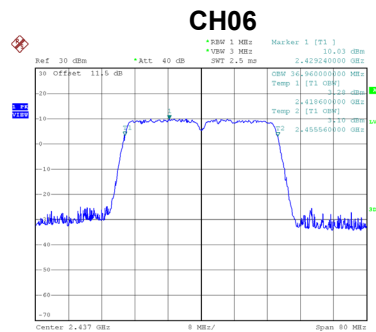

Date: 13.NOV.2020 13:49:36

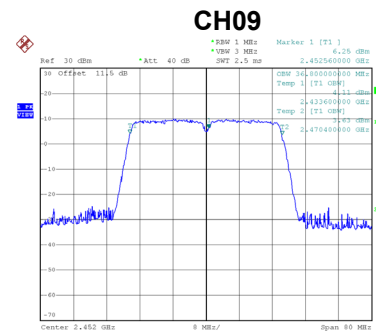

Date: 13.NOV.2020 13:51:21