

FCC Radio Test Report

FCC ID: V7TSS3V1

This report concerns: Original Grant

Project No. : 2008C191
Equipment : Smart Wi-Fi Light Switch
Brand Name : Tenda
Test Model : SS3
Series Model : N/A
Applicant : SHENZHEN TENDA TECHNOLOGY CO.,LTD
Address : 6-8 Floor, Tower E3, No. 1001, Zhongshanyuan Road, Nanshan District, Shenzhen, China. 518052
Manufacturer : SHENZHEN TENDA TECHNOLOGY CO.,LTD
Address : 6-8 Floor, Tower E3, No. 1001, Zhongshanyuan Road, Nanshan District, Shenzhen, China. 518052
Date of Receipt : Aug. 31, 2020
Date of Test : Aug. 31, 2020~Oct. 14, 2020
Issued Date : Oct. 21, 2020
Report Version : R00
Test Sample : Engineering Sample No.: DG2020083116
Standard(s) : FCC Part15, Subpart C (15.247)
ANSI C63.10-2013
FCC KDB 558074 D01 15.247 Meas Guidance v05r02

The above equipment has been tested and found compliance with the requirement of the relative standards by BTL Inc.

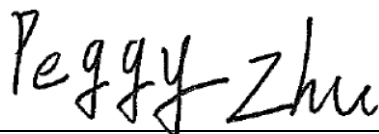

Prepared by : Peggy Zhu



Approved by : Ethan Ma



Certificate #5123.02

Add: No.3, Jinshagang 1st Road, Shixia, Dalang Town, Dongguan, Guangdong, China.

Tel: +86-769-8318-3000

Web: www.newbtl.com

Declaration

BTL represents to the client that testing is done in accordance with standard procedures as applicable and that test instruments used has been calibrated with standards traceable to international standard(s) and/or national standard(s).

BTL's reports apply only to the specific samples tested under conditions. It is manufacture's responsibility to ensure that additional production units of this model are manufactured with the identical electrical and mechanical components. **BTL** shall have no liability for any declarations, inferences or generalizations drawn by the client or others from **BTL** issued reports.

The report must not be used by the client to claim product certification, approval, or endorsement by NVLAP, NIST, A2LA, or any agency of the U.S. Government.

This report is the confidential property of the client. As a mutual protection to the clients, the public and ourselves, the test report shall not be reproduced, except in full, without our written approval.

BTL's laboratory quality assurance procedures are in compliance with the **ISO/IEC 17025** requirements, and accredited by the conformity assessment authorities listed in this test report.

BTL is not responsible for the sampling stage, so the results only apply to the sample as received.

The information, data and test plan are provided by manufacturer which may affect the validity of results, so it is manufacturer's responsibility to ensure that the apparatus meets the essential requirements of applied standards and in all the possible configurations as representative of its intended use.

Limitation

For the use of the authority's logo is limited unless the Test Standard(s)/Scope(s)/Item(s) mentioned in this test report is (are) included in the conformity assessment authorities acceptance respective.

Please note that the measurement uncertainty is provided for informational purpose only and are not use in determining the Pass/Fail results.

Table of Contents	Page
REPORT ISSUED HISTORY	6
1 . SUMMARY OF TEST RESULTS	7
1.1 TEST FACILITY	8
1.2 MEASUREMENT UNCERTAINTY	8
1.3 TEST ENVIRONMENT CONDITIONS	9
2 . GENERAL INFORMATION	10
2.1 GENERAL DESCRIPTION OF EUT	10
2.2 DESCRIPTION OF TEST MODES	11
2.3 PARAMETERS OF TEST SOFTWARE	12
2.4 DUTY CYCLE	13
2.5 BLOCK DIAGRAM SHOWING THE CONFIGURATION OF SYSTEM TESTED	14
2.6 SUPPORT UNITS	14
3 . AC POWER LINE CONDUCTED EMISSIONS TEST	15
3.1 LIMIT	15
3.2 TEST PROCEDURE	15
3.3 DEVIATION FROM TEST STANDARD	15
3.4 TEST SETUP	16
3.5 EUT OPERATION CONDITIONS	16
3.6 TEST RESULTS	16
4 . RADIATED EMISSIONS TEST	17
4.1 LIMIT	17
4.2 TEST PROCEDURE	18
4.3 DEVIATION FROM TEST STANDARD	18
4.4 TEST SETUP	19
4.5 EUT OPERATION CONDITIONS	20
4.6 TEST RESULTS - 9 KHZ TO 30 MHZ	20
4.7 TEST RESULTS - 30 MHZ TO 1000 MHZ	20
4.8 TEST RESULTS - ABOVE 1000 MHZ	20
5 . BANDWIDTH TEST	21
5.1 LIMIT	21
5.2 TEST PROCEDURE	21
5.3 DEVIATION FROM STANDARD	21
5.4 TEST SETUP	21

Table of Contents	Page
5.5 EUT OPERATION CONDITIONS	21
5.6 TEST RESULTS	21
6 . MAXIMUM OUTPUT POWER TEST	22
6.1 LIMIT	22
6.2 TEST PROCEDURE	22
6.3 DEVIATION FROM STANDARD	22
6.4 TEST SETUP	22
6.5 EUT OPERATION CONDITIONS	22
6.6 TEST RESULTS	22
7 . CONDUCTED SPURIOUS EMISSIONS	23
7.1 LIMIT	23
7.2 TEST PROCEDURE	23
7.3 DEVIATION FROM STANDARD	23
7.4 TEST SETUP	23
7.5 EUT OPERATION CONDITIONS	23
7.6 TEST RESULTS	23
8 . POWER SPECTRAL DENSITY TEST	24
8.1 LIMIT	24
8.2 TEST PROCEDURE	24
8.3 DEVIATION FROM STANDARD	24
8.4 TEST SETUP	24
8.5 EUT OPERATION CONDITIONS	24
8.6 TEST RESULTS	24
9 . MEASUREMENT INSTRUMENTS LIST	25
10 . EUT TEST PHOTO	27
APPENDIX A - AC POWER LINE CONDUCTED EMISSIONS	31
APPENDIX B - RADIATED EMISSION - 9 KHZ TO 30 MHZ	34
APPENDIX C - RADIATED EMISSION - 30 MHZ TO 1000 MHZ	39
APPENDIX D - RADIATED EMISSION- ABOVE 1000 MHZ	42
APPENDIX E - BANDWIDTH	79
APPENDIX F - MAXIMUM OUTPUT POWER	83
APPENDIX G - CONDUCTED SPURIOUS EMISSIONS	85

Table of Contents	Page
APPENDIX H - POWER SPECTRAL DENSITY	89

REPORT ISSUED HISTORY

Report Version	Description	Issued Date
R00	Original Issue.	Oct. 21, 2020

1. SUMMARY OF TEST RESULTS

Test procedures according to the technical standard(s):

FCC Part15, Subpart C (15.247)				
Standard(s) Section	Test Item	Test Result	Judgment	Remark
15.207	AC Power Line Conducted Emissions	APPENDIX A	PASS	-----
15.247(d) 15.205(a) 15.209(a)	Radiated Emissions	APPENDIX B APPENDIX C APPENDIX D	PASS	-----
15.247(a)(2)	Bandwidth	APPENDIX E	PASS	-----
15.247(b)(3)	Maximum Output Power	APPENDIX F	PASS	-----
15.247(d)	Conducted Spurious Emissions	APPENDIX G	PASS	-----
15.247(e)	Power Spectral Density	APPENDIX H	PASS	-----
15.203	Antenna Requirement	-----	PASS	Note(2)

Note:

- (1) "N/A" denotes test is not applicable in this test report.
- (2) The device what use a permanently attached antenna were considered sufficient to comply with the provisions of 15.203.

1.1 TEST FACILITY

The test facilities used to collect the test data in this report is at the location of No.3,Jinshagang 1st Road, Shixia, Dalang Town, Dongguan, Guangdong, China.

BTL's Test Firm Registration Number for FCC: 357015

BTL's Designation Number for FCC: CN1240

1.2 MEASUREMENT UNCERTAINTY

ISO/IEC 17025 requires that an estimate of the measurement uncertainties associated with the emissions test results be included in the report. The measurement uncertainties given below are based on a 95% confidence level (based on a coverage factor (k=2))

The BTL measurement uncertainty as below table:

A. AC power line conducted emissions test:

Test Site	Method	Measurement Frequency Range	U, (dB)
DG-C02	CISPR	150kHz ~ 30MHz	2.68

B. Radiated emissions test:

Test Site	Method	Measurement Frequency Range	Ant. H / V	U, (dB)
DG-CB03	CISPR	9kHz ~ 30MHz	V	3.79
		9kHz ~ 30MHz	H	3.57
		30MHz ~ 200MHz	V	4.26
		30MHz ~ 200MHz	H	3.38
		200MHz ~ 1,000MHz	V	3.98
		200MHz ~ 1,000MHz	H	3.94
		1GHz ~ 6GHz	-	4.58
		6GHz ~ 18GHz	-	5.18
		18GHz ~ 26.5GHz	-	3.62
		26.5GHz ~ 40GHz	-	4.00

C. Other Measurement:

Parameter	Uncertainty
Bandwidth	±3.8 %
Maximum Output Power	±0.95 dB
Conducted Spurious Emission	±2.71 dB
Power Spectral Density	±0.86 dB
Temperature	±0.08 °C
Time	±0.58 %
Supply voltages	±0.3 %

Note: Unless specifically mentioned, the uncertainty of measurement has not been taken into account to declare the compliance or non-compliance to the specification.

1.3 TEST ENVIRONMENT CONDITIONS

Test Item	Temperature	Humidity	Test Voltage	Tested By
AC Power Line Conducted Emissions	25°C	53%	AC 120V/60Hz	Kwok Guo
Radiated Emissions-9K-30MHz	22°C	60%	AC 120V/60Hz	Kwok Guo
Radiated Emissions-30 MHz to 1GHz	26°C	52%	AC 120V/60Hz	Kwok Guo
Radiated Emissions-Above 1000 MHz	24°C	60%	AC 120V/60Hz	Kwok Guo
Bandwidth	25°C	59%	AC 120V/60Hz	Hayden Chen
Maximum output power	25°C	59%	AC 120V/60Hz	Laughing Zhang
Conducted Spurious Emissions	25°C	59%	AC 120V/60Hz	Hayden Chen
Power Spectral Density	25°C	59%	AC 120V/60Hz	Hayden Chen

2. GENERAL INFORMATION

2.1 GENERAL DESCRIPTION OF EUT

Equipment	Smart Wi-Fi Light Switch
Brand Name	Tenda
Test Model	SS3
Series Model	N/A
Model Difference(s)	N/A
Power Source	AC Mains
Power Rating	I/P: 120V AC 60Hz O/P: 120V MAX. 15A
Operation Frequency	2412 MHz ~ 2462 MHz
Modulation Type	IEEE 802.11b: DSSS IEEE 802.11g: OFDM IEEE 802.11n: OFDM
Bit Rate of Transmitter	IEEE 802.11b: 11/5.5/2/1 Mbps IEEE 802.11g: 54/48/36/24/18/12/9/6 Mbps IEEE 802.11n: up to 72.2 Mbps
Maximum Output Power	IEEE 802.11b: 18.63 dBm (0.0729 W) IEEE 802.11g: 21.03 dBm (0.1268 W) IEEE 802.11n (HT20): 21.69 dBm (0.1476 W)

Note:

1. For a more detailed features description, please refer to the manufacturer's specifications or the user's manual.

2. Channel List:

CH01 - CH11 for IEEE 802.11b, IEEE 802.11g, IEEE 802.11n (HT20)							
Channel	Frequency (MHz)	Channel	Frequency (MHz)	Channel	Frequency (MHz)	Channel	Frequency (MHz)
01	2412	04	2427	07	2442	10	2457
02	2417	05	2432	08	2447	11	2462
03	2422	06	2437	09	2452		

3. Antenna Specification:

Ant.	Brand	Model Name	Antenna Type	Connector	Gain (dBi)
1	N/A	N/A	Internal	N/A	0

2.2 DESCRIPTION OF TEST MODES

The test system was pre-tested based on the consideration of all possible combinations of EUT operation mode.

Pretest Mode	Description
Mode 1	TX B Mode Channel 01/06/11
Mode 2	TX G Mode Channel 01/06/11
Mode 3	TX N-20 MHz Mode Channel 01/06/11
Mode 4	TX N-20 MHz Mode Channel 06

Following mode(s) was (were) found to be the worst case(s) and selected for the final test.

AC power line conducted emissions test	
Final Test Mode	Description
Mode 4	TX N-20 MHz Mode Channel 06

Radiated emissions test - Below 1GHz	
Final Test Mode:	Description
Mode 4	TX N-20 MHz Mode Channel 06

Radiated emissions test- Above 1GHz	
Final Test Mode	Description
Mode 1	TX B Mode Channel 01/06/11
Mode 2	TX G Mode Channel 01/06/11
Mode 3	TX N-20 MHz Mode Channel 01/06/11

Conducted test	
Final Test Mode	Description
Mode 1	TX B Mode Channel 01/06/11
Mode 2	TX G Mode Channel 01/06/11
Mode 3	TX N-20 MHz Mode Channel 01/06/11

NOTE:

- (1) The measurements are performed at the high, middle, low available channels.
- (2) All the bit rate of transmitter have been tested and found the lowest rate is found to be the worst case and recorded.
- (3) For radiated emission below 1 GHz test, the IEEE 802.11n (HT20) Channel 06 is found to be the worst case and recorded.
- (4) For radiated emission above 1 GHz test, 1GHz~26.5GHz have been pre-tested and in this report only recorded the worst case. The remaining spurious points are all below the limit value of 20dB.

2.3 PARAMETERS OF TEST SOFTWARE

Test Software	UI_mptool.exe 1.0.0.1		
Frequency (MHz)	2412	2437	2462
IEEE 802.11b	45	41	38
IEEE 802.11g	48	52	46
IEEE 802.11n (HT20)	47	53	43

2.4 DUTY CYCLE

IEEE 802.11b

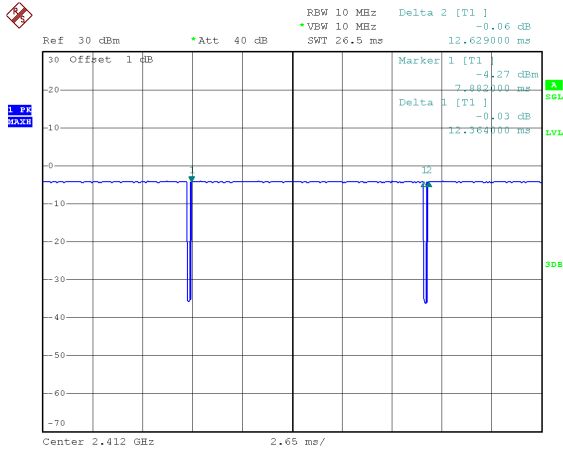

Date: 15.SEP.2020 11:01:03

Duty cycle = 12.364 ms / 12.629 ms = 97.90%
 Duty Factor = 10 log(1/Duty cycle) = 0.09

IEEE 802.11g

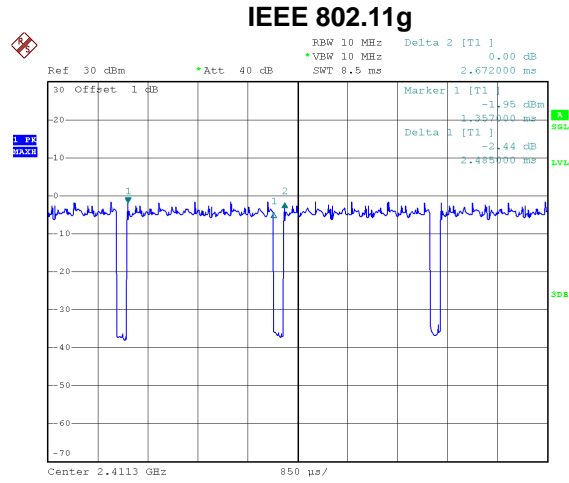

Date: 15.SEP.2020 11:05:28

Duty cycle = 2.485 ms / 2.672 ms = 93.00%
 Duty Factor = 10 log(1/Duty cycle) = 0.32

IEEE 802.11n (HT20)

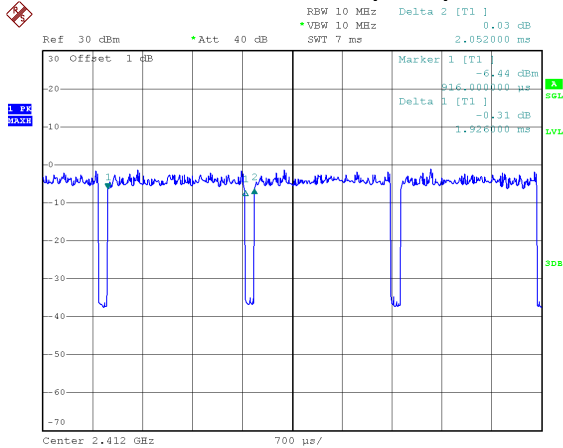

Date: 15.SEP.2020 10:57:08

Duty cycle = 1.926 ms / 2.052 ms = 93.86%
 Duty Factor = 10 log(1/Duty cycle) = 0.28

NOTE:

For IEEE 802.11b, IEEE 802.11g and IEEE 802.11n (HT20):

For radiated emissions frequency above 1 GHz, the resolution bandwidth of test receiver/spectrum analyzer is 1 MHz and the video bandwidth is 1 kHz (Duty cycle < 98%).

2.5 BLOCK DIAGRAM SHOWING THE CONFIGURATION OF SYSTEM TESTED

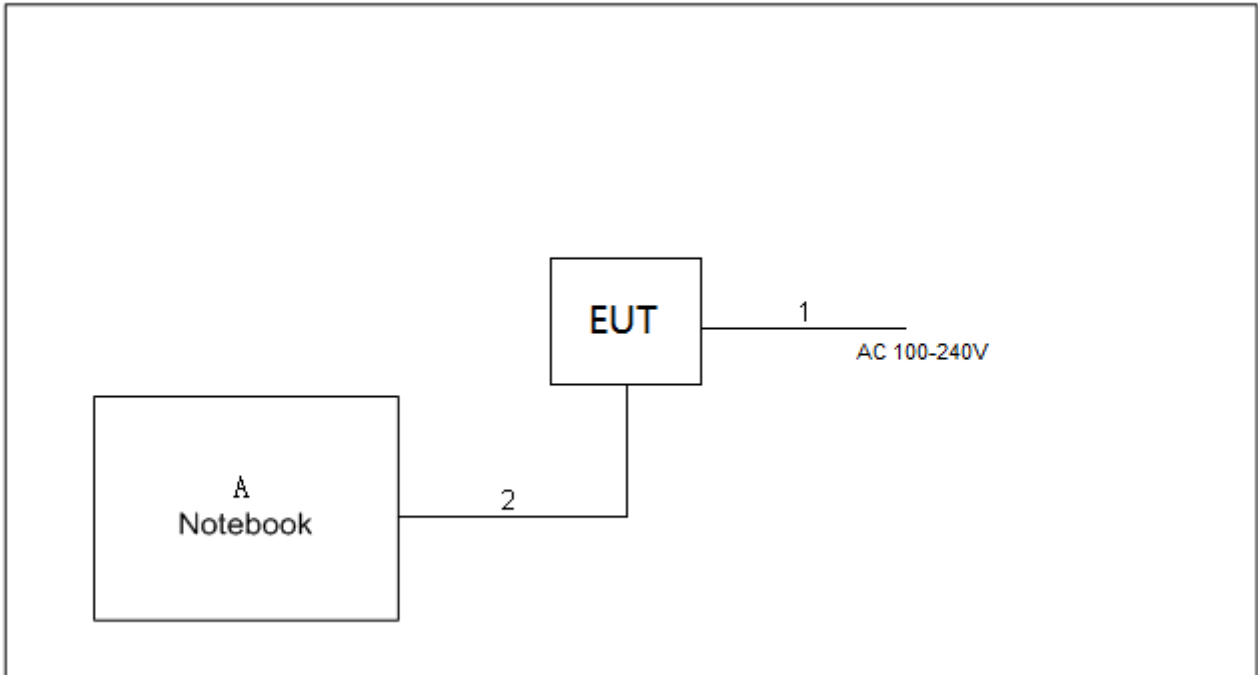

2.6 SUPPORT UNITS

Item	Equipment	Brand	Model No.	Series No.
A	Notebook	Dell	Inspiron 15-7559	N/A

Item	Cable Type	Shielded Type	Ferrite Core	Length
1	AC Cable	NO	NO	1.2m
2	USB Cable	NO	NO	0.8m

3. AC POWER LINE CONDUCTED EMISSIONS TEST

3.1 LIMIT

Frequency of Emission (MHz)	Limit (dB μ V)	
	Quasi-peak	Average
0.15 - 0.5	66 to 56*	56 to 46*
0.5 - 5.0	56	46
5.0 - 30.0	60	50

NOTE:

- (1) The tighter limit applies at the band edges.
- (2) The limit of " * " marked band means the limitation decreases linearly with the logarithm of the frequency in the range.

The following table is the setting of the receiver

Receiver Parameters	Setting
Attenuation	10 dB
Start Frequency	0.15 MHz
Stop Frequency	30 MHz
IF Bandwidth	9 kHz

3.2 TEST PROCEDURE

- a. The EUT was placed 0.8 meters from the horizontal ground plane with EUT being connected to the power mains through a line impedance stabilization network (LISN). All other support equipment powered from additional LISN(s). The LISN provide 50 Ohm/ 50uH of coupling impedance for the measuring instrument.
- b. Interconnecting cables that hang closer than 40 cm to the ground plane shall be folded back and forth in the center forming a bundle 30 to 40 cm long.
- c. I/O cables that are not connected to a peripheral shall be bundled in the center. The end of the cable may be terminated, if required, using the correct terminating impedance. The overall length shall not exceed 1 m.
- d. LISN at least 80 cm from nearest part of EUT chassis.
- e. For the actual test configuration, please refer to the related Item -EUT Test Photos.

3.3 DEVIATION FROM TEST STANDARD

No deviation

3.4 TEST SETUP

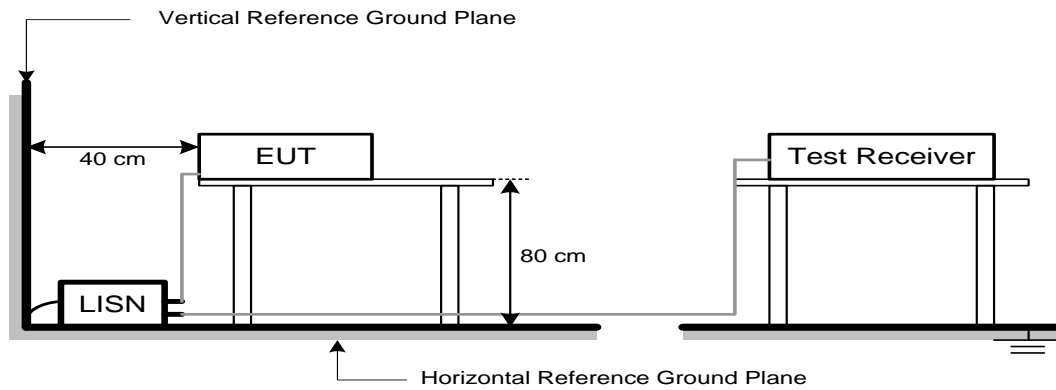

3.5 EUT OPERATION CONDITIONS

EUT was programmed to be in continuously transmitting mode.

3.6 TEST RESULTS

Please refer to the APPENDIX A.

4. RADIATED EMISSIONS TEST

4.1 LIMIT

In case the emission fall within the restricted band specified on 15.205(a), then the 15.209(a) limit in the table below has to be followed.

LIMITS OF RADIATED EMISSION MEASUREMENT (9 kHz-1000 MHz)

Frequency (MHz)	Field Strength (microvolts/meter)	Measurement Distance (meters)
0.009-0.490	2400/F(kHz)	300
0.490-1.705	24000/F(kHz)	30
1.705-30.0	30	30
30-88	100	3
88-216	150	3
216-960	200	3
Above 960	500	3

LIMITS OF RADIATED EMISSION MEASUREMENT (Above 1000 MHz)

Frequency (MHz)	(dBuV/m at 3 m)	
	Peak	Average
Above 1000	74	54

NOTE:

- (1) The limit for radiated test was performed according to FCC PART 15C.
- (2) The tighter limit applies at the band edges.
- (3) Emission level (dBuV/m)=20log Emission level (uV/m).

Spectrum Parameter	Setting
Attenuation	Auto
Start Frequency	1000 MHz
Stop Frequency	10th carrier harmonic
RBW / VBW (Emission in restricted band)	1 MHz / 3 MHz for Peak, 1 MHz / 1/T for Average

Receiver Parameter	Setting
Attenuation	Auto
Start ~ Stop Frequency	9 kHz~90 kHz for PK/AVG detector
Start ~ Stop Frequency	90 kHz~110 kHz for QP detector
Start ~ Stop Frequency	110 kHz~490 kHz for PK/AVG detector
Start ~ Stop Frequency	490 kHz~30 MHz for QP detector
Start ~ Stop Frequency	30 MHz~1000 MHz for QP detector

4.2 TEST PROCEDURE

- a. The measuring distance of 3 m shall be used for measurements. The EUT was placed on the top of a rotating table 0.8 meter above the ground at a 3 meter semi-anechoic chamber. The table was rotated 360 degrees to determine the position of the highest radiation.(below 1 GHz)
- b. The measuring distance of 3 m shall be used for measurements. The EUT was placed on the top of a rotating table 1.5 meter above the ground at a 3 meter semi-anechoic chamber. The table was rotated 360 degrees to determine the position of the highest radiation.(above 1 GHz)
- c. The height of the equipment or of the substitution antenna shall be 0.8m or 1.5m; the height of the test antenna shall vary between 1 m to 4 m. Both horizontal and vertical polarizations of the antenna are set to make the measurement.
- d. For each suspected emission, the EUT was arranged to its worst case and then the antenna was tuned to heights find the maximum reading (used Bore sight function).
- e. The receiver system was set to peak and average detect function and specified bandwidth with maximum hold mode when the test frequency is above 1 GHz.
- f. The initial step in collecting radiated emission data is a receiver peak detector mode pre-scanning the measurement frequency range. Significant peaks are then marked and then Quasi Peak detector mode re-measured.
- g. All readings are Peak unless otherwise stated QP in column of Note. Peak denotes that the Peak reading compliance with the QP Limits and then QP Mode measurement didn't perform.
(below 1 GHz)
- h. All readings are Peak Mode value unless otherwise stated AVG in column of Note. If the Peak Mode Measured value compliance with the Peak Limits and lower than AVG Limits, the EUT shall be deemed to meet both Peak & AVG Limits and then only Peak Mode was measured, but AVG Mode didn't perform. (above 1 GHz)
- i. For the actual test configuration, please refer to the related Item -EUT Test Photos.

4.3 DEVIATION FROM TEST STANDARD

No deviation

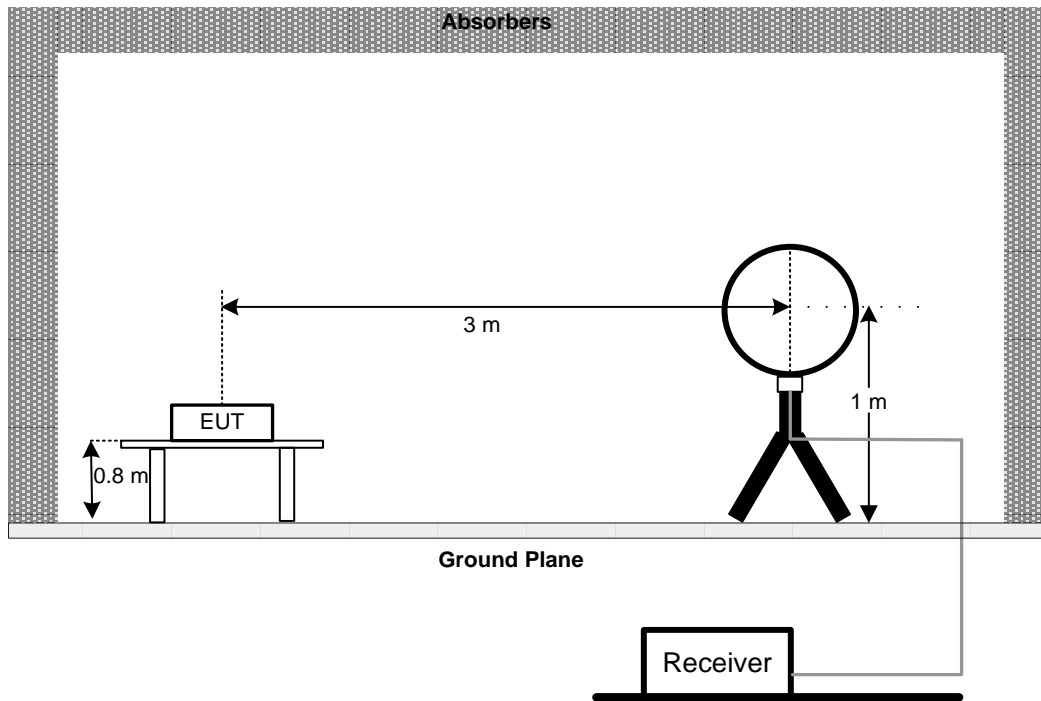
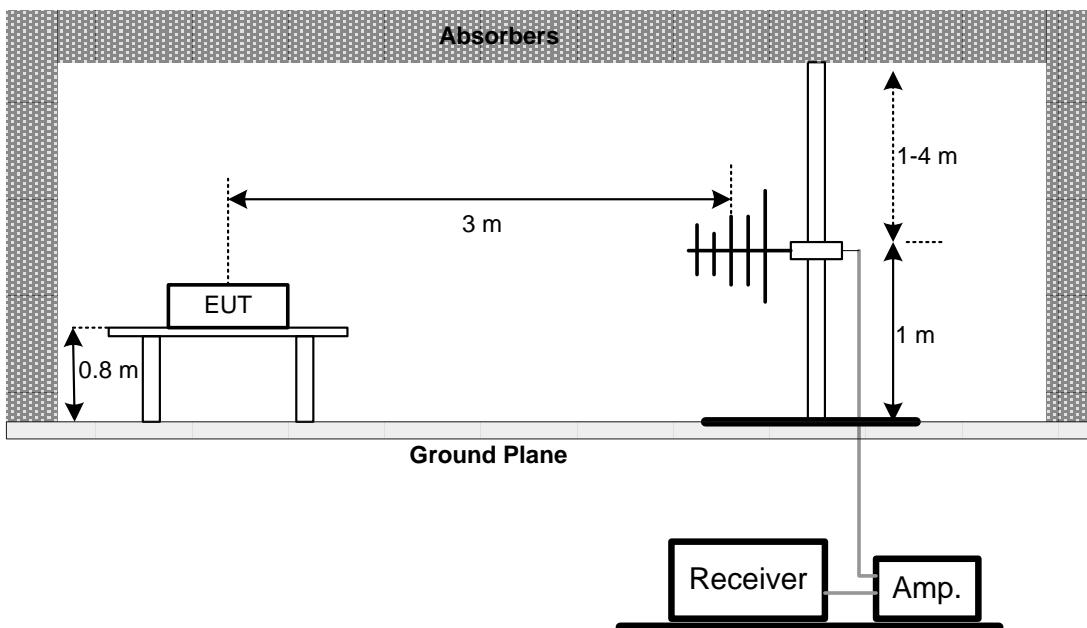
4.4 TEST SETUP**9 kHz-30 MHz****30 MHz to 1 GHz**

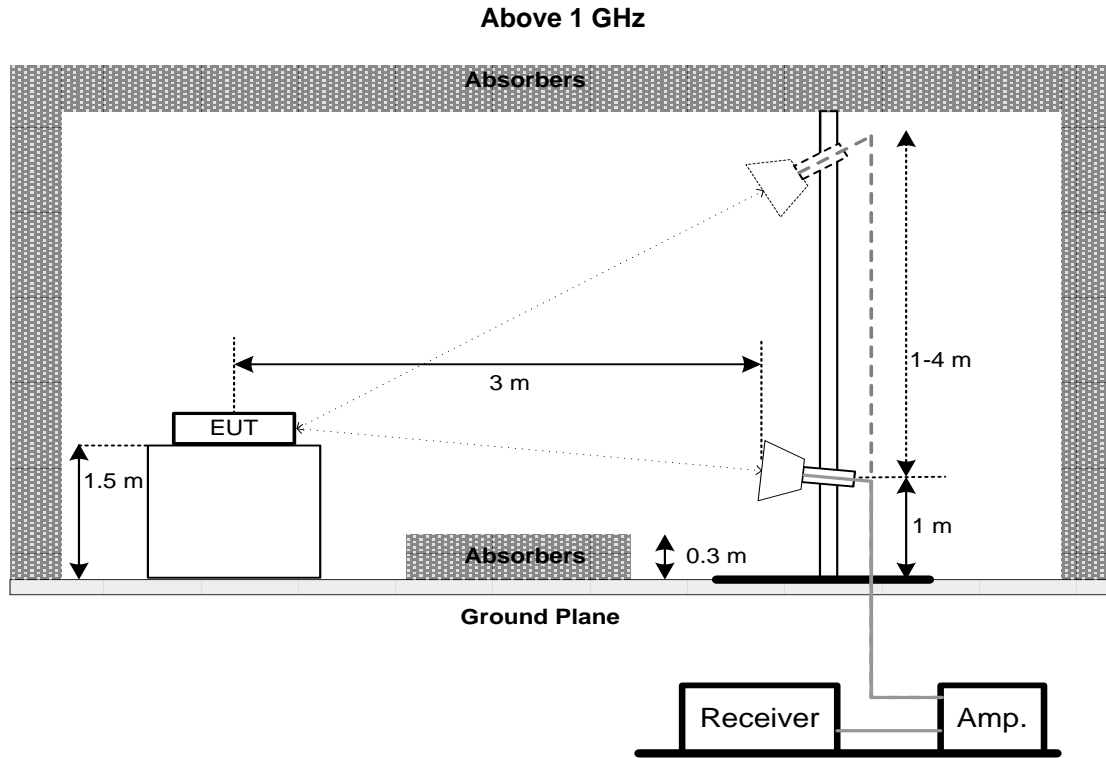

4.5 EUT OPERATION CONDITIONS

The EUT was programmed to be in continuously transmitting mode.

4.6 TEST RESULTS - 9 KHZ TO 30 MHZ

Please refer to the APPENDIX B

Remark:

- (1) Distance extrapolation factor = $40 \log (\text{specific distance} / \text{test distance})$ (dB).
- (2) Limit line = specific limits (dBuV) + distance extrapolation factor.

4.7 TEST RESULTS - 30 MHZ TO 1000 MHZ

Please refer to the APPENDIX C.

4.8 TEST RESULTS - ABOVE 1000 MHZ

Please refer to the APPENDIX D.

Remark:

- (1) No limit: This is fundamental signal, the judgment is not applicable.
For fundamental signal judgment was referred to Peak output test.

5. BANDWIDTH TEST

5.1 LIMIT

FCC Part15, Subpart C (15.247)		
Section	Test Item	Limit
15.247(a)(2)	6 dB Bandwidth	Minimum 500 kHz
	99% Emission Bandwidth	-

5.2 TEST PROCEDURE

- a. The EUT was directly connected to the spectrum analyzer and antenna output port as show in the block diagram below.
- b. Spectrum Setting:
 For 6 dB Bandwidth : RBW= 100 kHz, VBW=300 kHz, Sweep time = auto.
 For 99% Emission Bandwidth B/G/N-20 Mode: RBW= 300 KHz, VBW=1 MHz, Sweep time = 2.5 ms.
- c. The bandwidth was performed in accordance with method 11.8.1 of ANSI C63.10-2013.

5.3 DEVIATION FROM STANDARD

No deviation.

5.4 TEST SETUP



5.5 EUT OPERATION CONDITIONS

The EUT was programmed to be in continuously transmitting mode.

5.6 TEST RESULTS

Please refer to the APPENDIX E.

6. MAXIMUM OUTPUT POWER TEST

6.1 LIMIT

FCC Part15, Subpart C (15.247)		
Section	Test Item	Limit
15.247(b)(3)	Maximum Output Power	1 Watt or 30dBm

6.2 TEST PROCEDURE

- The EUT was directly connected to the power meter and antenna output port as show in the block diagram below.
- The maximum conducted output power was performed in accordance with method 11.9.1.3 of ANSI C63.10-2013.

6.3 DEVIATION FROM STANDARD

No deviation.

6.4 TEST SETUP



6.5 EUT OPERATION CONDITIONS

The EUT was programmed to be in continuously transmitting mode.

6.6 TEST RESULTS

Please refer to the APPENDIX F.

7. CONDUCTED SPURIOUS EMISSIONS

7.1 LIMIT

In any 100 kHz bandwidth outside the frequency band in which the spread spectrum or digitally modulated intentional radiator is operating, the radio frequency power that is produced by the intentional radiator shall be at least 20 dB below that in the 100 kHz bandwidth within the band that contains the highest level of the desired power, based on either an RF conducted or a radiated measurement, provided the transmitter demonstrates compliance with the peak Output Power limits. If the transmitter complies with the Output Power limits based on the use of RMS averaging over a time interval, as permitted under paragraph (b)(3) of this section, the attenuation required under this paragraph shall be 30 dB instead of 20 dB. Attenuation below the general limits specified in Section 15.209(a) is not required.

7.2 TEST PROCEDURE

- a. The EUT was directly connected to the spectrum analyzer and antenna output port as show in the block diagram below.
- b. Spectrum Setting: RBW= 100 kHz, VBW=300 kHz, Sweep time = Auto.

7.3 DEVIATION FROM STANDARD

No deviation.

7.4 TEST SETUP



7.5 EUT OPERATION CONDITIONS

The EUT was programmed to be in continuously transmitting mode.

7.6 TEST RESULTS

Please refer to the APPENDIX G.

8. POWER SPECTRAL DENSITY TEST

8.1 LIMIT

FCC Part15, Subpart C (15.247)		
Section	Test Item	Limit
15.247(e)	Power Spectral Density	8 dBm (in any 3 kHz)

8.2 TEST PROCEDURE

- The EUT was directly connected to the spectrum analyzer and antenna output port as show in the block diagram below.
- Spectrum Setting: RBW=3 kHz, VBW=10 kHz, Sweep time = Auto.
- The Power Spectral Density was performed in accordance with method 11.10.2 of ANSI C63.10-2013.

8.3 DEVIATION FROM STANDARD

No deviation.

8.4 TEST SETUP

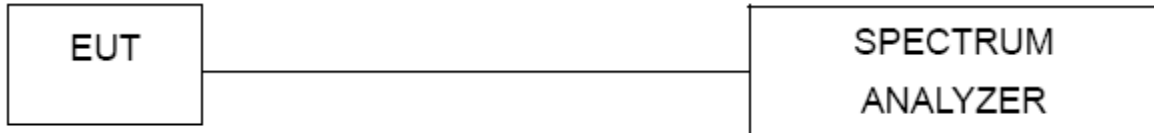

8.5 EUT OPERATION CONDITIONS

The EUT was programmed to be in continuously transmitting mode.

8.6 TEST RESULTS

Please refer to the APPENDIX H.

9. MEASUREMENT INSTRUMENTS LIST

AC Power Line Conducted Emissions					
Item	Kind of Equipment	Manufacturer	Type No.	Serial No.	Calibrated until
1	EMI Test Receiver	R&S	ESCI	100382	Feb. 28, 2021
2	LISN	EMCO	3816/2	52765	Mar. 01, 2021
3	TWO-LINE V-NETWORK	R&S	ENV216	101447	Feb. 28, 2021
4	50Ω Terminator	SHX	TF5-3	15041305	Mar. 01, 2021
5	Measurement Software	Farad	EZ-EMC Ver.NB-03A1-01	N/A	N/A
6	Cable	N/A	RG223	12m	Mar. 10, 2021
7	643 Shield Room	ETS	6*4*3m	N/A	N/A

Radiated Emissions - 9 kHz to 30 MHz					
Item	Kind of Equipment	Manufacturer	Type No.	Serial No.	Calibrated until
1	Antenna	EM	EM-6876-1	230	Apr. 16, 2021
2	Cable	N/A	RG 213/U	N/A	May 29, 2021
3	EMI Test Receiver	R&S	ESCI	100895	Feb. 28, 2021
4	Measurement Software	Farad	EZ-EMC Ver.NB-03A1-01	N/A	N/A
5	966 Chambe Room	RM	9*6*6m	N/A	Jul. 25, 2021

Radiated Emissions - 30 MHz to 1 GHz					
Item	Kind of Equipment	Manufacturer	Type No.	Serial No.	Calibrated until
1	Antenna	Schwarzbeck	VULB9160	9160-3232	Mar. 09, 2021
2*	Amplifier	HP	8447D	2944A09673	Aug. 11, 2021
3	Receiver	Agilent	N9038A	MY52130039	Jul. 25, 2021
4	Cable	emci	LMR-400(30MHz-1 GHz)(8m+5m)	N/A	May 22, 2021
5	Controller	CT	SC100	N/A	N/A
6	Controller	MF	MF-7802	MF780208416	N/A
7	Measurement Software	Farad	EZ-EMC Ver.NB-03A1-01	N/A	N/A
8	966 Chambe Room	RM	9*6*6m	N/A	Jul. 25, 2021

Radiated Emissions - Above 1 GHz					
Item	Kind of Equipment	Manufacturer	Type No.	Serial No.	Calibrated until
1	Double Ridged Guide Antenna	ETS	3115	75789	May 12, 2021
2	Broad-Band Horn Antenna	Schwarzbeck	BBHA 9170	9170319	Jul. 07, 2021
3	Amplifier	Agilent	8449B	3008A02333	Mar. 01, 2021
4	Microwave Preamplifier With Adaptor	EMC INSTRUMENT	EMC2654045	980039 & HA01	Mar. 07, 2021
5	Receiver	Agilent	N9038A	MY52130039	Jul. 25, 2021
6	Controller	CT	SC100	N/A	N/A
7	Controller	MF	MF-7802	MF780208416	N/A
8	Cable	N/A	EMC104-SM-SM-6000	N/A	May 09, 2021
9	Measurement Software	Farad	EZ-EMC Ver.NB-03A1-01	N/A	N/A
10	Filter	STI	STI15-9912	N/A	Jul. 25, 2021
11	966 Chambe Room	RM	9*6*6m	N/A	Jul. 25, 2021

Bandwidth & Antenna Conducted Spurious Emissions & Power Spectral Density					
Item	Kind of Equipment	Manufacturer	Type No.	Serial No.	Calibrated until
1	Spectrum Analyzer	R&S	FSP40	100185	Jul. 25, 2021
2	RF Cable	Tongkaichuan	N/A	N/A	N/A
3	DC Block	Mini	N/A	N/A	N/A

Maximum Output Power					
Item	Kind of Equipment	Manufacturer	Type No.	Serial No.	Calibrated until
1	Peak Power Analyzer	Keysight	8990B	MY51000506	Aug. 07, 2021
2	Wideband power sensor	Keysight	N1923A	MY58310004	Jul. 25, 2021
3	Attenuator	WOKEN	6SM3502	VAS1214NL	Feb. 11, 2021
4	RF Cable	Tongkaichuan	N/A	N/A	N/A

Remark: "N/A" denotes no model name, serial no. or calibration specified.

"**" calibration period of equipment list is three year.

Except * item, all calibration period of equipment list is one year.

10. EUT TEST PHOTO**AC Power Line Conducted Emissions Test Photos**

Radiated Emissions Test Photos**9 kHz to 30 MHz**

Radiated Emissions Test Photos

30 MHz to 1 GHz

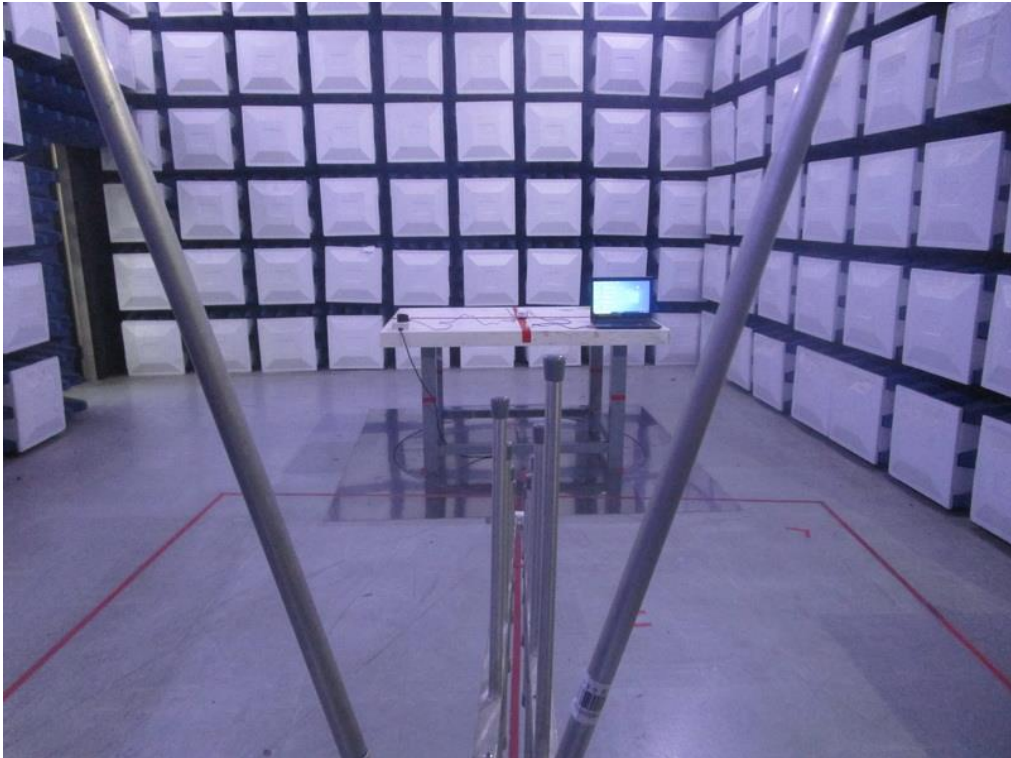

Radiated Emissions Test Photos

Above 1 GHz

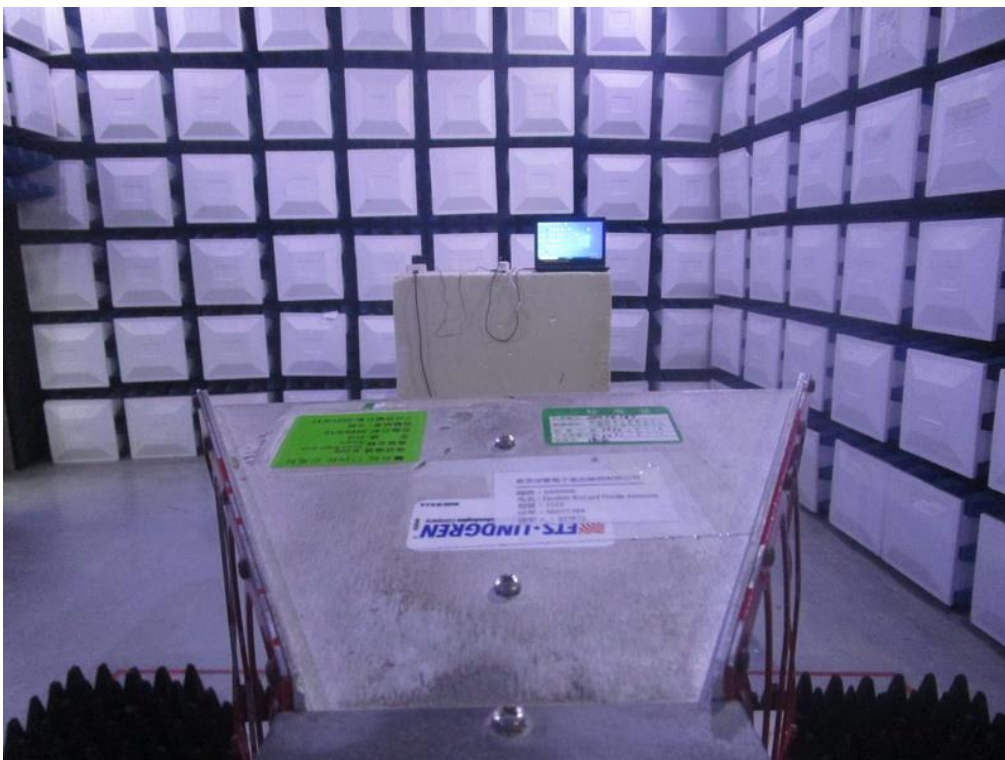

APPENDIX A - AC POWER LINE CONDUCTED EMISSIONS

Test Mode: TX N-20M Mode Channel 06

Line

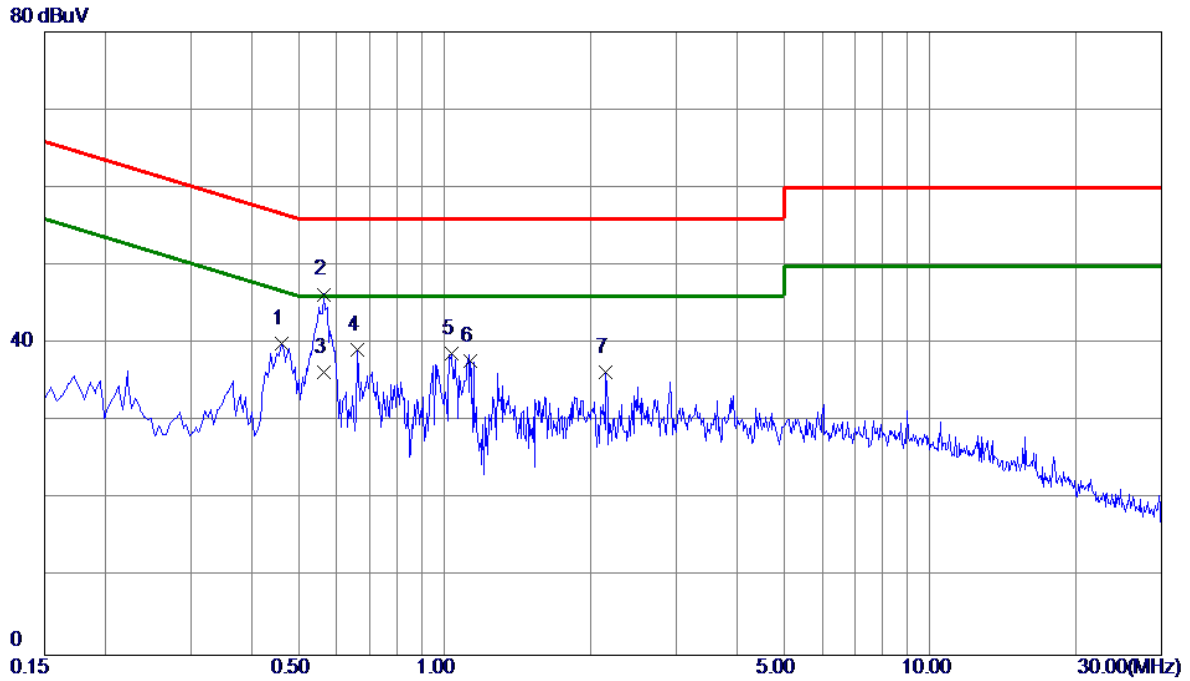

No.	Freq. MHz	Reading Level dBuV	Correct Factor dB	Measure ment dBuV	Limit dBuV	Margin dB	Detector	Comment
1	0.4605	30.10	9.94	40.04	56.68	-16.64	Peak	
2 *	0.5639	36.36	9.96	46.32	56.00	-9.68	Peak	
3	0.5639	26.30	9.96	36.26	46.00	-9.74	AVG	
4	0.6630	29.28	9.90	39.18	56.00	-16.82	Peak	
5	1.0365	28.70	10.01	38.71	56.00	-17.29	Peak	
6	1.1310	27.81	10.02	37.83	56.00	-18.17	Peak	
7	2.1480	26.15	10.10	36.25	56.00	-19.75	Peak	

REMARKS:

(1) Measurement Value = Reading Level + Correct Factor.

(2) Margin Level = Measurement Value - Limit Value.

Test Mode: TX N-20M Mode Channel 06

Neutral

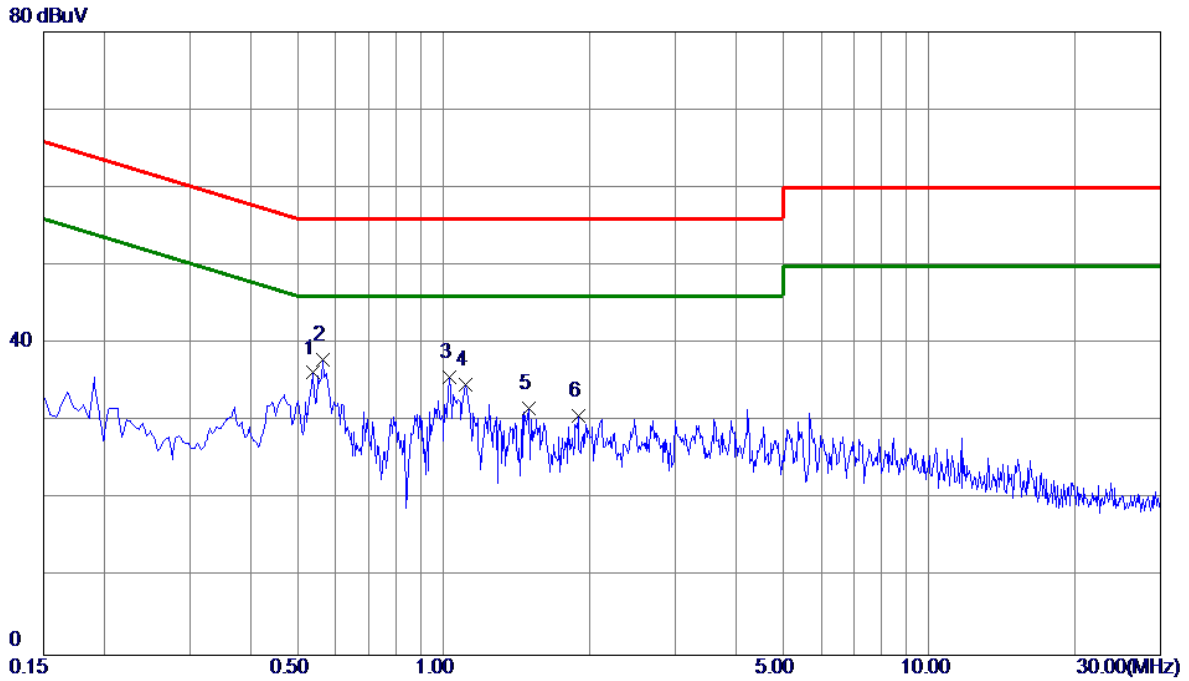

No.	Freq. MHz	Reading Level dBuV	Correct Factor dB	Measure ment dBuV	Limit dBuV	Margin dB	Detector	Comment
1	0.5370	26.08	10.16	36.24	56.00	-19.76	Peak	
2 *	0.5639	27.72	10.17	37.89	56.00	-18.11	Peak	
3	1.0275	25.38	10.30	35.68	56.00	-20.32	Peak	
4	1.1085	24.34	10.31	34.65	56.00	-21.35	Peak	
5	1.5000	21.26	10.36	31.62	56.00	-24.38	Peak	
6	1.8960	20.32	10.41	30.73	56.00	-25.27	Peak	

REMARKS:

(1) Measurement Value = Reading Level + Correct Factor.

(2) Margin Level = Measurement Value - Limit Value.

APPENDIX B - RADIATED EMISSION - 9 KHZ TO 30 MHZ

Test Mode: TX N-20M Mode Channel 06

Ant 0°

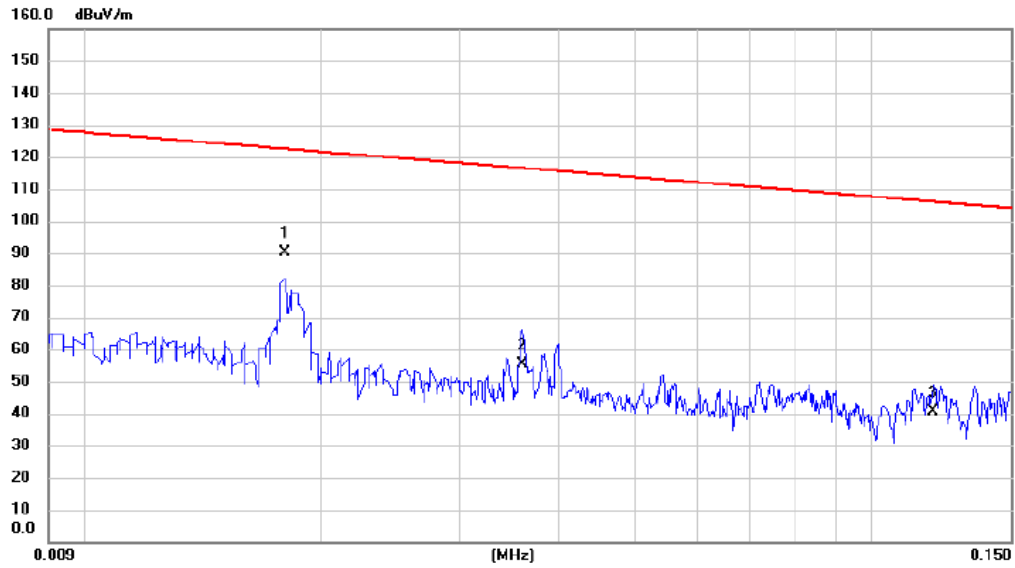

No.	Mk.	Freq.	Reading Level	Correct Factor	Measurement	Limit	Margin	Detector	Comment
		MHz	dBuV	dB	dBuV/m	dBuV/m	dB		
1	*	0.0180	76.55	13.84	90.39	122.50	-32.11	AVG	
2		0.0360	42.74	12.79	55.53	116.48	-60.95	AVG	
3		0.1197	27.80	12.73	40.53	106.05	-65.52	AVG	

REMARKS:

- (1) Measurement Value = Reading Level + Correct Factor.
- (2) Margin Level = Measurement Value - Limit Value.

Test Mode: TX N-20M Mode Channel 06

Ant 0°

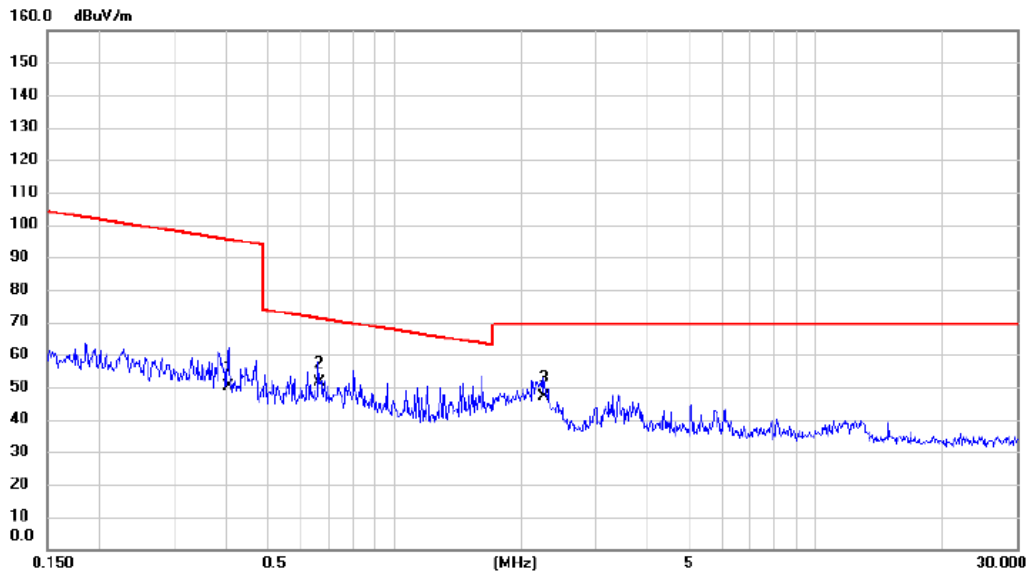

No.	Mk.	Freq. MHz	Reading Level dBuV	Correct Factor dB	Measure- ment dBuV/m	Limit dBuV/m	Margin dB	Detector	Comment
1		0.4040	38.15	12.25	50.40	95.48	-45.08	AVG	
2	*	0.6613	39.59	11.95	51.54	71.20	-19.66	QP	
3		2.2606	35.71	11.17	46.88	69.54	-22.66	QP	

REMARKS:

- (1) Measurement Value = Reading Level + Correct Factor.
- (2) Margin Level = Measurement Value - Limit Value.

Test Mode: TX N-20M Mode Channel 06

Ant 90°

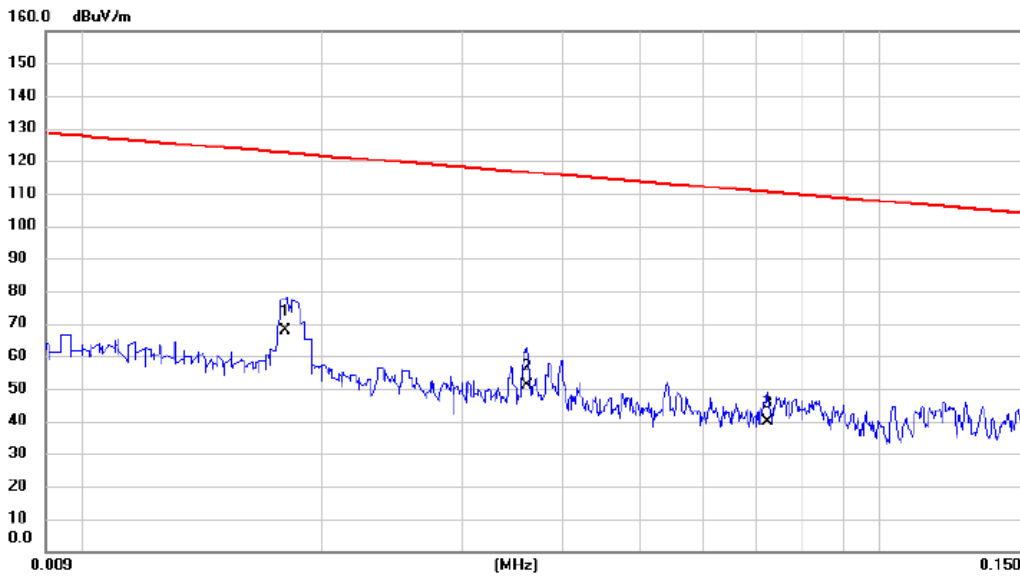

No.	Mk.	Freq. MHz	Reading Level dBuV	Correct Factor dB	Measure- ment dBuV/m	Limit dBuV/m	Margin dB	Detector	Comment
1	*	0.0180	54.09	13.84	67.93	122.50	-54.57	AVG	
2		0.0361	38.16	12.79	50.95	116.45	-65.50	AVG	
3		0.0724	27.34	12.55	39.89	110.41	-70.52	AVG	

REMARKS:

- (1) Measurement Value = Reading Level + Correct Factor.
- (2) Margin Level = Measurement Value - Limit Value.

Test Mode: TX N-20M Mode Channel 06

Ant 90°

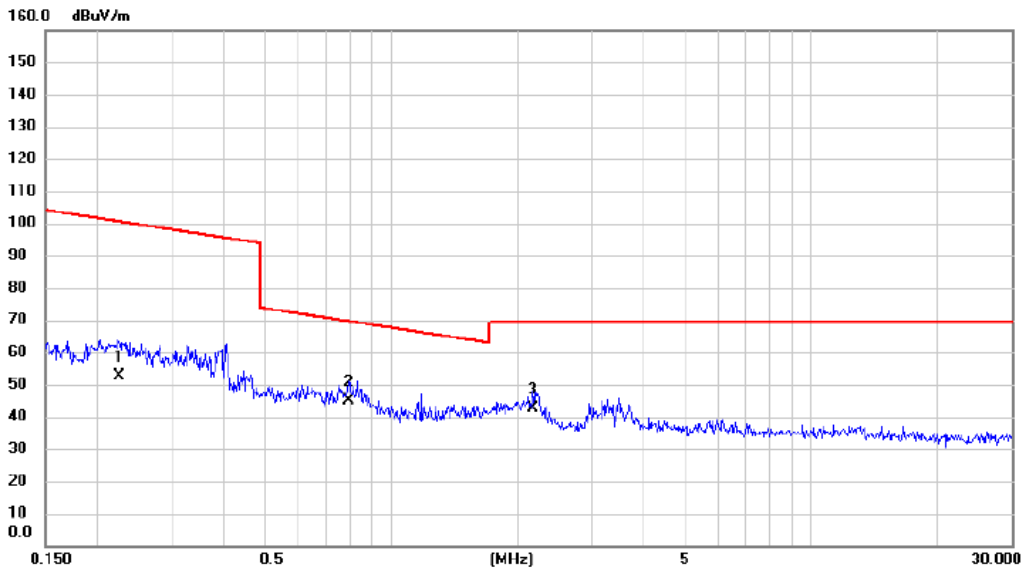

No.	Mk.	Freq. MHz	Reading Level dBuV	Correct Factor dB	Measure- ment dBuV/m	Limit dBuV/m	Margin dB	Detector	Comment
1		0.2244	39.73	12.71	52.44	100.59	-48.15	AVG	
2	*	0.7917	33.16	11.88	45.04	69.63	-24.59	QP	
3		2.1668	31.50	11.22	42.72	69.54	-26.82	QP	

REMARKS:

- (1) Measurement Value = Reading Level + Correct Factor.
- (2) Margin Level = Measurement Value - Limit Value.

APPENDIX C - RADIATED EMISSION - 30 MHZ TO 1000 MHZ

Test Mode: TX N-20M Mode Channel 06

Vertical

80 dBuV/m

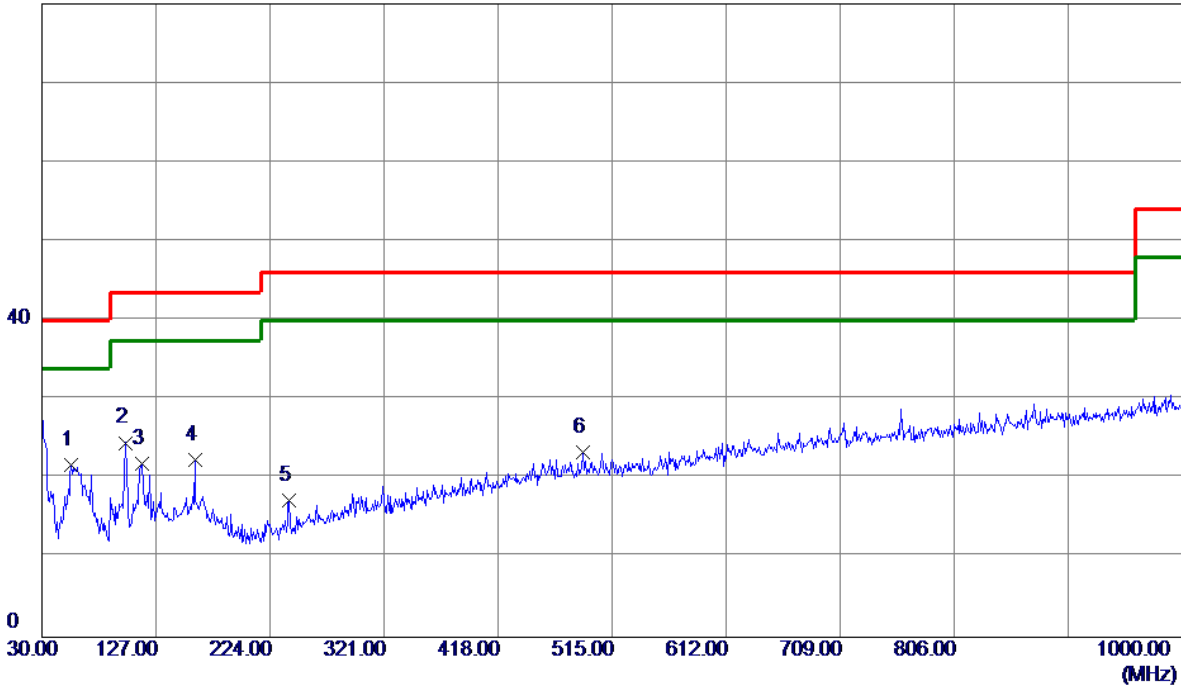

No.	Freq. MHz	Reading Level dBuV/m	Correct Factor dB	Measure ment dBuV/m	Limit dBuV/m	Margin dB	Detector	Comment
1 *	55.2200	35.40	-13.69	21.71	40.00	-18.29	Peak	
2	100.8100	39.42	-14.86	24.56	43.50	-18.94	Peak	
3	115.3600	35.32	-13.43	21.89	43.50	-21.61	Peak	
4	159.9800	33.11	-10.67	22.44	43.50	-21.06	Peak	
5	240.4900	30.91	-13.57	17.34	46.00	-28.66	Peak	
6	489.7800	30.66	-7.34	23.32	46.00	-22.68	Peak	

REMARKS:

- (1) Measurement Value = Reading Level + Correct Factor.
- (2) Margin Level = Measurement Value - Limit Value.

Test Mode: TX N-20M Mode Channel 06

Horizontal

80 dBuV/m

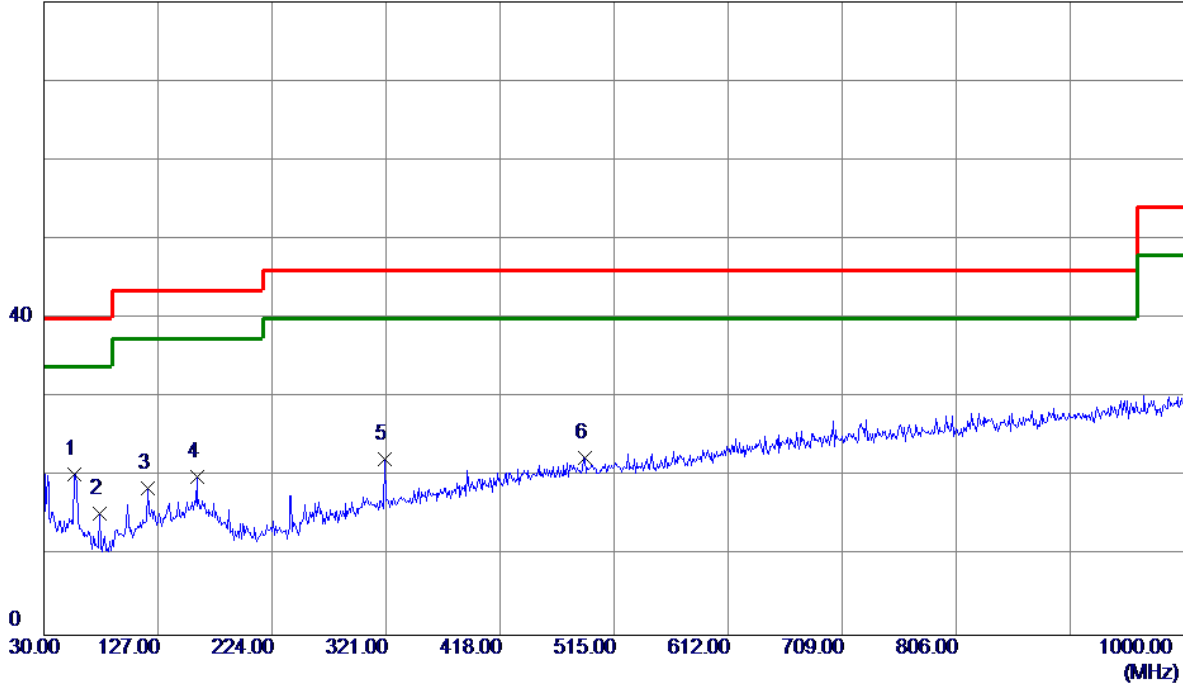

No.	Freq. MHz	Reading Level dBuV/m	Correct Factor dB	Measure ment dBuV/m	Limit dBuV/m	Margin dB	Detector	Comment
1 *	56.1900	34.16	-13.81	20.35	40.00	-19.65	Peak	
2	77.5300	32.69	-17.28	15.41	40.00	-24.59	Peak	
3	118.2700	31.58	-13.00	18.58	43.50	-24.92	Peak	
4	159.9800	30.65	-10.67	19.98	43.50	-23.52	Peak	
5	320.0300	32.86	-10.68	22.18	46.00	-23.82	Peak	
6	489.7800	29.71	-7.34	22.37	46.00	-23.63	Peak	

REMARKS:

(1) Measurement Value = Reading Level + Correct Factor.

(2) Margin Level = Measurement Value - Limit Value.

APPENDIX D - RADIATED EMISSION- ABOVE 1000 MHZ

Test Mode: TX B Mode 2412 MHz

Vertical

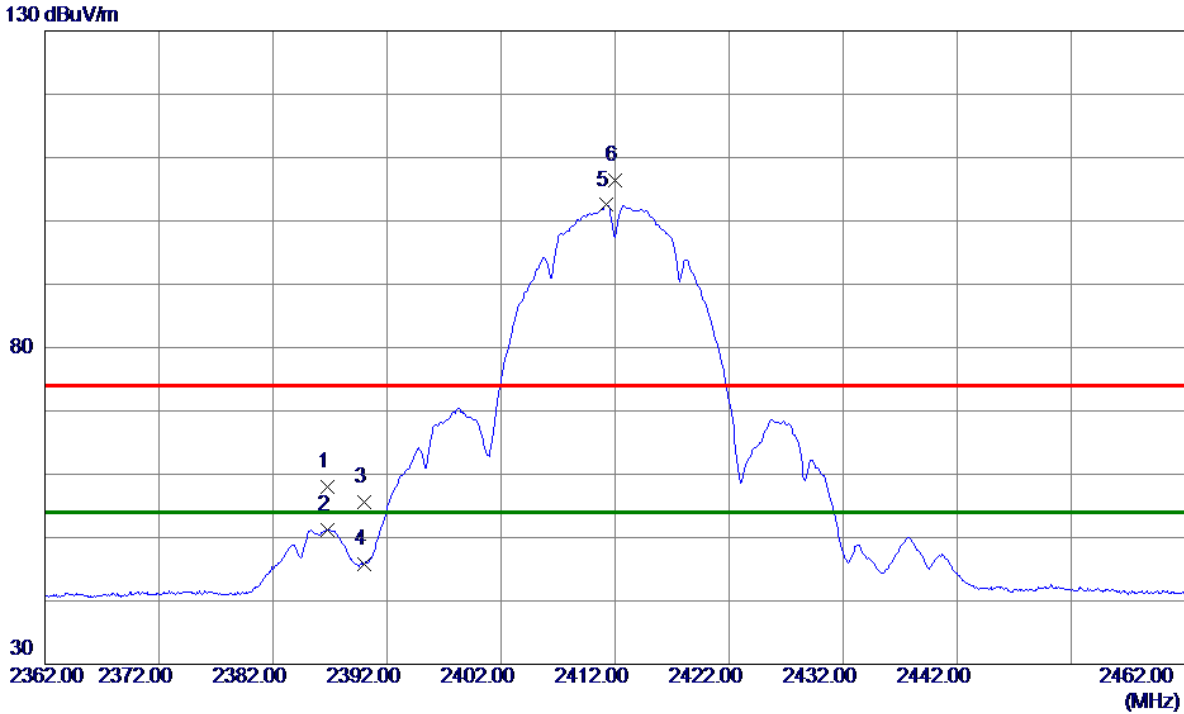

No.	Freq. MHz	Reading Level dBuV/m	Correct Factor dB	Measure ment dBuV/m	Limit dBuV/m	Margin dB	Detector	Comment
1	2386.7500	47.31	10.61	57.92	74.00	-16.08	Peak	
2	2386.7500	40.67	10.61	51.28	54.00	-2.72	AVG	
3	2390.0000	44.95	10.62	55.57	74.00	-18.43	Peak	
4	2390.0000	35.09	10.62	45.71	54.00	-8.29	AVG	
5 *	2411.2500	91.81	10.69	102.50	54.00	48.50	AVG	No Limit
6	2412.0500	95.62	10.69	106.31	74.00	32.31	Peak	No Limit

REMARKS:

- (1) Measurement Value = Reading Level + Correct Factor.
- (2) Margin Level = Measurement Value - Limit Value.

Test Mode: TX B Mode 2412 MHz

Vertical

80 dBuV/m

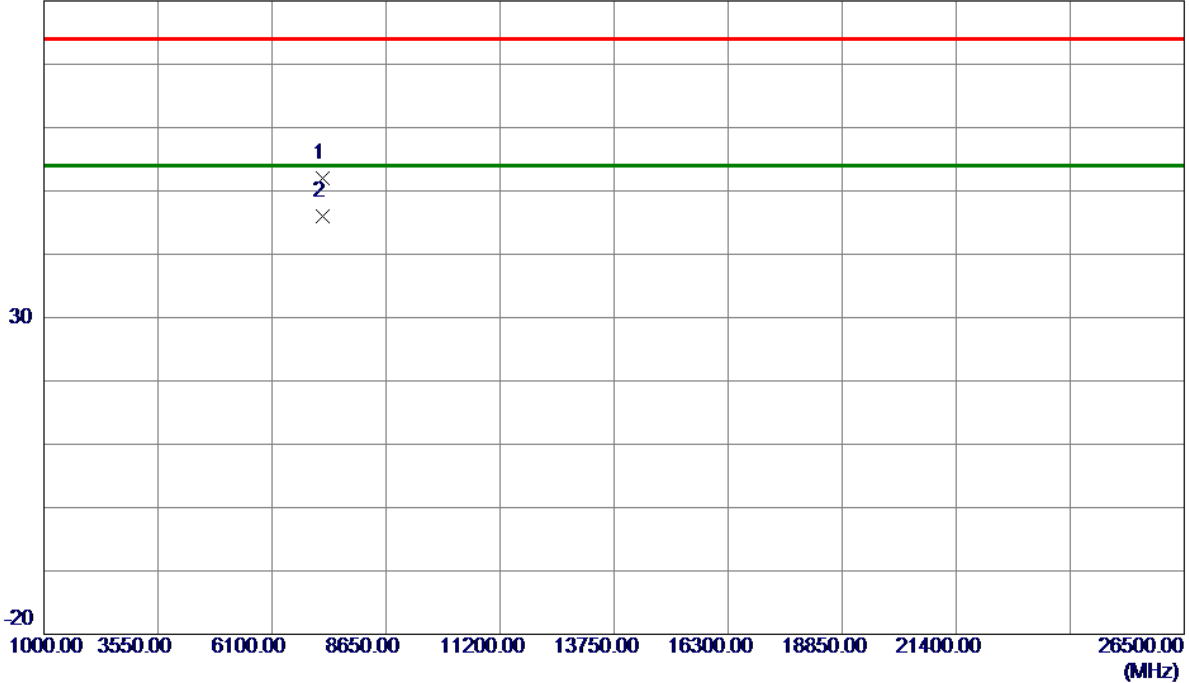

No.	Freq. MHz	Reading Level dBuV/m	Correct Factor dB	Measure ment dBuV/m	Limit dBuV/m	Margin dB	Detector	Comment
1	7235.9700	40.30	11.75	52.05	74.00	-21.95	Peak	
2 *	7236.6900	34.33	11.75	46.08	54.00	-7.92	AVG	

REMARKS:

- (1) Measurement Value = Reading Level + Correct Factor.
- (2) Margin Level = Measurement Value - Limit Value.

Test Mode: TX B Mode 2412 MHz

Horizontal

130 dBuV/m

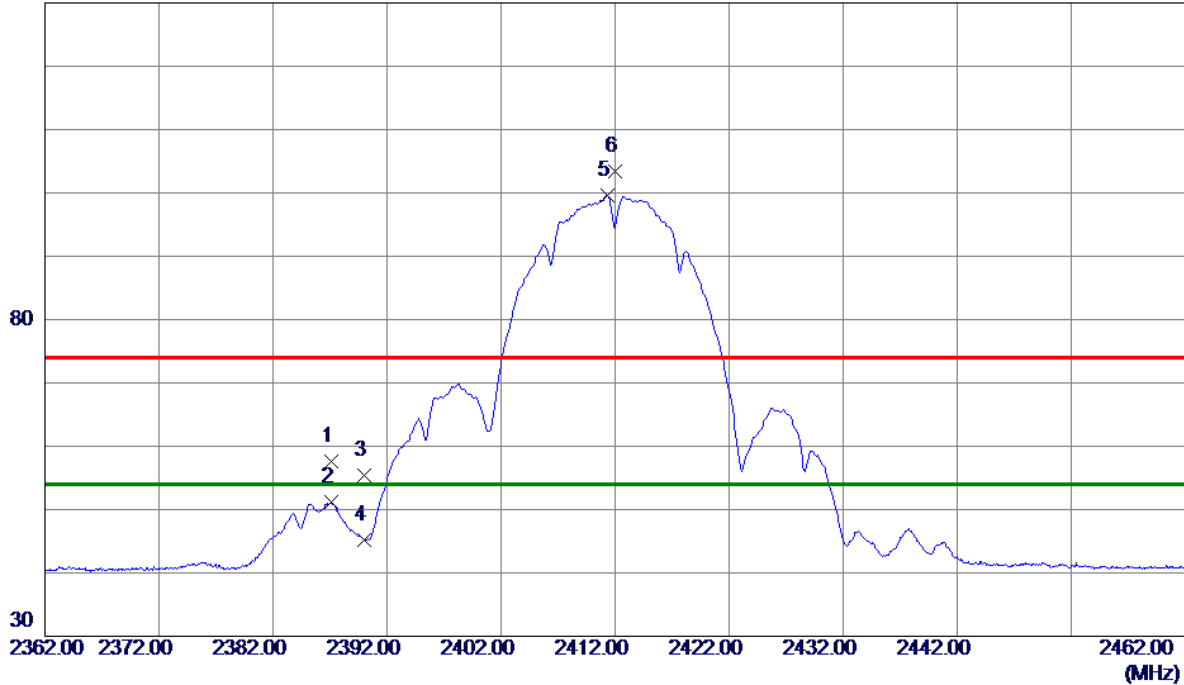

No.	Freq. MHz	Reading Level dBuV/m	Correct Factor dB	Measure ment dBuV/m	Limit dBuV/m	Margin dB	Detector	Comment
1	2387.1500	46.94	10.61	57.55	74.00	-16.45	Peak	
2	2387.1500	40.51	10.61	51.12	54.00	-2.88	AVG	
3	2390.0000	44.82	10.62	55.44	74.00	-18.56	Peak	
4	2390.0000	34.65	10.62	45.27	54.00	-8.73	AVG	
5 *	2411.3000	88.86	10.69	99.55	54.00	45.55	AVG	No Limit
6	2411.9500	92.64	10.69	103.33	74.00	29.33	Peak	No Limit

REMARKS:

- (1) Measurement Value = Reading Level + Correct Factor.
- (2) Margin Level = Measurement Value - Limit Value.

Test Mode: TX B Mode 2412 MHz

Horizontal

80 dBuV/m

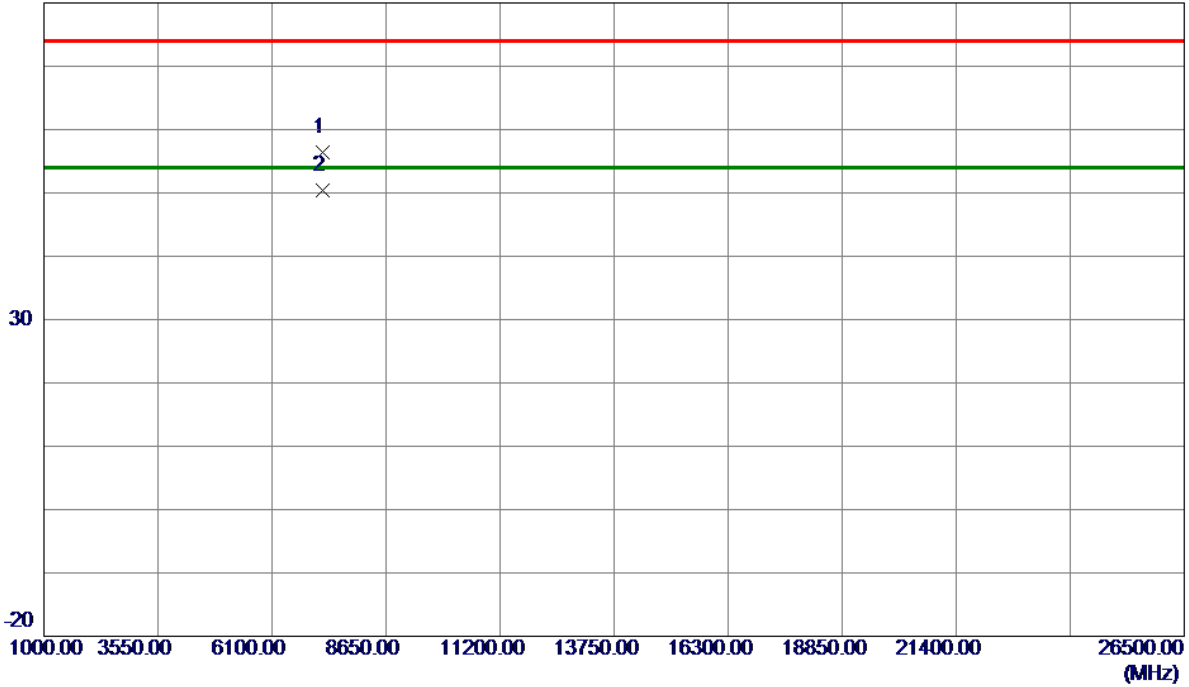

No.	Freq. MHz	Reading Level dBuV/m	Correct Factor dB	Measure ment dBuV/m	Limit dBuV/m	Margin dB	Detector	Comment
1	7235.7500	44.67	11.75	56.42	74.00	-17.58	Peak	
2 *	7236.6900	38.72	11.75	50.47	54.00	-3.53	AVG	

REMARKS:

(1) Measurement Value = Reading Level + Correct Factor.

(2) Margin Level = Measurement Value - Limit Value.

Test Mode: TX B Mode 2437 MHz

Vertical

130 dBuV/m

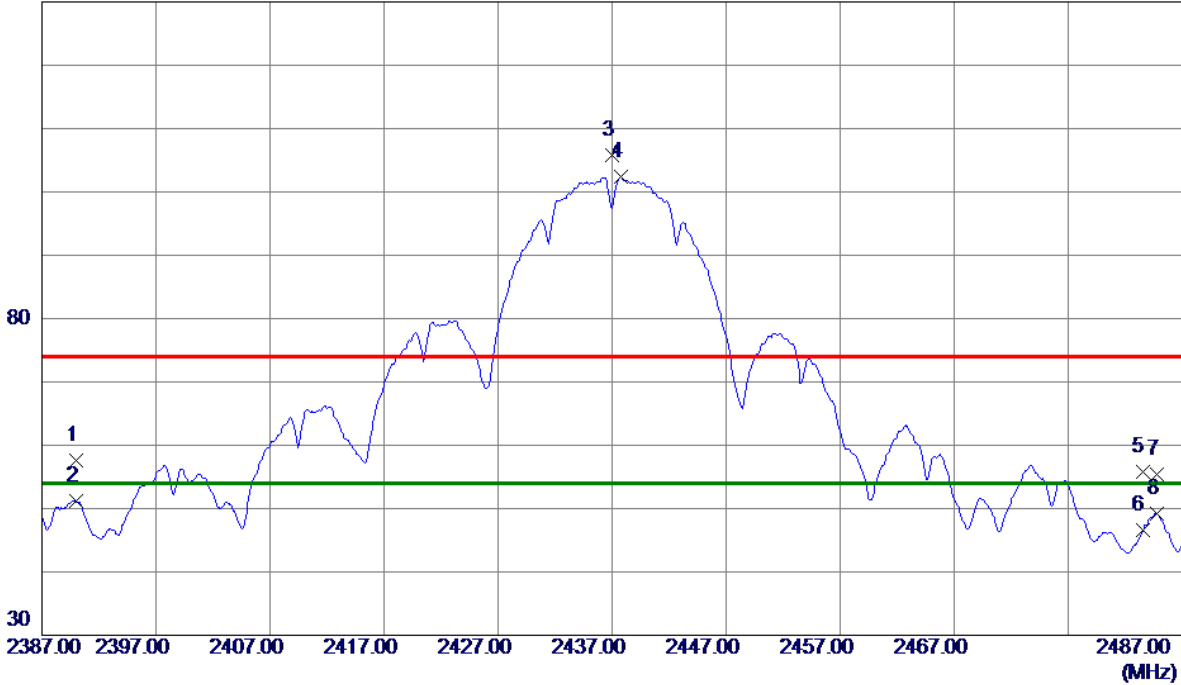

No.	Freq. MHz	Reading Level dBuV/m	Correct Factor dB	Measure ment dBuV/m	Limit dBuV/m	Margin dB	Detector	Comment
1	2390.0000	47.01	10.62	57.63	74.00	-16.37	Peak	
2	2390.0000	40.61	10.62	51.23	54.00	-2.77	AVG	
3	2437.0000	95.12	10.76	105.88	74.00	31.88	Peak	No Limit
4 *	2437.7500	91.61	10.76	102.37	54.00	48.37	AVG	No Limit
5	2483.5000	44.98	10.90	55.88	74.00	-18.12	Peak	
6	2483.5000	35.69	10.90	46.59	54.00	-7.41	AVG	
7	2484.7500	44.52	10.90	55.42	74.00	-18.58	Peak	
8	2484.7500	38.38	10.90	49.28	54.00	-4.72	AVG	

REMARKS:

- (1) Measurement Value = Reading Level + Correct Factor.
- (2) Margin Level = Measurement Value - Limit Value.

Test Mode: TX B Mode 2437 MHz

Vertical

80 dBuV/m

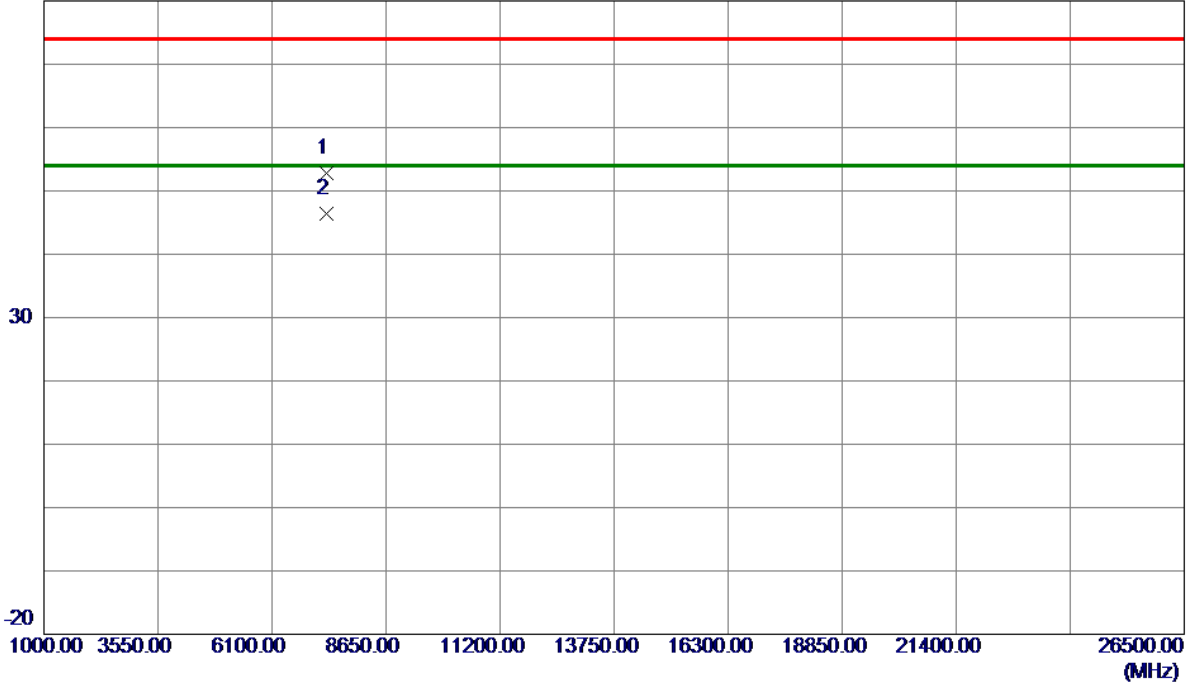

No.	Freq. MHz	Reading Level dBuV/m	Correct Factor dB	Measure ment dBuV/m	Limit dBuV/m	Margin dB	Detector	Comment
1	7310.8300	40.94	11.82	52.76	74.00	-21.24	Peak	
2 *	7311.6400	34.58	11.82	46.40	54.00	-7.60	AVG	

REMARKS:

- (1) Measurement Value = Reading Level + Correct Factor.
- (2) Margin Level = Measurement Value - Limit Value.

Test Mode: TX B Mode 2437 MHz

Horizontal

130 dBuV/m

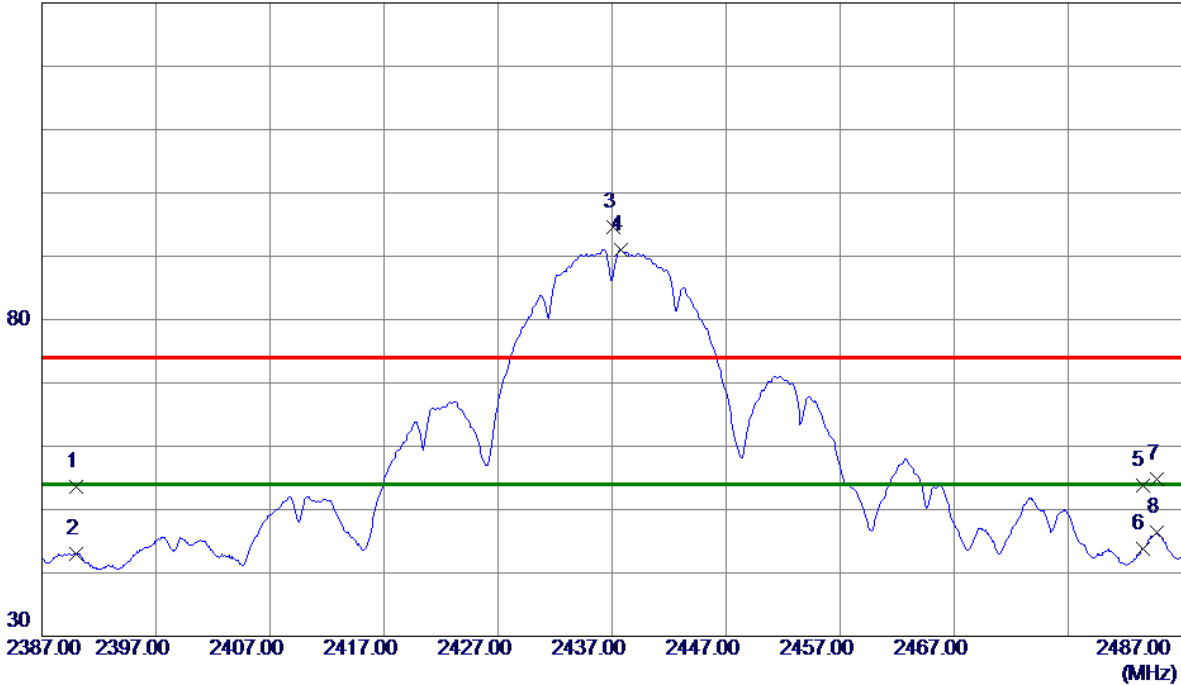

No.	Freq. MHz	Reading Level dBuV/m	Correct Factor dB	Measure ment dBuV/m	Limit dBuV/m	Margin dB	Detector	Comment
1	2390.0000	43.03	10.62	53.65	74.00	-20.35	Peak	
2	2390.0000	32.47	10.62	43.09	54.00	-10.91	AVG	
3	2437.1000	83.89	10.76	94.65	74.00	20.65	Peak	No Limit
4 *	2437.8000	80.33	10.76	91.09	54.00	37.09	AVG	No Limit
5	2483.5000	42.91	10.90	53.81	74.00	-20.19	Peak	
6	2483.5000	32.85	10.90	43.75	54.00	-10.25	AVG	
7	2484.7500	43.83	10.90	54.73	74.00	-19.27	Peak	
8	2484.7500	35.47	10.90	46.37	54.00	-7.63	AVG	

REMARKS:

- (1) Measurement Value = Reading Level + Correct Factor.
- (2) Margin Level = Measurement Value - Limit Value.

Test Mode: TX B Mode 2437 MHz

Horizontal

80 dBuV/m

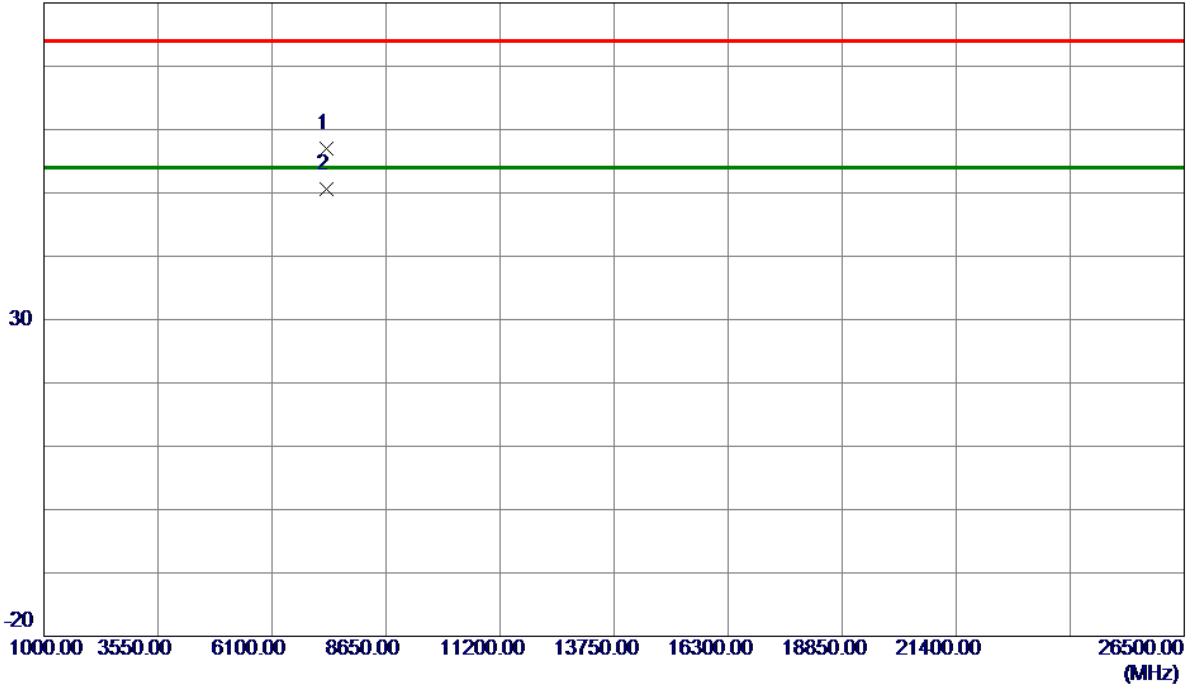

No.	Freq. MHz	Reading Level dBuV/m	Correct Factor dB	Measure ment dBuV/m	Limit dBuV/m	Margin dB	Detector	Comment
1	7311.1200	45.16	11.82	56.98	74.00	-17.02	Peak	
2 *	7311.7500	38.77	11.82	50.59	54.00	-3.41	AVG	

REMARKS:

(1) Measurement Value = Reading Level + Correct Factor.

(2) Margin Level = Measurement Value - Limit Value.

Test Mode: TX B Mode 2462 MHz

Vertical

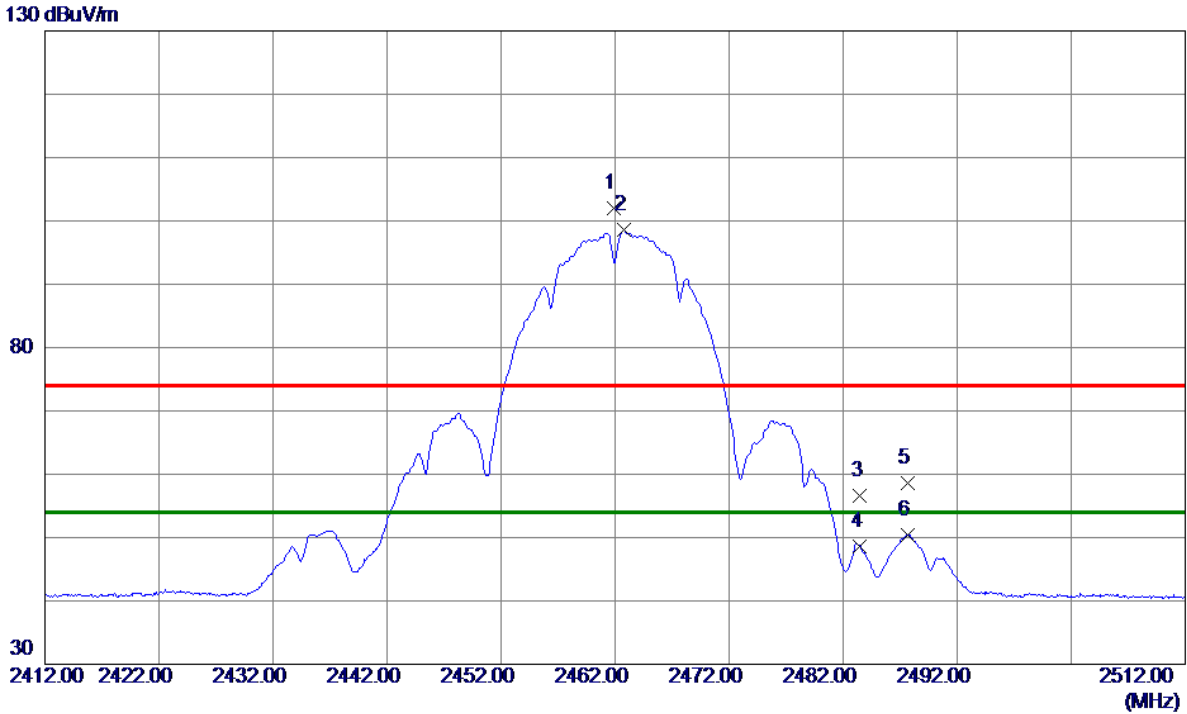

No.	Freq. MHz	Reading Level dBuV/m	Correct Factor dB	Measure ment dBuV/m	Limit dBuV/m	Margin dB	Detector	Comment
1	2461.8500	91.07	10.84	101.91	74.00	27.91	Peak	No Limit
2 *	2462.7500	87.71	10.84	98.55	54.00	44.55	AVG	No Limit
3	2483.5000	45.65	10.90	56.55	74.00	-17.45	Peak	
4	2483.5000	37.66	10.90	48.56	54.00	-5.44	AVG	
5	2487.7000	47.61	10.91	58.52	74.00	-15.48	Peak	
6	2487.7000	39.54	10.91	50.45	54.00	-3.55	AVG	

REMARKS:

- (1) Measurement Value = Reading Level + Correct Factor.
- (2) Margin Level = Measurement Value - Limit Value.

Test Mode: TX B Mode 2462 MHz

Vertical

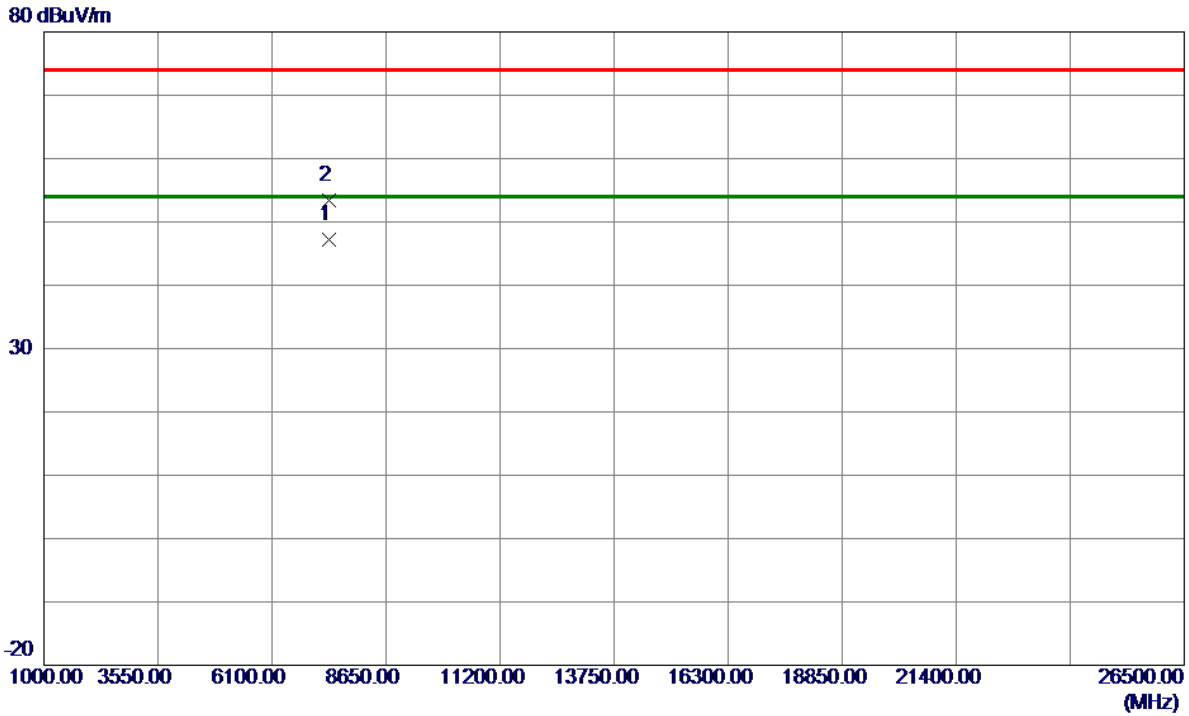

No.	Freq. MHz	Reading Level dBuV/m	Correct Factor dB	Measure ment dBuV/m	Limit dBuV/m	Margin dB	Detector	Comment
1 *	7385.2400	35.28	11.89	47.17	54.00	-6.83	AVG	
2	7385.7100	41.53	11.89	53.42	74.00	-20.58	Peak	

REMARKS:

- (1) Measurement Value = Reading Level + Correct Factor.
- (2) Margin Level = Measurement Value - Limit Value.

Test Mode: TX B Mode 2462 MHz

Horizontal

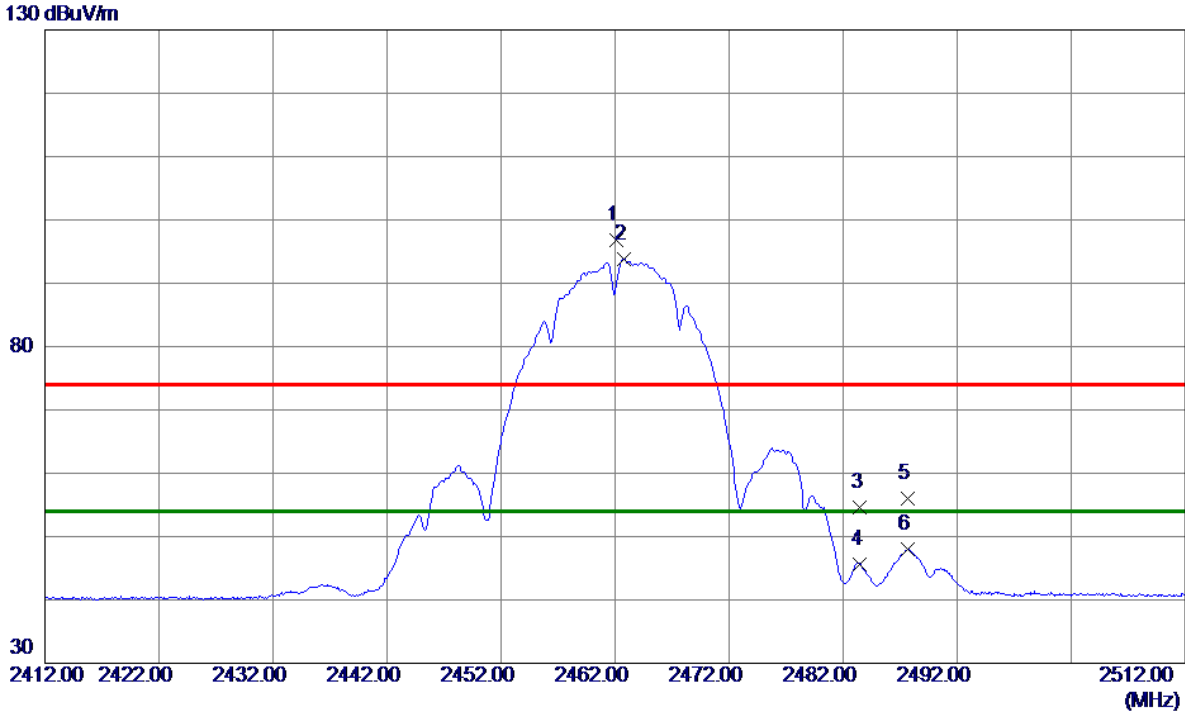

No.	Freq. MHz	Reading Level dBuV/m	Correct Factor dB	Measure ment dBuV/m	Limit dBuV/m	Margin dB	Detector	Comment
1	2462.1000	85.91	10.84	96.75	74.00	22.75	Peak	No Limit
2 *	2462.7500	83.05	10.84	93.89	54.00	39.89	AVG	No Limit
3	2483.5000	43.74	10.90	54.64	74.00	-19.36	Peak	
4	2483.5000	34.74	10.90	45.64	54.00	-8.36	AVG	
5	2487.7000	45.06	10.91	55.97	74.00	-18.03	Peak	
6	2487.7000	37.09	10.91	48.00	54.00	-6.00	AVG	

REMARKS:

- (1) Measurement Value = Reading Level + Correct Factor.
- (2) Margin Level = Measurement Value - Limit Value.

Test Mode: TX B Mode 2462 MHz

Horizontal

80 dBuV/m

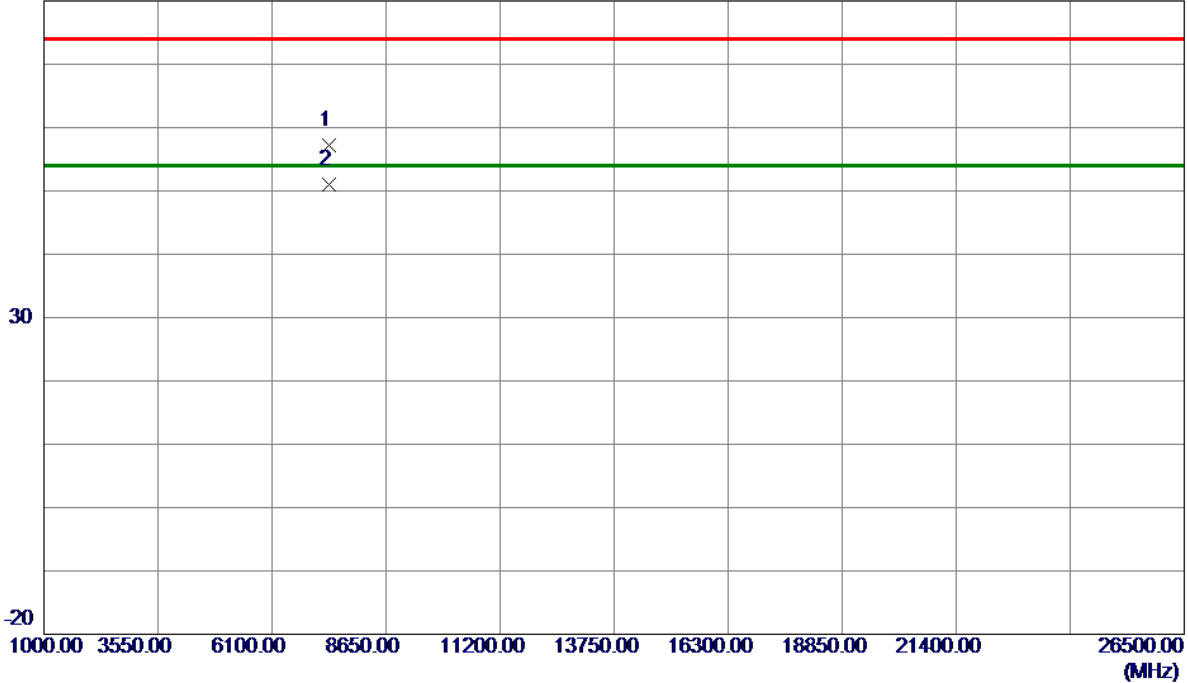

No.	Freq. MHz	Reading Level dBuV/m	Correct Factor dB	Measure ment dBuV/m	Limit dBuV/m	Margin dB	Detector	Comment
1	7385.9300	45.26	11.89	57.15	74.00	-16.85	Peak	
2 *	7386.7000	39.13	11.89	51.02	54.00	-2.98	AVG	

REMARKS:

(1) Measurement Value = Reading Level + Correct Factor.

(2) Margin Level = Measurement Value - Limit Value.

Test Mode: TX G Mode 2412 MHz

Vertical

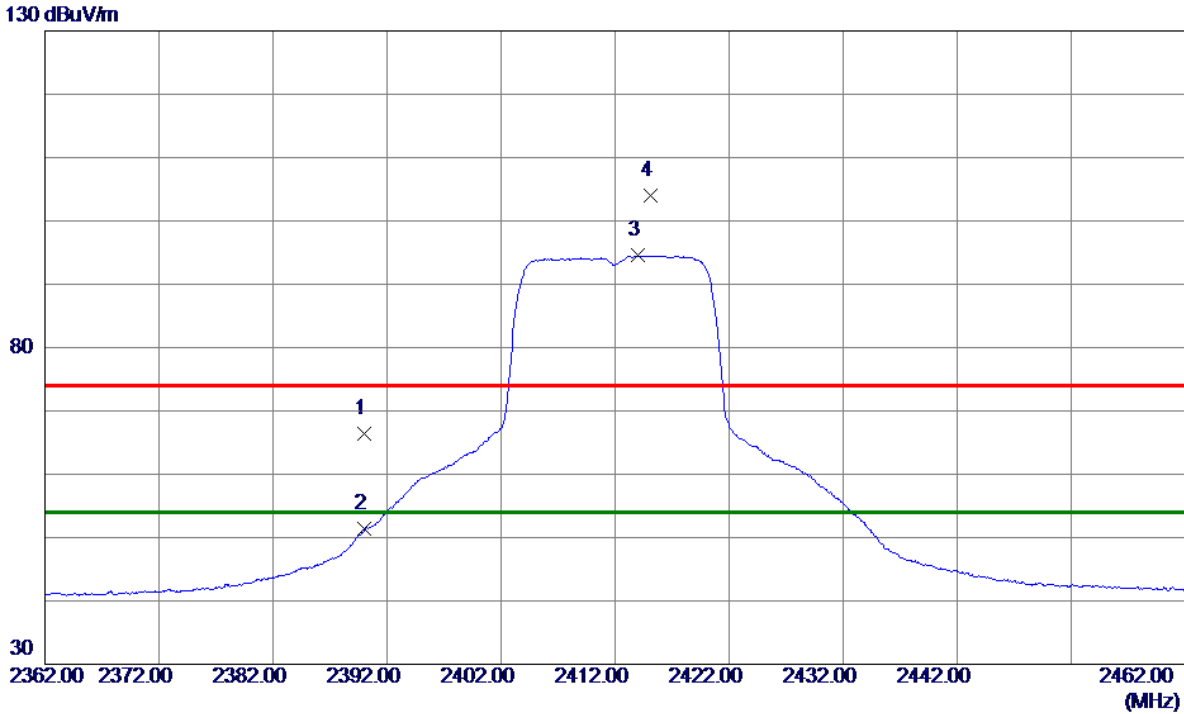

No.	Freq. MHz	Reading Level dBuV/m	Correct Factor dB	Measure ment dBuV/m	Limit dBuV/m	Margin dB	Detector	Comment
1	2390.0000	55.81	10.62	66.43	74.00	-7.57	Peak	
2	2390.0000	40.71	10.62	51.33	54.00	-2.67	AVG	
3 *	2414.0500	83.83	10.69	94.52	54.00	40.52	AVG	No Limit
4	2415.1500	93.32	10.70	104.02	74.00	30.02	Peak	No Limit

REMARKS:

- (1) Measurement Value = Reading Level + Correct Factor.
- (2) Margin Level = Measurement Value - Limit Value.

Test Mode: TX G Mode 2412 MHz

Vertical

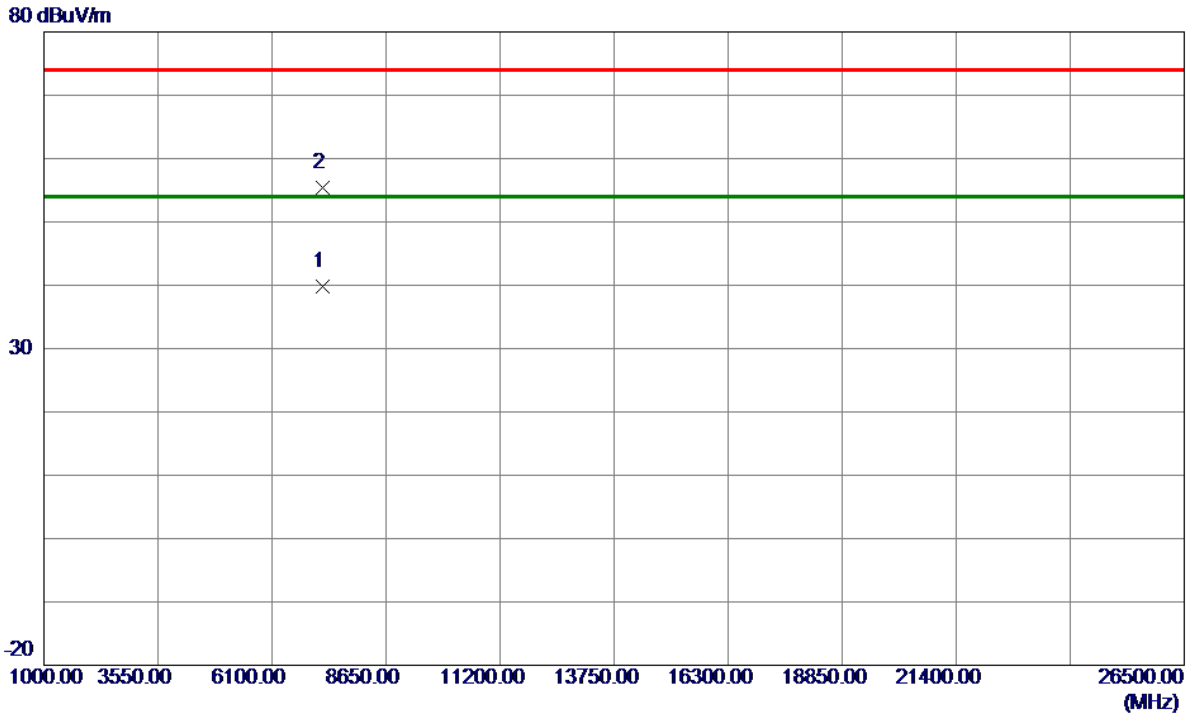

No.	Freq. MHz	Reading Level dBuV/m	Correct Factor dB	Measure ment dBuV/m	Limit dBuV/m	Margin dB	Detector	Comment
1 *	7238.5300	27.97	11.75	39.72	54.00	-14.28	AVG	
2	7242.6800	43.56	11.75	55.31	74.00	-18.69	Peak	

REMARKS:

- (1) Measurement Value = Reading Level + Correct Factor.
- (2) Margin Level = Measurement Value - Limit Value.

Test Mode: TX G Mode 2412 MHz

Horizontal

130 dBuV/m

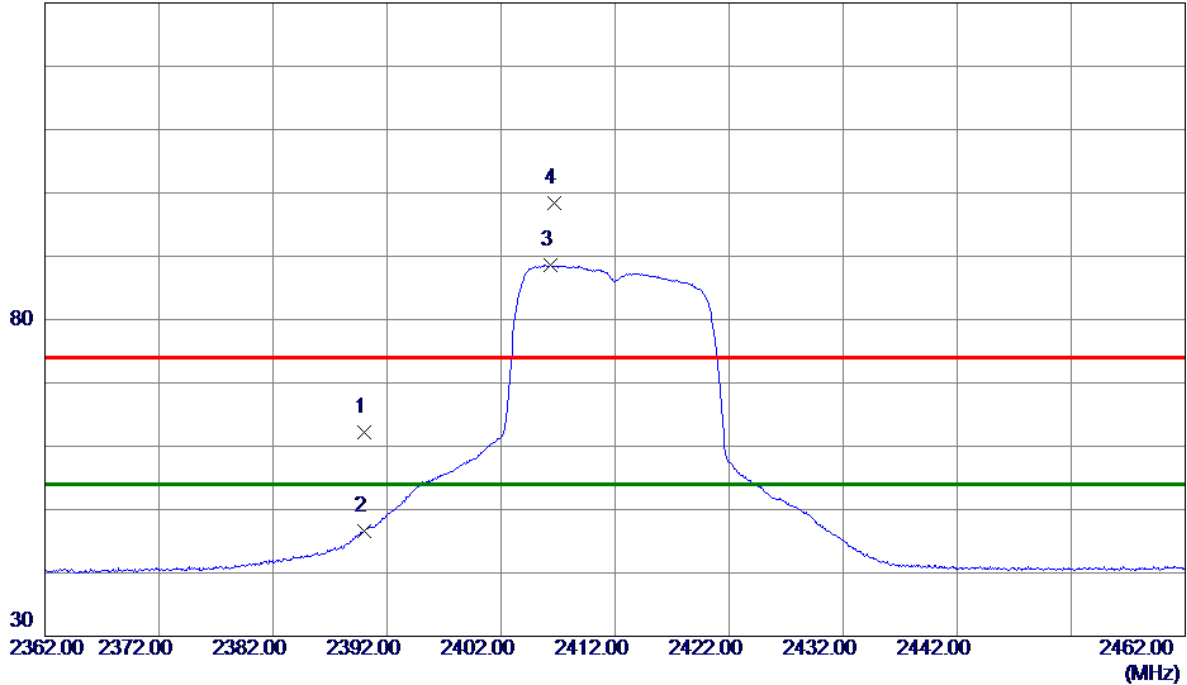

No.	Freq. MHz	Reading Level dBuV/m	Correct Factor dB	Measure ment dBuV/m	Limit dBuV/m	Margin dB	Detector	Comment
1	2390.0000	51.66	10.62	62.28	74.00	-11.72	Peak	
2	2390.0000	35.96	10.62	46.58	54.00	-7.42	AVG	
3 *	2406.3500	77.89	10.67	88.56	54.00	34.56	AVG	No Limit
4	2406.7000	87.64	10.67	98.31	74.00	24.31	Peak	No Limit

REMARKS:

- (1) Measurement Value = Reading Level + Correct Factor.
- (2) Margin Level = Measurement Value - Limit Value.

Test Mode: TX G Mode 2412 MHz

Horizontal

80 dBuV/m

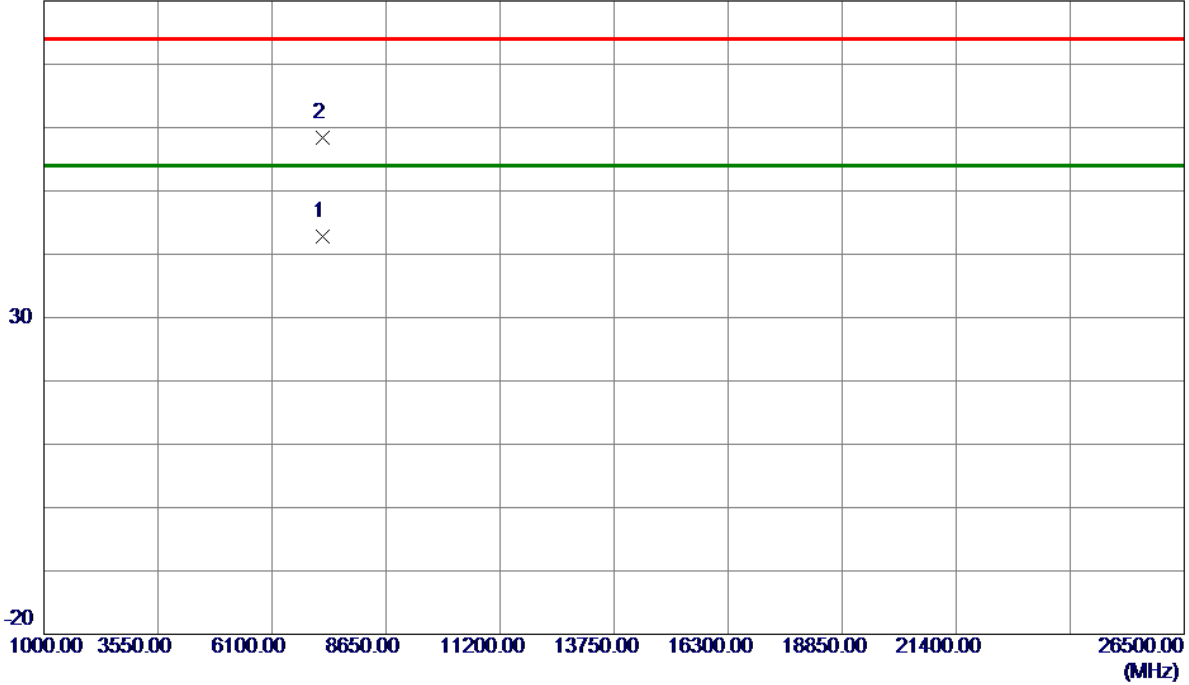

No.	Freq. MHz	Reading Level dBuV/m	Correct Factor dB	Measure ment dBuV/m	Limit dBuV/m	Margin dB	Detector	Comment
1 *	7237.9900	31.05	11.75	42.80	54.00	-11.20	AVG	
2	7242.7600	46.64	11.75	58.39	74.00	-15.61	Peak	

REMARKS:

- (1) Measurement Value = Reading Level + Correct Factor.
- (2) Margin Level = Measurement Value - Limit Value.

Test Mode: TX G Mode 2437 MHz

Vertical

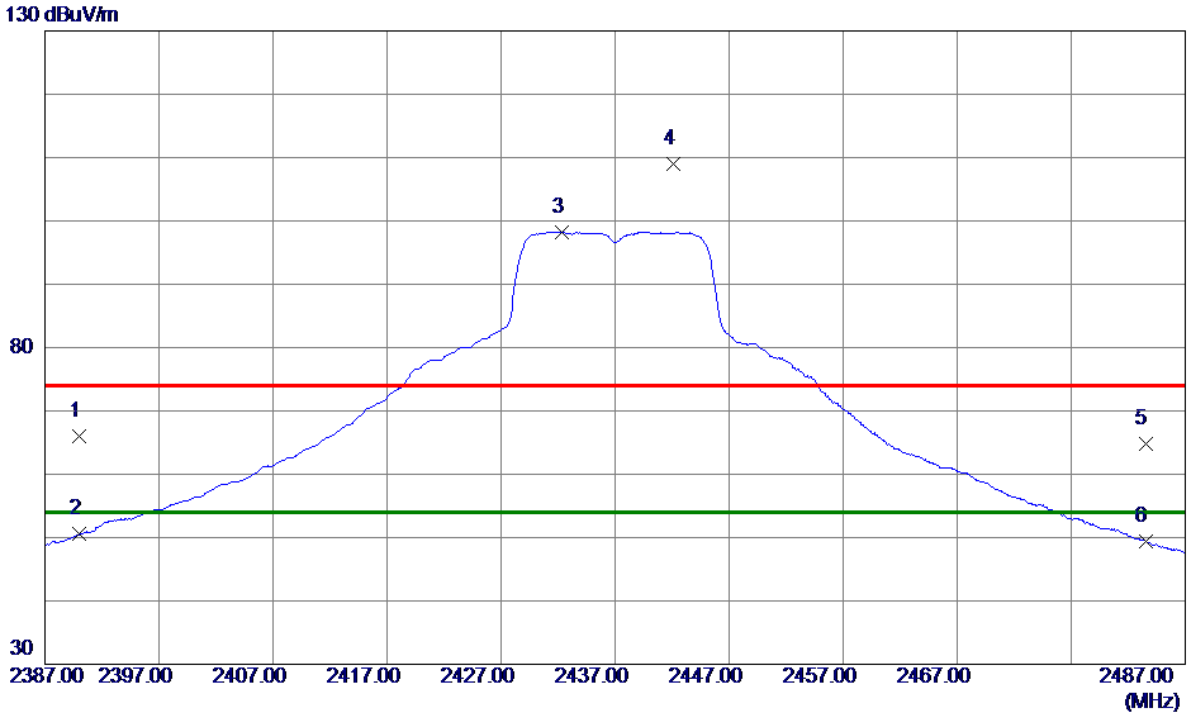

No.	Freq. MHz	Reading Level dBuV/m	Correct Factor dB	Measurement dBuV/m	Limit dBuV/m	Margin dB	Detector	Comment
1	2390.0000	55.45	10.62	66.07	74.00	-7.93	Peak	
2	2390.0000	39.90	10.62	50.52	54.00	-3.48	AVG	
3 *	2432.3000	87.52	10.75	98.27	54.00	44.27	AVG	No Limit
4	2442.1500	98.20	10.78	108.98	74.00	34.98	Peak	No Limit
5	2483.5000	53.97	10.90	64.87	74.00	-9.13	Peak	
6	2483.5000	38.44	10.90	49.34	54.00	-4.66	AVG	

REMARKS:

- (1) Measurement Value = Reading Level + Correct Factor.
- (2) Margin Level = Measurement Value - Limit Value.

Test Mode: TX G Mode 2437 MHz

Vertical

80 dBuV/m

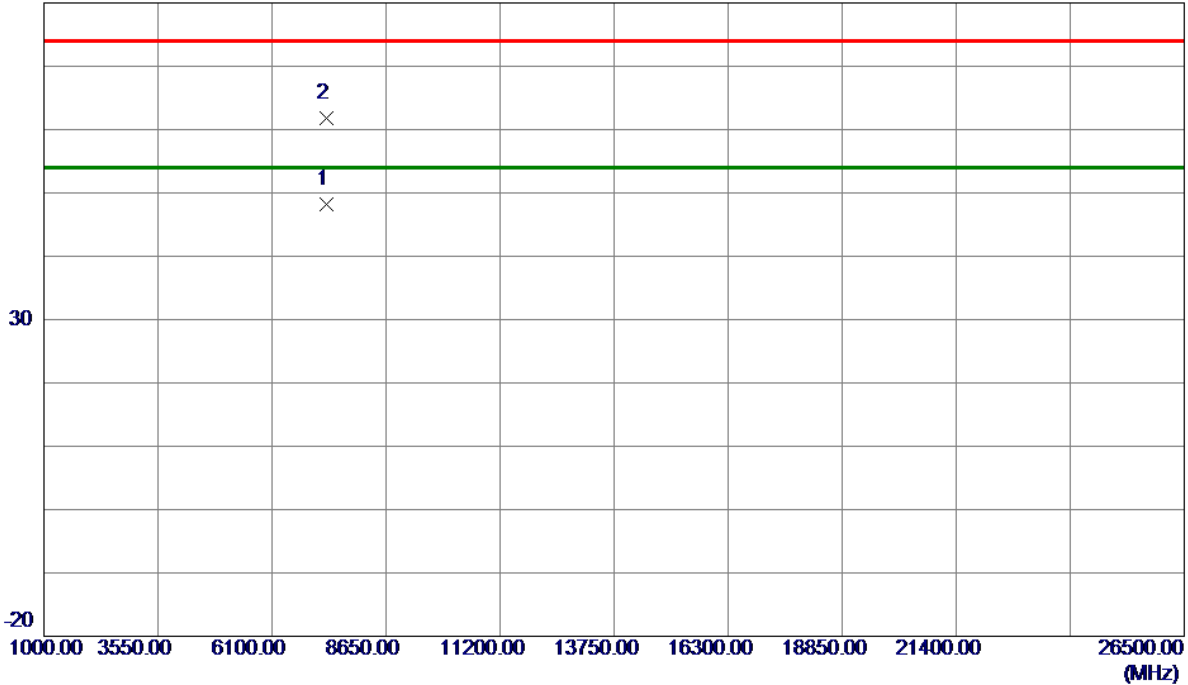

No.	Freq. MHz	Reading Level dBuV/m	Correct Factor dB	Measure ment dBuV/m	Limit dBuV/m	Margin dB	Detector	Comment
1 *	7309.6800	36.36	11.82	48.18	54.00	-5.82	AVG	
2	7311.1800	50.03	11.82	61.85	74.00	-12.15	Peak	

REMARKS:

- (1) Measurement Value = Reading Level + Correct Factor.
- (2) Margin Level = Measurement Value - Limit Value.

Test Mode: TX G Mode 2437 MHz

Horizontal

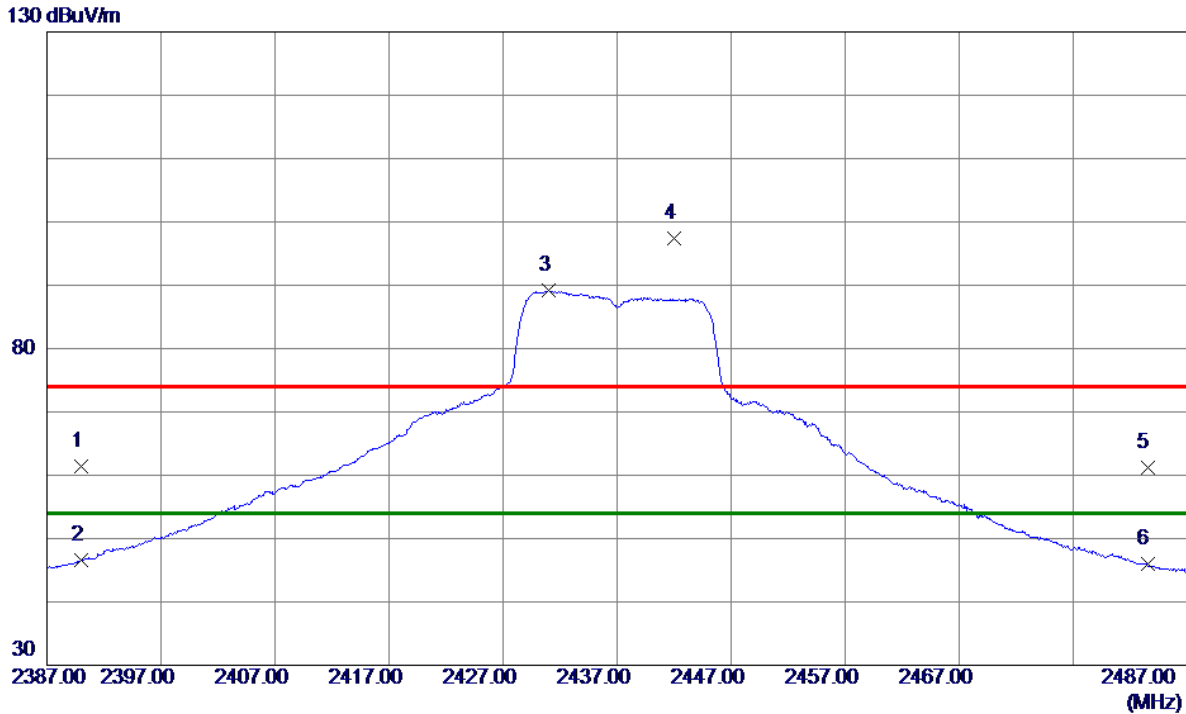

No.	Freq. MHz	Reading Level dBuV/m	Correct Factor dB	Measure ment dBuV/m	Limit dBuV/m	Margin dB	Detector	Comment
1	2390.0000	50.79	10.62	61.41	74.00	-12.59	Peak	
2	2390.0000	36.02	10.62	46.64	54.00	-7.36	AVG	
3 *	2431.0500	78.38	10.74	89.12	54.00	35.12	AVG	No Limit
4	2442.0500	86.57	10.78	97.35	74.00	23.35	Peak	No Limit
5	2483.5000	50.25	10.90	61.15	74.00	-12.85	Peak	
6	2483.5000	35.04	10.90	45.94	54.00	-8.06	AVG	

REMARKS:

- (1) Measurement Value = Reading Level + Correct Factor.
- (2) Margin Level = Measurement Value - Limit Value.

Test Mode: TX G Mode 2437 MHz

Horizontal

80 dBuV/m

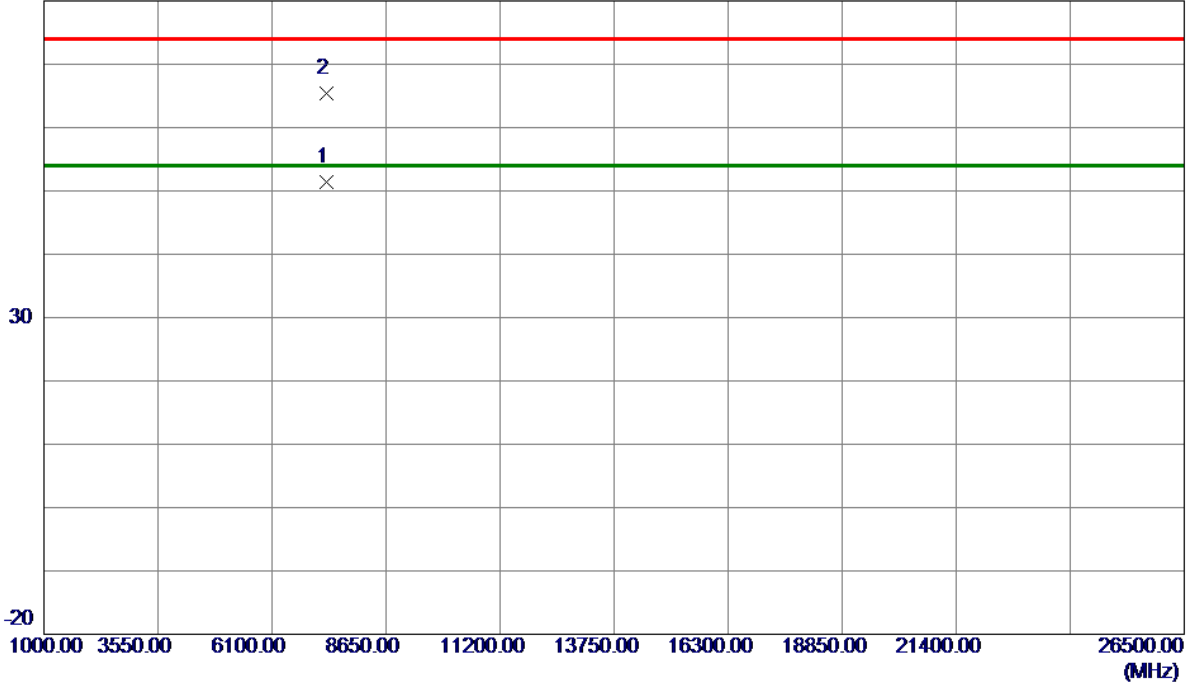

No.	Freq. MHz	Reading Level dBuV/m	Correct Factor dB	Measure ment dBuV/m	Limit dBuV/m	Margin dB	Detector	Comment
1 *	7309.6700	39.54	11.82	51.36	54.00	-2.64	AVG	
2	7311.0800	53.66	11.82	65.48	74.00	-8.52	Peak	

REMARKS:

- (1) Measurement Value = Reading Level + Correct Factor.
- (2) Margin Level = Measurement Value - Limit Value.

Test Mode: TX G Mode 2462 MHz

Vertical

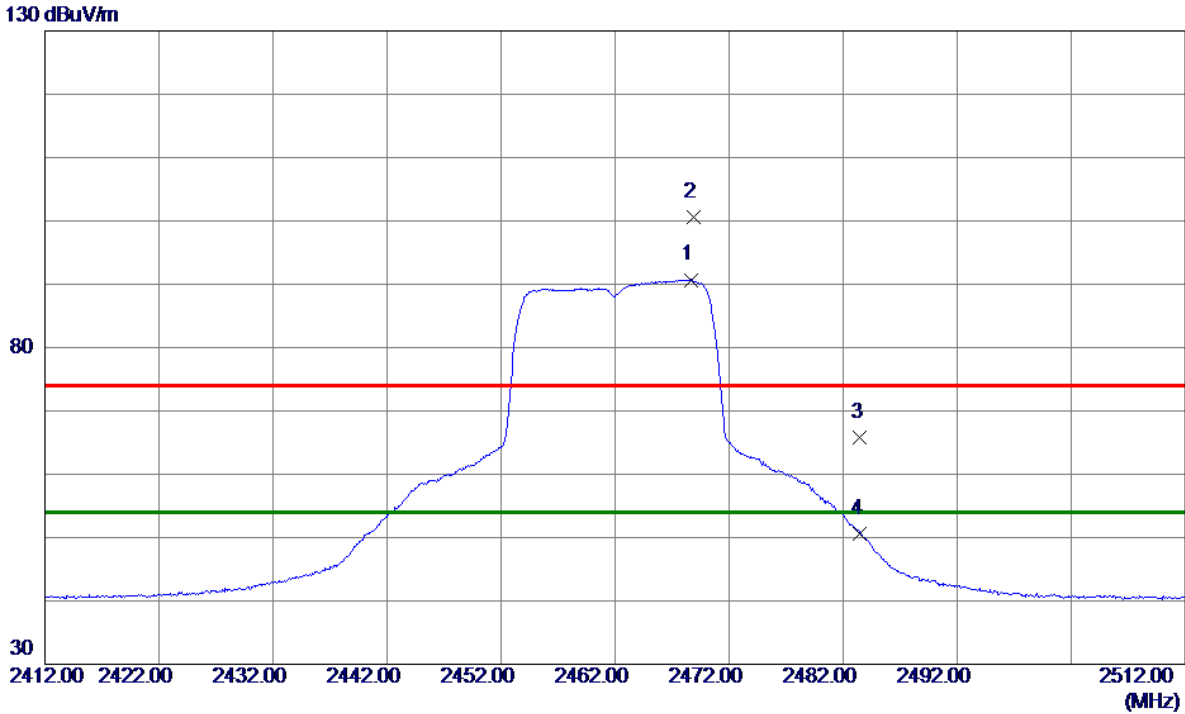

No.	Freq. MHz	Reading Level dBuV/m	Correct Factor dB	Measure ment dBuV/m	Limit dBuV/m	Margin dB	Detector	Comment
1 *	2468.6500	79.84	10.86	90.70	54.00	36.70	AVG	No Limit
2	2468.8500	89.73	10.86	100.59	74.00	26.59	Peak	No Limit
3	2483.5000	54.84	10.90	65.74	74.00	-8.26	Peak	
4	2483.5000	39.72	10.90	50.62	54.00	-3.38	AVG	

REMARKS:

- (1) Measurement Value = Reading Level + Correct Factor.
- (2) Margin Level = Measurement Value - Limit Value.

Test Mode: TX G Mode 2462 MHz

Vertical

80 dBuV/m

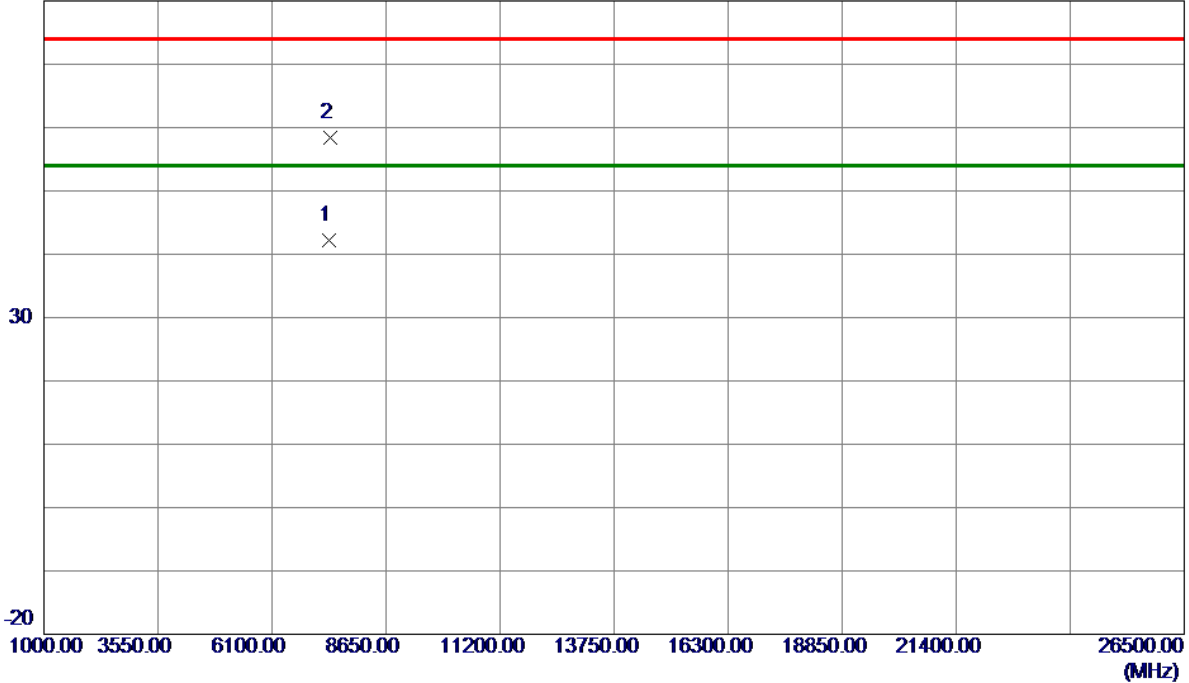

No.	Freq. MHz	Reading Level dBuV/m	Correct Factor dB	Measure ment dBuV/m	Limit dBuV/m	Margin dB	Detector	Comment
1 *	7384.5400	30.35	11.89	42.24	54.00	-11.76	AVG	
2	7393.0800	46.53	11.90	58.43	74.00	-15.57	Peak	

REMARKS:

- (1) Measurement Value = Reading Level + Correct Factor.
- (2) Margin Level = Measurement Value - Limit Value.

Test Mode: TX G Mode 2462 MHz

Horizontal

130 dBuV/m

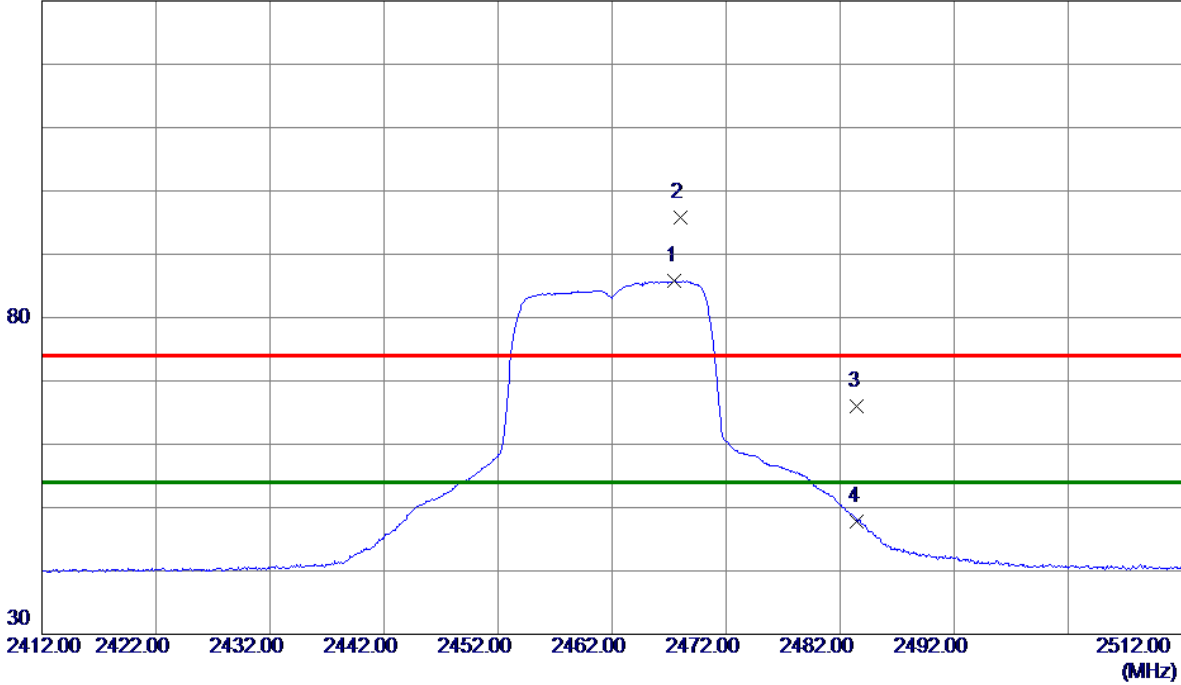

No.	Freq. MHz	Reading Level dBuV/m	Correct Factor dB	Measure ment dBuV/m	Limit dBuV/m	Margin dB	Detector	Comment
1 *	2467.5000	74.87	10.85	85.72	54.00	31.72	AVG	No Limit
2	2467.9500	84.93	10.85	95.78	74.00	21.78	Peak	No Limit
3	2483.5000	55.02	10.90	65.92	74.00	-8.08	Peak	
4	2483.5000	36.98	10.90	47.88	54.00	-6.12	AVG	

REMARKS:

- (1) Measurement Value = Reading Level + Correct Factor.
- (2) Margin Level = Measurement Value - Limit Value.

Test Mode: TX G Mode 2462 MHz

Horizontal

80 dBuV/m

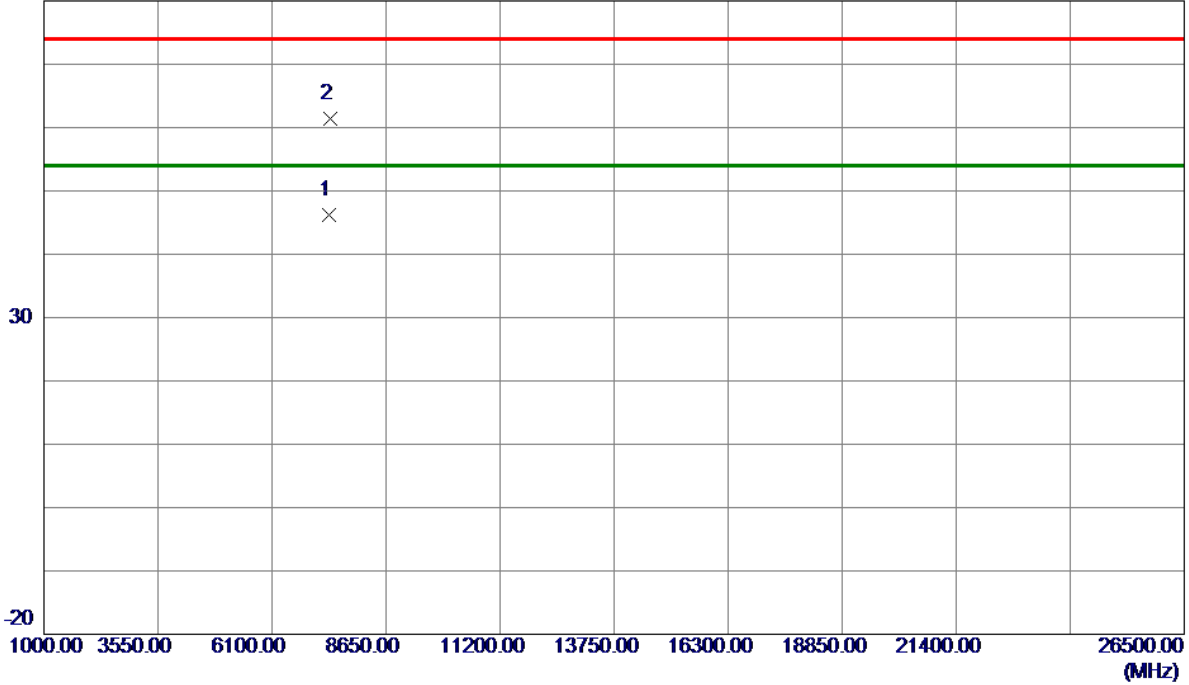

No.	Freq. MHz	Reading Level dBuV/m	Correct Factor dB	Measure ment dBuV/m	Limit dBuV/m	Margin dB	Detector	Comment
1 *	7380.5400	34.35	11.89	46.24	54.00	-7.76	AVG	
2	7390.0800	49.54	11.89	61.43	74.00	-12.57	Peak	

REMARKS:

- (1) Measurement Value = Reading Level + Correct Factor.
- (2) Margin Level = Measurement Value - Limit Value.

Test Mode: TX N-20M Mode 2412 MHz

Vertical

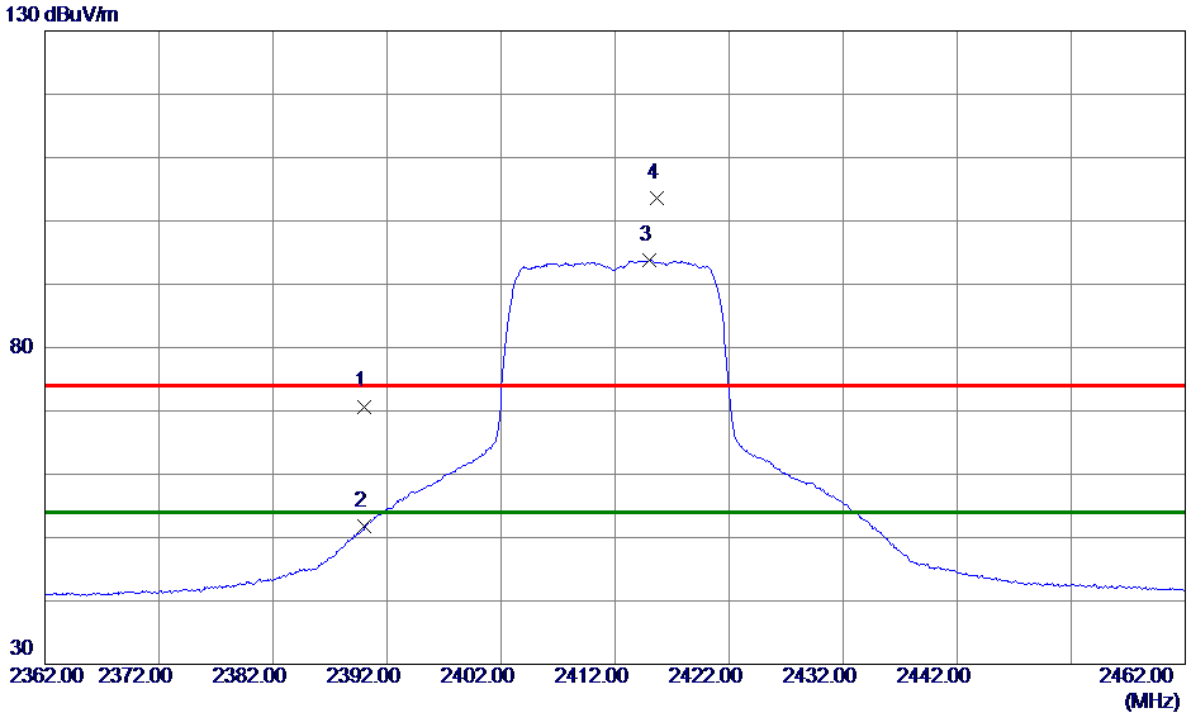

No.	Freq. MHz	Reading Level dBuV/m	Correct Factor dB	Measure ment dBuV/m	Limit dBuV/m	Margin dB	Detector	Comment
1	2390.0000	60.08	10.62	70.70	74.00	-3.30	Peak	
2	2390.0000	41.09	10.62	51.71	54.00	-2.29	AVG	
3 *	2415.0500	83.09	10.70	93.79	54.00	39.79	AVG	No Limit
4	2415.6500	92.96	10.70	103.66	74.00	29.66	Peak	No Limit

REMARKS:

- (1) Measurement Value = Reading Level + Correct Factor.
- (2) Margin Level = Measurement Value - Limit Value.

Test Mode: TX N-20M Mode 2412 MHz

Vertical

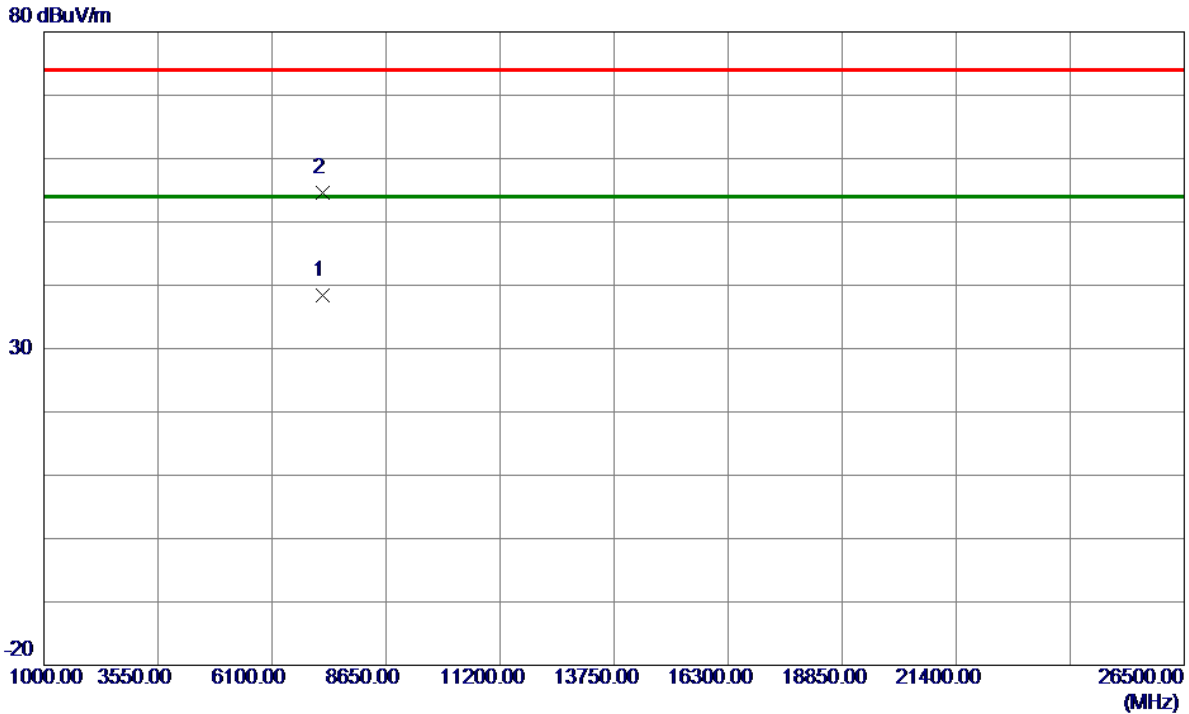

No.	Freq. MHz	Reading Level dBuV/m	Correct Factor dB	Measure ment dBuV/m	Limit dBuV/m	Margin dB	Detector	Comment
1 *	7239.2900	26.67	11.75	38.42	54.00	-15.58	AVG	
2	7245.1100	42.88	11.76	54.64	74.00	-19.36	Peak	

REMARKS:

- (1) Measurement Value = Reading Level + Correct Factor.
- (2) Margin Level = Measurement Value - Limit Value.

Test Mode: TX N-20M Mode 2412 MHz

Horizontal

130 dBuV/m

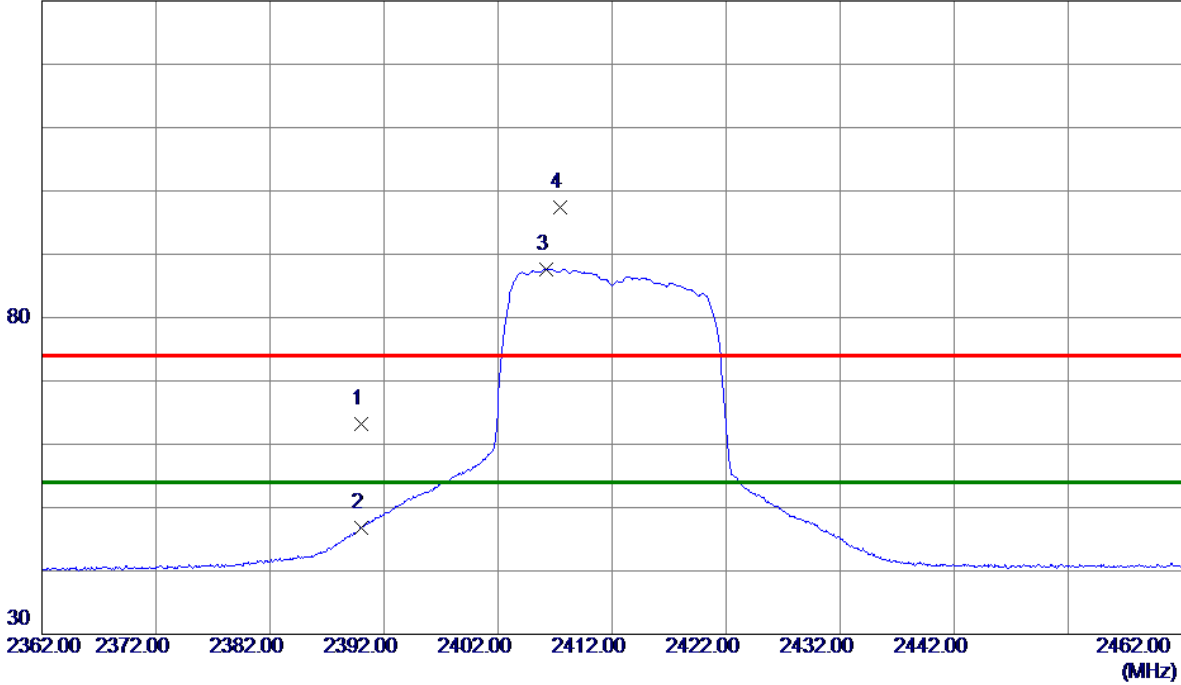

No.	Freq. MHz	Reading Level dBuV/m	Correct Factor dB	Measure ment dBuV/m	Limit dBuV/m	Margin dB	Detector	Comment
1	2390.0000	52.65	10.62	63.27	74.00	-10.73	Peak	
2	2390.0000	36.14	10.62	46.76	54.00	-7.24	AVG	
3 *	2406.2500	76.95	10.67	87.62	54.00	33.62	AVG	No Limit
4	2407.4500	86.82	10.67	97.49	74.00	23.49	Peak	No Limit

REMARKS:

- (1) Measurement Value = Reading Level + Correct Factor.
- (2) Margin Level = Measurement Value - Limit Value.

Test Mode: TX N-20M Mode 2412 MHz

Horizontal

80 dBuV/m

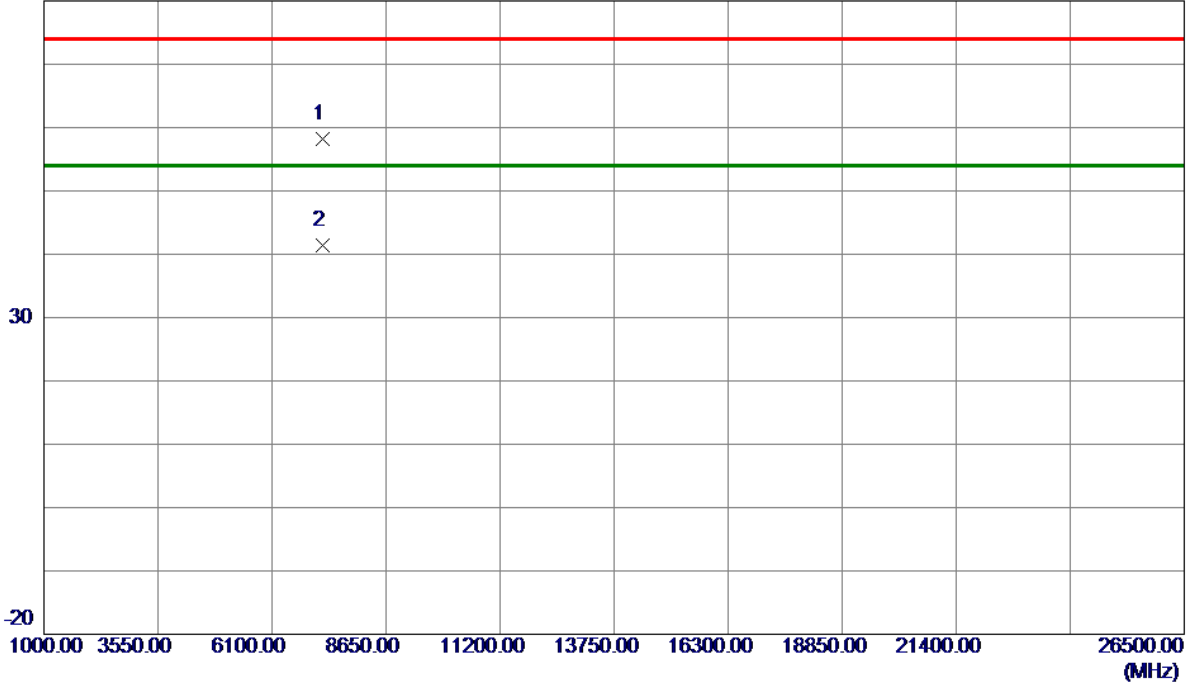

No.	Freq. MHz	Reading Level dBuV/m	Correct Factor dB	Measure ment dBuV/m	Limit dBuV/m	Margin dB	Detector	Comment
1	7236.5400	46.39	11.75	58.14	74.00	-15.86	Peak	
2 *	7240.3500	29.74	11.75	41.49	54.00	-12.51	AVG	

REMARKS:

- (1) Measurement Value = Reading Level + Correct Factor.
- (2) Margin Level = Measurement Value - Limit Value.

Test Mode: TX N-20M Mode 2437 MHz

Vertical

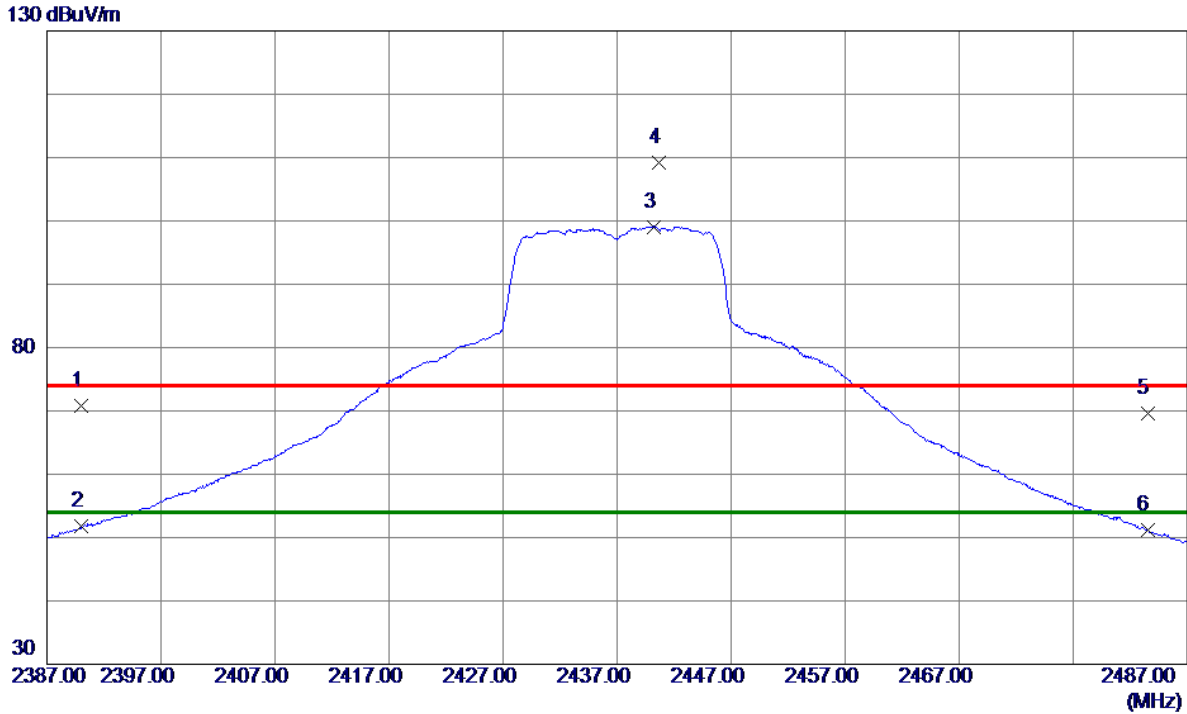

No.	Freq. MHz	Reading Level dBuV/m	Correct Factor dB	Measure ment dBuV/m	Limit dBuV/m	Margin dB	Detector	Comment
1	2390.0000	60.14	10.62	70.76	74.00	-3.24	Peak	
2	2390.0000	41.12	10.62	51.74	54.00	-2.26	AVG	
3 *	2440.2000	88.33	10.77	99.10	54.00	45.10	AVG	No Limit
4	2440.7000	98.40	10.77	109.17	74.00	35.17	Peak	No Limit
5	2483.5000	58.67	10.90	69.57	74.00	-4.43	Peak	
6	2483.5000	40.27	10.90	51.17	54.00	-2.83	AVG	

REMARKS:

- (1) Measurement Value = Reading Level + Correct Factor.
- (2) Margin Level = Measurement Value - Limit Value.

Test Mode: TX N-20M Mode 2437 MHz

Vertical

80 dBuV/m

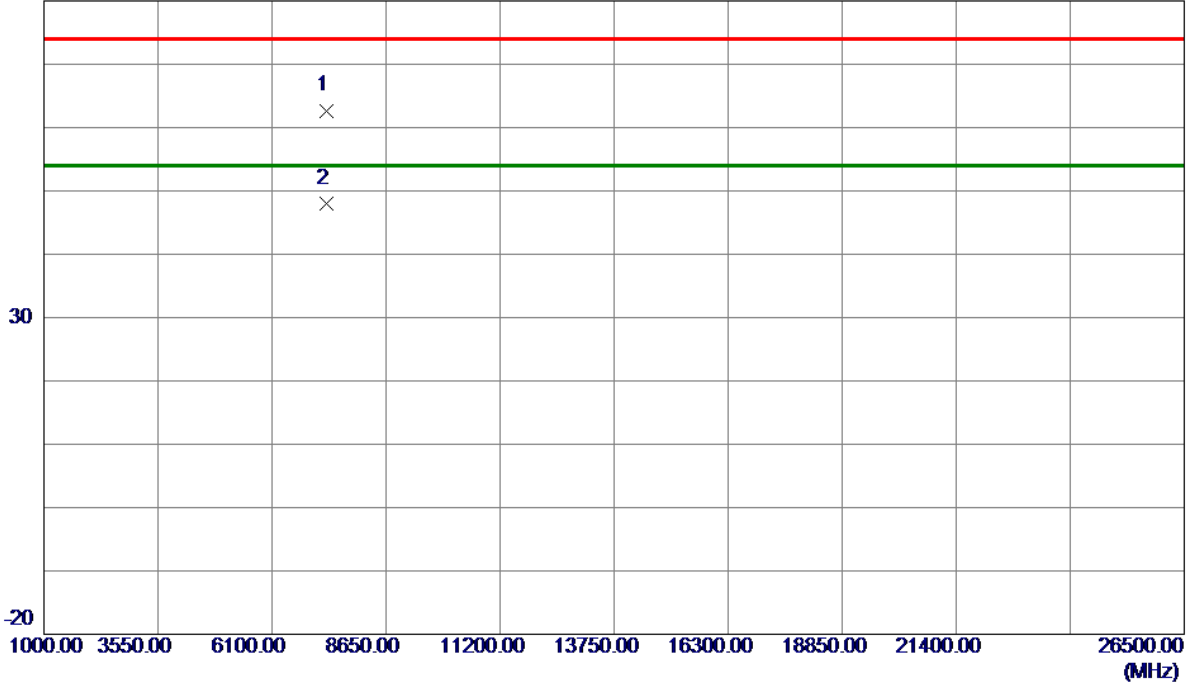

No.	Freq. MHz	Reading Level dBuV/m	Correct Factor dB	Measure ment dBuV/m	Limit dBuV/m	Margin dB	Detector	Comment
1	7305.8200	50.89	11.81	62.70	74.00	-11.30	Peak	
2 *	7309.5600	36.09	11.82	47.91	54.00	-6.09	AVG	

REMARKS:

- (1) Measurement Value = Reading Level + Correct Factor.
- (2) Margin Level = Measurement Value - Limit Value.

Test Mode: TX N-20M Mode 2437 MHz

Horizontal

130 dBuV/m

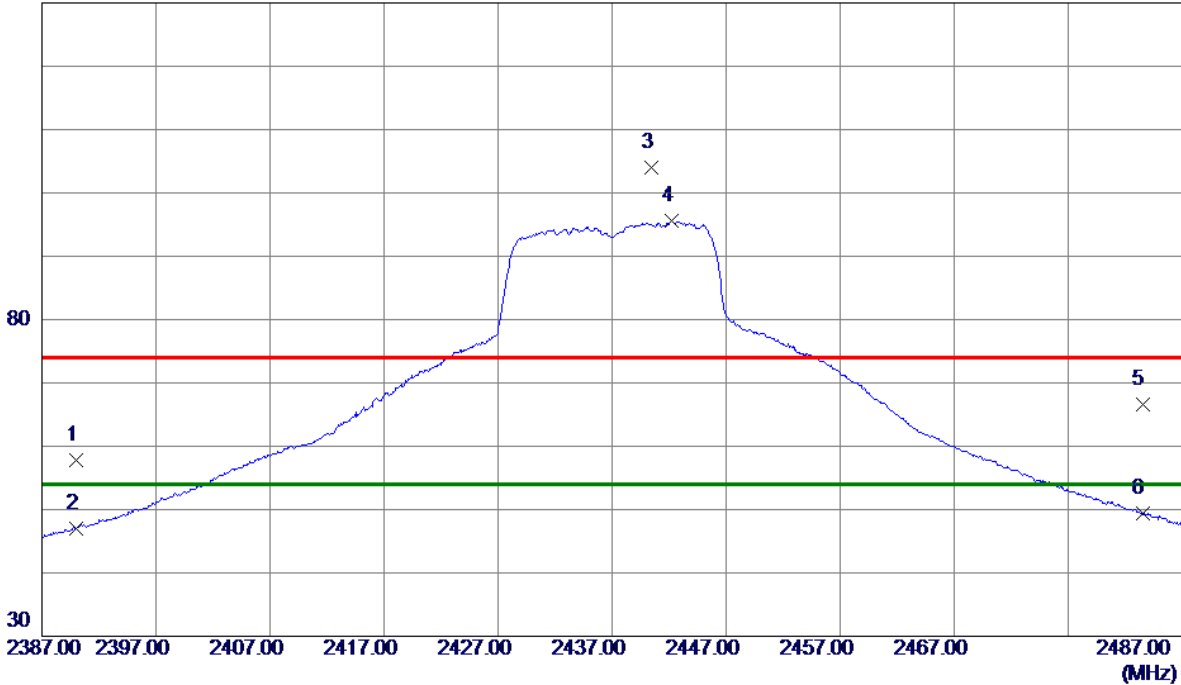

No.	Freq. MHz	Reading Level dBuV/m	Correct Factor dB	Measure ment dBuV/m	Limit dBuV/m	Margin dB	Detector	Comment
1	2390.0000	47.09	10.62	57.71	74.00	-16.29	Peak	
2	2390.0000	36.31	10.62	46.93	54.00	-7.07	AVG	
3	2440.4500	93.26	10.77	104.03	74.00	30.03	Peak	No Limit
4 *	2442.2000	84.77	10.78	95.55	54.00	41.55	AVG	No Limit
5	2483.5000	55.67	10.90	66.57	74.00	-7.43	Peak	
6	2483.5000	38.43	10.90	49.33	54.00	-4.67	AVG	

REMARKS:

- (1) Measurement Value = Reading Level + Correct Factor.
- (2) Margin Level = Measurement Value - Limit Value.

Test Mode: TX N-20M Mode 2437 MHz

Horizontal

80 dBuV/m

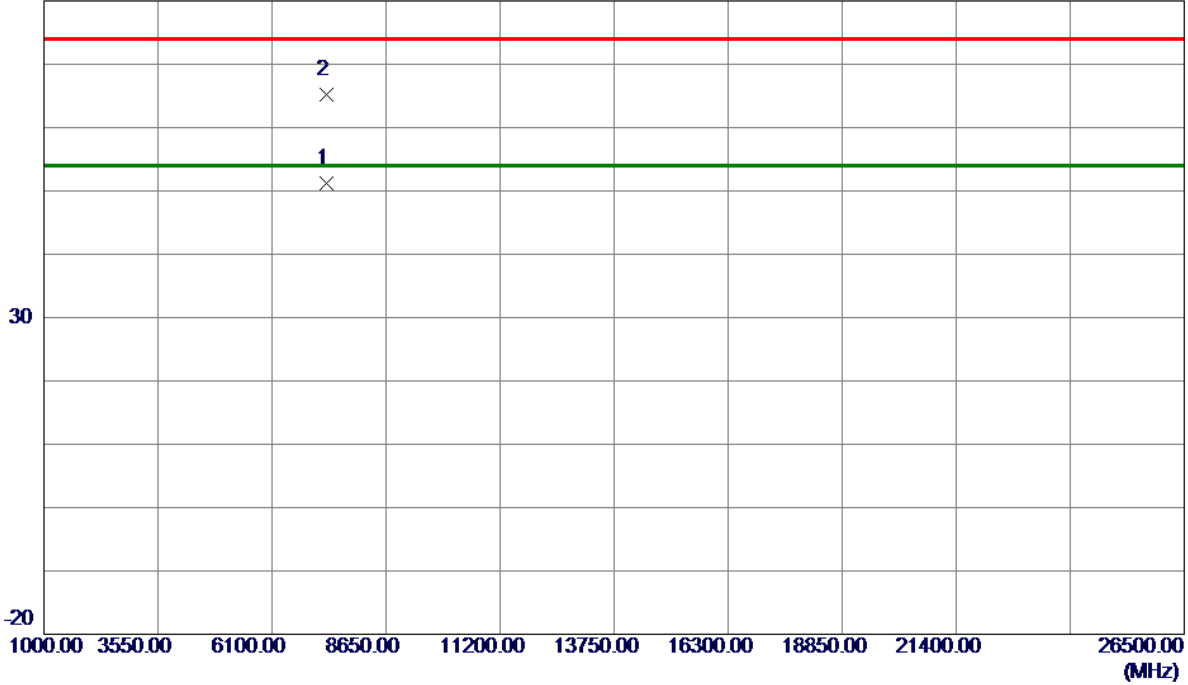

No.	Freq. MHz	Reading Level dBuV/m	Correct Factor dB	Measure ment dBuV/m	Limit dBuV/m	Margin dB	Detector	Comment
1 *	7309.5300	39.31	11.82	51.13	54.00	-2.87	AVG	
2	7310.4300	53.35	11.82	65.17	74.00	-8.83	Peak	

REMARKS:

- (1) Measurement Value = Reading Level + Correct Factor.
- (2) Margin Level = Measurement Value - Limit Value.

Test Mode: TX N-20M Mode 2462 MHz

Vertical

130 dBuV/m

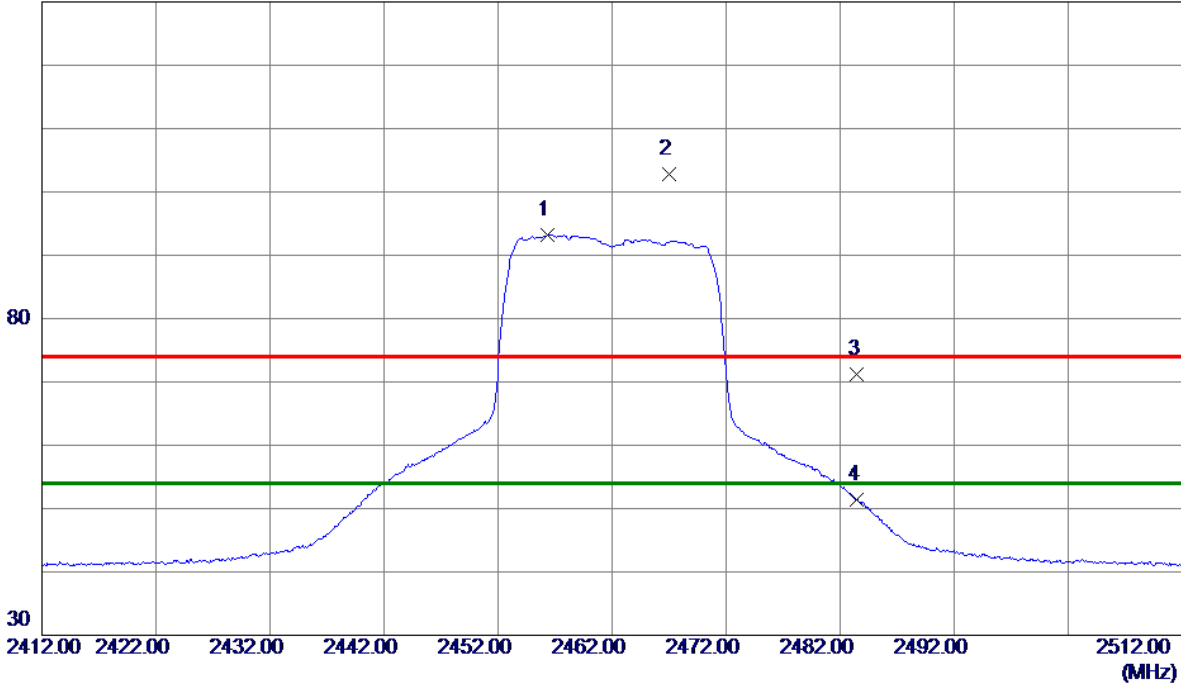

No.	Freq. MHz	Reading Level dBuV/m	Correct Factor dB	Measure ment dBuV/m	Limit dBuV/m	Margin dB	Detector	Comment
1 *	2456.3500	82.38	10.82	93.20	54.00	39.20	AVG	No Limit
2	2467.0500	91.86	10.85	102.71	74.00	28.71	Peak	No Limit
3	2483.5000	60.33	10.90	71.23	74.00	-2.77	Peak	
4	2483.5000	40.54	10.90	51.44	54.00	-2.56	AVG	

REMARKS:

- (1) Measurement Value = Reading Level + Correct Factor.
- (2) Margin Level = Measurement Value - Limit Value.

Test Mode: TX N-20M Mode 2462 MHz

Vertical

80 dBuV/m

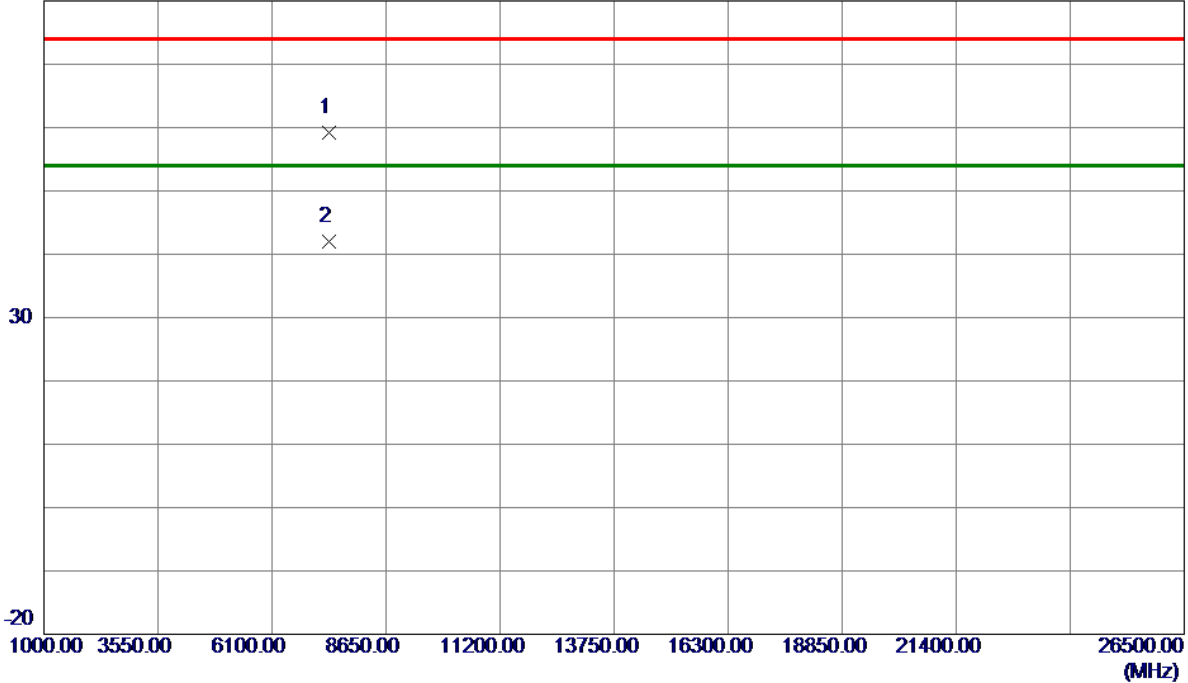

No.	Freq. MHz	Reading Level dBuV/m	Correct Factor dB	Measure ment dBuV/m	Limit dBuV/m	Margin dB	Detector	Comment
1	7385.8700	47.27	11.89	59.16	74.00	-14.84	Peak	
2 *	7388.4400	30.05	11.89	41.94	54.00	-12.06	AVG	

REMARKS:

- (1) Measurement Value = Reading Level + Correct Factor.
- (2) Margin Level = Measurement Value - Limit Value.

Test Mode: TX N-20M Mode 2462 MHz

Horizontal

130 dBuV/m

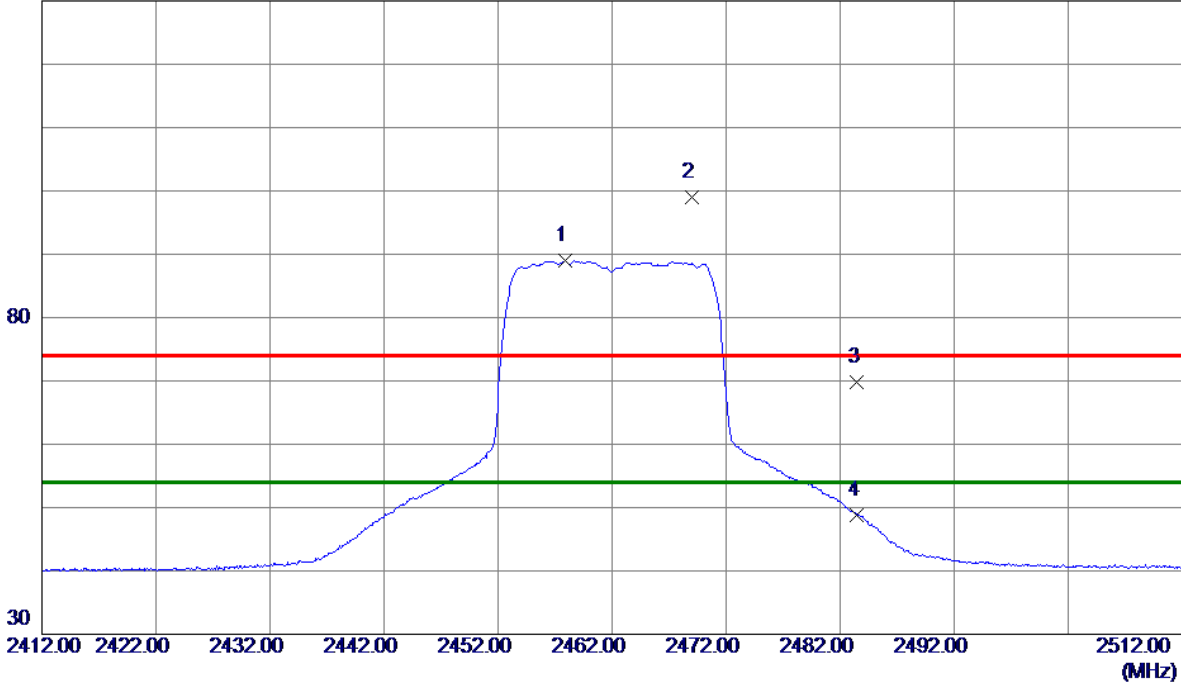

No.	Freq. MHz	Reading Level dBuV/m	Correct Factor dB	Measure ment dBuV/m	Limit dBuV/m	Margin dB	Detector	Comment
1 *	2457.8500	78.10	10.82	88.92	54.00	34.92	AVG	No Limit
2	2468.9500	88.12	10.86	98.98	74.00	24.98	Peak	No Limit
3	2483.5000	58.88	10.90	69.78	74.00	-4.22	Peak	
4	2483.5000	37.97	10.90	48.87	54.00	-5.13	AVG	

REMARKS:

- (1) Measurement Value = Reading Level + Correct Factor.
- (2) Margin Level = Measurement Value - Limit Value.

Test Mode: TX N-20M Mode 2462 MHz

Horizontal

80 dBuV/m

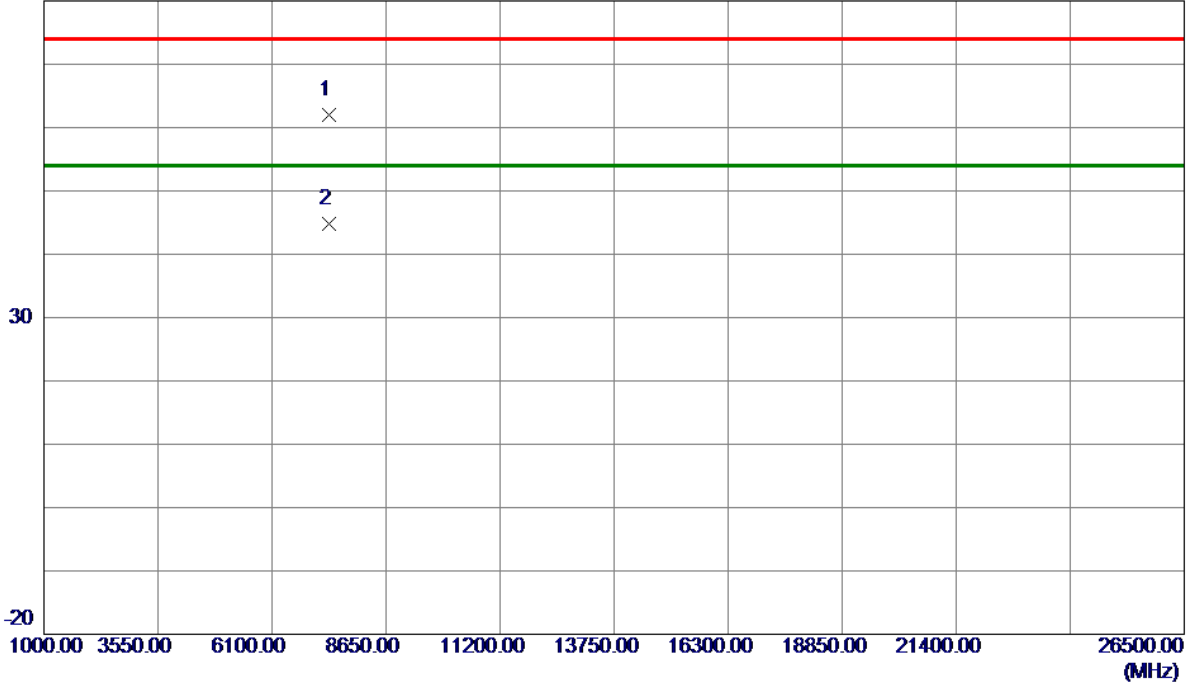

No.	Freq. MHz	Reading Level dBuV/m	Correct Factor dB	Measure ment dBuV/m	Limit dBuV/m	Margin dB	Detector	Comment
1	7386.9000	50.06	11.89	61.95	74.00	-12.05	Peak	
2 *	7388.7500	32.86	11.89	44.75	54.00	-9.25	AVG	

REMARKS:

- (1) Measurement Value = Reading Level + Correct Factor.
- (2) Margin Level = Measurement Value - Limit Value.

APPENDIX E - BANDWIDTH

Test Mode	TX B Mode
-----------	-----------

Channel	Frequency (MHz)	6 dB Bandwidth (MHz)	6 dB Bandwidth Min. Limit (kHz)	Result
01	2412	11.07	500	Complies
06	2437	10.18	500	Complies
11	2462	10.12	500	Complies

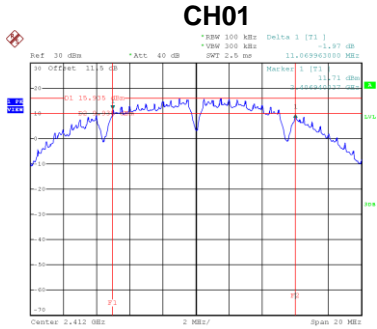

Date: 21.SEP.2020 16:13:120

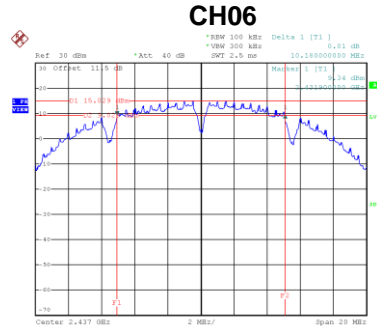

Date: 21.SEP.2020 16:15:138

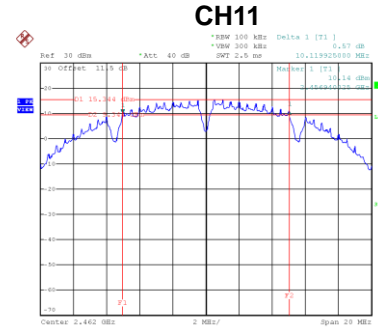

Date: 21.SEP.2020 16:15:112

Channel	Frequency (MHz)	99 % Emission Bandwidth (MHz)	Result
01	2412	17.28	Complies
06	2437	16.64	Complies
11	2462	16.72	Complies

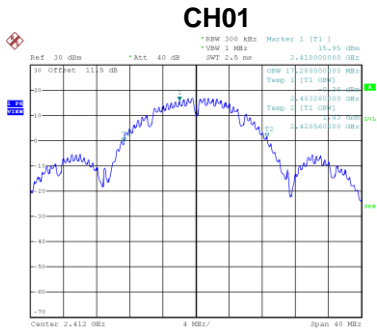

Date: 21.SEP.2020 16:13:128

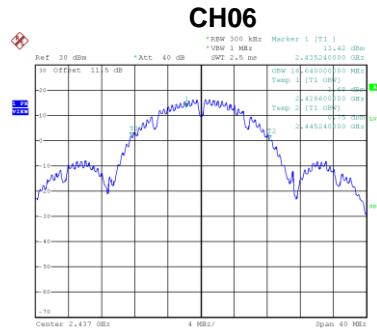

Date: 21.SEP.2020 16:15:145

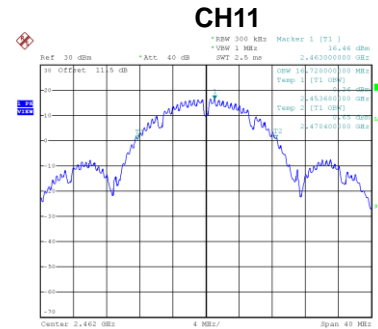

Date: 21.SEP.2020 16:15:119

Test Mode	TX G Mode
-----------	-----------

Channel	Frequency (MHz)	6 dB Bandwidth (MHz)	6 dB Bandwidth Min. Limit (kHz)	Result
01	2412	16.38	500	Complies
06	2437	16.38	500	Complies
11	2462	16.42	500	Complies

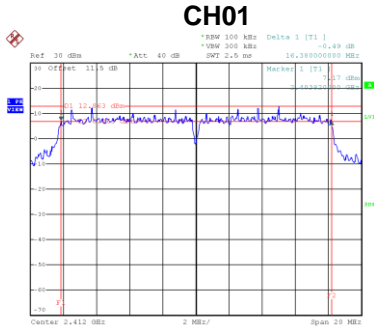

Date: 21.SEP.2020 16:54:35

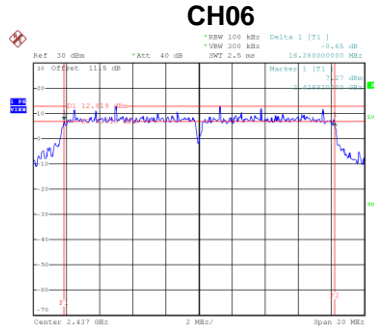

Date: 21.SEP.2020 16:55:57

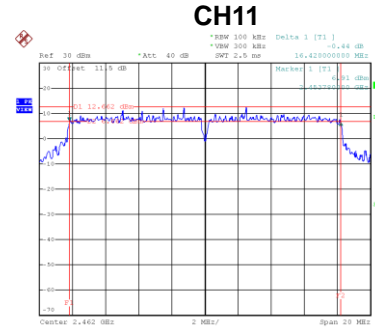

Date: 21.SEP.2020 16:57:16

Channel	Frequency (MHz)	99 % Emission Bandwidth (MHz)	Result
01	2412	21.60	Complies
06	2437	22.40	Complies
11	2462	22.88	Complies

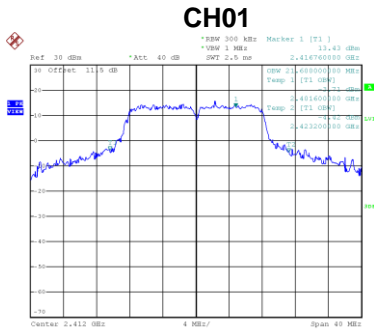

Date: 21.SEP.2020 16:54:43

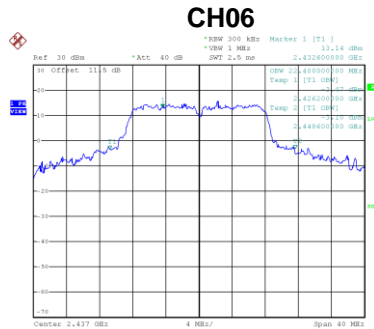

Date: 21.SEP.2020 16:56:04

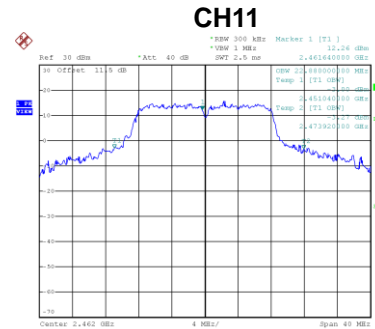

Date: 21.SEP.2020 16:57:23

Test Mode	TX N-20M Mode
-----------	---------------

Channel	Frequency (MHz)	6 dB Bandwidth (MHz)	6 dB Bandwidth Min. Limit (kHz)	Result
01	2412	17.12	500	Complies
06	2437	17.40	500	Complies
11	2462	17.36	500	Complies

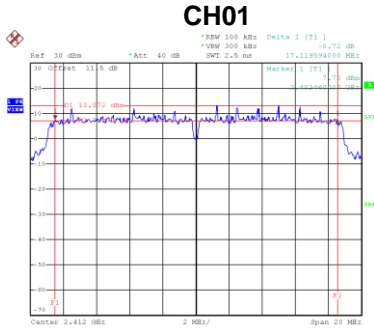

Date: 21.SEP.2020 16:58:149

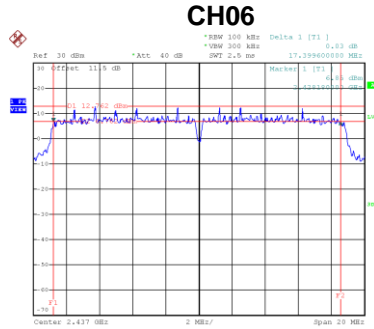

Date: 21.SEP.2020 17:00:125

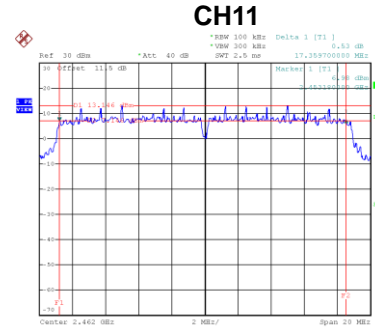

Date: 21.SEP.2020 17:01:149

Channel	Frequency (MHz)	99 % Emission Bandwidth (MHz)	Result
01	2412	24.16	Complies
06	2437	24.24	Complies
11	2462	24.80	Complies

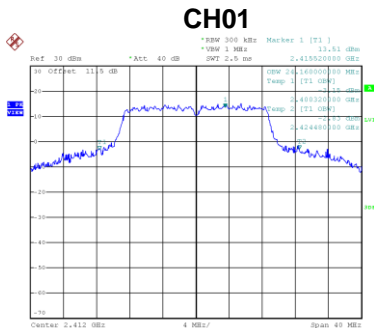

Date: 21.SEP.2020 16:58:156

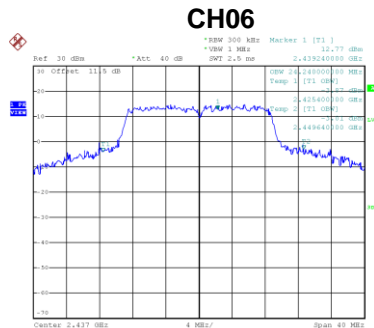

Date: 21.SEP.2020 17:00:132

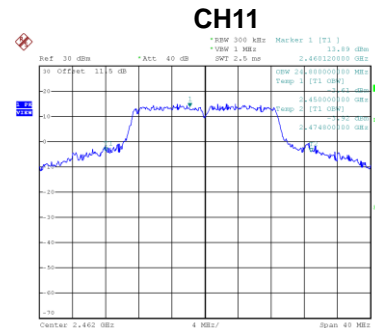

Date: 21.SEP.2020 17:01:157

APPENDIX F - MAXIMUM OUTPUT POWER

Test Mode TX B Mode

Channel	Frequency (MHz)	Peak Output Power (dBm)	Max. Limit (dBm)	Result
01	2412	18.63	30.00	Complies
06	2437	16.97	30.00	Complies
11	2462	15.66	30.00	Complies

Test Mode TX G Mode

Channel	Frequency (MHz)	Peak Output Power (dBm)	Max. Limit (dBm)	Result
01	2412	19.26	30.00	Complies
06	2437	21.03	30.00	Complies
11	2462	18.15	30.00	Complies

Test Mode TX N-20M Mode

Channel	Frequency (MHz)	Peak Output Power (dBm)	Max. Limit (dBm)	Result
01	2412	18.29	30.00	Complies
06	2437	21.69	30.00	Complies
11	2462	17.33	30.00	Complies

APPENDIX G - CONDUCTED SPURIOUS EMISSIONS

Test Mode TX B Mode

Bandedge-CH01

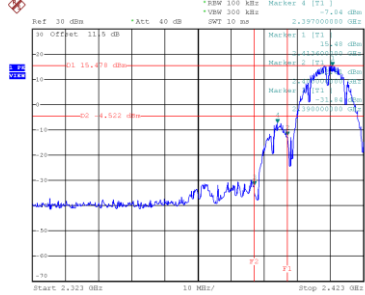

Date: 21.SEP.2020 16:39:36

Bandedge-CH11

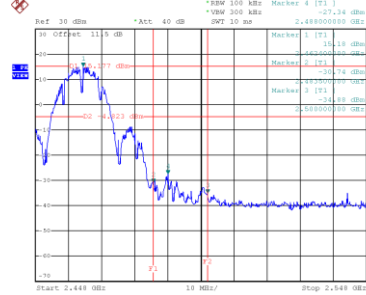

Date: 21.SEP.2020 16:53:27

CH01 – 10th Harmonic of the fundamental frequency

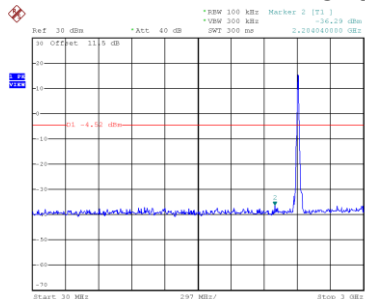

Date: 21.SEP.2020 16:39:49

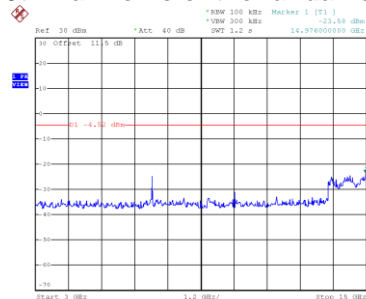

Date: 21.SEP.2020 17:08:44

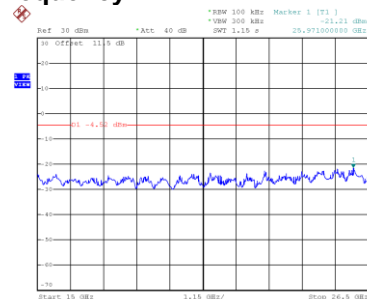

Date: 21.SEP.2020 16:40:04

CH06 – 10th Harmonic of the fundamental frequency

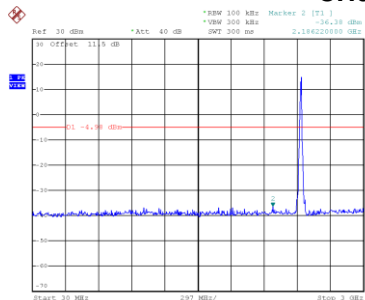

Date: 21.SEP.2020 16:52:07

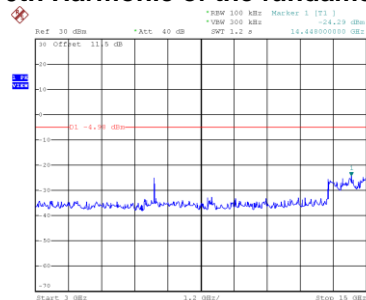

Date: 21.SEP.2020 16:52:14

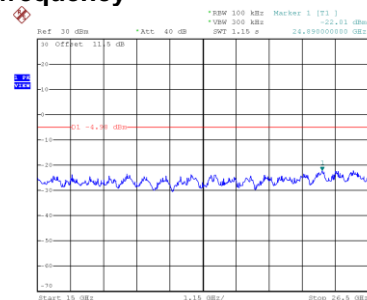

Date: 21.SEP.2020 16:52:21

CH11 – 10th Harmonic of the fundamental frequency

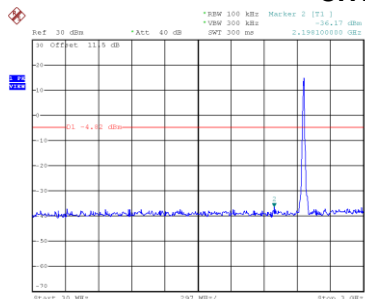

Date: 21.SEP.2020 16:53:40

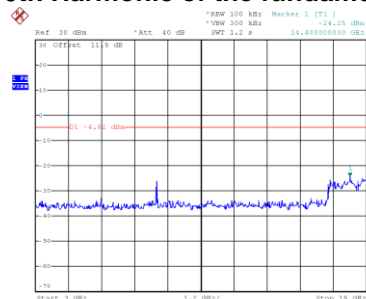

Date: 21.SEP.2020 16:53:48

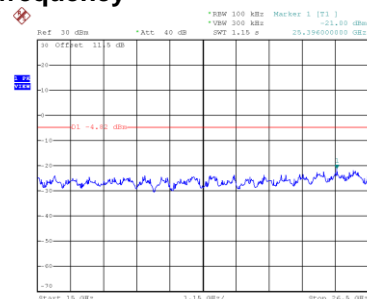

Date: 21.SEP.2020 16:53:55

Test Mode TX G Mode

Bandedge-CH01

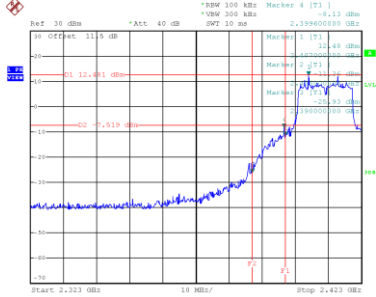

Date: 21.SEP.2020 16:15:10

Bandedge-CH11

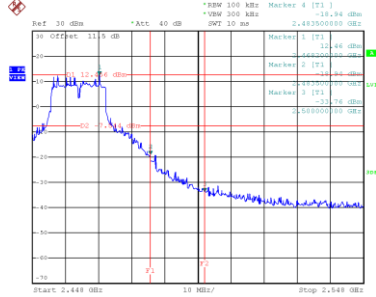

Date: 21.SEP.2020 16:15:11

CH01 – 10th Harmonic of the fundamental frequency

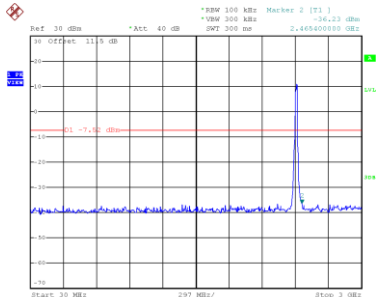

Date: 21.SEP.2020 16:15:103

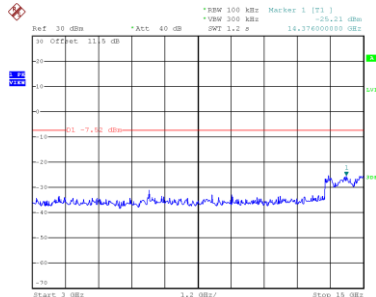

Date: 21.SEP.2020 16:15:111

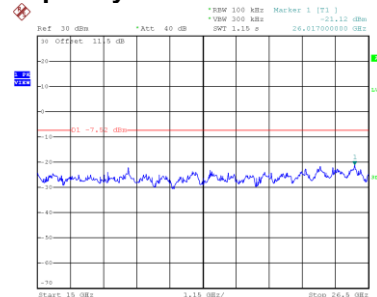

Date: 21.SEP.2020 16:15:119

CH06 – 10th Harmonic of the fundamental frequency

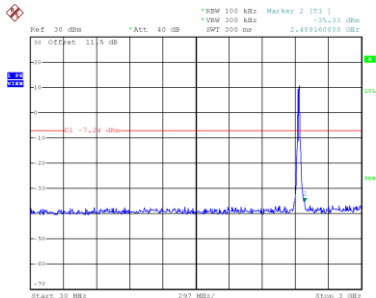

Date: 21.SEP.2020 16:15:125

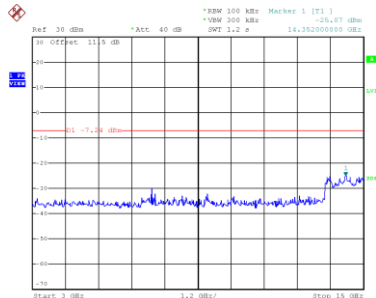

Date: 21.SEP.2020 16:15:133

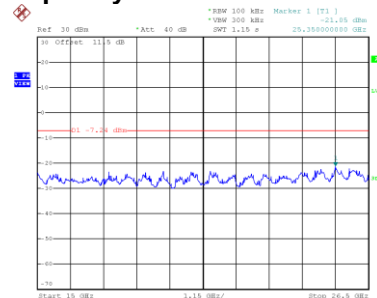

Date: 21.SEP.2020 16:15:140

CH11 – 10th Harmonic of the fundamental frequency

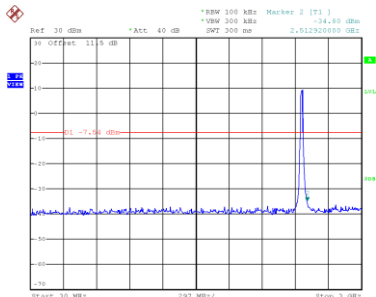

Date: 21.SEP.2020 16:15:144

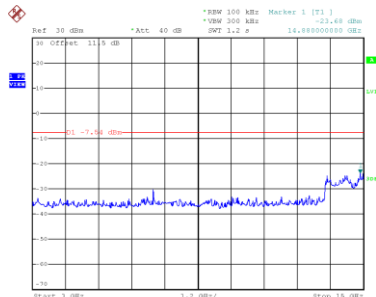

Date: 21.SEP.2020 16:15:152

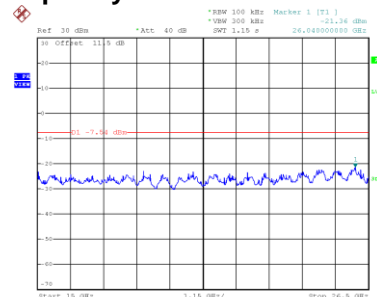

Date: 21.SEP.2020 16:15:159

Test Mode TX N-20M Mode

Bandedge-CH01

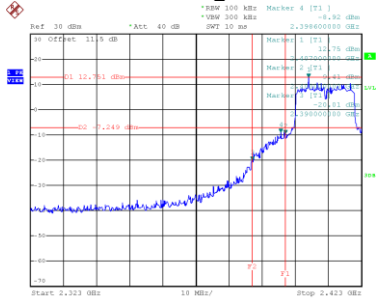

Date: 21.SEP.2020 16:59:04

Bandedge-CH11

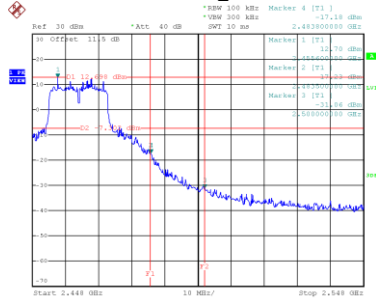

Date: 21.SEP.2020 17:02:04

CH01 – 10th Harmonic of the fundamental frequency

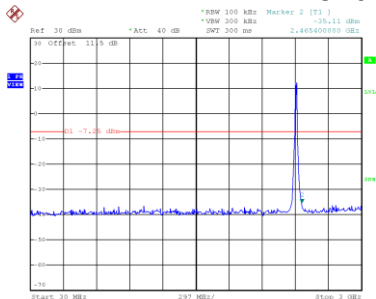

Date: 21.SEP.2020 16:59:18

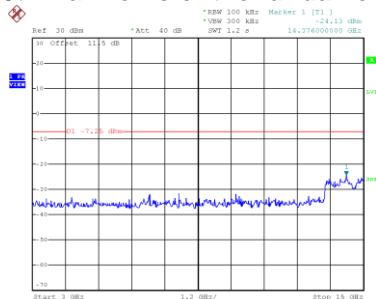

Date: 21.SEP.2020 16:59:26

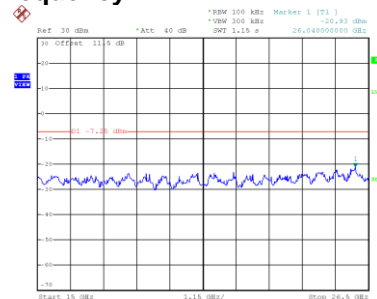

Date: 21.SEP.2020 16:59:34

CH06 – 10th Harmonic of the fundamental frequency

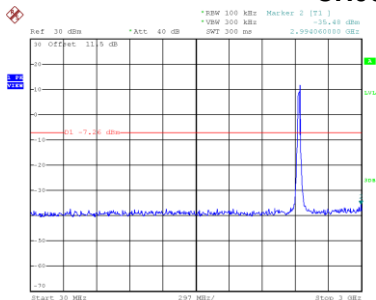

Date: 21.SEP.2020 17:00:53

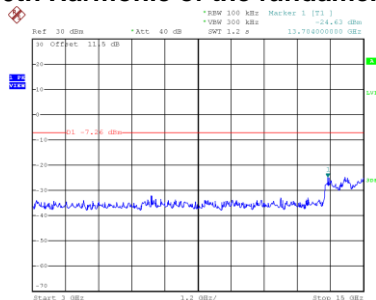

Date: 21.SEP.2020 17:01:00

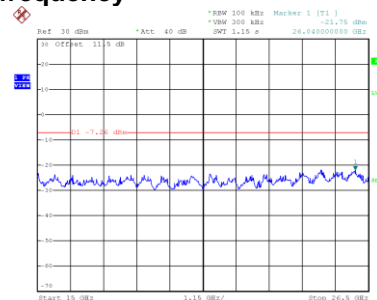

Date: 21.SEP.2020 17:01:08

CH11 – 10th Harmonic of the fundamental frequency

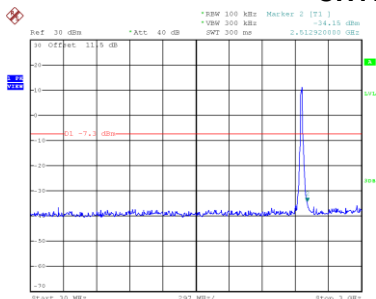

Date: 21.SEP.2020 17:02:18

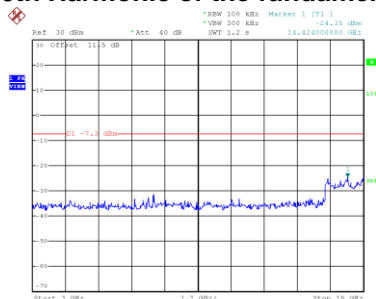

Date: 21.SEP.2020 17:02:25

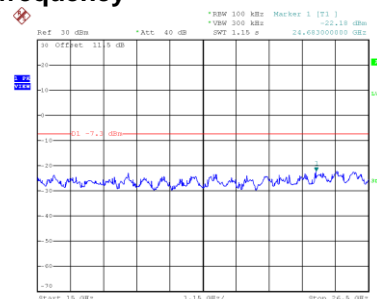

Date: 21.SEP.2020 17:02:33

APPENDIX H - POWER SPECTRAL DENSITY

Test Mode	TX B Mode
-----------	-----------

Channel	Frequency (MHz)	Power Spectral Density (dBm/3kHz)	Max. Limit (dBm/3kHz)	Result
01	2412	-1.62	8	Complies
06	2437	-1.59	8	Complies
11	2462	-0.21	8	Complies

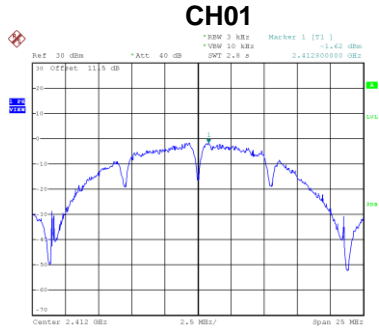

Date: 21.SEP.2020 17:04:23

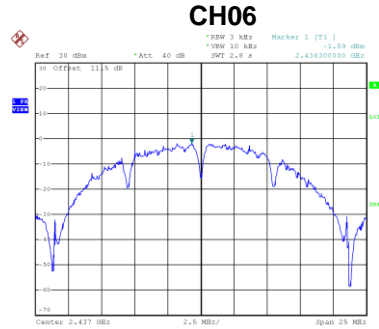

Date: 21.SEP.2020 17:05:01

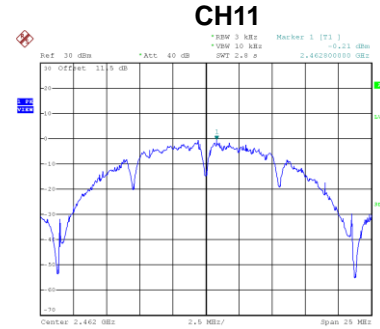

Date: 21.SEP.2020 17:07:00

Test Mode	TX G Mode
-----------	-----------

Channel	Frequency (MHz)	Power Spectral Density (dBm/3kHz)	Max. Limit (dBm/3kHz)	Result
01	2412	-3.66	8	Complies
06	2437	-4.66	8	Complies
11	2462	-4.92	8	Complies

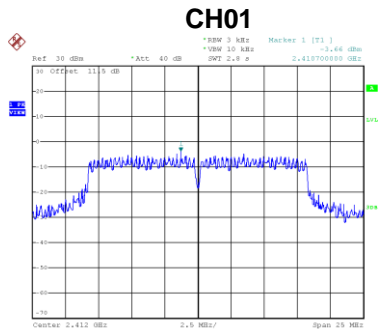

Date: 21.SEP.2020 16:55:28

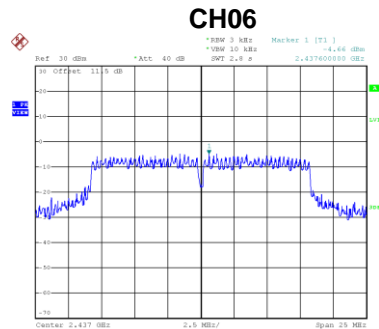

Date: 21.SEP.2020 16:56:49

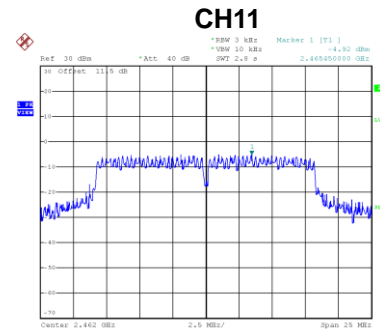

Date: 21.SEP.2020 16:58:08

Test Mode	TX N-20M Mode
-----------	---------------

Channel	Frequency (MHz)	Power Spectral Density (dBm/3kHz)	Max. Limit (dBm/3kHz)	Result
01	2412	-3.80	8	Complies
06	2437	-4.07	8	Complies
11	2462	-4.02	8	Complies

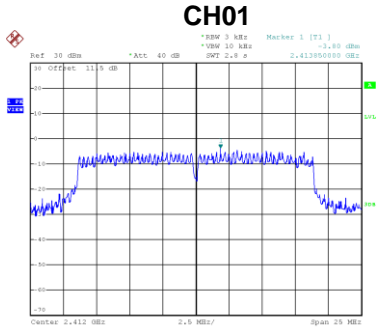

Date: 21.SEP.2020 16:59:43

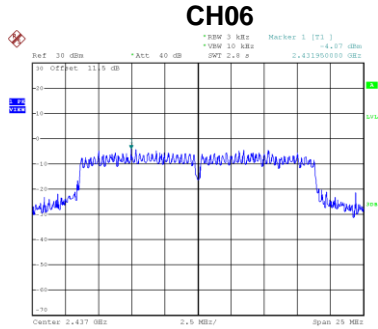

Date: 21.SEP.2020 17:01:17

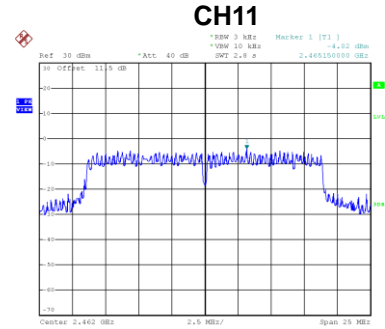

Date: 21.SEP.2020 17:02:42

End of Test Report