

TEST REPORT

Applicant: SHENZHEN TENDA TECHNOLOGY CO.,LTD.

Address: 6-8 Floor, Tower E3, No. 1001, Zhongshanyuan Road, Nanshan District, Shenzhen, China. 518052

Product Name: Dual-Band Gigabit Wi-Fi 6 Router

FCC ID: V7TRX2LP

Standard(s): 47 CFR Part 15, Subpart E(15.407)
ANSI C63.10-2013
KDB 789033 D02 General U-NII Test Procedures New Rules v02r01

Report Number: DG2231229-79269E-RF-00C

Report Date: 2024/3/6

The above device has been tested and found compliant with the requirement of the relative standards by Bay Area Compliance Laboratories Corp. (Dongguan).

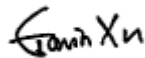

Reviewed By: Gavin Xu
Title: RF Engineer



Approved By: Ivan Cao
Title: EMC Manager

Bay Area Compliance Laboratories Corp. (Dongguan)
No.12, Pulong East 1st Road, Tangxia Town, Dongguan, Guangdong, China

Tel: +86-769-86858888

Fax: +86-769-86858891

www.baclcorp.com.cn

Note: The information marked ▲ is provided by the applicant, the laboratory is not responsible for its authenticity and this information can affect the validity of the result in the test report. Unless otherwise stated the results shown in this test report refer only to the sample(s) tested. This report cannot be reproduced except in full, without prior written approval of the Company. This report is valid only with a valid digital signature. The digital signature may be available only under the Adobe software above version 7.0. This report may contain data that are not covered by the accreditation scope and shall be marked with ★. This report must not be used by the client to claim product certification, approval, or endorsement by NVLAP, NIST, or any agency of the U.S. Government.

CONTENTS

DOCUMENT REVISION HISTORY	4
1. GENERAL INFORMATION	5
1.1 PRODUCT DESCRIPTION FOR EQUIPMENT UNDER TEST (EUT)	5
1.2 ACCESSORY INFORMATION	5
1.3 ANTENNA INFORMATION DETAIL▲	6
1.4 EQUIPMENT MODIFICATIONS	6
2. DESCRIPTION OF TEST CONFIGURATION	7
2.1 OPERATION FREQUENCY DETAIL	7
2.2 EUT OPERATION CONDITION	8
2.3 EUT EXERCISE SOFTWARE	8
2.4 SUPPORT EQUIPMENT LIST AND DETAILS	9
2.5 SUPPORT CABLE LIST AND DETAILS	9
2.6 BLOCK DIAGRAM OF TEST SETUP	10
2.7 TEST FACILITY	11
2.8 MEASUREMENT UNCERTAINTY	11
3. SUMMARY OF TEST RESULTS	12
4. REQUIREMENTS AND TEST PROCEDURES	13
4.1 AC LINE CONDUCTED EMISSIONS	13
4.1.1 Applicable Standard	13
4.1.2 EUT Setup	14
4.1.3 EMI Test Receiver Setup	14
4.1.4 Test Procedure	15
4.1.5 Corrected Amplitude & Margin Calculation	15
4.1.6 Test Result	15
4.2 RADIATION SPURIOUS EMISSIONS	16
4.2.1 Applicable Standard	16
4.2.2 EUT Setup	17
4.2.3 EMI Test Receiver & Spectrum Analyzer Setup	18
4.2.4 Test Procedure	19
4.2.5 Corrected Result & Margin Calculation	19
4.2.6 Test Result	19
4.3 EMISSION BANDWIDTH	20
4.3.1 Applicable Standard	20
4.3.2 EUT Setup	20
4.3.3 Test Procedure	20
4.3.4 Test Result	21
4.4 MAXIMUM CONDUCTED OUTPUT POWER	22
4.4.1 Applicable Standard	22
4.4.2 EUT Setup	22
4.4.3 Test Procedure	22
4.4.3 Test Result	22

4.5 MAXIMUM POWER SPECTRAL DENSITY 23

 4.5.1 Applicable Standard 23

 4.5.2 EUT Setup 23

 4.5.3 Test Procedure 24

 4.5.4 Test Result 24

4.6 DUTY CYCLE 25

 4.6.1 EUT Setup 25

 4.6.2 Test Procedure 25

 4.6.3 Judgment 25

4.7 ANTENNA REQUIREMENT 26

 4.7.1 Applicable Standard 26

 4.7.2 Judgment 26

5. Test DATA AND RESULTS 27

5.1 AC LINE CONDUCTED EMISSIONS 27

5.2 RADIATION SPURIOUS EMISSIONS 30

5.3 EMISSION BANDWIDTH 117

5.4 99% OCCUPIED BANDWIDTH 127

5.5 MAXIMUM CONDUCTED OUTPUT POWER 138

5.6 MAXIMUM POWER SPECTRAL DENSITY 143

5.7 DUTY CYCLE 162

APPENDIX A - EUT PHOTOGRAPHS 165

APPENDIX B - TEST SETUP PHOTOGRAPHS 166

APPENDIX C - RF EXPOSURE EVALUATION 167

APPLICABLE STANDARD 167

CALCULATION FORMULA: 167

CALCULATED DATA: 168

DOCUMENT REVISION HISTORY

Revision Number	Report Number	Description of Revision	Date of Revision
1.0	DG2231229-79269E-RF-00C	Original Report	2024/3/6

1. GENERAL INFORMATION

1.1 Product Description for Equipment under Test (EUT)

EUT Name:	Dual-Band Gigabit Wi-Fi 6 Router
EUT Model:	RX2L Pro
Multiple Models:	TX2L Pro
Operation Frequency:	5180-5240 MHz (802.11a/n ht20/ac vht20/ax he20) 5190-5230 MHz(802.11n ht40/ac vht40/ax he40) 5210 MHz(802.11ac vht80/ax he80) 5745-5825 MHz (802.11a/n ht20/ac vht20/ax he20) 5755-5795 MHz(802.11n ht40/ac vht40/ax he40) 5775 MHz(802.11ac vht80/ax he80)
Maximum Average Output Power (Conducted):	16.96 dBm in 5150-5250 MHz Band 15.84dBm in 5725-5850 MHz Band
Modulation Type:	802.11a/n/ac:OFDM-BPSK, QPSK, 16QAM, 64QAM,256QAM 802.11ax: OFDMA- BPSK, QPSK, 16QAM, 64QAM,256QAM, 1024QAM
Rated Input Voltage:	DC 12V from adapter
Serial Number:	2FY2-1(Radiated spurious emission and AC line conducted emission) 2FY2-5(RF conducted test)
EUT Received Date:	2023/12/30
EUT Received Status:	Good
<p>Note: The Multiple models are electrically identical with the test model. Please refer to the declaration letter for more detail, which was provided by manufacturer.</p>	

1.2 Accessory Information

Accessory Description	Manufacturer	Model	Parameters
Adapter	SHENZHEN HEWEISHUN NETWORK TECHNOLOGY CO.,LTD.	BN073-A12012U	Input: 100-240Vac ~50-60Hz 0.4A Output: DC12V 1A

1.3 Antenna Information Detail ▲

Antenna	Manufacturer	Antenna Type	input impedance (Ohm)	Frequency Range	Antenna Gain
5G Chain 0 & Chain 1	SHENZHEN TENDA TECHNOLOGY CO.,LTD.	PCB	50	5.15~5.25GHz	6.32 dBi
				5.725-5.85GHz	6.41 dBi

Note:

The system supports 2T2R Beamforming and Non-beamforming(CDD) modes at 802.11n/ac/ax modes.
Per KDB 662911 D01 Multiple Transmitter Output v02r01:

For power measurements:

CDD Mode:

Array Gain = 0 dB (i.e., no array gain) for $N_{ANT} \leq 4$
directional gain=6.32 dBi for 5150-5250MHz
directional gain=6.41 dBi for 5725-5850MHz

Beamforming Mode:

Array Gain = $10 \log(N_{ANT}/N_{SS})$ dB.
directional gain=6.32dBi+3dB=9.32dBi for 5150-5250MHz
directional gain=6.41dBi+3dB=9.41dBi for 5725-5850MHz

For power spectral density (PSD) measurements:

Array Gain = $10 \log(N_{ANT}/N_{SS})$ dB.
directional gain=6.32dBi+3dB=9.32dBi for 5150-5250MHz
directional gain=6.41dBi+3dB=9.41dBi for 5725-5850MHz

The design of compliance with §15.203:

- Unit uses a permanently attached antenna.
- Unit uses a unique coupling to the intentional radiator.
- Unit was professionally installed, and installer shall be responsible for verifying that the correct antenna is employed with the unit.

1.4 Equipment Modifications

No modifications are made to the EUT during all test items.

2. DESCRIPTION OF TEST CONFIGURATION

2.1 Operation Frequency Detail

For 802.11a/n ht20/ac vht20/ax he20:

5150-5250MHz Band		5725-5850MHz Band	
Channel	Frequency (MHz)	Channel	Frequency (MHz)
36	5180	149	5745
40	5200	153	5765
44	5220	157	5785
48	5240	161	5805
/	/	165	5825

For 802.11n ht40/ac vht40/ax he40:

5150-5250MHz Band		5725-5850MHz Band	
Channel	Frequency (MHz)	Channel	Frequency (MHz)
38	5190	151	5755
46	5230	159	5795

For 802.11ac vht80/ax he80:

5150-5250MHz Band		5725-5850MHz Band	
Channel	Frequency (MHz)	Channel	Frequency (MHz)
42	5210	155	5775

2.2 EUT Operation Condition

The system was configured for testing in Engineering Mode, which was provided by the manufacturer. The following summary table is showing all test modes to demonstrate in compliance with the standard:

Test Items	Test Modes
RF Conducted	Mode 1: Transmitting 802.11a
	Mode 2: Transmitting 802.11n ht20
	Mode 3: Transmitting 802.11n ht40
	Mode 4: Transmitting 802.11ac vht20
	Mode 5: Transmitting 802.11ac vht40
	Mode 6: Transmitting 802.11ac vht80
	Mode 7: Transmitting 802.11ax he20
	Mode 8: Transmitting 802.11ax he40
	Mode 9: Transmitting 802.11ax he80
Radiated Spurious Emission	Mode 1: Transmitting 802.11a
	Mode 2: Transmitting 802.11n ht20
	Mode 3: Transmitting 802.11n ht40
	Mode 4: Transmitting 802.11ac vht20
	Mode 5: Transmitting 802.11ac vht40
	Mode 6: Transmitting 802.11ac vht80
	Mode 7: Transmitting 802.11ax he20
	Mode 8: Transmitting 802.11ax he40
	Mode 9: Transmitting 802.11ax he80
AC Line Conducted Emission	Test was performed at the channel and mode with maximum output power (Per pretest, 802.11n ht20 Non-beamforming, 5200MHz was the maximum power)
<p>Note: Mode 1~9 were tested with the frequencies in bold in section 2.1. The device supports SISO in all modes, and MIMO 2Tx in 802.11n/ac/ax mode, per pretest, 2Tx mode was the worst mode and reported for 802.11n/ac/ax mode. The system supports Beamforming and Non-beamforming modes at 802.11n/ac/ax mode. The two modes have same output power, which are declared by manufacturer. Therefore, the all RF conducted test were performed at Non-beamforming mode only. For 802.11 ax mode, the device only supports full-RU.</p>	

2.3 EUT Exercise Software

EUT Exercise Software:		MP_tool_8832b					
The software was provided by manufacturer. The maximum power was configured as below, that was provided by the manufacturer ▲:							
5150-5250 MHz Band:							
Test Modes	Data Rate	Power Level Setting					
		Low Channel		Middle Channel		High Channel	
		Chain 0	Chain 1	Chain 0	Chain 1	Chain 0	Chain 1
802.11a	6Mbps	20	20	20	20	20	20
802.11n ht20	6Mbps	19	19	19	19	19	19
802.11n ht40	MCS8	17	17	/	/	17	17
802.11ac vht20	MCS8	19	19	19	19	19	19
802.11ac vht40	MCS8	16	16	/	/	16	16
802.11ac vht80	MCS8	/	/	16	16	/	/
802.11 ax he20	MCS8	19	19	19	19	19	19
802.11ax he40	MCS8	17	17	/	/	17	17
802.11ax he80	MCS8	/	/	15	15	/	/

5725-5850 MHz Band:							
Test Modes	Data Rate	Power Level Setting					
		Low Channel		Middle Channel		High Channel	
		Chain 0	Chain 1	Chain 0	Chain 1	Chain 0	Chain 1
802.11a	6Mbps	18	16	18	16	18	16
802.11n ht20	6Mbps	16	14	16	14	16	14
802.11n ht40	MCS8	17	15	/	/	17	15
802.11ac vht20	MCS8	14	12	14	12	14	12
802.11ac vht40	MCS8	14	12	/	/	14	12
802.11ac vht80	MCS8	/	/	16	14	/	/
802.11 ax he20	MCS8	13	11	13	11	13	11
802.11ax he40	MCS8	15	13	/	/	15	13
802.11ax he80	MCS8	/	/	16	14	/	/

Note:

1. The above are the worst-case data rates, which are determined for each mode based upon investigations by measuring the average power and PSD across all data rates, bandwidths, and modulations.

2.4 Support Equipment List and Details

Manufacturer	Description	Model	Serial Number
Lenovo	Laptop	E450	PF-OMR8KV
Bacl	Load 1#	RJ45X8	F-EM-PHRJ45X8001
Bacl	Load 2#	RJ45X8	F-EM-PHRJ45X8002
Bacl	Load 3#	RJ45X8	F-EM-PHRJ45X8003

2.5 Support Cable List and Details

Cable Description	Shielding Type	Ferrite Core	Length (m)	From Port	To
DC Cable	no	no	1.5	Adapter	EUT
RJ45 Cable	no	no	10.0	EUT	Laptop
RJ45 Cable	no	no	10.0	EUT	Load 1#
RJ45 Cable	no	no	10.0	EUT	Load 2#
RJ45 Cable	no	no	10.0	EUT	Load 3#

2.6 Block Diagram of Test Setup

AC line conducted emissions:

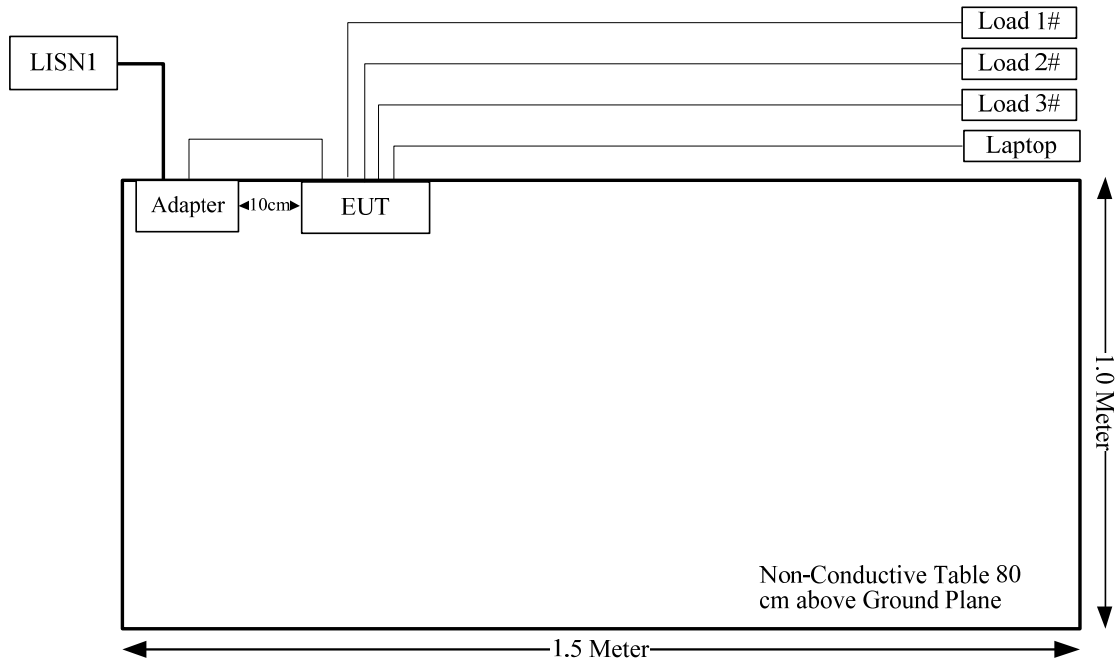

Radiated Spurious Emissions:

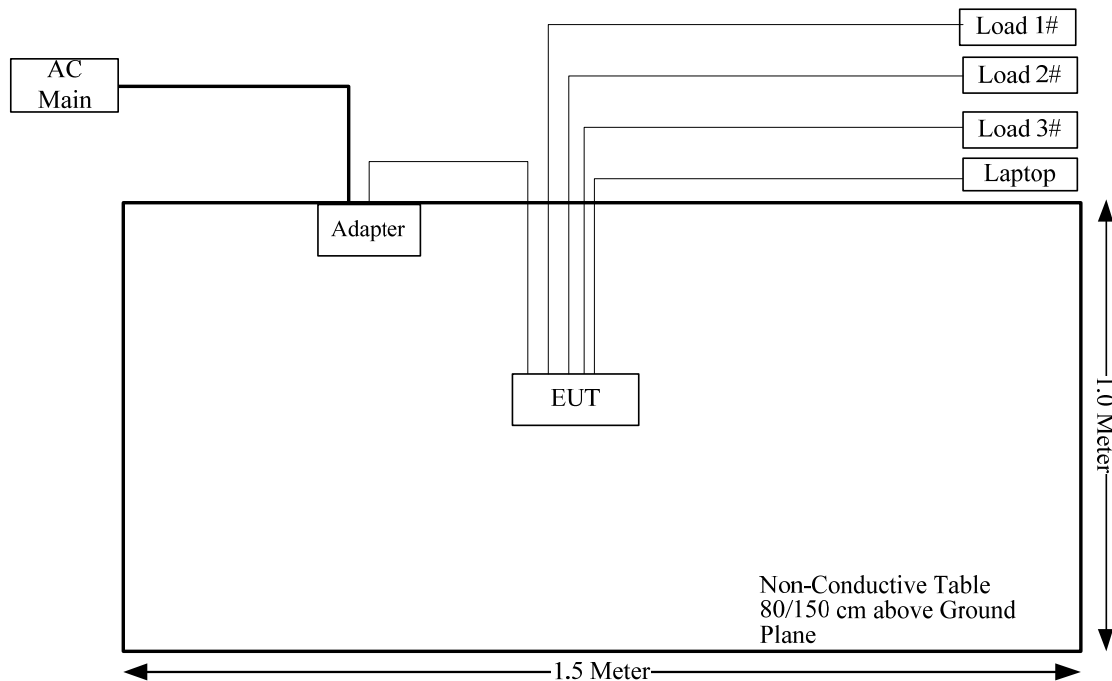

2.7 Test Facility

The Test site used by Bay Area Compliance Laboratories Corp. (Dongguan) to collect test data is located on the No.12, Pulong East 1st Road, Tangxia Town, Dongguan, Guangdong, China.

The lab has been recognized as the FCC accredited lab under the KDB 974614 D01 and is listed in the FCC Public Access Link (PAL) database, FCC Registration No. : 829273, the FCC Designation No. : CN5044.

The lab has been recognized by Innovation, Science and Economic Development Canada to test to Canadian radio equipment requirements, the CAB identifier: CN0022.

2.8 Measurement Uncertainty

Otherwise required by the applicant or Product Regulations, Decision Rule in this report did not consider the uncertainty. The extended uncertainty given in this report is obtained by combining the standard uncertainty times the coverage factor K with the 95% confidence interval.

Parameter	Measurement Uncertainty
Occupied Channel Bandwidth	±5 %
RF output power, conducted	±0.61dB
Power Spectral Density, conducted	±0.61 dB
Unwanted Emissions, radiated	9kHz~30MHz: 3.3dB, 30MHz~200MHz: 4.55 dB, 200MHz~1GHz: 5.92 dB, 1GHz~6GHz: 4.98 dB, 6GHz~18GHz: 5.89 dB, 18GHz~26.5GHz:5.47 dB, 26.5GHz~40GHz:5.63 dB
Unwanted Emissions, conducted	±2.47 dB
Temperature	±1°C
Humidity	±5%
DC and low frequency voltages	±0.4%
Duty Cycle	1%
AC Power Lines Conducted Emission	3.11 dB (150 kHz to 30 MHz)

3. SUMMARY OF TEST RESULTS

Standard(s) Section	Test Items	Result
§15.207(a)	AC line conducted emissions	Compliant
FCC§15.205& §15.209 &§15.407(b)	Radiated Spurious Emissions	Compliant
FCC§15.407(a) (e)	Emission Bandwidth	Compliant
FCC§15.407(a)	Maximum Conducted Output Power	Compliant
FCC§15.407 (a)	Power Spectral Density	Compliant
§15.203	Antenna Requirement	Compliant

4. REQUIREMENTS AND TEST PROCEDURES

4.1 AC Line Conducted Emissions

4.1.1 Applicable Standard

FCC§15.207(a).

(a) Except as shown in paragraphs (b) and (c) of this section, for an intentional radiator that is designed to be connected to the public utility (AC) power line, the radio frequency voltage that is conducted back onto the AC power line on any frequency or frequencies, within the band 150 kHz to 30 MHz, shall not exceed the limits in the following table, as measured using a 50 μ H/50 ohms line impedance stabilization network (LISN). Compliance with the provisions of this paragraph shall be based on the measurement of the radio frequency voltage between each power line and ground at the power terminal. The lower limit applies at the boundary between the frequency ranges.

Frequency of emission (MHz)	Conducted limit (dB μ V)	
	Quasi-peak	Average
0.15-0.5	66 to 56*	56 to 46*
0.5-5	56	46
5-30	60	50

*Decreases with the logarithm of the frequency.

(b) The limit shown in paragraph (a) of this section shall not apply to carrier current systems operating as intentional radiators on frequencies below 30 MHz. In lieu thereof, these carrier current systems shall be subject to the following standards:

(1) For carrier current system containing their fundamental emission within the frequency band 535-1705 kHz and intended to be received using a standard AM broadcast receiver: no limit on conducted emissions.

(2) For all other carrier current systems: 1000 μ V within the frequency band 535-1705 kHz, as measured using a 50 μ H/50 ohms LISN.

(3) Carrier current systems operating below 30 MHz are also subject to the radiated emission limits in §15.205, §15.209, §15.221, §15.223, or §15.227, as appropriate.

(c) Measurements to demonstrate compliance with the conducted limits are not required for devices which only employ battery power for operation and which do not operate from the AC power lines or contain provisions for operation while connected to the AC power lines. Devices that include, or make provisions for, the use of battery chargers which permit operating while charging, AC adapters or battery eliminators or that connect to the AC power lines indirectly, obtaining their power through another device which is connected to the AC power lines, shall be tested to demonstrate compliance with the conducted limits.

4.1.2 EUT Setup

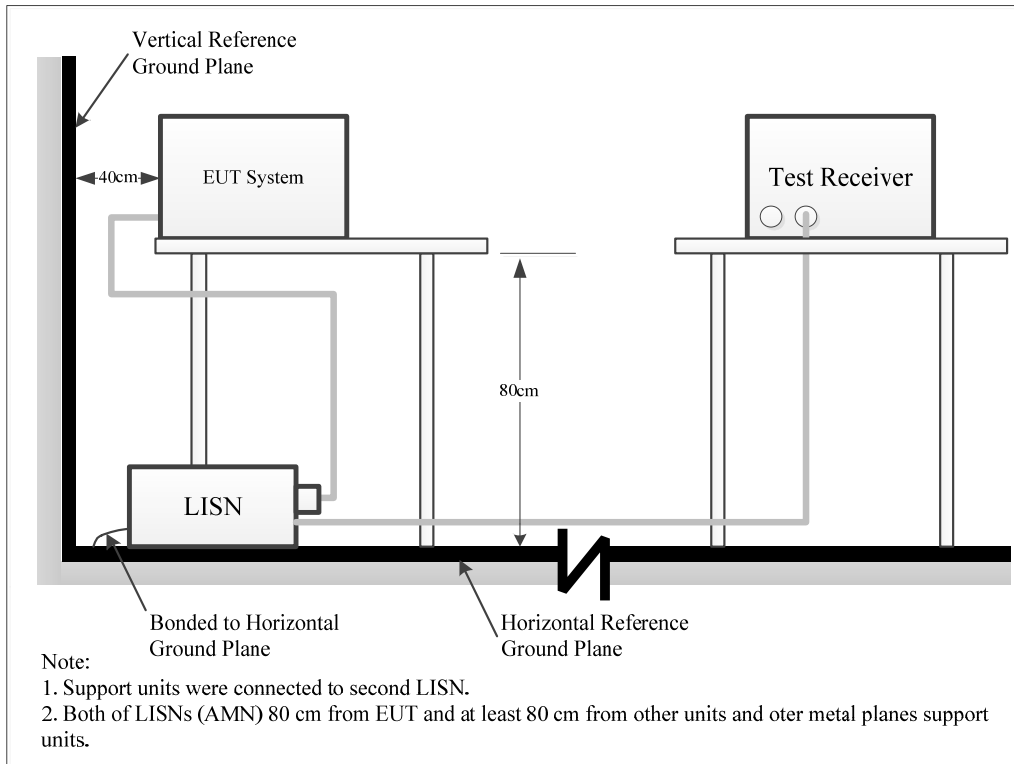

The setup of EUT is according with per ANSI C63.10-2013 measurement procedure. The specification used was with the FCC Part 15.207 limits.

The spacing between the peripherals was 10 cm.

The adapter or EUT was connected to the main LISN with a 120 V/60 Hz AC power source.

4.1.3 EMI Test Receiver Setup

The EMI test receiver was set to investigate the spectrum from 150 kHz to 30 MHz.

During the conducted emission test, the EMI test receiver was set with the following configurations:

Frequency Range	IF B/W
150 kHz – 30 MHz	9 kHz

4.1.4 Test Procedure

The frequency and amplitude of the six highest ac power-line conducted emissions relative to the limit, measured over all the current-carrying conductors of the EUT power cords, and the operating frequency or frequency to which the EUT is tuned (if appropriate), should be reported, unless such emissions are more than 20 dB below the limit. AC power-line conducted emissions measurements are to be separately carried out only on each of the phase (“hot”) line(s) and (if used) on the neutral line(s), but not on the ground [protective earth] line(s). If less than six emission frequencies are within 20 dB of the limit, then the noise level of the measuring instrument at representative frequencies should be reported. The specific conductor of the power-line cord for each of the reported emissions should be identified. Measure the six highest emissions with respect to the limit on each current-carrying conductor of each power cord associated with the EUT (but not the power cords of associated or peripheral equipment that are part of the test configuration). Then, report the six highest emissions with respect to the limit from among all the measurements identifying the frequency and specific current-carrying conductor identified with the emission. The six highest emissions should be reported for each of the current-carrying conductors, or the six highest emissions may be reported over all the current-carrying conductors.

4.1.5 Corrected Amplitude & Margin Calculation

The basic equation is as follows:

$$\text{Result} = \text{Reading} + \text{Factor}$$

$$\text{Factor} = \text{attenuation caused by cable loss} + \text{voltage division factor of AMN}$$

The “**Margin**” column of the following data tables indicates the degree of compliance within the applicable limit. The equation for margin calculation is as follows:

$$\text{Margin} = \text{Limit} - \text{Result}$$

4.1.6 Test Result

Please refer to section 5.1.

4.2 Radiation Spurious Emissions

4.2.1 Applicable Standard

FCC §15.407 (b);

Undesirable emission limits. Except as shown in paragraph (b)(7) of this section, the maximum emissions outside of the frequency bands of operation shall be attenuated in accordance with the following limits:

- (1) For transmitters operating in the 5.15-5.25 GHz band: All emissions outside of the 5.15-5.35 GHz band shall not exceed an e.i.r.p. of - 27 dBm/MHz.
 - (2) For transmitters operating in the 5.25-5.35 GHz band: All emissions outside of the 5.15-5.35 GHz band shall not exceed an e.i.r.p. of - 27 dBm/MHz.
 - (3) For transmitters operating in the 5.47-5.725 GHz band: All emissions outside of the 5.47-5.725 GHz band shall not exceed an e.i.r.p. of - 27 dBm/MHz.
 - (4) For transmitters operating solely in the 5.725-5.850 GHz band:
 - (i) All emissions shall be limited to a level of - 27 dBm/MHz at 75 MHz or more above or below the band edge increasing linearly to 10 dBm/MHz at 25 MHz above or below the band edge, and from 25 MHz above or below the band edge increasing linearly to a level of 15.6 dBm/MHz at 5 MHz above or below the band edge, and from 5 MHz above or below the band edge increasing linearly to a level of 27 dBm/MHz at the band edge.
 - (ii) Devices certified before March 2, 2017 with antenna gain greater than 10 dBi may demonstrate compliance with the emission limits in § 15.247(d), but manufacturing, marketing and importing of devices certified under this alternative must cease by March 2, 2018. Devices certified before March 2, 2018 with antenna gain of 10 dBi or less may demonstrate compliance with the emission limits in § 15.247(d), but manufacturing, marketing and importing of devices certified under this alternative must cease before March 2, 2020.
 - (8) The emission measurements shall be performed using a minimum resolution bandwidth of 1 MHz. A lower resolution bandwidth may be employed near the band edge, when necessary, provided the measured energy is integrated to show the total power over 1 MHz.
 - (9) Unwanted emissions below 1 GHz must comply with the general field strength limits set forth in § 15.209. Further, any U-NII devices using an AC power line are required to comply also with the conducted limits set forth in § 15.207.
 - (10) The provisions of § 15.205 apply to intentional radiators operating under this section.
 - (11) When measuring the emission limits, the nominal carrier frequency shall be adjusted as close to the upper and lower frequency band edges as the design of the equipment permits.
- (c) The device shall automatically discontinue transmission in case of either absence of information to transmit or operational failure. These provisions are not intended to preclude the transmission of control or signalling information or the use of repetitive codes used by certain digital technologies to complete frame or burst intervals. Applicants shall include in their application for equipment authorization a description of how this requirement is met.

4.2.2 EUT Setup

9kHz~30MHz:

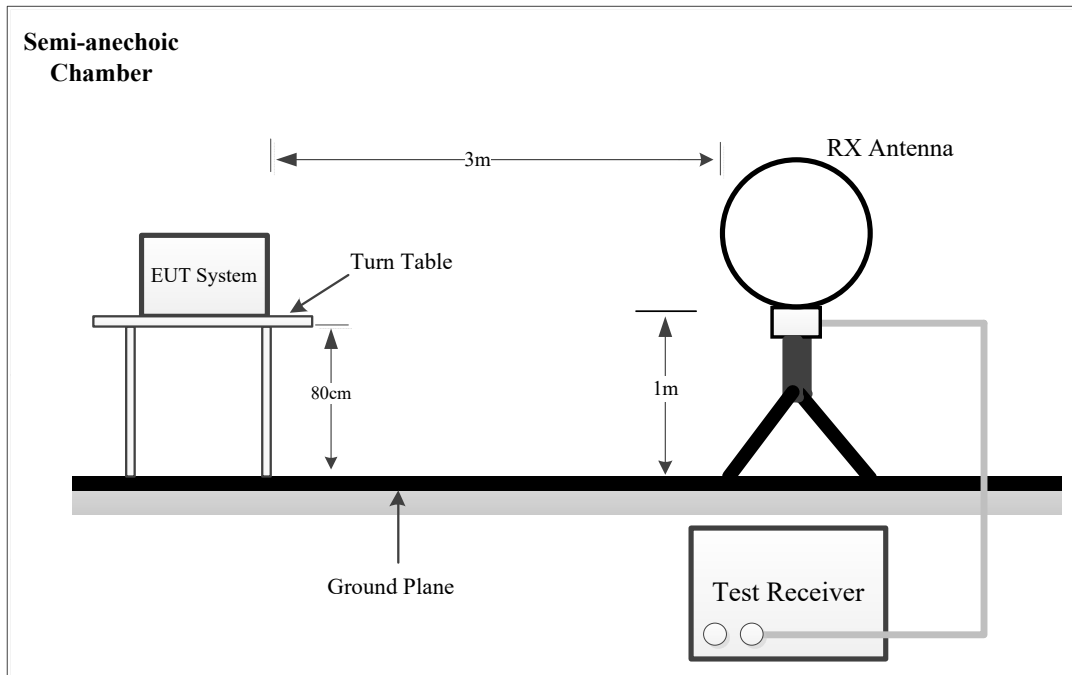

30MHz~1GHz:

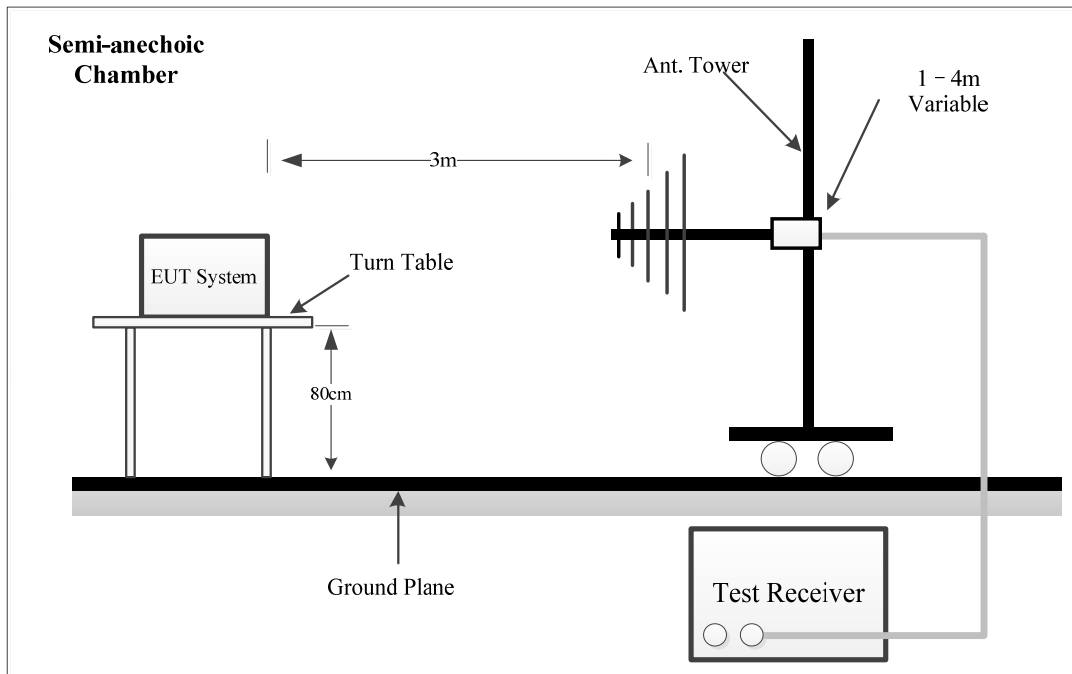

Above 1GHz:

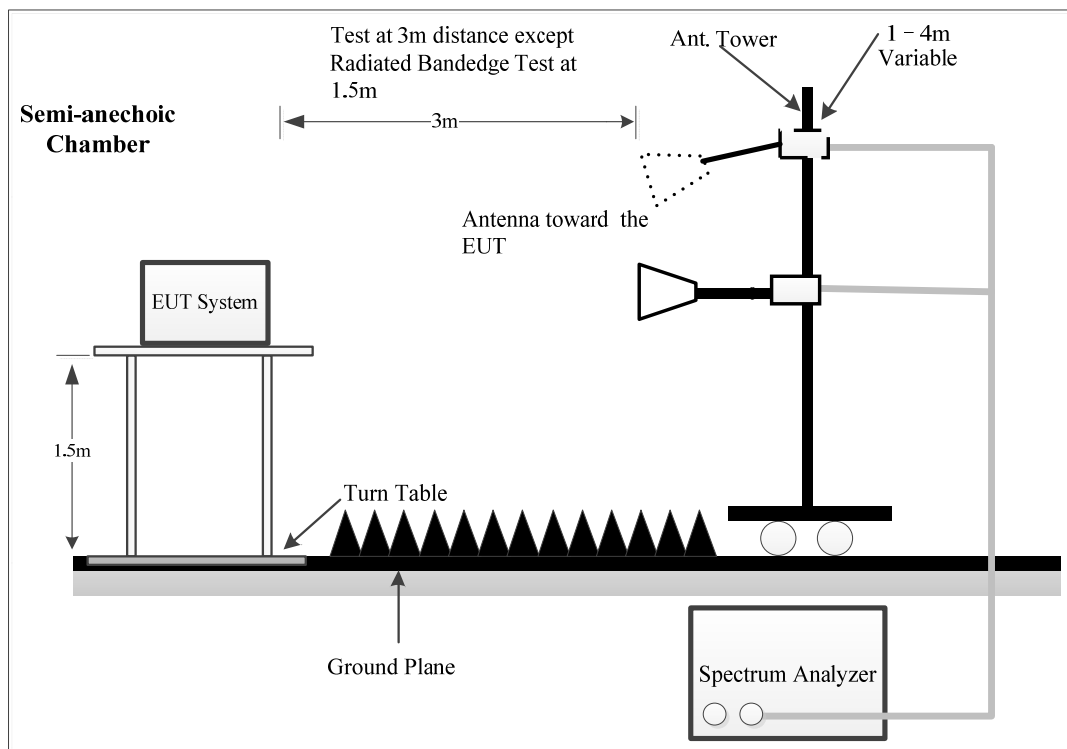

The radiated emission tests were performed in the semi-anechoic chamber, using the setup accordance with the ANSI C63.10-2013. The specification used was FCC 15.209, FCC 15.407 limits.

The external I/O cables were draped along the test table and formed a bundle 30 to 40 cm long in the middle.

The spacing between the peripherals was 10 cm.

For 9kHz-30MHz test, the lowest height of the magnetic antenna shall be 1 m above the ground and three antenna orientations (parallel, perpendicular, and ground-parallel) shall be measured.

4.2.3 EMI Test Receiver & Spectrum Analyzer Setup

The system was investigated from 9 kHz to 40 GHz.

During the radiated emission test, the EMI test receiver & Spectrum Analyzer Setup were set with the following configurations:

9kHz-1000MHz:

Frequency Range	Measurement	RBW	Video B/W	IF B/W
9 kHz – 150 kHz	QP/AV	200 Hz	1 kHz	200 Hz
150 kHz – 30 MHz	QP/AV	9 kHz	30 kHz	9 kHz
30 MHz – 1000 MHz	PK	100 kHz	300 kHz	/
	QP	/	/	120 kHz

1GHz- 40GHz:

Measurement	Duty cycle	RBW	Video B/W
PK	Any	1MHz	3 MHz
Ave.	>98%	1MHz	10 Hz
	<98%	1MHz	≥1/T

Note: T is minimum transmission duration

If the maximized peak measured value complies with under the QP/Average limit more than 6dB, then it is unnecessary to perform an QP/Average measurement.

4.2.4 Test Procedure

During the radiated emission test, the adapter was connected to the first AC floor outlet.

Data was recorded in Quasi-peak detection mode for frequency range of 9 kHz -1 GHz, except 9-90 kHz, 110-490 kHz, employing an average detector, peak and Average detection modes for frequencies above 1 GHz.

According to KDB 789033 D02 General UNII Test Procedures New Rules v02r01, emission shall be computed as: $E [dB\mu V/m] = EIRP[dBm] + 95.2$, for $d = 3$ meters.

For Radiated Bandedge test, which was performed at 1.5 m distance, according to C63.10, the test result shall be extrapolated to the specified distance using an extrapolation Factor of 20dB/decade from 3m to 1.5m

Distance extrapolation Factor = $20 \log (\text{specific distance } [3m]/\text{test distance } [1.5m]) \text{ dB} = 6.02 \text{ dB}$

All emissions under the average limit and under the noise floor have not recorded in the report.

4.2.5 Corrected Result & Margin Calculation

The basic equation except radiated bandedge test is as follows:

Factor = Antenna Factor + Cable Loss- Amplifier Gain

Result = Reading + Factor

For Radiated Bandedge test:

Factor = Antenna Factor + Cable Loss-Distance extrapolation Factor

Result = Reading + Factor

The “Margin” column of the following data tables indicates the degree of compliance within the applicable limit. The equation for margin calculation is as follows:

Margin = Limit – Result

4.2.6 Test Result

Please refer to section 5.2.

4.3 Emission Bandwidth

4.3.1 Applicable Standard

FCC §15.407 (a),(h)

(h)(2) Radar Detection Function of Dynamic Frequency Selection (DFS). U-NII devices operating with any part of its 26 dB emission bandwidth in the 5.25-5.35 GHz and 5.47-5.725 GHz bands shall employ a DFS radar detection mechanism to detect the presence of radar systems and to avoid co-channel operation with radar systems.

FCC §15.407 (e)

Within the 5.725-5.850 GHz and 5.850-5.895 GHz bands, the minimum 6 dB bandwidth of U-NII devices shall be at least 500 kHz.

4.3.2 EUT Setup

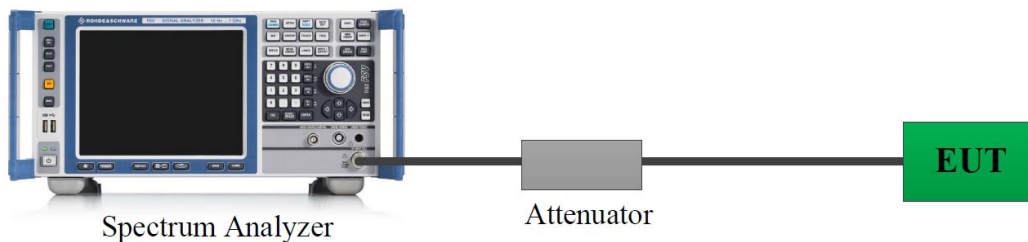

4.3.3 Test Procedure

26dB Emission Bandwidth:

According to ANSI C63.10-2013 Section 12.4.1

- a) Set RBW = approximately 1% of the emission bandwidth.
- b) Set the VBW > RBW.
- c) Detector = peak.
- d) Trace mode = max hold
- e) Measure the maximum width of the emission that is 26 dB down from the peak of the emission. Compare this with the RBW setting of the instrument. Readjust RBW and repeat measurement as needed until the RBW/EBW ratio is approximately 1%.

6 dB emission bandwidth:

According to KDB 789033 D02 General UNII Test Procedures New Rules v02r01

- a) Set RBW = 100 kHz.
- b) Set the video bandwidth (VBW) ≥ 3 RBW.
- c) Detector = Peak.
- d) Trace mode = max hold.
- e) Sweep = auto couple.
- f) Allow the trace to stabilize.
- g) Measure the maximum width of the emission that is constrained by the frequencies associated with the two outermost amplitude points (upper and lower frequencies) that are attenuated by 6 dB relative to the maximum level measured in the fundamental emission.

Note: The automatic bandwidth measurement capability of a spectrum analyzer or EMI receiver may be employed if it implements the functionality described in this section. For devices that use channel aggregation refer to III.A and III.C for determining emission bandwidth.

99% Occupied Bandwidth:

According to ANSI C63.10-2013 Section 12.4.2&6.9.3

The occupied bandwidth is the frequency bandwidth such that, below its lower and above its upper frequency limits, the mean powers are each equal to 0.5% of the total mean power of the given emission. The following procedure shall be used for measuring 99% power bandwidth:

a) The instrument center frequency is set to the nominal EUT channel center frequency. The frequency span for the spectrum analyzer shall be between 1.5 times and 5.0 times the OBW.

b) The nominal IF filter bandwidth (3 dB RBW) shall be in the range of 1% to 5% of the OBW, and VBW shall be approximately three times the RBW, unless otherwise specified by the applicable requirement.

c) Set the reference level of the instrument as required, keeping the signal from exceeding the maximum input mixer level for linear operation. In general, the peak of the spectral envelope shall be more than $[10 \log (OBW/RBW)]$ below the reference level. Specific guidance is given in 4.1.5.2.

d) Step a) through step c) might require iteration to adjust within the specified range.

e) Video averaging is not permitted. Where practical, a sample detection and single sweep mode shall be used. Otherwise, peak detection and max hold mode (until the trace stabilizes) shall be used.

f) Use the 99% power bandwidth function of the instrument (if available) and report the measured bandwidth.

g) If the instrument does not have a 99% power bandwidth function, then the trace data points are recovered and directly summed in linear power terms. The recovered amplitude data points, beginning at the lowest frequency, are placed in a running sum until 0.5% of the total is reached; that frequency is recorded as the lower frequency. The process is repeated until 99.5% of the total is reached; that frequency is recorded as the upper frequency. The 99% power bandwidth is the difference between these two frequencies.

h) The occupied bandwidth shall be reported by providing plot(s) of the measuring instrument display; the plot axes and the scale units per division shall be clearly labeled. Tabular data may be reported in addition to the plot(s).

4.3.4 Test Result

Please refer to section 5.3 and section 5.4.

4.4 Maximum Conducted Output Power

4.4.1 Applicable Standard

FCC §15.407(a) (1)(ii)

For an indoor access point operating in the band 5.15-5.25 GHz, the maximum conducted output power over the frequency band of operation shall not exceed 1 W provided the maximum antenna gain does not exceed 6 dBi. In addition, the maximum power spectral density shall not exceed 17 dBm in any 1 megahertz band. If transmitting antennas of directional gain greater than 6 dBi are used, both the maximum conducted output power and the maximum power spectral density shall be reduced by the amount in dB that the directional gain of the antenna exceeds 6 dBi.

FCC §15.407(a) (2)

For the 5.25-5.35 GHz and 5.47-5.725 GHz bands, the maximum conducted output power over the frequency bands of operation shall not exceed the lesser of 250 mW or $11 \text{ dBm} + 10 \log B$, where B is the 26 dB emission bandwidth in megahertz. In addition, the maximum power spectral density shall not exceed 11 dBm in any 1 megahertz band. If transmitting antennas of directional gain greater than 6 dBi are used, both the maximum conducted output power and the maximum power spectral density shall be reduced by the amount in dB that the directional gain of the antenna exceeds 6 dBi.

FCC §15.407(a) (3)(i)

For the band 5.725-5.850 GHz, the maximum conducted output power over the frequency band of operation shall not exceed 1 W. In addition, the maximum power spectral density shall not exceed 30 dBm in any 500-kHz band. If transmitting antennas of directional gain greater than 6 dBi are used, both the maximum conducted output power and the maximum power spectral density shall be reduced by the amount in dB that the directional gain of the antenna exceeds 6 dBi. However, fixed point-to-point U-NII devices operating in this band may employ transmitting antennas with directional gain greater than 6 dBi without any corresponding reduction in transmitter conducted power. Fixed, point-to-point operations exclude the use of point-to-multipoint systems, omnidirectional applications, and multiple collocated transmitters transmitting the same information. The operator of the U-NII device, or if the equipment is professionally installed, the installer, is responsible for ensuring that systems employing high gain directional antennas are used exclusively for fixed, point-to-point operations.

4.4.2 EUT Setup

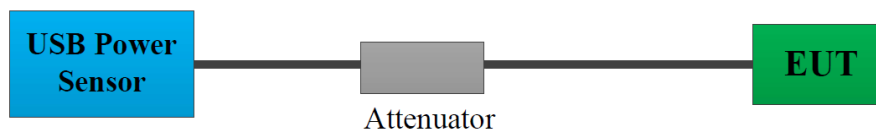

4.4.3 Test Procedure

According to ANSI C63.10-2013 Section 12.3.3.1

Method PM-G is measurement using a gated RF average power meter.

Measurements may be performed using a wideband gated RF power meter provided that the gate parameters are adjusted such that the power is measured only when the EUT is transmitting at its maximum power control level. Because the measurement is made only during the ON time of the transmitter, no duty cycle correction factor is required.

4.4.3 Test Result

Please refer to section 5.5.

4.5 Maximum Power Spectral Density

4.5.1 Applicable Standard

FCC §15.407(a) (1)(ii)

For an indoor access point operating in the band 5.15-5.25 GHz, the maximum conducted output power over the frequency band of operation shall not exceed 1 W provided the maximum antenna gain does not exceed 6 dBi. In addition, the maximum power spectral density shall not exceed 17 dBm in any 1 megahertz band. If transmitting antennas of directional gain greater than 6 dBi are used, both the maximum conducted output power and the maximum power spectral density shall be reduced by the amount in dB that the directional gain of the antenna exceeds 6 dBi.

FCC §15.407(a) (2)

For the 5.25-5.35 GHz and 5.47-5.725 GHz bands, the maximum conducted output power over the frequency bands of operation shall not exceed the lesser of 250 mW or $11 \text{ dBm} + 10 \log B$, where B is the 26 dB emission bandwidth in megahertz. In addition, the maximum power spectral density shall not exceed 11 dBm in any 1 megahertz band. If transmitting antennas of directional gain greater than 6 dBi are used, both the maximum conducted output power and the maximum power spectral density shall be reduced by the amount in dB that the directional gain of the antenna exceeds 6 dBi.

FCC §15.407(a) (3)(i)

For the band 5.725-5.850 GHz, the maximum conducted output power over the frequency band of operation shall not exceed 1 W. In addition, the maximum power spectral density shall not exceed 30 dBm in any 500-kHz band. If transmitting antennas of directional gain greater than 6 dBi are used, both the maximum conducted output power and the maximum power spectral density shall be reduced by the amount in dB that the directional gain of the antenna exceeds 6 dBi. However, fixed point-to-point U-NII devices operating in this band may employ transmitting antennas with directional gain greater than 6 dBi without any corresponding reduction in transmitter conducted power. Fixed, point-to-point operations exclude the use of point-to-multipoint systems, omnidirectional applications, and multiple collocated transmitters transmitting the same information. The operator of the U-NII device, or if the equipment is professionally installed, the installer, is responsible for ensuring that systems employing high gain directional antennas are used exclusively for fixed, point-to-point operations.

4.5.2 EUT Setup

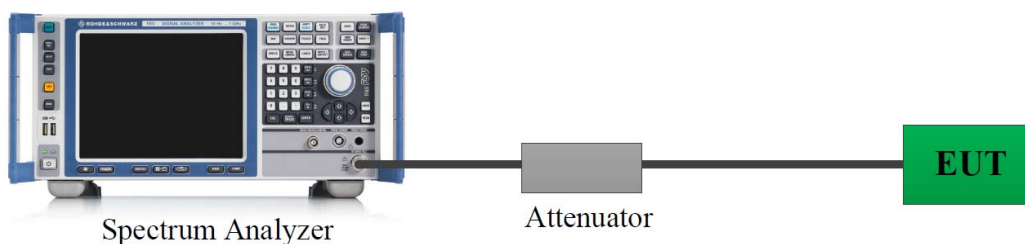

4.5.3 Test Procedure

According to KDB 789033 D02 General UNII Test Procedures New Rules v02r01

Duty cycle $\geq 98\%$

KDB 789033 D02 General UNII Test Procedures New Rules v02r01 Method SA-1 should be applied.

Duty cycle $< 98\%$, duty cycle variations are less than $\pm 2\%$

KDB 789033 D02 General UNII Test Procedures New Rules v02r01 Method SA-2 should be applied.

Duty cycle $< 98\%$, duty cycle variations exceed $\pm 2\%$

KDB 789033 D02 General UNII Test Procedures New Rules v02r01 Method SA-3 should be applied.

4.5.4 Test Result

Please refer to section 5.6.

4.6 Duty Cycle

4.6.1 EUT Setup

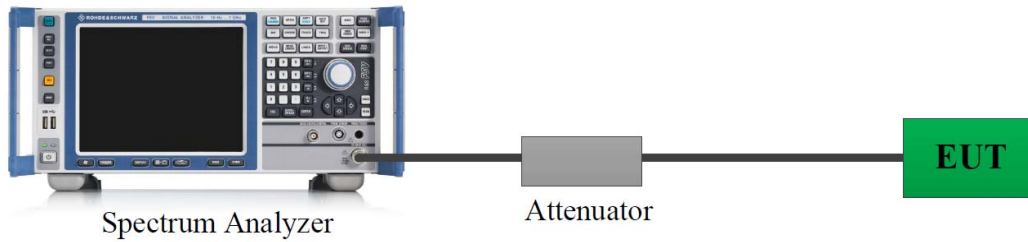

4.6.2 Test Procedure

According to ANSI C63.10-2013 Section 12.2

The zero-span mode on a spectrum analyzer or EMI receiver if the response time and spacing between bins on the sweep are sufficient to permit accurate measurements of the ON and OFF times of the transmitted signal:

- 1) Set the center frequency of the instrument to the center frequency of the transmission.
- 2) Set $RBW \geq OBW$ if possible; otherwise, set RBW to the largest available value.
- 3) Set $VBW \geq RBW$. Set detector = peak or average.
- 4) The zero-span measurement method shall not be used unless both RBW and VBW are $> 50/T$ and the number of sweep points across duration T exceeds 100. (For example, if VBW and/or RBW are limited to 3 MHz, then the zero-span method of measuring the duty cycle shall not be used if $T \leq 16.7 \mu s$.)

4.6.3 Judgment

Report Only. Please refer to section 5.7.

4.7 Antenna Requirement

4.7.1 Applicable Standard

FCC §15.203

An intentional radiator shall be designed to ensure that no antenna other than that furnished by the responsible party shall be used with the device. The use of a permanently attached antenna or of an antenna that uses a unique coupling to the intentional radiator shall be considered sufficient to comply with the provisions of this section. The manufacturer may design the unit so that a broken antenna can be replaced by the user, but the use of a standard antenna jack or electrical connector is prohibited. This requirement does not apply to carrier current devices or to devices operated under the provisions of §§15.211, 15.213, 15.217, 15.219, 15.221, or §15.236. Further, this requirement does not apply to intentional radiators that must be professionally installed, such as perimeter protection systems and some field disturbance sensors, or to other intentional radiators which, in accordance with §15.31(d), must be measured at the installation site. However, the installer shall be responsible for ensuring that the proper antenna is employed so that the limits in this part are not exceeded.

4.7.2 Judgment

Compliant. Please refer to the Antenna Information detail in Section 1.3.

5. Test DATA AND RESULTS

5.1 AC Line Conducted Emissions

Serial Number:	2FY2-1	Test Date:	2024/1/8
Test Site:	CE	Test Mode:	Transmitting
Tester:	Lane Sun	Test Result:	Pass

Environmental Conditions:

Temperature: (°C)	21.0	Relative Humidity: (%)	59	ATM Pressure: (kPa)	101.4
----------------------	------	------------------------------	----	------------------------	-------

Test Equipment List and Details:

Manufacturer	Description	Model	Serial Number	Calibration Date	Calibration Due Date
R&S	LISN	ENV216	101614	2023/10/18	2024/10/17
MICRO-COAX	Coaxial Cable	C-NJNJ-50	C-0200-01	2023/9/5	2024/9/4
R&S	EMI Test Receiver	ESCI	100035	2023/8/18	2024/8/17
R&S	Test Software	EMC32	V9.10.00	N/A	N/A

* Statement of Traceability: Bay Area Compliance Laboratories Corp. (Dongguan) attests that all calibrations have been performed, traceable to National Primary Standards and International System of Units (SI).

Project No: DG2231229-79269E-RF
 Test Engineer: Lane Sun
 Test Date: 2024-1-8
 Port: L
 Test Mode: Transmitting(802.11n ht20 MIMO 5200MHz)
 Power Source: AC 120V/60Hz

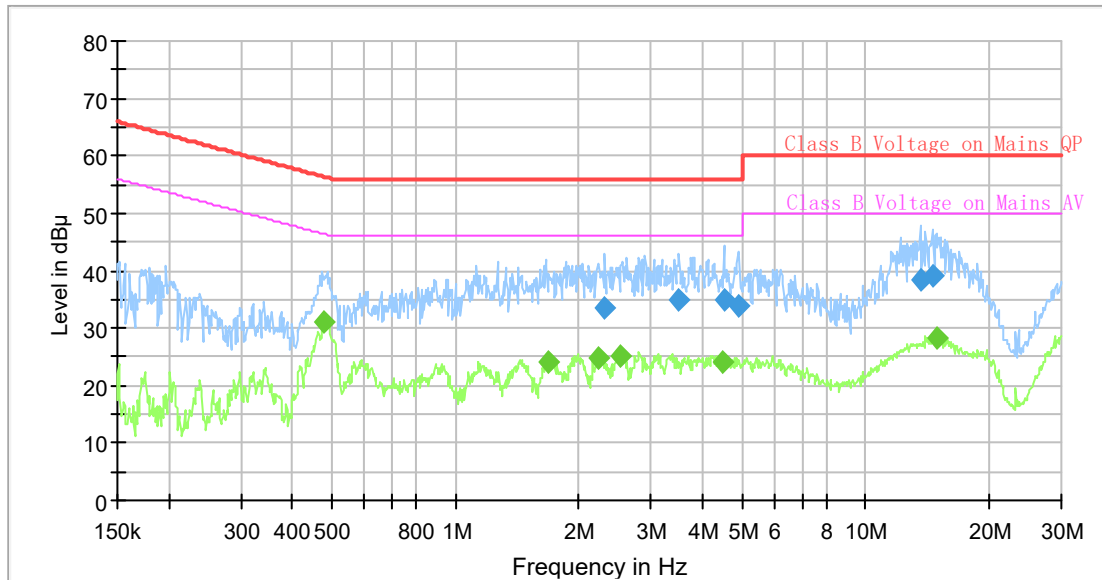

Final Result

Frequency (MHz)	QuasiPeak (dB μV)	Average (dB μV)	Limit (dB μV)	Margin (dB)	Bandwidth (kHz)	Line	Corr. (dB)
0.477109	---	31.25	46.39	15.14	9.000	L1	10.8
1.693547	---	24.12	46.00	21.88	9.000	L1	10.8
2.239220	---	24.97	46.00	21.03	9.000	L1	10.8
2.318778	33.56	---	56.00	22.44	9.000	L1	10.8
2.536578	---	25.17	46.00	20.83	9.000	L1	10.8
3.507860	34.81	---	56.00	21.19	9.000	L1	10.8
4.501377	---	23.98	46.00	22.02	9.000	L1	10.8
4.523884	34.79	---	56.00	21.21	9.000	L1	10.8
4.924186	33.92	---	56.00	22.08	9.000	L1	10.8
13.621066	38.35	---	60.00	21.65	9.000	L1	10.8
14.533489	39.00	---	60.00	21.00	9.000	L1	10.9
14.900478	---	28.21	50.00	21.79	9.000	L1	10.9

Project No: DG2231229-79269E-RF
 Test Engineer: Lane Sun
 Test Date: 2024-1-8
 Port: N
 Test Mode: Transmitting(802.11n ht20 MIMO 5200MHz)
 Power Source: AC 120V/60Hz

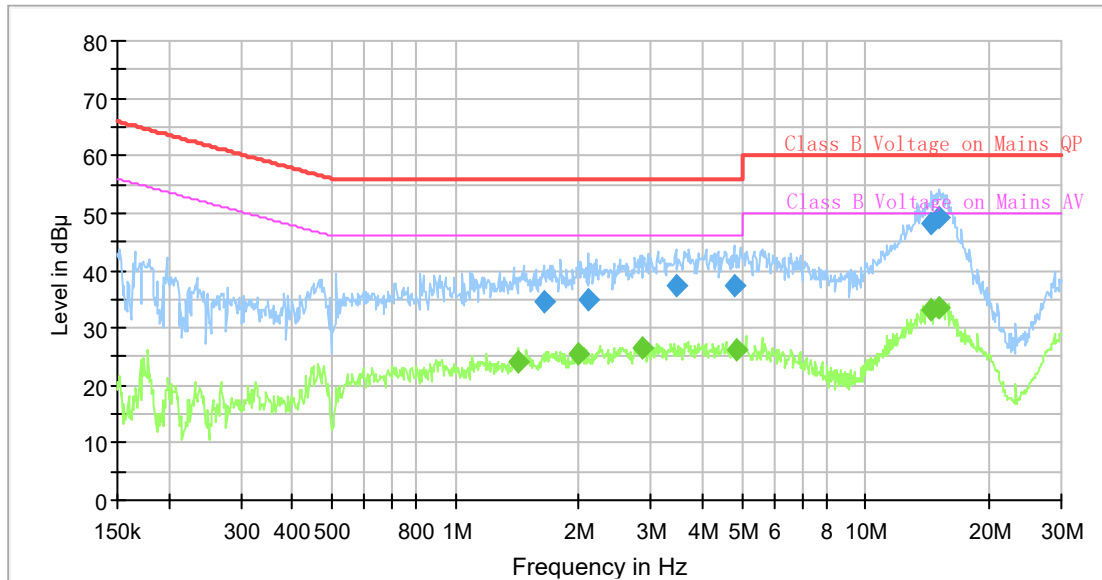

Final Result

Frequency (MHz)	QuasiPeak (dB μ V)	Average (dB μ V)	Limit (dB μ V)	Margin (dB)	Bandwidth (kHz)	Line	Corr. (dB)
1.429391	---	24.21	46.00	21.79	9.000	N	10.9
1.643618	34.46	---	56.00	21.54	9.000	N	10.9
1.996537	---	25.60	46.00	20.40	9.000	N	10.9
2.109133	34.97	---	56.00	21.03	9.000	N	10.9
2.844905	---	26.58	46.00	19.42	9.000	N	10.9
3.455764	37.42	---	56.00	18.58	9.000	N	10.9
4.779012	37.48	---	56.00	18.52	9.000	N	10.8
4.875311	---	26.35	46.00	19.65	9.000	N	10.8
14.461183	48.19	---	60.00	11.81	9.000	N	10.9
14.461183	---	33.07	50.00	16.93	9.000	N	10.9
15.049855	---	33.46	50.00	16.54	9.000	N	10.9
15.125104	49.34	---	60.00	10.66	9.000	N	10.9

5.2 Radiation Spurious Emissions

Serial Number:	2FY2-1	Test Date:	Below 1GHz: 2024/1/14 Above 1GHz: 2024/1/29~2024/2/2
Test Site:	Chamber 10m, Chamber B	Test Mode:	Transmitting
Tester:	Zoo Zou, Colin Yang, Bill Yang	Test Result:	Pass

Environmental Conditions:

Temperature: (°C)	18~22.8	Relative Humidity: (%)	40~65	ATM Pressure: (kPa)	101.1~102.2
----------------------	---------	------------------------------	-------	------------------------	-------------

Test Equipment List and Details:

Manufacturer	Description	Model	Serial Number	Calibration Date	Calibration Due Date
9kHz~1000MHz					
EMCO	Passive Loop Antenna	6512	9706-1206	2023/10/21	2024/10/20
Sunol Sciences	Hybrid Antenna	JB3	A060611-1	2023/9/6	2024/9/5
Narda	Attenuator	779-6dB	04269	2023/9/6	2024/9/5
Unknown	Coaxial Cable	C-NJNJ-50	C-1000-01	2023/8/1	2024/7/31
Unknown	Coaxial Cable	C-NJNJ-50	C-0400-04	2023/8/1	2024/7/31
Unknown	Coaxial Cable	C-NJNJ-50	C-0530-01	2023/8/1	2024/7/31
Sonoma	Amplifier	310N	185914	2023/8/1	2024/7/31
R&S	EMI Test Receiver	ESCI	100224	2023/8/18	2024/8/17
Farad	Test Software	EZ-EMC	V1.1.4.2	N/A	N/A
Above 1GHz					
ETS-Lindgren	Horn Antenna	3115	000 527 35	2023/9/7	2024/9/6
Ducommun Technologies	Horn Antenna	ARH-4223-02	1007726-02 1304	2023/2/22	2026/2/21
Ducommun Technologies	Horn Antenna	ARH-2823-02	1007726-01 1302	2023/2/22	2026/2/21
Xinhang Macrowave	Coaxial Cable	XH750A-N/J-SMA/J-10M	20231117004 #0001	2023/11/17	2024/11/16
Xinhang Macrowave	Coaxial Cable	XH360A-2.92/J-2.92/J-6M-A	20231208001 #0001	2023/12/11	2024/12/10
AH	Preamplifier	PAM-0118P	469	2023/8/19	2024/8/18
AH	Preamplifier	PAM-1840VH	191	2023/9/7	2024/9/6
Agilent	Spectrum Analyzer	E4440A	MY44303352	2023/10/18	2024/10/17
R&S	Spectrum Analyzer	FSV40	101944	2023/10/18	2024/10/17
Sinoscite	Band Rejection Filter	BSF5150-5850MN	0899003	2023/6/16	2024/6/15
Mini-Circuits	High-Pass Filter	VHF-6010+	31118	2023/12/1	2024/11/30
Audix	Test Software	E3	191218 (V9)	N/A	N/A

* Statement of Traceability: Bay Area Compliance Laboratories Corp. (Dongguan) attests that all calibrations have been performed, traceable to National Primary Standards and International System of Units (SI).

Test Data:

Please refer to the below table and plots.

After pre-scan in the X, Y and Z axes of orientation, the worst case is below:

1) 9kHz~30MHz

The amplitude of spurious emissions attenuated more than 20 dB below the permissible value is not required to be report.

1) 30MHz-1GHz

Project No: DG2231229-79269E-RF
 Test Engineer: Zoo Zou
 Test Date: 2024-1-14
 Polarization: Horizontal
 Test Mode: Transmitting(802.11n ht20 MIMO 5200MHz)
 Power Source: AC 120V/60Hz

80.0 dBuV/m

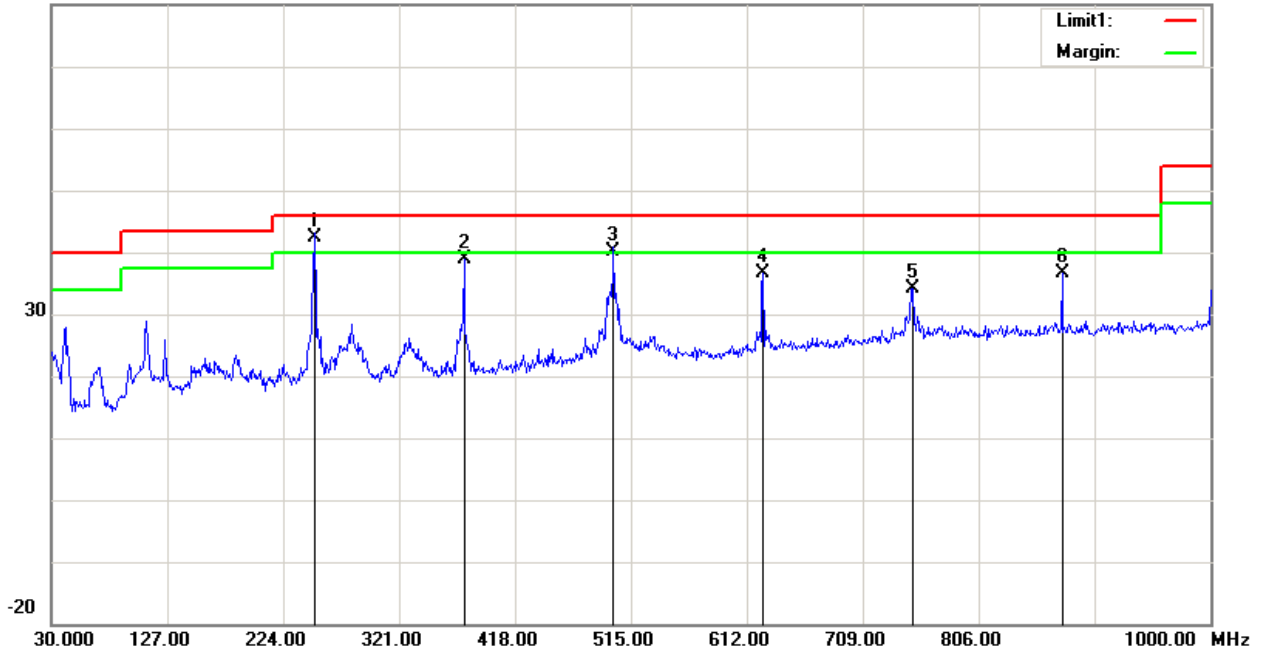

No.	Frequency (MHz)	Reading (dBuV)	Detector	Factor (dB/m)	Result (dBuV/m)	Limit (dBuV/m)	Margin (dB)
1	250.1900	53.83	QP	-11.43	42.40	46.00	3.60
2	375.3200	46.77	peak	-7.89	38.88	46.00	7.12
3	500.4500	44.38	QP	-4.28	40.10	46.00	5.90
4	625.5800	38.86	peak	-2.24	36.62	46.00	9.38
5	750.7100	34.55	peak	-0.31	34.24	46.00	11.76
6	875.8400	35.34	peak	1.18	36.52	46.00	9.48

Project No: DG2231229-79269E-RF
 Test Engineer: Zoo Zou
 Test Date: 2024-1-14
 Polarization: Vertical
 Test Mode: Transmitting(802.11n ht20 MIMO 5200MHz)
 Power Source: AC 120V/60Hz

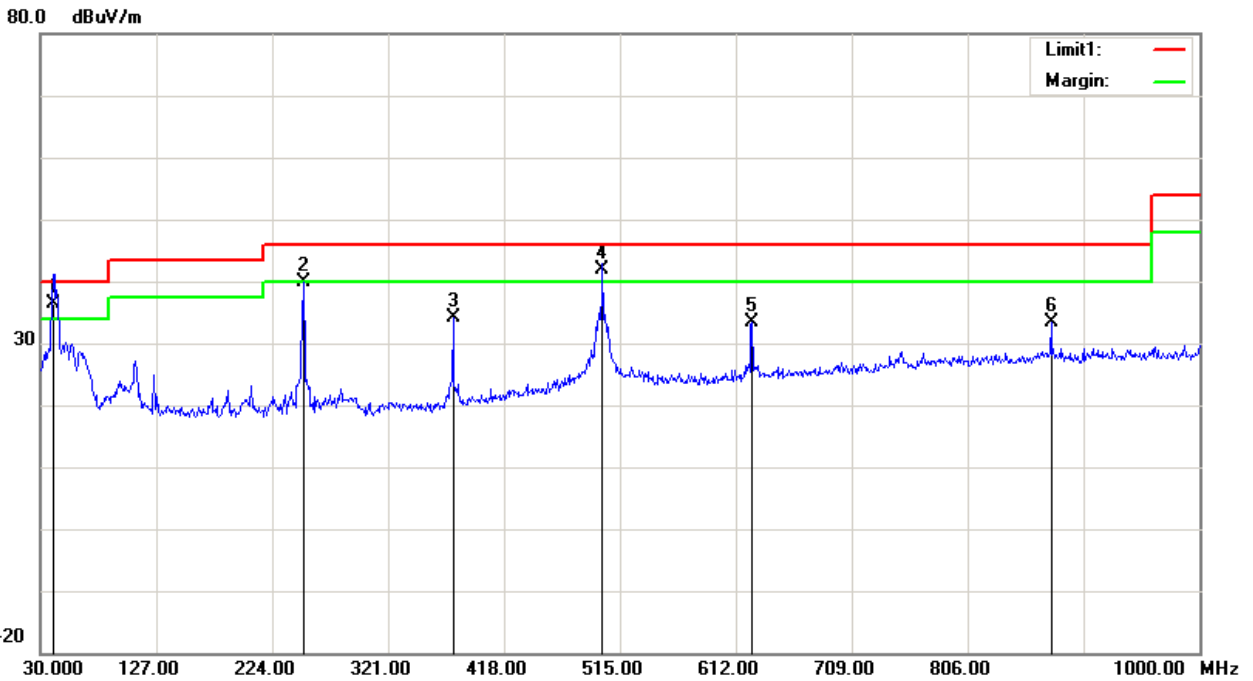

No.	Frequency (MHz)	Reading (dBuV)	Detector	Factor (dB/m)	Result (dBuV/m)	Limit (dBuV/m)	Margin (dB)
1	40.6700	47.87	QP	-11.37	36.50	40.00	3.50
2	250.1900	51.32	peak	-11.43	39.89	46.00	6.11
3	375.3200	42.09	peak	-7.89	34.20	46.00	11.80
4	500.4500	46.18	QP	-4.28	41.90	46.00	4.10
5	625.5800	35.59	peak	-2.24	33.35	46.00	12.65
6	875.8400	32.14	peak	1.18	33.32	46.00	12.68

**3) 1-18GHz:
5150-5250MHz (Chain 0):**

802.11a mode, Low Channel, Horizontal		802.11a mode, Low Channel, Vertical																																																																																																																	
<p>Project No.: DG2231229-79269E-RF Serial No.: 2FY2-1 Polarization: Horizontal Tester: Colin Yang Test Mode: Transmitting Note: 802.11a_U-NII-1_low channel 5180MHz Chain 0</p> <p style="text-align: right;">Date: 2024-01-31</p>		<p>Project No.: DG2231229-79269E-RF Serial No.: 2FY2-1 Polarization: Vertical Tester: Colin Yang Test Mode: Transmitting Note: 802.11a_U-NII-1_low channel 5180MHz Chain 0</p> <p style="text-align: right;">Date: 2024-01-31</p>																																																																																																																	
<table border="1"> <thead> <tr> <th>No.</th> <th>Frequency (MHz)</th> <th>Reading (dBuV)</th> <th>Factor (dB/m)</th> <th>Result (dBuV/m)</th> <th>Limit (dBuV/m)</th> <th>Margin (dB)</th> <th>Detector</th> </tr> </thead> <tbody> <tr> <td>1</td> <td>4928.79</td> <td>40.02</td> <td>-2.51</td> <td>37.51</td> <td>54.00</td> <td>16.49</td> <td>Average</td> </tr> <tr> <td>2</td> <td>4928.79</td> <td>50.25</td> <td>-2.51</td> <td>47.74</td> <td>74.00</td> <td>26.26</td> <td>Peak</td> </tr> </tbody> </table>		No.	Frequency (MHz)	Reading (dBuV)	Factor (dB/m)	Result (dBuV/m)	Limit (dBuV/m)	Margin (dB)	Detector	1	4928.79	40.02	-2.51	37.51	54.00	16.49	Average	2	4928.79	50.25	-2.51	47.74	74.00	26.26	Peak	<table border="1"> <thead> <tr> <th>No.</th> <th>Frequency (MHz)</th> <th>Reading (dBuV)</th> <th>Factor (dB/m)</th> <th>Result (dBuV/m)</th> <th>Limit (dBuV/m)</th> <th>Margin (dB)</th> <th>Detector</th> </tr> </thead> <tbody> <tr> <td>1</td> <td>4894.78</td> <td>42.12</td> <td>-2.66</td> <td>39.46</td> <td>54.00</td> <td>14.54</td> <td>Average</td> </tr> <tr> <td>2</td> <td>4894.78</td> <td>53.33</td> <td>-2.66</td> <td>50.67</td> <td>74.00</td> <td>23.33</td> <td>Peak</td> </tr> </tbody> </table>		No.	Frequency (MHz)	Reading (dBuV)	Factor (dB/m)	Result (dBuV/m)	Limit (dBuV/m)	Margin (dB)	Detector	1	4894.78	42.12	-2.66	39.46	54.00	14.54	Average	2	4894.78	53.33	-2.66	50.67	74.00	23.33	Peak																																																																
No.	Frequency (MHz)	Reading (dBuV)	Factor (dB/m)	Result (dBuV/m)	Limit (dBuV/m)	Margin (dB)	Detector																																																																																																												
1	4928.79	40.02	-2.51	37.51	54.00	16.49	Average																																																																																																												
2	4928.79	50.25	-2.51	47.74	74.00	26.26	Peak																																																																																																												
No.	Frequency (MHz)	Reading (dBuV)	Factor (dB/m)	Result (dBuV/m)	Limit (dBuV/m)	Margin (dB)	Detector																																																																																																												
1	4894.78	42.12	-2.66	39.46	54.00	14.54	Average																																																																																																												
2	4894.78	53.33	-2.66	50.67	74.00	23.33	Peak																																																																																																												
<p>Project No.: DG2231229-79269E-RF Serial No.: 2FY2-1 Polarization: Horizontal Tester: Bill Yang Test Mode: Transmitting Note: 802.11a_U-NII-1_Low channel 5180MHz Chain 0</p> <p style="text-align: right;">Date: 2024-01-30</p>		<p>Project No.: DG2231229-79269E-RF Serial No.: 2FY2-1 Polarization: Vertical Tester: Bill Yang Test Mode: Transmitting Note: 802.11a_U-NII-1_Low channel 5180MHz Chain 0</p> <p style="text-align: right;">Date: 2024-01-30</p>																																																																																																																	
<table border="1"> <thead> <tr> <th>No.</th> <th>Frequency (MHz)</th> <th>Reading (dBuV)</th> <th>Factor (dB/m)</th> <th>Result (dBuV/m)</th> <th>Limit (dBuV/m)</th> <th>Margin (dB)</th> <th>Detector</th> </tr> </thead> <tbody> <tr> <td>1</td> <td>10360.00</td> <td>53.78</td> <td>6.49</td> <td>60.27</td> <td>68.20</td> <td>7.93</td> <td>Peak</td> </tr> <tr> <td>2</td> <td>15540.00</td> <td>44.91</td> <td>4.67</td> <td>49.58</td> <td>54.00</td> <td>4.42</td> <td>Average</td> </tr> <tr> <td>3</td> <td>15540.00</td> <td>53.93</td> <td>4.67</td> <td>58.60</td> <td>74.00</td> <td>15.40</td> <td>Peak</td> </tr> <tr> <td>4</td> <td>17450.29</td> <td>43.25</td> <td>15.48</td> <td>58.73</td> <td>68.20</td> <td>9.47</td> <td>Peak</td> </tr> <tr> <td>5</td> <td>17747.95</td> <td>27.13</td> <td>16.94</td> <td>44.07</td> <td>54.00</td> <td>9.93</td> <td>Average</td> </tr> <tr> <td>6</td> <td>17747.95</td> <td>39.17</td> <td>16.94</td> <td>56.11</td> <td>74.00</td> <td>17.89</td> <td>Peak</td> </tr> </tbody> </table>		No.	Frequency (MHz)	Reading (dBuV)	Factor (dB/m)	Result (dBuV/m)	Limit (dBuV/m)	Margin (dB)	Detector	1	10360.00	53.78	6.49	60.27	68.20	7.93	Peak	2	15540.00	44.91	4.67	49.58	54.00	4.42	Average	3	15540.00	53.93	4.67	58.60	74.00	15.40	Peak	4	17450.29	43.25	15.48	58.73	68.20	9.47	Peak	5	17747.95	27.13	16.94	44.07	54.00	9.93	Average	6	17747.95	39.17	16.94	56.11	74.00	17.89	Peak	<table border="1"> <thead> <tr> <th>No.</th> <th>Frequency (MHz)</th> <th>Reading (dBuV)</th> <th>Factor (dB/m)</th> <th>Result (dBuV/m)</th> <th>Limit (dBuV/m)</th> <th>Margin (dB)</th> <th>Detector</th> </tr> </thead> <tbody> <tr> <td>1</td> <td>10360.00</td> <td>50.34</td> <td>6.49</td> <td>56.83</td> <td>68.20</td> <td>11.37</td> <td>Peak</td> </tr> <tr> <td>2</td> <td>15540.00</td> <td>35.85</td> <td>4.67</td> <td>40.52</td> <td>54.00</td> <td>13.48</td> <td>Average</td> </tr> <tr> <td>3</td> <td>15540.00</td> <td>45.86</td> <td>4.67</td> <td>50.53</td> <td>74.00</td> <td>23.47</td> <td>Peak</td> </tr> <tr> <td>4</td> <td>17342.27</td> <td>44.27</td> <td>14.60</td> <td>58.87</td> <td>68.20</td> <td>9.33</td> <td>Peak</td> </tr> <tr> <td>5</td> <td>17757.55</td> <td>27.96</td> <td>17.00</td> <td>44.96</td> <td>54.00</td> <td>9.04</td> <td>Average</td> </tr> <tr> <td>6</td> <td>17757.55</td> <td>38.19</td> <td>17.00</td> <td>55.19</td> <td>74.00</td> <td>18.81</td> <td>Peak</td> </tr> </tbody> </table>		No.	Frequency (MHz)	Reading (dBuV)	Factor (dB/m)	Result (dBuV/m)	Limit (dBuV/m)	Margin (dB)	Detector	1	10360.00	50.34	6.49	56.83	68.20	11.37	Peak	2	15540.00	35.85	4.67	40.52	54.00	13.48	Average	3	15540.00	45.86	4.67	50.53	74.00	23.47	Peak	4	17342.27	44.27	14.60	58.87	68.20	9.33	Peak	5	17757.55	27.96	17.00	44.96	54.00	9.04	Average	6	17757.55	38.19	17.00	55.19	74.00	18.81	Peak
No.	Frequency (MHz)	Reading (dBuV)	Factor (dB/m)	Result (dBuV/m)	Limit (dBuV/m)	Margin (dB)	Detector																																																																																																												
1	10360.00	53.78	6.49	60.27	68.20	7.93	Peak																																																																																																												
2	15540.00	44.91	4.67	49.58	54.00	4.42	Average																																																																																																												
3	15540.00	53.93	4.67	58.60	74.00	15.40	Peak																																																																																																												
4	17450.29	43.25	15.48	58.73	68.20	9.47	Peak																																																																																																												
5	17747.95	27.13	16.94	44.07	54.00	9.93	Average																																																																																																												
6	17747.95	39.17	16.94	56.11	74.00	17.89	Peak																																																																																																												
No.	Frequency (MHz)	Reading (dBuV)	Factor (dB/m)	Result (dBuV/m)	Limit (dBuV/m)	Margin (dB)	Detector																																																																																																												
1	10360.00	50.34	6.49	56.83	68.20	11.37	Peak																																																																																																												
2	15540.00	35.85	4.67	40.52	54.00	13.48	Average																																																																																																												
3	15540.00	45.86	4.67	50.53	74.00	23.47	Peak																																																																																																												
4	17342.27	44.27	14.60	58.87	68.20	9.33	Peak																																																																																																												
5	17757.55	27.96	17.00	44.96	54.00	9.04	Average																																																																																																												
6	17757.55	38.19	17.00	55.19	74.00	18.81	Peak																																																																																																												

802.11a mode, Low Channel, Bandedge, Horizontal

Project No.: DG2231229-79269E-RF Serial No.: 2FY2-1
 Polarization: Horizontal Tester: Colin Yang
 Test Mode: Transmitting
 Note: 802.11a_U-NII-1_low channel 5180MHz Chain 0

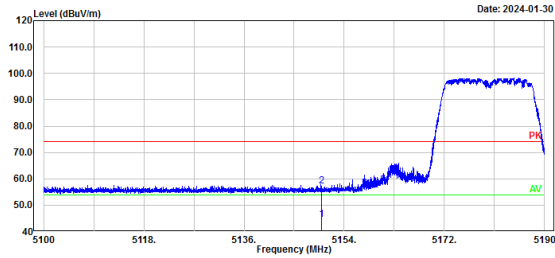

No.	Frequency (MHz)	Reading (dBμV)	Factor (dB/m)	Result (dBμV/m)	Limit (dBμV/m)	Margin (dB)	Detector
1	5150.00	15.99	28.68	44.67	54.00	9.33	Average
2	5150.00	28.49	28.68	57.17	74.00	16.83	Peak

802.11a mode, Low Channel, Bandedge, Vertical

Project No.: DG2231229-79269E-RF Serial No.: 2FY2-1
 Polarization: Vertical Tester: Colin Yang
 Test Mode: Transmitting
 Note: 802.11a_U-NII-1_low channel 5180MHz Chain 0

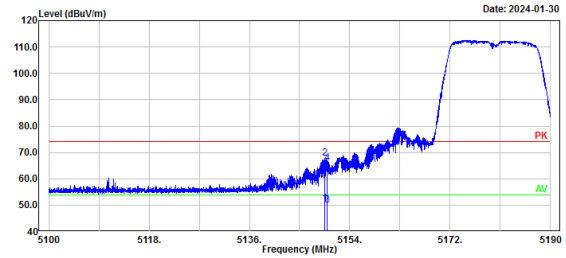

No.	Frequency (MHz)	Reading (dBμV)	Factor (dB/m)	Result (dBμV/m)	Limit (dBμV/m)	Margin (dB)	Detector
1	5149.44	21.84	28.68	50.52	54.00	3.48	Average
2	5149.44	38.98	28.68	67.66	74.00	6.34	Peak
3	5150.00	21.36	28.68	50.04	54.00	3.96	Average
4	5150.00	37.33	28.68	66.01	74.00	7.99	Peak

802.11a mode, Middle Channel, Horizontal

Project No.: DG2231229-79269E-RF Serial No.: 2FY2-1
 Polarization: Horizontal Tester: Colin Yang
 Test Mode: Transmitting
 Note: 802.11a_U-NII-1_middle channel 5200MHz Chain 0

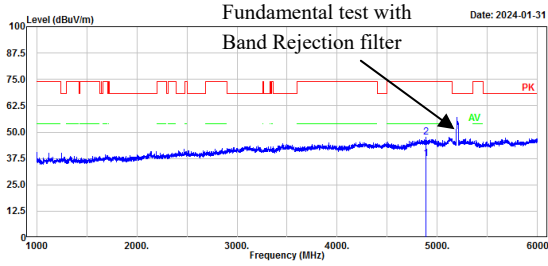

No.	Frequency (MHz)	Reading (dBuV)	Factor (dB/m)	Result (dBuV/m)	Limit (dBuV/m)	Margin (dB)	Detector
1	4882.78	40.12	-2.71	37.41	54.00	16.59	Average
2	4882.78	50.42	-2.71	47.71	74.00	26.29	Peak

802.11a mode, Middle Channel, Vertical

Project No.: DG2231229-79269E-RF Serial No.: 2FY2-1
 Polarization: Vertical Tester: Colin Yang
 Test Mode: Transmitting
 Note: 802.11a_U-NII-1_middle channel 5200MHz Chain 0

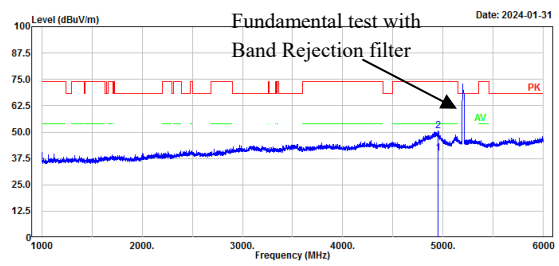

No.	Frequency (MHz)	Reading (dBuV)	Factor (dB/m)	Result (dBuV/m)	Limit (dBuV/m)	Margin (dB)	Detector
1	4948.79	42.35	-2.41	39.94	54.00	14.06	Average
2	4948.79	52.97	-2.41	50.56	74.00	23.44	Peak

Project No.: DG2231229-79269E-RF Serial No.: 2FY2-1
 Polarization: Horizontal Tester: Bill Yang
 Test Mode: Transmitting
 Note: 802.11a_U-NII-1_Middle channel 5200MHz Chain 0

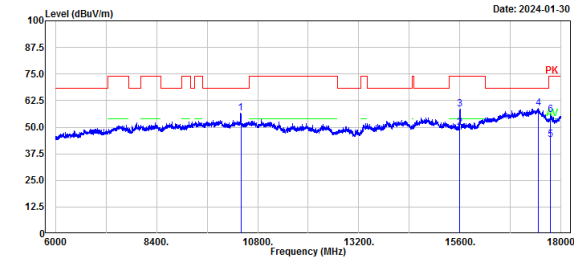

No.	Frequency (MHz)	Reading (dBuV)	Factor (dB/m)	Result (dBuV/m)	Limit (dBuV/m)	Margin (dB)	Detector
1	10400.00	50.22	6.44	56.66	68.20	11.54	Peak
2	15600.00	44.97	4.77	49.74	54.00	4.26	Average
3	15600.00	53.62	4.77	58.39	74.00	15.61	Peak
4	17457.49	43.29	15.53	58.82	68.20	9.38	Peak
5	17740.75	27.38	16.90	44.28	54.00	9.72	Average
6	17740.75	38.89	16.90	55.79	74.00	18.21	Peak

Project No.: DG2231229-79269E-RF Serial No.: 2FY2-1
 Polarization: Vertical Tester: Bill Yang
 Test Mode: Transmitting
 Note: 802.11a_U-NII-1_Middle channel 5200MHz Chain 0

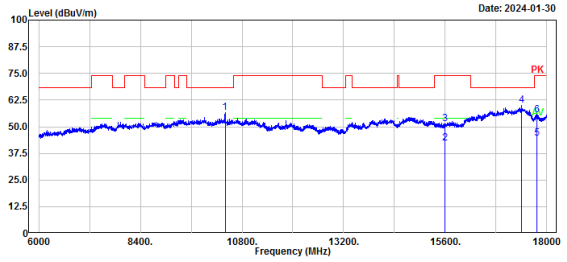

No.	Frequency (MHz)	Reading (dBuV)	Factor (dB/m)	Result (dBuV/m)	Limit (dBuV/m)	Margin (dB)	Detector
1	10400.08	50.04	6.44	56.48	68.20	11.72	Peak
2	15600.00	37.62	4.77	42.39	54.00	11.61	Average
3	15600.00	46.50	4.77	51.27	74.00	22.73	Peak
4	17397.48	44.77	15.06	59.83	68.20	8.37	Peak
5	17759.95	27.36	17.00	44.36	54.00	9.64	Average
6	17759.95	38.66	17.00	55.66	74.00	18.34	Peak

802.11a mode, High Channel, Horizontal

Project No.: DG2231229-79269E-RF Serial No.: 2FY2-1
 Polarization: Horizontal Tester: Colin Yang
 Test Mode: Transmitting
 Note: 802.11a_U-NII-1_high channel 5240MHz Chain 0

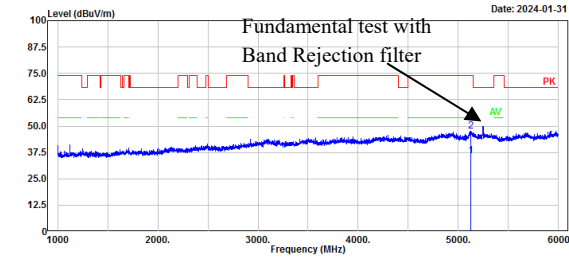

No.	Frequency (MHz)	Reading (dBuV)	Factor (dB/m)	Result (dBuV/m)	Limit (dBuV/m)	Margin (dB)	Detector
1	5126.83	37.11	-1.30	35.81	54.00	18.19	Average
2	5126.83	48.83	-1.30	47.53	74.00	26.47	Peak

802.11a mode, High Channel, Vertical

Project No.: DG2231229-79269E-RF Serial No.: 2FY2-1
 Polarization: Vertical Tester: Colin Yang
 Test Mode: Transmitting
 Note: 802.11a_U-NII-1_high channel 5240MHz Chain 0

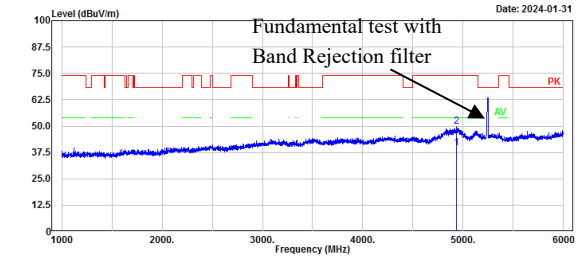

No.	Frequency (MHz)	Reading (dBuV)	Factor (dB/m)	Result (dBuV/m)	Limit (dBuV/m)	Margin (dB)	Detector
1	4933.79	42.18	-2.48	39.70	54.00	14.30	Average
2	4933.79	52.42	-2.48	49.94	74.00	24.06	Peak

Project No.: DG2231229-79269E-RF Serial No.: 2FY2-1
 Polarization: Horizontal Tester: Bill Yang
 Test Mode: Transmitting
 Note: 802.11a_U-NII-1_High channel 5240MHz Chain 0

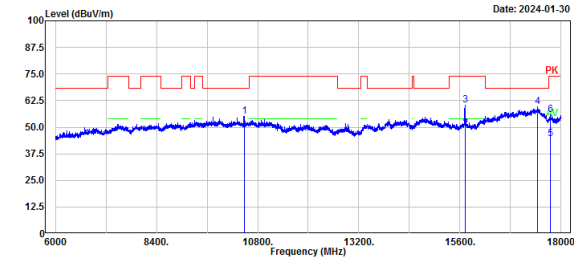

No.	Frequency (MHz)	Reading (dBuV)	Factor (dB/m)	Result (dBuV/m)	Limit (dBuV/m)	Margin (dB)	Detector
1	10480.00	48.49	6.60	55.09	68.20	13.11	Peak
2	15720.00	44.53	5.05	49.58	54.00	4.42	Average
3	15720.00	55.25	5.05	60.30	74.00	13.70	Peak
4	17447.89	44.05	15.45	59.50	68.20	8.70	Peak
5	17750.35	27.74	16.95	44.69	54.00	9.31	Average
6	17750.35	38.79	16.95	55.74	74.00	18.26	Peak

Project No.: DG2231229-79269E-RF Serial No.: 2FY2-1
 Polarization: Vertical Tester: Bill Yang
 Test Mode: Transmitting
 Note: 802.11a_U-NII-1_High channel 5240MHz Chain 0

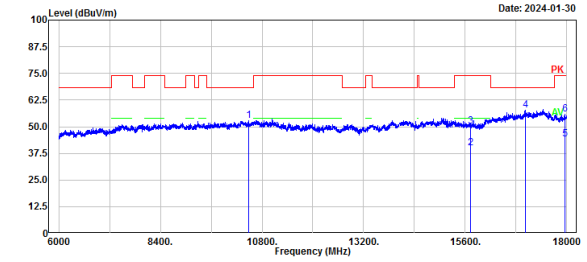

No.	Frequency (MHz)	Reading (dBuV)	Factor (dB/m)	Result (dBuV/m)	Limit (dBuV/m)	Margin (dB)	Detector
1	10480.00	46.10	6.60	52.70	68.20	15.50	Peak
2	15720.00	34.89	5.05	39.94	54.00	14.06	Average
3	15720.00	45.22	5.05	50.27	74.00	23.73	Peak
4	17020.60	45.83	12.09	57.92	68.20	10.28	Peak
5	17949.59	26.14	17.96	44.10	54.00	9.90	Average
6	17949.59	37.93	17.96	55.89	74.00	18.11	Peak

802.11a mode, High Channel, Bandedge, Horizontal

Project No.: DG2231229-79269E-RF Serial No.: 2FY2-1
 Polarization: Horizontal Tester: Colin Yang
 Test Mode: Transmitting
 Note: 802.11a_U-NII-1_high channel 5240MHz Chain 0

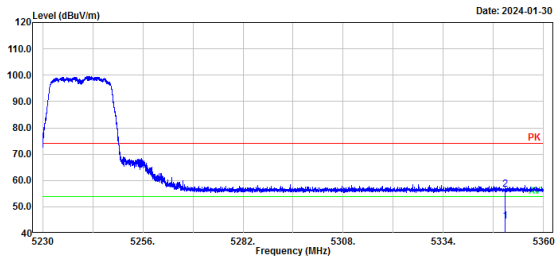

No.	Frequency (MHz)	Reading (dBuV)	Factor (dB/m)	Result (dBuV/m)	Limit (dBuV/m)	Margin (dB)	Detector
1	5350.00	15.24	29.16	44.40	54.00	9.60	Average
2	5350.00	27.54	29.16	56.70	74.00	17.30	Peak

802.11a mode, High Channel, Bandedge, Vertical

Project No.: DG2231229-79269E-RF Serial No.: 2FY2-1
 Polarization: Vertical Tester: Colin Yang
 Test Mode: Transmitting
 Note: 802.11a_U-NII-1_high channel 5240MHz Chain 0

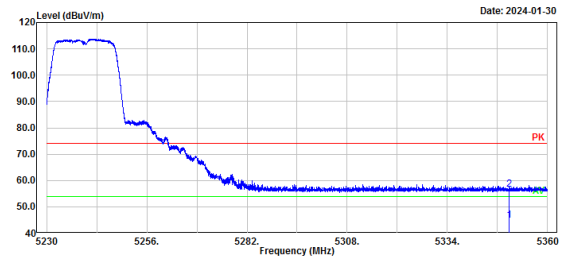

No.	Frequency (MHz)	Reading (dBuV)	Factor (dB/m)	Result (dBuV/m)	Limit (dBuV/m)	Margin (dB)	Detector
1	5350.00	15.54	29.16	44.70	54.00	9.30	Average
2	5350.00	27.54	29.16	56.70	74.00	17.30	Peak

Chain 1:

802.11a mode, Low Channel, Horizontal		802.11a mode, Low Channel, Vertical																																																																																																																	
Project No.: DG2231229-79269E-RF Serial No.: 2FY2-1 Polarization: Horizontal Tester: Colin Yang Test Mode: Transmitting Note: 802.11a_U-NII-1_low channel 5180MHz Chain 1 Date: 2024-01-31 		Project No.: DG2231229-79269E-RF Serial No.: 2FY2-1 Polarization: Vertical Tester: Colin Yang Test Mode: Transmitting Note: 802.11a_U-NII-1_low channel 5180MHz Chain 1 Date: 2024-01-31 																																																																																																																	
<table border="1"> <thead> <tr> <th>No.</th> <th>Frequency (MHz)</th> <th>Reading (dBuV)</th> <th>Factor (dB/m)</th> <th>Result (dBuV/m)</th> <th>Limit (dBuV/m)</th> <th>Margin (dB)</th> <th>Detector</th> </tr> </thead> <tbody> <tr> <td>1</td> <td>5122.83</td> <td>39.02</td> <td>-1.34</td> <td>37.68</td> <td>54.00</td> <td>16.32</td> <td>Average</td> </tr> <tr> <td>2</td> <td>5122.83</td> <td>48.88</td> <td>-1.34</td> <td>47.54</td> <td>74.00</td> <td>26.46</td> <td>Peak</td> </tr> </tbody> </table>		No.	Frequency (MHz)	Reading (dBuV)	Factor (dB/m)	Result (dBuV/m)	Limit (dBuV/m)	Margin (dB)	Detector	1	5122.83	39.02	-1.34	37.68	54.00	16.32	Average	2	5122.83	48.88	-1.34	47.54	74.00	26.46	Peak	<table border="1"> <thead> <tr> <th>No.</th> <th>Frequency (MHz)</th> <th>Reading (dBuV)</th> <th>Factor (dB/m)</th> <th>Result (dBuV/m)</th> <th>Limit (dBuV/m)</th> <th>Margin (dB)</th> <th>Detector</th> </tr> </thead> <tbody> <tr> <td>1</td> <td>4926.79</td> <td>42.31</td> <td>-2.52</td> <td>39.79</td> <td>54.00</td> <td>14.21</td> <td>Average</td> </tr> <tr> <td>2</td> <td>4926.79</td> <td>52.52</td> <td>-2.52</td> <td>50.00</td> <td>74.00</td> <td>24.00</td> <td>Peak</td> </tr> </tbody> </table>		No.	Frequency (MHz)	Reading (dBuV)	Factor (dB/m)	Result (dBuV/m)	Limit (dBuV/m)	Margin (dB)	Detector	1	4926.79	42.31	-2.52	39.79	54.00	14.21	Average	2	4926.79	52.52	-2.52	50.00	74.00	24.00	Peak																																																																
No.	Frequency (MHz)	Reading (dBuV)	Factor (dB/m)	Result (dBuV/m)	Limit (dBuV/m)	Margin (dB)	Detector																																																																																																												
1	5122.83	39.02	-1.34	37.68	54.00	16.32	Average																																																																																																												
2	5122.83	48.88	-1.34	47.54	74.00	26.46	Peak																																																																																																												
No.	Frequency (MHz)	Reading (dBuV)	Factor (dB/m)	Result (dBuV/m)	Limit (dBuV/m)	Margin (dB)	Detector																																																																																																												
1	4926.79	42.31	-2.52	39.79	54.00	14.21	Average																																																																																																												
2	4926.79	52.52	-2.52	50.00	74.00	24.00	Peak																																																																																																												
Project No.: DG2231229-79269E-RF Serial No.: 2FY2-1 Polarization: Horizontal Tester: Bill Yang Test Mode: Transmitting Note: 802.11a_U-NII-1_low channel 5180MHz Chain 1 Date: 2024-01-30 		Project No.: DG2231229-79269E-RF Serial No.: 2FY2-1 Polarization: Vertical Tester: Bill Yang Test Mode: Transmitting Note: 802.11a_U-NII-1_low channel 5180MHz Chain 1 Date: 2024-01-30 																																																																																																																	
<table border="1"> <thead> <tr> <th>No.</th> <th>Frequency (MHz)</th> <th>Reading (dBuV)</th> <th>Factor (dB/m)</th> <th>Result (dBuV/m)</th> <th>Limit (dBuV/m)</th> <th>Margin (dB)</th> <th>Detector</th> </tr> </thead> <tbody> <tr> <td>1</td> <td>10360.00</td> <td>53.66</td> <td>6.49</td> <td>60.15</td> <td>68.20</td> <td>8.05</td> <td>Peak</td> </tr> <tr> <td>2</td> <td>15540.00</td> <td>43.25</td> <td>4.67</td> <td>47.92</td> <td>54.00</td> <td>6.08</td> <td>Average</td> </tr> <tr> <td>3</td> <td>15540.00</td> <td>52.85</td> <td>4.67</td> <td>57.52</td> <td>74.00</td> <td>16.48</td> <td>Peak</td> </tr> <tr> <td>4</td> <td>17483.90</td> <td>43.33</td> <td>15.74</td> <td>59.07</td> <td>68.20</td> <td>9.13</td> <td>Peak</td> </tr> <tr> <td>5</td> <td>17762.35</td> <td>28.09</td> <td>17.03</td> <td>45.12</td> <td>54.00</td> <td>8.88</td> <td>Average</td> </tr> <tr> <td>6</td> <td>17762.35</td> <td>39.01</td> <td>17.03</td> <td>56.04</td> <td>74.00</td> <td>17.96</td> <td>Peak</td> </tr> </tbody> </table>		No.	Frequency (MHz)	Reading (dBuV)	Factor (dB/m)	Result (dBuV/m)	Limit (dBuV/m)	Margin (dB)	Detector	1	10360.00	53.66	6.49	60.15	68.20	8.05	Peak	2	15540.00	43.25	4.67	47.92	54.00	6.08	Average	3	15540.00	52.85	4.67	57.52	74.00	16.48	Peak	4	17483.90	43.33	15.74	59.07	68.20	9.13	Peak	5	17762.35	28.09	17.03	45.12	54.00	8.88	Average	6	17762.35	39.01	17.03	56.04	74.00	17.96	Peak	<table border="1"> <thead> <tr> <th>No.</th> <th>Frequency (MHz)</th> <th>Reading (dBuV)</th> <th>Factor (dB/m)</th> <th>Result (dBuV/m)</th> <th>Limit (dBuV/m)</th> <th>Margin (dB)</th> <th>Detector</th> </tr> </thead> <tbody> <tr> <td>1</td> <td>10360.00</td> <td>52.32</td> <td>6.49</td> <td>58.81</td> <td>68.20</td> <td>9.39</td> <td>Peak</td> </tr> <tr> <td>2</td> <td>15540.00</td> <td>35.22</td> <td>4.67</td> <td>39.89</td> <td>54.00</td> <td>14.11</td> <td>Average</td> </tr> <tr> <td>3</td> <td>15540.00</td> <td>45.73</td> <td>4.67</td> <td>50.40</td> <td>74.00</td> <td>23.60</td> <td>Peak</td> </tr> <tr> <td>4</td> <td>17354.27</td> <td>44.34</td> <td>14.70</td> <td>59.04</td> <td>68.20</td> <td>9.16</td> <td>Peak</td> </tr> <tr> <td>5</td> <td>17755.15</td> <td>28.76</td> <td>16.98</td> <td>45.74</td> <td>54.00</td> <td>8.26</td> <td>Average</td> </tr> <tr> <td>6</td> <td>17755.15</td> <td>39.30</td> <td>16.98</td> <td>56.28</td> <td>74.00</td> <td>17.72</td> <td>Peak</td> </tr> </tbody> </table>		No.	Frequency (MHz)	Reading (dBuV)	Factor (dB/m)	Result (dBuV/m)	Limit (dBuV/m)	Margin (dB)	Detector	1	10360.00	52.32	6.49	58.81	68.20	9.39	Peak	2	15540.00	35.22	4.67	39.89	54.00	14.11	Average	3	15540.00	45.73	4.67	50.40	74.00	23.60	Peak	4	17354.27	44.34	14.70	59.04	68.20	9.16	Peak	5	17755.15	28.76	16.98	45.74	54.00	8.26	Average	6	17755.15	39.30	16.98	56.28	74.00	17.72	Peak
No.	Frequency (MHz)	Reading (dBuV)	Factor (dB/m)	Result (dBuV/m)	Limit (dBuV/m)	Margin (dB)	Detector																																																																																																												
1	10360.00	53.66	6.49	60.15	68.20	8.05	Peak																																																																																																												
2	15540.00	43.25	4.67	47.92	54.00	6.08	Average																																																																																																												
3	15540.00	52.85	4.67	57.52	74.00	16.48	Peak																																																																																																												
4	17483.90	43.33	15.74	59.07	68.20	9.13	Peak																																																																																																												
5	17762.35	28.09	17.03	45.12	54.00	8.88	Average																																																																																																												
6	17762.35	39.01	17.03	56.04	74.00	17.96	Peak																																																																																																												
No.	Frequency (MHz)	Reading (dBuV)	Factor (dB/m)	Result (dBuV/m)	Limit (dBuV/m)	Margin (dB)	Detector																																																																																																												
1	10360.00	52.32	6.49	58.81	68.20	9.39	Peak																																																																																																												
2	15540.00	35.22	4.67	39.89	54.00	14.11	Average																																																																																																												
3	15540.00	45.73	4.67	50.40	74.00	23.60	Peak																																																																																																												
4	17354.27	44.34	14.70	59.04	68.20	9.16	Peak																																																																																																												
5	17755.15	28.76	16.98	45.74	54.00	8.26	Average																																																																																																												
6	17755.15	39.30	16.98	56.28	74.00	17.72	Peak																																																																																																												

802.11a mode, Low Channel, Bandedge, Horizontal

Project No.: DG2231229-79269E-RF Serial No.: 2FY2-1
 Polarization: Horizontal Tester: Colin Yang
 Test Mode: Transmitting
 Note: 802.11a_U-NII-1_low channel 5180MHz Chain 1

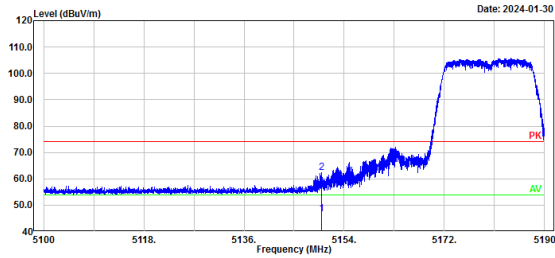

No.	Frequency (MHz)	Reading (dBμV)	Factor (dB/m)	Result (dBμV/m)	Limit (dBμV/m)	Margin (dB)	Detector
1	5150.00	18.07	28.68	46.75	54.00	7.25	Average
2	5150.00	33.79	28.68	62.47	74.00	11.53	Peak

802.11a mode, Low Channel, Bandedge, Vertical

Project No.: DG2231229-79269E-RF Serial No.: 2FY2-1
 Polarization: Vertical Tester: Colin Yang
 Test Mode: Transmitting
 Note: 802.11a_U-NII-1_low channel 5180MHz Chain 1

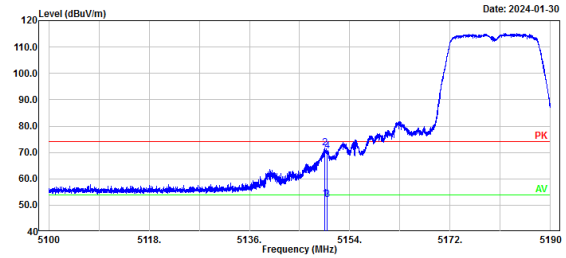

No.	Frequency (MHz)	Reading (dBμV)	Factor (dB/m)	Result (dBμV/m)	Limit (dBμV/m)	Margin (dB)	Detector
1	5149.49	23.68	28.68	52.36	54.00	1.64	Average
2	5149.49	43.10	28.68	71.78	74.00	2.22	Peak
3	5150.00	23.32	28.68	52.00	54.00	2.00	Average
4	5150.00	41.94	28.68	70.62	74.00	3.38	Peak

802.11a mode, Middle Channel, Horizontal

Project No.: DG2231229-79269E-RF Serial No.: 2FY2-1
 Polarization: Horizontal Tester: Colin Yang
 Test Mode: Transmitting
 Note: 802.11a_U-NII-1_middle channel 5200MHz Chain 1

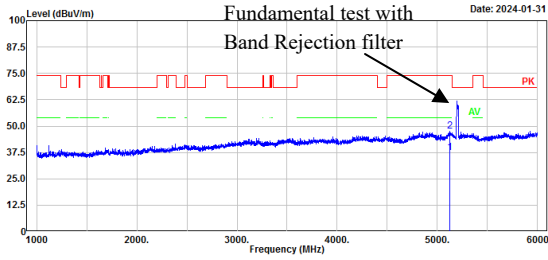

No.	Frequency (MHz)	Reading (dBuV)	Factor (dB/m)	Result (dBuV/m)	Limit (dBuV/m)	Margin (dB)	Detector
1	5122.83	38.62	-1.34	37.28	54.00	16.72	Average
2	5122.83	48.94	-1.34	47.60	74.00	26.40	Peak

802.11a mode, Middle Channel, Vertical

Project No.: DG2231229-79269E-RF Serial No.: 2FY2-1
 Polarization: Vertical Tester: Colin Yang
 Test Mode: Transmitting
 Note: 802.11a_U-NII-1_middle channel 5200MHz Chain 1

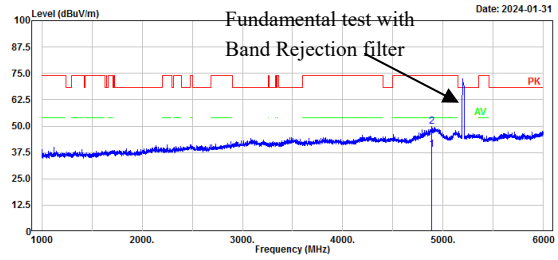

No.	Frequency (MHz)	Reading (dBuV)	Factor (dB/m)	Result (dBuV/m)	Limit (dBuV/m)	Margin (dB)	Detector
1	4882.78	41.57	-2.71	38.86	54.00	15.14	Average
2	4882.78	52.34	-2.71	49.63	74.00	24.37	Peak

Project No.: DG2231229-79269E-RF Serial No.: 2FY2-1
 Polarization: Horizontal Tester: Bill Yang
 Test Mode: Transmitting
 Note: 802.11a_U-NII-1_Middle channel 5200MHz Chain 1

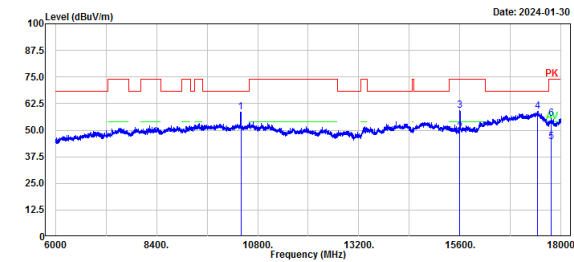

No.	Frequency (MHz)	Reading (dBuV)	Factor (dB/m)	Result (dBuV/m)	Limit (dBuV/m)	Margin (dB)	Detector
1	10400.00	52.08	6.44	58.52	68.20	9.68	Peak
2	15600.00	44.10	4.77	48.87	54.00	5.13	Average
3	15600.00	54.49	4.77	59.26	74.00	14.74	Peak
4	17438.29	43.60	15.38	58.98	68.20	9.22	Peak
5	17771.96	27.55	17.08	44.63	54.00	9.37	Average
6	17771.96	38.41	17.08	55.49	74.00	18.51	Peak

Project No.: DG2231229-79269E-RF Serial No.: 2FY2-1
 Polarization: Vertical Tester: Bill Yang
 Test Mode: Transmitting
 Note: 802.11a_U-NII-1_Middle channel 5200MHz Chain 1

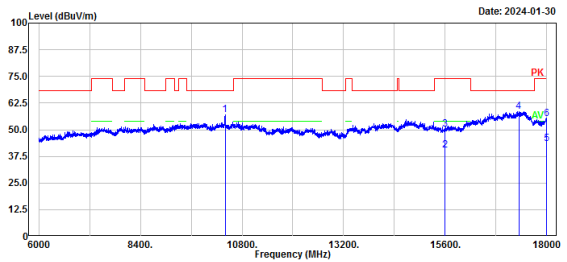

No.	Frequency (MHz)	Reading (dBuV)	Factor (dB/m)	Result (dBuV/m)	Limit (dBuV/m)	Margin (dB)	Detector
1	10400.00	50.58	6.44	57.02	68.20	11.18	Peak
2	15600.00	35.67	4.77	40.44	54.00	13.56	Average
3	15600.00	45.38	4.77	50.15	74.00	23.85	Peak
4	17335.07	43.98	14.54	58.52	68.20	9.68	Peak
5	17985.60	25.13	18.10	43.23	54.00	10.77	Average
6	17985.60	36.89	18.10	54.99	74.00	19.01	Peak

802.11a mode, High Channel, Horizontal

Project No.: DG2231229-79269E-RF Serial No.: 2FY2-1
 Polarization: Horizontal Tester: Colin Yang
 Test Mode: Transmitting
 Note: 802.11a_U-NII-1_high channel 5240MHz Chain 1

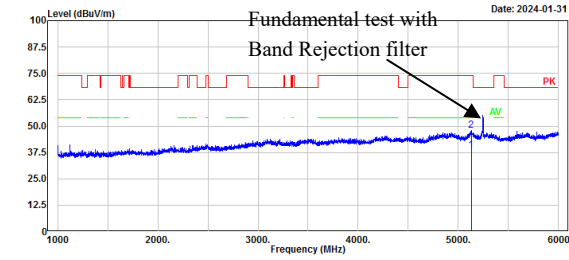

No.	Frequency (MHz)	Reading (dBuV)	Factor (dB/m)	Result (dBuV/m)	Limit (dBuV/m)	Margin (dB)	Detector
1	5127.83	39.66	-1.29	38.37	54.00	15.63	Average
2	5127.83	49.10	-1.29	47.81	74.00	26.19	Peak

802.11a mode, High Channel, Vertical

Project No.: DG2231229-79269E-RF Serial No.: 2FY2-1
 Polarization: Vertical Tester: Colin Yang
 Test Mode: Transmitting
 Note: 802.11a_U-NII-1_high channel 5240MHz Chain 1

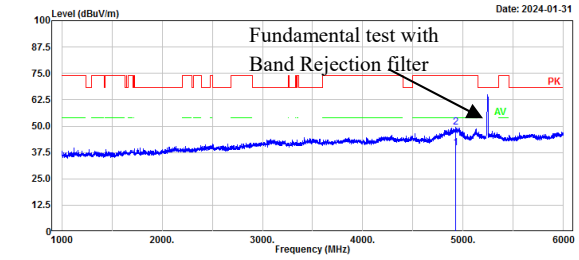

No.	Frequency (MHz)	Reading (dBuV)	Factor (dB/m)	Result (dBuV/m)	Limit (dBuV/m)	Margin (dB)	Detector
1	4926.79	42.18	-2.52	39.66	54.00	14.34	Average
2	4926.79	52.03	-2.52	49.51	74.00	24.49	Peak

Project No.: DG2231229-79269E-RF Serial No.: 2FY2-1
 Polarization: Horizontal Tester: Bill Yang
 Test Mode: Transmitting
 Note: 802.11a_U-NII-1_High channel 5240MHz Chain 1

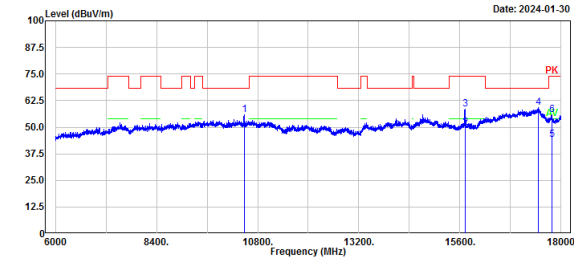

No.	Frequency (MHz)	Reading (dBuV)	Factor (dB/m)	Result (dBuV/m)	Limit (dBuV/m)	Margin (dB)	Detector
1	10480.00	49.35	6.60	55.95	68.20	12.25	Peak
2	15720.00	44.58	5.05	49.63	54.00	4.37	Average
3	15720.00	53.48	5.05	58.53	74.00	15.47	Peak
4	17462.29	43.57	15.57	59.14	68.20	9.06	Peak
5	17776.76	27.01	17.11	44.12	54.00	9.88	Average
6	17776.76	38.69	17.11	55.80	74.00	18.20	Peak

Project No.: DG2231229-79269E-RF Serial No.: 2FY2-1
 Polarization: Vertical Tester: Bill Yang
 Test Mode: Transmitting
 Note: 802.11a_U-NII-1_High channel 5240MHz Chain 1

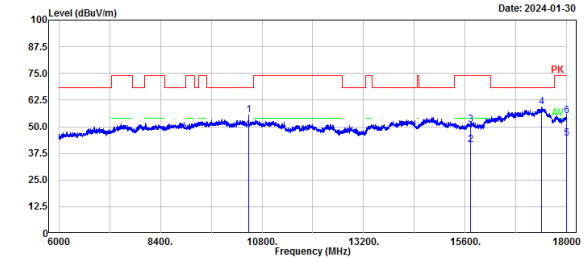

No.	Frequency (MHz)	Reading (dBuV)	Factor (dB/m)	Result (dBuV/m)	Limit (dBuV/m)	Margin (dB)	Detector
1	10479.30	48.84	6.60	55.44	68.20	12.76	Peak
2	15720.00	36.50	5.05	41.55	54.00	12.45	Average
3	15720.00	46.00	5.05	51.05	74.00	22.95	Peak
4	17409.48	44.02	15.15	59.17	68.20	9.03	Peak
5	17985.60	26.27	18.10	44.37	54.00	9.63	Average
6	17985.60	36.90	18.10	55.00	74.00	19.00	Peak

802.11a mode, High Channel, Bandedge, Horizontal

Project No.: DG2231229-79269E-RF Serial No.: 2FY2-1
 Polarization: Horizontal Tester: Colin Yang
 Test Mode: Transmitting
 Note: 802.11a_U-NII-1_high channel 5240MHz Chain 1

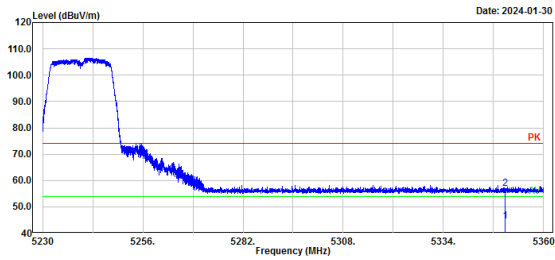

No.	Frequency (MHz)	Reading (dBuV)	Factor (dB/m)	Result (dBuV/m)	Limit (dBuV/m)	Margin (dB)	Detector
1	5350.00	15.35	29.16	44.51	54.00	9.49	Average
2	5350.00	27.81	29.16	56.97	74.00	17.03	Peak

802.11a mode, High Channel, Bandedge, Vertical

Project No.: DG2231229-79269E-RF Serial No.: 2FY2-1
 Polarization: Vertical Tester: Colin Yang
 Test Mode: Transmitting
 Note: 802.11a_U-NII-1_high channel 5240MHz Chain 1

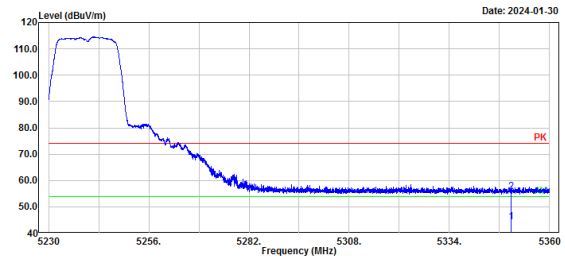

No.	Frequency (MHz)	Reading (dBuV)	Factor (dB/m)	Result (dBuV/m)	Limit (dBuV/m)	Margin (dB)	Detector
1	5350.00	15.17	29.16	44.33	54.00	9.67	Average
2	5350.00	26.59	29.16	55.75	74.00	18.25	Peak

MIMO Mode(Beamforming was the worst):

802.11n ht20 mode, Low Channel, Horizontal

Project No.: DG2231229-79269E-RF Serial No.: 2FY2-1
 Polarization: Horizontal Tester: Colin Yang
 Test Mode: Transmitting
 Note: 802.11n20_U-NII-1_low channel 5180MHz

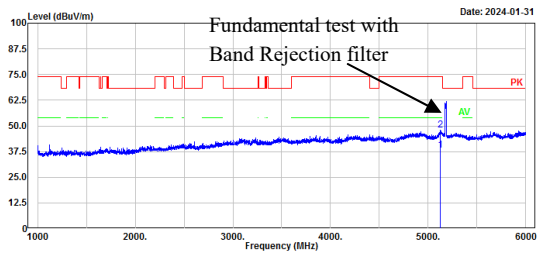

No.	Frequency (MHz)	Reading (dBuV)	Factor (dB/m)	Result (dBuV/m)	Limit (dBuV/m)	Margin (dB)	Detector
1	5124.83	39.33	-1.33	38.00	54.00	16.00	Average
2	5124.83	49.30	-1.33	47.97	74.00	26.03	Peak

802.11n ht20 mode, Low Channel, Vertical

Project No.: DG2231229-79269E-RF Serial No.: 2FY2-1
 Polarization: Vertical Tester: Colin Yang
 Test Mode: Transmitting
 Note: 802.11n20_U-NII-1_low channel 5180MHz

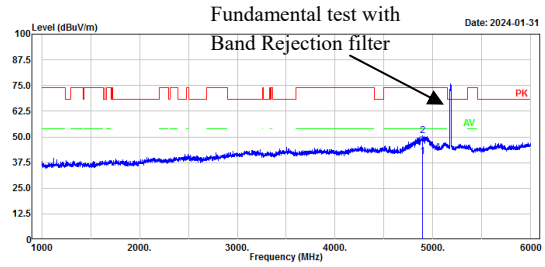

No.	Frequency (MHz)	Reading (dBuV)	Factor (dB/m)	Result (dBuV/m)	Limit (dBuV/m)	Margin (dB)	Detector
1	4894.78	42.87	-2.66	40.21	54.00	13.79	Average
2	4894.78	53.36	-2.66	50.70	74.00	23.30	Peak

Project No.: DG2231229-79269E-RF Serial No.: 2FY2-1
 Polarization: Horizontal Tester: Bill Yang
 Test Mode: Transmitting
 Note: 802.11n20_U-NII-1_low channel 5180MHz

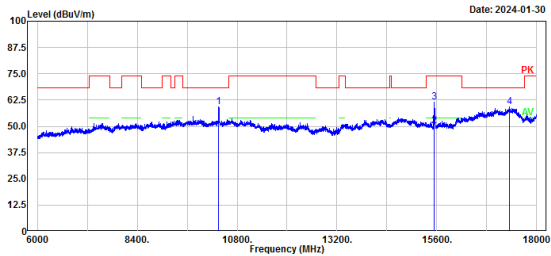

No.	Frequency (MHz)	Reading (dBuV)	Factor (dB/m)	Result (dBuV/m)	Limit (dBuV/m)	Margin (dB)	Detector
1	10360.00	52.90	6.49	59.39	68.20	8.81	Peak
2	15540.00	45.38	4.67	50.05	54.00	3.95	Average
3	15540.00	56.97	4.67	61.64	74.00	12.36	Peak
4	17344.67	44.60	14.62	59.22	68.20	8.98	Peak

Project No.: DG2231229-79269E-RF Serial No.: 2FY2-1
 Polarization: Vertical Tester: Bill Yang
 Test Mode: Transmitting
 Note: 802.11n20_U-NII-1_low channel 5180MHz

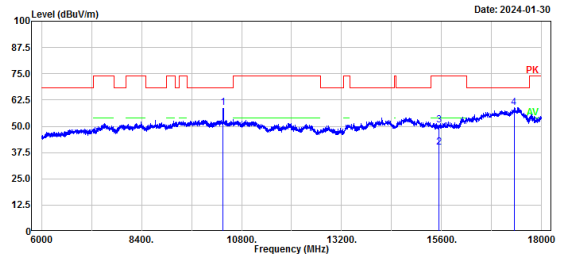

No.	Frequency (MHz)	Reading (dBuV)	Factor (dB/m)	Result (dBuV/m)	Limit (dBuV/m)	Margin (dB)	Detector
1	10360.00	52.19	6.49	58.68	68.20	9.52	Peak
2	15540.00	35.20	4.67	39.87	54.00	14.13	Average
3	15540.00	45.84	4.67	50.51	74.00	23.49	Peak
4	17335.07	44.36	14.54	58.90	68.20	9.30	Peak

802.11n ht20 mode, Low Channel, Bandedge, Horizontal

Project No.: DG2231229-79269E-RF Serial No.: 2FY2-1
 Polarization: Horizontal Tester: Colin Yang
 Test Mode: Transmitting
 Note: 802.11n20_U-NII-1_low channel 5180MHz

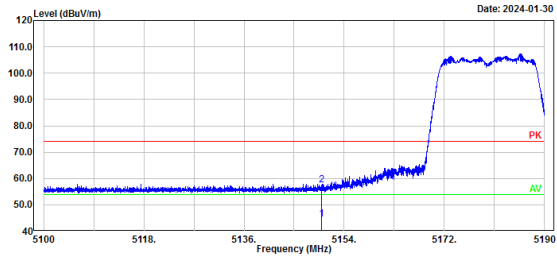

No.	Frequency (MHz)	Reading (dBuV)	Factor (dB/m)	Result (dBuV/m)	Limit (dBuV/m)	Margin (dB)	Detector
1	5150.00	15.89	28.68	44.57	54.00	9.43	Average
2	5150.00	28.90	28.68	57.58	74.00	16.42	Peak

802.11n ht20 mode, Low Channel, Bandedge, Vertical

Project No.: DG2231229-79269E-RF Serial No.: 2FY2-1
 Polarization: Vertical Tester: Colin Yang
 Test Mode: Transmitting
 Note: 802.11n20_U-NII-1_low channel 5180MHz

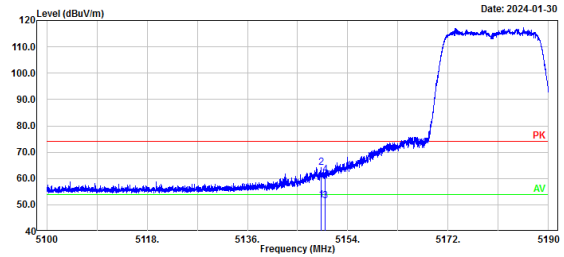

No.	Frequency (MHz)	Reading (dBuV)	Factor (dB/m)	Result (dBuV/m)	Limit (dBuV/m)	Margin (dB)	Detector
1	5149.19	23.05	28.68	51.73	54.00	2.27	Average
2	5149.19	35.56	28.68	64.24	74.00	9.76	Peak
3	5150.00	22.68	28.68	51.36	54.00	2.64	Average
4	5150.00	32.69	28.68	61.37	74.00	12.63	Peak

802.11n ht20 mode, Middle Channel, Horizontal

Project No.: DG2231229-79269E-RF Serial No.: 2FY2-1
 Polarization: Horizontal Tester: Colin Yang
 Test Mode: Transmitting
 Note: 802.11n20_U-NII-1_middle channel 5200MHz

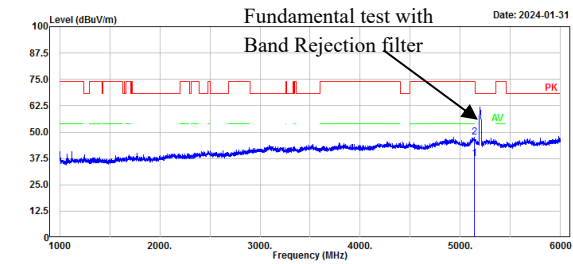

No.	Frequency (MHz)	Reading (dBμV)	Factor (dB/m)	Result (dBμV/m)	Limit (dBμV/m)	Margin (dB)	Detector
1	5141.83	38.66	-1.17	37.49	54.00	16.51	Average
2	5141.83	48.55	-1.17	47.38	74.00	26.62	Peak

802.11n ht20 mode, Middle Channel, Vertical

Project No.: DG2231229-79269E-RF Serial No.: 2FY2-1
 Polarization: Vertical Tester: Colin Yang
 Test Mode: Transmitting
 Note: 802.11n20_U-NII-1_middle channel 5200MHz

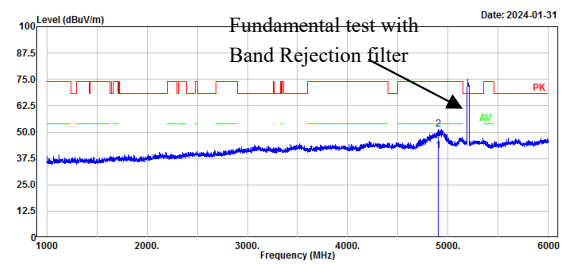

No.	Frequency (MHz)	Reading (dBμV)	Factor (dB/m)	Result (dBμV/m)	Limit (dBμV/m)	Margin (dB)	Detector
1	4897.78	43.65	-2.65	41.00	54.00	13.00	Average
2	4897.78	54.11	-2.65	51.46	74.00	22.54	Peak

Project No.: DG2231229-79269E-RF Serial No.: 2FY2-1
 Polarization: Horizontal Tester: Bill Yang
 Test Mode: Transmitting
 Note: 802.11n20_U-NII-1_Middle channel 5200MHz

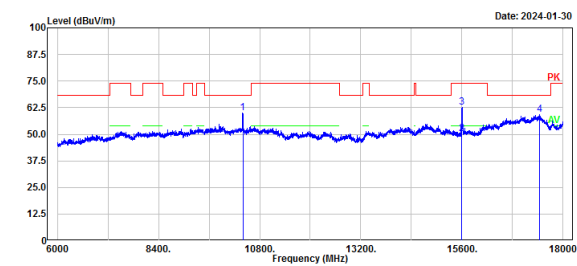

No.	Frequency (MHz)	Reading (dBμV)	Factor (dB/m)	Result (dBμV/m)	Limit (dBμV/m)	Margin (dB)	Detector
1	10400.00	53.54	6.44	59.98	68.20	8.22	Peak
2	15600.00	45.51	4.77	50.28	54.00	3.72	Average
3	15600.00	57.99	4.77	62.76	74.00	11.24	Peak
4	17435.89	43.90	15.36	59.26	68.20	8.94	Peak

Project No.: DG2231229-79269E-RF Serial No.: 2FY2-1
 Polarization: Vertical Tester: Bill Yang
 Test Mode: Transmitting
 Note: 802.11n20_U-NII-1_Middle channel 5200MHz

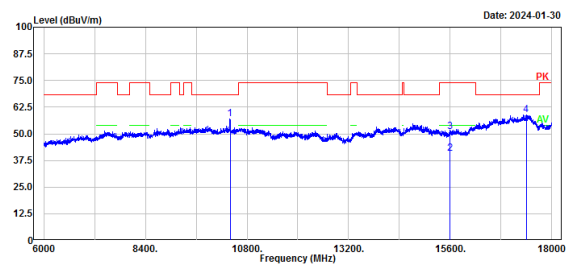

No.	Frequency (MHz)	Reading (dBμV)	Factor (dB/m)	Result (dBμV/m)	Limit (dBμV/m)	Margin (dB)	Detector
1	10400.00	50.37	6.44	56.81	68.20	11.39	Peak
2	15600.00	36.07	4.77	40.84	54.00	13.16	Average
3	15600.00	46.32	4.77	51.09	74.00	22.91	Peak
4	17392.68	43.89	15.01	58.90	68.20	9.30	Peak

802.11n ht20 mode, High Channel, Horizontal

Project No.: DG2231229-79269E-RF Serial No.: 2FY2-1
 Polarization: Horizontal Tester: Colin Yang
 Test Mode: Transmitting
 Note: 802.11n20_U-NII-1_high channel 5240MHz

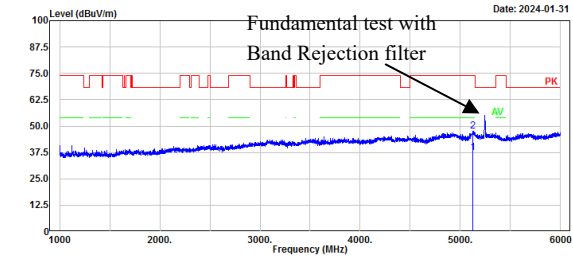

No.	Frequency (MHz)	Reading (dBμV)	Factor (dB/m)	Result (dBμV/m)	Limit (dBμV/m)	Margin (dB)	Detector
1	5120.82	38.59	-1.36	37.23	54.00	16.77	Average
2	5120.82	49.04	-1.36	47.68	74.00	26.32	Peak

802.11n ht20 mode, High Channel, Vertical

Project No.: DG2231229-79269E-RF Serial No.: 2FY2-1
 Polarization: Vertical Tester: Colin Yang
 Test Mode: Transmitting
 Note: 802.11n20_U-NII-1_high channel 5240MHz

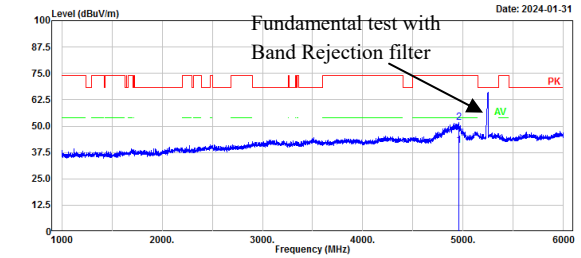

No.	Frequency (MHz)	Reading (dBμV)	Factor (dB/m)	Result (dBμV/m)	Limit (dBμV/m)	Margin (dB)	Detector
1	4959.79	43.11	-2.35	40.76	54.00	13.24	Average
2	4959.79	53.93	-2.35	51.58	74.00	22.42	Peak

Project No.: DG2231229-79269E-RF Serial No.: 2FY2-1
 Polarization: Horizontal Tester: Bill Yang
 Test Mode: Transmitting
 Note: 802.11n20_U-NII-1_High channel 5240MHz

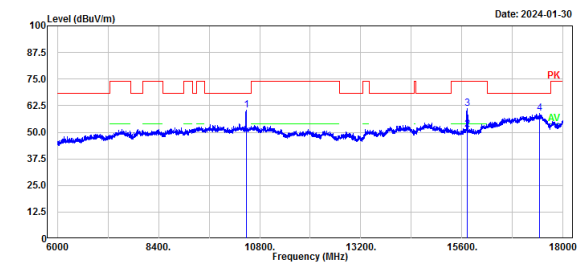

No.	Frequency (MHz)	Reading (dBμV)	Factor (dB/m)	Result (dBμV/m)	Limit (dBμV/m)	Margin (dB)	Detector
1	10480.00	53.86	6.60	60.46	68.20	7.74	Peak
2	15720.00	46.37	5.05	51.42	54.00	2.58	Average
3	15720.00	56.15	5.05	61.20	74.00	12.80	Peak
4	17443.09	43.59	15.42	59.01	68.20	9.19	Peak

Project No.: DG2231229-79269E-RF Serial No.: 2FY2-1
 Polarization: Vertical Tester: Bill Yang
 Test Mode: Transmitting
 Note: 802.11n20_U-NII-1_High channel 5240MHz

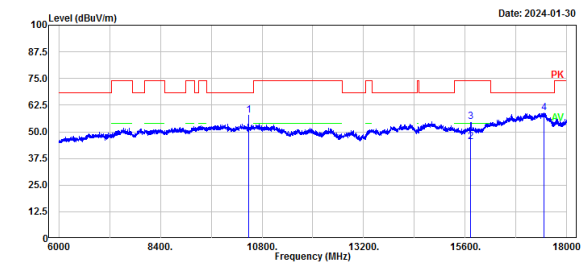

No.	Frequency (MHz)	Reading (dBμV)	Factor (dB/m)	Result (dBμV/m)	Limit (dBμV/m)	Margin (dB)	Detector
1	10480.00	51.30	6.60	57.90	68.20	10.30	Peak
2	15720.00	40.42	5.05	45.47	54.00	8.53	Average
3	15720.00	49.48	5.05	54.53	74.00	19.47	Peak
4	17457.49	43.30	15.53	58.83	68.20	9.37	Peak

802.11n ht20 mode, High Channel, Bandedge, Horizontal

Project No.: DG2231229-79269E-RF Serial No.: 2FY2-1
 Polarization: Horizontal Tester: Colin Yang
 Test Mode: Transmitting
 Note: 802.11n20_U-NII-1_high channel 5240MHz

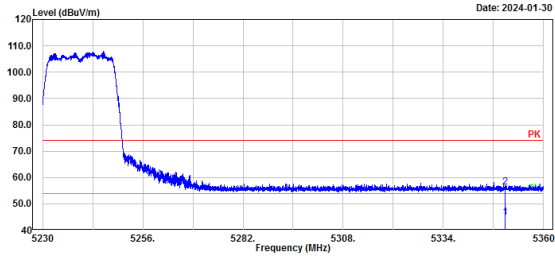

No.	Frequency (MHz)	Reading (dBuV)	Factor (dB/m)	Result (dBuV/m)	Limit (dBuV/m)	Margin (dB)	Detector
1	5350.00	15.68	29.16	44.84	54.00	9.16	Average
2	5350.00	27.00	29.16	56.16	74.00	17.84	Peak

802.11n ht20 mode, High Channel, Bandedge, Vertical

Project No.: DG2231229-79269E-RF Serial No.: 2FY2-1
 Polarization: Vertical Tester: Colin Yang
 Test Mode: Transmitting
 Note: 802.11n20_U-NII-1_high channel 5240MHz

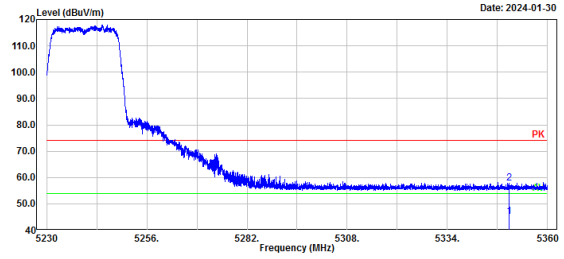

No.	Frequency (MHz)	Reading (dBuV)	Factor (dB/m)	Result (dBuV/m)	Limit (dBuV/m)	Margin (dB)	Detector
1	5350.00	16.12	29.16	45.28	54.00	8.72	Average
2	5350.00	28.71	29.16	57.87	74.00	16.13	Peak

802.11n ht40 mode, Low Channel, Horizontal

Project No.: DG2231229-79269E-RF Serial No.: 2FY2-1
 Polarization: Horizontal Tester: Colin Yang
 Test Mode: Transmitting
 Note: 802.11n40_U-NII-1_low channel 5190MHz

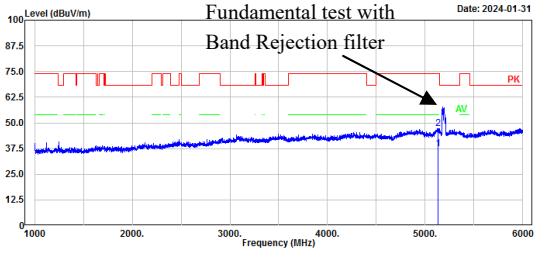

No.	Frequency (MHz)	Reading (dBuV)	Factor (dB/m)	Result (dBuV/m)	Limit (dBuV/m)	Margin (dB)	Detector
1	5131.83	38.50	-1.27	37.23	54.00	16.77	Average
2	5131.83	48.47	-1.27	47.20	74.00	26.80	Peak

802.11n ht40 mode, Low Channel, Vertical

Project No.: DG2231229-79269E-RF Serial No.: 2FY2-1
 Polarization: Vertical Tester: Colin Yang
 Test Mode: Transmitting
 Note: 802.11n40_U-NII-1_low channel 5190MHz

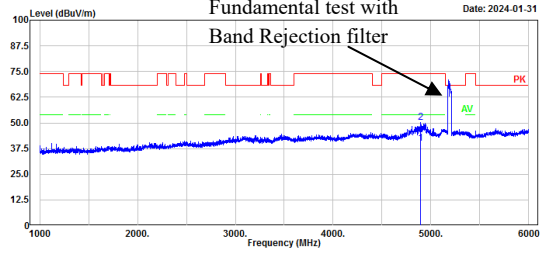

No.	Frequency (MHz)	Reading (dBuV)	Factor (dB/m)	Result (dBuV/m)	Limit (dBuV/m)	Margin (dB)	Detector
1	4896.78	42.47	-2.65	39.82	54.00	14.18	Average
2	4896.78	52.93	-2.65	50.28	74.00	23.72	Peak

Project No.: DG2231229-79269E-RF Serial No.: 2FY2-1
 Polarization: Horizontal Tester: Bill Yang
 Test Mode: Transmitting
 Note: 802.11n40_U-NII-1_Low channel 5190MHz

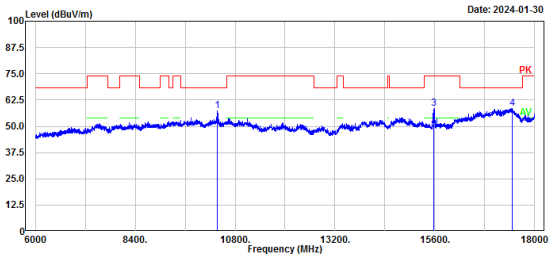

No.	Frequency (MHz)	Reading (dBuV)	Factor (dB/m)	Result (dBuV/m)	Limit (dBuV/m)	Margin (dB)	Detector
1	10380.00	50.94	6.47	57.41	68.20	10.79	Peak
2	15570.00	43.45	4.72	48.17	54.00	5.83	Average
3	15570.00	53.74	4.72	58.46	74.00	15.54	Peak
4	17455.09	43.08	15.51	58.59	68.20	9.61	Peak

Project No.: DG2231229-79269E-RF Serial No.: 2FY2-1
 Polarization: Vertical Tester: Bill Yang
 Test Mode: Transmitting
 Note: 802.11n40_U-NII-1_Low channel 5190MHz

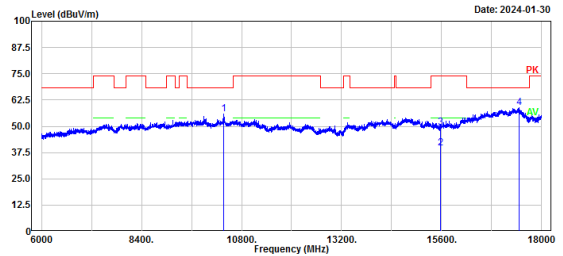

No.	Frequency (MHz)	Reading (dBuV)	Factor (dB/m)	Result (dBuV/m)	Limit (dBuV/m)	Margin (dB)	Detector
1	10380.00	49.30	6.47	55.77	68.20	12.43	Peak
2	15570.00	34.99	4.72	39.71	54.00	14.29	Average
3	15570.00	44.71	4.72	49.43	74.00	24.57	Peak
4	17452.69	43.21	15.50	58.71	68.20	9.49	Peak

802.11n ht40 mode, Low Channel, Bandedge, Horizontal

Project No.: DG2231229-79269E-RF Serial No.: 2FY2-1
 Polarization: Horizontal Tester: Colin Yang
 Test Mode: Transmitting
 Note: 802.11n40_U-NII-1_low channel 5190MHz

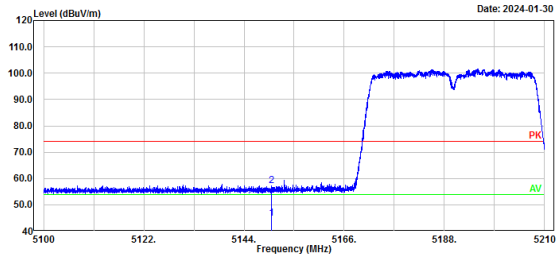

No.	Frequency (MHz)	Reading (dBuV)	Factor (dB/m)	Result (dBuV/m)	Limit (dBuV/m)	Margin (dB)	Detector
1	5150.00	16.21	28.68	44.89	54.00	9.11	Average
2	5150.00	28.61	28.68	57.29	74.00	16.71	Peak

802.11n ht40 mode, Low Channel, Bandedge, Vertical

Project No.: DG2231229-79269E-RF Serial No.: 2FY2-1
 Polarization: Vertical Tester: Colin Yang
 Test Mode: Transmitting
 Note: 802.11n40_U-NII-1_low channel 5190MHz

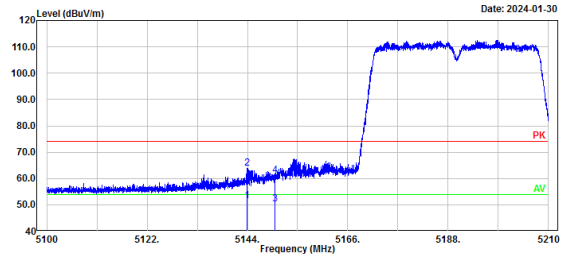

No.	Frequency (MHz)	Reading (dBuV)	Factor (dB/m)	Result (dBuV/m)	Limit (dBuV/m)	Margin (dB)	Detector
1	5143.86	22.88	28.67	51.55	54.00	-2.45	Average
2	5143.86	35.28	28.67	63.87	74.00	10.13	Peak
3	5150.00	21.49	28.68	50.17	54.00	3.83	Average
4	5150.00	32.58	28.68	61.26	74.00	12.74	Peak

802.11n ht40 mode, High Channel, Horizontal

Project No.: DG2231229-79269E-RF Serial No.: 2FY2-1
 Polarization: Horizontal Tester: Colin Yang
 Test Mode: Transmitting
 Note: 802.11n40_U-NII-1_high channel 5230MHz

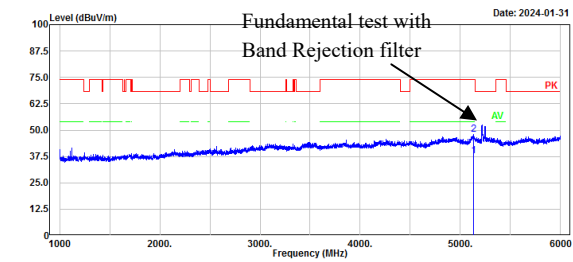

No.	Frequency (MHz)	Reading (dBμV)	Factor (dB/m)	Result (dBμV/m)	Limit (dBμV/m)	Margin (dB)	Detector
1	5129.83	39.14	-1.28	37.86	54.00	16.14	Average
2	5129.83	49.03	-1.28	47.75	74.00	26.25	Peak

802.11n ht40 mode, High Channel, Vertical

Project No.: DG2231229-79269E-RF Serial No.: 2FY2-1
 Polarization: Vertical Tester: Colin Yang
 Test Mode: Transmitting
 Note: 802.11n40_U-NII-1_high channel 5230MHz

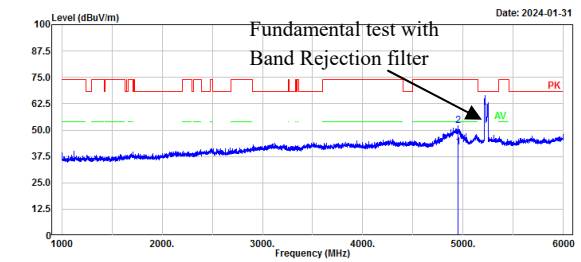

No.	Frequency (MHz)	Reading (dBμV)	Factor (dB/m)	Result (dBμV/m)	Limit (dBμV/m)	Margin (dB)	Detector
1	4946.79	44.15	-2.42	41.73	54.00	12.27	Average
2	4946.79	54.52	-2.42	52.10	74.00	21.90	Peak

Project No.: DG2231229-79269E-RF Serial No.: 2FY2-1
 Polarization: Horizontal Tester: Bill Yang
 Test Mode: Transmitting
 Note: 802.11n40_U-NII-1_High channel 5230MHz

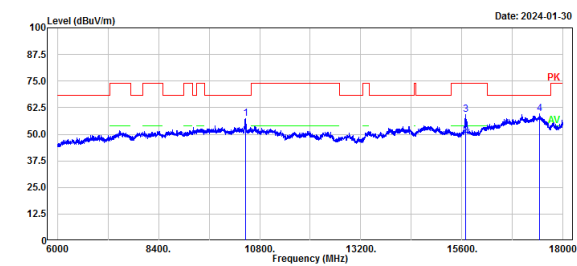

No.	Frequency (MHz)	Reading (dBμV)	Factor (dB/m)	Result (dBμV/m)	Limit (dBμV/m)	Margin (dB)	Detector
1	10460.00	50.65	6.56	57.21	68.20	10.99	Peak
2	15690.00	44.63	4.97	49.60	54.00	4.40	Average
3	15690.00	54.25	4.97	59.22	74.00	14.78	Peak
4	17445.49	44.18	15.44	59.62	68.20	8.58	Peak

Project No.: DG2231229-79269E-RF Serial No.: 2FY2-1
 Polarization: Vertical Tester: Bill Yang
 Test Mode: Transmitting
 Note: 802.11n40_U-NII-1_High channel 5230MHz

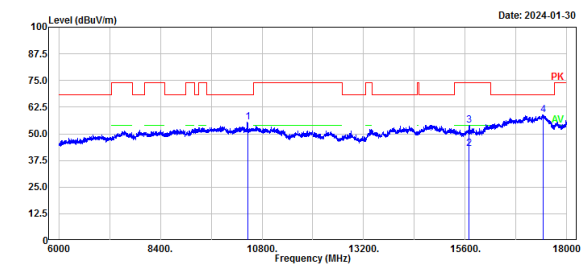

No.	Frequency (MHz)	Reading (dBμV)	Factor (dB/m)	Result (dBμV/m)	Limit (dBμV/m)	Margin (dB)	Detector
1	10460.00	48.79	6.56	55.35	68.20	12.85	Peak
2	15690.00	37.94	4.97	42.91	54.00	11.09	Average
3	15690.00	49.01	4.97	53.98	74.00	20.02	Peak
4	17440.69	43.45	15.40	58.85	68.20	9.35	Peak

802.11n ht40 mode, High Channel, Bandedge, Horizontal

Project No.: DG2231229-79269E-RF Serial No.: 2FY2-1
 Polarization: Horizontal Tester: Colin Yang
 Test Mode: Transmitting
 Note: 802.11n40_U-NII-1_high channel 5230MHz

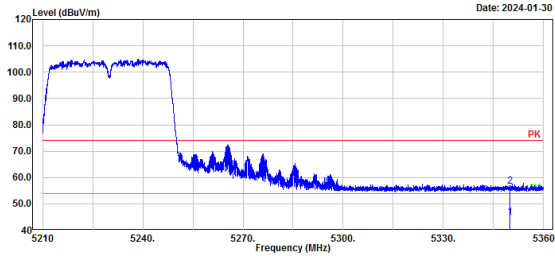

No.	Frequency (MHz)	Reading (dBuV)	Factor (dB/m)	Result (dBuV/m)	Limit (dBuV/m)	Margin (dB)	Detector
1	5350.00	15.76	29.16	44.92	54.00	9.08	Average
2	5350.00	27.37	29.16	56.53	74.00	17.47	Peak

802.11n ht40 mode, High Channel, Bandedge, Vertical

Project No.: DG2231229-79269E-RF Serial No.: 2FY2-1
 Polarization: Vertical Tester: Colin Yang
 Test Mode: Transmitting
 Note: 802.11n40_U-NII-1_high channel 5230MHz

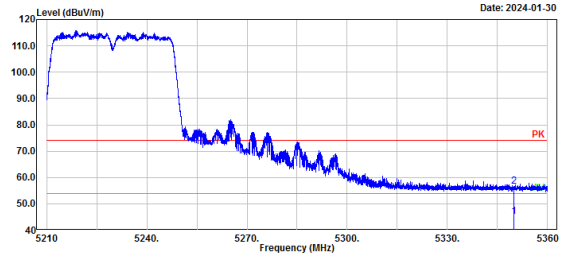

No.	Frequency (MHz)	Reading (dBuV)	Factor (dB/m)	Result (dBuV/m)	Limit (dBuV/m)	Margin (dB)	Detector
1	5350.00	16.12	29.16	45.28	54.00	8.72	Average
2	5350.00	27.49	29.16	56.65	74.00	17.35	Peak

802.11 ac vht20 mode, Low Channel, Horizontal

Project No.: DG2231229-79269E-RF Serial No.: 2FY2-1
 Polarization: Horizontal Tester: Colin Yang
 Test Mode: Transmitting
 Note: 802.11ac20_U-NII-1_low channel 5180MHz

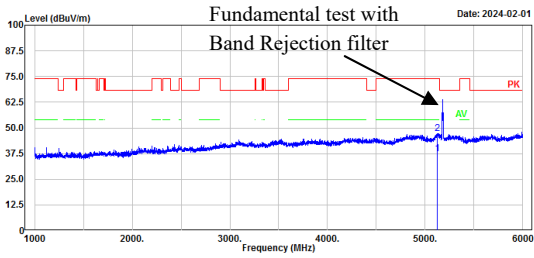

No.	Frequency (MHz)	Reading (dBuV)	Factor (dB/m)	Result (dBuV/m)	Limit (dBuV/m)	Margin (dB)	Detector
1	5125.83	38.73	-1.30	37.43	54.00	16.57	Average
2	5125.83	48.42	-1.30	47.12	74.00	26.88	Peak

802.11 ac vht20 mode, Low Channel, Vertical

Project No.: DG2231229-79269E-RF Serial No.: 2FY2-1
 Polarization: Vertical Tester: Colin Yang
 Test Mode: Transmitting
 Note: 802.11ac20_U-NII-1_low channel 5180MHz

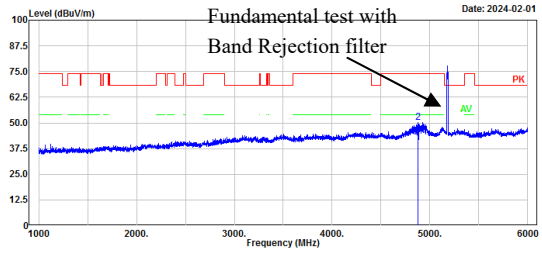

No.	Frequency (MHz)	Reading (dBuV)	Factor (dB/m)	Result (dBuV/m)	Limit (dBuV/m)	Margin (dB)	Detector
1	4880.78	42.92	-2.73	40.19	54.00	13.81	Average
2	4880.78	53.05	-2.73	50.32	74.00	23.68	Peak

Project No.: DG2231229-79269E-RF Serial No.: 2FY2-1
 Polarization: Horizontal Tester: Bill Yang
 Test Mode: Transmitting
 Note: 802.11ac20_U-NII-1_low channel 5180MHz

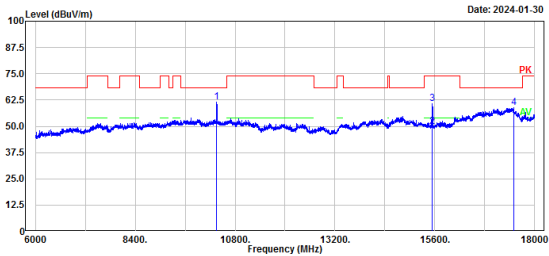

No.	Frequency (MHz)	Reading (dBuV)	Factor (dB/m)	Result (dBuV/m)	Limit (dBuV/m)	Margin (dB)	Detector
1	10360.00	55.18	6.49	61.67	68.20	6.53	Peak
2	15540.00	44.96	4.67	49.63	54.00	4.37	Average
3	15540.00	55.96	4.67	60.63	74.00	13.37	Peak
4	17491.10	43.10	15.81	58.91	68.20	9.29	Peak

Project No.: DG2231229-79269E-RF Serial No.: 2FY2-1
 Polarization: Vertical Tester: Bill Yang
 Test Mode: Transmitting
 Note: 802.11ac20_U-NII-1_low channel 5180MHz

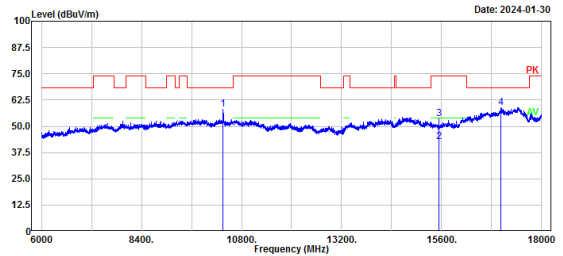

No.	Frequency (MHz)	Reading (dBuV)	Factor (dB/m)	Result (dBuV/m)	Limit (dBuV/m)	Margin (dB)	Detector
1	10360.00	51.59	6.49	58.08	68.20	10.12	Peak
2	15540.00	37.97	4.67	42.64	54.00	11.36	Average
3	15540.00	48.95	4.67	53.62	74.00	20.38	Peak
4	17023.00	46.88	12.11	58.99	68.20	9.21	Peak

802.11 ac vht20 mode, Low Channel, Bandedge, Horizontal

Project No.: DG2231229-79269E-RF Serial No.: 2FY2-1
 Polarization: Horizontal Tester: Colin Yang
 Test Mode: Transmitting
 Note: 802.11ac20_U-NII-1_low channel 5180MHz

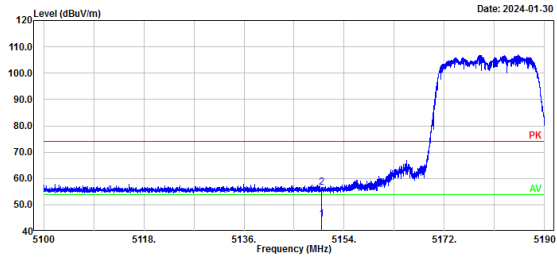

No.	Frequency (MHz)	Reading (dBuV)	Factor (dB/m)	Result (dBuV/m)	Limit (dBuV/m)	Margin (dB)	Detector
1	5150.00	15.89	28.68	44.57	54.00	9.43	Average
2	5150.00	27.80	28.68	56.48	74.00	17.52	Peak

802.11 ac vht20 mode, Low Channel, Bandedge, Vertical

Project No.: DG2231229-79269E-RF Serial No.: 2FY2-1
 Polarization: Vertical Tester: Colin Yang
 Test Mode: Transmitting
 Note: 802.11ac20_U-NII-1_low channel 5180MHz

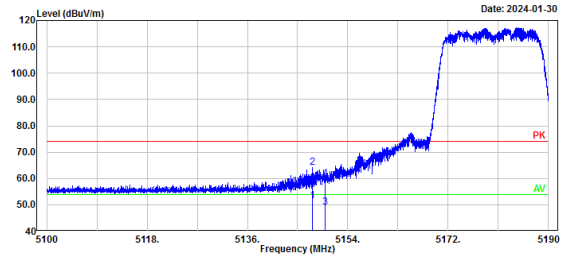

No.	Frequency (MHz)	Reading (dBuV)	Factor (dB/m)	Result (dBuV/m)	Limit (dBuV/m)	Margin (dB)	Detector
1	5147.64	22.76	28.68	51.44	54.00	2.56	Average
2	5147.64	35.33	28.68	64.01	74.00	9.99	Peak
3	5150.00	20.47	28.68	49.15	54.00	4.85	Average
4	5150.00	31.25	28.68	59.93	74.00	14.07	Peak

802.11 ac vht20 mode, Middle Channel, Horizontal

Project No.: DG2231229-79269E-RF Serial No.: 2FY2-1
 Polarization: Horizontal Tester: Colin Yang
 Test Mode: Transmitting
 Note: 802.11ac20_U-NII-1_middle channel 5200MHz

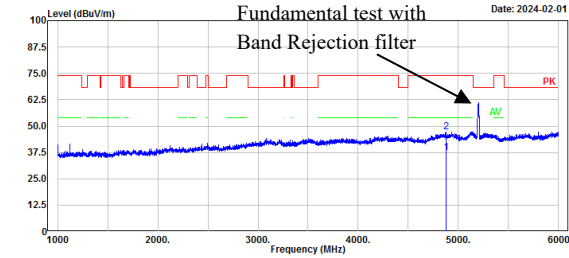

No.	Frequency (MHz)	Reading (dBμV)	Factor (dB/m)	Result (dBμV/m)	Limit (dBμV/m)	Margin (dB)	Detector
1	4879.78	40.01	-2.73	37.28	54.00	16.72	Average
2	4879.78	50.02	-2.73	47.29	74.00	26.71	Peak

802.11 ac vht20 mode, Middle Channel, Vertical

Project No.: DG2231229-79269E-RF Serial No.: 2FY2-1
 Polarization: Vertical Tester: Colin Yang
 Test Mode: Transmitting
 Note: 802.11ac20_U-NII-1_middle channel 5200MHz

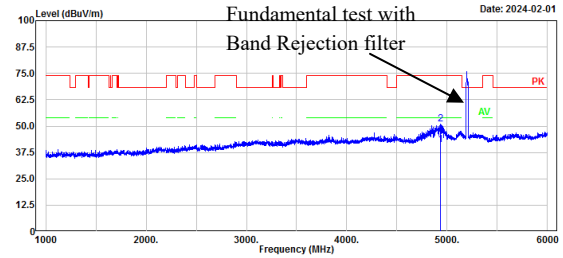

No.	Frequency (MHz)	Reading (dBμV)	Factor (dB/m)	Result (dBμV/m)	Limit (dBμV/m)	Margin (dB)	Detector
1	4936.79	43.45	-2.47	40.98	54.00	13.02	Average
2	4936.79	53.48	-2.47	51.01	74.00	22.99	Peak

Project No.: DG2231229-79269E-RF Serial No.: 2FY2-1
 Polarization: Horizontal Tester: Bill Yang
 Test Mode: Transmitting
 Note: 802.11ac20_U-NII-1_Middle channel 5200MHz

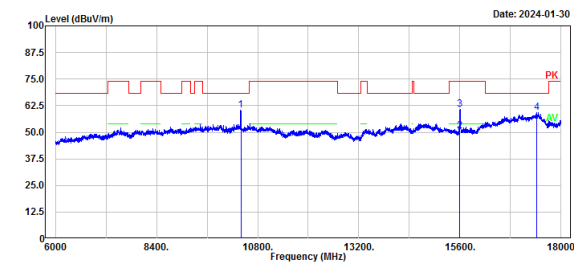

No.	Frequency (MHz)	Reading (dBμV)	Factor (dB/m)	Result (dBμV/m)	Limit (dBμV/m)	Margin (dB)	Detector
1	10400.00	53.83	6.44	60.27	68.20	7.93	Peak
2	15600.00	45.92	4.77	50.69	54.00	3.31	Average
3	15600.00	55.95	4.77	60.72	74.00	13.28	Peak
4	17421.48	44.07	15.25	59.32	68.20	8.88	Peak

Project No.: DG2231229-79269E-RF Serial No.: 2FY2-1
 Polarization: Vertical Tester: Bill Yang
 Test Mode: Transmitting
 Note: 802.11ac20_U-NII-1_Middle channel 5200MHz

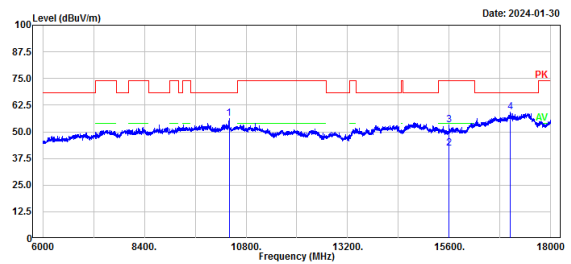

No.	Frequency (MHz)	Reading (dBμV)	Factor (dB/m)	Result (dBμV/m)	Limit (dBμV/m)	Margin (dB)	Detector
1	10400.00	49.67	6.44	56.11	68.20	12.09	Peak
2	15600.00	37.62	4.77	42.39	54.00	11.61	Average
3	15600.00	48.61	4.77	53.38	74.00	20.62	Peak
4	17035.01	46.89	12.22	59.11	68.20	9.09	Peak

802.11 ac vht20 mode, High Channel, Horizontal

Project No.: DG2231229-79269E-RF Serial No.: 2FY2-1
 Polarization: Horizontal Tester: Colin Yang
 Test Mode: Transmitting
 Note: 802.11ac20_U-NII-1_high channel 5240MHz

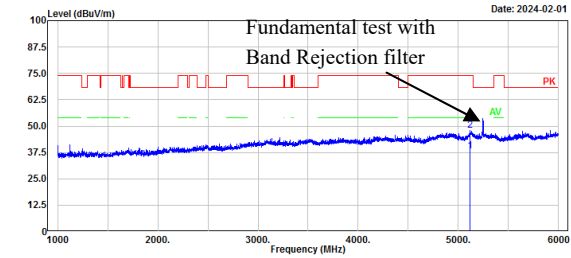

No.	Frequency (MHz)	Reading (dBuV)	Factor (dB/m)	Result (dBuV/m)	Limit (dBuV/m)	Margin (dB)	Detector
1	5115.82	39.68	-1.40	38.28	54.00	15.72	Average
2	5115.82	49.18	-1.40	47.78	74.00	26.22	Peak

802.11 ac vht20 mode, High Channel, Vertical

Project No.: DG2231229-79269E-RF Serial No.: 2FY2-1
 Polarization: Vertical Tester: Colin Yang
 Test Mode: Transmitting
 Note: 802.11ac20_U-NII-1_high channel 5240MHz

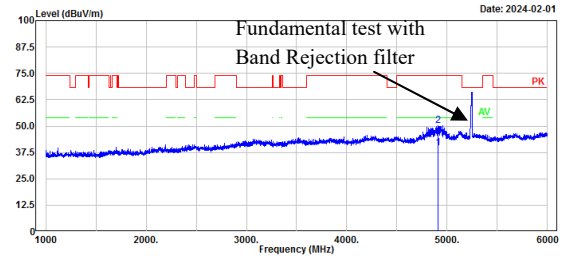

No.	Frequency (MHz)	Reading (dBuV)	Factor (dB/m)	Result (dBuV/m)	Limit (dBuV/m)	Margin (dB)	Detector
1	4910.78	42.18	-2.59	39.59	54.00	14.41	Average
2	4910.78	52.61	-2.59	50.02	74.00	23.98	Peak

Project No.: DG2231229-79269E-RF Serial No.: 2FY2-1
 Polarization: Horizontal Tester: Bill Yang
 Test Mode: Transmitting
 Note: 802.11ac20_U-NII-1_High channel 5240MHz

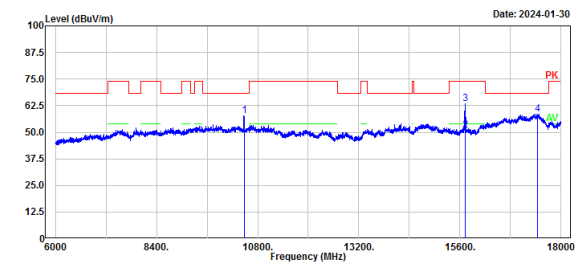

No.	Frequency (MHz)	Reading (dBuV)	Factor (dB/m)	Result (dBuV/m)	Limit (dBuV/m)	Margin (dB)	Detector
1	10480.00	51.27	6.60	57.87	68.20	10.33	Peak
2	15720.00	45.78	5.05	50.83	54.00	3.17	Average
3	15720.00	58.20	5.05	63.25	74.00	10.75	Peak
4	17445.49	43.23	15.44	58.67	68.20	9.53	Peak

Project No.: DG2231229-79269E-RF Serial No.: 2FY2-1
 Polarization: Vertical Tester: Bill Yang
 Test Mode: Transmitting
 Note: 802.11ac20_U-NII-1_High channel 5240MHz

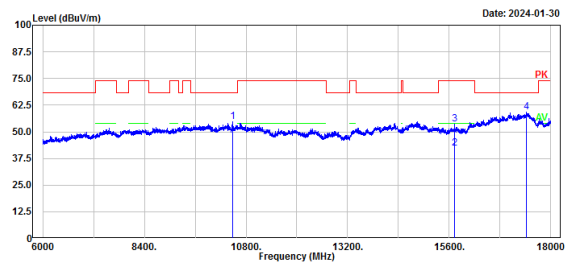

No.	Frequency (MHz)	Reading (dBuV)	Factor (dB/m)	Result (dBuV/m)	Limit (dBuV/m)	Margin (dB)	Detector
1	10480.00	48.09	6.60	54.69	68.20	13.51	Peak
2	15720.00	37.34	5.05	42.39	54.00	11.61	Average
3	15720.00	48.53	5.05	53.58	74.00	20.42	Peak
4	17423.88	43.88	15.27	59.15	68.20	9.05	Peak

802.11 ac vht20 mode, High Channel, Bandedge, Horizontal

Project No.: DG2231229-79269E-RF Serial No.: 2FY2-1
 Polarization: Horizontal Tester: Colin Yang
 Test Mode: Transmitting
 Note: 802.11ac20_U-NII-1_high channel 5240MHz

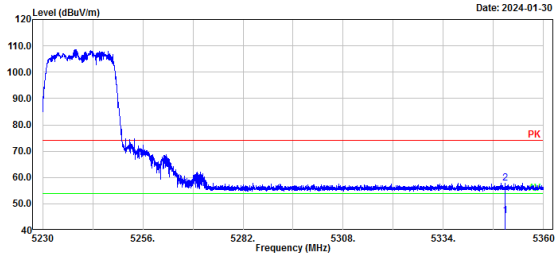

No.	Frequency (MHz)	Reading (dBuV)	Factor (dB/m)	Result (dBuV/m)	Limit (dBuV/m)	Margin (dB)	Detector
1	5350.00	16.42	29.16	45.58	54.00	8.42	Average
2	5350.00	28.70	29.16	57.86	74.00	16.14	Peak

802.11 ac vht20 mode, High Channel, Bandedge, Vertical

Project No.: DG2231229-79269E-RF Serial No.: 2FY2-1
 Polarization: Vertical Tester: Colin Yang
 Test Mode: Transmitting
 Note: 802.11ac20_U-NII-1_high channel 5240MHz

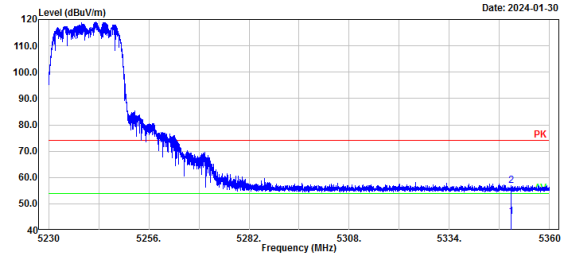

No.	Frequency (MHz)	Reading (dBuV)	Factor (dB/m)	Result (dBuV/m)	Limit (dBuV/m)	Margin (dB)	Detector
1	5350.00	16.02	29.16	45.18	54.00	8.82	Average
2	5350.00	27.69	29.16	56.85	74.00	17.15	Peak

802.11 ac vht40 mode, Low Channel, Horizontal

Project No.: DG2231229-79269E-RF Serial No.: 2FY2-1
 Polarization: Horizontal Tester: Colin Yang
 Test Mode: Transmitting
 Note: 802.11ac40_U-NII-1_low channel 5190MHz

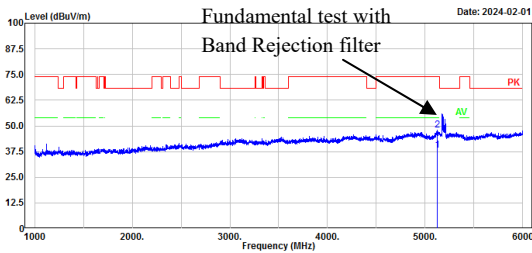

No.	Frequency (MHz)	Reading (dBuV)	Factor (dB/m)	Result (dBuV/m)	Limit (dBuV/m)	Margin (dB)	Detector
1	5124.83	39.32	-1.33	37.99	54.00	16.01	Average
2	5124.83	49.22	-1.33	47.89	74.00	26.11	Peak

802.11 ac vht40 mode, Low Channel, Vertical

Project No.: DG2231229-79269E-RF Serial No.: 2FY2-1
 Polarization: Vertical Tester: Colin Yang
 Test Mode: Transmitting
 Note: 802.11ac40_U-NII-1_low channel 5190MHz

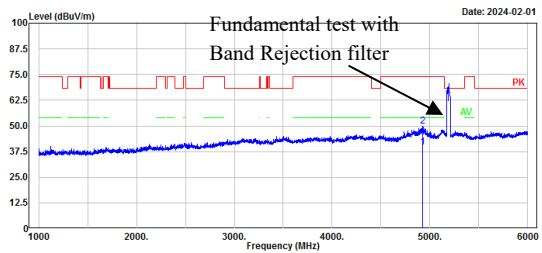

No.	Frequency (MHz)	Reading (dBuV)	Factor (dB/m)	Result (dBuV/m)	Limit (dBuV/m)	Margin (dB)	Detector
1	4922.79	42.30	-2.53	39.77	54.00	14.23	Average
2	4922.79	52.22	-2.53	49.69	74.00	24.31	Peak

Project No.: DG2231229-79269E-RF Serial No.: 2FY2-1
 Polarization: Horizontal Tester: Bill Yang
 Test Mode: Transmitting
 Note: 802.11ac40_U-NII-1_Low channel 5190MHz

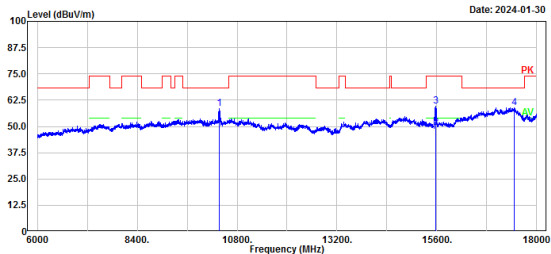

No.	Frequency (MHz)	Reading (dBuV)	Factor (dB/m)	Result (dBuV/m)	Limit (dBuV/m)	Margin (dB)	Detector
1	10380.00	52.19	6.47	58.66	68.20	9.54	Peak
2	15570.00	44.57	4.72	49.29	54.00	4.71	Average
3	15570.00	55.06	4.72	59.78	74.00	14.22	Peak
4	17457.49	43.38	15.53	58.91	68.20	9.29	Peak

Project No.: DG2231229-79269E-RF Serial No.: 2FY2-1
 Polarization: Vertical Tester: Bill Yang
 Test Mode: Transmitting
 Note: 802.11ac40_U-NII-1_Low channel 5190MHz

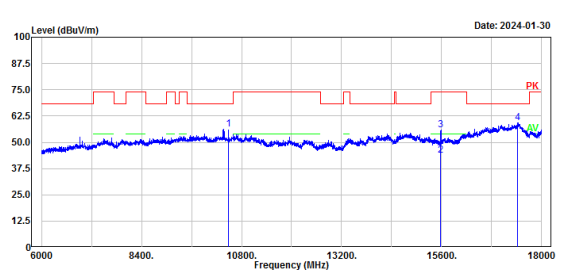

No.	Frequency (MHz)	Reading (dBuV)	Factor (dB/m)	Result (dBuV/m)	Limit (dBuV/m)	Margin (dB)	Detector
1	10480.00	49.51	6.60	56.11	68.20	12.09	Peak
2	15570.00	38.90	4.72	43.62	54.00	10.38	Average
3	15570.00	51.11	4.72	55.83	74.00	18.17	Peak
4	17428.69	44.08	15.30	59.38	68.20	8.82	Peak

802.11 ac vht40 mode, Low Channel, Bandedge, Horizontal

Project No.: DG2231229-79269E-RF Serial No.: 2FY2-1
 Polarization: Horizontal Tester: Colin Yang
 Test Mode: Transmitting
 Note: 802.11ac40_U-NII-1_low channel 5190MHz

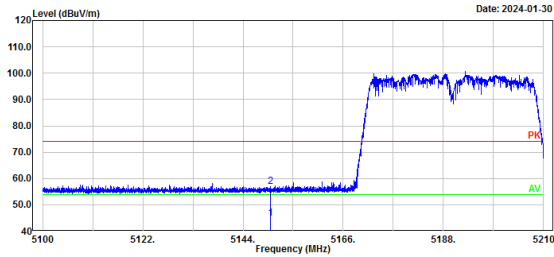

No.	Frequency (MHz)	Reading (dBuV)	Factor (dB/m)	Result (dBuV/m)	Limit (dBuV/m)	Margin (dB)	Detector
1	5150.00	16.07	28.68	44.75	54.00	9.25	Average
2	5150.00	28.14	28.68	56.82	74.00	17.18	Peak

802.11 ac vht40 mode, Low Channel, Bandedge, Vertical

Project No.: DG2231229-79269E-RF Serial No.: 2FY2-1
 Polarization: Vertical Tester: Colin Yang
 Test Mode: Transmitting
 Note: 802.11ac40_U-NII-1_low channel 5190MHz

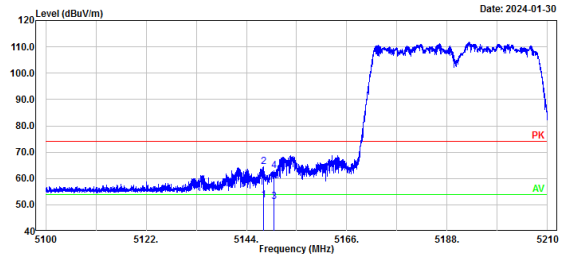

No.	Frequency (MHz)	Reading (dBuV)	Factor (dB/m)	Result (dBuV/m)	Limit (dBuV/m)	Margin (dB)	Detector
1	5147.77	23.14	28.68	51.82	54.00	2.18	Average
2	5147.77	35.89	28.68	64.57	74.00	9.43	Peak
3	5150.00	22.36	28.68	51.04	54.00	2.96	Average
4	5150.00	34.25	28.68	62.93	74.00	11.07	Peak

802.11 ac vht40 mode, High Channel, Horizontal

Project No.: DG2231229-79269E-RF Serial No.: 2FY2-1
 Polarization: Horizontal Tester: Colin Yang
 Test Mode: Transmitting
 Note: 802.11ac40_U-NII-1_high channel 5230MHz

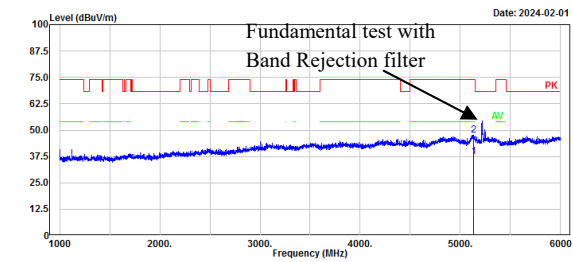

No.	Frequency (MHz)	Reading (dBμV)	Factor (dB/m)	Result (dBμV/m)	Limit (dBμV/m)	Margin (dB)	Detector
1	5130.83	38.79	-1.27	37.52	54.00	16.48	Average
2	5130.83	48.76	-1.27	47.49	74.00	26.51	Peak

802.11 ac vht40 mode, High Channel, Vertical

Project No.: DG2231229-79269E-RF Serial No.: 2FY2-1
 Polarization: Vertical Tester: Colin Yang
 Test Mode: Transmitting
 Note: 802.11ac40_U-NII-1_high channel 5230MHz

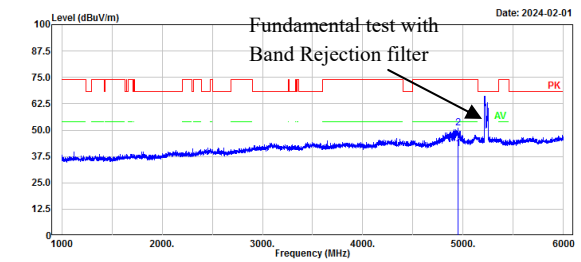

No.	Frequency (MHz)	Reading (dBμV)	Factor (dB/m)	Result (dBμV/m)	Limit (dBμV/m)	Margin (dB)	Detector
1	4947.79	43.67	-2.42	41.25	54.00	12.75	Average
2	4947.79	53.33	-2.42	50.91	74.00	23.09	Peak

Project No.: DG2231229-79269E-RF Serial No.: 2FY2-1
 Polarization: Horizontal Tester: Bill Yang
 Test Mode: Transmitting
 Note: 802.11ac40_U-NII-1_High channel 5230MHz

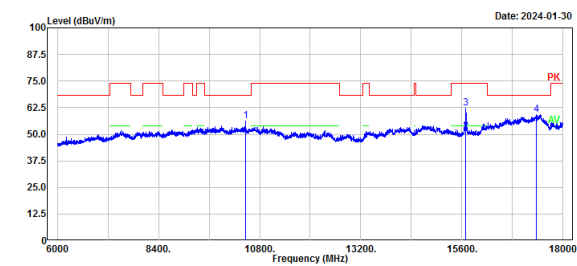

No.	Frequency (MHz)	Reading (dBμV)	Factor (dB/m)	Result (dBμV/m)	Limit (dBμV/m)	Margin (dB)	Detector
1	10460.00	49.77	6.56	56.33	68.20	11.87	Peak
2	15690.00	46.36	4.97	51.33	54.00	2.67	Average
3	15690.00	57.37	4.97	62.34	74.00	11.66	Peak
4	17359.07	44.63	14.74	59.37	68.20	8.83	Peak

Project No.: DG2231229-79269E-RF Serial No.: 2FY2-1
 Polarization: Vertical Tester: Bill Yang
 Test Mode: Transmitting
 Note: 802.11ac40_U-NII-1_High channel 5230MHz

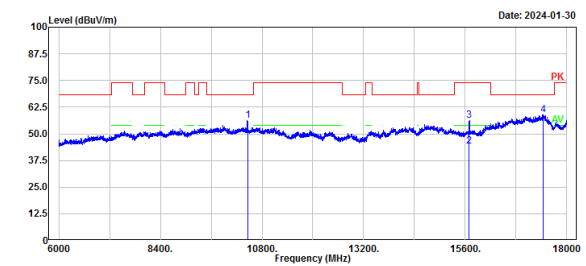

No.	Frequency (MHz)	Reading (dBμV)	Factor (dB/m)	Result (dBμV/m)	Limit (dBμV/m)	Margin (dB)	Detector
1	10460.00	49.56	6.56	56.12	68.20	12.08	Peak
2	15690.00	39.24	4.97	44.21	54.00	9.79	Average
3	15690.00	51.11	4.97	56.08	74.00	17.92	Peak
4	17443.09	43.54	15.42	58.96	68.20	9.24	Peak

802.11 ac vht40 mode, High Channel, Bandedge, Horizontal

Project No.: DG2231229-79269E-RF Serial No.: 2FY2-1
 Polarization: Horizontal Tester: Colin Yang
 Test Mode: Transmitting
 Note: 802.11ac40_U-NII-1_high channel 5230MHz

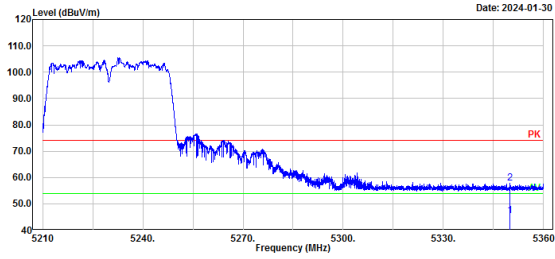

No.	Frequency (MHz)	Reading (dBuV)	Factor (dB/m)	Result (dBuV/m)	Limit (dBuV/m)	Margin (dB)	Detector
1	5350.00	16.23	29.16	45.39	54.00	8.61	Average
2	5350.00	28.56	29.16	57.72	74.00	16.28	Peak

802.11 ac vht40 mode, High Channel, Bandedge, Vertical

Project No.: DG2231229-79269E-RF Serial No.: 2FY2-1
 Polarization: Vertical Tester: Colin Yang
 Test Mode: Transmitting
 Note: 802.11ac40_U-NII-1_high channel 5230MHz

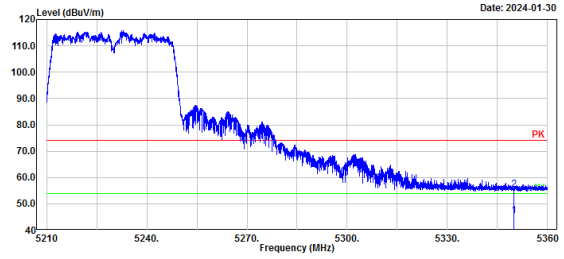

No.	Frequency (MHz)	Reading (dBuV)	Factor (dB/m)	Result (dBuV/m)	Limit (dBuV/m)	Margin (dB)	Detector
1	5350.00	16.32	29.16	45.48	54.00	8.52	Average
2	5350.00	26.33	29.16	55.49	74.00	18.51	Peak

802.11 ac vht80 mode, Middle Channel, Horizontal

Project No.: DG2231229-79269E-RF
 Polarization: Horizontal
 Test Mode: Transmitting
 Note: 802.11ac80_U-NII-1_Middle channel 5210MHz
 Serial No.: 2FY2-1
 Tester: Colin Yang

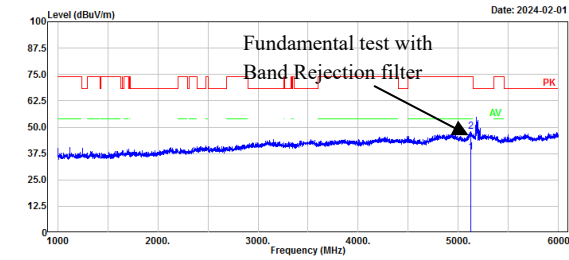

No.	Frequency (MHz)	Reading (dBuV)	Factor (dB/m)	Result (dBuV/m)	Limit (dBuV/m)	Margin (dB)	Detector
1	5125.83	39.35	-1.30	38.05	54.00	15.95	Average
2	5125.83	49.17	-1.30	47.87	74.00	26.13	Peak

802.11 ac vht80 mode, Middle Channel, Vertical

Project No.: DG2231229-79269E-RF
 Polarization: Vertical
 Test Mode: Transmitting
 Note: 802.11ac80_U-NII-1_Middle channel 5210MHz
 Serial No.: 2FY2-1
 Tester: Colin Yang

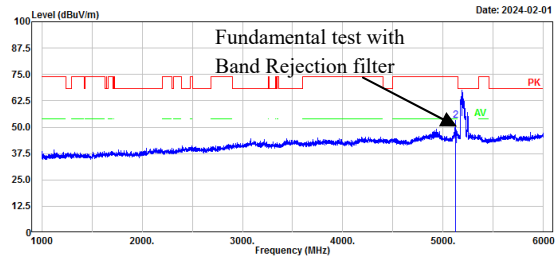

No.	Frequency (MHz)	Reading (dBuV)	Factor (dB/m)	Result (dBuV/m)	Limit (dBuV/m)	Margin (dB)	Detector
1	5121.82	42.36	-1.35	41.01	54.00	12.99	Average
2	5121.82	54.47	-1.35	53.12	74.00	20.88	Peak

Project No.: DG2231229-79269E-RF
 Polarization: Horizontal
 Test Mode: Transmitting
 Note: 802.11ac80_U-NII-1_Middle channel 5210MHz
 Serial No.: 2FY2-1
 Tester: Bill Yang

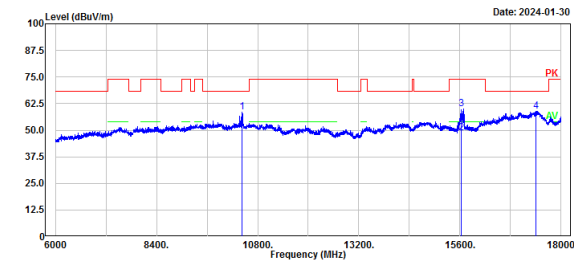

No.	Frequency (MHz)	Reading (dBuV)	Factor (dB/m)	Result (dBuV/m)	Limit (dBuV/m)	Margin (dB)	Detector
1	10420.00	52.04	6.47	58.51	68.20	9.69	Peak
2	15630.00	43.68	4.84	48.52	54.00	5.48	Average
3	15630.00	55.01	4.84	59.85	74.00	14.15	Peak
4	17409.48	43.79	15.15	58.94	68.20	9.26	Peak

Project No.: DG2231229-79269E-RF
 Polarization: Vertical
 Test Mode: Transmitting
 Note: 802.11ac80_U-NII-1_Middle channel 5210MHz
 Serial No.: 2FY2-1
 Tester: Bill Yang

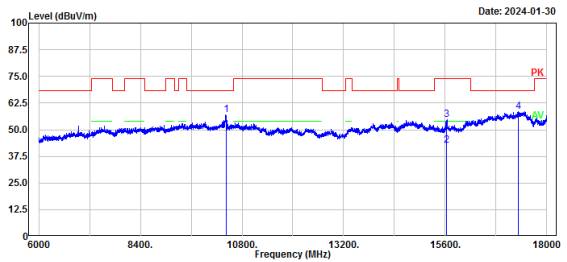

No.	Frequency (MHz)	Reading (dBuV)	Factor (dB/m)	Result (dBuV/m)	Limit (dBuV/m)	Margin (dB)	Detector
1	10420.00	50.60	6.47	57.07	68.20	11.13	Peak
2	15630.00	37.79	4.84	42.63	54.00	11.37	Average
3	15630.00	49.90	4.84	54.74	74.00	19.26	Peak
4	17332.67	44.11	14.52	58.63	68.20	9.57	Peak

802.11 ac vht80 mode, Middle Channel, Bandedge, Horizontal

Project No.: DG2231229-79269E-RF Serial No.: 2FY2-1
 Polarization: Horizontal Tester: Colin Yang
 Test Mode: Transmitting
 Note: 802.11ac80_U-NII-1_Middle channel 5210MHz

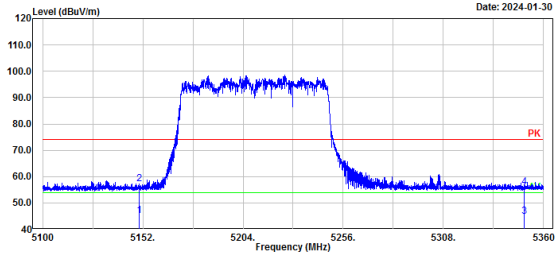

No.	Frequency (MHz)	Reading (dBuV)	Factor (dB/m)	Result (dBuV/m)	Limit (dBuV/m)	Margin (dB)	Detector
1	5150.00	16.42	28.68	45.10	54.00	8.90	Average
2	5150.00	28.56	28.68	57.24	74.00	16.76	Peak
3	5350.00	15.77	29.16	44.93	54.00	9.07	Average
4	5350.00	26.99	29.16	56.15	74.00	17.85	Peak

802.11 ac vht80 mode, Middle Channel, Bandedge, Vertical

Project No.: DG2231229-79269E-RF Serial No.: 2FY2-1
 Polarization: Vertical Tester: Colin Yang
 Test Mode: Transmitting
 Note: 802.11ac80_U-NII-1_Middle channel 5210MHz

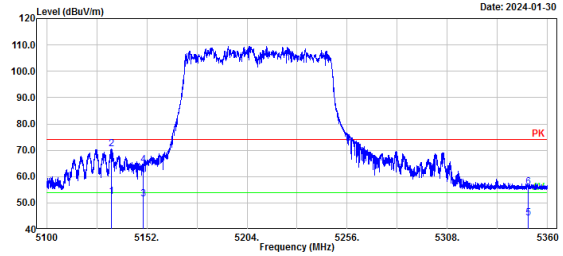

No.	Frequency (MHz)	Reading (dBuV)	Factor (dB/m)	Result (dBuV/m)	Limit (dBuV/m)	Margin (dB)	Detector
1	5133.44	23.68	28.65	52.33	54.00	1.67	Average
2	5133.44	41.73	28.65	70.38	74.00	3.62	Peak
3	5150.00	22.67	28.68	51.35	54.00	2.65	Average
4	5150.00	35.76	28.68	64.44	74.00	9.56	Peak
5	5350.00	15.21	29.16	44.37	54.00	9.63	Average
6	5350.00	26.84	29.16	56.00	74.00	18.00	Peak

802.11 ax he20 mode, Low Channel, Horizontal

Project No.: DG2231229-79269E-RF Serial No.: 2FY2-1
 Polarization: Horizontal Tester: Colin Yang
 Test Mode: Transmitting
 Note: 802.11ax20_U-NII-1_low channel 5180MHz

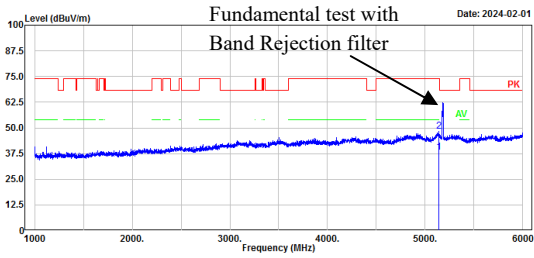

No.	Frequency (MHz)	Reading (dBuV)	Factor (dB/m)	Result (dBuV/m)	Limit (dBuV/m)	Margin (dB)	Detector
1	5138.83	39.18	-1.21	37.97	54.00	16.03	Average
2	5138.83	49.46	-1.21	48.25	74.00	25.75	Peak

802.11 ax he20 mode, Low Channel, Vertical

Project No.: DG2231229-79269E-RF Serial No.: 2FY2-1
 Polarization: Vertical Tester: Colin Yang
 Test Mode: Transmitting
 Note: 802.11ax20_U-NII-1_low channel 5180MHz

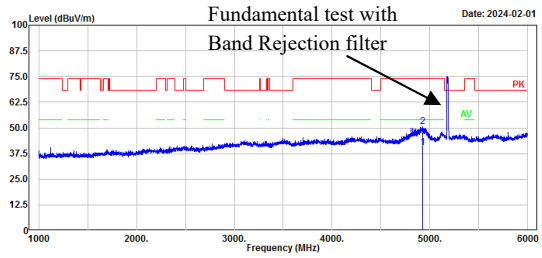

No.	Frequency (MHz)	Reading (dBuV)	Factor (dB/m)	Result (dBuV/m)	Limit (dBuV/m)	Margin (dB)	Detector
1	4924.79	42.87	-2.53	40.34	54.00	13.66	Average
2	4924.79	53.00	-2.53	50.47	74.00	23.53	Peak

Project No.: DG2231229-79269E-RF Serial No.: 2FY2-1
 Polarization: Horizontal Tester: Bill Yang
 Test Mode: Transmitting
 Note: 802.11ax20_U-NII-1_Low channel 5180MHz

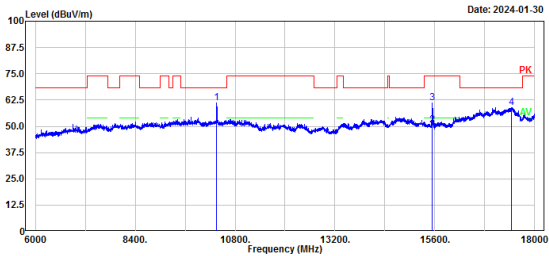

No.	Frequency (MHz)	Reading (dBuV)	Factor (dB/m)	Result (dBuV/m)	Limit (dBuV/m)	Margin (dB)	Detector
1	10360.00	54.61	6.49	61.10	68.20	7.10	Peak
2	15540.00	45.77	4.67	50.44	54.00	3.56	Average
3	15540.00	56.52	4.67	61.19	74.00	12.81	Peak
4	17433.49	43.55	15.34	58.89	68.20	9.31	Peak

Project No.: DG2231229-79269E-RF Serial No.: 2FY2-1
 Polarization: Vertical Tester: Bill Yang
 Test Mode: Transmitting
 Note: 802.11ax20_U-NII-1_Low channel 5180MHz

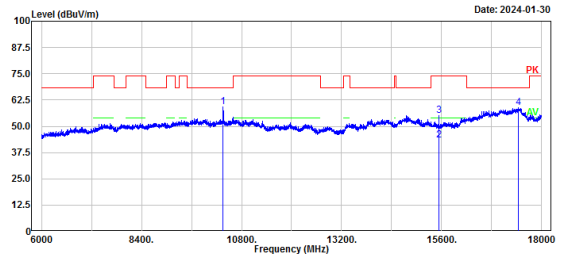

No.	Frequency (MHz)	Reading (dBuV)	Factor (dB/m)	Result (dBuV/m)	Limit (dBuV/m)	Margin (dB)	Detector
1	10360.00	52.62	6.49	59.11	68.20	9.09	Peak
2	15540.00	38.62	4.67	43.29	54.00	10.71	Average
3	15540.00	50.33	4.67	55.00	74.00	19.00	Peak
4	17438.29	43.33	15.38	58.71	68.20	9.49	Peak

802.11 ax he20 mode, Low Channel, Bandedge, Horizontal

Project No.: DG2231229-79269E-RF Serial No.: 2FY2-1
 Polarization: Horizontal Tester: Colin Yang
 Test Mode: Transmitting
 Note: 802.11ax20_U-NII-1_low channel 5180MHz

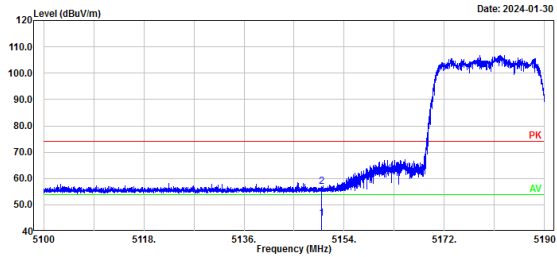

No.	Frequency (MHz)	Reading (dBuV)	Factor (dB/m)	Result (dBuV/m)	Limit (dBuV/m)	Margin (dB)	Detector
1	5150.00	16.11	28.68	44.79	54.00	9.21	Average
2	5150.00	28.37	28.68	57.05	74.00	16.95	Peak

802.11 ax he20 mode, Low Channel, Bandedge, Vertical

Project No.: DG2231229-79269E-RF Serial No.: 2FY2-1
 Polarization: Vertical Tester: Colin Yang
 Test Mode: Transmitting
 Note: 802.11ax20_U-NII-1_low channel 5180MHz

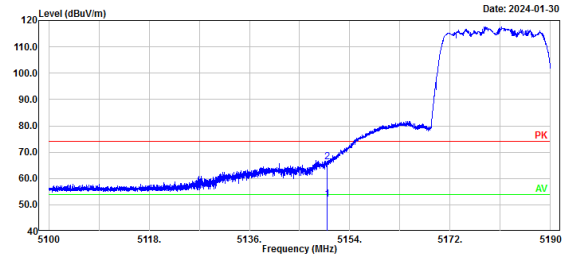

No.	Frequency (MHz)	Reading (dBuV)	Factor (dB/m)	Result (dBuV/m)	Limit (dBuV/m)	Margin (dB)	Detector
1	5150.00	23.34	28.68	52.02	54.00	1.98	Average
2	5150.00	37.68	28.68	66.36	74.00	7.64	Peak

802.11 ax he20 mode, Middle Channel, Horizontal

Project No.: DG2231229-79269E-RF Serial No.: 2FY2-1
 Polarization: Horizontal Tester: Colin Yang
 Test Mode: Transmitting
 Note: 802.11ax20_U-NII-1_middle channel 5200MHz



No.	Frequency (MHz)	Reading (dBμV)	Factor (dB/m)	Result (dBμV/m)	Limit (dBμV/m)	Margin (dB)	Detector
1	5123.83	39.26	-1.34	37.92	54.00	16.08	Average
2	5123.83	49.67	-1.34	48.33	74.00	25.67	Peak

802.11 ax he20 mode, Middle Channel, Vertical

Project No.: DG2231229-79269E-RF Serial No.: 2FY2-1
 Polarization: Vertical Tester: Colin Yang
 Test Mode: Transmitting
 Note: 802.11ax20_U-NII-1_middle channel 5200MHz

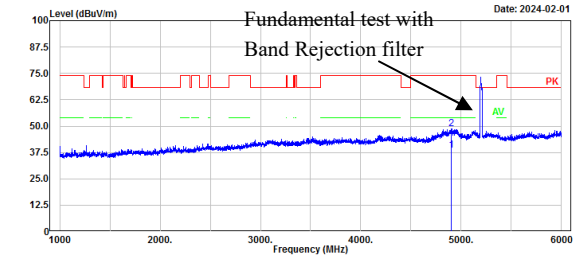

No.	Frequency (MHz)	Reading (dBμV)	Factor (dB/m)	Result (dBμV/m)	Limit (dBμV/m)	Margin (dB)	Detector
1	4898.78	41.24	-2.64	38.60	54.00	15.40	Average
2	4898.78	51.49	-2.64	48.85	74.00	25.15	Peak

Project No.: DG2231229-79269E-RF Serial No.: 2FY2-1
 Polarization: Horizontal Tester: Bill Yang
 Test Mode: Transmitting
 Note: 802.11ax20_U-NII-1_Middle channel 5200MHz

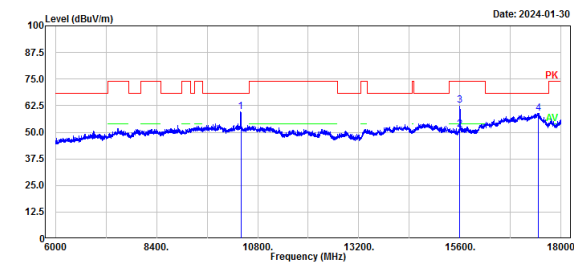

No.	Frequency (MHz)	Reading (dBμV)	Factor (dB/m)	Result (dBμV/m)	Limit (dBμV/m)	Margin (dB)	Detector
1	10400.00	53.36	6.44	59.80	68.20	8.40	Peak
2	15600.00	46.59	4.77	51.36	54.00	2.64	Average
3	15600.00	57.85	4.77	62.62	74.00	11.38	Peak
4	17459.89	43.49	15.55	59.04	68.20	9.16	Peak

Project No.: DG2231229-79269E-RF Serial No.: 2FY2-1
 Polarization: Vertical Tester: Bill Yang
 Test Mode: Transmitting
 Note: 802.11ax20_U-NII-1_Middle channel 5200MHz

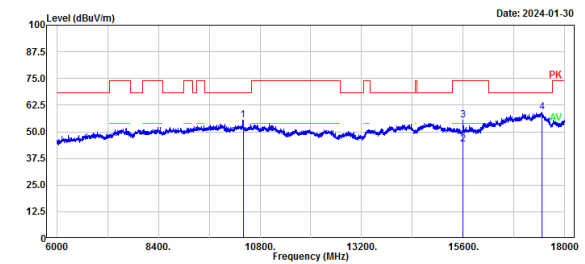

No.	Frequency (MHz)	Reading (dBμV)	Factor (dB/m)	Result (dBμV/m)	Limit (dBμV/m)	Margin (dB)	Detector
1	10400.00	48.93	6.44	55.37	68.20	12.83	Peak
2	15600.00	39.51	4.77	44.28	54.00	9.72	Average
3	15600.00	50.64	4.77	55.41	74.00	18.59	Peak
4	17452.69	43.82	15.50	59.32	68.20	8.88	Peak

802.11 ax he20 mode, High Channel, Horizontal

Project No.: DG2231229-79269E-RF Serial No.: 2FY2-1
 Polarization: Horizontal Tester: Colin Yang
 Test Mode: Transmitting
 Note: 802.11ax20_U-NII-1_high channel 5240MHz

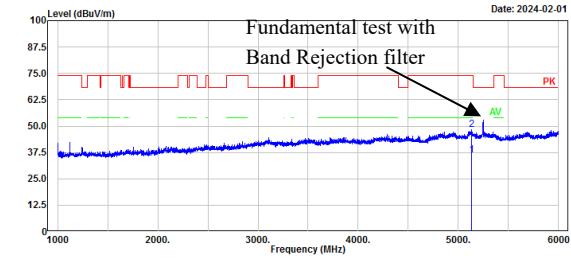

No.	Frequency (MHz)	Reading (dBμV)	Factor (dB/m)	Result (dBμV/m)	Limit (dBμV/m)	Margin (dB)	Detector
1	5131.83	37.50	-1.27	36.23	54.00	17.77	Average
2	5131.83	49.76	-1.27	48.49	74.00	25.51	Peak

802.11 ax he20 mode, High Channel, Vertical

Project No.: DG2231229-79269E-RF Serial No.: 2FY2-1
 Polarization: Vertical Tester: Colin Yang
 Test Mode: Transmitting
 Note: 802.11ax20_U-NII-1_high channel 5240MHz

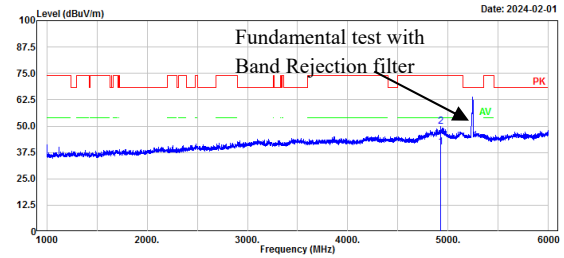

No.	Frequency (MHz)	Reading (dBμV)	Factor (dB/m)	Result (dBμV/m)	Limit (dBμV/m)	Margin (dB)	Detector
1	4927.79	42.38	-2.51	39.87	54.00	14.13	Average
2	4927.79	52.20	-2.51	49.69	74.00	24.31	Peak

Project No.: DG2231229-79269E-RF Serial No.: 2FY2-1
 Polarization: Horizontal Tester: Bill Yang
 Test Mode: Transmitting
 Note: 802.11ax20_U-NII-1_High channel 5240MHz

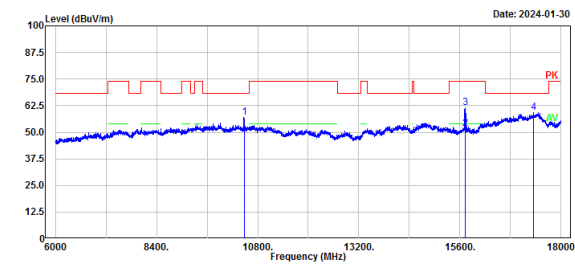

No.	Frequency (MHz)	Reading (dBμV)	Factor (dB/m)	Result (dBμV/m)	Limit (dBμV/m)	Margin (dB)	Detector
1	10480.00	50.56	6.60	57.16	68.20	11.04	Peak
2	15720.00	46.47	5.05	51.52	54.00	2.48	Average
3	15720.00	56.42	5.05	61.47	74.00	12.53	Peak
4	17347.07	44.79	14.63	59.42	68.20	8.78	Peak

Project No.: DG2231229-79269E-RF Serial No.: 2FY2-1
 Polarization: Vertical Tester: Bill Yang
 Test Mode: Transmitting
 Note: 802.11ax20_U-NII-1_High channel 5240MHz

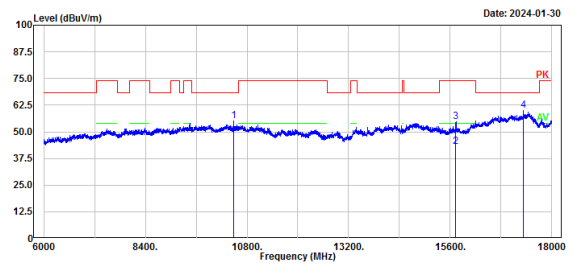

No.	Frequency (MHz)	Reading (dBμV)	Factor (dB/m)	Result (dBμV/m)	Limit (dBμV/m)	Margin (dB)	Detector
1	10480.00	48.57	6.60	55.17	68.20	13.03	Peak
2	15720.00	38.15	5.05	43.20	54.00	10.80	Average
3	15720.00	49.70	5.05	54.75	74.00	19.25	Peak
4	17332.67	45.43	14.52	59.95	68.20	8.25	Peak

802.11 ax he20 mode, High Channel, Bandedge, Horizontal

Project No.: DG2231229-79269E-RF Serial No.: 2FY2-1
 Polarization: Horizontal Tester: Colin Yang
 Test Mode: Transmitting
 Note: 802.11ax20_U-NII-1_hgih channel 5240MHz

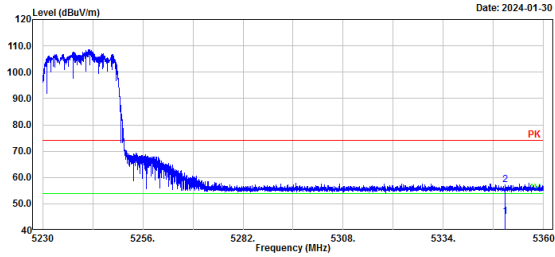

No.	Frequency (MHz)	Reading (dBμV)	Factor (dB/m)	Result (dBμV/m)	Limit (dBμV/m)	Margin (dB)	Detector
1	5350.00	15.98	29.16	45.14	54.00	8.86	Average
2	5350.00	28.16	29.16	57.32	74.00	16.68	Peak

802.11 ax he20 mode, High Channel, Bandedge, Vertical

Project No.: DG2231229-79269E-RF Serial No.: 2FY2-1
 Polarization: Vertical Tester: Colin Yang
 Test Mode: Transmitting
 Note: 802.11ax20_U-NII-1_hgih channel 5240MHz

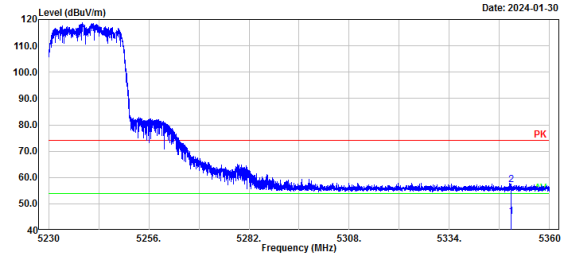

No.	Frequency (MHz)	Reading (dBμV)	Factor (dB/m)	Result (dBμV/m)	Limit (dBμV/m)	Margin (dB)	Detector
1	5350.00	15.87	29.16	45.03	54.00	8.97	Average
2	5350.00	28.00	29.16	57.16	74.00	16.84	Peak

802.11 ax he40 mode, Low Channel, Horizontal

Project No.: DG2231229-79269E-RF Serial No.: 2FY2-1
 Polarization: Horizontal Tester: Colin Yang
 Test Mode: Transmitting
 Note: 802.11ax40_U-NII-1_low channel 5190MHz

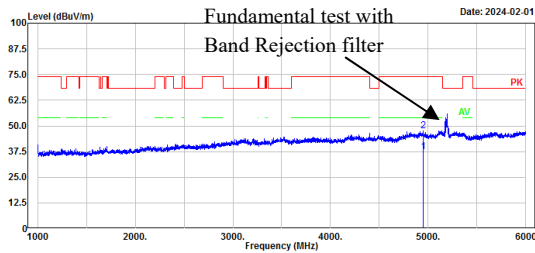

No.	Frequency (MHz)	Reading (dBuV)	Factor (dB/m)	Result (dBuV/m)	Limit (dBuV/m)	Margin (dB)	Detector
1	4949.79	39.62	-2.41	37.21	54.00	16.79	Average
2	4949.79	49.87	-2.41	47.46	74.00	26.54	Peak

802.11 ax he40 mode, Low Channel, Vertical

Project No.: DG2231229-79269E-RF Serial No.: 2FY2-1
 Polarization: Vertical Tester: Colin Yang
 Test Mode: Transmitting
 Note: 802.11ax40_U-NII-1_low channel 5190MHz

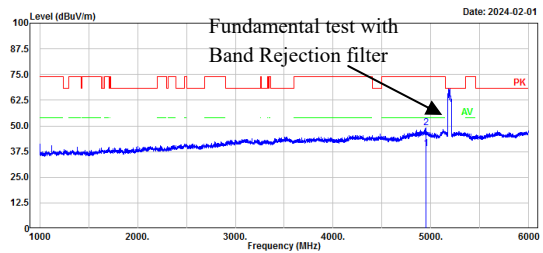

No.	Frequency (MHz)	Reading (dBuV)	Factor (dB/m)	Result (dBuV/m)	Limit (dBuV/m)	Margin (dB)	Detector
1	4947.79	41.45	-2.42	39.03	54.00	14.97	Average
2	4947.79	51.39	-2.42	48.97	74.00	25.03	Peak

Project No.: DG2231229-79269E-RF Serial No.: 2FY2-1
 Polarization: Horizontal Tester: Bill Yang
 Test Mode: Transmitting
 Note: 802.11ax40_U-NII-1_Low channel 5190MHz

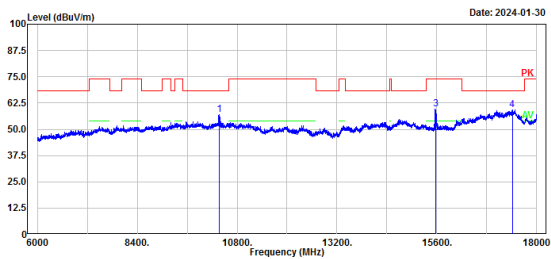

No.	Frequency (MHz)	Reading (dBuV)	Factor (dB/m)	Result (dBuV/m)	Limit (dBuV/m)	Margin (dB)	Detector
1	10380.00	50.45	6.47	56.92	68.20	11.28	Peak
2	15570.00	43.67	4.72	48.39	54.00	5.61	Average
3	15570.00	55.09	4.72	59.81	74.00	14.19	Peak
4	17411.88	44.06	15.17	59.23	68.20	8.97	Peak

Project No.: DG2231229-79269E-RF Serial No.: 2FY2-1
 Polarization: Vertical Tester: Bill Yang
 Test Mode: Transmitting
 Note: 802.11ax40_U-NII-1_Low channel 5190MHz

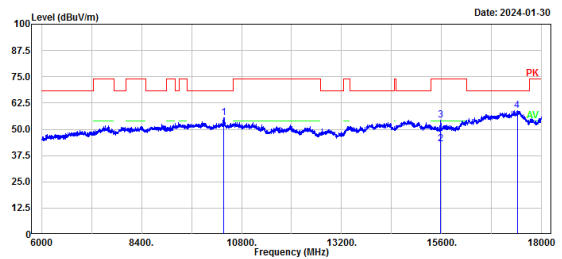

No.	Frequency (MHz)	Reading (dBuV)	Factor (dB/m)	Result (dBuV/m)	Limit (dBuV/m)	Margin (dB)	Detector
1	10380.00	49.11	6.47	55.58	68.20	12.62	Peak
2	15570.00	38.14	4.72	42.86	54.00	11.14	Average
3	15570.00	49.55	4.72	54.27	74.00	19.73	Peak
4	17411.88	43.71	15.17	58.88	68.20	9.32	Peak

802.11 ax he40 mode, Low Channel, Bandedge, Horizontal

Project No.: DG2231229-79269E-RF Serial No.: 2FY2-1
 Polarization: Horizontal Tester: Colin Yang
 Test Mode: Transmitting
 Note: 802.11ax40_U-NII-1_low channel 5190MHz

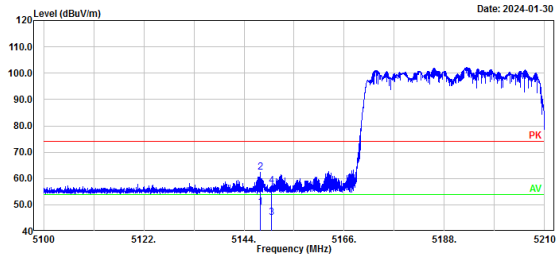

No.	Frequency (MHz)	Reading (dBuV)	Factor (dB/m)	Result (dBuV/m)	Limit (dBuV/m)	Margin (dB)	Detector
1	5147.53	20.42	28.68	49.10	54.00	4.90	Average
2	5147.53	33.55	28.68	62.23	74.00	11.77	Peak
3	5150.00	16.57	28.68	45.25	54.00	8.75	Average
4	5150.00	28.40	28.68	57.08	74.00	16.92	Peak

802.11 ax he40 mode, Low Channel, Bandedge, Vertical

Project No.: DG2231229-79269E-RF Serial No.: 2FY2-1
 Polarization: Vertical Tester: Colin Yang
 Test Mode: Transmitting
 Note: 802.11ax40_U-NII-1_low channel 5190MHz

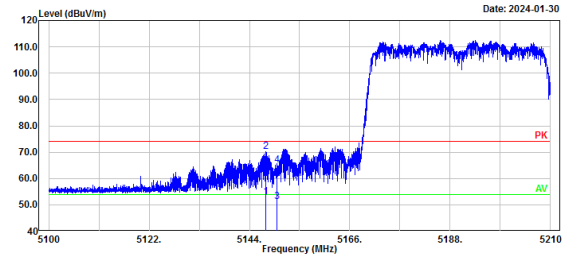

No.	Frequency (MHz)	Reading (dBuV)	Factor (dB/m)	Result (dBuV/m)	Limit (dBuV/m)	Margin (dB)	Detector
1	5147.64	24.26	28.68	52.94	54.00	1.06	Average
2	5147.64	41.42	28.68	70.10	74.00	3.90	Peak
3	5150.00	22.45	28.68	51.13	54.00	2.87	Average
4	5150.00	36.32	28.68	65.00	74.00	9.00	Peak

802.11 ax he40 mode, High Channel, Horizontal

Project No.: DG2231229-79269E-RF Serial No.: 2FY2-1
 Polarization: Horizontal Tester: Colin Yang
 Test Mode: Transmitting
 Note: 802.11ax40_U-NII-1_high channel 5230MHz

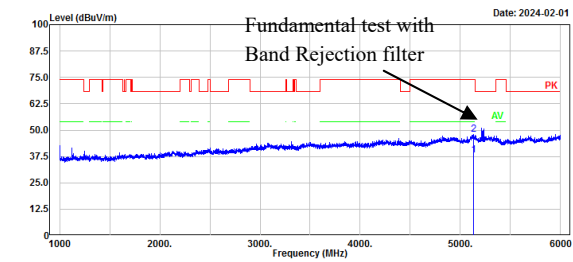

No.	Frequency (MHz)	Reading (dBuV)	Factor (dB/m)	Result (dBuV/m)	Limit (dBuV/m)	Margin (dB)	Detector
1	5131.83	39.46	-1.27	38.19	54.00	15.81	Average
2	5131.83	49.03	-1.27	47.76	74.00	26.24	Peak

802.11 ax he40 mode, High Channel, Vertical

Project No.: DG2231229-79269E-RF Serial No.: 2FY2-1
 Polarization: Vertical Tester: Colin Yang
 Test Mode: Transmitting
 Note: 802.11ax40_U-NII-1_high channel 5230MHz

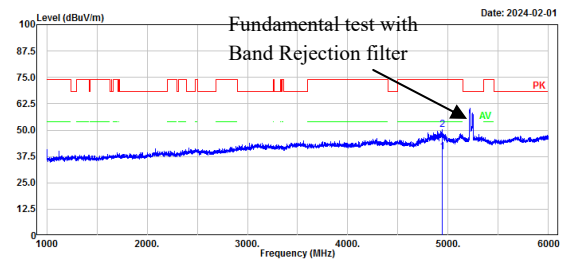

No.	Frequency (MHz)	Reading (dBuV)	Factor (dB/m)	Result (dBuV/m)	Limit (dBuV/m)	Margin (dB)	Detector
1	4938.79	42.15	-2.46	39.69	54.00	14.31	Average
2	4938.79	52.68	-2.46	50.22	74.00	23.78	Peak

Project No.: DG2231229-79269E-RF Serial No.: 2FY2-1
 Polarization: Horizontal Tester: Bill Yang
 Test Mode: Transmitting
 Note: 802.11ax40_U-NII-1_High channel 5230MHz

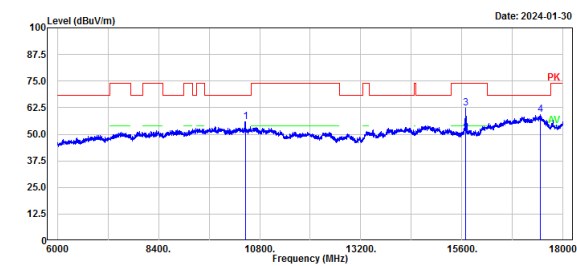

No.	Frequency (MHz)	Reading (dBuV)	Factor (dB/m)	Result (dBuV/m)	Limit (dBuV/m)	Margin (dB)	Detector
1	10460.00	49.23	6.56	55.79	68.20	12.41	Peak
2	15690.00	45.76	4.97	50.73	54.00	3.27	Average
3	15690.00	57.21	4.97	62.18	74.00	11.82	Peak
4	17467.09	43.82	15.61	59.43	68.20	8.77	Peak

Project No.: DG2231229-79269E-RF Serial No.: 2FY2-1
 Polarization: Vertical Tester: Bill Yang
 Test Mode: Transmitting
 Note: 802.11ax40_U-NII-1_High channel 5230MHz

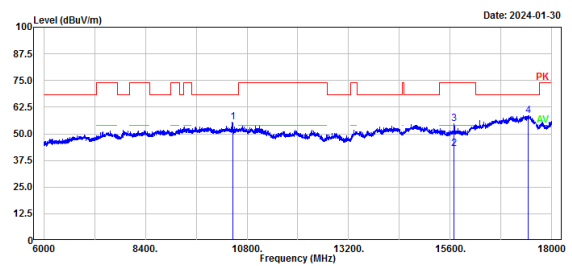

No.	Frequency (MHz)	Reading (dBuV)	Factor (dB/m)	Result (dBuV/m)	Limit (dBuV/m)	Margin (dB)	Detector
1	10460.00	48.76	6.56	55.32	68.20	12.88	Peak
2	15690.00	37.90	4.97	42.87	54.00	11.13	Average
3	15690.00	49.84	4.97	54.81	74.00	19.19	Peak
4	17431.09	43.19	15.33	58.52	68.20	9.68	Peak

802.11 ax he40 mode, High Channel, Bandedge, Horizontal

Project No.: DG2231229-79269E-RF Serial No.: 2FY2-1
 Polarization: Horizontal Tester: Colin Yang
 Test Mode: Transmitting
 Note: 802.11ax40_U-NII-1_high channel 5230MHz

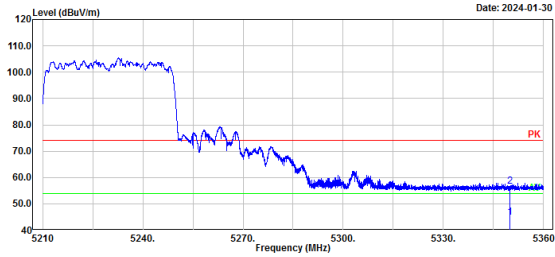

No.	Frequency (MHz)	Reading (dBuV)	Factor (dB/m)	Result (dBuV/m)	Limit (dBuV/m)	Margin (dB)	Detector
1	5350.00	15.71	29.16	44.87	54.00	9.13	Average
2	5350.00	27.44	29.16	56.60	74.00	17.40	Peak

802.11 ax he40 mode, High Channel, Bandedge, Vertical

Project No.: DG2231229-79269E-RF Serial No.: 2FY2-1
 Polarization: Vertical Tester: Colin Yang
 Test Mode: Transmitting
 Note: 802.11ax40_U-NII-1_high channel 5230MHz

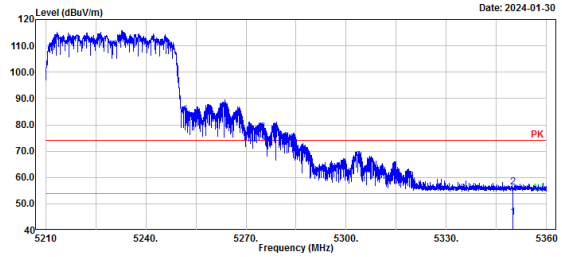

No.	Frequency (MHz)	Reading (dBuV)	Factor (dB/m)	Result (dBuV/m)	Limit (dBuV/m)	Margin (dB)	Detector
1	5350.00	15.68	29.16	44.84	54.00	9.16	Average
2	5350.00	27.28	29.16	56.44	74.00	17.56	Peak

802.11 ax he80 mode, Middle Channel, Horizontal

Project No.: DG2231229-79269E-RF
 Polarization: Horizontal
 Test Mode: Transmitting
 Note: 802.11ax80_U-NII-1_Middle channel 5210MHz

Serial No.: 2FY2-1
 Tester: Colin Yang

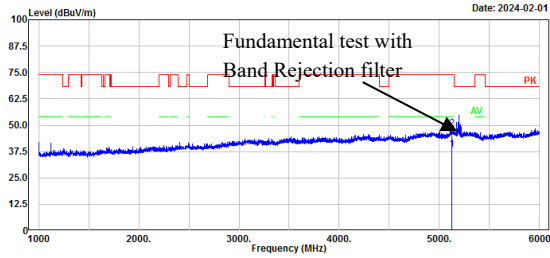

No.	Frequency (MHz)	Reading (dBuV)	Factor (dB/m)	Result (dBuV/m)	Limit (dBuV/m)	Margin (dB)	Detector
1	5123.83	39.68	-1.34	38.34	54.00	15.66	Average
2	5123.83	49.53	-1.34	48.19	74.00	25.81	Peak

802.11 ax he80 mode, Middle Channel, Vertical

Project No.: DG2231229-79269E-RF
 Polarization: Vertical
 Test Mode: Transmitting
 Note: 802.11ax80_U-NII-1_Middle channel 5210MHz

Serial No.: 2FY2-1
 Tester: Colin Yang

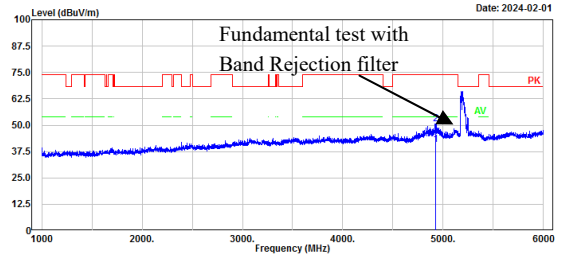

No.	Frequency (MHz)	Reading (dBuV)	Factor (dB/m)	Result (dBuV/m)	Limit (dBuV/m)	Margin (dB)	Detector
1	4922.79	43.31	-2.53	40.78	54.00	13.22	Average
2	4922.79	53.23	-2.53	50.70	74.00	23.30	Peak

Project No.: DG2231229-79269E-RF
 Polarization: Horizontal
 Test Mode: Transmitting
 Note: 802.11ax80_U-NII-1_Middle channel 5210MHz

Serial No.: 2FY2-1
 Tester: Bill Yang

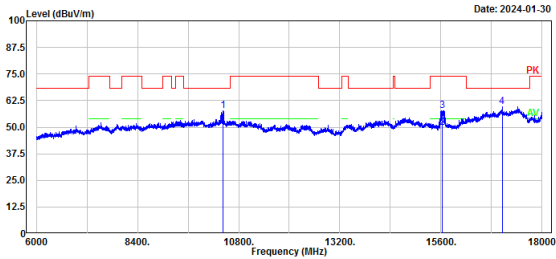

No.	Frequency (MHz)	Reading (dBuV)	Factor (dB/m)	Result (dBuV/m)	Limit (dBuV/m)	Margin (dB)	Detector
1	10420.00	51.18	6.47	57.65	68.20	10.55	Peak
2	15630.00	44.82	4.84	49.66	54.00	4.34	Average
3	15630.00	53.06	4.84	57.90	74.00	16.10	Peak
4	17049.41	47.40	12.35	59.75	68.20	8.45	Peak

Project No.: DG2231229-79269E-RF
 Polarization: Vertical
 Test Mode: Transmitting
 Note: 802.11ax80_U-NII-1_Middle channel 5210MHz

Serial No.: 2FY2-1
 Tester: Bill Yang

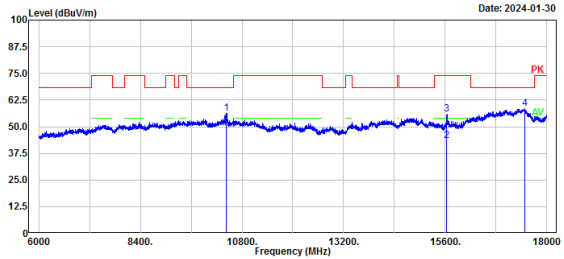

No.	Frequency (MHz)	Reading (dBuV)	Factor (dB/m)	Result (dBuV/m)	Limit (dBuV/m)	Margin (dB)	Detector
1	10420.00	49.88	6.47	56.35	68.20	11.85	Peak
2	15630.00	38.44	4.84	43.28	54.00	10.72	Average
3	15630.00	50.84	4.84	55.68	74.00	18.32	Peak
4	17483.90	42.59	15.74	58.33	68.20	9.87	Peak

802.11 ax he80 mode, Middle Channel, Bandedge, Horizontal

Project No.: DG2231229-79269E-RF Serial No.: 2FY2-1
 Polarization: Horizontal Tester: Colin Yang
 Test Mode: Transmitting
 Note: 802.11ax80_U-NII-1_Middle channel 5210MHz

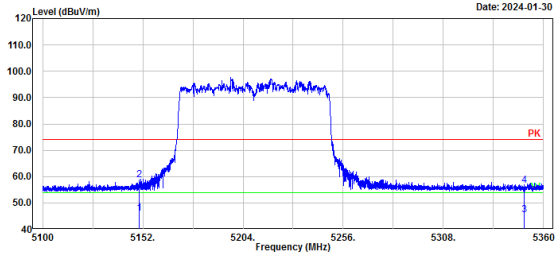

No.	Frequency (MHz)	Reading (dBuV)	Factor (dB/m)	Result (dBuV/m)	Limit (dBuV/m)	Margin (dB)	Detector
1	5150.00	17.23	28.68	45.91	54.00	8.09	Average
2	5150.00	29.93	28.68	58.61	74.00	15.39	Peak
3	5350.00	16.21	29.16	45.37	54.00	8.63	Average
4	5350.00	27.56	29.16	56.72	74.00	17.28	Peak

802.11 ax he80 mode, Middle Channel, Bandedge, Vertical

Project No.: DG2231229-79269E-RF Serial No.: 2FY2-1
 Polarization: Vertical Tester: Colin Yang
 Test Mode: Transmitting
 Note: 802.11ax80_U-NII-1_Middle channel 5210MHz

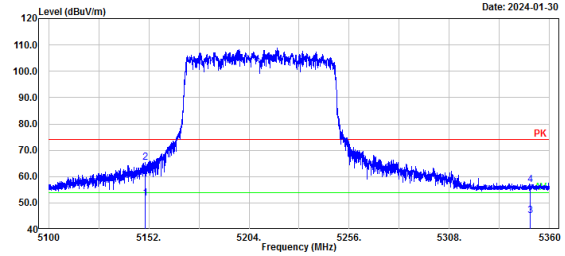

No.	Frequency (MHz)	Reading (dBuV)	Factor (dB/m)	Result (dBuV/m)	Limit (dBuV/m)	Margin (dB)	Detector
1	5150.00	23.14	28.68	51.82	54.00	2.18	Average
2	5150.00	36.73	28.68	65.41	74.00	8.59	Peak
3	5350.00	16.05	29.16	45.21	54.00	8.79	Average
4	5350.00	27.67	29.16	56.83	74.00	17.17	Peak

**5725-5850MHz
SISO, Chain 0:**

802.11a mode, Low Channel, Horizontal	802.11a mode, Low Channel, Vertical																																																																																																																
<p>Project No.: DG2231229-79269E-RF Serial No.: 2FY2-1 Polarization: Horizontal Tester: Colin Yang Test Mode: Transmitting Note: 802.11a_U-NII-3_low channel 5745MHz Chain 0</p> <p style="text-align: right;">Date: 2024-02-01</p> <p style="text-align: center;">Fundamental test with Band Rejection filter</p> <table border="1"> <thead> <tr> <th>No.</th> <th>Frequency (MHz)</th> <th>Reading (dBuV)</th> <th>Factor (dB/m)</th> <th>Result (dBuV/m)</th> <th>Limit (dBuV/m)</th> <th>Margin (dB)</th> <th>Detector</th> </tr> </thead> <tbody> <tr> <td>1</td> <td>5145.83</td> <td>38.45</td> <td>-1.15</td> <td>37.30</td> <td>54.00</td> <td>16.70</td> <td>Average</td> </tr> <tr> <td>2</td> <td>5145.83</td> <td>48.86</td> <td>-1.15</td> <td>47.71</td> <td>74.00</td> <td>26.29</td> <td>Peak</td> </tr> </tbody> </table>	No.	Frequency (MHz)	Reading (dBuV)	Factor (dB/m)	Result (dBuV/m)	Limit (dBuV/m)	Margin (dB)	Detector	1	5145.83	38.45	-1.15	37.30	54.00	16.70	Average	2	5145.83	48.86	-1.15	47.71	74.00	26.29	Peak	<p>Project No.: DG2231229-79269E-RF Serial No.: 2FY2-1 Polarization: Vertical Tester: Colin Yang Test Mode: Transmitting Note: 802.11a_U-NII-3_low channel 5745MHz Chain 0</p> <p style="text-align: right;">Date: 2024-02-01</p> <p style="text-align: center;">Fundamental test with Band Rejection filter</p> <table border="1"> <thead> <tr> <th>No.</th> <th>Frequency (MHz)</th> <th>Reading (dBuV)</th> <th>Factor (dB/m)</th> <th>Result (dBuV/m)</th> <th>Limit (dBuV/m)</th> <th>Margin (dB)</th> <th>Detector</th> </tr> </thead> <tbody> <tr> <td>1</td> <td>5120.82</td> <td>39.47</td> <td>-1.36</td> <td>38.11</td> <td>54.00</td> <td>15.89</td> <td>Average</td> </tr> <tr> <td>2</td> <td>5120.82</td> <td>49.12</td> <td>-1.36</td> <td>47.76</td> <td>74.00</td> <td>26.24</td> <td>Peak</td> </tr> </tbody> </table>	No.	Frequency (MHz)	Reading (dBuV)	Factor (dB/m)	Result (dBuV/m)	Limit (dBuV/m)	Margin (dB)	Detector	1	5120.82	39.47	-1.36	38.11	54.00	15.89	Average	2	5120.82	49.12	-1.36	47.76	74.00	26.24	Peak																																																																
No.	Frequency (MHz)	Reading (dBuV)	Factor (dB/m)	Result (dBuV/m)	Limit (dBuV/m)	Margin (dB)	Detector																																																																																																										
1	5145.83	38.45	-1.15	37.30	54.00	16.70	Average																																																																																																										
2	5145.83	48.86	-1.15	47.71	74.00	26.29	Peak																																																																																																										
No.	Frequency (MHz)	Reading (dBuV)	Factor (dB/m)	Result (dBuV/m)	Limit (dBuV/m)	Margin (dB)	Detector																																																																																																										
1	5120.82	39.47	-1.36	38.11	54.00	15.89	Average																																																																																																										
2	5120.82	49.12	-1.36	47.76	74.00	26.24	Peak																																																																																																										
<p>Project No.: DG2231229-79269E-RF Serial No.: 2FY2-1 Polarization: Horizontal Tester: Colin Yang Test Mode: Transmitting Note: 802.11a_U-NII-3_low channel 5745MHz Chain 0</p> <p style="text-align: right;">Date: 2024-01-29</p> <table border="1"> <thead> <tr> <th>No.</th> <th>Frequency (MHz)</th> <th>Reading (dBuV)</th> <th>Factor (dB/m)</th> <th>Result (dBuV/m)</th> <th>Limit (dBuV/m)</th> <th>Margin (dB)</th> <th>Detector</th> </tr> </thead> <tbody> <tr> <td>1</td> <td>11490.00</td> <td>41.51</td> <td>4.23</td> <td>45.74</td> <td>54.00</td> <td>8.26</td> <td>Average</td> </tr> <tr> <td>2</td> <td>11490.00</td> <td>49.37</td> <td>4.23</td> <td>53.60</td> <td>74.00</td> <td>20.40</td> <td>Peak</td> </tr> <tr> <td>3</td> <td>17235.00</td> <td>42.81</td> <td>13.75</td> <td>56.56</td> <td>68.20</td> <td>11.64</td> <td>Peak</td> </tr> <tr> <td>4</td> <td>17457.49</td> <td>44.70</td> <td>15.53</td> <td>60.23</td> <td>68.20</td> <td>7.97</td> <td>Peak</td> </tr> <tr> <td>5</td> <td>17738.35</td> <td>29.38</td> <td>16.88</td> <td>46.26</td> <td>54.00</td> <td>7.74</td> <td>Average</td> </tr> <tr> <td>6</td> <td>17738.35</td> <td>40.48</td> <td>16.88</td> <td>57.36</td> <td>74.00</td> <td>16.64</td> <td>Peak</td> </tr> </tbody> </table>	No.	Frequency (MHz)	Reading (dBuV)	Factor (dB/m)	Result (dBuV/m)	Limit (dBuV/m)	Margin (dB)	Detector	1	11490.00	41.51	4.23	45.74	54.00	8.26	Average	2	11490.00	49.37	4.23	53.60	74.00	20.40	Peak	3	17235.00	42.81	13.75	56.56	68.20	11.64	Peak	4	17457.49	44.70	15.53	60.23	68.20	7.97	Peak	5	17738.35	29.38	16.88	46.26	54.00	7.74	Average	6	17738.35	40.48	16.88	57.36	74.00	16.64	Peak	<p>Project No.: DG2231229-79269E-RF Serial No.: 2FY2-1 Polarization: Vertical Tester: Colin Yang Test Mode: Transmitting Note: 802.11a_U-NII-3_low channel 5745MHz Chain 0</p> <p style="text-align: right;">Date: 2024-01-29</p> <table border="1"> <thead> <tr> <th>No.</th> <th>Frequency (MHz)</th> <th>Reading (dBuV)</th> <th>Factor (dB/m)</th> <th>Result (dBuV/m)</th> <th>Limit (dBuV/m)</th> <th>Margin (dB)</th> <th>Detector</th> </tr> </thead> <tbody> <tr> <td>1</td> <td>11490.00</td> <td>48.31</td> <td>4.23</td> <td>52.54</td> <td>54.00</td> <td>1.46</td> <td>Average</td> </tr> <tr> <td>2</td> <td>11490.00</td> <td>56.23</td> <td>4.23</td> <td>60.46</td> <td>74.00</td> <td>13.54</td> <td>Peak</td> </tr> <tr> <td>3</td> <td>17235.00</td> <td>42.03</td> <td>13.75</td> <td>55.78</td> <td>68.20</td> <td>12.42</td> <td>Peak</td> </tr> <tr> <td>4</td> <td>17371.07</td> <td>44.92</td> <td>14.83</td> <td>59.75</td> <td>68.20</td> <td>8.45</td> <td>Peak</td> </tr> <tr> <td>5</td> <td>17776.76</td> <td>29.02</td> <td>17.11</td> <td>46.13</td> <td>54.00</td> <td>7.87</td> <td>Average</td> </tr> <tr> <td>6</td> <td>17776.76</td> <td>39.44</td> <td>17.11</td> <td>56.55</td> <td>74.00</td> <td>17.45</td> <td>Peak</td> </tr> </tbody> </table>	No.	Frequency (MHz)	Reading (dBuV)	Factor (dB/m)	Result (dBuV/m)	Limit (dBuV/m)	Margin (dB)	Detector	1	11490.00	48.31	4.23	52.54	54.00	1.46	Average	2	11490.00	56.23	4.23	60.46	74.00	13.54	Peak	3	17235.00	42.03	13.75	55.78	68.20	12.42	Peak	4	17371.07	44.92	14.83	59.75	68.20	8.45	Peak	5	17776.76	29.02	17.11	46.13	54.00	7.87	Average	6	17776.76	39.44	17.11	56.55	74.00	17.45	Peak
No.	Frequency (MHz)	Reading (dBuV)	Factor (dB/m)	Result (dBuV/m)	Limit (dBuV/m)	Margin (dB)	Detector																																																																																																										
1	11490.00	41.51	4.23	45.74	54.00	8.26	Average																																																																																																										
2	11490.00	49.37	4.23	53.60	74.00	20.40	Peak																																																																																																										
3	17235.00	42.81	13.75	56.56	68.20	11.64	Peak																																																																																																										
4	17457.49	44.70	15.53	60.23	68.20	7.97	Peak																																																																																																										
5	17738.35	29.38	16.88	46.26	54.00	7.74	Average																																																																																																										
6	17738.35	40.48	16.88	57.36	74.00	16.64	Peak																																																																																																										
No.	Frequency (MHz)	Reading (dBuV)	Factor (dB/m)	Result (dBuV/m)	Limit (dBuV/m)	Margin (dB)	Detector																																																																																																										
1	11490.00	48.31	4.23	52.54	54.00	1.46	Average																																																																																																										
2	11490.00	56.23	4.23	60.46	74.00	13.54	Peak																																																																																																										
3	17235.00	42.03	13.75	55.78	68.20	12.42	Peak																																																																																																										
4	17371.07	44.92	14.83	59.75	68.20	8.45	Peak																																																																																																										
5	17776.76	29.02	17.11	46.13	54.00	7.87	Average																																																																																																										
6	17776.76	39.44	17.11	56.55	74.00	17.45	Peak																																																																																																										

802.11a mode, Low Channel, Bandedge, Horizontal

Project No.: DG2231229-79269E-RF Serial No.: 2FY2-1
 Polarization: Horizontal Tester: Bill Yang
 Test Mode: Transmitting
 Note: 802.11a_U-NII-3_low channel 5745MHz Chain 0

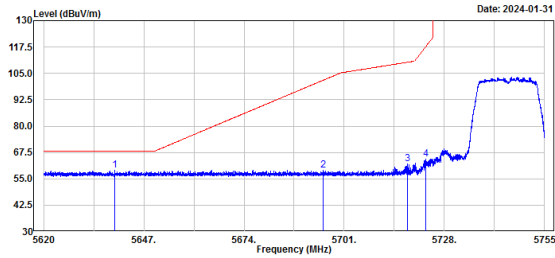

No.	Frequency (MHz)	Reading (dBμV)	Factor (dB/m)	Result (dBμV/m)	Limit (dBμV/m)	Margin (dB)	Detector
1	5639.17	29.30	29.68	58.98	68.20	9.22	Peak
2	5695.24	29.48	29.76	59.24	101.69	42.45	Peak
3	5718.00	32.29	29.80	62.09	110.24	48.15	Peak
4	5723.03	34.63	29.81	64.44	117.70	53.26	Peak

802.11a mode, Low Channel, Bandedge, Vertical

Project No.: DG2231229-79269E-RF Serial No.: 2FY2-1
 Polarization: Vertical Tester: Bill Yang
 Test Mode: Transmitting
 Note: 802.11a_U-NII-3_low channel 5745MHz Chain 0

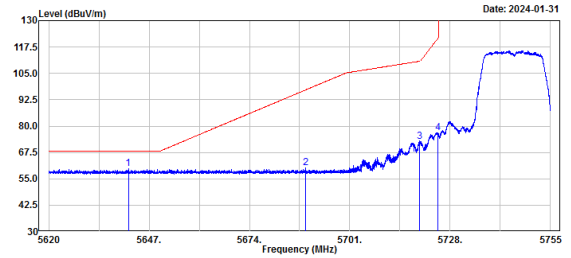

No.	Frequency (MHz)	Reading (dBμV)	Factor (dB/m)	Result (dBμV/m)	Limit (dBμV/m)	Margin (dB)	Detector
1	5641.42	30.13	29.68	59.81	68.20	8.39	Peak
2	5689.03	30.37	29.76	60.13	97.11	36.98	Peak
3	5719.79	42.69	29.80	72.49	110.74	38.25	Peak
4	5724.67	47.16	29.81	76.97	121.45	44.48	Peak

802.11a mode, Middle Channel, Horizontal

Project No.: DG2231229-79269E-RF Serial No.: 2FY2-1
 Polarization: Horizontal Tester: Colin Yang
 Test Mode: Transmitting
 Note: 802.11a_U-NII-3_middle channel 5785MHz Chain 0

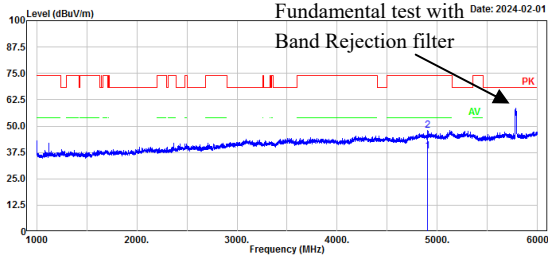

No.	Frequency (MHz)	Reading (dBuV)	Factor (dB/m)	Result (dBuV/m)	Limit (dBuV/m)	Margin (dB)	Detector
1	4900.78	40.82	-2.64	38.18	54.00	15.82	Average
2	4900.78	50.55	-2.64	47.91	74.00	26.09	Peak

802.11a mode, Middle Channel, Vertical

Project No.: DG2231229-79269E-RF Serial No.: 2FY2-1
 Polarization: Vertical Tester: Colin Yang
 Test Mode: Transmitting
 Note: 802.11a_U-NII-3_middle channel 5785MHz Chain 0

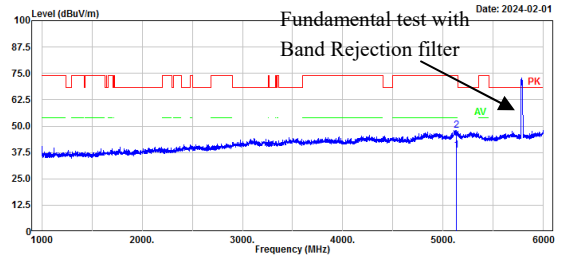

No.	Frequency (MHz)	Reading (dBuV)	Factor (dB/m)	Result (dBuV/m)	Limit (dBuV/m)	Margin (dB)	Detector
1	5133.83	39.61	-1.24	38.37	54.00	15.63	Average
2	5133.83	49.31	-1.24	48.07	74.00	25.93	Peak

Project No.: DG2231229-79269E-RF Serial No.: 2FY2-1
 Polarization: Horizontal Tester: Colin Yang
 Test Mode: Transmitting
 Note: 802.11a_U-NII-3_middle channel 5785MHz Chain 0

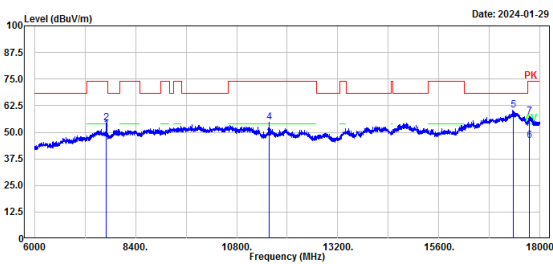

No.	Frequency (MHz)	Reading (dBuV)	Factor (dB/m)	Result (dBuV/m)	Limit (dBuV/m)	Margin (dB)	Detector
1	7711.54	48.48	2.96	51.44	54.00	2.56	Average
2	7711.54	51.52	2.96	54.48	74.00	19.52	Peak
3	11570.00	42.88	4.44	47.32	54.00	6.68	Average
4	11570.00	50.36	4.44	54.80	74.00	19.20	Peak
5	17355.00	45.69	14.70	60.39	68.20	7.81	Peak
6	17743.15	29.31	16.91	46.22	54.00	7.78	Average
7	17743.15	40.39	16.91	57.30	74.00	16.70	Peak

Project No.: DG2231229-79269E-RF Serial No.: 2FY2-1
 Polarization: Vertical Tester: Colin Yang
 Test Mode: Transmitting
 Note: 802.11a_U-NII-3_middle channel 5785MHz Chain 0

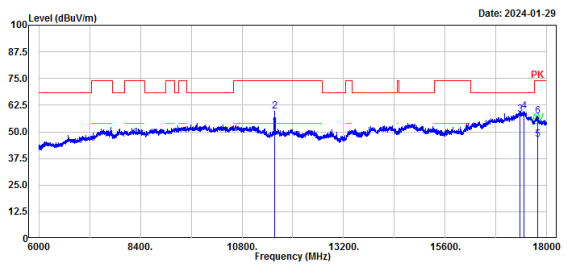

No.	Frequency (MHz)	Reading (dBuV)	Factor (dB/m)	Result (dBuV/m)	Limit (dBuV/m)	Margin (dB)	Detector
1	11570.00	47.68	4.44	52.12	54.00	1.88	Average
2	11570.00	55.26	4.44	59.70	74.00	14.30	Peak
3	17355.00	43.40	14.70	58.10	68.20	10.10	Peak
4	17452.69	44.00	15.50	59.50	68.20	8.70	Peak
5	17791.16	29.14	17.19	46.33	54.00	7.67	Average
6	17791.16	40.08	17.19	57.27	74.00	16.73	Peak

802.11a mode, High Channel, Horizontal

Project No.: DG2231229-79269E-RF Serial No.: 2FY2-1
 Polarization: Horizontal Tester: Colin Yang
 Test Mode: Transmitting
 Note: 802.11a_U-NII-3_high channel 5825MHz Chain 0

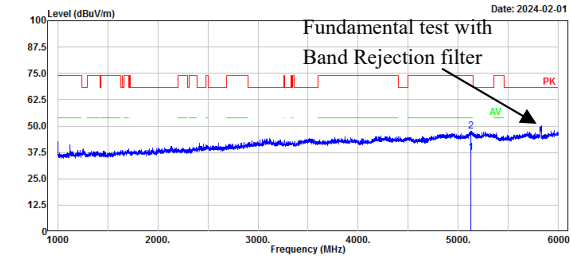

No.	Frequency (MHz)	Reading (dBμV)	Factor (dB/m)	Result (dBμV/m)	Limit (dBμV/m)	Margin (dB)	Detector
1	5125.83	38.66	-1.30	37.36	54.00	16.64	Average
2	5125.83	48.93	-1.30	47.63	74.00	26.37	Peak

802.11a mode, High Channel, Vertical

Project No.: DG2231229-79269E-RF Serial No.: 2FY2-1
 Polarization: Vertical Tester: Colin Yang
 Test Mode: Transmitting
 Note: 802.11a_U-NII-3_high channel 5825MHz Chain 0

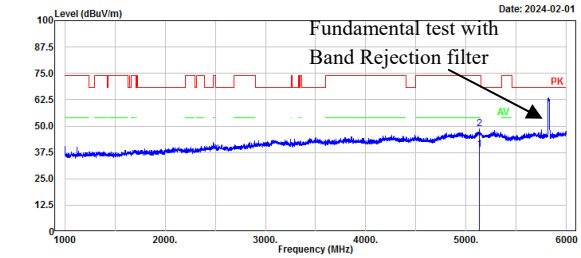

No.	Frequency (MHz)	Reading (dBμV)	Factor (dB/m)	Result (dBμV/m)	Limit (dBμV/m)	Margin (dB)	Detector
1	5128.83	40.18	-1.29	38.89	54.00	15.11	Average
2	5128.83	50.01	-1.29	48.72	74.00	25.28	Peak

Project No.: DG2231229-79269E-RF Serial No.: 2FY2-1
 Polarization: Horizontal Tester: Colin Yang
 Test Mode: Transmitting
 Note: 802.11a_U-NII-3_high channel 5825MHz Chain 0

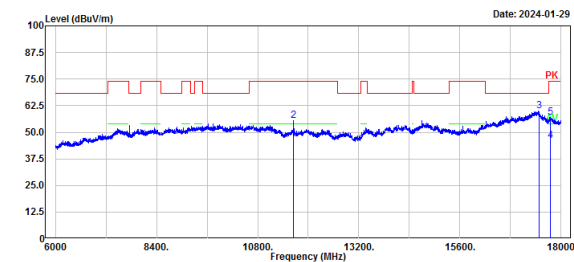

No.	Frequency (MHz)	Reading (dBμV)	Factor (dB/m)	Result (dBμV/m)	Limit (dBμV/m)	Margin (dB)	Detector
1	11650.00	42.45	4.52	46.97	54.00	7.03	Average
2	11650.00	50.87	4.52	55.39	74.00	18.61	Peak
3	17475.00	44.27	15.67	59.94	68.20	8.26	Peak
4	17743.15	29.17	16.91	46.08	54.00	7.92	Average
5	17743.15	40.16	16.91	57.07	74.00	16.93	Peak

Project No.: DG2231229-79269E-RF Serial No.: 2FY2-1
 Polarization: Vertical Tester: Colin Yang
 Test Mode: Transmitting
 Note: 802.11a_U-NII-3_high channel 5825MHz Chain 0

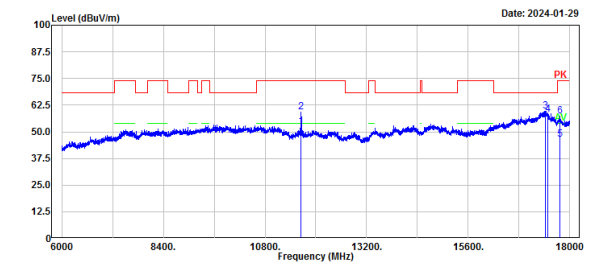

No.	Frequency (MHz)	Reading (dBμV)	Factor (dB/m)	Result (dBμV/m)	Limit (dBμV/m)	Margin (dB)	Detector
1	11650.00	47.88	4.52	52.40	54.00	1.60	Average
2	11650.00	54.54	4.52	59.06	74.00	14.94	Peak
3	17414.28	44.44	15.19	59.63	68.20	8.57	Peak
4	17475.00	42.26	15.67	57.93	68.20	10.27	Peak
5	17764.75	29.35	17.03	46.38	54.00	7.62	Average
6	17764.75	40.29	17.03	57.32	74.00	16.68	Peak

802.11a mode, High Channel, Bandedge, Horizontal

Project No.: DG2231229-79269E-RF Serial No.: 2FY2-1
 Polarization: Horizontal Tester: Bill Yang
 Test Mode: Transmitting
 Note: 802.11a_U-NII-3_High channel 5825MHz Chain 0

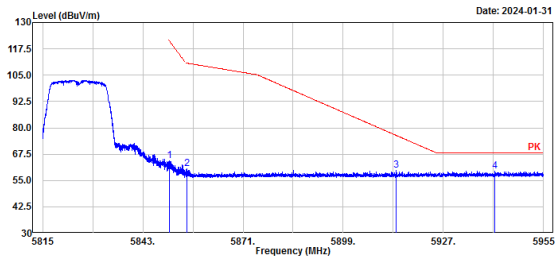

No.	Frequency (MHz)	Reading (dBuV)	Factor (dB/m)	Result (dBuV/m)	Limit (dBuV/m)	Margin (dB)	Detector
1	5850.54	34.52	29.99	64.51	120.97	56.46	Peak
2	5855.41	30.65	30.00	60.65	110.68	50.03	Peak
3	5913.75	29.72	30.09	59.81	76.50	16.69	Peak
4	5941.36	29.46	30.11	59.57	68.20	8.63	Peak

802.11a mode, High Channel, Bandedge, Vertical

Project No.: DG2231229-79269E-RF Serial No.: 2FY2-1
 Polarization: Vertical Tester: Bill Yang
 Test Mode: Transmitting
 Note: 802.11a_U-NII-3_High channel 5825MHz Chain 0

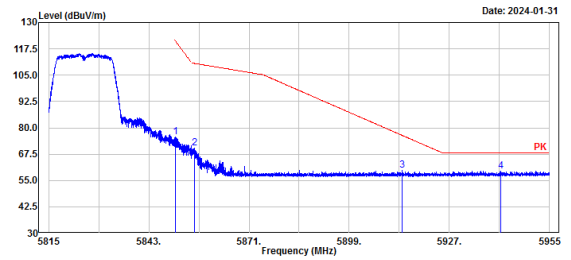

No.	Frequency (MHz)	Reading (dBuV)	Factor (dB/m)	Result (dBuV/m)	Limit (dBuV/m)	Margin (dB)	Detector
1	5850.54	45.53	29.99	75.52	120.97	45.45	Peak
2	5855.69	40.22	30.00	70.22	110.61	40.39	Peak
3	5913.75	29.72	30.09	59.81	76.50	16.69	Peak
4	5941.36	29.46	30.11	59.57	68.20	8.63	Peak

Chain 1:

802.11a mode, Low Channel, Horizontal		802.11a mode, Low Channel, Vertical																																																																																																																	
Project No.: DG2231229-79269E-RF Serial No.: 2FY2-1 Polarization: Horizontal Tester: Colin Yang Test Mode: Transmitting Note: 802.11a_U-NII-3_low channel 5745MHz Chain 1		Project No.: DG2231229-79269E-RF Serial No.: 2FY2-1 Polarization: Vertical Tester: Colin Yang Test Mode: Transmitting Note: 802.11a_U-NII-3_low channel 5745MHz Chain 1																																																																																																																	
<table border="1"> <thead> <tr> <th>No.</th> <th>Frequency (MHz)</th> <th>Reading (dBuV)</th> <th>Factor (dB/m)</th> <th>Result (dBuV/m)</th> <th>Limit (dBuV/m)</th> <th>Margin (dB)</th> <th>Detector</th> </tr> </thead> <tbody> <tr> <td>1</td> <td>5130.83</td> <td>38.31</td> <td>-1.27</td> <td>37.04</td> <td>54.00</td> <td>16.96</td> <td>Average</td> </tr> <tr> <td>2</td> <td>5130.83</td> <td>48.70</td> <td>-1.27</td> <td>47.43</td> <td>74.00</td> <td>26.57</td> <td>Peak</td> </tr> </tbody> </table>		No.	Frequency (MHz)	Reading (dBuV)	Factor (dB/m)	Result (dBuV/m)	Limit (dBuV/m)	Margin (dB)	Detector	1	5130.83	38.31	-1.27	37.04	54.00	16.96	Average	2	5130.83	48.70	-1.27	47.43	74.00	26.57	Peak	<table border="1"> <thead> <tr> <th>No.</th> <th>Frequency (MHz)</th> <th>Reading (dBuV)</th> <th>Factor (dB/m)</th> <th>Result (dBuV/m)</th> <th>Limit (dBuV/m)</th> <th>Margin (dB)</th> <th>Detector</th> </tr> </thead> <tbody> <tr> <td>1</td> <td>5118.82</td> <td>38.61</td> <td>-1.37</td> <td>37.24</td> <td>54.00</td> <td>16.76</td> <td>Average</td> </tr> <tr> <td>2</td> <td>5118.82</td> <td>48.94</td> <td>-1.37</td> <td>47.57</td> <td>74.00</td> <td>26.43</td> <td>Peak</td> </tr> </tbody> </table>		No.	Frequency (MHz)	Reading (dBuV)	Factor (dB/m)	Result (dBuV/m)	Limit (dBuV/m)	Margin (dB)	Detector	1	5118.82	38.61	-1.37	37.24	54.00	16.76	Average	2	5118.82	48.94	-1.37	47.57	74.00	26.43	Peak																																																																
No.	Frequency (MHz)	Reading (dBuV)	Factor (dB/m)	Result (dBuV/m)	Limit (dBuV/m)	Margin (dB)	Detector																																																																																																												
1	5130.83	38.31	-1.27	37.04	54.00	16.96	Average																																																																																																												
2	5130.83	48.70	-1.27	47.43	74.00	26.57	Peak																																																																																																												
No.	Frequency (MHz)	Reading (dBuV)	Factor (dB/m)	Result (dBuV/m)	Limit (dBuV/m)	Margin (dB)	Detector																																																																																																												
1	5118.82	38.61	-1.37	37.24	54.00	16.76	Average																																																																																																												
2	5118.82	48.94	-1.37	47.57	74.00	26.43	Peak																																																																																																												
Project No.: DG2231229-79269E-RF Serial No.: 2FY2-1 Polarization: Horizontal Tester: Colin Yang Test Mode: Transmitting Note: 802.11a_U-NII-3_low channel 5745MHz Chain 1		Project No.: DG2231229-79269E-RF Serial No.: 2FY2-1 Polarization: Vertical Tester: Colin Yang Test Mode: Transmitting Note: 802.11a_U-NII-3_low channel 5745MHz Chain 1																																																																																																																	
<table border="1"> <thead> <tr> <th>No.</th> <th>Frequency (MHz)</th> <th>Reading (dBuV)</th> <th>Factor (dB/m)</th> <th>Result (dBuV/m)</th> <th>Limit (dBuV/m)</th> <th>Margin (dB)</th> <th>Detector</th> </tr> </thead> <tbody> <tr> <td>1</td> <td>11490.00</td> <td>42.31</td> <td>4.23</td> <td>46.54</td> <td>54.00</td> <td>7.46</td> <td>Average</td> </tr> <tr> <td>2</td> <td>11490.00</td> <td>50.29</td> <td>4.23</td> <td>54.52</td> <td>74.00</td> <td>19.48</td> <td>Peak</td> </tr> <tr> <td>3</td> <td>17235.00</td> <td>42.42</td> <td>13.75</td> <td>56.17</td> <td>68.20</td> <td>12.03</td> <td>Peak</td> </tr> <tr> <td>4</td> <td>17419.08</td> <td>44.52</td> <td>15.23</td> <td>59.75</td> <td>68.20</td> <td>8.45</td> <td>Peak</td> </tr> <tr> <td>5</td> <td>17759.95</td> <td>29.22</td> <td>17.00</td> <td>46.22</td> <td>54.00</td> <td>7.78</td> <td>Average</td> </tr> <tr> <td>6</td> <td>17759.95</td> <td>40.00</td> <td>17.00</td> <td>57.00</td> <td>74.00</td> <td>17.00</td> <td>Peak</td> </tr> </tbody> </table>		No.	Frequency (MHz)	Reading (dBuV)	Factor (dB/m)	Result (dBuV/m)	Limit (dBuV/m)	Margin (dB)	Detector	1	11490.00	42.31	4.23	46.54	54.00	7.46	Average	2	11490.00	50.29	4.23	54.52	74.00	19.48	Peak	3	17235.00	42.42	13.75	56.17	68.20	12.03	Peak	4	17419.08	44.52	15.23	59.75	68.20	8.45	Peak	5	17759.95	29.22	17.00	46.22	54.00	7.78	Average	6	17759.95	40.00	17.00	57.00	74.00	17.00	Peak	<table border="1"> <thead> <tr> <th>No.</th> <th>Frequency (MHz)</th> <th>Reading (dBuV)</th> <th>Factor (dB/m)</th> <th>Result (dBuV/m)</th> <th>Limit (dBuV/m)</th> <th>Margin (dB)</th> <th>Detector</th> </tr> </thead> <tbody> <tr> <td>1</td> <td>11490.00</td> <td>47.21</td> <td>4.23</td> <td>51.44</td> <td>54.00</td> <td>2.56</td> <td>Average</td> </tr> <tr> <td>2</td> <td>11490.00</td> <td>54.96</td> <td>4.23</td> <td>59.19</td> <td>74.00</td> <td>14.81</td> <td>Peak</td> </tr> <tr> <td>3</td> <td>17235.00</td> <td>42.93</td> <td>13.75</td> <td>56.68</td> <td>68.20</td> <td>11.52</td> <td>Peak</td> </tr> <tr> <td>4</td> <td>17371.07</td> <td>44.91</td> <td>14.83</td> <td>59.74</td> <td>68.20</td> <td>8.46</td> <td>Peak</td> </tr> <tr> <td>5</td> <td>17807.96</td> <td>29.24</td> <td>17.28</td> <td>46.52</td> <td>54.00</td> <td>7.48</td> <td>Average</td> </tr> <tr> <td>6</td> <td>17807.96</td> <td>39.53</td> <td>17.28</td> <td>56.81</td> <td>74.00</td> <td>17.19</td> <td>Peak</td> </tr> </tbody> </table>		No.	Frequency (MHz)	Reading (dBuV)	Factor (dB/m)	Result (dBuV/m)	Limit (dBuV/m)	Margin (dB)	Detector	1	11490.00	47.21	4.23	51.44	54.00	2.56	Average	2	11490.00	54.96	4.23	59.19	74.00	14.81	Peak	3	17235.00	42.93	13.75	56.68	68.20	11.52	Peak	4	17371.07	44.91	14.83	59.74	68.20	8.46	Peak	5	17807.96	29.24	17.28	46.52	54.00	7.48	Average	6	17807.96	39.53	17.28	56.81	74.00	17.19	Peak
No.	Frequency (MHz)	Reading (dBuV)	Factor (dB/m)	Result (dBuV/m)	Limit (dBuV/m)	Margin (dB)	Detector																																																																																																												
1	11490.00	42.31	4.23	46.54	54.00	7.46	Average																																																																																																												
2	11490.00	50.29	4.23	54.52	74.00	19.48	Peak																																																																																																												
3	17235.00	42.42	13.75	56.17	68.20	12.03	Peak																																																																																																												
4	17419.08	44.52	15.23	59.75	68.20	8.45	Peak																																																																																																												
5	17759.95	29.22	17.00	46.22	54.00	7.78	Average																																																																																																												
6	17759.95	40.00	17.00	57.00	74.00	17.00	Peak																																																																																																												
No.	Frequency (MHz)	Reading (dBuV)	Factor (dB/m)	Result (dBuV/m)	Limit (dBuV/m)	Margin (dB)	Detector																																																																																																												
1	11490.00	47.21	4.23	51.44	54.00	2.56	Average																																																																																																												
2	11490.00	54.96	4.23	59.19	74.00	14.81	Peak																																																																																																												
3	17235.00	42.93	13.75	56.68	68.20	11.52	Peak																																																																																																												
4	17371.07	44.91	14.83	59.74	68.20	8.46	Peak																																																																																																												
5	17807.96	29.24	17.28	46.52	54.00	7.48	Average																																																																																																												
6	17807.96	39.53	17.28	56.81	74.00	17.19	Peak																																																																																																												

802.11a mode, Low Channel, Bandedge, Horizontal

Project No.: DG2231229-79269E-RF Serial No.: 2FY2-1
 Polarization: Horizontal Tester: Bill Yang
 Test Mode: Transmitting
 Note: 802.11a_U-NII-3_Low channel 5745MHz Chain 1

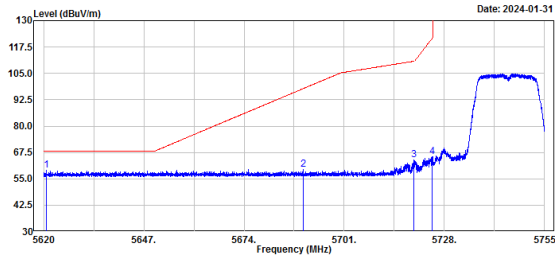

No.	Frequency (MHz)	Reading (dBμV)	Factor (dB/m)	Result (dBμV/m)	Limit (dBμV/m)	Margin (dB)	Detector
1	5620.76	29.23	29.64	58.87	68.20	9.33	Peak
2	5689.97	29.78	29.76	59.54	97.80	38.26	Peak
3	5719.70	34.09	29.80	63.89	110.72	46.83	Peak
4	5724.70	35.48	29.81	65.29	121.52	56.23	Peak

802.11a mode, Low Channel, Bandedge, Vertical

Project No.: DG2231229-79269E-RF Serial No.: 2FY2-1
 Polarization: Vertical Tester: Bill Yang
 Test Mode: Transmitting
 Note: 802.11a_U-NII-3_Low channel 5745MHz Chain 1

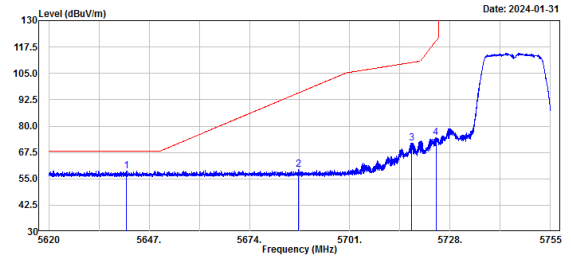

No.	Frequency (MHz)	Reading (dBμV)	Factor (dB/m)	Result (dBμV/m)	Limit (dBμV/m)	Margin (dB)	Detector
1	5640.93	29.04	29.68	58.72	68.20	9.48	Peak
2	5687.16	29.57	29.75	59.32	95.73	36.41	Peak
3	5717.71	42.00	29.80	71.80	110.16	38.36	Peak
4	5724.16	44.80	29.81	74.61	120.28	45.67	Peak

802.11a mode, Middle Channel, Horizontal

Project No.: DG2231229-79269E-RF Serial No.: 2FY2-1
 Polarization: Horizontal Tester: Colin Yang
 Test Mode: Transmitting
 Note: 802.11a_U-NII-3_middle channel 5785MHz Chain 1

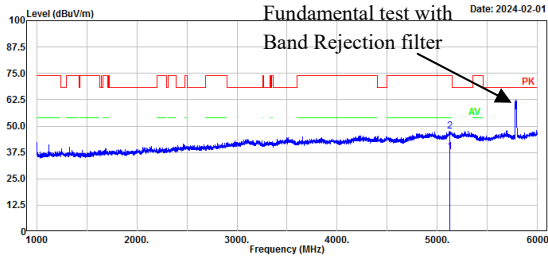

No.	Frequency (MHz)	Reading (dBuV)	Factor (dB/m)	Result (dBuV/m)	Limit (dBuV/m)	Margin (dB)	Detector
1	5121.82	38.92	-1.35	37.57	54.00	16.43	Average
2	5121.82	48.88	-1.35	47.53	74.00	26.47	Peak

802.11a mode, Middle Channel, Vertical

Project No.: DG2231229-79269E-RF Serial No.: 2FY2-1
 Polarization: Vertical Tester: Colin Yang
 Test Mode: Transmitting
 Note: 802.11a_U-NII-3_middle channel 5785MHz Chain 1

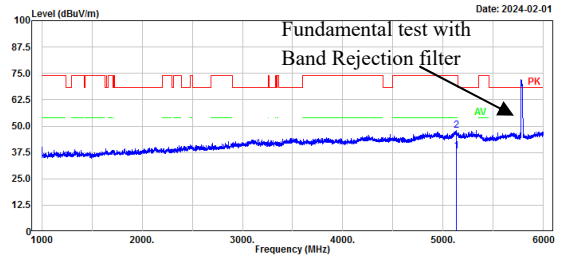

No.	Frequency (MHz)	Reading (dBuV)	Factor (dB/m)	Result (dBuV/m)	Limit (dBuV/m)	Margin (dB)	Detector
1	5129.83	39.52	-1.28	38.24	54.00	15.76	Average
2	5129.83	49.26	-1.28	47.98	74.00	26.02	Peak

Project No.: DG2231229-79269E-RF Serial No.: 2FY2-1
 Polarization: Horizontal Tester: Colin Yang
 Test Mode: Transmitting
 Note: 802.11a_U-NII-3_middle channel 5785MHz Chain 1

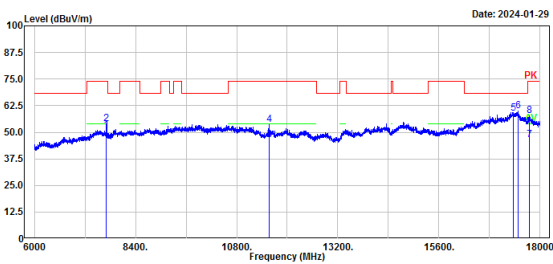

No.	Frequency (MHz)	Reading (dBuV)	Factor (dB/m)	Result (dBuV/m)	Limit (dBuV/m)	Margin (dB)	Detector
1	7711.54	48.08	2.96	51.04	54.00	2.96	Average
2	7711.54	50.95	2.96	53.91	74.00	20.09	Peak
3	11570.00	42.02	4.44	46.46	54.00	7.54	Average
4	11570.00	49.21	4.44	53.65	74.00	20.35	Peak
5	17355.00	44.29	14.70	58.99	68.20	9.21	Peak
6	17476.70	44.31	15.68	59.99	68.20	8.21	Peak
7	17752.75	29.45	16.96	46.41	54.00	7.59	Average
8	17752.75	40.85	16.96	57.81	74.00	16.19	Peak

Project No.: DG2231229-79269E-RF Serial No.: 2FY2-1
 Polarization: Vertical Tester: Colin Yang
 Test Mode: Transmitting
 Note: 802.11a_U-NII-3_middle channel 5785MHz Chain 1

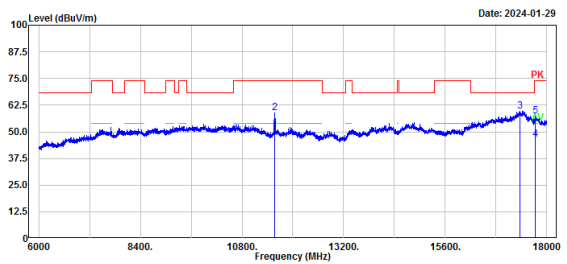

No.	Frequency (MHz)	Reading (dBuV)	Factor (dB/m)	Result (dBuV/m)	Limit (dBuV/m)	Margin (dB)	Detector
1	11570.00	47.13	4.44	51.57	54.00	2.43	Average
2	11570.00	54.31	4.44	58.75	74.00	15.25	Peak
3	17355.00	45.09	14.70	59.79	68.20	8.41	Peak
4	17731.15	29.43	16.83	46.26	54.00	7.74	Average
5	17731.15	40.63	16.83	57.46	74.00	16.54	Peak

802.11a mode, High Channel, Horizontal

Project No.: DG2231229-79269E-RF Serial No.: 2FY2-1
 Polarization: Horizontal Tester: Colin Yang
 Test Mode: Transmitting
 Note: 802.11a_U-NII-3_high channel 5825MHz Chain 1

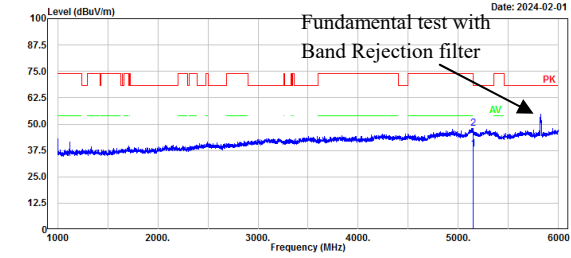

No.	Frequency (MHz)	Reading (dBμV)	Factor (dB/m)	Result (dBμV/m)	Limit (dBμV/m)	Margin (dB)	Detector
1	5148.83	39.32	-1.12	38.20	54.00	15.80	Average
2	5148.83	49.11	-1.12	47.99	74.00	26.01	Peak

802.11a mode, High Channel, Vertical

Project No.: DG2231229-79269E-RF Serial No.: 2FY2-1
 Polarization: Vertical Tester: Colin Yang
 Test Mode: Transmitting
 Note: 802.11a_U-NII-3_high channel 5825MHz Chain 1

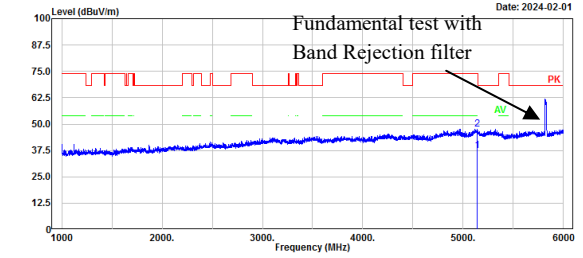

No.	Frequency (MHz)	Reading (dBμV)	Factor (dB/m)	Result (dBμV/m)	Limit (dBμV/m)	Margin (dB)	Detector
1	5139.83	38.67	-1.20	37.47	54.00	16.53	Average
2	5139.83	48.88	-1.20	47.68	74.00	26.32	Peak

Project No.: DG2231229-79269E-RF Serial No.: 2FY2-1
 Polarization: Horizontal Tester: Colin Yang
 Test Mode: Transmitting
 Note: 802.11a_U-NII-3_high channel 5825MHz Chain 1

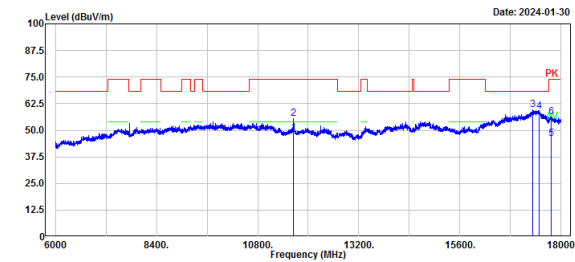

No.	Frequency (MHz)	Reading (dBμV)	Factor (dB/m)	Result (dBμV/m)	Limit (dBμV/m)	Margin (dB)	Detector
1	11650.00	44.08	4.52	48.60	54.00	5.40	Average
2	11650.00	51.08	4.52	55.60	74.00	18.40	Peak
3	17332.67	45.11	14.52	59.63	68.20	8.57	Peak
4	17475.00	43.01	15.67	58.68	68.20	9.52	Peak
5	17767.15	28.97	17.05	46.02	54.00	7.98	Average
6	17767.15	39.36	17.05	56.41	74.00	17.59	Peak

Project No.: DG2231229-79269E-RF Serial No.: 2FY2-1
 Polarization: Vertical Tester: Colin Yang
 Test Mode: Transmitting
 Note: 802.11a_U-NII-3_high channel 5825MHz Chain 1

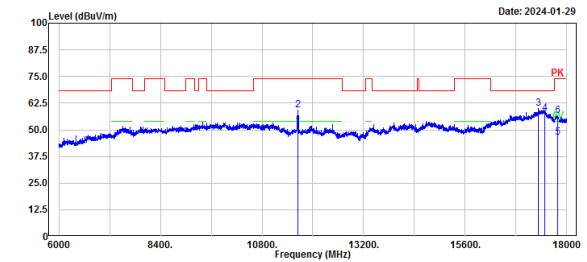

No.	Frequency (MHz)	Reading (dBμV)	Factor (dB/m)	Result (dBμV/m)	Limit (dBμV/m)	Margin (dB)	Detector
1	11650.00	47.26	4.52	51.78	54.00	2.22	Average
2	11650.00	54.60	4.52	59.12	74.00	14.88	Peak
3	17330.27	45.38	14.50	59.88	68.20	8.32	Peak
4	17475.00	42.22	15.67	57.89	68.20	10.31	Peak
5	17786.36	29.27	17.16	46.43	54.00	7.57	Average
6	17786.36	39.46	17.16	56.62	74.00	17.38	Peak

802.11a mode, High Channel, Bandedge, Horizontal

Project No.: DG2231229-79269E-RF Serial No.: 2FY2-1
 Polarization: Horizontal Tester: Bill Yang
 Test Mode: Transmitting
 Note: 802.11a_U-NII-3_High channel 5825MHz Chain 1

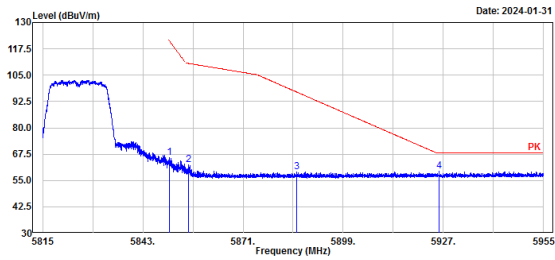

No.	Frequency (MHz)	Reading (dBuV)	Factor (dB/m)	Result (dBuV/m)	Limit (dBuV/m)	Margin (dB)	Detector
1	5850.51	35.95	29.99	65.94	121.03	55.09	Peak
2	5855.83	32.53	30.00	62.53	110.57	48.04	Peak
3	5885.94	28.97	30.05	59.02	97.08	38.06	Peak
4	5925.82	29.22	30.10	59.32	68.20	8.88	Peak

802.11a mode, High Channel, Bandedge, Vertical

Project No.: DG2231229-79269E-RF Serial No.: 2FY2-1
 Polarization: Vertical Tester: Bill Yang
 Test Mode: Transmitting
 Note: 802.11a_U-NII-3_High channel 5825MHz Chain 1

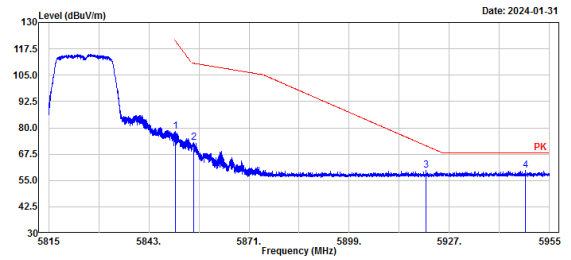

No.	Frequency (MHz)	Reading (dBuV)	Factor (dB/m)	Result (dBuV/m)	Limit (dBuV/m)	Margin (dB)	Detector
1	5850.51	48.23	29.99	78.22	121.03	42.81	Peak
2	5855.61	43.13	30.00	73.13	110.63	37.50	Peak
3	5920.39	29.74	30.09	59.83	71.60	11.77	Peak
4	5948.22	29.52	30.12	59.64	68.20	8.56	Peak

MIMO:

802.11n ht20 mode, Low Channel, Horizontal

Project No.: DG2231229-79269E-RF Serial No.: 2FY2-1
 Polarization: Horizontal Tester: Colin Yang
 Test Mode: Transmitting
 Note: 802.11n20_U-NII-3_low channel 5745MHz

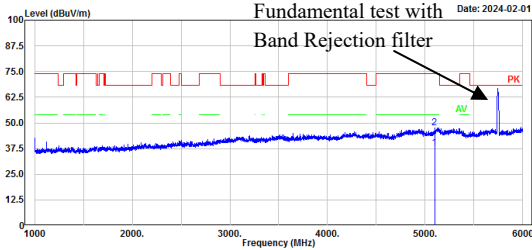

No.	Frequency (MHz)	Reading (dBuV)	Factor (dB/m)	Result (dBuV/m)	Limit (dBuV/m)	Margin (dB)	Detector
1	5095.82	39.22	-1.56	37.66	54.00	16.34	Average
2	5095.82	49.19	-1.56	47.63	74.00	26.37	Peak

802.11n ht20 mode, Low Channel, Vertical

Project No.: DG2231229-79269E-RF Serial No.: 2FY2-1
 Polarization: Vertical Tester: Colin Yang
 Test Mode: Transmitting
 Note: 802.11n20_U-NII-3_low channel 5745MHz

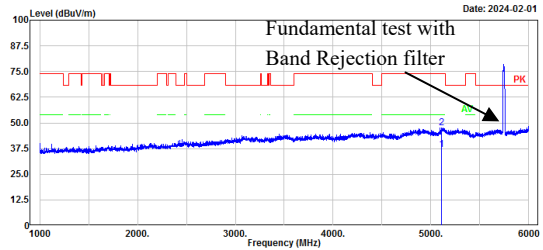

No.	Frequency (MHz)	Reading (dBuV)	Factor (dB/m)	Result (dBuV/m)	Limit (dBuV/m)	Margin (dB)	Detector
1	5106.82	38.55	-1.48	37.07	54.00	16.93	Average
2	5106.82	48.96	-1.48	47.48	74.00	26.52	Peak

Project No.: DG2231229-79269E-RF Serial No.: 2FY2-1
 Polarization: Horizontal Tester: Colin Yang
 Test Mode: Transmitting
 Note: 802.11n20_U-NII-3_low channel 5745MHz

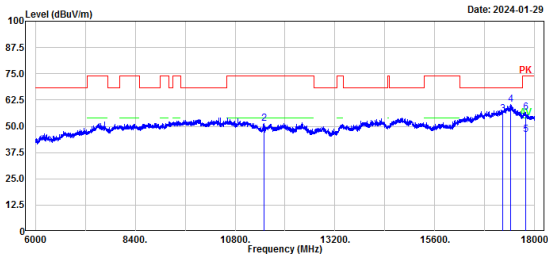

No.	Frequency (MHz)	Reading (dBuV)	Factor (dB/m)	Result (dBuV/m)	Limit (dBuV/m)	Margin (dB)	Detector
1	11490.00	41.31	4.23	45.54	54.00	8.46	Average
2	11490.00	47.06	4.23	51.29	74.00	22.71	Peak
3	17235.00	41.93	13.75	55.68	68.20	12.52	Peak
4	17416.68	45.11	15.22	60.33	68.20	7.87	Peak
5	17781.56	29.07	17.13	46.20	54.00	7.80	Average
6	17781.56	39.59	17.13	56.72	74.00	17.28	Peak

Project No.: DG2231229-79269E-RF Serial No.: 2FY2-1
 Polarization: Vertical Tester: Colin Yang
 Test Mode: Transmitting
 Note: 802.11n20_U-NII-3_low channel 5745MHz

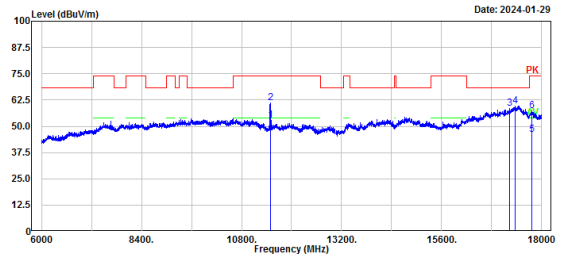

No.	Frequency (MHz)	Reading (dBuV)	Factor (dB/m)	Result (dBuV/m)	Limit (dBuV/m)	Margin (dB)	Detector
1	11490.00	48.44	4.23	52.67	54.00	1.33	Average
2	11490.00	57.01	4.23	61.24	74.00	12.76	Peak
3	17235.00	44.76	13.75	58.51	68.20	9.69	Peak
4	17361.47	45.00	14.76	59.76	68.20	8.44	Peak
5	17764.75	29.04	17.03	46.07	54.00	7.93	Average
6	17764.75	40.47	17.03	57.50	74.00	16.50	Peak

802.11n ht20 mode, Low Channel, Bandedge, Horizontal

Project No.: DG2231229-79269E-RF Serial No.: 2FY2-1
 Polarization: Horizontal Tester: Bill Yang
 Test Mode: Transmitting
 Note: 802.11n20_U-NII-3_low channel 5745MHz

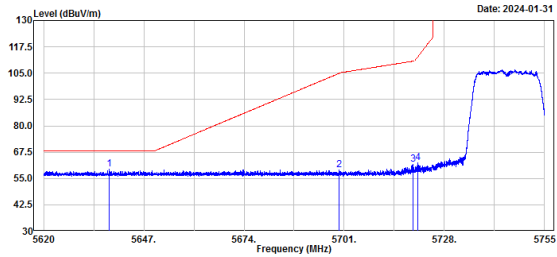

No.	Frequency (MHz)	Reading (dBuV)	Factor (dB/m)	Result (dBuV/m)	Limit (dBuV/m)	Margin (dB)	Detector
1	5637.69	29.81	29.68	59.49	68.20	8.71	Peak
2	5699.69	29.35	29.77	59.12	104.97	45.85	Peak
3	5719.49	32.01	29.80	61.81	110.66	48.85	Peak
4	5728.78	32.57	29.80	62.37	112.59	50.22	Peak

802.11n ht20 mode, Low Channel, Bandedge, Vertical

Project No.: DG2231229-79269E-RF Serial No.: 2FY2-1
 Polarization: Vertical Tester: Bill Yang
 Test Mode: Transmitting
 Note: 802.11n20_U-NII-3_low channel 5745MHz

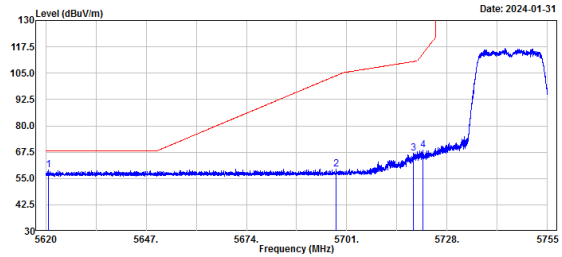

No.	Frequency (MHz)	Reading (dBuV)	Factor (dB/m)	Result (dBuV/m)	Limit (dBuV/m)	Margin (dB)	Detector
1	5620.65	29.31	29.64	58.95	68.20	9.25	Peak
2	5698.07	29.69	29.77	59.46	103.78	44.32	Peak
3	5718.95	37.07	29.80	66.87	110.51	43.64	Peak
4	5721.41	38.50	29.81	68.31	114.01	45.70	Peak

802.11n ht20 mode, Middle Channel, Horizontal

Project No.: DG2231229-79269E-RF Serial No.: 2FY2-1
 Polarization: Horizontal Tester: Colin Yang
 Test Mode: Transmitting
 Note: 802.11n20_U-NII-3_middle channel 5785MHz

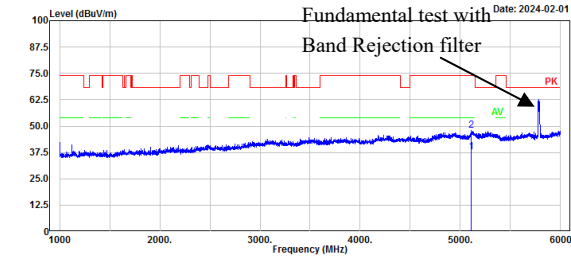

No.	Frequency (MHz)	Reading (dBuV)	Factor (dB/m)	Result (dBuV/m)	Limit (dBuV/m)	Margin (dB)	Detector
1	5110.82	39.12	-1.43	37.69	54.00	16.31	Average
2	5110.82	49.18	-1.43	47.75	74.00	26.25	Peak

802.11n ht20 mode, Middle Channel, Vertical

Project No.: DG2231229-79269E-RF Serial No.: 2FY2-1
 Polarization: Vertical Tester: Colin Yang
 Test Mode: Transmitting
 Note: 802.11n20_U-NII-3_middle channel 5785MHz

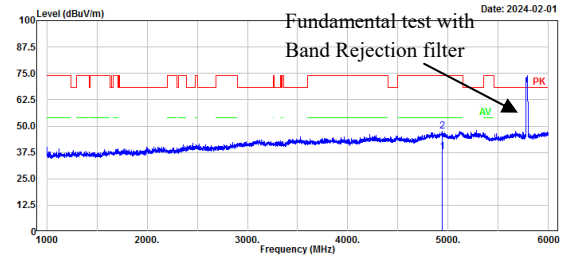

No.	Frequency (MHz)	Reading (dBuV)	Factor (dB/m)	Result (dBuV/m)	Limit (dBuV/m)	Margin (dB)	Detector
1	4944.79	40.25	-2.43	37.82	54.00	16.18	Average
2	4944.79	50.08	-2.43	47.65	74.00	26.35	Peak

Project No.: DG2231229-79269E-RF Serial No.: 2FY2-1
 Polarization: Horizontal Tester: Colin Yang
 Test Mode: Transmitting
 Note: 802.11n20_U-NII-3_middle channel 5785MHz

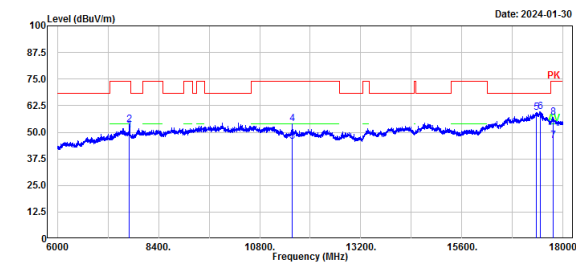

No.	Frequency (MHz)	Reading (dBuV)	Factor (dB/m)	Result (dBuV/m)	Limit (dBuV/m)	Margin (dB)	Detector
1	7711.54	48.10	2.96	51.06	54.00	2.94	Average
2	7711.54	50.76	2.96	53.72	74.00	20.28	Peak
3	11570.00	41.23	4.44	45.67	54.00	8.33	Average
4	11570.00	49.37	4.44	53.81	74.00	20.19	Peak
5	17355.00	44.62	14.70	59.32	68.20	8.88	Peak
6	17467.09	44.15	15.61	59.76	68.20	8.44	Peak
7	17755.15	29.17	16.98	46.15	54.00	7.85	Average
8	17755.15	40.12	16.98	57.10	74.00	16.90	Peak

Project No.: DG2231229-79269E-RF Serial No.: 2FY2-1
 Polarization: Vertical Tester: Colin Yang
 Test Mode: Transmitting
 Note: 802.11n20_U-NII-3_middle channel 5785MHz

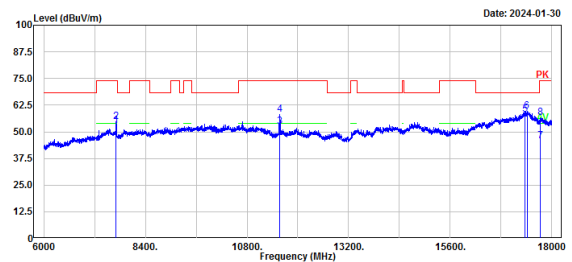

No.	Frequency (MHz)	Reading (dBuV)	Factor (dB/m)	Result (dBuV/m)	Limit (dBuV/m)	Margin (dB)	Detector
1	7711.54	49.88	2.96	52.84	54.00	1.16	Average
2	7711.54	51.58	2.96	54.54	74.00	19.46	Peak
3	11570.00	47.89	4.44	52.33	54.00	1.67	Average
4	11570.00	53.86	4.44	58.30	74.00	15.70	Peak
5	17355.00	43.46	14.70	58.16	68.20	10.04	Peak
6	17411.88	44.49	15.17	59.66	68.20	8.54	Peak
7	17733.55	28.86	16.86	45.72	54.00	8.28	Average
8	17733.55	39.84	16.86	56.70	74.00	17.30	Peak

802.11n ht20 mode, High Channel, Horizontal

Project No.: DG2231229-79269E-RF Serial No.: 2FY2-1
 Polarization: Horizontal Tester: Colin Yang
 Test Mode: Transmitting
 Note: 802.11n20_U-NII-3_high channel 5825MHz

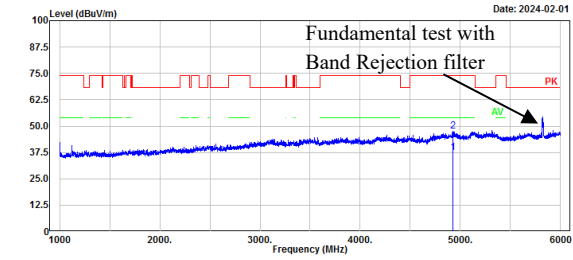

No.	Frequency (MHz)	Reading (dBμV)	Factor (dB/m)	Result (dBμV/m)	Limit (dBμV/m)	Margin (dB)	Detector
1	4927.79	39.85	-2.51	37.34	54.00	16.66	Average
2	4927.79	49.94	-2.51	47.43	74.00	26.57	Peak

802.11n ht20 mode, High Channel, Vertical

Project No.: DG2231229-79269E-RF Serial No.: 2FY2-1
 Polarization: Vertical Tester: Colin Yang
 Test Mode: Transmitting
 Note: 802.11n20_U-NII-3_high channel 5825MHz

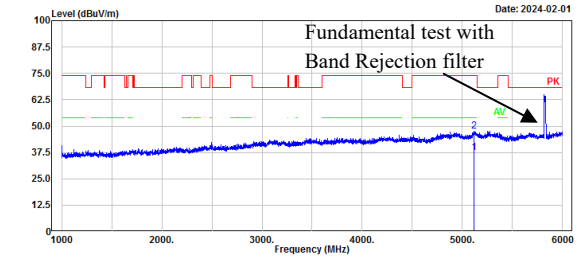

No.	Frequency (MHz)	Reading (dBμV)	Factor (dB/m)	Result (dBμV/m)	Limit (dBμV/m)	Margin (dB)	Detector
1	5116.82	38.65	-1.39	37.26	54.00	16.74	Average
2	5116.82	48.78	-1.39	47.39	74.00	26.61	Peak

Project No.: DG2231229-79269E-RF Serial No.: 2FY2-1
 Polarization: Horizontal Tester: Colin Yang
 Test Mode: Transmitting
 Note: 802.11n20_U-NII-3_high channel 5825MHz

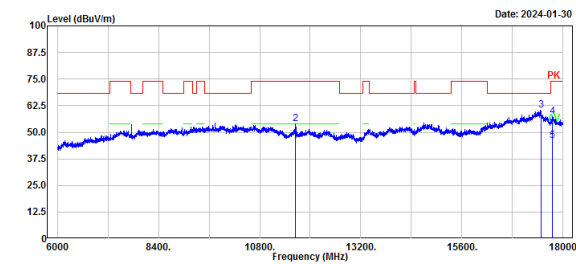

No.	Frequency (MHz)	Reading (dBμV)	Factor (dB/m)	Result (dBμV/m)	Limit (dBμV/m)	Margin (dB)	Detector
1	11650.00	41.43	4.52	45.95	54.00	8.05	Average
2	11650.00	49.47	4.52	53.99	74.00	20.01	Peak
3	17475.00	44.63	15.67	60.30	68.20	7.90	Peak
4	17738.35	40.61	16.88	57.49	74.00	16.51	Peak
5	17738.35	29.20	16.88	46.08	54.00	7.92	Average

Project No.: DG2231229-79269E-RF Serial No.: 2FY2-1
 Polarization: Vertical Tester: Colin Yang
 Test Mode: Transmitting
 Note: 802.11n20_U-NII-3_high channel 5825MHz

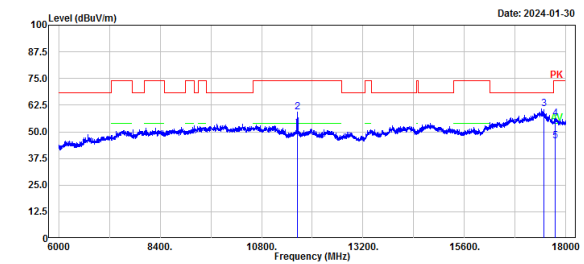

No.	Frequency (MHz)	Reading (dBμV)	Factor (dB/m)	Result (dBμV/m)	Limit (dBμV/m)	Margin (dB)	Detector
1	11650.00	47.44	4.52	51.96	54.00	2.04	Average
2	11650.00	54.78	4.52	59.30	74.00	14.70	Peak
3	17475.00	44.90	15.67	60.57	68.20	7.63	Peak
4	17743.15	39.28	16.91	56.19	74.00	17.81	Peak
5	17743.15	28.69	16.91	45.60	54.00	8.40	Average

802.11n ht20 mode, High Channel, Bandedge, Horizontal

Project No.: DG2231229-79269E-RF Serial No.: 2FY2-1
 Polarization: Horizontal Tester: Bill Yang
 Test Mode: Transmitting
 Note: 802.11n20_U-NII-3_High channel 5825MHz

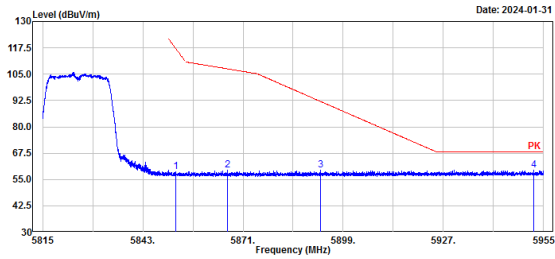

No.	Frequency (MHz)	Reading (dBμV)	Factor (dB/m)	Result (dBμV/m)	Limit (dBμV/m)	Margin (dB)	Detector
1	5852.25	28.61	29.99	58.60	117.07	58.47	Peak
2	5866.73	29.31	30.02	59.33	107.51	48.18	Peak
3	5892.58	29.27	30.07	59.34	92.16	32.82	Peak
4	5952.31	29.19	30.12	59.31	68.20	8.89	Peak

802.11n ht20 mode, High Channel, Bandedge, Vertical

Project No.: DG2231229-79269E-RF Serial No.: 2FY2-1
 Polarization: Vertical Tester: Bill Yang
 Test Mode: Transmitting
 Note: 802.11n20_U-NII-3_High channel 5825MHz

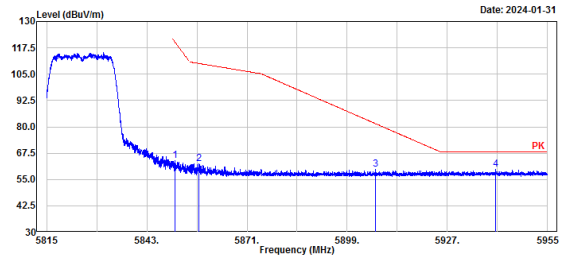

No.	Frequency (MHz)	Reading (dBμV)	Factor (dB/m)	Result (dBμV/m)	Limit (dBμV/m)	Margin (dB)	Detector
1	5850.79	34.09	29.99	64.08	120.40	56.32	Peak
2	5857.60	32.29	30.00	62.29	110.07	47.78	Peak
3	5907.00	29.81	30.09	59.90	81.48	21.58	Peak
4	5940.52	29.70	30.11	59.81	68.20	8.39	Peak

802.11n ht40 mode, Low Channel, Horizontal

Project No.: DG2231229-79269E-RF Serial No.: 2FY2-1
 Polarization: Horizontal Tester: Colin Yang
 Test Mode: Transmitting
 Note: 802.11n40_U-NII-3_low channel 5755MHz

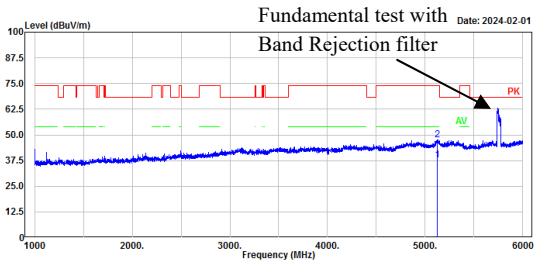

No.	Frequency (MHz)	Reading (dBuV)	Factor (dB/m)	Result (dBuV/m)	Limit (dBuV/m)	Margin (dB)	Detector
1	5122.83	39.05	-1.34	37.71	54.00	16.29	Average
2	5122.83	48.77	-1.34	47.43	74.00	26.57	Peak

802.11n ht40 mode, Low Channel, Vertical

Project No.: DG2231229-79269E-RF Serial No.: 2FY2-1
 Polarization: Vertical Tester: Colin Yang
 Test Mode: Transmitting
 Note: 802.11n40_U-NII-3_low channel 5755MHz

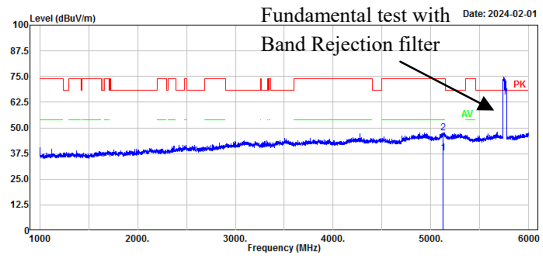

No.	Frequency (MHz)	Reading (dBuV)	Factor (dB/m)	Result (dBuV/m)	Limit (dBuV/m)	Margin (dB)	Detector
1	5123.83	38.98	-1.34	37.64	54.00	16.36	Average
2	5123.83	49.00	-1.34	47.66	74.00	26.34	Peak

Project No.: DG2231229-79269E-RF Serial No.: 2FY2-1
 Polarization: Horizontal Tester: Colin Yang
 Test Mode: Transmitting
 Note: 802.11n40_U-NII-3_low channel 5755MHz

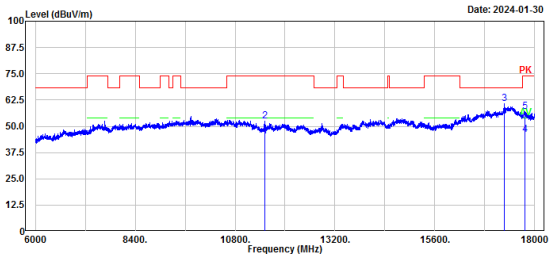

No.	Frequency (MHz)	Reading (dBuV)	Factor (dB/m)	Result (dBuV/m)	Limit (dBuV/m)	Margin (dB)	Detector
1	11510.00	41.10	4.25	45.35	54.00	8.65	Average
2	11510.00	48.20	4.25	52.45	74.00	21.55	Peak
3	17265.00	46.81	13.97	60.78	68.20	7.42	Peak
4	17769.55	28.84	17.06	45.90	54.00	8.10	Average
5	17769.55	39.95	17.06	57.01	74.00	16.99	Peak

Project No.: DG2231229-79269E-RF Serial No.: 2FY2-1
 Polarization: Vertical Tester: Colin Yang
 Test Mode: Transmitting
 Note: 802.11n40_U-NII-3_low channel 5755MHz

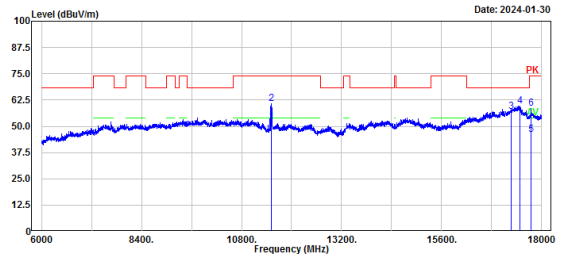

No.	Frequency (MHz)	Reading (dBuV)	Factor (dB/m)	Result (dBuV/m)	Limit (dBuV/m)	Margin (dB)	Detector
1	11510.00	47.64	4.25	51.89	54.00	2.11	Average
2	11510.00	56.40	4.25	60.65	74.00	13.35	Peak
3	17265.00	43.08	13.97	57.05	68.20	11.15	Peak
4	17486.30	43.92	15.76	59.68	68.20	8.52	Peak
5	17750.35	29.25	16.95	46.20	54.00	7.80	Average
6	17750.35	41.36	16.95	58.31	74.00	15.69	Peak

802.11n ht40 mode, Low Channel, Bandedge, Horizontal

Project No.: DG2231229-79269E-RF Serial No.: 2FY2-1
 Polarization: Horizontal Tester: Bill Yang
 Test Mode: Transmitting
 Note: 802.11n40_U-NII-3_Low channel 5755MHz

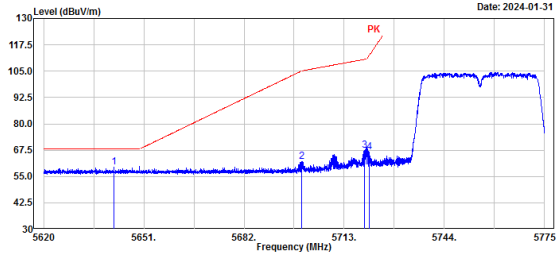

No.	Frequency (MHz)	Reading (dBuV)	Factor (dB/m)	Result (dBuV/m)	Limit (dBuV/m)	Margin (dB)	Detector
1	5641.80	29.60	29.68	59.28	68.20	8.92	Peak
2	5699.78	32.33	29.77	62.10	105.04	42.94	Peak
3	5719.31	37.47	29.80	67.27	110.61	43.34	Peak
4	5728.71	36.67	29.80	66.47	112.41	45.94	Peak

802.11n ht40 mode, Low Channel, Bandedge, Vertical

Project No.: DG2231229-79269E-RF Serial No.: 2FY2-1
 Polarization: Vertical Tester: Bill Yang
 Test Mode: Transmitting
 Note: 802.11n40_U-NII-3_Low channel 5755MHz

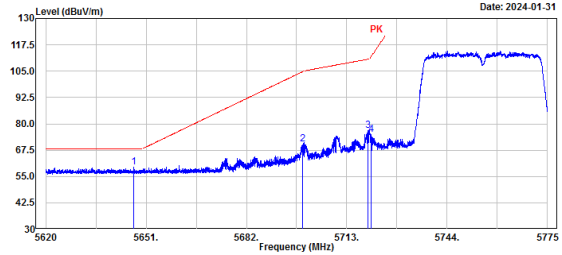

No.	Frequency (MHz)	Reading (dBuV)	Factor (dB/m)	Result (dBuV/m)	Limit (dBuV/m)	Margin (dB)	Detector
1	5647.10	29.60	29.70	59.30	68.20	8.90	Peak
2	5699.47	40.79	29.77	70.56	104.81	34.25	Peak
3	5719.59	47.06	29.80	76.86	110.69	33.83	Peak
4	5728.52	45.22	29.80	75.02	111.99	36.97	Peak

802.11n ht40 mode, High Channel, Horizontal

Project No.: DG2231229-79269E-RF Serial No.: 2FY2-1
 Polarization: Horizontal Tester: Colin Yang
 Test Mode: Transmitting
 Note: 802.11n40_U-NII-3_high channel 5795MHz

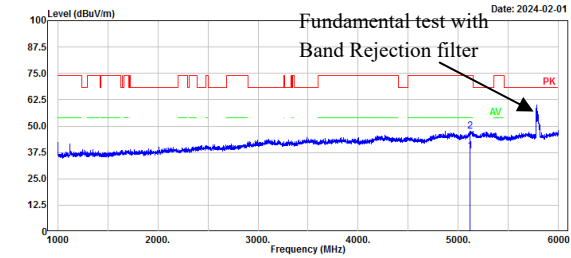

No.	Frequency (MHz)	Reading (dBuV)	Factor (dB/m)	Result (dBuV/m)	Limit (dBuV/m)	Margin (dB)	Detector
1	5114.82	39.35	-1.41	37.94	54.00	16.06	Average
2	5114.82	49.13	-1.41	47.72	74.00	26.28	Peak

802.11n ht40 mode, High Channel, Vertical

Project No.: DG2231229-79269E-RF Serial No.: 2FY2-1
 Polarization: Vertical Tester: Colin Yang
 Test Mode: Transmitting
 Note: 802.11n40_U-NII-3_high channel 5795MHz

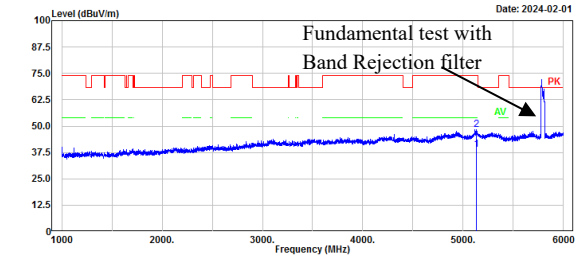

No.	Frequency (MHz)	Reading (dBuV)	Factor (dB/m)	Result (dBuV/m)	Limit (dBuV/m)	Margin (dB)	Detector
1	5134.83	40.02	-1.24	38.78	54.00	15.22	Average
2	5134.83	49.38	-1.24	48.14	74.00	25.86	Peak

Project No.: DG2231229-79269E-RF Serial No.: 2FY2-1
 Polarization: Horizontal Tester: Colin Yang
 Test Mode: Transmitting
 Note: 802.11n40_U-NII-3_high channel 5795MHz

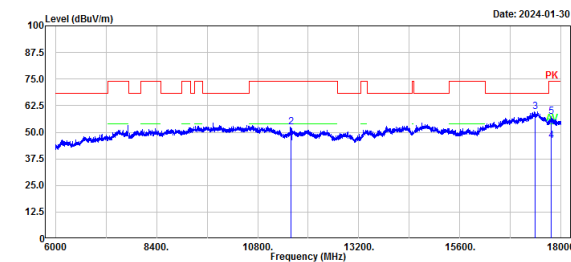

No.	Frequency (MHz)	Reading (dBuV)	Factor (dB/m)	Result (dBuV/m)	Limit (dBuV/m)	Margin (dB)	Detector
1	11590.00	40.58	4.51	45.09	54.00	8.91	Average
2	11590.00	48.01	4.51	52.52	74.00	21.48	Peak
3	17385.00	44.65	14.96	59.61	68.20	8.59	Peak
4	17757.55	29.04	17.00	46.04	54.00	7.96	Average
5	17757.55	40.24	17.00	57.24	74.00	16.76	Peak

Project No.: DG2231229-79269E-RF Serial No.: 2FY2-1
 Polarization: Vertical Tester: Colin Yang
 Test Mode: Transmitting
 Note: 802.11n40_U-NII-3_high channel 5795MHz

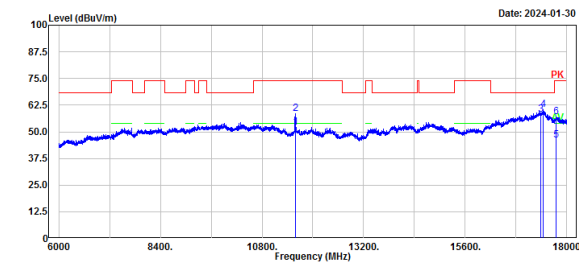

No.	Frequency (MHz)	Reading (dBuV)	Factor (dB/m)	Result (dBuV/m)	Limit (dBuV/m)	Margin (dB)	Detector
1	11590.00	47.64	4.51	52.15	54.00	1.85	Average
2	11590.00	53.86	4.51	58.37	74.00	15.63	Peak
3	17385.00	43.03	14.96	57.99	68.20	10.21	Peak
4	17447.89	44.81	15.45	60.26	68.20	7.94	Peak
5	17752.75	29.02	16.96	45.98	54.00	8.02	Average
6	17752.75	39.99	16.96	56.95	74.00	17.05	Peak

802.11n ht40 mode, High Channel, Bandedge, Horizontal

Project No.: DG2231229-79269E-RF Serial No.: 2FY2-1
 Polarization: Horizontal Tester: Bill Yang
 Test Mode: Transmitting
 Note: 802.11n40_U-NII-3_High channel 5795MHz

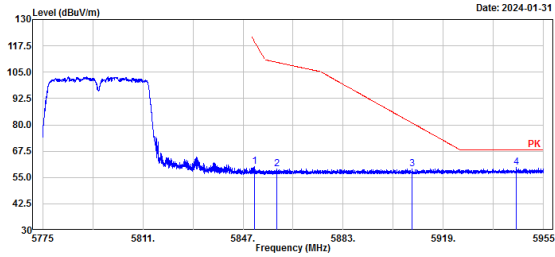

No.	Frequency (MHz)	Reading (dBuV)	Factor (dB/m)	Result (dBuV/m)	Limit (dBuV/m)	Margin (dB)	Detector
1	5851.12	30.22	29.99	60.21	119.65	59.44	Peak
2	5859.19	29.10	30.01	59.11	109.63	50.52	Peak
3	5907.76	29.11	30.09	59.20	80.92	21.72	Peak
4	5945.28	29.60	30.11	59.71	68.20	8.49	Peak

802.11n ht40 mode, High Channel, Bandedge, Vertical

Project No.: DG2231229-79269E-RF Serial No.: 2FY2-1
 Polarization: Vertical Tester: Bill Yang
 Test Mode: Transmitting
 Note: 802.11n40_U-NII-3_High channel 5795MHz

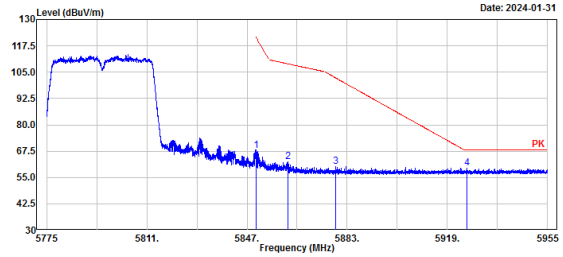

No.	Frequency (MHz)	Reading (dBuV)	Factor (dB/m)	Result (dBuV/m)	Limit (dBuV/m)	Margin (dB)	Detector
1	5850.40	37.73	29.99	67.72	121.29	53.57	Peak
2	5861.71	32.48	30.01	62.49	108.92	46.43	Peak
3	5878.99	30.27	30.04	60.31	102.24	41.93	Peak
4	5926.09	29.28	30.10	59.38	68.20	8.82	Peak

802.11 ac vht20 mode, Low Channel, Horizontal

Project No.: DG2231229-79269E-RF
 Polarization: Horizontal
 Test Mode: Transmitting
 Note: 802.11ac20_U-NII-3_low channel 5745MHz

Serial No.: 2FY2-1
 Tester: Colin Yang

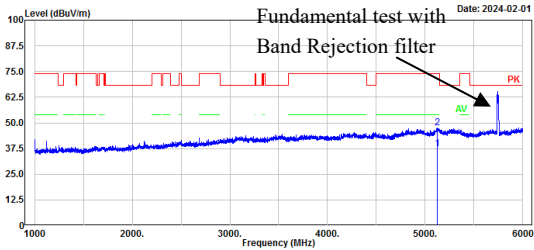

No.	Frequency (MHz)	Reading (dBuV)	Factor (dB/m)	Result (dBuV/m)	Limit (dBuV/m)	Margin (dB)	Detector
1	5122.83	38.62	-1.34	37.28	54.00	16.72	Average
2	5122.83	48.86	-1.34	47.52	74.00	26.48	Peak

802.11 ac vht20 mode, Low Channel, Vertical

Project No.: DG2231229-79269E-RF
 Polarization: Vertical
 Test Mode: Transmitting
 Note: 802.11ac20_U-NII-3_low channel 5745MHz

Serial No.: 2FY2-1
 Tester: Colin Yang

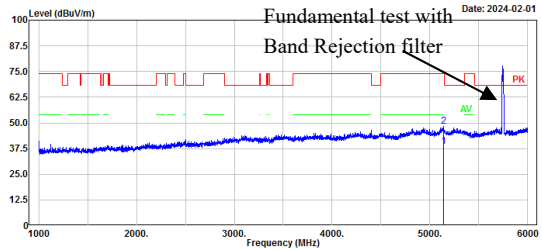

No.	Frequency (MHz)	Reading (dBuV)	Factor (dB/m)	Result (dBuV/m)	Limit (dBuV/m)	Margin (dB)	Detector
1	5137.83	39.63	-1.22	38.41	54.00	15.59	Average
2	5137.83	49.52	-1.22	48.30	74.00	25.70	Peak

Project No.: DG2231229-79269E-RF
 Polarization: Horizontal
 Test Mode: Transmitting
 Note: 802.11ac20_U-NII-3_low channel 5745MHz

Serial No.: 2FY2-1
 Tester: Colin Yang

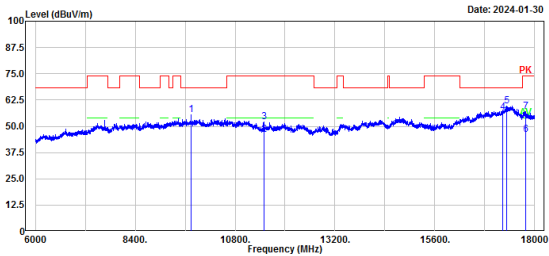

No.	Frequency (MHz)	Reading (dBuV)	Factor (dB/m)	Result (dBuV/m)	Limit (dBuV/m)	Margin (dB)	Detector
1	9747.15	49.44	6.11	55.55	68.20	12.65	Peak
2	11490.00	41.76	4.23	45.99	54.00	8.01	Average
3	11490.00	47.72	4.23	51.95	74.00	22.05	Peak
4	17235.00	42.86	13.75	56.61	68.20	11.59	Peak
5	17327.87	45.05	14.48	59.53	68.20	8.67	Peak
6	17776.76	29.06	17.11	46.17	54.00	7.83	Average
7	17776.76	39.99	17.11	57.10	74.00	16.90	Peak

Project No.: DG2231229-79269E-RF
 Polarization: Vertical
 Test Mode: Transmitting
 Note: 802.11ac20_U-NII-3_low channel 5745MHz

Serial No.: 2FY2-1
 Tester: Colin Yang

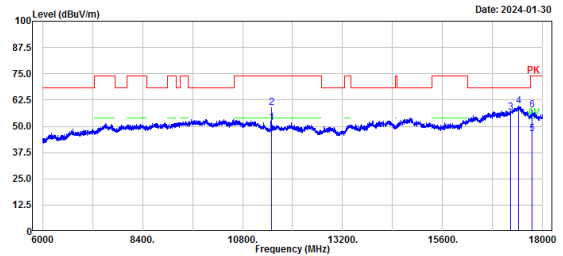

No.	Frequency (MHz)	Reading (dBuV)	Factor (dB/m)	Result (dBuV/m)	Limit (dBuV/m)	Margin (dB)	Detector
1	11490.00	47.43	4.23	51.66	54.00	2.34	Average
2	11490.00	54.60	4.23	58.83	74.00	15.17	Peak
3	17235.00	42.95	13.75	56.70	68.20	11.50	Peak
4	17426.29	44.37	15.28	59.65	68.20	8.55	Peak
5	17738.35	29.36	16.88	46.24	54.00	7.76	Average
6	17738.35	41.00	16.88	57.88	74.00	16.12	Peak

802.11 ac vht20 mode, Low Channel, Bandedge, Horizontal

Project No.: DG2231229-79269E-RF Serial No.: 2FY2-1
 Polarization: Horizontal Tester: Bill Yang
 Test Mode: Transmitting
 Note: 802.11ac20_U-NII-3_low channel 5745MHz

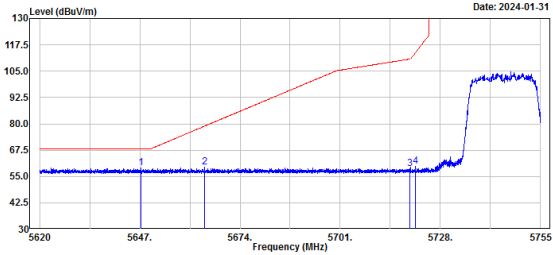

No.	Frequency (MHz)	Reading (dBuV)	Factor (dB/m)	Result (dBuV/m)	Limit (dBuV/m)	Margin (dB)	Detector
1	5647.30	29.26	29.70	58.96	68.20	9.24	Peak
2	5664.51	29.64	29.72	59.36	78.97	19.61	Peak
3	5719.81	29.01	29.80	58.81	110.75	51.94	Peak
4	5721.22	29.98	29.81	59.79	113.57	53.78	Peak

802.11 ac vht20 mode, Low Channel, Bandedge, Vertical

Project No.: DG2231229-79269E-RF Serial No.: 2FY2-1
 Polarization: Vertical Tester: Bill Yang
 Test Mode: Transmitting
 Note: 802.11ac20_U-NII-3_low channel 5745MHz

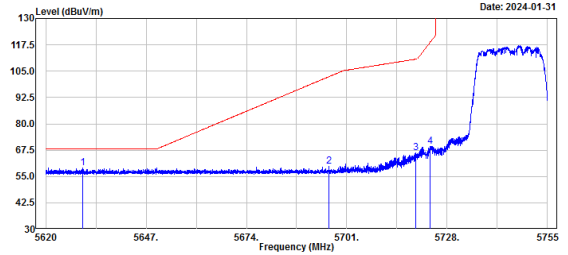

No.	Frequency (MHz)	Reading (dBuV)	Factor (dB/m)	Result (dBuV/m)	Limit (dBuV/m)	Margin (dB)	Detector
1	5629.97	29.57	29.66	59.23	68.20	8.97	Peak
2	5696.13	29.92	29.77	59.69	102.35	42.66	Peak
3	5719.49	36.40	29.80	66.20	110.66	44.46	Peak
4	5723.43	39.60	29.81	69.41	118.62	49.21	Peak

802.11 ac vht20 mode, Middle Channel, Horizontal

Project No.: DG2231229-79269E-RF Serial No.: 2FY2-1
 Polarization: Horizontal Tester: Colin Yang
 Test Mode: Transmitting
 Note: 802.11ac20_U-NII-3_middle channel 5785MHz

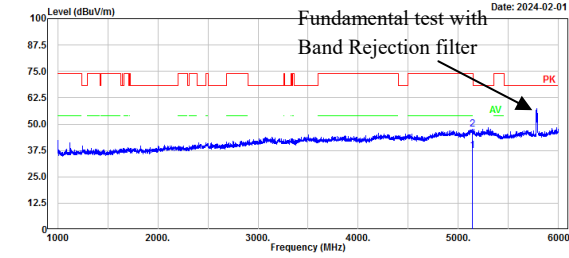

No.	Frequency (MHz)	Reading (dBuV)	Factor (dB/m)	Result (dBuV/m)	Limit (dBuV/m)	Margin (dB)	Detector
1	5142.83	38.49	-1.17	37.32	54.00	16.68	Average
2	5142.83	48.84	-1.17	47.67	74.00	26.33	Peak

802.11 ac vht20 mode, Middle Channel, Vertical

Project No.: DG2231229-79269E-RF Serial No.: 2FY2-1
 Polarization: Vertical Tester: Colin Yang
 Test Mode: Transmitting
 Note: 802.11ac20_U-NII-3_middle channel 5785MHz

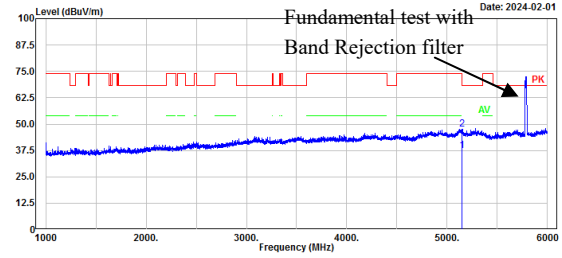

No.	Frequency (MHz)	Reading (dBuV)	Factor (dB/m)	Result (dBuV/m)	Limit (dBuV/m)	Margin (dB)	Detector
1	5145.83	38.65	-1.15	37.50	54.00	16.50	Average
2	5145.83	48.88	-1.15	47.73	74.00	26.27	Peak

Project No.: DG2231229-79269E-RF Serial No.: 2FY2-1
 Polarization: Horizontal Tester: Colin Yang
 Test Mode: Transmitting
 Note: 802.11ac20_U-NII-3_middle channel 5785MHz

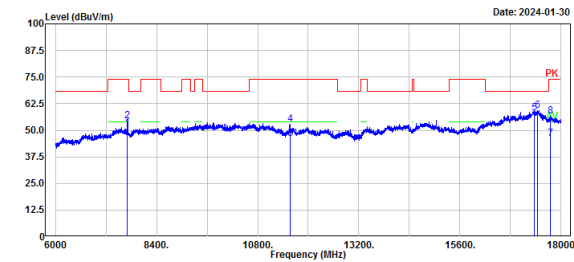

No.	Frequency (MHz)	Reading (dBuV)	Factor (dB/m)	Result (dBuV/m)	Limit (dBuV/m)	Margin (dB)	Detector
1	7711.54	47.80	2.96	50.76	54.00	3.24	Average
2	7711.54	51.23	2.96	54.19	74.00	19.81	Peak
3	11570.00	41.78	4.44	46.22	54.00	7.78	Average
4	11570.00	48.55	4.44	52.99	74.00	21.01	Peak
5	17355.00	43.44	14.70	58.14	68.20	10.06	Peak
6	17433.49	43.84	15.34	59.18	68.20	9.02	Peak
7	17745.55	29.07	16.92	45.99	54.00	8.01	Average
8	17745.55	39.54	16.92	56.46	74.00	17.54	Peak

Project No.: DG2231229-79269E-RF Serial No.: 2FY2-1
 Polarization: Vertical Tester: Colin Yang
 Test Mode: Transmitting
 Note: 802.11ac20_U-NII-3_middle channel 5785MHz

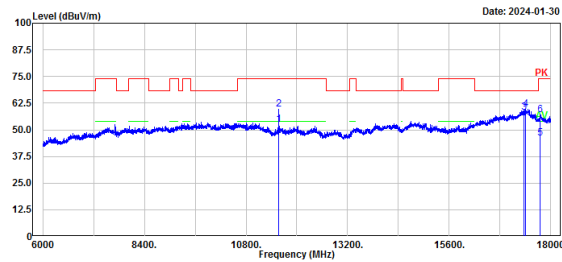

No.	Frequency (MHz)	Reading (dBuV)	Factor (dB/m)	Result (dBuV/m)	Limit (dBuV/m)	Margin (dB)	Detector
1	11570.00	48.03	4.44	52.47	54.00	1.53	Average
2	11570.00	55.04	4.44	59.48	74.00	14.52	Peak
3	17355.00	43.42	14.70	58.12	68.20	10.08	Peak
4	17407.08	44.58	15.13	59.71	68.20	8.49	Peak
5	17745.55	29.11	16.92	46.03	54.00	7.97	Average
6	17745.55	39.98	16.92	56.90	74.00	17.10	Peak

802.11 ac vht20 mode, High Channel, Horizontal

Project No.: DG2231229-79269E-RF Serial No.: 2FY2-1
 Polarization: Horizontal Tester: Colin Yang
 Test Mode: Transmitting
 Note: 802.11ac20_U-NII-3_high channel 5825MHz

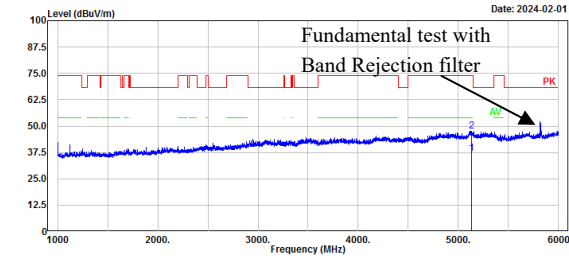

No.	Frequency (MHz)	Reading (dBμV)	Factor (dB/m)	Result (dBμV/m)	Limit (dBμV/m)	Margin (dB)	Detector
1	5134.83	38.19	-1.24	36.95	54.00	17.05	Average
2	5134.83	48.88	-1.24	47.64	74.00	26.36	Peak

802.11 ac vht20 mode, High Channel, Vertical

Project No.: DG2231229-79269E-RF Serial No.: 2FY2-1
 Polarization: Vertical Tester: Colin Yang
 Test Mode: Transmitting
 Note: 802.11ac20_U-NII-3_high channel 5825MHz

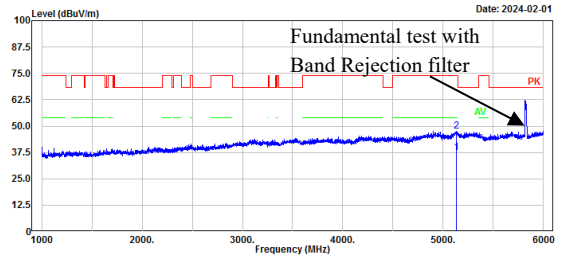

No.	Frequency (MHz)	Reading (dBμV)	Factor (dB/m)	Result (dBμV/m)	Limit (dBμV/m)	Margin (dB)	Detector
1	5130.83	38.57	-1.27	37.30	54.00	16.70	Average
2	5130.83	48.93	-1.27	47.66	74.00	26.34	Peak

Project No.: DG2231229-79269E-RF Serial No.: 2FY2-1
 Polarization: Horizontal Tester: Colin Yang
 Test Mode: Transmitting
 Note: 802.11ac20_U-NII-3_high channel 5825MHz

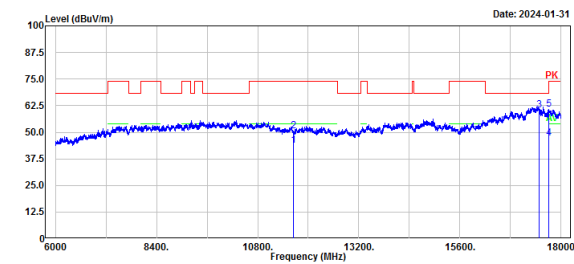

No.	Frequency (MHz)	Reading (dBμV)	Factor (dB/m)	Result (dBμV/m)	Limit (dBμV/m)	Margin (dB)	Detector
1	11650.00	39.07	4.52	43.59	54.00	10.41	Average
2	11650.00	46.20	4.52	50.72	74.00	23.28	Peak
3	17475.00	44.64	15.67	60.31	68.20	7.89	Peak
4	17714.34	30.41	16.75	47.16	54.00	6.84	Average
5	17714.34	43.91	16.75	60.66	74.00	13.34	Peak

Project No.: DG2231229-79269E-RF Serial No.: 2FY2-1
 Polarization: Vertical Tester: Colin Yang
 Test Mode: Transmitting
 Note: 802.11ac20_U-NII-3_high channel 5825MHz

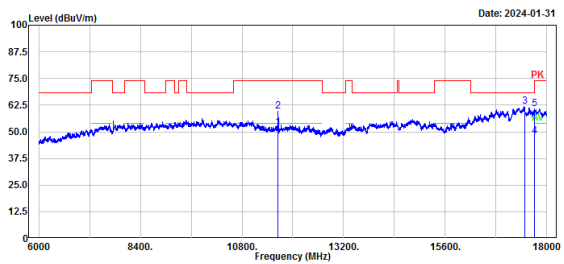

No.	Frequency (MHz)	Reading (dBμV)	Factor (dB/m)	Result (dBμV/m)	Limit (dBμV/m)	Margin (dB)	Detector
1	11650.00	47.53	4.52	52.05	54.00	1.95	Average
2	11650.00	55.22	4.52	59.74	74.00	14.26	Peak
3	17475.00	46.37	15.67	62.04	68.20	6.16	Peak
4	17711.94	31.06	16.73	47.79	54.00	6.21	Average
5	17711.94	43.97	16.73	60.70	74.00	13.30	Peak

802.11 ac vht20 mode, High Channel, Bandedge, Horizontal

Project No.: DG2231229-79269E-RF Serial No.: 2FY2-1
 Polarization: Horizontal Tester: Bill Yang
 Test Mode: Transmitting
 Note: 802.11ac20_U-NII-3_High channel 5825MHz

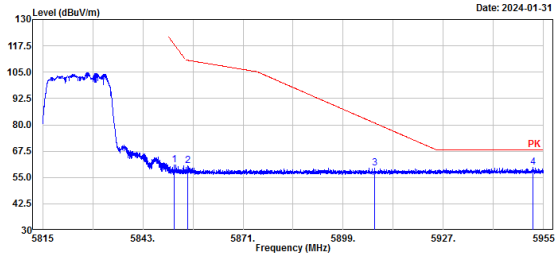

No.	Frequency (MHz)	Reading (dBuV)	Factor (dB/m)	Result (dBuV/m)	Limit (dBuV/m)	Margin (dB)	Detector
1	5851.72	30.88	29.99	60.87	118.29	57.42	Peak
2	5855.50	30.48	30.00	60.48	110.66	50.18	Peak
3	5907.84	29.40	30.09	59.49	80.86	21.37	Peak
4	5952.03	29.76	30.12	59.88	68.20	8.32	Peak

802.11 ac vht20 mode, High Channel, Bandedge, Vertical

Project No.: DG2231229-79269E-RF Serial No.: 2FY2-1
 Polarization: Vertical Tester: Bill Yang
 Test Mode: Transmitting
 Note: 802.11ac20_U-NII-3_High channel 5825MHz

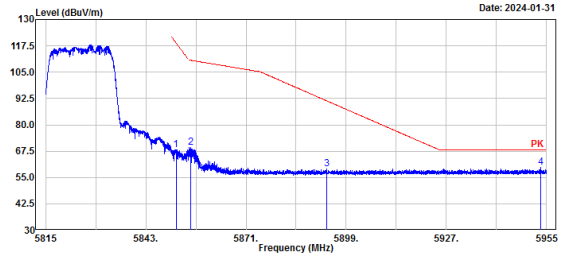

No.	Frequency (MHz)	Reading (dBuV)	Factor (dB/m)	Result (dBuV/m)	Limit (dBuV/m)	Margin (dB)	Detector
1	5851.44	38.24	29.99	68.23	118.93	50.70	Peak
2	5855.50	39.06	30.00	69.06	110.66	41.60	Peak
3	5893.53	29.03	30.07	59.10	91.45	32.35	Peak
4	5953.26	29.70	30.12	59.82	68.20	8.38	Peak

802.11 ac vht40 mode, Low Channel, Horizontal

Project No.: DG2231229-79269E-RF Serial No.: 2FY2-1
 Polarization: Horizontal Tester: Colin Yang
 Test Mode: Transmitting
 Note: 802.11ac40_U-NII-3_low channel 5755MHz

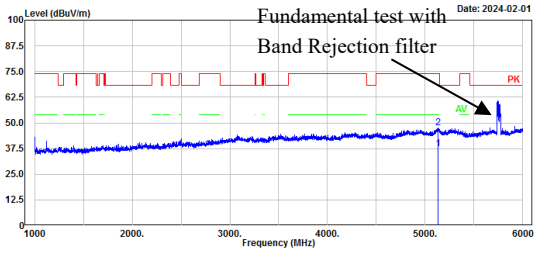

No.	Frequency (MHz)	Reading (dBuV)	Factor (dB/m)	Result (dBuV/m)	Limit (dBuV/m)	Margin (dB)	Detector
1	5132.83	38.74	-1.25	37.49	54.00	16.51	Average
2	5132.83	48.85	-1.25	47.60	74.00	26.40	Peak

802.11 ac vht40 mode, Low Channel, Vertical

Project No.: DG2231229-79269E-RF Serial No.: 2FY2-1
 Polarization: Vertical Tester: Colin Yang
 Test Mode: Transmitting
 Note: 802.11ac40_U-NII-3_low channel 5755MHz

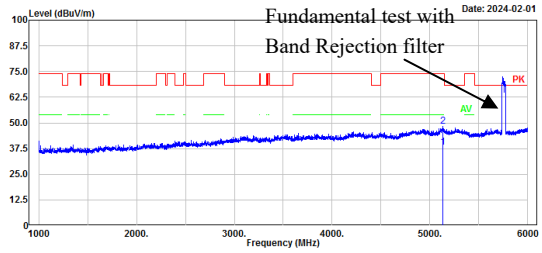

No.	Frequency (MHz)	Reading (dBuV)	Factor (dB/m)	Result (dBuV/m)	Limit (dBuV/m)	Margin (dB)	Detector
1	5134.83	39.31	-1.24	38.07	54.00	15.93	Average
2	5134.83	49.43	-1.24	48.19	74.00	25.81	Peak

Project No.: DG2231229-79269E-RF Serial No.: 2FY2-1
 Polarization: Horizontal Tester: Colin Yang
 Test Mode: Transmitting
 Note: 802.11ac40_U-NII-3_low channel 5755MHz

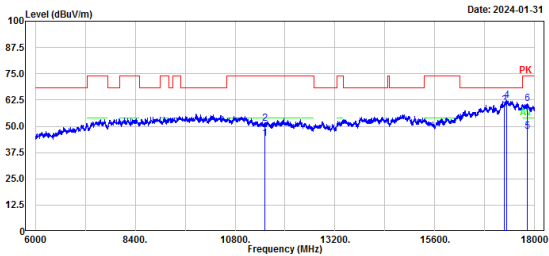

No.	Frequency (MHz)	Reading (dBuV)	Factor (dB/m)	Result (dBuV/m)	Limit (dBuV/m)	Margin (dB)	Detector
1	11510.00	39.87	4.25	44.12	54.00	9.88	Average
2	11510.00	47.00	4.25	51.25	74.00	22.75	Peak
3	17265.00	46.10	13.97	60.07	68.20	8.13	Peak
4	17338.27	47.65	14.58	62.15	68.20	6.05	Peak
5	17812.76	38.42	17.30	47.72	54.00	6.28	Average
6	17812.76	43.41	17.30	60.71	74.00	13.29	Peak

Project No.: DG2231229-79269E-RF Serial No.: 2FY2-1
 Polarization: Vertical Tester: Colin Yang
 Test Mode: Transmitting
 Note: 802.11ac40_U-NII-3_low channel 5755MHz

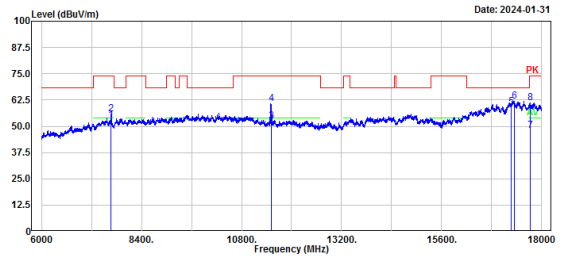

No.	Frequency (MHz)	Reading (dBuV)	Factor (dB/m)	Result (dBuV/m)	Limit (dBuV/m)	Margin (dB)	Detector
1	7673.14	49.77	2.97	52.74	54.00	1.26	Average
2	7673.14	52.87	2.97	55.84	74.00	18.16	Peak
3	11510.00	48.15	4.25	52.40	54.00	1.60	Average
4	11510.00	56.39	4.25	60.64	74.00	13.36	Peak
5	17265.00	45.25	13.97	59.22	68.20	8.98	Peak
6	17339.87	47.48	14.58	62.06	68.20	6.14	Peak
7	17719.14	31.04	16.78	47.82	54.00	6.18	Average
8	17719.14	44.30	16.78	61.08	74.00	12.92	Peak

802.11 ac vht40 mode, Low Channel, Bandedge, Horizontal

Project No.: DG2231229-79269E-RF Serial No.: 2FY2-1
 Polarization: Horizontal Tester: Bill Yang
 Test Mode: Transmitting
 Note: 802.11ac40_U-NII-3_Low channel 5755MHz

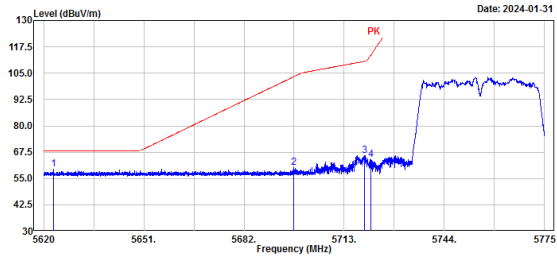

No.	Frequency (MHz)	Reading (dBuV)	Factor (dB/m)	Result (dBuV/m)	Limit (dBuV/m)	Margin (dB)	Detector
1	5622.95	29.69	29.65	59.34	68.20	8.86	Peak
2	5697.36	30.31	29.77	60.08	103.25	43.17	Peak
3	5719.25	36.16	29.80	65.96	110.59	44.63	Peak
4	5721.30	34.01	29.81	63.82	113.76	49.94	Peak

802.11 ac vht40 mode, Low Channel, Bandedge, Vertical

Project No.: DG2231229-79269E-RF Serial No.: 2FY2-1
 Polarization: Vertical Tester: Bill Yang
 Test Mode: Transmitting
 Note: 802.11ac40_U-NII-3_Low channel 5755MHz

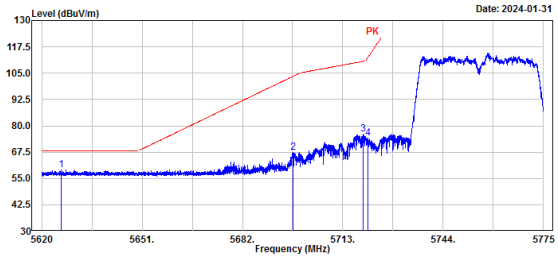

No.	Frequency (MHz)	Reading (dBuV)	Factor (dB/m)	Result (dBuV/m)	Limit (dBuV/m)	Margin (dB)	Detector
1	5626.08	29.54	29.65	59.19	68.20	9.01	Peak
2	5697.70	37.51	29.77	67.28	103.51	36.23	Peak
3	5719.38	46.10	29.80	75.90	110.63	34.73	Peak
4	5720.74	44.23	29.80	74.03	112.49	38.46	Peak

802.11 ac vht40 mode, High Channel, Horizontal

Project No.: DG2231229-79269E-RF Serial No.: 2FY2-1
 Polarization: Horizontal Tester: Colin Yang
 Test Mode: Transmitting
 Note: 802.11ac40_U-NII-3_high channel 5795MHz

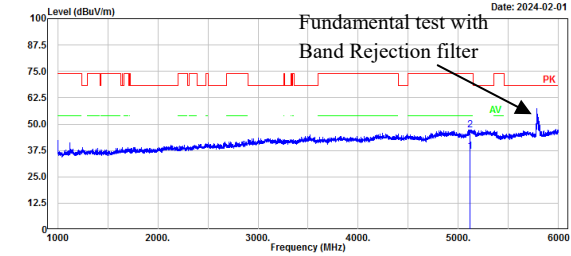

No.	Frequency (MHz)	Reading (dBμV)	Factor (dB/m)	Result (dBμV/m)	Limit (dBμV/m)	Margin (dB)	Detector
1	5117.82	38.50	-1.39	37.11	54.00	16.89	Average
2	5117.82	48.62	-1.39	47.23	74.00	26.77	Peak

802.11 ac vht40 mode, High Channel, Vertical

Project No.: DG2231229-79269E-RF Serial No.: 2FY2-1
 Polarization: Vertical Tester: Colin Yang
 Test Mode: Transmitting
 Note: 802.11ac40_U-NII-3_high channel 5795MHz

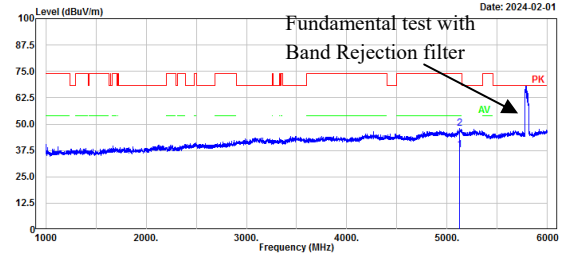

No.	Frequency (MHz)	Reading (dBμV)	Factor (dB/m)	Result (dBμV/m)	Limit (dBμV/m)	Margin (dB)	Detector
1	5120.82	39.24	-1.36	37.88	54.00	16.12	Average
2	5120.82	49.28	-1.36	47.92	74.00	26.08	Peak

Project No.: DG2231229-79269E-RF Serial No.: 2FY2-1
 Polarization: Horizontal Tester: Colin Yang
 Test Mode: Transmitting
 Note: 802.11ac40_U-NII-3_high channel 5795MHz

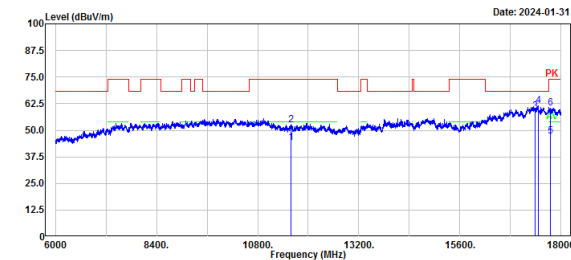

No.	Frequency (MHz)	Reading (dBμV)	Factor (dB/m)	Result (dBμV/m)	Limit (dBμV/m)	Margin (dB)	Detector
1	11590.00	39.79	4.51	44.30	54.00	9.70	Average
2	11590.00	47.99	4.51	52.50	74.00	21.50	Peak
3	17385.00	43.72	14.96	58.68	68.20	9.52	Peak
4	17459.89	45.85	15.55	61.40	68.20	6.80	Peak
5	17735.95	30.21	16.87	47.08	54.00	6.92	Average
6	17735.95	43.54	16.87	60.41	74.00	13.59	Peak

Project No.: DG2231229-79269E-RF Serial No.: 2FY2-1
 Polarization: Vertical Tester: Colin Yang
 Test Mode: Transmitting
 Note: 802.11ac40_U-NII-3_high channel 5795MHz

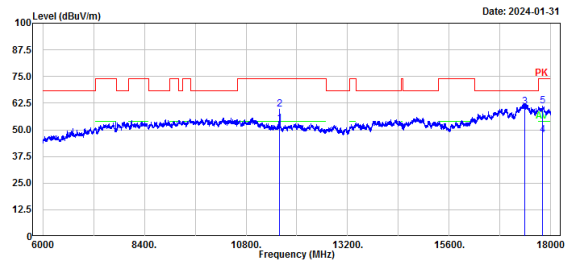

No.	Frequency (MHz)	Reading (dBμV)	Factor (dB/m)	Result (dBμV/m)	Limit (dBμV/m)	Margin (dB)	Detector
1	11590.00	48.25	4.51	52.76	54.00	1.24	Average
2	11590.00	55.12	4.51	59.63	74.00	14.37	Peak
3	17385.00	45.71	14.96	60.67	68.20	7.53	Peak
4	17807.96	30.45	17.28	47.73	54.00	6.27	Average
5	17807.96	44.01	17.28	61.29	74.00	12.71	Peak

802.11 ac vht40 mode, High Channel, Bandedge, Horizontal

Project No.: DG2231229-79269E-RF Serial No.: 2FY2-1
 Polarization: Horizontal Tester: Bill Yang
 Test Mode: Transmitting
 Note: 802.11ac40_U-NII-3_High channel 5795MHz

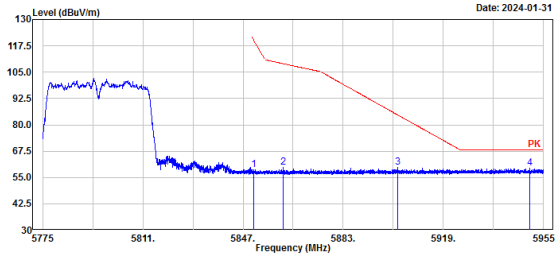

No.	Frequency (MHz)	Reading (dBuV)	Factor (dB/m)	Result (dBuV/m)	Limit (dBuV/m)	Margin (dB)	Detector
1	5850.72	28.75	29.99	58.74	120.55	61.81	Peak
2	5861.42	29.62	30.01	59.63	109.00	49.37	Peak
3	5902.47	29.64	30.08	59.72	84.84	25.12	Peak
4	5949.96	29.37	30.12	59.49	68.20	8.71	Peak

802.11 ac vht40 mode, High Channel, Bandedge, Vertical

Project No.: DG2231229-79269E-RF Serial No.: 2FY2-1
 Polarization: Vertical Tester: Bill Yang
 Test Mode: Transmitting
 Note: 802.11ac40_U-NII-3_High channel 5795MHz

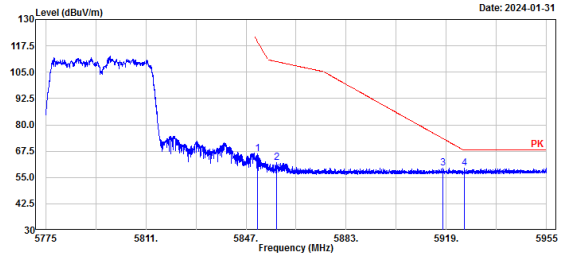

No.	Frequency (MHz)	Reading (dBuV)	Factor (dB/m)	Result (dBuV/m)	Limit (dBuV/m)	Margin (dB)	Detector
1	5851.16	36.09	29.99	66.08	119.57	53.49	Peak
2	5858.07	32.04	30.00	62.04	109.94	47.90	Peak
3	5917.66	29.50	30.09	59.59	73.61	14.02	Peak
4	5925.51	29.21	30.10	59.31	68.20	8.89	Peak

802.11 ac vht80 mode, Middle Channel, Horizontal

Project No.: DG2231229-79269E-RF
 Polarization: Horizontal
 Test Mode: Transmitting
 Note: 802.11ac80_U-NII-3_Middle channel 5775MHz

Serial No.: 2FY2-1
 Tester: Colin Yang

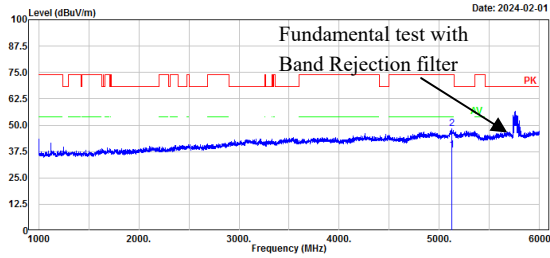

No.	Frequency (MHz)	Reading (dBuV)	Factor (dB/m)	Result (dBuV/m)	Limit (dBuV/m)	Margin (dB)	Detector
1	5121.82	39.38	-1.35	38.03	54.00	15.97	Average
2	5121.82	49.54	-1.35	48.19	74.00	25.81	Peak

802.11 ac vht80 mode, Middle Channel, Vertical

Project No.: DG2231229-79269E-RF
 Polarization: Vertical
 Test Mode: Transmitting
 Note: 802.11ac80_U-NII-3_Middle channel 5775MHz

Serial No.: 2FY2-1
 Tester: Colin Yang

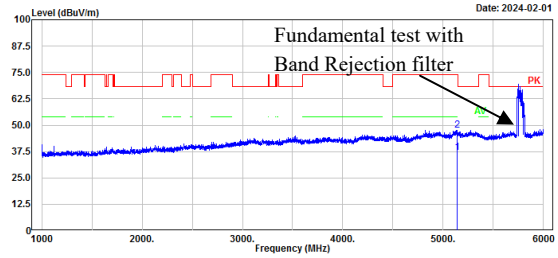

No.	Frequency (MHz)	Reading (dBuV)	Factor (dB/m)	Result (dBuV/m)	Limit (dBuV/m)	Margin (dB)	Detector
1	5142.83	38.32	-1.17	37.15	54.00	16.85	Average
2	5142.83	48.82	-1.17	47.65	74.00	26.35	Peak

Project No.: DG2231229-79269E-RF
 Polarization: Horizontal
 Test Mode: Transmitting
 Note: 802.11ac80_U-NII-3_Middle channel 5775MHz

Serial No.: 2FY2-1
 Tester: Colin Yang

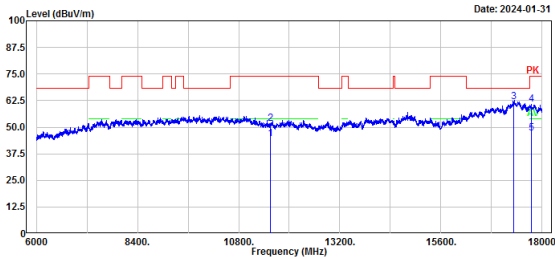

No.	Frequency (MHz)	Reading (dBuV)	Factor (dB/m)	Result (dBuV/m)	Limit (dBuV/m)	Margin (dB)	Detector
1	11550.00	40.05	4.38	44.43	54.00	9.57	Average
2	11550.00	47.28	4.38	51.66	74.00	22.34	Peak
3	17325.00	47.61	14.45	62.06	68.20	6.14	Peak
4	17735.95	43.85	16.87	60.72	74.00	13.28	Peak
5	17735.95	30.45	16.87	47.32	54.00	6.68	Average

Project No.: DG2231229-79269E-RF
 Polarization: Vertical
 Test Mode: Transmitting
 Note: 802.11ac80_U-NII-3_Middle channel 5775MHz

Serial No.: 2FY2-1
 Tester: Colin Yang

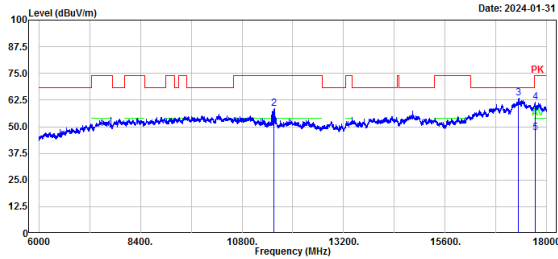

No.	Frequency (MHz)	Reading (dBuV)	Factor (dB/m)	Result (dBuV/m)	Limit (dBuV/m)	Margin (dB)	Detector
1	11550.00	47.76	4.38	52.14	54.00	1.86	Average
2	11550.00	54.04	4.38	58.42	74.00	15.58	Peak
3	17325.00	49.12	14.45	63.57	68.20	4.63	Peak
4	17726.35	44.79	16.81	61.60	74.00	12.40	Peak
5	17726.35	30.32	16.81	47.13	54.00	6.87	Average

802.11 ac vht80 mode, Middle Channel, Bandedge, Horizontal

Project No.: DG2231229-79269E-RF
 Polarization: Horizontal
 Test Mode: Transmitting
 Note: 802.11ac80_U-NII-3_Middle channel 5775MHz

Serial No.: 2FY2-1
 Tester: Bill Yang

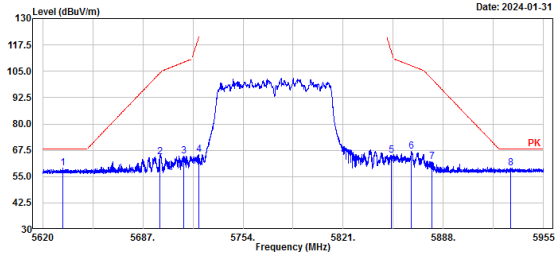

No.	Frequency (MHz)	Reading (dBuV)	Factor (dB/m)	Result (dBuV/m)	Limit (dBuV/m)	Margin (dB)	Detector
1	5633.74	29.42	29.67	59.09	68.20	9.11	Peak
2	5698.27	34.60	29.77	64.37	103.93	39.56	Peak
3	5714.22	34.86	29.80	64.66	109.18	44.52	Peak
4	5724.47	35.74	29.81	65.55	121.00	55.45	Peak
5	5853.01	35.25	29.99	65.24	115.35	50.11	Peak
6	5866.68	36.85	30.02	66.87	107.53	40.66	Peak
7	5880.41	32.13	30.05	62.18	101.18	39.00	Peak
8	5932.95	28.97	30.11	59.08	68.20	9.12	Peak

802.11 ac vht80 mode, Middle Channel, Bandedge, Vertical

Project No.: DG2231229-79269E-RF
 Polarization: Vertical
 Test Mode: Transmitting
 Note: 802.11ac80_U-NII-3_Middle channel 5775MHz

Serial No.: 2FY2-1
 Tester: Bill Yang

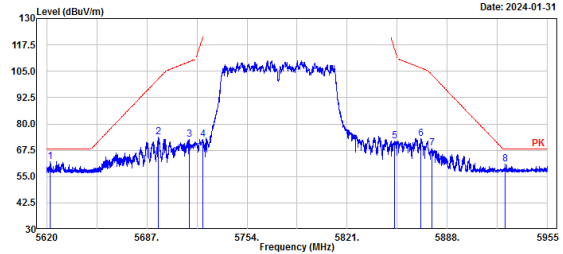

No.	Frequency (MHz)	Reading (dBuV)	Factor (dB/m)	Result (dBuV/m)	Limit (dBuV/m)	Margin (dB)	Detector
1	5622.28	32.45	29.65	62.10	68.20	6.10	Peak
2	5694.85	43.89	29.76	73.65	101.41	27.76	Peak
3	5715.36	42.65	29.80	72.45	109.50	37.05	Peak
4	5724.27	42.94	29.81	72.75	120.54	47.79	Peak
5	5852.60	41.93	29.99	71.92	116.26	44.34	Peak
6	5870.43	43.17	30.02	73.19	106.48	33.29	Peak
7	5877.67	38.61	30.04	68.65	103.22	34.57	Peak
8	5926.72	30.69	30.10	60.79	68.20	7.41	Peak

802.11 ax he20 mode, Low Channel, Horizontal

Project No.: DG2231229-79269E-RF Serial No.: 2FY2-1
 Polarization: Horizontal Tester: Colin Yang
 Test Mode: Transmitting
 Note: 802.11ax20_U-NII-3_low channel 5745MHz

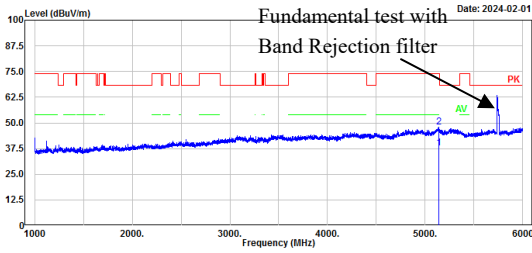

No.	Frequency (MHz)	Reading (dBuV)	Factor (dB/m)	Result (dBuV/m)	Limit (dBuV/m)	Margin (dB)	Detector
1	5141.83	38.73	-1.17	37.56	54.00	16.44	Average
2	5141.83	48.92	-1.17	47.75	74.00	26.25	Peak

802.11 ax he20 mode, Low Channel, Vertical

Project No.: DG2231229-79269E-RF Serial No.: 2FY2-1
 Polarization: Vertical Tester: Colin Yang
 Test Mode: Transmitting
 Note: 802.11ax20_U-NII-3_low channel 5745MHz

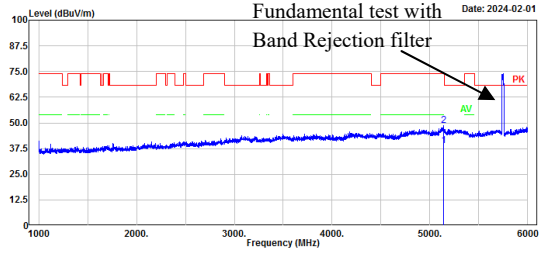

No.	Frequency (MHz)	Reading (dBuV)	Factor (dB/m)	Result (dBuV/m)	Limit (dBuV/m)	Margin (dB)	Detector
1	5135.83	40.12	-1.23	38.89	54.00	15.11	Average
2	5135.83	50.09	-1.23	48.86	74.00	25.14	Peak

Project No.: DG2231229-79269E-RF Serial No.: 2FY2-1
 Polarization: Horizontal Tester: Colin Yang
 Test Mode: Transmitting
 Note: 802.11ax20_U-NII-3_low channel 5745MHz

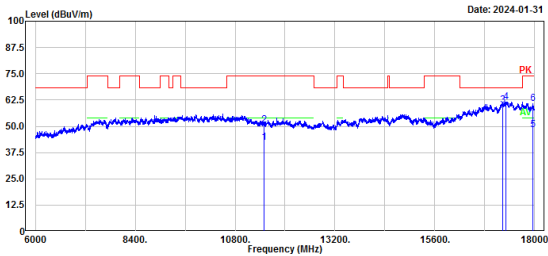

No.	Frequency (MHz)	Reading (dBuV)	Factor (dB/m)	Result (dBuV/m)	Limit (dBuV/m)	Margin (dB)	Detector
1	11490.00	38.15	4.23	42.38	54.00	11.62	Average
2	11490.00	46.52	4.23	50.75	74.00	23.25	Peak
3	17235.00	46.29	13.75	60.04	68.20	8.16	Peak
4	17306.26	47.28	14.30	61.58	68.20	6.62	Peak
5	17954.39	30.37	17.97	48.34	54.00	5.66	Average
6	17954.39	42.95	17.97	60.92	74.00	13.08	Peak

Project No.: DG2231229-79269E-RF Serial No.: 2FY2-1
 Polarization: Vertical Tester: Colin Yang
 Test Mode: Transmitting
 Note: 802.11ax20_U-NII-3_low channel 5745MHz

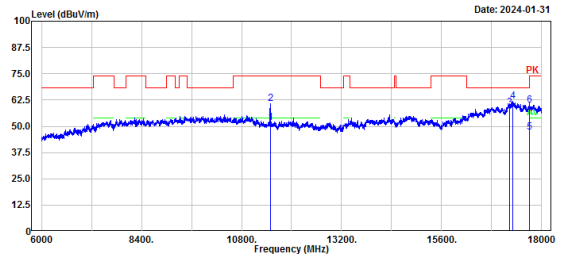

No.	Frequency (MHz)	Reading (dBuV)	Factor (dB/m)	Result (dBuV/m)	Limit (dBuV/m)	Margin (dB)	Detector
1	11490.00	47.55	4.23	51.78	54.00	2.22	Average
2	11490.00	56.52	4.23	60.75	74.00	13.25	Peak
3	17235.00	45.27	13.75	59.02	68.20	9.18	Peak
4	17303.86	47.45	14.27	61.72	68.20	6.48	Peak
5	17707.14	30.62	16.70	47.32	54.00	6.68	Average
6	17707.14	43.45	16.70	60.15	74.00	13.85	Peak

802.11 ax he20 mode, Low Channel, Bandedge, Horizontal

Project No.: DG2231229-79269E-RF Serial No.: 2FY2-1
 Polarization: Horizontal Tester: Bill Yang
 Test Mode: Transmitting
 Note: 802.11ax20_U-NII-3_Low channel 5745MHz

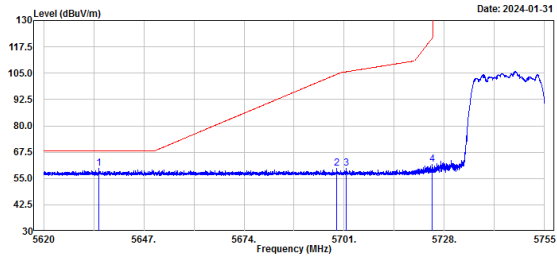

No.	Frequency (MHz)	Reading (dBuV)	Factor (dB/m)	Result (dBuV/m)	Limit (dBuV/m)	Margin (dB)	Detector
1	5634.91	29.99	29.67	59.66	68.20	8.54	Peak
2	5699.07	30.17	29.77	59.94	104.52	44.58	Peak
3	5701.50	30.23	29.77	60.00	105.62	45.62	Peak
4	5724.73	31.70	29.81	61.51	121.58	60.07	Peak

802.11 ax he20 mode, Low Channel, Bandedge, Vertical

Project No.: DG2231229-79269E-RF Serial No.: 2FY2-1
 Polarization: Vertical Tester: Bill Yang
 Test Mode: Transmitting
 Note: 802.11ax20_U-NII-3_Low channel 5745MHz

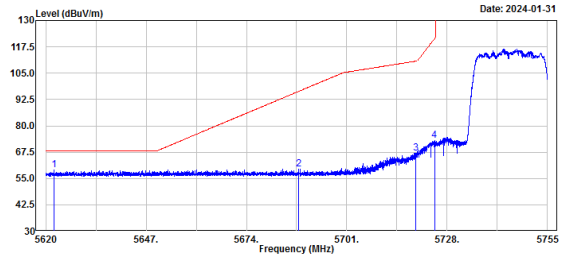

No.	Frequency (MHz)	Reading (dBuV)	Factor (dB/m)	Result (dBuV/m)	Limit (dBuV/m)	Margin (dB)	Detector
1	5622.24	29.26	29.65	58.91	68.20	9.29	Peak
2	5688.08	29.76	29.76	59.52	96.41	36.89	Peak
3	5719.60	37.34	29.80	67.14	110.69	43.55	Peak
4	5724.59	43.23	29.81	73.04	121.27	48.23	Peak

802.11 ax he20 mode, Middle Channel, Horizontal

Project No.: DG2231229-79269E-RF Serial No.: 2FY2-1
 Polarization: Horizontal Tester: Colin Yang
 Test Mode: Transmitting
 Note: 802.11ax20_U-NII-3_middle channel 5785MHz

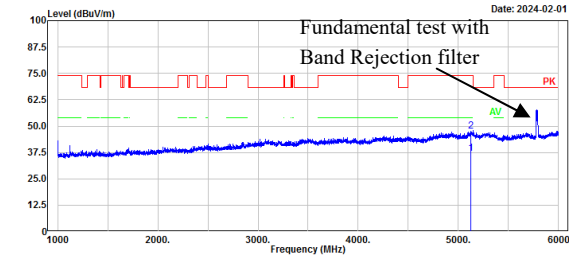

No.	Frequency (MHz)	Reading (dBμV)	Factor (dB/m)	Result (dBμV/m)	Limit (dBμV/m)	Margin (dB)	Detector
1	5122.83	38.44	-1.34	37.10	54.00	16.90	Average
2	5122.83	48.94	-1.34	47.60	74.00	26.40	Peak

802.11 ax he20 mode, Middle Channel, Vertical

Project No.: DG2231229-79269E-RF Serial No.: 2FY2-1
 Polarization: Vertical Tester: Colin Yang
 Test Mode: Transmitting
 Note: 802.11ax20_U-NII-3_middle channel 5785MHz

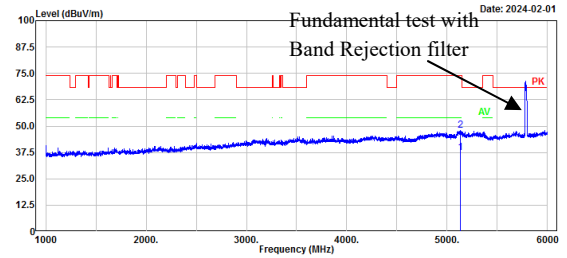

No.	Frequency (MHz)	Reading (dBμV)	Factor (dB/m)	Result (dBμV/m)	Limit (dBμV/m)	Margin (dB)	Detector
1	5134.83	38.62	-1.24	37.38	54.00	16.62	Average
2	5134.83	49.00	-1.24	47.76	74.00	26.24	Peak

Project No.: DG2231229-79269E-RF Serial No.: 2FY2-1
 Polarization: Horizontal Tester: Colin Yang
 Test Mode: Transmitting
 Note: 802.11ax20_U-NII-3_middle channel 5785MHz

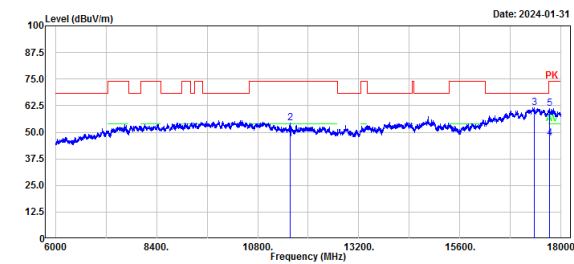

No.	Frequency (MHz)	Reading (dBμV)	Factor (dB/m)	Result (dBμV/m)	Limit (dBμV/m)	Margin (dB)	Detector
1	11570.00	42.32	4.44	46.76	54.00	7.24	Average
2	11570.00	49.87	4.44	54.31	74.00	19.69	Peak
3	17355.00	46.84	14.70	61.54	68.20	6.66	Peak
4	17728.75	30.47	16.83	47.30	54.00	6.70	Average
5	17728.75	44.28	16.83	61.11	74.00	12.89	Peak

Project No.: DG2231229-79269E-RF Serial No.: 2FY2-1
 Polarization: Vertical Tester: Colin Yang
 Test Mode: Transmitting
 Note: 802.11ax20_U-NII-3_middle channel 5785MHz

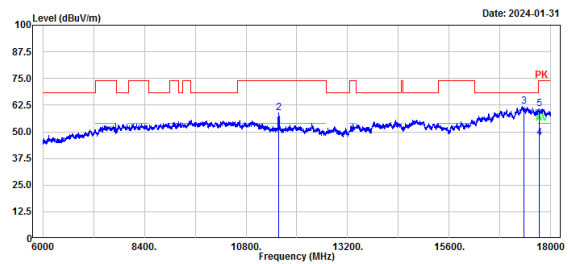

No.	Frequency (MHz)	Reading (dBμV)	Factor (dB/m)	Result (dBμV/m)	Limit (dBμV/m)	Margin (dB)	Detector
1	11570.00	48.34	4.44	52.78	54.00	1.22	Average
2	11570.00	54.35	4.44	58.79	74.00	15.21	Peak
3	17355.00	47.15	14.70	61.85	68.20	6.35	Peak
4	17723.95	30.51	16.80	47.31	54.00	6.69	Average
5	17723.95	44.10	16.80	60.90	74.00	13.10	Peak

802.11 ax he20 mode, High Channel, Horizontal

Project No.: DG2231229-79269E-RF Serial No.: 2FY2-1
 Polarization: Horizontal Tester: Colin Yang
 Test Mode: Transmitting
 Note: 802.11ax20_U-NII-3_high channel 5825MHz

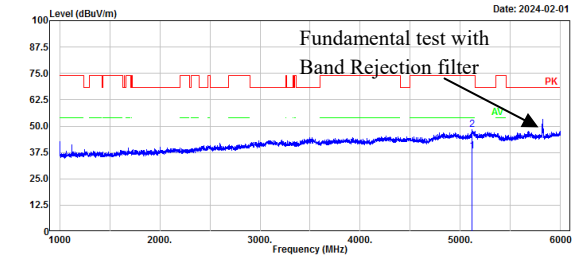

No.	Frequency (MHz)	Reading (dBuV)	Factor (dB/m)	Result (dBuV/m)	Limit (dBuV/m)	Margin (dB)	Detector
1	5112.82	39.67	-1.42	38.25	54.00	15.75	Average
2	5112.82	49.55	-1.42	48.13	74.00	25.87	Peak

802.11 ax he20 mode, High Channel, Vertical

Project No.: DG2231229-79269E-RF Serial No.: 2FY2-1
 Polarization: Vertical Tester: Colin Yang
 Test Mode: Transmitting
 Note: 802.11ax20_U-NII-3_high channel 5825MHz

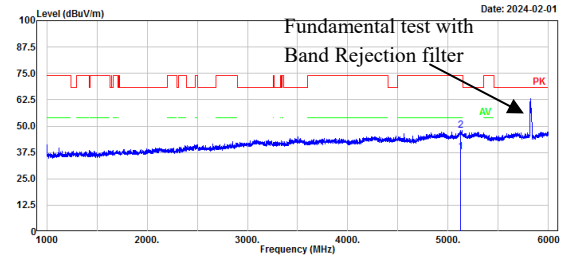

No.	Frequency (MHz)	Reading (dBuV)	Factor (dB/m)	Result (dBuV/m)	Limit (dBuV/m)	Margin (dB)	Detector
1	5126.83	39.10	-1.30	37.80	54.00	16.20	Average
2	5126.83	49.29	-1.30	47.99	74.00	26.01	Peak

Project No.: DG2231229-79269E-RF Serial No.: 2FY2-1
 Polarization: Horizontal Tester: Colin Yang
 Test Mode: Transmitting
 Note: 802.11ax20_U-NII-3_high channel 5825MHz

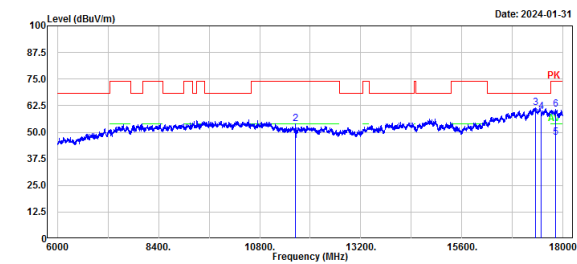

No.	Frequency (MHz)	Reading (dBuV)	Factor (dB/m)	Result (dBuV/m)	Limit (dBuV/m)	Margin (dB)	Detector
1	11650.00	41.62	4.52	46.14	54.00	7.86	Average
2	11650.00	49.39	4.52	53.91	74.00	20.09	Peak
3	17337.47	46.95	14.55	61.50	68.20	6.70	Peak
4	17475.00	43.80	15.67	59.47	68.20	8.73	Peak
5	17817.56	30.37	17.34	47.71	54.00	6.29	Average
6	17817.56	43.59	17.34	60.93	74.00	13.07	Peak

Project No.: DG2231229-79269E-RF Serial No.: 2FY2-1
 Polarization: Vertical Tester: Colin Yang
 Test Mode: Transmitting
 Note: 802.11ax20_U-NII-3_high channel 5825MHz

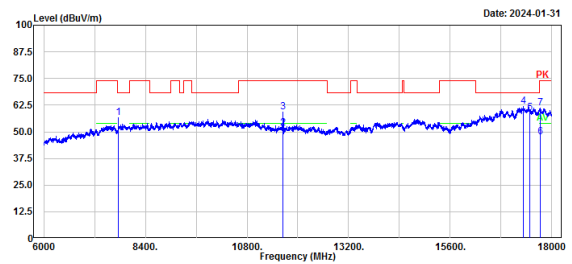

No.	Frequency (MHz)	Reading (dBuV)	Factor (dB/m)	Result (dBuV/m)	Limit (dBuV/m)	Margin (dB)	Detector
1	7766.75	53.65	3.03	56.68	68.20	11.52	Peak
2	11650.00	47.21	4.52	51.73	54.00	2.27	Average
3	11650.00	54.67	4.52	59.19	74.00	14.81	Peak
4	17320.66	47.38	14.42	61.80	68.20	6.40	Peak
5	17475.00	43.20	15.67	58.87	68.20	9.33	Peak
6	17726.35	30.58	16.81	47.39	54.00	6.61	Average
7	17726.35	44.34	16.81	61.15	74.00	12.85	Peak

802.11 ax he20 mode, High Channel, Bandedge, Horizontal

Project No.: DG2231229-79269E-RF Serial No.: 2FY2-1
 Polarization: Horizontal Tester: Bill Yang
 Test Mode: Transmitting
 Note: 802.11ax20_U-NII-3_High channel 5825MHz

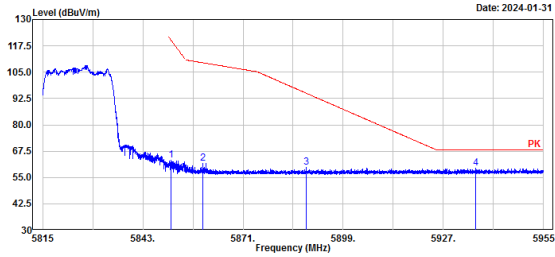

No.	Frequency (MHz)	Reading (dBuV)	Factor (dB/m)	Result (dBuV/m)	Limit (dBuV/m)	Margin (dB)	Detector
1	5850.85	33.03	29.99	63.02	120.27	57.25	Peak
2	5859.73	31.67	30.01	61.68	109.48	47.80	Peak
3	5888.63	29.62	30.06	59.68	95.08	35.40	Peak
4	5936.07	29.31	30.11	59.42	68.20	8.78	Peak

802.11 ax he20 mode, High Channel, Bandedge, Vertical

Project No.: DG2231229-79269E-RF Serial No.: 2FY2-1
 Polarization: Vertical Tester: Bill Yang
 Test Mode: Transmitting
 Note: 802.11ax20_U-NII-3_High channel 5825MHz

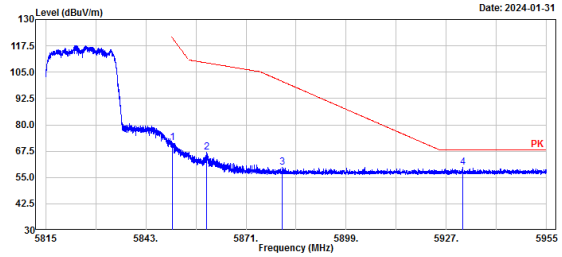

No.	Frequency (MHz)	Reading (dBuV)	Factor (dB/m)	Result (dBuV/m)	Limit (dBuV/m)	Margin (dB)	Detector
1	5850.43	41.36	29.99	71.35	121.23	49.88	Peak
2	5859.89	36.86	30.01	66.87	109.43	42.56	Peak
3	5881.12	29.89	30.05	59.94	100.65	40.71	Peak
4	5931.48	29.61	30.11	59.72	68.20	8.48	Peak

802.11 ax he40 mode, Low Channel, Horizontal

Project No.: DG2231229-79269E-RF Serial No.: 2FY2-1
 Polarization: Horizontal Tester: Colin Yang
 Test Mode: Transmitting
 Note: 802.11ax40_U-NII-3_low channel 5755MHz

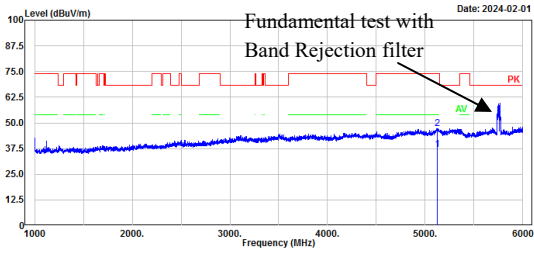

No.	Frequency (MHz)	Reading (dBuV)	Factor (dB/m)	Result (dBuV/m)	Limit (dBuV/m)	Margin (dB)	Detector
1	5121.82	38.44	-1.35	37.09	54.00	16.91	Average
2	5121.82	48.49	-1.35	47.14	74.00	26.86	Peak

802.11 ax he40 mode, Low Channel, Vertical

Project No.: DG2231229-79269E-RF Serial No.: 2FY2-1
 Polarization: Vertical Tester: Colin Yang
 Test Mode: Transmitting
 Note: 802.11ax40_U-NII-3_low channel 5755MHz

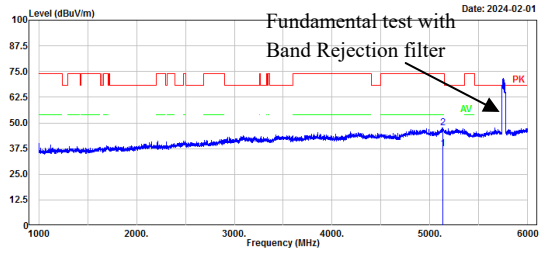

No.	Frequency (MHz)	Reading (dBuV)	Factor (dB/m)	Result (dBuV/m)	Limit (dBuV/m)	Margin (dB)	Detector
1	5134.83	38.74	-1.24	37.50	54.00	16.50	Average
2	5134.83	48.80	-1.24	47.56	74.00	26.44	Peak

Project No.: DG2231229-79269E-RF Serial No.: 2FY2-1
 Polarization: Horizontal Tester: Colin Yang
 Test Mode: Transmitting
 Note: 802.11ax40_U-NII-3_low channel 5755MHz

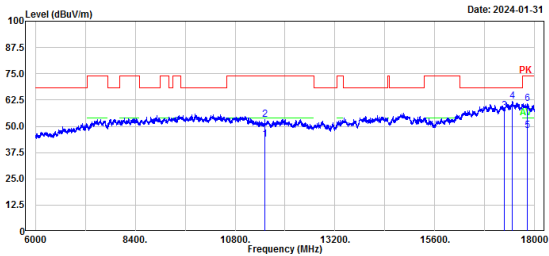

No.	Frequency (MHz)	Reading (dBuV)	Factor (dB/m)	Result (dBuV/m)	Limit (dBuV/m)	Margin (dB)	Detector
1	11510.00	39.45	4.25	43.70	54.00	10.30	Average
2	11510.00	48.96	4.25	53.21	74.00	20.79	Peak
3	17265.00	43.41	13.97	57.38	68.20	10.82	Peak
4	17462.29	46.25	15.57	61.82	68.20	6.38	Peak
5	17829.57	38.59	17.39	47.98	54.00	6.02	Average
6	17829.57	43.48	17.39	60.87	74.00	13.13	Peak

Project No.: DG2231229-79269E-RF Serial No.: 2FY2-1
 Polarization: Vertical Tester: Colin Yang
 Test Mode: Transmitting
 Note: 802.11ax40_U-NII-3_low channel 5755MHz

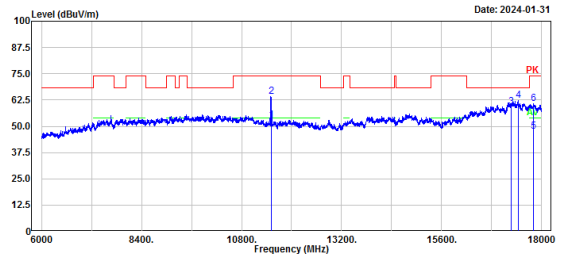

No.	Frequency (MHz)	Reading (dBuV)	Factor (dB/m)	Result (dBuV/m)	Limit (dBuV/m)	Margin (dB)	Detector
1	11510.00	48.45	4.25	52.70	54.00	1.30	Average
2	11510.00	59.74	4.25	63.99	74.00	10.01	Peak
3	17265.00	45.38	13.97	59.35	68.20	8.85	Peak
4	17433.49	46.79	15.34	62.13	68.20	6.07	Peak
5	17807.96	30.44	17.28	47.72	54.00	6.28	Average
6	17807.96	43.39	17.28	60.67	74.00	13.33	Peak

802.11 ax he40 mode, Low Channel, Bandedge, Horizontal

Project No.: DG2231229-79269E-RF Serial No.: 2FY2-1
 Polarization: Horizontal Tester: Bill Yang
 Test Mode: Transmitting
 Note: 802.11ax40_U-NII-3_Low channel 5755MHz

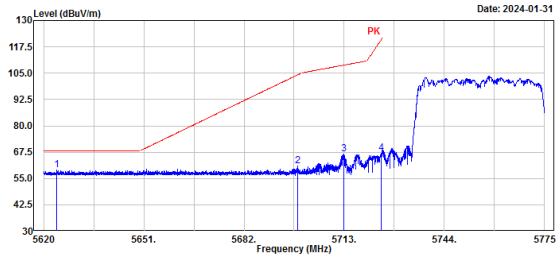

No.	Frequency (MHz)	Reading (dBuV)	Factor (dB/m)	Result (dBuV/m)	Limit (dBuV/m)	Margin (dB)	Detector
1	5624.06	29.43	29.65	59.08	68.20	9.12	Peak
2	5698.54	31.27	29.77	61.04	104.12	43.08	Peak
3	5712.80	36.68	29.80	66.48	108.79	42.31	Peak
4	5724.43	37.23	29.81	67.04	120.90	53.86	Peak

802.11 ax he40 mode, Low Channel, Bandedge, Vertical

Project No.: DG2231229-79269E-RF Serial No.: 2FY2-1
 Polarization: Vertical Tester: Bill Yang
 Test Mode: Transmitting
 Note: 802.11ax40_U-NII-3_Low channel 5755MHz

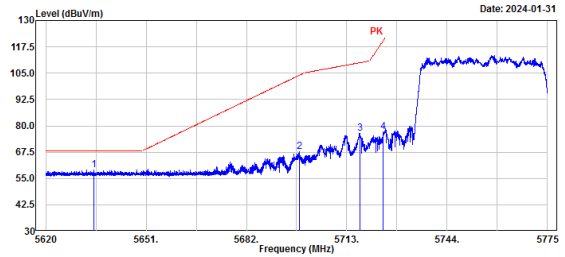

No.	Frequency (MHz)	Reading (dBuV)	Factor (dB/m)	Result (dBuV/m)	Limit (dBuV/m)	Margin (dB)	Detector
1	5634.76	29.52	29.67	59.19	68.20	9.01	Peak
2	5698.32	38.12	29.77	67.89	103.96	36.07	Peak
3	5716.96	46.60	29.80	76.40	109.95	33.55	Peak
4	5724.31	47.28	29.81	77.09	120.62	43.53	Peak

802.11 ax he40 mode, High Channel, Horizontal

Project No.: DG2231229-79269E-RF Serial No.: 2FY2-1
 Polarization: Horizontal Tester: Colin Yang
 Test Mode: Transmitting
 Note: 802.11ax40_U-NII-3_high channel 5795MHz

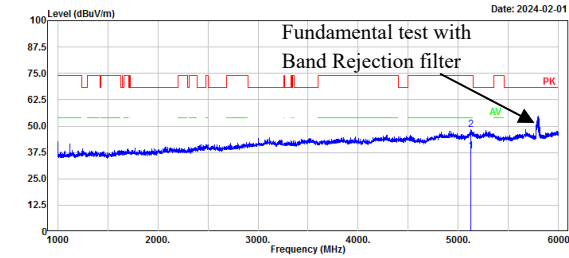

No.	Frequency (MHz)	Reading (dBμV)	Factor (dB/m)	Result (dBμV/m)	Limit (dBμV/m)	Margin (dB)	Detector
1	5124.83	39.26	-1.33	37.93	54.00	16.07	Average
2	5124.83	49.74	-1.33	48.41	74.00	25.59	Peak

802.11 ax he40 mode, High Channel, Vertical

Project No.: DG2231229-79269E-RF Serial No.: 2FY2-1
 Polarization: Vertical Tester: Colin Yang
 Test Mode: Transmitting
 Note: 802.11ax40_U-NII-3_high channel 5795MHz

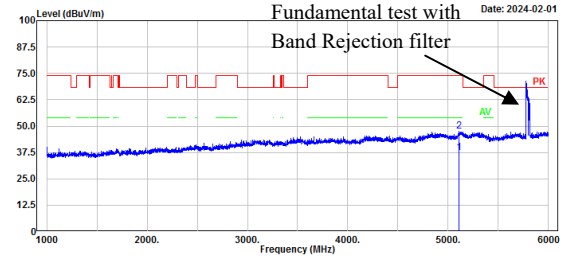

No.	Frequency (MHz)	Reading (dBμV)	Factor (dB/m)	Result (dBμV/m)	Limit (dBμV/m)	Margin (dB)	Detector
1	5109.82	38.77	-1.45	37.32	54.00	16.68	Average
2	5109.82	48.99	-1.45	47.54	74.00	26.46	Peak

Project No.: DG2231229-79269E-RF Serial No.: 2FY2-1
 Polarization: Horizontal Tester: Colin Yang
 Test Mode: Transmitting
 Note: 802.11ax40_U-NII-3_high channel 5795MHz

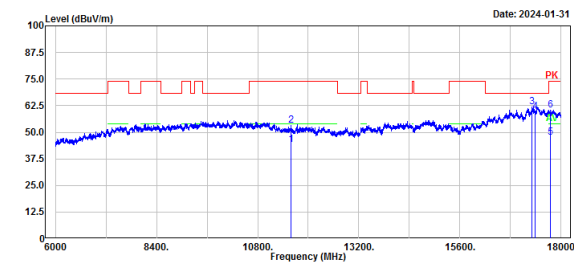

No.	Frequency (MHz)	Reading (dBμV)	Factor (dB/m)	Result (dBμV/m)	Limit (dBμV/m)	Margin (dB)	Detector
1	11590.00	39.67	4.51	44.18	54.00	9.82	Average
2	11590.00	48.80	4.51	53.31	74.00	20.69	Peak
3	17301.46	47.81	14.25	62.06	68.20	6.14	Peak
4	17385.00	44.69	14.96	59.65	68.20	8.55	Peak
5	17752.75	30.55	16.96	47.51	54.00	6.49	Average
6	17752.75	43.27	16.96	60.23	74.00	13.77	Peak

Project No.: DG2231229-79269E-RF Serial No.: 2FY2-1
 Polarization: Vertical Tester: Colin Yang
 Test Mode: Transmitting
 Note: 802.11ax40_U-NII-3_high channel 5795MHz

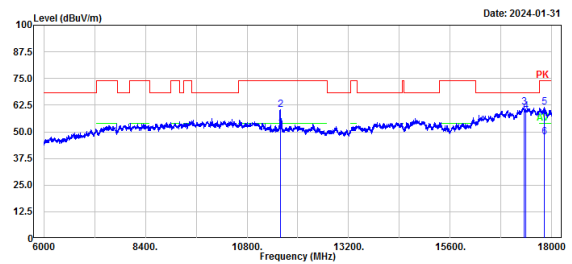

No.	Frequency (MHz)	Reading (dBμV)	Factor (dB/m)	Result (dBμV/m)	Limit (dBμV/m)	Margin (dB)	Detector
1	11590.00	47.23	4.51	51.74	54.00	2.26	Average
2	11590.00	55.91	4.51	60.42	74.00	13.58	Peak
3	17337.47	47.02	14.55	61.57	68.20	6.63	Peak
4	17385.00	44.85	14.96	59.81	68.20	8.39	Peak
5	17829.57	44.30	17.39	61.69	74.00	12.31	Peak
6	17829.57	30.31	17.39	47.70	54.00	6.30	Average

802.11 ax he40 mode, High Channel, Bandedge, Horizontal

Project No.: DG2231229-79269E-RF Serial No.: 2FY2-1
 Polarization: Horizontal Tester: Bill Yang
 Test Mode: Transmitting
 Note: 802.11ax40_U-NII-3_High channel 5795MHz

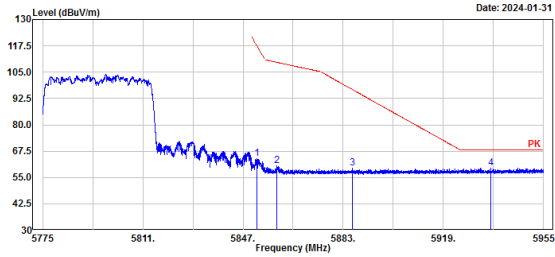

No.	Frequency (MHz)	Reading (dBuV)	Factor (dB/m)	Result (dBuV/m)	Limit (dBuV/m)	Margin (dB)	Detector
1	5852.13	34.06	29.99	64.05	117.35	53.30	Peak
2	5859.26	30.60	30.01	60.61	109.61	49.00	Peak
3	5886.26	29.41	30.05	59.46	96.84	37.38	Peak
4	5936.10	29.46	30.11	59.57	68.20	8.63	Peak

802.11 ax he40 mode, High Channel, Bandedge, Vertical

Project No.: DG2231229-79269E-RF Serial No.: 2FY2-1
 Polarization: Vertical Tester: Bill Yang
 Test Mode: Transmitting
 Note: 802.11ax40_U-NII-3_High channel 5795MHz

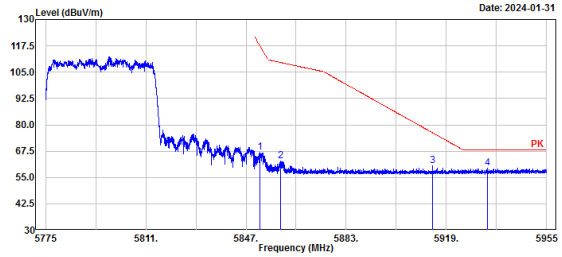

No.	Frequency (MHz)	Reading (dBuV)	Factor (dB/m)	Result (dBuV/m)	Limit (dBuV/m)	Margin (dB)	Detector
1	5852.02	37.05	29.99	67.04	117.59	50.55	Peak
2	5859.51	32.85	30.01	62.86	109.54	46.68	Peak
3	5913.92	30.32	30.09	60.41	76.38	15.97	Peak
4	5933.61	29.37	30.11	59.48	68.20	8.72	Peak

802.11 ax he80 mode, Middle Channel, Horizontal

Project No.: DG2231229-79269E-RF
 Polarization: Horizontal
 Test Mode: Transmitting
 Note: 802.11ax80_U-NII-3_Middle channel 5775MHz

Serial No.: 2FY2-1
 Tester: Colin Yang

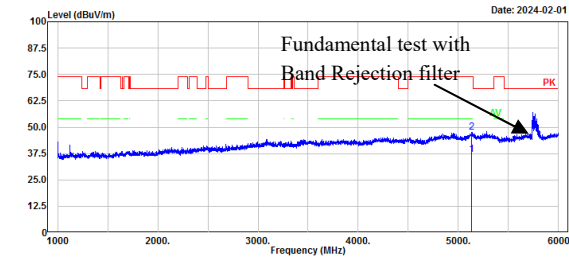

No.	Frequency (MHz)	Reading (dBuV)	Factor (dB/m)	Result (dBuV/m)	Limit (dBuV/m)	Margin (dB)	Detector
1	5131.83	38.37	-1.27	37.10	54.00	16.90	Average
2	5131.83	48.82	-1.27	47.55	74.00	26.45	Peak

802.11 ax he80 mode, Middle Channel, Vertical

Project No.: DG2231229-79269E-RF
 Polarization: Vertical
 Test Mode: Transmitting
 Note: 802.11ax80_U-NII-3_Middle channel 5775MHz

Serial No.: 2FY2-1
 Tester: Colin Yang

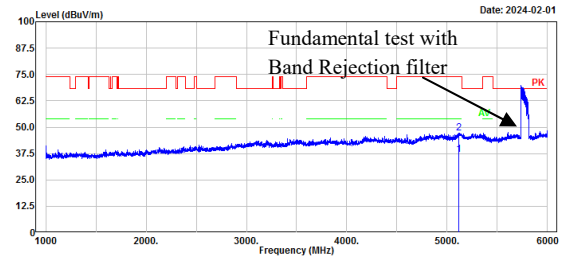

No.	Frequency (MHz)	Reading (dBuV)	Factor (dB/m)	Result (dBuV/m)	Limit (dBuV/m)	Margin (dB)	Detector
1	5112.82	38.32	-1.42	36.90	54.00	17.10	Average
2	5112.82	48.64	-1.42	47.22	74.00	26.78	Peak

Project No.: DG2231229-79269E-RF
 Polarization: Horizontal
 Test Mode: Transmitting
 Note: 802.11ax80_U-NII-3_Middle channel 5775MHz

Serial No.: 2FY2-1
 Tester: Colin Yang

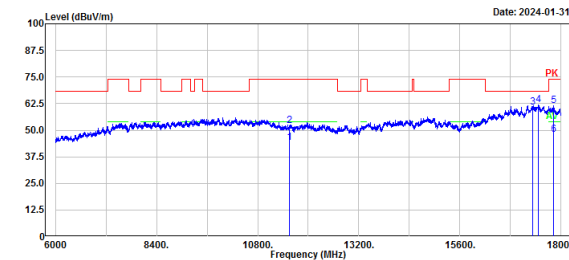

No.	Frequency (MHz)	Reading (dBuV)	Factor (dB/m)	Result (dBuV/m)	Limit (dBuV/m)	Margin (dB)	Detector
1	11550.00	39.67	4.38	44.05	54.00	9.95	Average
2	11550.00	47.71	4.38	52.09	74.00	21.91	Peak
3	17325.00	46.36	14.45	60.81	68.20	7.39	Peak
4	17457.49	46.48	15.53	62.01	68.20	6.19	Peak
5	17824.77	44.18	17.36	61.54	74.00	12.46	Peak
6	17824.77	30.43	17.36	47.79	54.00	6.21	Average

Project No.: DG2231229-79269E-RF
 Polarization: Vertical
 Test Mode: Transmitting
 Note: 802.11ax80_U-NII-3_Middle channel 5775MHz

Serial No.: 2FY2-1
 Tester: Colin Yang

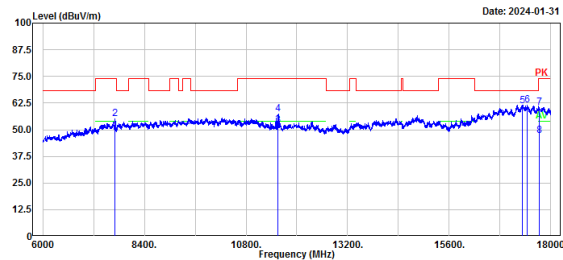

No.	Frequency (MHz)	Reading (dBuV)	Factor (dB/m)	Result (dBuV/m)	Limit (dBuV/m)	Margin (dB)	Detector
1	7699.54	46.63	2.96	49.59	54.00	4.41	Average
2	7699.54	52.10	2.96	55.06	74.00	18.94	Peak
3	11550.00	47.65	4.38	52.03	54.00	1.97	Average
4	11550.00	53.05	4.38	57.43	74.00	16.57	Peak
5	17325.00	46.59	14.45	61.04	68.20	7.16	Peak
6	17440.69	46.05	15.40	61.45	68.20	6.75	Peak
7	17731.15	43.67	16.83	60.50	74.00	13.50	Peak
8	17731.15	30.26	16.83	47.09	54.00	6.91	Average

802.11 ax he80 mode, Middle Channel, Bandedge, Horizontal

Project No.: DG2231229-79269E-RF
 Polarization: Horizontal
 Test Mode: Transmitting
 Note: 802.11ax80_U-NII-3_Middle channel 5775MHz

Serial No.: 2FY2-1
 Tester: Bill Yang

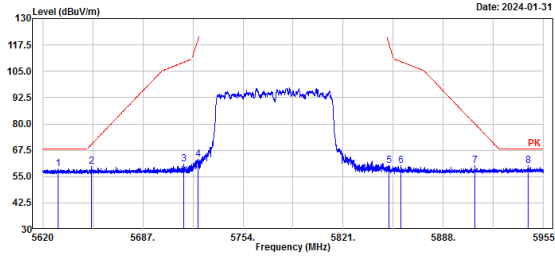

No.	Frequency (MHz)	Reading (dBuV)	Factor (dB/m)	Result (dBuV/m)	Limit (dBuV/m)	Margin (dB)	Detector
1	5630.45	29.12	29.66	58.78	68.20	9.42	Peak
2	5652.90	30.01	29.70	59.71	70.36	10.65	Peak
3	5714.29	31.08	29.80	60.88	109.20	48.32	Peak
4	5724.01	33.56	29.81	63.37	119.93	56.56	Peak
5	5851.73	30.36	29.99	60.35	118.25	57.90	Peak
6	5859.71	30.17	30.01	60.18	109.48	49.30	Peak
7	5909.10	30.02	30.09	60.11	79.94	19.83	Peak
8	5944.88	29.99	30.11	60.10	68.20	8.10	Peak

802.11 ax he80 mode, Middle Channel, Bandedge, Vertical

Project No.: DG2231229-79269E-RF
 Polarization: Vertical
 Test Mode: Transmitting
 Note: 802.11ax80_U-NII-3_Middle channel 5775MHz

Serial No.: 2FY2-1
 Tester: Bill Yang

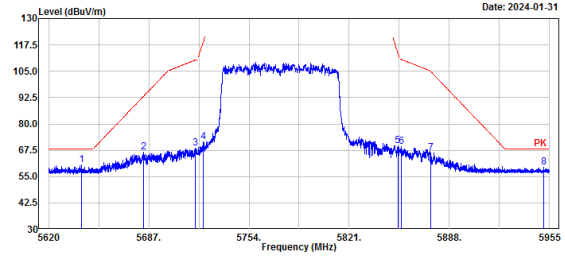

No.	Frequency (MHz)	Reading (dBuV)	Factor (dB/m)	Result (dBuV/m)	Limit (dBuV/m)	Margin (dB)	Detector
1	5642.05	30.79	29.68	60.47	68.20	7.73	Peak
2	5683.46	36.86	29.75	66.61	93.00	26.39	Peak
3	5718.31	38.57	29.80	68.37	110.33	41.96	Peak
4	5723.33	41.55	29.81	71.36	118.40	47.04	Peak
5	5853.48	39.70	29.99	69.69	114.28	44.59	Peak
6	5855.69	39.11	30.00	69.11	110.61	41.50	Peak
7	5875.32	36.22	30.04	66.26	104.96	38.70	Peak
8	5951.05	29.18	30.12	59.30	68.20	8.90	Peak

18-40GHz:

No Emission was detected in the range 18-40GHz, test was performed on the mode and channel which with the maximum power.

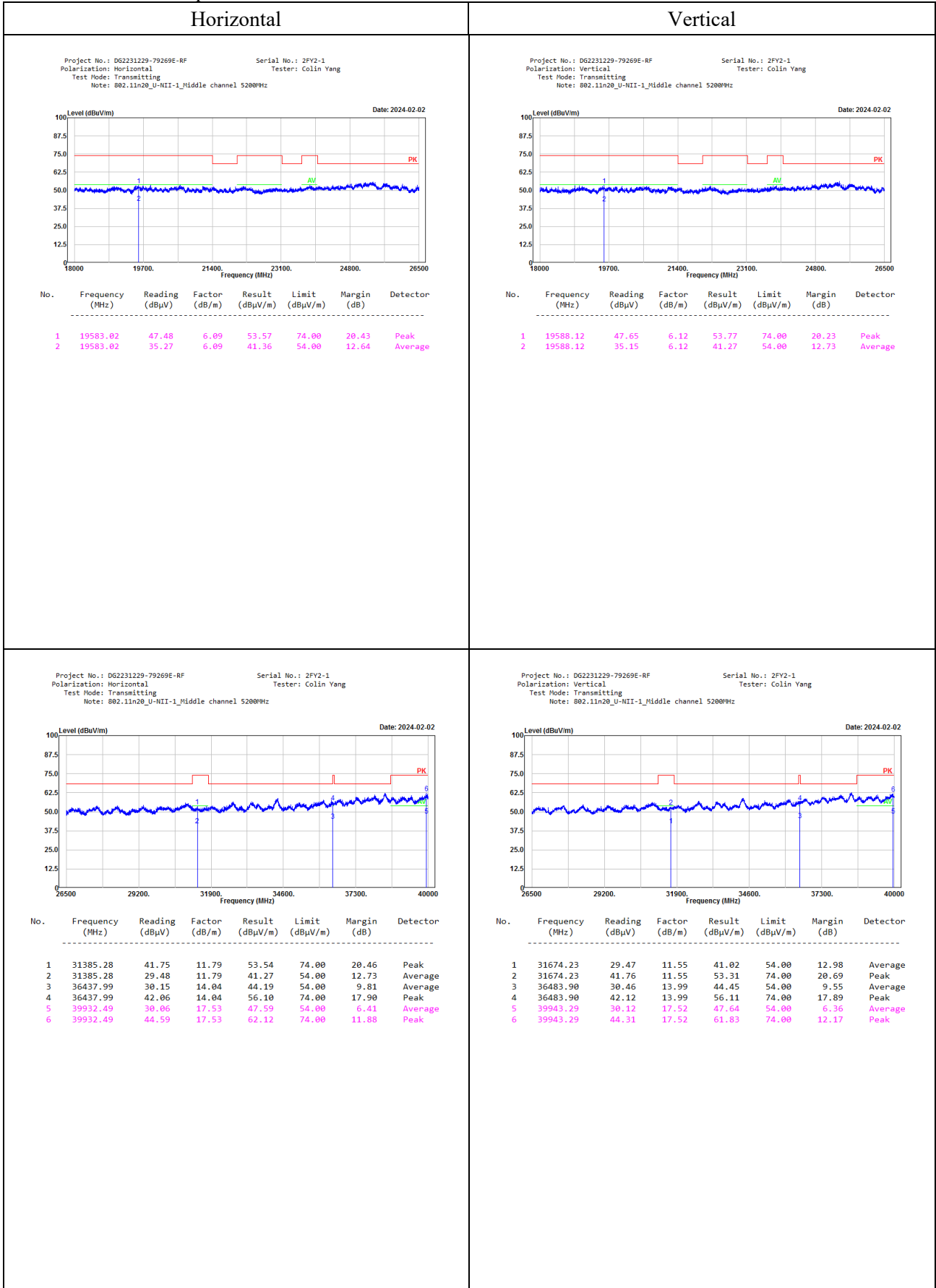

5.3 Emission Bandwidth

Serial No.:	2FY2-5	Test Date:	2024/02/04~2024/02/05
Test Site:	RF	Test Mode:	Transmitting
Tester:	Jojo Zhou	Test Result:	Pass

Environmental Conditions:

Temperature: (°C)	23.8~24.1	Relative Humidity: (%)	39~42	ATM Pressure: (kPa)	101~101.3
-----------------------------	-----------	----------------------------------	-------	-------------------------------	-----------

Test Equipment List and Details:

Manufacturer	Description	Model	Serial Number	Calibration Date	Calibration Due Date
R&S	Spectrum Analyzer	FSV40	101947	2023/10/18	2024/10/17
yzjingcheng	Coaxial Cable	KTRFBU-141-50	41010012	2023/09/01	2024/08/31
E-Microwave	Coaxial Attenuators	EMCA10-5RN-6	OE01203239	2023/09/01	2024/08/31

* Statement of Traceability: Bay Area Compliance Laboratories Corp. (Dongguan) attests that all calibrations have been performed, traceable to National Primary Standards and International System of Units (SI).

Test Data:**5150-5250 MHz****26 dB Emission Bandwidth:**

Mode	Value (MHz)
a_5180MHz_Chain 0	18.641
a_5200MHz_Chain 0	18.581
a_5240MHz_Chain 0	18.641
n20_5180MHz_Chain 0	19.541
n20_5200MHz_Chain 0	19.541
n20_5240MHz_Chain 0	19.660
n40_5190MHz_Chain 0	39.441
n40_5230MHz_Chain 0	39.441
ac20_5180MHz_Chain 0	19.481
ac20_5200MHz_Chain 0	19.421
ac20_5240MHz_Chain 0	19.421
ac40_5190MHz_Chain 0	39.201
ac40_5230MHz_Chain 0	39.321
ac80_5210MHz_Chain 0	85.594
ax20_5180MHz_RU_FULL_Chain 0	20.559
ax20_5200MHz_RU_FULL_Chain 0	20.440
ax20_5240MHz_RU_FULL_Chain 0	20.500
ax40_5190MHz_RU_FULL_Chain 0	40.520
ax40_5230MHz_RU_FULL_Chain 0	40.520
ax80_5210MHz_RU_FULL_Chain 0	81.519

5725-5850 MHz**Minimum 6dB Emission Bandwidth:**

Mode	Value (MHz)	Limit (MHz)	Result
a_5745MHz_Chain 0	16.384	0.500	Pass
a_5785MHz_Chain 0	16.384	0.500	Pass
a_5825MHz_Chain 0	16.384	0.500	Pass
n20_5745MHz_Chain 0	17.503	0.500	Pass
n20_5785MHz_Chain 0	17.463	0.500	Pass
n20_5825MHz_Chain 0	17.343	0.500	Pass
n40_5755MHz_Chain 0	36.124	0.500	Pass
n40_5795MHz_Chain 0	36.204	0.500	Pass
ac20_5745MHz_Chain 0	17.782	0.500	Pass
ac20_5785MHz_Chain 0	17.782	0.500	Pass
ac20_5825MHz_Chain 0	17.782	0.500	Pass
ac40_5755MHz_Chain 0	36.683	0.500	Pass
ac40_5795MHz_Chain 0	36.603	0.500	Pass
ac80_5775MHz_Chain 0	76.883	0.500	Pass
ax20_5745MHz_RU_FULL_Chain 0	19.181	0.500	Pass
ax20_5785MHz_RU_FULL_Chain 0	19.141	0.500	Pass
ax20_5825MHz_RU_FULL_Chain 0	19.141	0.500	Pass
ax40_5755MHz_RU_FULL_Chain 0	38.202	0.500	Pass
ax40_5795MHz_RU_FULL_Chain 0	38.202	0.500	Pass
ax80_5775MHz_RU_FULL_Chain 0	77.522	0.500	Pass

5150-5250MHz:
26dB Emission Bandwidth:

a_5180MHz_Chain 0

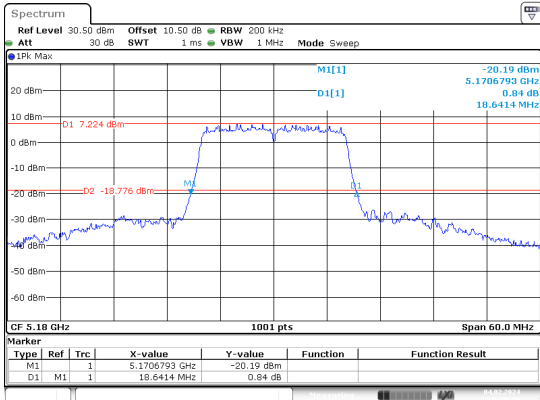

ProjectNo.:DG2231229-79269E-RF Tester:Jojo Zhou
Date: 4.FEB.2024 16:40:28

a_5200MHz_Chain 0

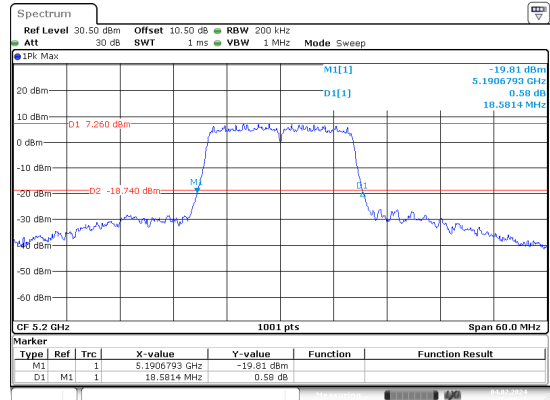

ProjectNo.:DG2231229-79269E-RF Tester:Jojo Zhou
Date: 4.FEB.2024 16:43:19

a_5240MHz_Chain 0

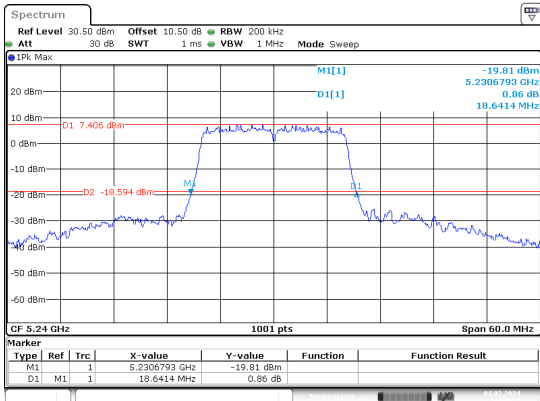

ProjectNo.:DG2231229-79269E-RF Tester:Jojo Zhou
Date: 4.FEB.2024 16:44:58

n20_5180MHz_Chain 0

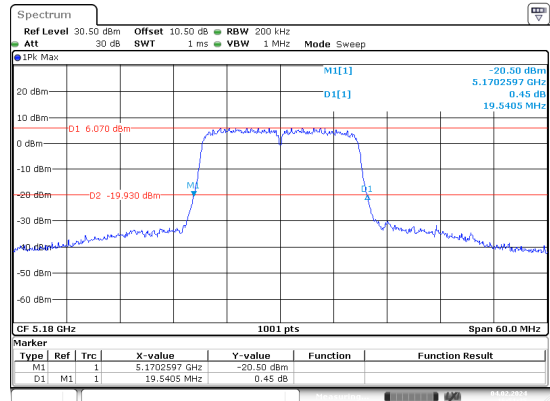

ProjectNo.:DG2231229-79269E-RF Tester:Jojo Zhou
Date: 4.FEB.2024 16:51:34

n20_5200MHz_Chain 0

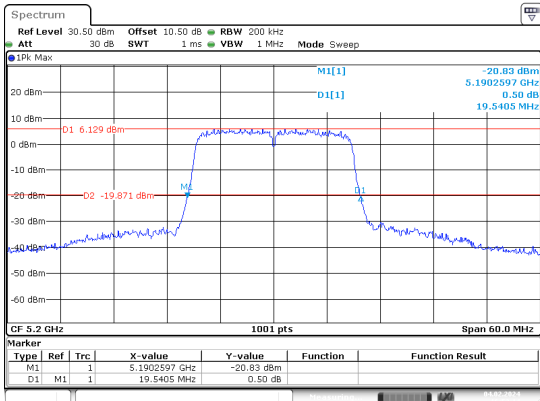

ProjectNo.:DG2231229-79269E-RF Tester:Jojo Zhou
Date: 4.FEB.2024 16:53:14

n20_5240MHz_Chain 0

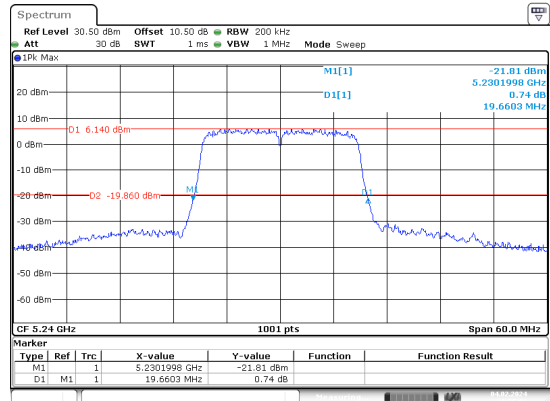

ProjectNo.:DG2231229-79269E-RF Tester:Jojo Zhou
Date: 4.FEB.2024 16:55:00

n40_5190MHz_Chain 0

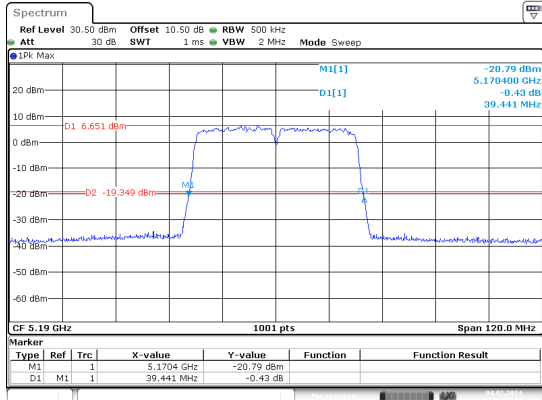

ProjectNo.:DG2231229-79269E-RF Tester:Jojo Zhou
Date: 4.FEB.2024 16:57:42

n40_5230MHz_Chain 0

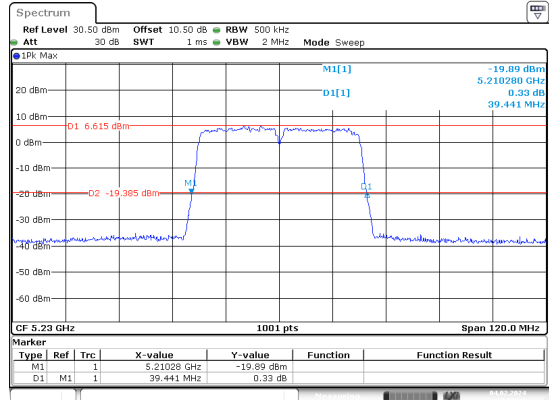

ProjectNo.:DG2231229-79269E-RF Tester:Jojo Zhou
Date: 4.FEB.2024 17:01:40

ac20_5180MHz_Chain 0

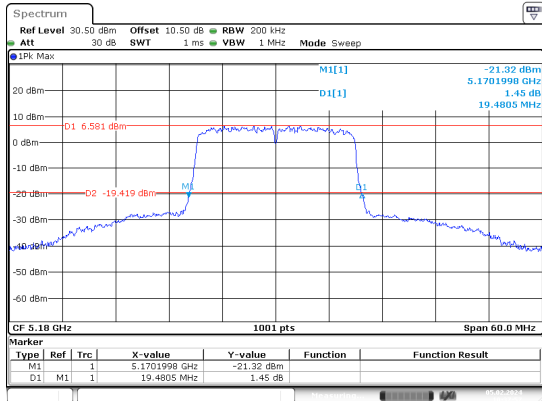

ProjectNo.:DG2231229-79269E-RF Tester:Jojo Zhou
Date: 5.FEB.2024 10:37:57

ac20_5200MHz_Chain 0

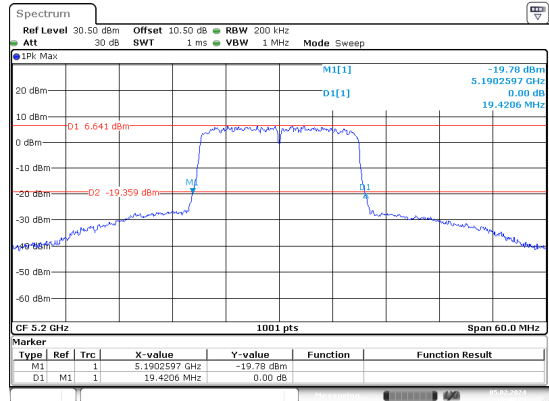

ProjectNo.:DG2231229-79269E-RF Tester:Jojo Zhou
Date: 5.FEB.2024 10:40:25

ac20_5240MHz_Chain 0

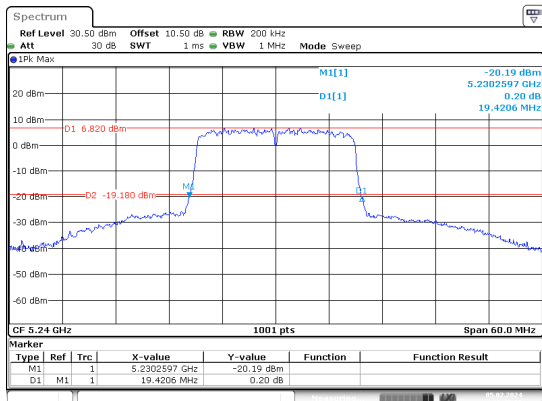

ProjectNo.:DG2231229-79269E-RF Tester:Jojo Zhou
Date: 5.FEB.2024 10:42:21

ac40_5190MHz_Chain 0

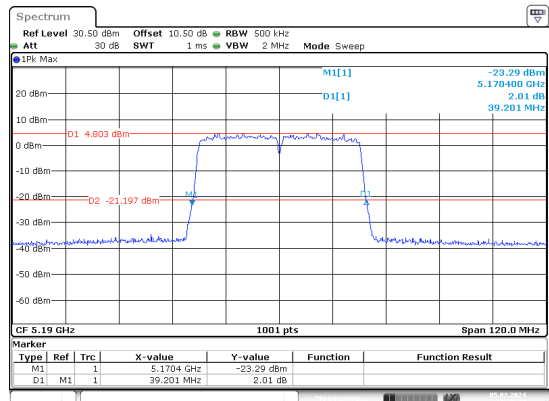

ProjectNo.:DG2231229-79269E-RF Tester:Jojo Zhou
Date: 5.FEB.2024 10:45:17

ac40_5230MHz_Chain 0

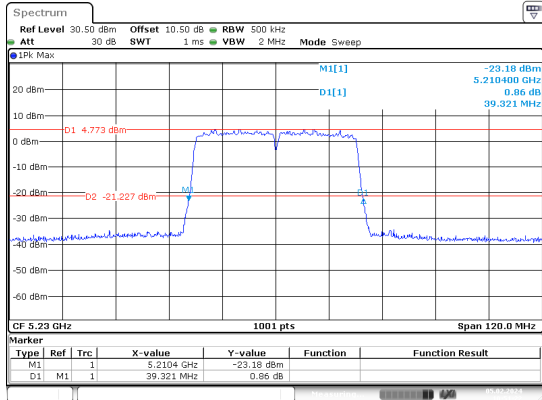

ProjectNo.:DG2231229-79269E-RF Tester:Jojo Zhou
Date: 5.FEB.2024 10:51:22

ac80_5210MHz_Chain 0

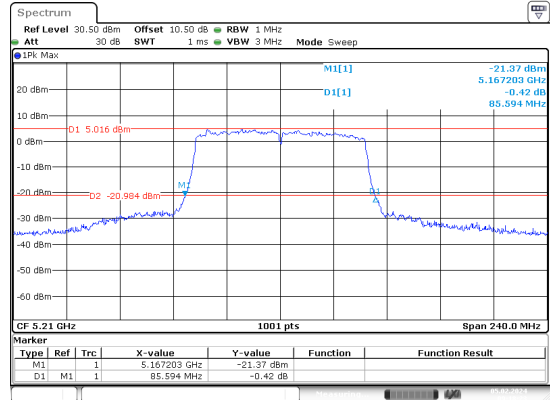

ProjectNo.:DG2231229-79269E-RF Tester:Jojo Zhou
Date: 5.FEB.2024 09:19:23

ax20_5180MHz_RU_FULL_Chain 0

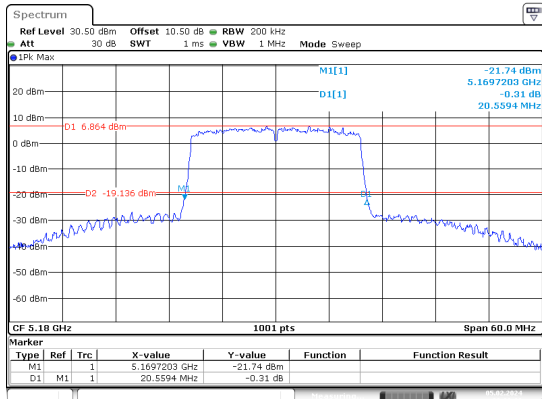

ProjectNo.:DG2231229-79269E-RF Tester:Jojo Zhou
Date: 5.FEB.2024 09:26:13

ax20_5200MHz_RU_FULL_Chain 0

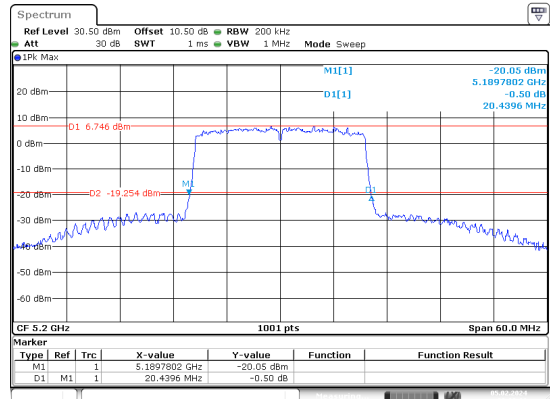

ProjectNo.:DG2231229-79269E-RF Tester:Jojo Zhou
Date: 5.FEB.2024 09:28:22

ax20_5240MHz_RU_FULL_Chain 0

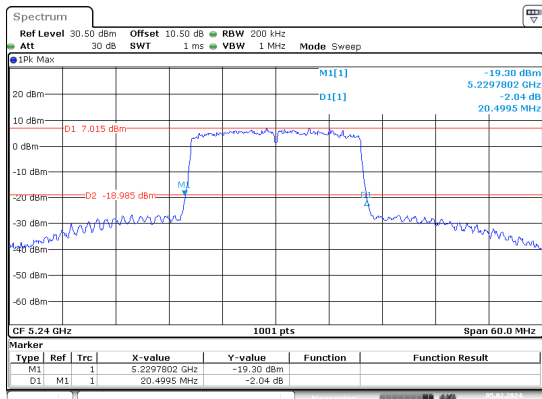

ProjectNo.:DG2231229-79269E-RF Tester:Jojo Zhou
Date: 5.FEB.2024 09:30:16

ax40_5190MHz_RU_FULL_Chain 0

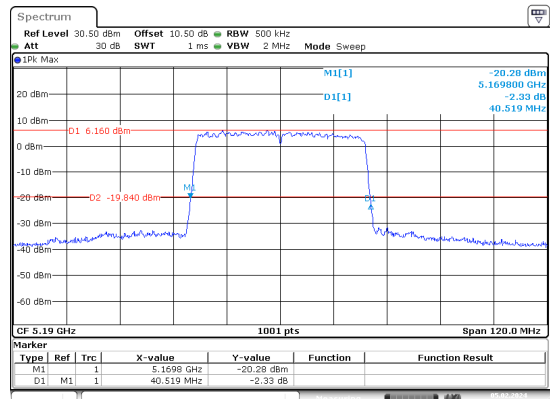

ProjectNo.:DG2231229-79269E-RF Tester:Jojo Zhou
Date: 5.FEB.2024 09:32:32

ax40_5230MHz_RU_FULL_Chain 0

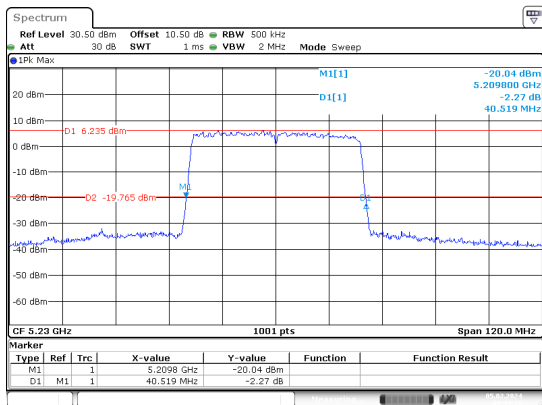

ProjectNo.:DG2231229-79269E-RF Tester:Jojo Zhou
 Date: 5.FEB.2024 09:35:17

ax80_5210MHz_RU_FULL_Chain 0

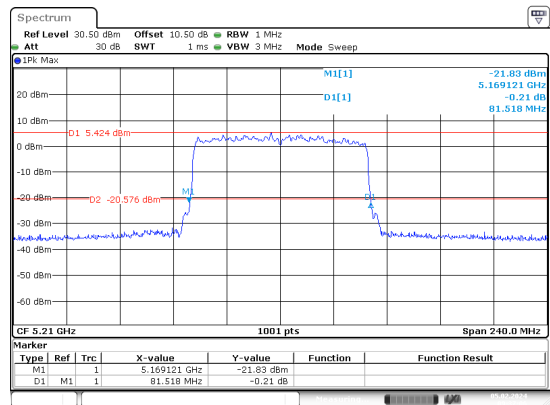

ProjectNo.:DG2231229-79269E-RF Tester:Jojo Zhou
 Date: 5.FEB.2024 09:37:07