

## Install Guide

5GHz Long Range Outdoor CPE

You can get the User Guide online at [www.tendacn.com](http://www.tendacn.com) for featured settings of the device.

### Package Contents

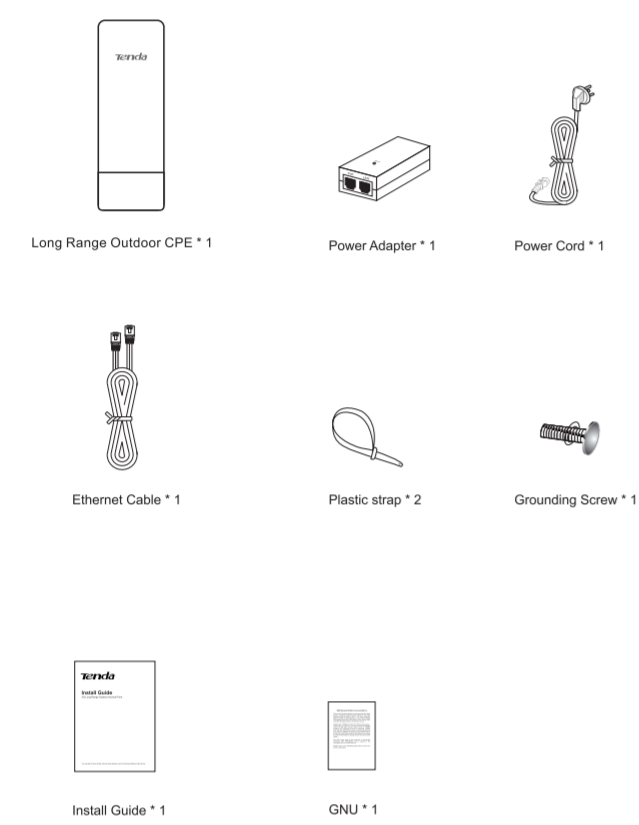

## 1 Get to Know Your Device

### Front View

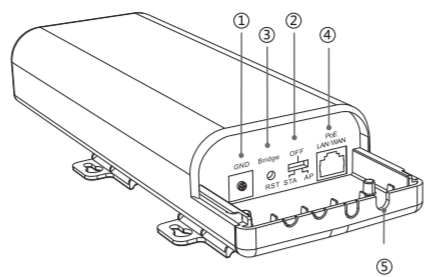

| Item | Port / Button            | Description  |
|------|--------------------------|--|
| ①    | GND                      | With the included grounding screw, attach a copper wire here to provide proper surge and lightning protection for your device.   |
| ②    | STA/OFF/AP (Mode Switch) | Used to adjust operating mode of the device.<br><b>OFF</b> : the default position. When the switch is on OFF position, you can change operating mode through WEB UI.<br><b>STA</b> : When the switch is on STA position, the device only work at station mode, and you can't change the operating mode through WEB UI.<br><b>AP</b> : When the switch is on AP position, the device only work at AP mode, and you can't change the operating mode through WEB UI.  |
| ③    | Bridge/RST               | Used to bridge two device or reset the device to factory default settings.<br>1. When one O6 switch to AP position and another switch to STA Position, Pressing and holding Bridge/RST button for 3~7 seconds on AP device, then release it, the Signal Threshold LED1(LED1/LED2/LED3) will start blinking. Within 2 minutes, pressing and holding Bridge/RST button for 3~7 seconds on Station device, then release it, the Station will start to negotiate with AP automatically to connect to it. When two device bridge successfully, the Signal Threshold LED (LED1/LED2/LED3) will turn on and be solid.<br>2. Pressing and holding the RST/Bridge button for over 15 seconds to restore this device to factory default. |
| ④    | PoE/LAN/WAN              | This port provides power over an Ethernet connection via the PoE injector. And it works interchangeably as a WAN port in Router mode and a LAN port in other modes.  |
| ⑤    | /                        | Cable access hole cut-outs   |

### Rear View

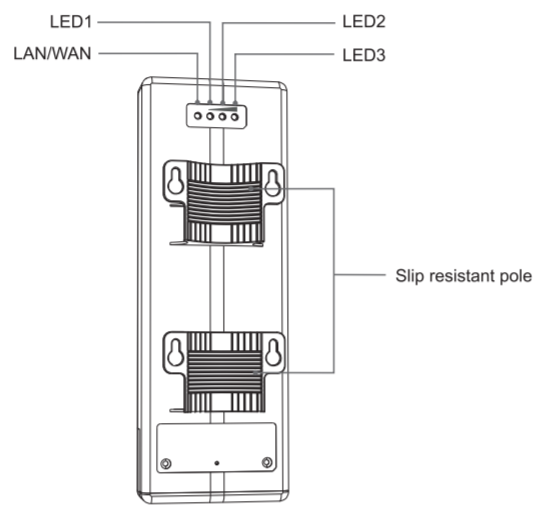

| LED                                   | Status   | Description  |
|---------------------------------------|----------|--|
| LAN                                   | Off      | The device is powered off.   |
|                                       | Solid    | The device is powered on, and there is no data transmission.   |
|                                       | Blinking | There is data transmission on this port.   |
| LED1/LED2/LED3 (Signal Threshold LED) | Off      | The device isn't bridged to other device.  |
|                                       | Blinking | The device is negotiating with other device to bridge together.  |
|                                       | Solid    | The Signal Threshold LEDs on the device will light up when received signal levels reach the values defined in the LED1/LED2/LED3 fields in the WEB UI. This allows a technician to easily deploy a CPE product without logging into the device. The default values are shown below:<br>When -90 dBm < wireless signal strength < -80dBm, LED1, LED2 will be green.<br>When -80 dBm < wireless signal strength < -70dBm, LED1, LED2 will be green.<br>When -70 dBm < wireless signal strength, LED1, LED2 and LED3 will be green. |

## 2 Hardware Install

### Step 1: Mount the AP

Set up the AP in an outdoor location, usually on the roof, and thread plastic straps through grooves underneath the brackets. Then attach the device firmly to a solid pole.

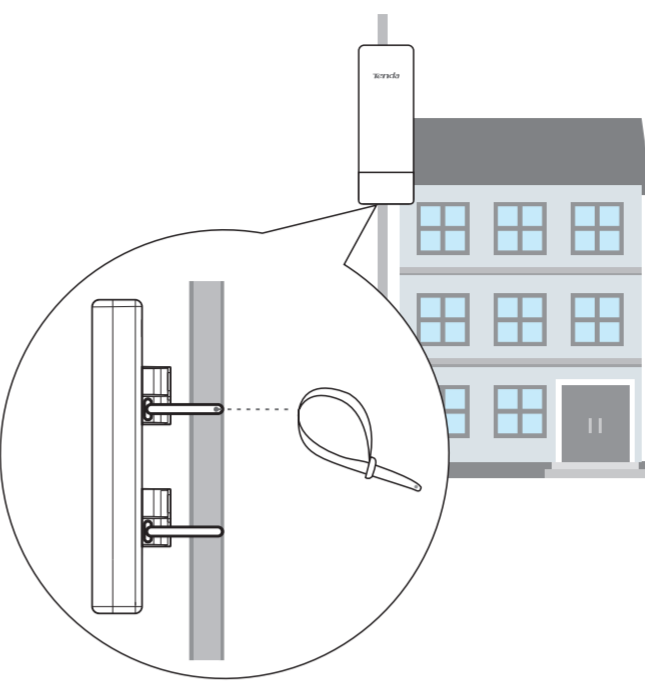

### Step 2: Connect the AP

- Slide the bottom cover of the AP down to expose the ports.
- Connect the PoE LAN/WAN port of device to the PoE port of the adapter with an Ethernet cable.
- Connect your computer to the LAN port of the adapter with another Ethernet cable.
- Gently replace the cover by sliding it up until it clicks into place.
- Connect the Power Cord to the adapter's power port. Connect the other end of the Power Cord to a power outlet.

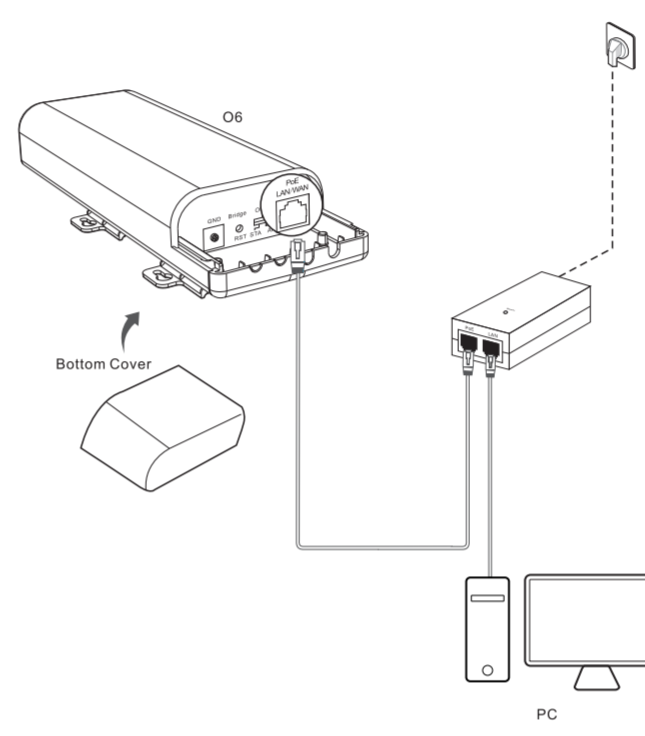

## 3 Configure PC

\* Take Windows 7 as an example

- Step 1:** Click the icon on the bottom right corner of your desktop.  
**Step 2:** Click **Open Network and Sharing Center**.

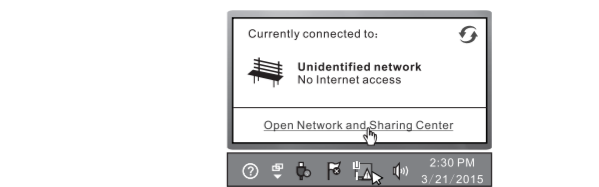

- Tips**  
If you can't find the icon on the bottom right corner of your desktop, follow steps below:  
Click **Start > Control Panel > Network and Internet > Network and Sharing Center**.

**Step 3:** Click **Local Area Connection > Properties**.

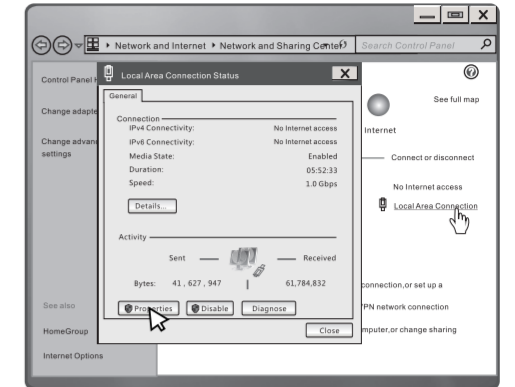

**Step 4:** Find and double click **Internet Protocol Version 4(TCP/IPv4)**.

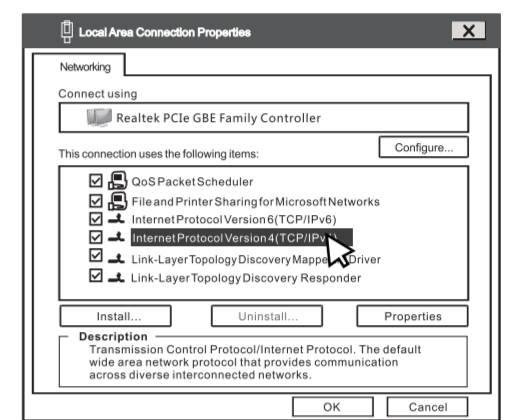

**Step 5:** Select **Use the following IP address**, type in the IP address: **192.168.2.x (2-253)**, Subnet mask: **255.255.255.0** and click **OK**.

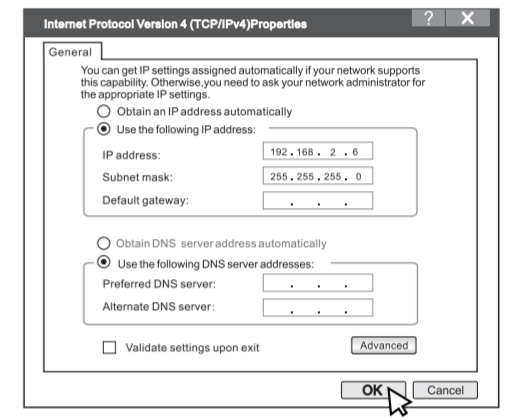

**Step 6:** Click **OK** on the **Local Area Connection Properties** window (see Step 4 for the screenshot).

## 4 Configure the AP

**Step 1:** Input **192.168.2.1** in a web browser's address bar, and then press **Enter** or **Return** on your keyboard.

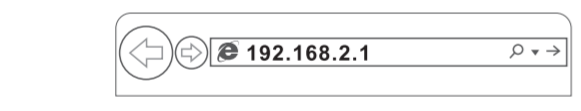

**Step 2:** Enter the default username and password (**admin** for both defaults) and click **Login**.

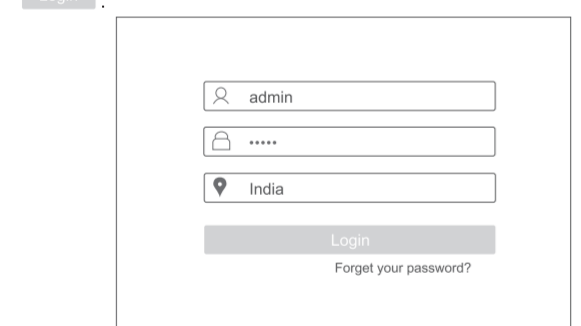

**Step 3:** Please select the proper operating mode and follow instructions on the web UI to apply your settings.

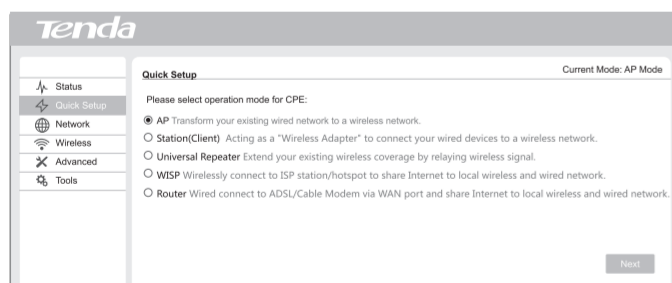

Here we will mainly introduce 2 application scenarios to you.

### AP Mode + Station Mode

For long-distance data transmission and IP camera (CCTV) surveillance, one works in AP mode and the other works in Station mode to build stable wireless connection. Please follow the steps as shown below.

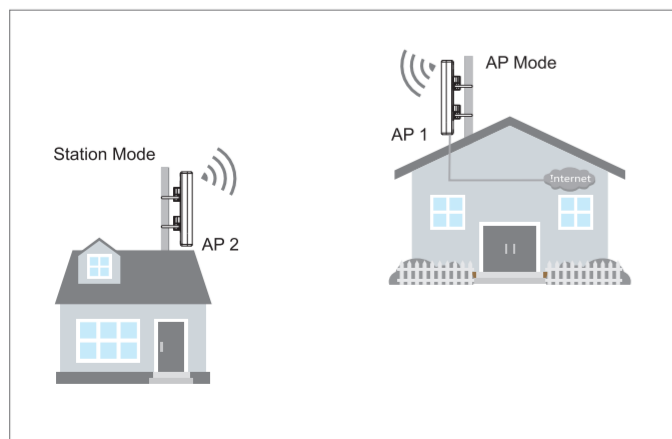

### 1. Set AP1 in AP mode.

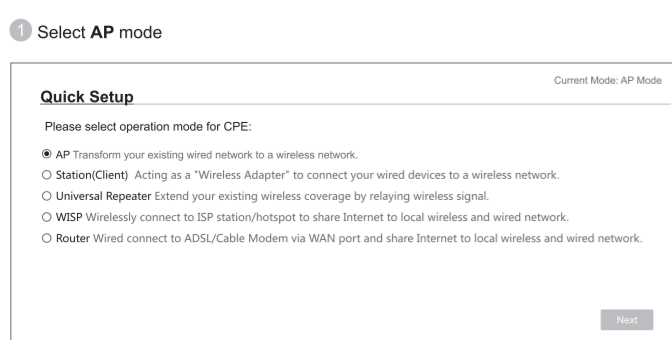

### 2. Set AP2 in Station mode.

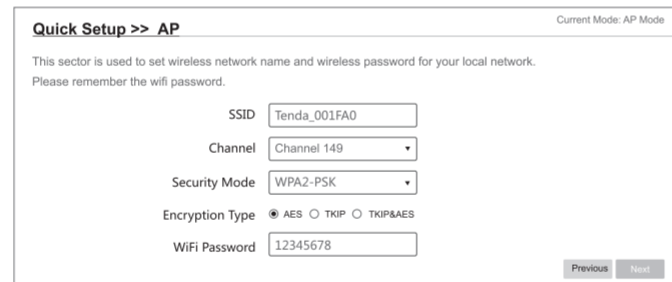

Then click **Save** on the appearing page to apply your settings. Wait until the device restarts automatically.

### 2. Set AP2 in Station mode.

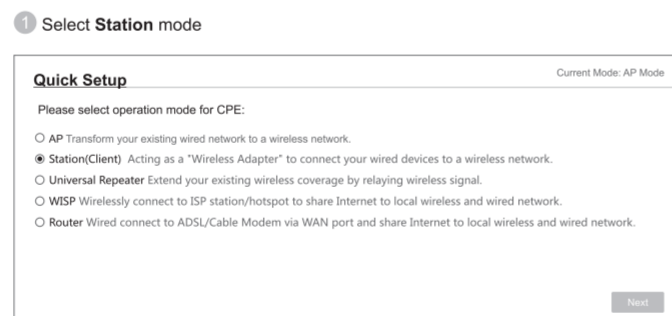

### 2. Select the remote SSID (WiFi name) you wish to bridge from the list

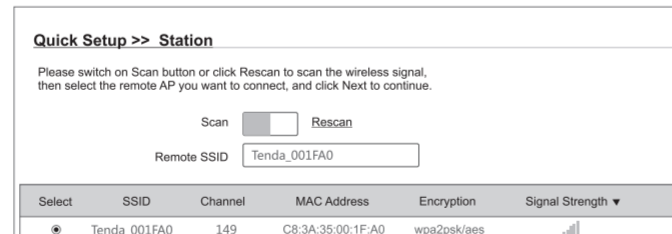

### 3. Enter the key (WiFi password) of the remote SSID if needed

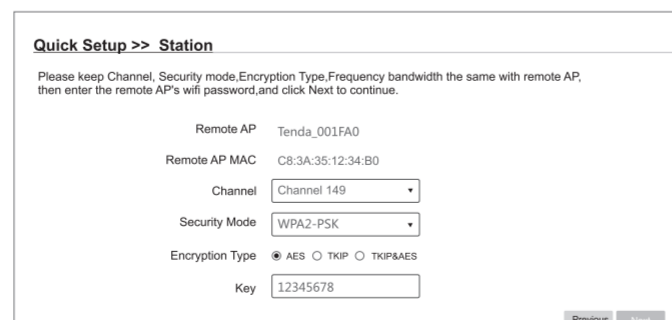

### 3. If the remote AP's IP address is 192.168.2.1, this AP's IP address should be 192.168.2.x (2-254).

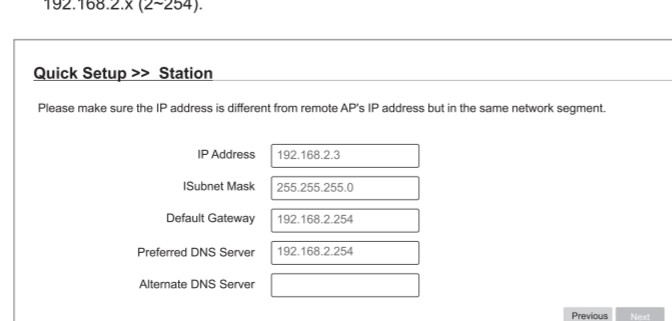

Then click **Save** on the appearing page to apply your settings. Wait until the device restarts automatically. When the **Signal Threshold LED** stays solid, it has been bridged successfully!

### WISP Mode

In this mode, the device connects to ISP hotspot wirelessly to share Internet with local wireless and wired devices.

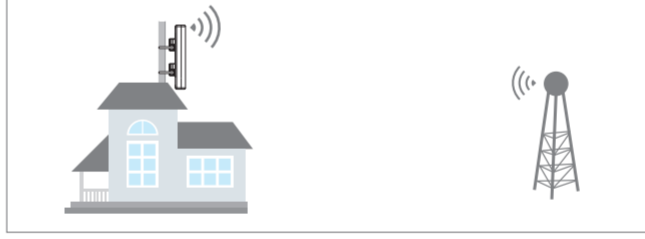

### 1. Select WISP mode

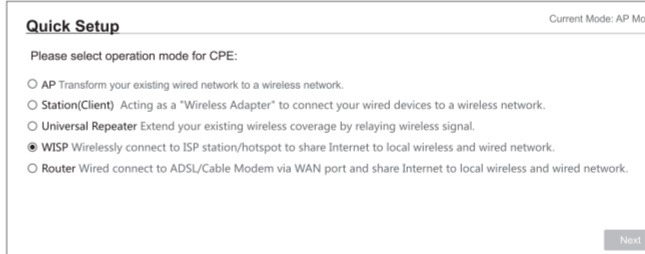

### 2. Select the SSID (WiFi name) of ISP hotspot

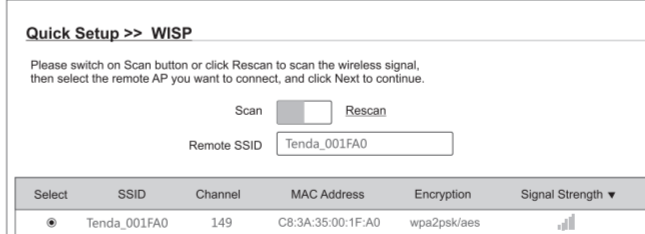

### 3. Enter the key (WiFi password) of the ISP hotspot if needed

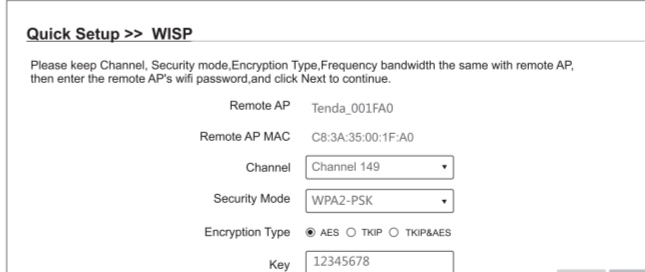

### 4. Select the WAN connection type and set corresponding parameters if needed

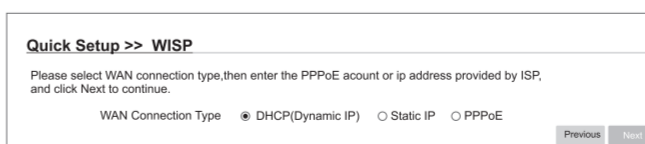

### 5. Customize your SSID for your local network

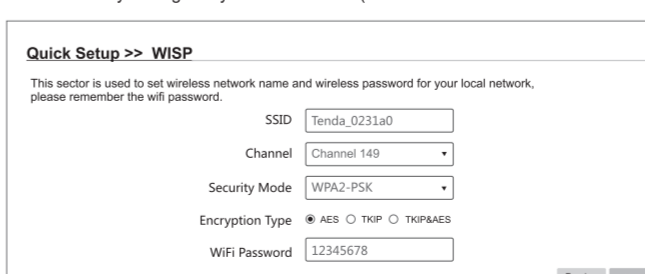

### 6. If the ISP hotspot's IP address is 192.168.2.x, this AP's IP can be 192.168.5.x.

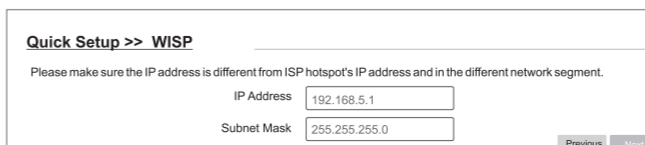

Then click **Save** on the appearing page to apply your settings. Wait until the device restarts automatically. When the **Signal Threshold LED** stays solid, it has been bridged successfully!

### Step 4: After finishing settings mentioned above, set your PC to Obtain an IP address automatically for Internet access.

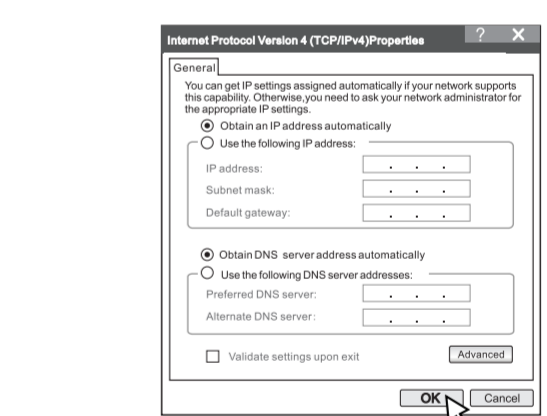

### FAQs

- Q1: How do I restore my device to its factory default settings?**  
**Method 1:** Via the Bridge/RST button  
With the device powered on, slide the bottom cover of the device down to expose the Bridge/RST button, press and hold it for over 15 seconds to restore the device to its factory defaults. Note that once your device is reset, all your current settings will be lost and you need to reconfigure your device.  
**Method 2:** Via the RESET button on power adapter  
With the device powered on, Press and hold the RESET button with a thin pin for at least 15 seconds to restore this device to its factory defaults.  
**Method 3:** Via the Web UI  
Log in to this device's web UI, click **Tools > Maintenance**, locate the **Reset to Factory Settings** section and click **Reset**.
- Q2: I enter the device's LAN IP address in the web browser but cannot access this device's web UI. What should I do?**  
**Method 1:** Verify that the IP address of computer should be a different one but on the same network segment as the LAN IP address of this device. The default LAN IP address of device is 192.168.2.1 and you need to set your PC to a static IP address within the following range: 192.168.2.x (2-253).  
**Method 2:** Clear the browser cookies or try another web browser.  
If you are still unable to login, please restore the device to factory default settings and follow this Install Guide to configure your settings again.

### Declaration of Conformity

Herby, SHENZHEN TENDA TECHNOLOGY CO., LTD., declares that the radio equipment type O6 is in compliance with Directive 2014/53/EU.  
The full text of the EU declaration of conformity is available at the following internet address:  
<http://www.tendacn.com/en/service/page/c.html>  
Operate Frequency: 5150-5250 MHz  
EIRP Power (Max.): 22.8 dBm  
Software Version: 1.0.0.5

### Safety & Emission Statement

**CE Mark Warning**  
CE Mark Warning  
This is a Class B product. In a domestic environment, this product may cause radio interference, in which case the user may be required to take adequate measures.  
Operations in the 5.15-5.25GHz band are restricted to indoor usage only.  
NOTE: (1) The manufacturer is not responsible for any radio or TV interference caused by unauthorized modifications to this equipment. (2) To avoid unnecessary radiation interference, it is recommended to use a shielded RJ45 cable.

### FCC Statement

This device complies with Part 15 of the FCC Rules. Operation is subject to the following two conditions: (1) This device may not cause harmful interference, and (2) this device must accept any interference received, including interference that may cause undesired operation.  
This equipment has been tested and found to comply with the limits for Class B digital device, pursuant to Part 15 of the FCC Rules. These limits are designed to provide reasonable protection against harmful interference in a residential installation. This equipment generates, uses and can radiate radio frequency energy and, if not installed and used in accordance with the instructions, may cause harmful interference to radio communications. However, there is no guarantee that interference will not occur in a particular installation. If this equipment does cause harmful interference to radio or television reception, which can be determined by turning the equipment off and on, the user is encouraged to try to correct the interference by one of the following measures:  
• Reorient or relocate the receiving antenna.  
• Increase the separation between the equipment and receiver.  
• Connect the equipment into an outlet on a circuit different from that to which the receiver is connected.  
• Consult the dealer or an experienced radio/TV technician for help.  
**FCC Caution:** Any changes or modifications not expressly approved by the party responsible for compliance could void the user's authority to operate this equipment.  
The manufacturer is not responsible for any radio or TV interference caused by unauthorized modifications to this equipment.  
Radiation Exposure Statement  
This equipment complies with FCC radiation exposure limits set forth for an uncontrolled environment. This equipment should be installed and operated with minimum distance 20cm between the radiator and your body.  
NOTE: (1) The manufacturer is not responsible for any radio or TV interference caused by unauthorized modifications to this equipment. (2) To avoid unnecessary radiation interference, it is recommended to use a shielded RJ45 cable.

Shenzhen Tenda Technology Co., Ltd.  
6-B Floor, Tower E3, No.1001, Zhongguanyuan Road,  
Nanhan District, Shenzhen, China, 518052  
Website: <http://www.tendacn.com>  
E-mail: [support@tendacn.com.cn](mailto:support@tenda.com.cn)  
YouTube: [TendaSZ1999](https://www.youtube.com/user/TendaSZ1999)  
Skype: [tendacn](https://www.skype.com/user/tendacn)  
Phone: Global hotline: (86 755)27657180  
© 2016 Shenzhen Tenda Technology Co., Ltd. All rights reserved.  
Tenda is a registered trademark legally held by Shenzhen Tenda Technology Co., Ltd.  
Other brands and product names mentioned herein are trademarks or registered trademarks of their respective holders. Specifications are subject to change without notice.