



## Quick Installation Guide

Outdoor CPE Kit  
O1-5G/OS3/O4

O1-5G is used for illustration here unless otherwise specified. The actual product prevails.



### RECYCLING

This product bears the selective sorting symbol for Waste electrical and electronic equipment (WEEE). This means that this product must be handled pursuant to European directive 2012/19/EU in order to be recycled or dismantled to minimize its impact on the environment. User has the choice to give his product to a competent recycling organization or to the retailer when he buys a new electrical or electronic equipment.

### Technical Support

Shenzhen Tenda Technology Co., Ltd.  
Floor 6-8, Tower E3, No.1001, Zhongshanyuan Road, Nanshan District, Shenzhen, China. 518052  
Website: www.tendacn.com  
E-mail: support@tenda.cn  
support\_uk@tenda.cn (United Kingdom)  
support\_us@tenda.cn (North America Support)

### Copyright

© 2023 Shenzhen Tenda Technology Co., Ltd. All rights reserved.  
Tenda is a registered trademark legally held by Shenzhen Tenda Technology Co., Ltd. Other brand and product names mentioned herein are trademarks or registered trademarks of their respective holders. Specifications are subject to change without notice.  
V1.0 Keep for future reference.



## Package contents

- CPE × 2
- Expansion bolt × 4 (height: 6.6 mm, inner diameter: 2.4 mm, length: 26.4 mm)
- Power adapter × 2
- Screw for fixing the PoE injector × 4 (thread diameter: 3 mm, length: 14 mm, head diameter: 5.2 mm)
- PoE injector × 2
- Quick installation guide
- Plastic strap (O1-5G: × 2; OS3: × 4)

## Get to know the PoE injector

The included PoE injector may vary with CPE models.

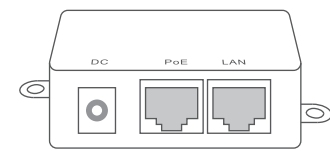

Port	Description
DC	Power jack
PoE	PoE power output port. Use an Ethernet cable to connect this port to the passive PoE port of the CPE.
LAN	LAN port. Used to connect network devices such as a computer, switch, or camera.

## Get to know your device

The CPE appearance varies with models. Please refer to the CPE you purchased.

### LED indicators

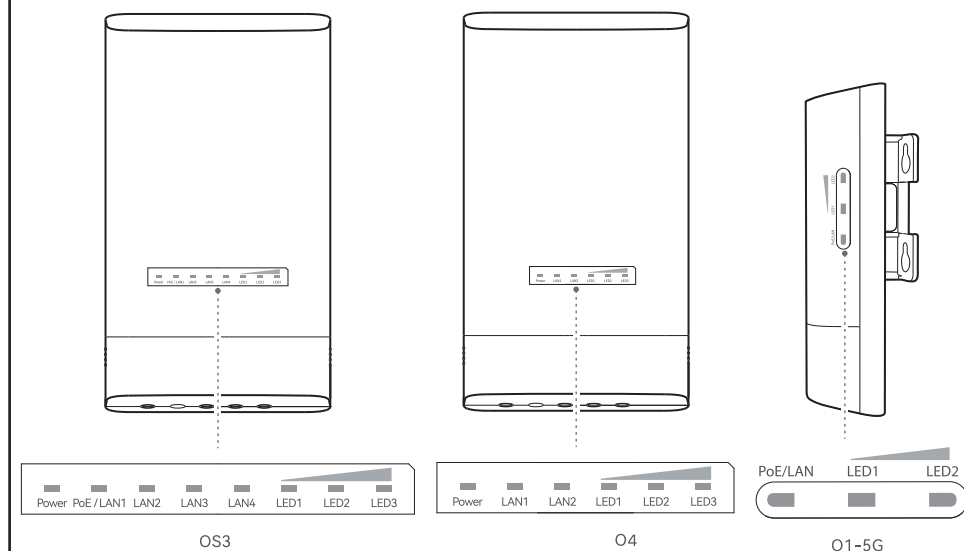

The following table lists all LED indicators that are used on the CPE. However, the LED indicators may vary with CPE models.

LED indicator	Status	Description
Power	Solid on	CPE powered on
	Off	CPE powered off
PoE/LAN	Solid on	The CPE is powered on. No data is transmitted.
	Blinking	The CPE is powered on. Data is being transmitted.
	Off	The CPE is powered off.
PoE/LAN1, LAN2, LAN3, LAN4	Solid on	The port is connected. No data is transmitted.
	Blinking	The port is connected. Data is being transmitted.
LED1, LED2, LED3 (Received signal strength indicator)	Solid on/Blinking	CPE bridged or connected to other devices - Solid on: CPE working in AP or Router mode - Blinking: CPE working in Client, Universal Responder or WISP mode The more indicators are on, the better the connection quality is. <b>Tip</b> - You can change the signal strength values for each indicator in the web UI of the CPE. - The quantity of LED indicators and available working modes vary with CPE models.
	Off	No device is connected to the CPE wirelessly, or the signal strength is weak. Adjust your CPE's direction or location.

### Ports, buttons and slots

O1-5G and OS3 are used for illustration in the following figures.

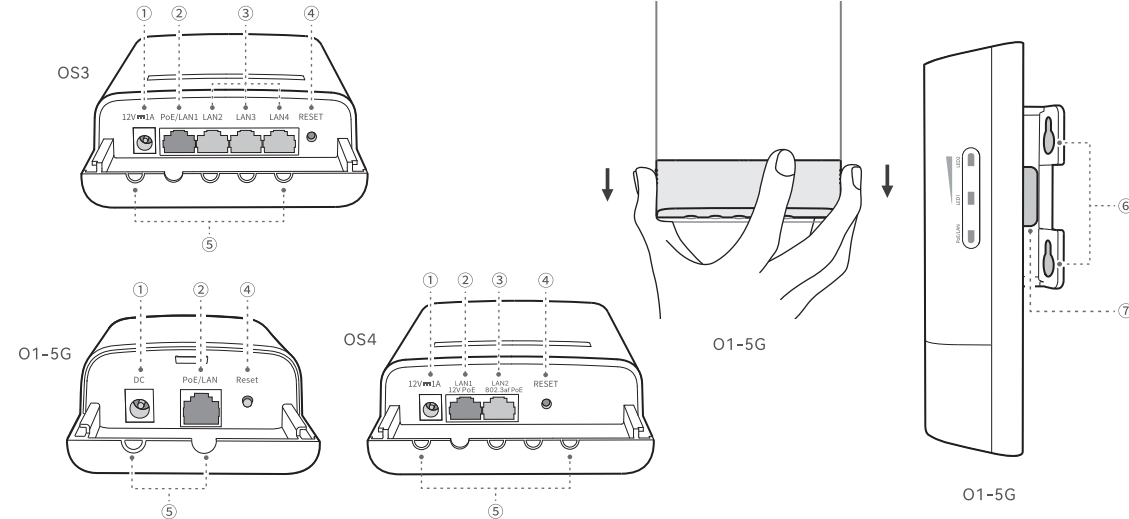

The following table lists all ports, buttons and slots that are used on the CPE. However, the ports, buttons and slots may vary with CPE models.

Port/Button/Slot	Description
① 12V 1A, DC	DC power jack. Connect the power adapter (if any) to this port for power supply.
② PoE/LAN, PoE/LAN1 LAN1 12V PoE, LAN2 802.3af PoE	Multiplexing port for power input and data transmission. - If passive PoE is used for power supply, connect this port to the PoE port of the PoE injector. - If you power on the CPE using a power adapter, this port can be connected to a computer, switch or IP camera. - If standard PoE is used for power supply, connect this port to the PoE port of the IEEE 802.3af/at PoE power supply device. You can check whether the CPE supports standard PoE powers supply on the package box or the CPE's <b>Tip</b> - If the CPE works in the Router mode (if supported), this port functions as a WAN port to connect to an upstream network device. - LAN1 12V PoE port only supports passive PoE. LAN2 802.3af PoE port only supports standard PoE.
③ LAN2, LAN3, LAN4	Ethernet port for connecting to a computer, switch or IP camera.
④ RESET, Reset	Reset button. Used to restore the CPE to factory settings. For details, see Q2 in FAQ.
⑤ Cable grommet	Used to fix the power cord or Ethernet cable.
⑥ Wall mounting slots	Used to fix the CPE to a wall. Recommended specifications for expansion belts and screws: - Expansion bolt: height: 6.6 mm, inner diameter: 2.4 mm, length: 26.4 mm - Screw: thread diameter: 3 mm, length: 14 mm, head diameter: 5.2 mm
⑦ Pole mounting slots	Used to fix the CPE to a pole using the included plastic straps.

## Power on the CPE

### Option 1: Use the PoE injector

Connect the PoE injector to the CPE as its label. In the following figures, the CPE is powered on by the PoE injector. See Q4 in FAQ for the maximum PoE power supply distance.

- Tip**  
CAT5 Ethernet cables or above are recommended for higher speed.

### Option 2: Use the power adapter

If the CPE has a DC power jack, use the included power adapter to power on the CPE.

- Tip**  
Use the included power adapter to avoid damage to the CPE.

## Connect the CPE

You can see the working mode of the CPE on its label. In the following figures, the CPE is powered on by the PoE injector.

### Connect the NVR side-CPE to the NVR

Connect the CPE labelled with NVR Side to the switch that connects to the NVR.

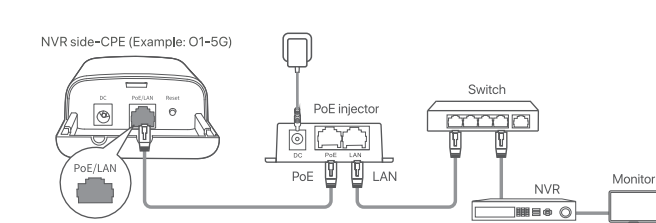

### Connect the Camera side-CPE to the IP camera

Connect the CPE labelled with Camera Side to the switch that connects to the IP camera.

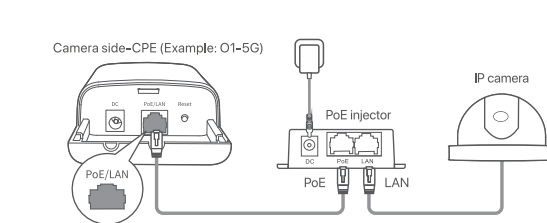

## Application scenarios

Install the CPE labelled with NVR Side at the NVR side and the CPE labelled with Camera Side at the camera side. The following demonstrates how pole mounting enables monitoring in different scenarios. When using this method, route the plastic straps through slots at the back of the CPEs, and properly position the CPEs on the poles before tightening the straps. After successful installation, the bridging quality reaches the best when the CPEs' received signal strength indicators (such as LED1, LED2 and LED3) are all solid on or blinking.

- Tip**  
The two CPEs are pre-configured and ready for installation.

### Construction tower crane

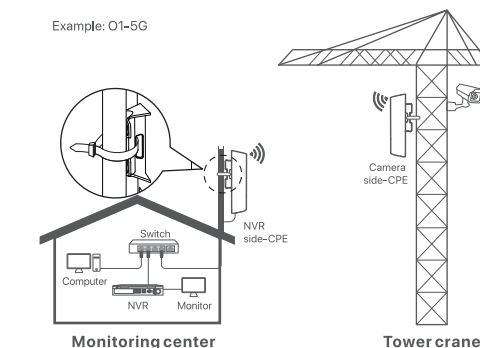

### Community, factory and farm

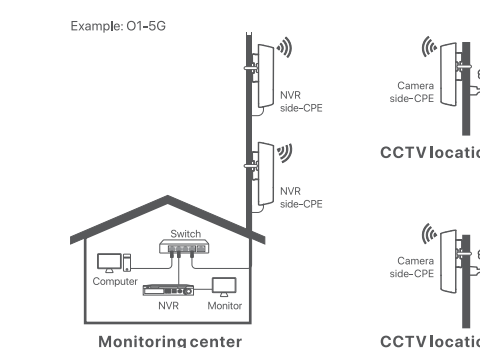

### Elevator

Scenario 1: The machine room located close to the top of the elevator shaft

Example: O1-5G

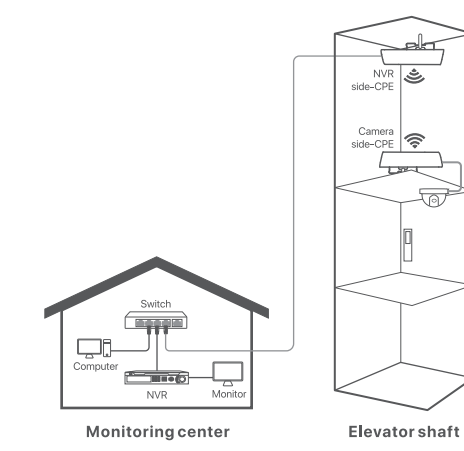

Scenario 2: The machine room located close to the bottom of the elevator shaft

Example: O1-5G

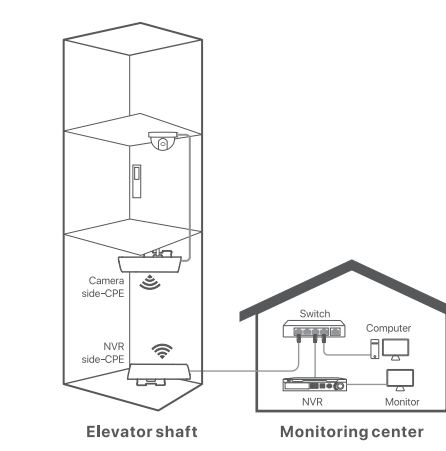

## Log into the CPE

The following procedure describes how to log into the web UI of the CPE on a computer.  
① Connect the computer to the LAN port of the CPE or the LAN port of the switch connected to the CPE.  
② Set the computer's IP address to the same network segment as the CPE's IP address. For example, if the CPE's IP address is 192.168.2.1, then the computer's IP address can be set to 192.168.2.X (X ranges from 2 to 254 and is unused), and the subnet mask is 255.255.255.0.  
③ Start a web browser on the computer connected to the CPE and enter the default IP address (192.168.2.1 in AP mode or 192.168.2.2 in Station mode) in the address bar. Enter the username and password and click Login.

- Tip**  
- You can also log into the web UI of the CPE using Wi-Fi. By default, the CPE Wi-Fi name is Tenda\_XXXXXX or Tenda\_XXXXXX\_MG (XXXXXX indicates the last six characters of the CPE MAC address). If you cannot find the Wi-Fi network, try restarting the CPE.  
- If the login failed, refer to Q1 in FAQ.  
- To ensure network security, change your username and password after first login.

## FAQ

### Q1: I cannot log in to the web UI of the CPE. What should I do?

A1: Try the following solutions:

- Ensure that the device is connected to the CPE.
- Ensure that the device like computer and CPE are in the same network segment. For example, the CPE's IP address is 192.168.2.1, then the computer's IP address can be set to 192.168.2.X (X ranges from 2 - 254 and is unused).
- Restore the CPE to factory settings by referring to Q2, and try again.

### Q2: How to reset the CPE?

A2: **Note: Resetting the CPE clears all settings, and you need to configure it again.**

**Method 1:** After the CPE completes startup, hold down the reset button (RESET or Reset) for about 8 seconds and release it when all LED indicators light up. The CPE is restored to factory settings.

**Method 2:** Log in to the web UI of the CPE, navigate to Tools > Maintenance, and click Reset.

### Q3: How to check that the CPE is under the best connection status?

A3: **Method 1:** Observe the LED indicators of the CPE. The connection quality reaches the best when all LED indicators of the CPE light solid on or blink.

**Method 2:** Log in to the web UI of the CPE, and check the bridging status in Status > Wireless Status. Stronger signal strength (-60 dBm better than -70 dBm), less background noise (-100 dBm better than -90 dBm), and faster transmit/receive speed lead to better bridging signal.

### Q4: What is the maximum distance for PoE power supply when a PoE injector is used for power supply?

A4: The following table is for your reference. You can check the power supply data on the CPE housing, power adapter or PoE injector.

Power supply mode	Input voltage	Maximum PoE power supply distance
9V/0.6A DC power supply/PoE power supply	9-13V	30m
12V 1A DC power supply/PoE power supply	9-13V	50m or 60m
24V 0.5A PoE power supply	18-25V	60m

### Q5: After the installation is finished, there is no display of the scenes monitored by IP cameras at the NVR side. What should I do?

A5: Try the following solutions:

- Ensure that all devices are working normally and connected properly.
- Ensure that the computer, NVR and IP camera are in the same network segment, and the NVR configuration and IP camera configuration are correct.
- If the IP camera can be scanned but cannot be added at the NVR side, ensure that the Transparent Bridge function is enabled and the IP camera is already in initialization (active) state.
- If the IP camera cannot be scanned at the NVR side, refer to the following procedure to solve the issue.

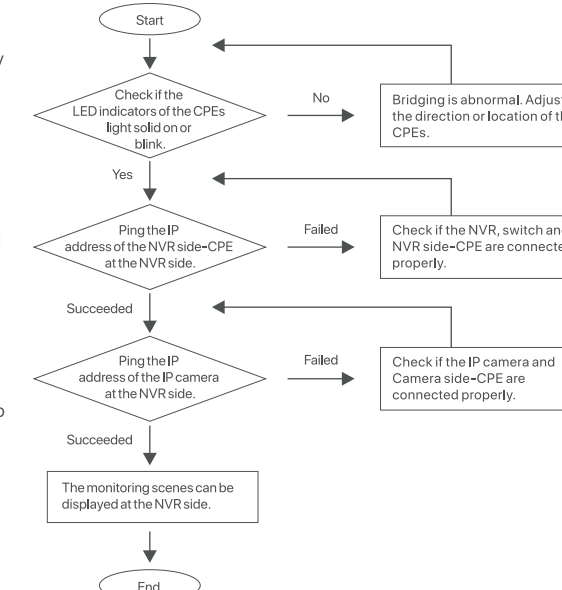

## Safety Precautions

Before operating, read the operation instructions and precautions to be taken, and follow them to prevent accidents. The warning and danger items in other documents do not cover all the safety precautions that must be followed. They are only supplementary information, and the installation and maintenance personnel need to understand the basic safety precautions to be taken.

- Do not use the device in a place where wireless devices are not allowed.
- CPE operating and storage environment. Operating temperature: -30°C - 55°C; Operating humidity: (10% - 90%) RH, non-condensing. Storage temperature: -30°C - 70°C, Storage humidity: (10% - 90%) RH, non-condensing.
- Power adapter operating and storage temperature. Operating temperature: 0°C - 40°C; Operating humidity: (5% - 95%) RH, non-condensing. Storage temperature: -20°C - 70°C, Storage humidity: (5% - 95%) RH, non-condensing.
- Please use the included power adapter.
- If you power on the CPE using a power adapter: the mains plug is used as the disconnect device and shall remain readily operable; the power socket shall be installed near the CPE and easily accessible.
- The CPE is used outdoors. The PoE injector and power adapter are used indoors.
- Keep the device away from fire, high electric field, high magnetic field, and inflammable and explosive items.
- While the device is designed to be waterproof, it is recommended to avoid long-duration water immersion to ensure its safety and longevity.
- Do not use the power adapter/PoE if its plug or cord is damaged.
- If such phenomena as smoke, abnormal sound or smell appear when you use the device, immediately stop using it and disconnect its power supply, unplug all connected cables, and contact the after-sales service personnel.
- Disassembling or modifying the device or its accessories without authorization voids the warranty, and might cause safety hazards.

For the latest safety precautions, see Safety and Regulatory Information on www.tendacn.com.



### CE Mark Warning

This is a Class A product.  
Warning: Operation of this equipment in a residential environment could cause radio interference. In which case the user may be required to take adequate measures. This equipment should be installed and operated with a minimum distance 20 cm between the device and your body.  
**NOTE:** (1) The manufacturer is not responsible for any radio or TV interference caused by unauthorized modifications to this equipment. (2) To avoid unnecessary radiation interference, it is recommended to use a shielded RJ45 cable.

### Declaration of Conformity

Hereby, SHENZHEN TENDA TECHNOLOGY CO., LTD. declares that the device is in compliance with Directive 2014/53/EU. The full text of the EU declaration of conformity is available at the following internet address: https://www.tendacn.com/download/eq-9.html  
Attention: In EU member states, EFTA countries, Northern Ireland and Great Britain, the operation in the frequency range 5470MHz - 5725MHz is permitted both indoors and outdoors.

AT	BE	BG	CH	CY	CZ	DE	DK	EE	EL	ES	FI	FR	HR	HU	IE	IS	IT	LI	LU	LV	LT	MT	NL	NO	PL	PT	RO	SE	SI	SK	UK(EN)	UK
----	----	----	----	----	----	----	----	----	----	----	----	----	----	----	----	----	----	----	----	----	----	----	----	----	----	----	----	----	----	----	--------	----

Operating Frequency/Max Output Power

2412MHz-2472MHz/20dBm (OS3V2.0)
5150MHz-5250MHz/23dBm (O1-5G/OS3/O4)
5470MHz-5725MHz/27dBm (O1-5G/OS3/O4)

### Radiation Exposure Statement

This device complies with FCC radiation exposure limits set forth for an uncontrolled environment and it also complies with Part 15 of the FCC RF Rules. This equipment should be installed and operated with minimum distance 20cm between the device and your body.

**Caution!**  
Any changes or modifications not expressly approved by the party responsible for compliance could void the user's authority to operate the equipment. This transmitter must not be co-located or operating in conjunction with any other antenna or transmitter.  
Operating frequency: OS3V2.0: 2412-2482 MHz; O1-5G/OS3/O4: 5150-5250 MHz; 5725-5850 MHz.  
**NOTE:** (1) The manufacturer is not responsible for any radio or TV interference caused by unauthorized modifications to this equipment. (2) To avoid unnecessary radiation interference, it is recommended to use a shielded RJ45 cable.