



# FCC PART 15.407

## TEST REPORT

For

### SHENZHEN TENDA TECHNOLOGY CO.,LTD.

Tenda Industrial Park, No. 34-1, Shilong Rd., Shiyan Town, Bao'an District, Shenzhen, P.R.China

**FCC ID: V7TN80**

<b>Report Type:</b> Original Report	<b>Product Type:</b> Wireless N900 Concurrent Dual-Band Gigabit Router
<b>Test Engineer:</b> Leon Chen	<i>leon chen</i>
<b>Report Number:</b> R2DG130314004-00B	
<b>Report Date:</b> 2013-03-29	
<b>Reviewed By:</b> Ivan Cao RF Leader	<i>Ivan Cao</i>
<b>Test Laboratory:</b> Bay Area Compliance Laboratories Corp. (Dongguan) No.69 Pulongcun, Puxinhu Industrial Zone, Tangxia, Dongguan, Guangdong, China Tel: +86-769-86858888 Fax: +86-769-86858891 <a href="http://www.baclcorp.com.cn">www.baclcorp.com.cn</a>	

**Note:** This test report is prepared for the customer shown above and for the device described herein. It may not be duplicated or used in part without prior written consent from Bay Area Compliance Laboratories Corp. This report **must not** be used by the customer to claim product certification, approval, or endorsement by NVLAP\*, or any agency of the Federal Government.

\* This report may contain data that are not covered by the NVLAP accreditation and shall be marked with an asterisk "★" (Rev.2)

## TABLE OF CONTENTS

<b>GENERAL INFORMATION.....</b>	<b>4</b>
PRODUCT DESCRIPTION FOR EQUIPMENT UNDER TEST (EUT) .....	4
OBJECTIVE .....	4
RELATED SUBMITTAL(S)/GRANT(S).....	4
TEST METHODOLOGY .....	4
TEST FACILITY .....	5
<b>SYSTEM TEST CONFIGURATION.....</b>	<b>6</b>
DESCRIPTION OF TEST CONFIGURATION .....	6
EUT EXERCISE SOFTWARE .....	6
EQUIPMENT MODIFICATIONS .....	6
SUPPORT EQUIPMENT LIST AND DETAILS .....	7
EXTERNAL CABLE.....	7
BLOCK DIAGRAM OF TEST SETUP .....	7
<b>SUMMARY OF TEST RESULTS .....</b>	<b>8</b>
<b>FCC §15.247 (i) &amp; §1.1307 (b) (1) &amp; §2.1091- MAXIMUM PERMISSIBLE EXPOSURE (MPE).....</b>	<b>9</b>
APPLICABLE STANDARD .....	9
<b>FCC §15.203 – ANTENNA REQUIREMENT .....</b>	<b>10</b>
APPLICABLE STANDARD .....	10
ANTENNA CONNECTOR CONSTRUCTION .....	10
<b>FCC §15.407 (b) (6) §15.207 (a) – CONDUCTED EMISSIONS .....</b>	<b>11</b>
APPLICABLE STANDARD .....	11
MEASUREMENT UNCERTAINTY.....	11
EUT SETUP .....	12
EMI TEST RECEIVER SETUP.....	12
CORRECTED AMPLITUDE & MARGIN CALCULATION .....	12
TEST EQUIPMENT LIST AND DETAILS.....	13
TEST PROCEDURE .....	13
TEST RESULTS SUMMARY .....	13
TEST DATA .....	13
<b>FCC §15.209, §15.205 &amp; §15.407(b) (1) (6) (7) – UNDESIRABLE EMISSION &amp; RESTRICTED BANDS .....</b>	<b>16</b>
APPLICABLE STANDARD .....	16
MEASUREMENT UNCERTAINTY.....	16
EUT SETUP .....	17
EMI TEST RECEIVER & SPECTRUM ANALYZER SETUP .....	17
TEST PROCEDURE .....	18
CORRECTED AMPLITUDE & MARGIN CALCULATION .....	18
TEST EQUIPMENT LIST AND DETAILS.....	18
TEST RESULTS SUMMARY .....	19
TEST DATA .....	19
CONDUCTED SPURIOUS EMISSION AT ANTENNA PORT.....	23
TEST DATA .....	24
<b>FCC §15.407(b) (1) (2) (3) (4) – OUT OF BAND EMISSIONS .....</b>	<b>52</b>
APPLICABLE STANDARD .....	52
TEST PROCEDURE .....	52
TEST EQUIPMENT LIST AND DETAILS.....	52
TEST DATA .....	53

**FCC §15.407(a) (1) – 26 dB OCCUPIED BANDWIDTH .....61**  
    APPLICABLE STANDARD .....61  
    TEST EQUIPMENT LIST AND DETAILS.....61  
    TEST PROCEDURE .....61  
    TEST DATA .....62

**FCC §15.407(a) (1) – CONDUCTED TRANSMITTER OUTPUT POWER.....72**  
    APPLICABLE STANDARD .....72  
    TEST EQUIPMENT LIST AND DETAILS.....72  
    TEST PROCEDURE .....72  
    TEST DATA .....73

**FCC §15.407(a) (1) (5) - POWER SPECTRAL DENSITY .....84**  
    APPLICABLE STANDARD .....84  
    TEST PROCEDURE .....84  
    TEST EQUIPMENT LIST AND DETAILS.....84  
    TEST DATA .....85

**FCC §15.407(a) (6) – PEAK EXCURSION RATIO .....96**  
    APPLICABLE STANDARD .....96  
    TEST PROCEDURE .....96  
    TEST EQUIPMENT LIST AND DETAILS.....96  
    TEST DATA .....96

## GENERAL INFORMATION

---

### Product Description for Equipment under Test (EUT)

The *SHENZHEN TENDA TECHNOLOGY CO.,LTD.*'s product, model number: *N80 (FCC ID: V7TN80)* or ("EUT") in this report is *Wireless N900 Concurrent Dual-Band Gigabit Router*, which was measured approximately: 21.6 cm (L) x 15.6 cm (W) x 3.9 cm (H), rated input voltage: DC 12V from adapter.

Adapter information: Honor  
Model: ADS-40FSG-12 12030GPCU  
Input: AC 100-240V, 50/60Hz, Max.1.0A  
Output: DC 12V, 2.5A

*\* All measurement and test data in this report was gathered from production sample serial number: 130314004 (Assigned by BACL, Dongguan). The EUT was received on 2013-03-15.*

### Objective

This type approval report is prepared on behalf of *SHENZHEN TENDA TECHNOLOGY CO.,LTD.* in accordance with Part 2-Subpart J, Part 15-Subparts A, B and E of the Federal Communication Commissions rules.

The tests were performed in order to determine compliance with FCC Part 15, Subpart E, section 15.203, 15.205, 15.207, 15.209 and 15.407 rules.

### Related Submittal(s)/Grant(s)

FCC Part 15C DTS submissions with FCC ID: *V7TN80*.  
FCC Part 15B JBP submissions with FCC ID: *V7TN80*.

### Test Methodology

All measurements contained in this report were conducted with ANSI C63.4-2003, American National Standard for Methods of Measurement of Radio-Noise Emissions from Low-Voltage Electrical and Electronic Equipment in the range of 9 kHz to 40 GHz.

All emissions measurement was performed and Bay Area Compliance Laboratories Corp. (Dongguan).

## Test Facility

The Test site used by Bay Area Compliance Laboratories Corp. (Dongguan) to collect test data is located on the No.69 Pulongcun, Puxinhu Industrial Zone, Tangxia, Dongguan, Guangdong, China

Test site at Bay Area Compliance Laboratories Corp. (Dongguan) has been fully described in reports submitted to the Federal Communication Commission (FCC). The details of these reports have been found to be in compliance with the requirements of Section 2.948 of the FCC Rules on February 02, 2012. The facility also complies with the radiated and AC line conducted test site criteria set forth in ANSI C63.4-2003.

The Federal Communications Commission has the reports on file and is listed under FCC Registration No.: 273710. The test site has been approved by the FCC for public use and is listed in the FCC Public Access Link (PAL) database.

Additionally, Bay Area Compliance Laboratories Corp. (Dongguan) is an ISO/IEC 17025 accredited laboratory, and is accredited by National Voluntary Laboratory Accredited Program (Lab Code 500069-0).



The current scope of accreditations can be found at <http://ts.nist.gov/standards/scopes/5000690.htm>

## SYSTEM TEST CONFIGURATION

---

### Description of Test Configuration

The EUT was configured for testing in an engineering mode which was provided by the manufacturer.

For 5180~5240MHz band, 7 channels are provided to testing:

Channel	Frequency (MHz)	Channel	Frequency (MHz)
36	5180	44	5220
38	5190	46	5230
40	5200	48	5240
42	5210	/	/

For 802.11a and 802.11n ht20 Channel 36, 40, 44 and 48 was used, we choosed the channel 36,40,48 for testing, for 802.11n ht40, Channel 38, 46 was tested.

The worst-case data rates are determined to be as follows for each mode based upon investigations by measuring the average power and PSD across all data rates bandwidths, and modulations.

For 802.11a,the EUT can transmitting with chain 0 ,chain 1 or chain 2, therefore investigated worst case to representative chain 0 in test report.

### EUT Exercise Software

The software 'Broadcom MTool 2.0.0.3' was used for testing, which was provided by manufacturer.

### Equipment Modifications

No modification was made to the EUT tested.

**Support Equipment List and Details**

Manufacturer	Description	Model	Serial Number
HP	Printer	C3941A	JPTVOB2337
SAST	Modem	AEM-2100	0293
DELL	Keyboard	L100	CNORH656658907BL05DC
DELL	Laptop	PP11L	N/A
Kinston	Flash Disk	4G	/
DELL	PC	GX620	/

**External Cable**

Cable Description	Length (m)	From Port	To
Shielded Detachable Printer Cable	1.2	Parallel Port of Laptop	Printer
Shielded Detachable Serial Cable	1.2	Serial Port of Laptop	Modem
Shielded Detachable Keyboard Cable	1.5	Keyboard Port of Laptop	Keyboard
RJ 45 Cable	1.0	Laptop	EUT
RJ45 Cable*4	10	EUT	PC

**Block Diagram of Test Setup**

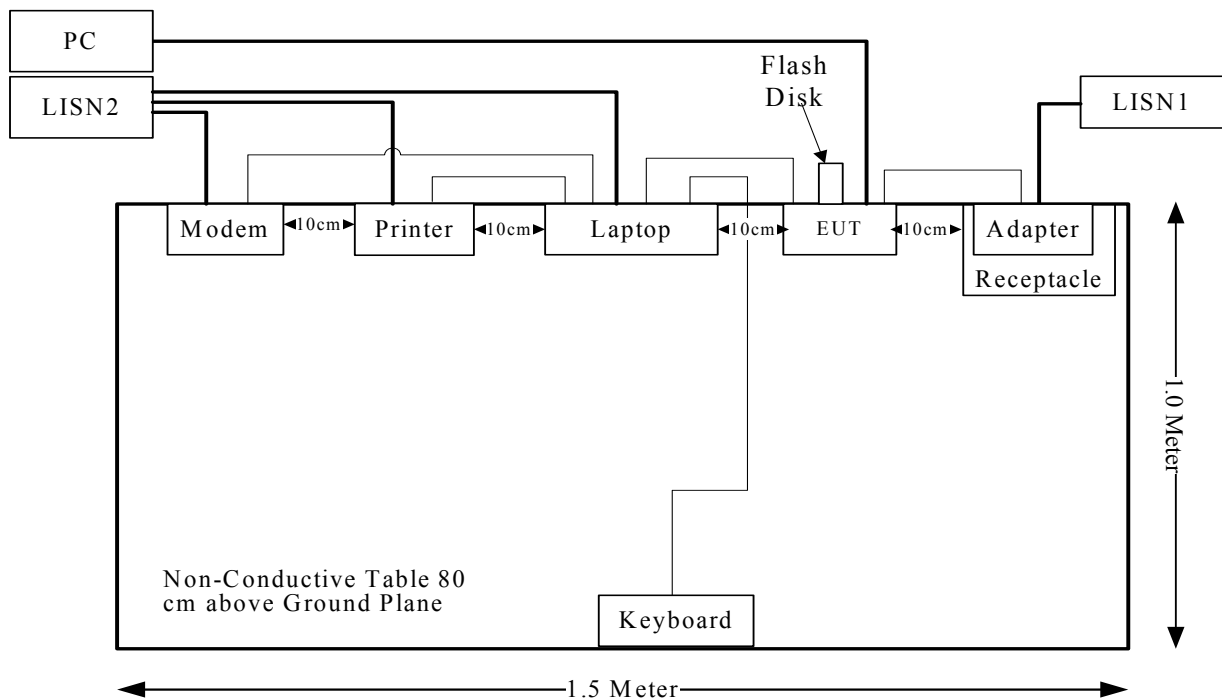

**SUMMARY OF TEST RESULTS**

<b>FCC Rules</b>	<b>Description of Test</b>	<b>Result</b>
FCC §15.247 (i) & §1.1307 (b) (1) & §2.1091	Maximum Permissible Exposure	Compliance
§15.203	Antenna Requirement	Compliance
§15.407(b)(6)& §15.207(a)	Conducted Emissions	Compliance
§15.205& §15.209 &§15.407(b) (1),(6),(7)	Undesirable Emission& Restricted Bands	Compliance
§15.407(b) (1),(2),(3),(4)	Out Of Band Emissions	Compliance
§15.407(a) (1)	26 dB Bandwidth	Compliance
§15.407(a)(1),	Conducted Transmitter Output Power	Compliance
§15.407 (a)(1),(5)	Power Spectral Density	Compliance
§15.407(a)(6)	Peak Excursion Ratio	Compliance



**FCC §15.247 (i) & §1.1307 (b) (1) & §2.1091- MAXIMUM PERMISSIBLE EXPOSURE (MPE)**

**Applicable Standard**

According to subpart 15.247(i) and subpart §1.1307(b)(1), systems operating under the provisions of this section shall be operated in a manner that ensures that the public is not exposed to radio frequency energy level in excess of the Commission’s guidelines.

Limits for Maximum Permissible Exposure (MPE) (§1.1310, §2.1091)

<b>(B) Limits for General Population/Uncontrolled Exposure</b>				
Frequency Range (MHz)	Electric Field Strength (V/m)	Magnetic Field Strength (A/m)	Power Density (mW/cm <sup>2</sup> )	Averaging Time (minutes)
0.3–1.34	614	1.63	*(100)	30
1.34–30	824/f	2.19/f	*(180/f <sup>2</sup> )	30
30–300	27.5	0.073	0.2	30
300–1500	/	/	f/1500	30
1500–100,000	/	/	1.0	30

f = frequency in MHz; \* = Plane-wave equivalent power density;

According to §1.1310 and §2.1091 RF exposure is calculated.

**Calculated Formulary:**

Predication of MPE limit at a given distance

$S = PG/4\pi R^2$  = power density (in appropriate units, e.g. mW/cm<sup>2</sup>);

P = power input to the antenna (in appropriate units, e.g., mW);

G = power gain of the antenna in the direction of interest relative to an isotropic radiator, the power gain factor, is normally numeric gain;

R = distance to the center of radiation of the antenna (appropriate units, e.g., cm);

**Calculated Data:**

Mode	Frequency (MHz)	Antenna Gain		Conducted Power		Evaluation Distance (cm)	Power Density (mW/cm <sup>2</sup> )	MPE Limit (mW/cm <sup>2</sup> )
		(dBi)	(numeric)	(dBm)	(mW)			
802.11a	5200	5	3.16	14.17	26.12	20.00	0.01644	1.0
802.11n ht20	5180	5	3.16	12.89	19.45	20.00	0.01224	1.0
802.11n ht40	5190	5	3.16	12.26	16.83	20.00	0.01059	1.0

**Result:** The device meet FCC MPE at 20 cm distance

## **FCC §15.203 – ANTENNA REQUIREMENT**

---

### **Applicable Standard**

According to § 15.203, An intentional radiator shall be designed to ensure that no antenna other than that furnished by the responsible party shall be used with the device. The use of a permanently attached antenna or of an antenna that uses a unique coupling to the intentional radiator shall be considered sufficient to comply with the provisions of this section. The manufacturer may design the unit so that a broken antenna can be replaced by the user, but the use of a standard antenna jack or electrical connector is prohibited.

And according to FCC 47 CFR section 15.407 (a)(1),if transmitting antennas of directional gain greater than 6 dBi are used, both the maximum conducted output power and the peak power spectral density shall be reduced by the amount in dB that the directional gain of the antenna exceeds 6 dBi.

### **Antenna Connector Construction**

The EUT has 3 dipole antennas, which were using a unique connector to attach the EUT, and the maximum gain is 5.0dBi, please refer to the internal photos.

**Result:** Compliance.

## **FCC §15.407 (b) (6) §15.207 (a) – CONDUCTED EMISSIONS**

### **Applicable Standard**

FCC §15.207, §15.407(b) (6)

### **Measurement Uncertainty**

Compliance or non-compliance with a disturbance limit shall be determined in the following manner:

If  $U_{lab}$  is less than or equal to  $U_{cispr}$  of Table 1, then:

- compliance is deemed to occur if no measured disturbance level exceeds the disturbance limit;
- non-compliance is deemed to occur if any measured disturbance level exceeds the disturbance limit.

If  $U_{lab}$  is greater than  $U_{cispr}$  of Table 1, then:

- compliance is deemed to occur if no measured disturbance level, increased by  $(U_{lab} - U_{cispr})$ , exceeds the disturbance limit;
- non-compliance is deemed to occur if any measured disturbance level, increased by  $(U_{lab} - U_{cispr})$ , exceeds the disturbance limit.

Based on CISPR 16-4-2: 2011, measurement uncertainty of conducted disturbance at mains port using AMN at Bay Area Compliance Laboratories Corp. (Dongguan) is 3.46 dB (150 kHz to 30 MHz).

Table 1 – Values of  $U_{cispr}$

Measurement	$U_{cispr}$
Conducted disturbance at mains port using AMN (150 kHz to 30 MHz)	3.4 dB

**EUT Setup**

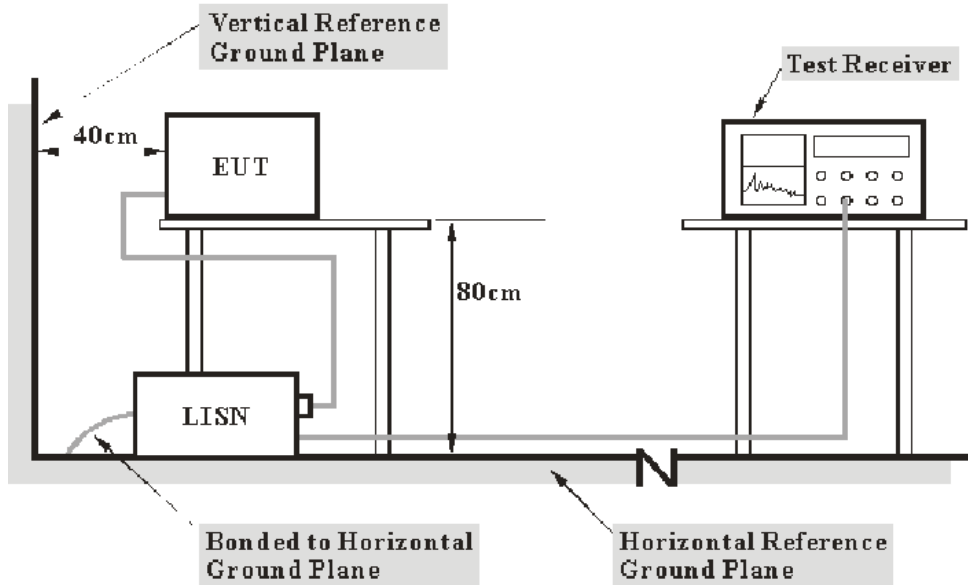

- Note: 1. Support units were connected to second LISN.  
 2. Both of LISNs (AMN) 80 cm from EUT and at the least 80 cm from other units and other metal planes support units.

The setup of EUT is according with per ANSI C63.4-2003 measurement procedure. The specification used was with the FCC Part 15.207 limits.

The spacing between the peripherals was 10 cm.

The adapter was connected to a 120VAC/60 Hz power source.

**EMI Test Receiver Setup**

The EMI test receiver was set to investigate the spectrum from 150 kHz to 30 MHz.

During the conducted emission test, the EMI test receiver was set with the following configurations:

<i>Frequency Range</i>	<i>IF B/W</i>
150 kHz – 30 MHz	9 kHz

**Corrected Amplitude & Margin Calculation**

The basic equation is as follows:

$$V_C = V_R + A_C + VDF$$

$$C_f = A_C + VDF$$

Herein,

$V_C$  (cord. Reading): corrected voltage amplitude

$V_R$ : reading voltage amplitude

$A_C$ : attenuation caused by cable loss

VDF: voltage division factor of AMN

C<sub>f</sub>: Correction Factor

The “**Margin**” column of the following data tables indicates the degree of compliance within the applicable limit. For example, a margin of 7dB means the emission is 7dB below the maximum limit. The equation for margin calculation is as follows:

$$\text{Margin} = \text{Limit} - \text{Corrected Amplitude}$$

### Test Equipment List and Details

Manufacturer	Description	Model	Serial Number	Calibration Date	Calibration Due Date
R&S	EMI Test Receiver	ESCS 30	830245/006	2012-11-29	2013-11-28
R&S	LISN1	ESH3-Z5	843331/015	2012-09-17	2013-09-16
R&S	LISN2	ESH3-Z5	100113	2012-11-29	2013-11-28
BACL	Test Software	BACL-EMC	V1.0-2010	N/A	N/A

\* Statement of Traceability: Bay Area Compliance Laboratories Corp. (Dongguan) attests that all calibrations have been performed in accordance to NVLAP requirements, traceable to National Primary Standards and International System of Units (SI).

### Test Procedure

During the conducted emission test, the adapter was connected to the LISN and the other support equipments were connected to the outlet of the second LISN.

Maximizing procedure was performed on the six (6) highest emissions of the EUT.

All data was recorded in the Quasi-peak and average detection mode.

### Test Results Summary

According to the recorded data in following table, the EUT complied with the FCC Part 15.207, with the worst margin reading of:

**15.52 dB at 0.170 MHz in the Neutral conducted mode**

### Test Data

#### Environmental Conditions

<b>Temperature:</b>	26.1 ° C
<b>Relative Humidity:</b>	61 %
<b>ATM Pressure:</b>	100.4 kPa

*The testing was performed by Leon Chen on 2013-03-28.*

*Test Mode: Transmitting*

120 V, 60 Hz, Line:

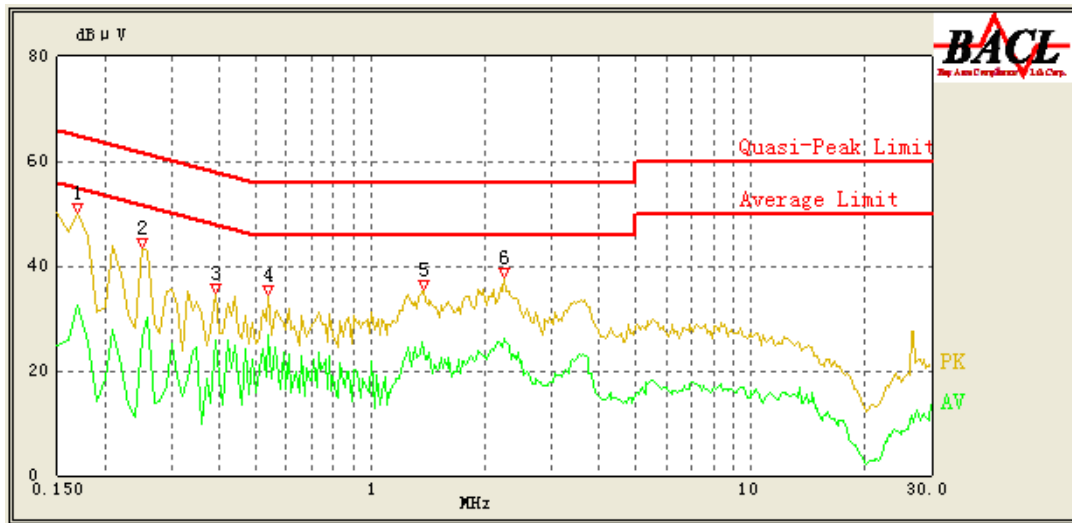

Frequency (MHz)	Cord. Reading (dBμV)	Correction Factor (dB)	Limit (dBμV)	Margin (dB)	Detector (PK/AV/QP)
0.170	49.24	1.03	65.43	16.19	QP
0.170	32.35	1.03	55.43	23.08	AV
0.250	39.82	0.89	63.14	23.32	QP
0.250	26.16	0.89	53.14	26.98	AV
0.390	30.02	0.68	59.14	29.12	QP
0.390	25.93	0.68	49.14	23.21	AV
0.540	31.13	0.51	56.00	24.87	QP
0.540	26.95	0.51	46.00	19.05	AV
1.380	29.72	0.33	56.00	26.28	QP
1.380	24.09	0.33	46.00	21.91	AV
2.250	31.76	0.37	56.00	24.24	QP
2.250	26.03	0.37	46.00	19.97	AV

**120V, 60 Hz, Neutral:**



Frequency (MHz)	Cord. Reading (dBμV)	Correction Factor (dB)	Limit (dBμV)	Margin (dB)	Detector (PK/AV/QP)
0.170	49.91	1.74	65.43	15.52	QP
0.170	34.65	1.74	55.43	20.78	AV
0.250	41.01	1.33	63.14	22.13	QP
0.250	26.54	1.33	53.14	26.60	AV
0.300	41.94	1.07	61.71	19.77	QP
0.300	32.31	1.07	51.71	19.40	AV
0.610	34.44	0.48	56.00	21.56	QP
0.610	29.07	0.48	46.00	16.93	AV
1.310	32.81	0.24	56.00	23.19	QP
1.310	27.45	0.24	46.00	18.55	AV
2.180	29.78	0.28	56.00	26.22	QP
2.200	24.91	0.28	46.00	21.09	AV

## FCC §15.209, §15.205 & §15.407(b) (1) (6) (7) – UNDESIRABLE EMISSION & RESTRICTED BANDS

### Applicable Standard

FCC §15.407 (b) (1), (6), (7); §15.209; §15.205;

For transmitters operating in the 5.15–5.25 GHz band: all emissions outside of the 5.15–5.35 GHz band shall not exceed an EIRP of –27 dBm/MHz.

Unwanted emissions below 1 GHz must comply with the general field strength limits set forth in §15.209.

According to KDB 789033 D01 General UNII Test Procedures v01, emission shall be computed as:  
 $E[\text{dB}\mu\text{V}/\text{m}] = \text{EIRP}[\text{dBm}] + 95.2$ , for  $d = 3$  meters.

The limits of fundamental above 5GHz shall be extrapolated to the specified distance using an extrapolation factor of 20dB/decade from 3m to 1.5m  
 Distance extrapolation factor =  $20 \log(3\text{m}/1.5)$  dB  
 Limit line = specific limits (dB $\mu\text{V}/\text{m}$ ) + 6dB

### Measurement Uncertainty

Compliance or non-compliance with a disturbance limit shall be determined in the following manner:

If  $U_{\text{lab}}$  is less than or equal to  $U_{\text{cispr}}$  of Table 1, then:

- compliance is deemed to occur if no measured disturbance level exceeds the disturbance limit;
- non-compliance is deemed to occur if any measured disturbance level exceeds the disturbance limit.

If  $U_{\text{lab}}$  is greater than  $U_{\text{cispr}}$  of Table 1, then:

- compliance is deemed to occur if no measured disturbance level, increased by  $(U_{\text{lab}} - U_{\text{cispr}})$ , exceeds the disturbance limit;
- non-compliance is deemed to occur if any measured disturbance level, increased by  $(U_{\text{lab}} - U_{\text{cispr}})$ , exceeds the disturbance limit.

Based on CISPR 16-4-2: 2011, measurement uncertainty of radiated emission at a distance of 3m at Bay Area Compliance Laboratories Corp. (Dongguan) is:

30M~200MHz: 5.0 dB  
 200M~1GHz: 6.2 dB  
 1G~6GHz: 4.45 dB  
 6G~18GHz: 5.23 dB

Table 1 – Values of  $U_{\text{cispr}}$

Measurement	$U_{\text{cispr}}$
Radiated disturbance (electric field strength at an OATS or in a SAC) (30 MHz to 1000 MHz)	6.3 dB
Radiated disturbance (electric field strength in a FAR) (1 GHz to 6 GHz)	5.2 dB
Radiated disturbance (electric field strength in a FAR) (6 GHz to 18 GHz)	5.5 dB



**EUT Setup**

**Below 1 G:**

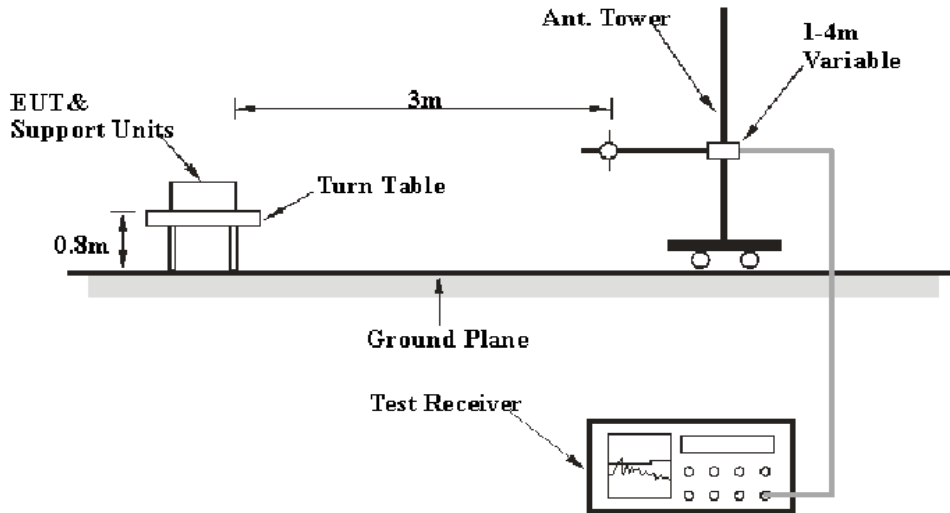

**Above 1 G:**

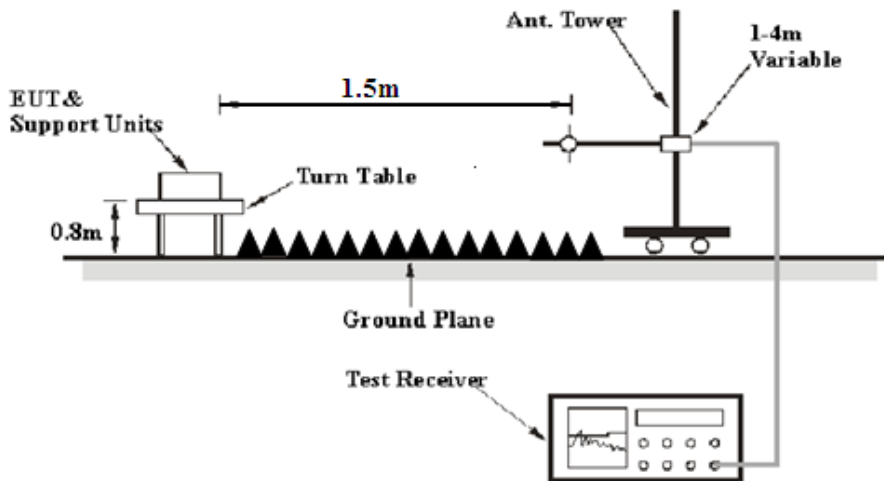

The radiated emission tests were performed in the 3 meters, using the setup accordance with the ANSI C63.4-2003. The specification used was the FCC 15.209, and FCC 15.407 limits.

The external I/O cables were draped along the test table and formed a bundle 30 to 40 cm long in the middle.

The spacing between the peripherals was 10 cm.

The adapter was connected to a 120 VAC/60 Hz power source,

**EMI Test Receiver & Spectrum Analyzer Setup**

The system was investigated from 30 MHz to 40 GHz.

During the radiated emission test, the EMI test receiver & Spectrum Analyzer Setup were set with the following configurations:

<i>Frequency Range</i>	<i>RBW</i>	<i>Video B/W</i>	<i>Detector</i>
30 MHz – 1000 MHz	100 kHz	300 kHz	QP
1000 MHz – 40 GHz	1 MHz	3 MHz	PK
1000 MHz – 40 GHz	1 MHz	10 Hz	Ave.

### Test Procedure

During the radiated emission test, the adapter was connected to the first AC floor outlet and the other support equipments were connected to the second AC floor outlet.

Maximizing procedure was performed on the highest emissions to ensure that the EUT complied with all installation combinations.

Data was recorded in Quasi-peak detection mode for frequency range of 30 MHz-1GHz, peak and Average detection modes for frequencies above 1GHz.

### Corrected Amplitude & Margin Calculation

The Corrected Amplitude is calculated by adding the Antenna Loss and Cable Loss, and subtracting the Amplifier Gain from the Meter Reading. The basic equation is as follows:

$$\text{Corrected Amplitude} = \text{Meter Reading} + \text{Antenna Loss} + \text{Cable Loss} - \text{Amplifier Gain}$$

The “**Margin**” column of the following data tables indicates the degree of compliance with the applicable limit. For example, a margin of 7dB means the emission is 7dB below the limit. The equation for margin calculation is as follows:

$$\text{Margin} = \text{Limit} - \text{Corrected Amplitude}$$

### Test Equipment List and Details

Manufacturer	Description	Model	Serial Number	Calibration Date	Calibration Due Date
R&S	EMI TEST RECIEVER	ESCI	100224	2012-5-14	2013-5-13
Sunol Sciences	Antenna	JB3	A060611-1	2012-9-6	2013-9-5
HP	HP AMPLIFIER	8447E	2434A02181	N/A	N/A
R&S	Spectrum analyzer	FSEM 30	849016/001	2012-9-4	2013-9-3
ETS LINDGREN	horn antenna	3115	000 527 35	2012-9-6	2013-9-5
Mini-Circuit	Amplifier	ZVA-213-S+	054201245	N/A	N/A
Rohde & Schwarz	Spectrum Analyzer	FSP38	100478	2012-5-14	2013-5-13

\* Statement of Traceability: Bay Area Compliance Laboratories Corp. (Dongguan) attests that all calibrations have been performed in accordance to NVLAP requirements, traceable to National Primary Standards and International System of Units (SI).

## Test Results Summary

According to the recorded data in following table, the EUT complied with the FCC Title 47, Part 15, Subpart C, Section 15.205, 15.209 and 15.407, with the worst margin reading of:

**1.64 dB at 875.84 MHz in the Vertical polarization for 802.11a Mode**

## Test Data

### Environmental Conditions

<b>Temperature:</b>	24.4° C
<b>Relative Humidity:</b>	70 %
<b>ATM Pressure:</b>	100.7 kPa

*The testing was performed by Leon Chen on 2013-03-29*

*Mode: Transmitting*

802.11a Mode:

Frequency (MHz)	Receiver		Rx Antenna		Cable loss (dB)	Amplifier Gain (dB)	Corrected Amplitude (dBµV/m)	FCC 15.407	
	Reading (dBµV)	Detector (PK/QP/AV)	Polar (H/V)	Factor (dB)				Limit (dBµV/m)	Margin (dB)
Low Channel: 5180MHz									
5180	56.79	PK	H	31.46	5.49	0	93.74	N/A	N/A
5180	43.80	AV	H	31.46	5.49	0	80.75	N/A	N/A
5180	61.48	PK	V	31.46	5.49	0	98.43	N/A	N/A
5180	47.29	AV	V	31.46	5.49	0	84.24	N/A	N/A
5150	22.65	PK	V	31.4	5.45	0	59.50	74	14.50
5150	8.92	AV	V	31.4	5.45	0	45.77	54	8.23
10360	27.08	PK	V	36.97	8.34	25.85	46.54	68.2	21.66
15540	27.69	PK	V	37.43	11.42	24.1	52.44	74	21.56
15540	13.53	AV	V	37.43	11.42	24.1	38.28	54	15.72
7500	32.44	PK	V	34.8	7.06	26.37	47.93	74	26.07
7500	30.19	AV	V	34.8	7.06	26.37	45.68	54	8.32
875.84	40.5	QP	V	22.48	3.6	22.22	44.36	46	1.64
625.58	41.36	QP	V	19.9	3.06	22.28	42.04	46	3.96
Middle Channel: 5200MHz									
5200	56.62	PK	H	31.5	5.51	0	93.63	N/A	N/A
5200	44.11	AV	H	31.5	5.51	0	81.12	N/A	N/A
5200	61.61	PK	V	31.5	5.51	0	98.62	N/A	N/A
5200	47.21	AV	V	31.5	5.51	0	84.22	N/A	N/A
10400	27.21	PK	V	36.98	8.34	25.92	46.61	68.2	21.59
15600	27.68	PK	V	37.32	11.46	24.12	52.34	74	21.66
15600	13.79	AV	V	37.32	11.46	24.12	38.45	54	15.55
7500	32.91	PK	V	34.8	7.06	26.37	48.40	74	25.60
7500	30.72	AV	V	34.8	7.06	26.37	46.21	54	7.79
875.84	39.8	QP	V	22.48	3.60	22.22	43.66	46.00	2.34
625.58	41.36	QP	V	19.90	3.06	22.28	42.04	46.00	3.96
250.36	39.44	QP	V	12.17	1.92	21.49	32.04	46.00	13.96
High Channel: 5240MHz									
5240	56.90	PK	H	31.58	5.09	0	93.57	N/A	N/A
5240	44.13	AV	H	31.58	5.09	0	80.80	N/A	N/A
5240	61.82	PK	V	31.58	5.09	0	98.49	N/A	N/A
5240	47.35	AV	V	31.58	5.09	0	84.02	N/A	N/A
5350	22.39	PK	V	31.8	4.58	0	58.77	74	15.23
5350	8.80	AV	V	31.8	4.58	0	45.18	54	8.82
10480	27.12	PK	V	37	8.34	26.02	46.44	68.2	21.76
15720	27.63	PK	V	37.1	11.54	23.53	52.74	74	21.26
15720	13.70	AV	V	37.1	11.54	23.53	38.81	54	15.19
7500	32.35	PK	V	34.8	7.06	26.37	47.84	74	26.16
7500	30.27	AV	V	34.8	7.06	26.37	45.76	54	8.24
625.58	41.6	QP	V	19.9	3.06	22.28	42.28	46	3.72
250.36	40.29	QP	V	12.17	1.92	21.49	32.89	46	13.11

802.11n20 Mode:

Frequency (MHz)	Receiver		Rx Antenna		Cable loss (dB)	Amplifier Gain (dB)	Corrected Amplitude (dBµV/m)	FCC 15.407	
	Reading (dBµV)	Detector (PK/QP/AV)	Polar (H/V)	Factor (dB)				Limit (dBµV/m)	Margin (dB)
Low Channel:5180MHz									
5180	54.13	PK	H	31.46	5.49	0	91.08	N/A	N/A
5180	41.7	AV	H	31.46	5.49	0	78.65	N/A	N/A
5180	61.15	PK	V	31.46	5.49	0	98.1	N/A	N/A
5180	47.82	AV	V	31.46	5.49	0	84.77	N/A	N/A
5150	22.16	PK	V	31.4	5.45	0	59.01	74	14.99
5150	8.76	AV	V	31.4	5.45	0	45.61	54	8.39
10360	27.65	PK	V	36.97	8.34	25.85	47.11	68.2	21.09
15540	27.72	PK	V	37.43	11.42	24.1	52.47	74	21.53
15540	14.47	AV	V	37.43	11.42	24.1	39.22	54	14.78
7500	32.19	PK	V	34.8	7.06	26.37	47.68	74	26.32
7500	30.29	AV	V	34.8	7.06	26.37	45.78	54	8.22
625.58	40.9	QP	V	19.9	3.06	22.28	41.58	46	4.42
250.36	41.07	QP	V	12.17	1.92	21.49	33.67	46	12.33
Middle Channel: 5200MHz									
5200	53.98	PK	H	31.5	5.51	0	90.99	N/A	N/A
5200	41.69	AV	H	31.5	5.51	0	78.7	N/A	N/A
5200	61.23	PK	V	31.5	5.51	0	98.24	N/A	N/A
5200	47.97	AV	V	31.5	5.51	0	84.98	N/A	N/A
10400	27.82	PK	V	36.98	8.34	25.92	47.22	68.2	20.98
15600	27.49	PK	V	37.32	11.46	24.12	52.15	74	21.85
15600	14.55	AV	V	37.32	11.46	24.12	39.21	54	14.79
7500	32.48	PK	V	34.8	7.06	26.37	47.97	74	26.03
7500	30.67	AV	V	34.8	7.06	26.37	46.16	54	7.84
875.84	40.16	QP	V	22.48	3.6	22.22	44.02	46	1.98
625.58	40.71	QP	V	19.9	3.06	22.28	41.39	46	4.61
250.36	38.77	QP	V	12.17	1.92	21.49	31.37	46	14.63
High Channel: 5240MHz									
5240	54.17	PK	H	31.58	5.09	0	90.84	N/A	N/A
5240	41.72	AV	H	31.58	5.09	0	78.39	N/A	N/A
5240	60.91	PK	V	31.58	5.09	0	97.58	N/A	N/A
5240	47.99	AV	V	31.58	5.09	0	84.66	N/A	N/A
5350	22.11	PK	V	31.8	4.58	0	58.49	74	15.51
5350	8.37	AV	V	31.8	4.58	0	44.75	54	9.25
10480	27.91	PK	V	37	8.34	26.02	47.23	68.2	20.97
15720	27.85	PK	V	37.1	11.54	23.53	52.96	74	21.04
15720	14.54	AV	V	37.1	11.54	23.53	39.65	54	14.35
7500	33.81	PK	V	34.8	7.06	26.37	49.3	74	24.7
7500	31.46	AV	V	34.8	7.06	26.37	46.95	54	7.05
875.84	38.9	QP	V	22.48	3.6	22.22	42.76	46	3.24
250.36	40.16	QP	V	12.17	1.92	21.49	32.76	46	13.24

802.11n40 Mode:

Frequency (MHz)	Receiver		Rx Antenna		Cable loss (dB)	Amplifier Gain (dB)	Corrected Amplitude (dBµV/m)	FCC 15.407	
	Reading (dBµV)	Detector (PK/QP/AV)	Polar (H/V)	Factor (dB)				Limit (dBµV/m)	Margin (dB)
Low Channel: 5190MHz									
5190	54.81	PK	H	31.48	5.5	0	91.79	N/A	N/A
5190	41.74	AV	H	31.48	5.5	0	78.72	N/A	N/A
5190	61.18	PK	V	31.48	5.5	0	98.16	N/A	N/A
5190	48.02	AV	V	31.48	5.5	0	85.00	N/A	N/A
5150	22.26	PK	V	31.4	5.45	0	59.11	74	14.89
5150	8.84	AV	V	31.4	5.45	0	45.69	54	8.31
10380	27.66	PK	V	36.98	8.34	25.89	47.09	68.2	21.11
15570	27.46	PK	V	37.37	11.44	24.11	52.16	74	21.84
15570	14.50	AV	V	37.37	11.44	24.11	39.20	54	14.80
7500	32.67	PK	V	34.8	7.06	26.37	48.16	74	25.84
7500	30.82	AV	V	34.8	7.06	26.37	46.31	54	7.69
625.58	39.70	QP	V	19.9	3.06	22.28	40.38	46	5.62
250.36	38.77	QP	V	12.17	1.92	21.49	31.37	46	14.63
High Channel: 5230MHz									
5230	54.54	PK	H	31.56	5.2	0	91.30	N/A	N/A
5230	41.47	AV	H	31.56	5.2	0	78.23	N/A	N/A
5230	61.37	PK	V	31.56	5.2	0	98.13	N/A	N/A
5230	48.10	AV	V	31.56	5.2	0	84.86	N/A	N/A
5350	22.10	PK	V	31.8	4.58	0	58.48	74.2	15.72
5350	8.56	AV	V	31.8	4.58	0	44.94	60	15.06
11590	27.27	PK	V	37.9	8.01	25.91	47.27	74.2	26.93
17385	27.81	PK	V	41.81	12.17	24.61	57.18	74.2	17.02
17385	14.51	AV	V	41.81	12.17	24.61	43.88	60	16.12
7500	32.63	PK	V	34.8	7.06	26.37	48.12	74.2	26.08
7500	30.77	AV	V	34.8	7.06	26.37	46.26	60	13.74
625.58	40.80	QP	V	19.9	3.06	22.28	41.48	46	4.52
250.36	38.77	QP	V	12.17	1.92	21.49	31.37	46	14.63

Note: the measurement distance was 1.5m for the frequencies above 1 GHz.

## Conducted Spurious Emission at Antenna Port

### Test Procedure

1. Check the calibration of the measuring instrument using either an internal calibrator or a known signal from an external generator.
2. The Resolution bandwidth is set to 1MHz, The Video bandwidth is set to  $\geq 1$ MHz, report the peak value out of the operating band. Offset the antenna gain and cable loss.
3. Repeat above procedures until all frequencies measured were complete.



**Test data**

*Mode: Transmitting*

Please refer to the following table and plots.

Frequency (MHz)	Worst Reading Level (dBm)	Limit (dBm)	Result
802.11a			
5180	-34.88	-27	PASS
5200	-34.77	-27	PASS
5240	-34.71	-27	PASS
802.11n20 Chain 0			
5180	-36.29	-27	PASS
5200	-36.53	-27	PASS
5240	-35.93	-27	PASS
802.11n20 Chain 1			
5180	-36.65	-27	PASS
5200	-37.14	-27	PASS
5240	-34.60	-27	PASS
802.11n20 Chain 2			
5180	-36.73	-27	PASS
5200	-36.16	-27	PASS
5240	-36.48	-27	PASS
802.11n20 Total:Chain 0+ Chain 1+ Chain 2			
5180	-31.78	-27	PASS
5200	-31.82	-27	PASS
5240	-31.83	-27	PASS
802.11n40 Chain 0			
5190	-34.84	-27	PASS
5230	-35.86	-27	PASS
802.11n40 Chain 1			
5190	-37.72	-27	PASS
5230	-36.38	-27	PASS
802.11n40 Chain 2			
5190	-35.41	-27	PASS
5230	-36.25	-27	PASS
802.11n40 Total:Chain 0+ Chain 1+ Chain 2			
5190	-31.05	-27	PASS
5230	-31.39	-27	PASS

Note: the antenna gain is 5dBi, cable loss 1dB.



Please refer to the following plots.

### 802.11a Low Channel 30M-1G

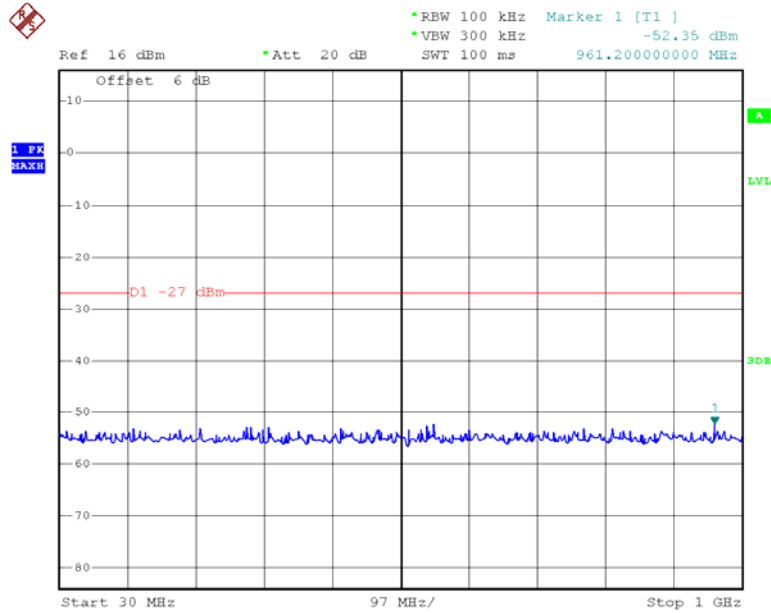

Date: 29.MAR.2013 13:38:08

### 802.11a Low Channel 1G-26.5G

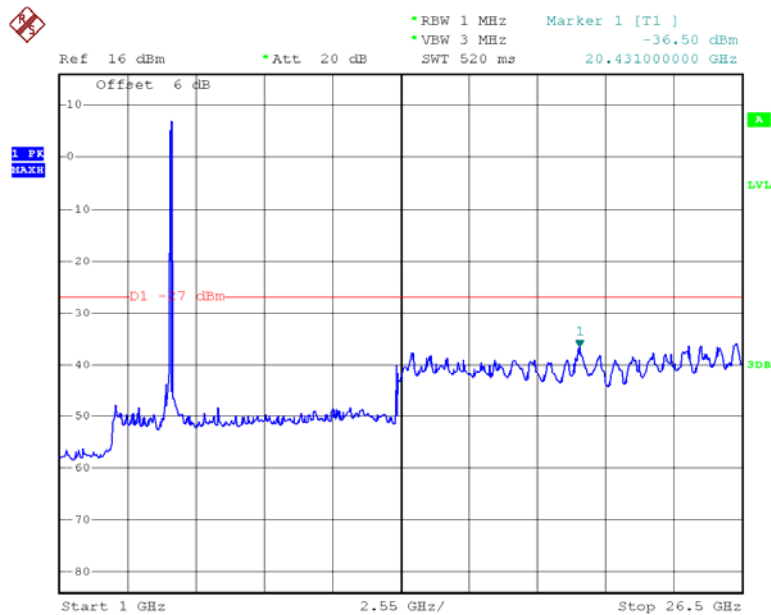

Date: 29.MAR.2013 13:39:54

### 802.11a Low Channel 26.5-40G

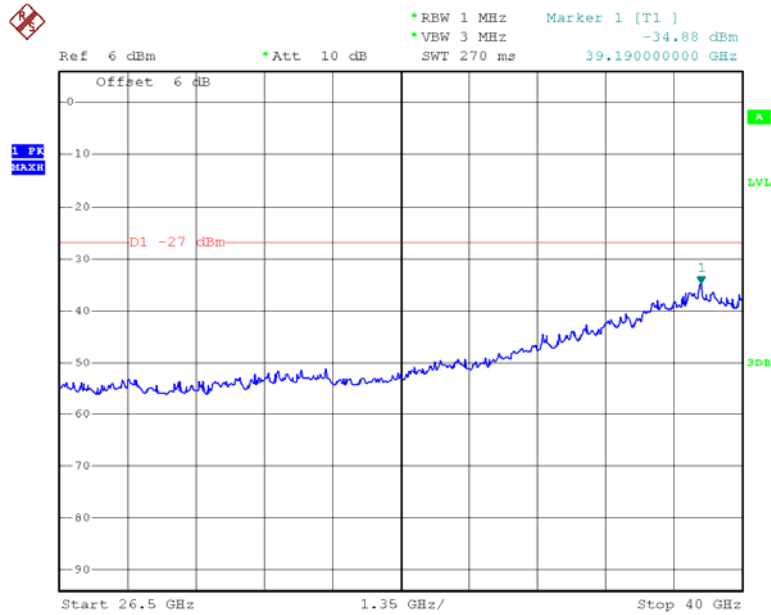

Date: 29.MAR.2013 13:40:15

### 802.11a Middle Channel 30M-1G

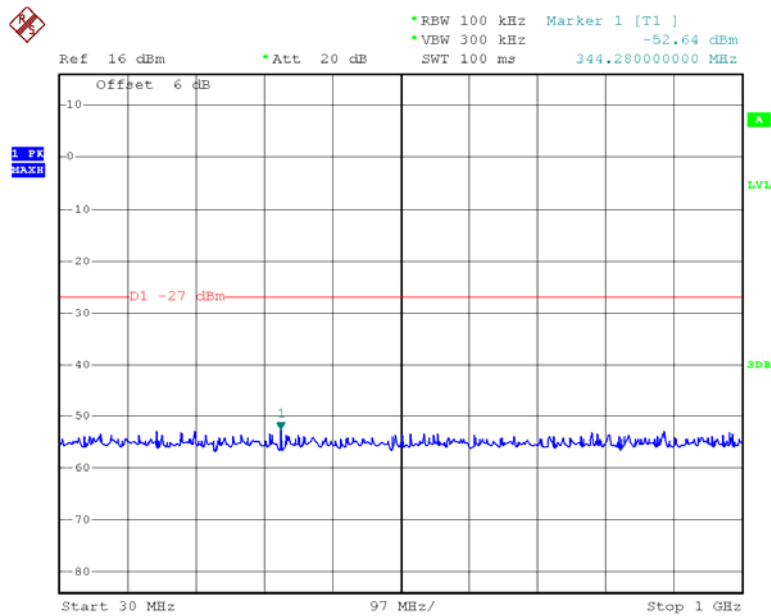

Date: 29.MAR.2013 13:41:36

### 802.11a Middle Channel 1G -26.5G

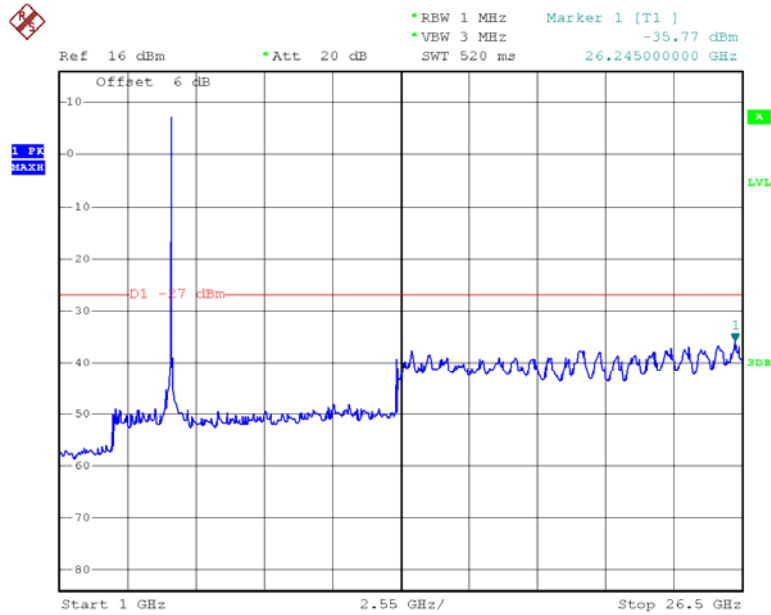

Date: 29.MAR.2013 13:42:01

### 802.11a Middle Channel 26.5-40G

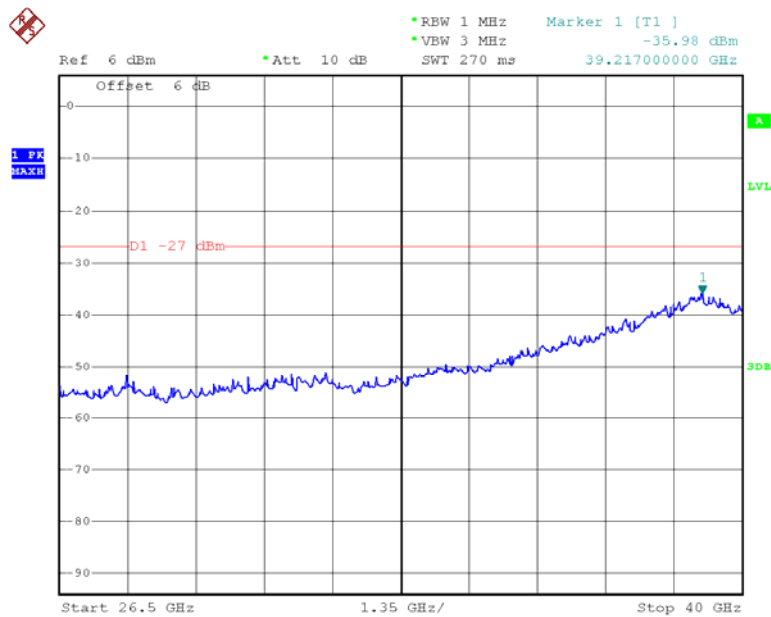

Date: 29.MAR.2013 13:42:15

### 802.11a High Channel 30M-1G

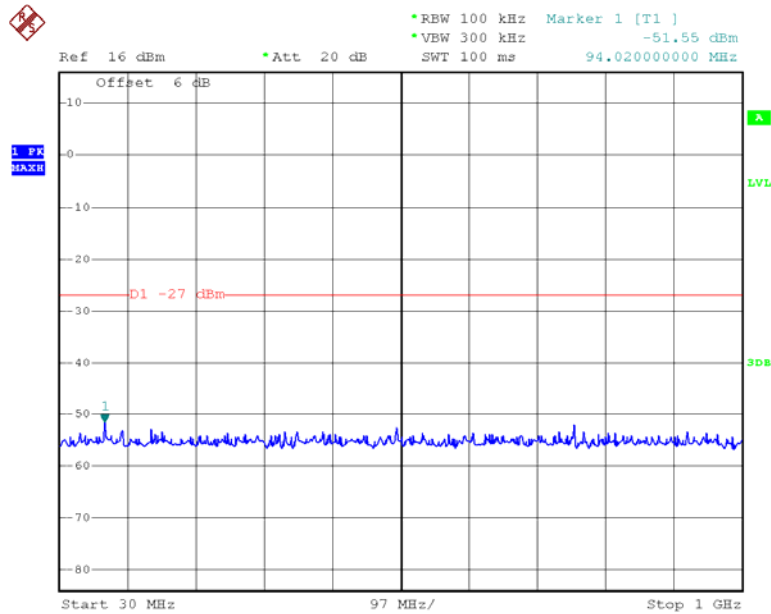

Date: 29.MAR.2013 13:43:20

### 802.11a High Channel 1G-26.5G

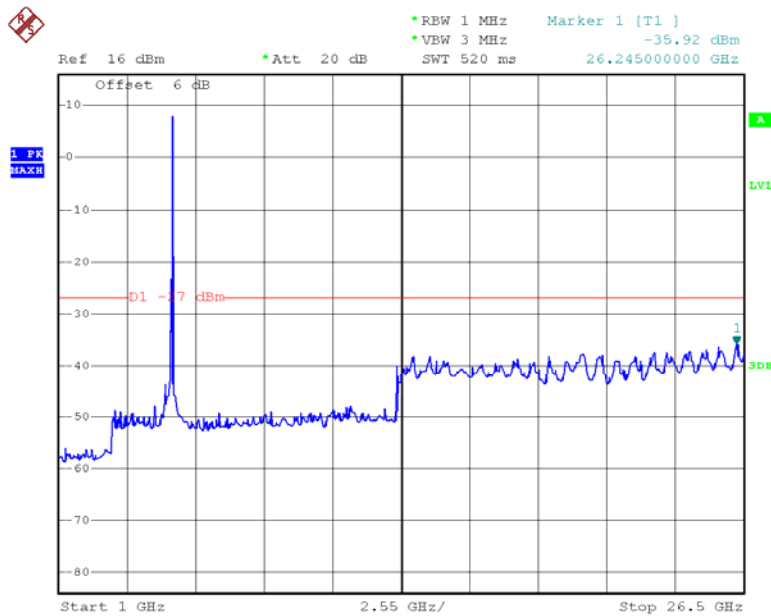

Date: 29.MAR.2013 13:43:42

### 802.11a High Channel 26.5-40G

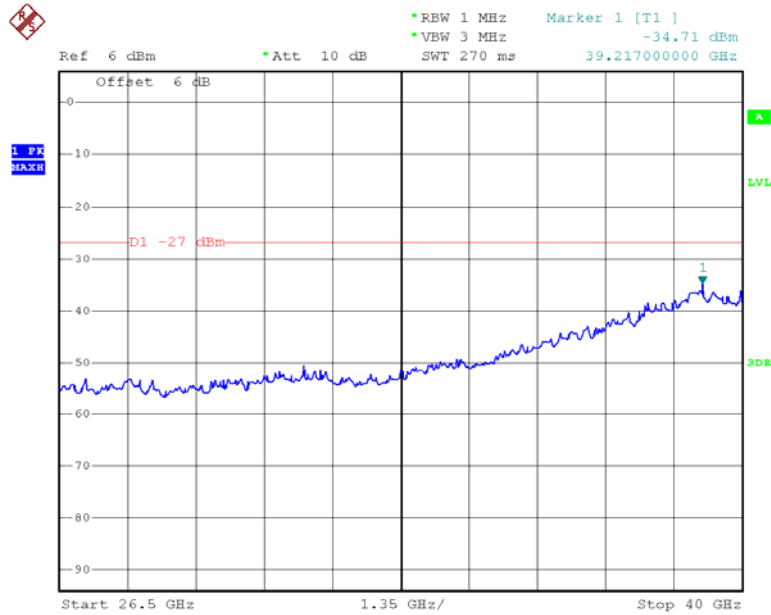

Date: 29.MAR.2013 13:43:54

### Chain 0: 802.11n20 Low Channel 30M-1G

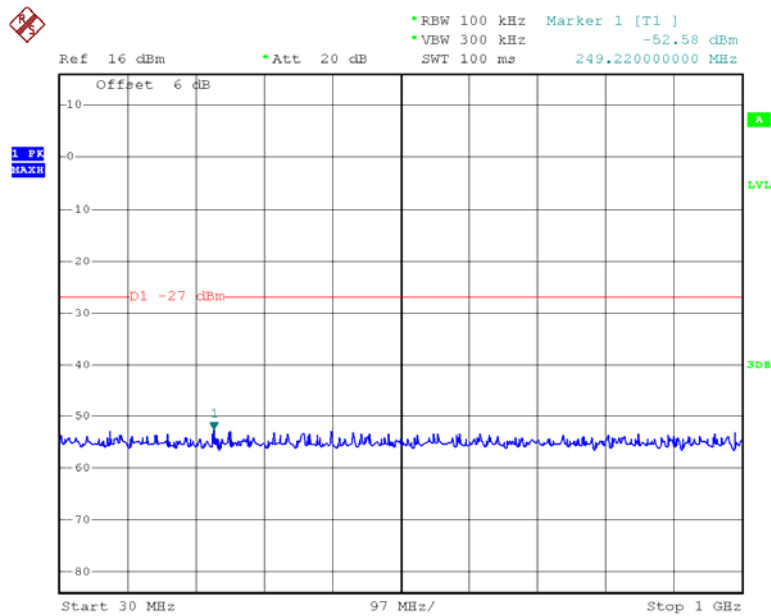

Date: 29.MAR.2013 13:45:53

### Chain 0: 802.11n20 Low Channel 1G-26.5G

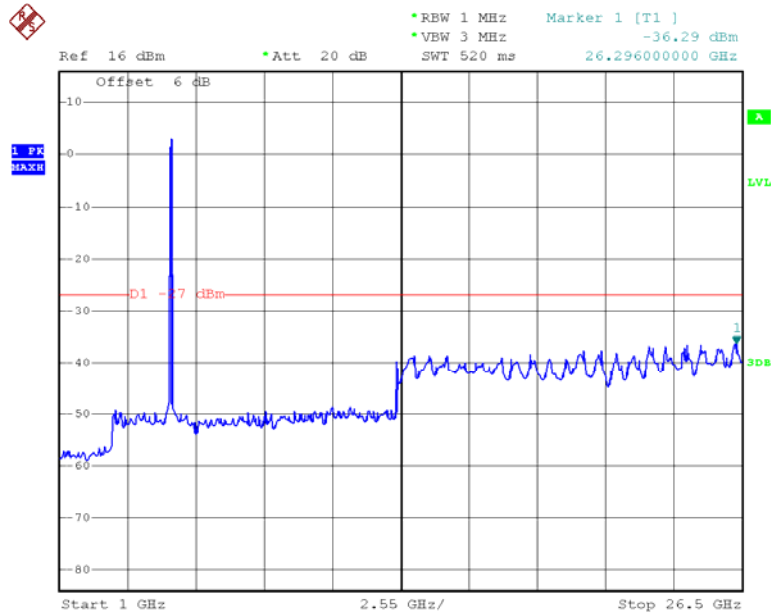

Date: 29.MAR.2013 13:51:45

### Chain 0: 802.11n20 Low Channel 26.5-40G

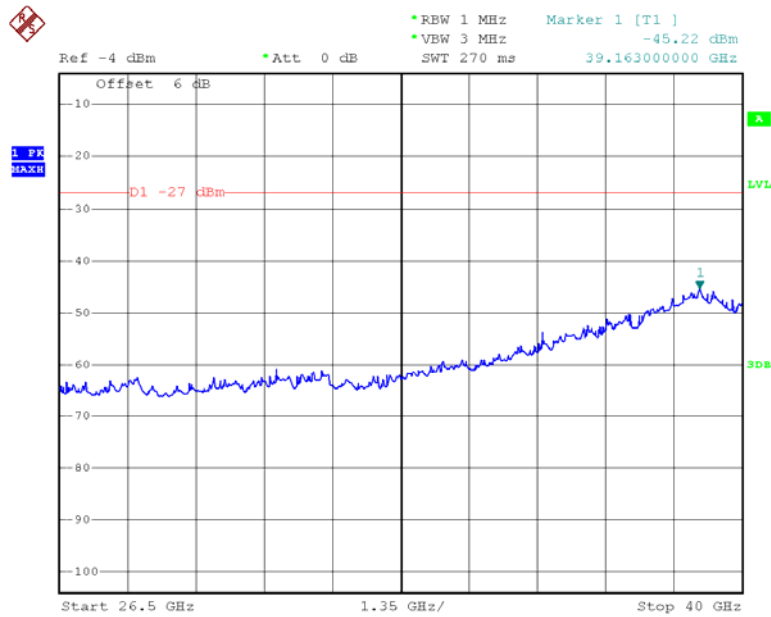

Date: 29.MAR.2013 13:48:27

### Chain 0: 802.11n20 Middle Channel 30M-1G

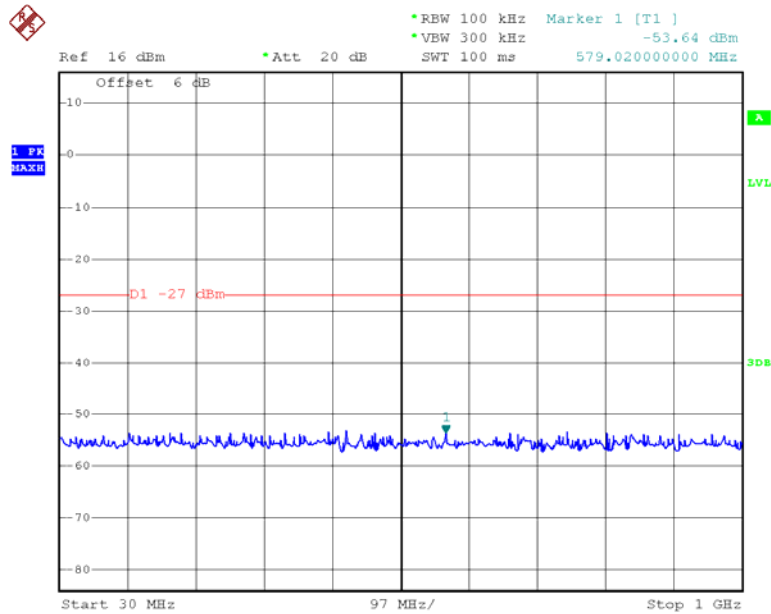

Date: 29.MAR.2013 13:46:13

### Chain 0: 802.11n20 Middle Channel 1G -26.5G

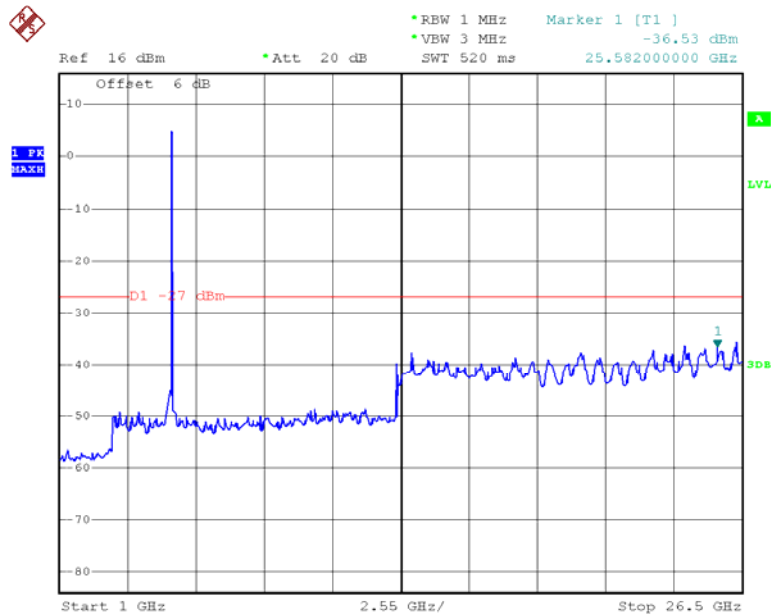

Date: 29.MAR.2013 13:52:28

### Chain 0: 802.11n20 Middle Channel 26.5-40G

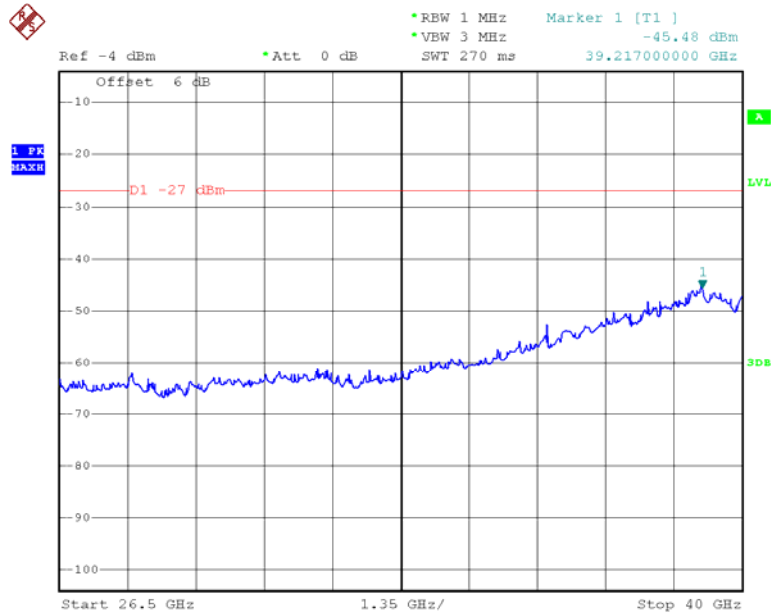

Date: 29.MAR.2013 13:48:33

### Chain 0: 802.11n20 High Channel 30M-1G

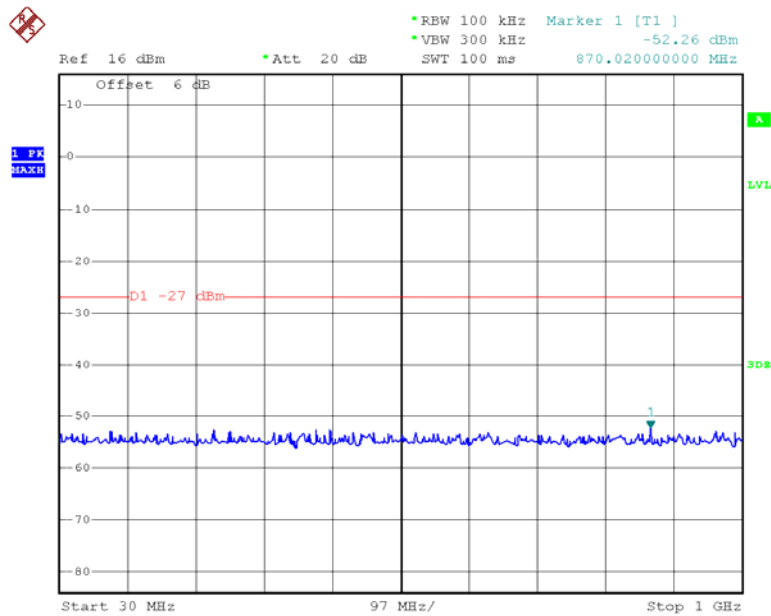

Date: 29.MAR.2013 13:46:03



### Chain 0: 802.11n20 High Channel 1G-26.5G

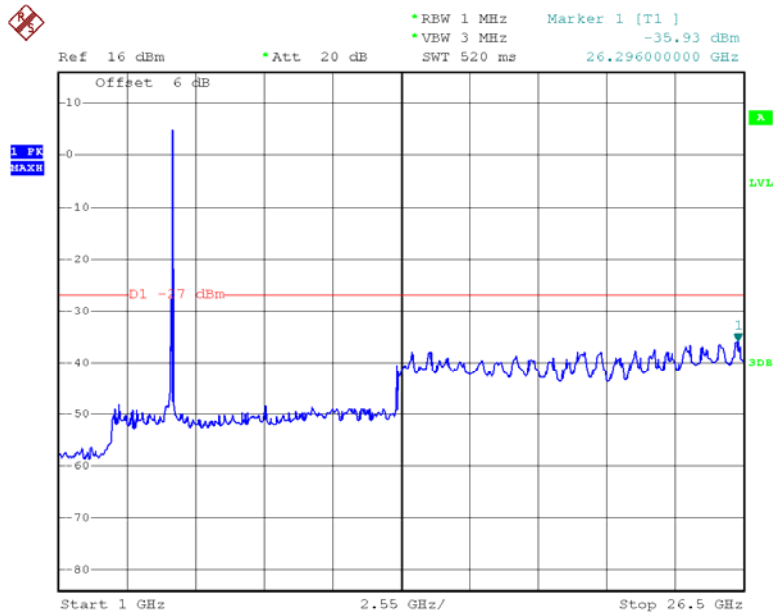

Date: 29.MAR.2013 13:46:44

### Chain 0: 802.11n20 High Channel 26.5-40G

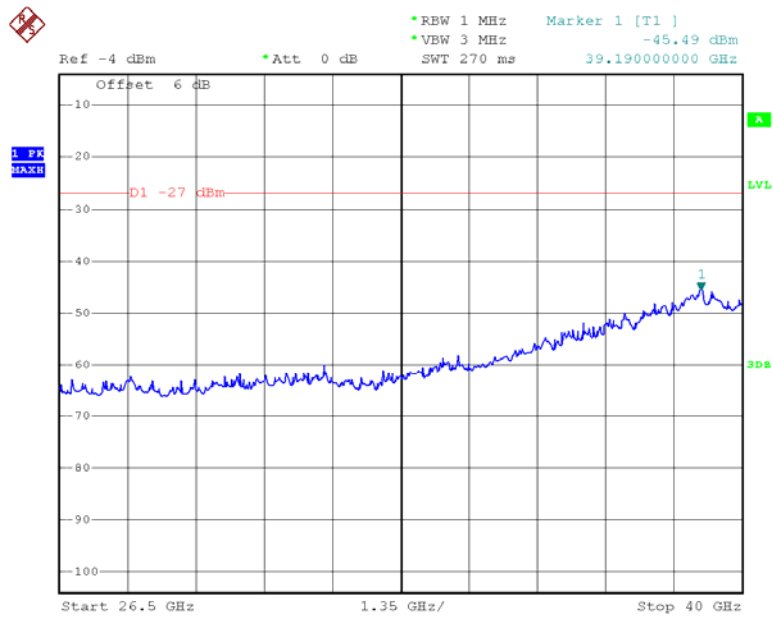

Date: 29.MAR.2013 13:48:47

### Chain 1: 802.11n20 Low Channel 30M-1G

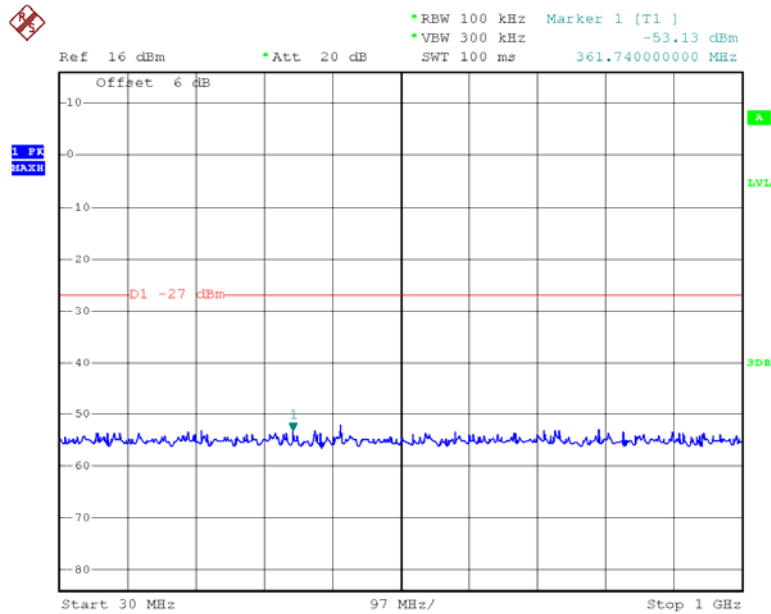

Date: 29.MAR.2013 13:54:06

### Chain 1: 802.11n20 Low Channel 1G-26.5G

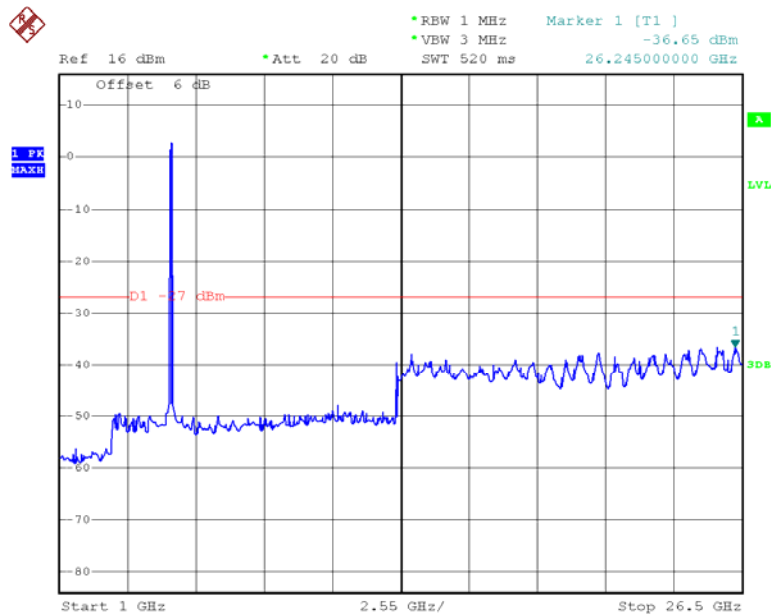

Date: 29.MAR.2013 13:53:39

### Chain 1: 802.11n20 Low Channel 26.5-40G

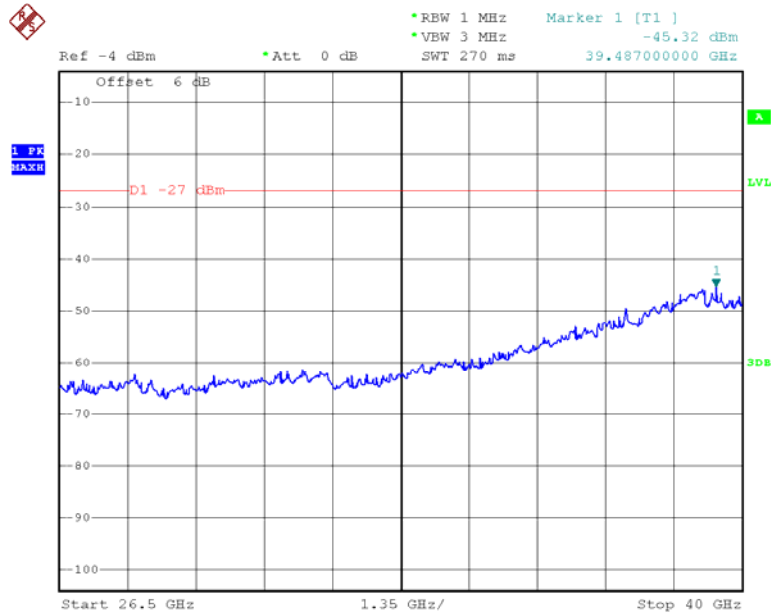

Date: 29.MAR.2013 13:56:17

### Chain 1: 802.11n20 Middle Channel 30M-1G

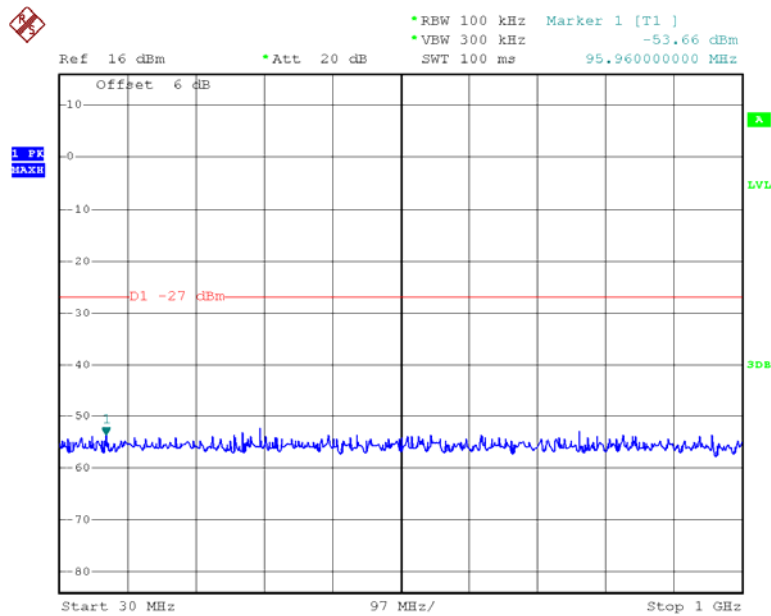

Date: 29.MAR.2013 13:54:31

### Chain 1: 802.11n20 Middle Channel 1G -26.5G

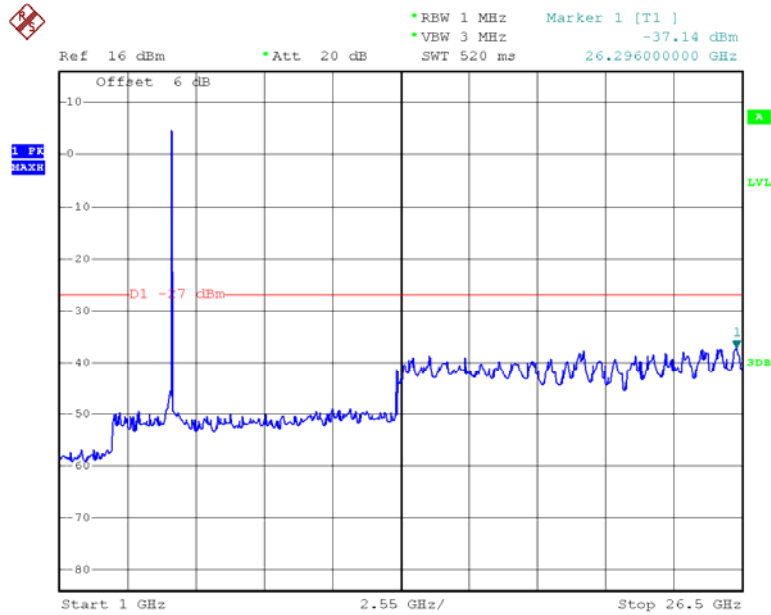

Date: 29.MAR.2013 13:53:17

### Chain 1: 802.11n20 Middle Channel 26.5-40G

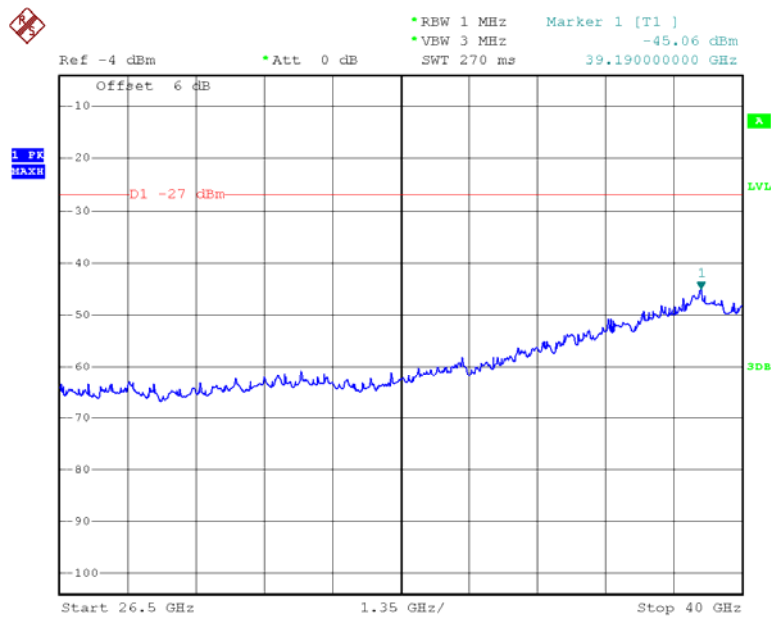

Date: 29.MAR.2013 13:55:54

### Chain 1: 802.11n20 High Channel 30M-1G

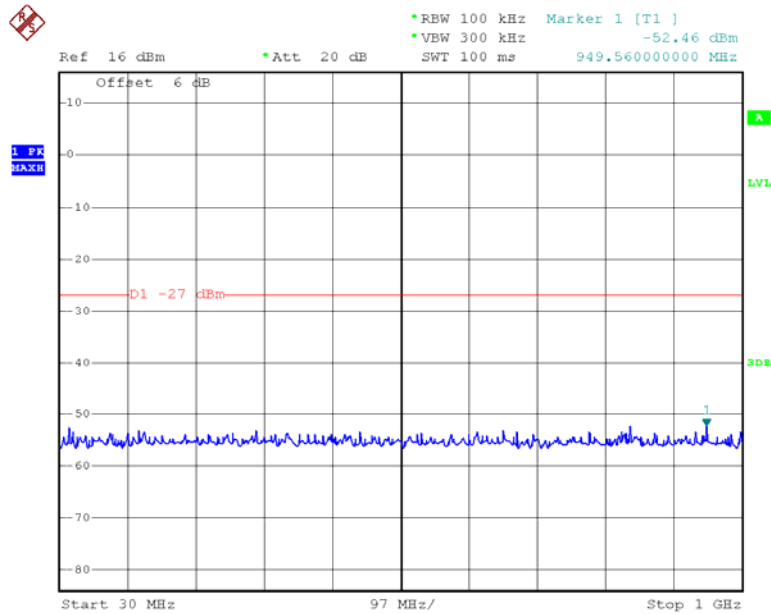

Date: 29.MAR.2013 13:54:58

### Chain 1: 802.11n20 High Channel 1G-26.5G

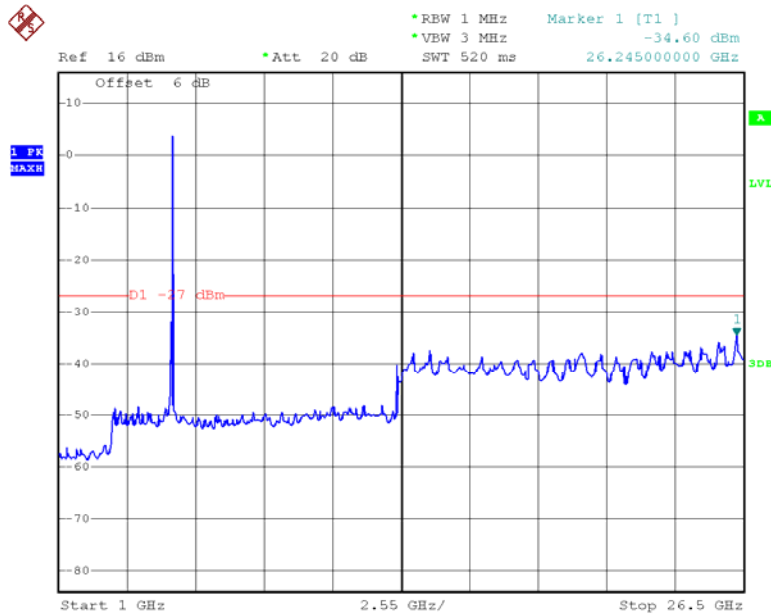

Date: 29.MAR.2013 13:47:19

### Chain 1: 802.11n20 High Channel 26.5-40G

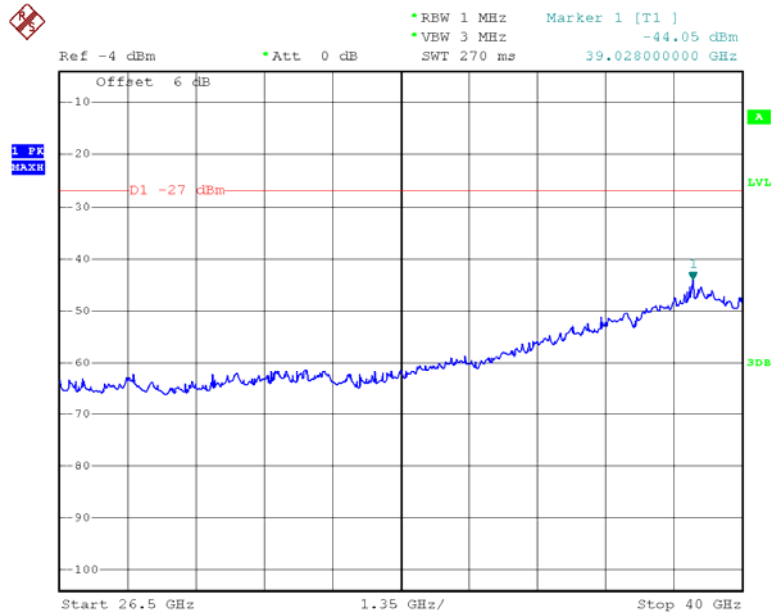

Date: 29.MAR.2013 13:55:33

### Chain 2: 802.11n20 Low Channel 30M-1G

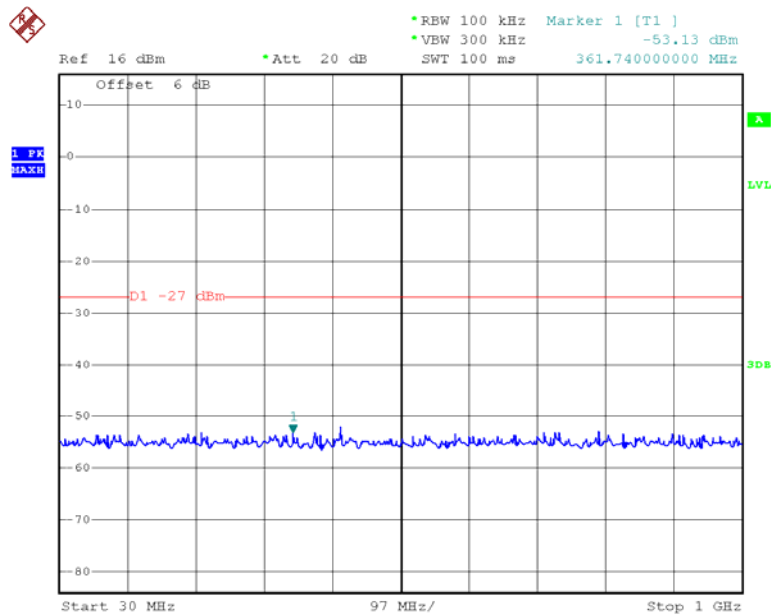

Date: 29.MAR.2013 13:54:06

### Chain 2: 802.11n20 Low Channel 1G-26.5G

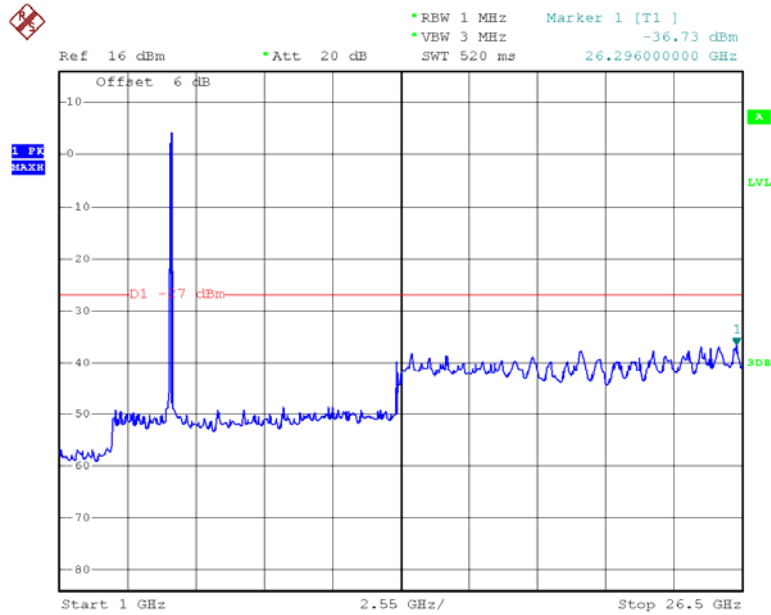

Date: 29.MAR.2013 13:58:05

### Chain 2: 802.11n20 Low Channel 26.5-40G

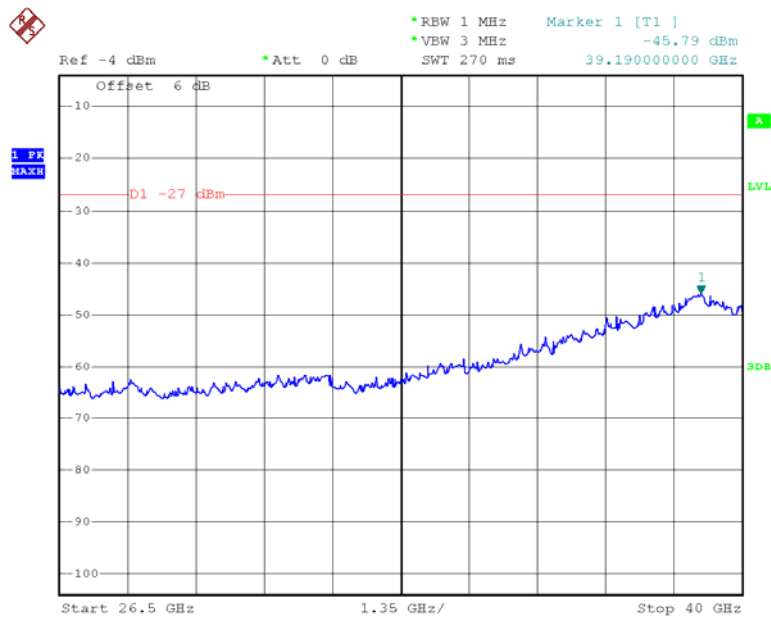

Date: 29.MAR.2013 13:55:47

### Chain 2: 802.11n20 Middle Channel 30M-1G

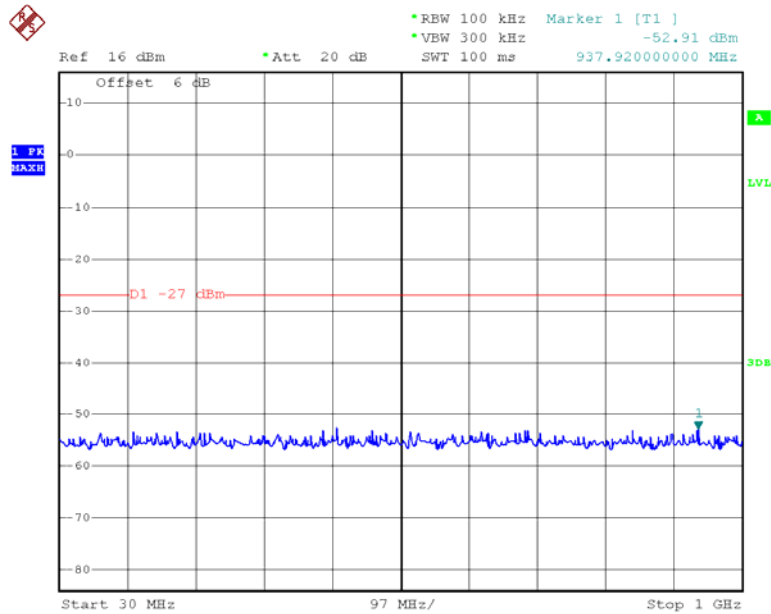

Date: 29.MAR.2013 13:54:21

### Chain 2: 802.11n20 Middle Channel 1G -26.5G

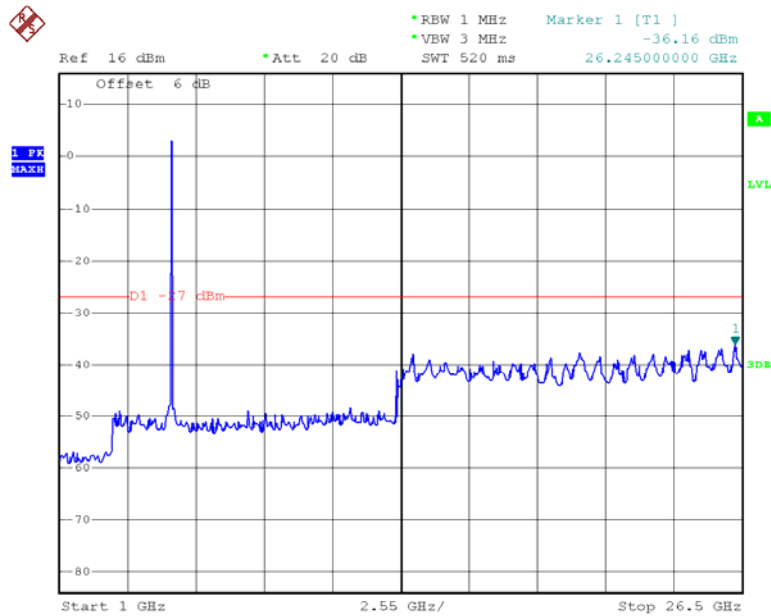

Date: 29.MAR.2013 13:58:24



### Chain 2: 802.11n20 Middle Channel 26.5-40G

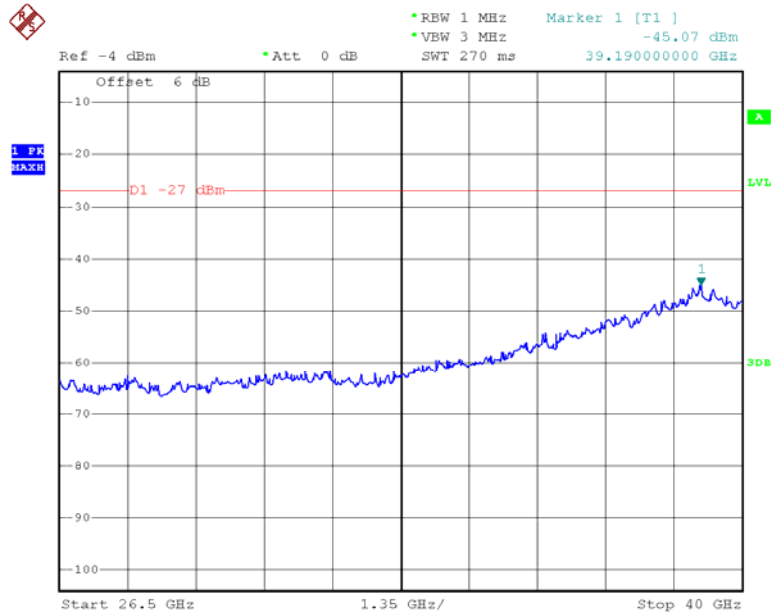

Date: 29.MAR.2013 13:56:10

### Chain 2: 802.11n20 High Channel 30M-1G

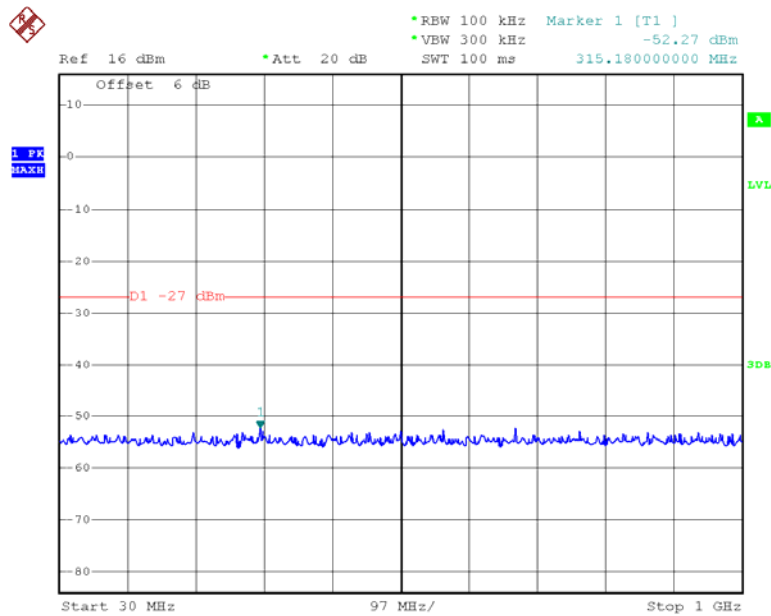

Date: 29.MAR.2013 13:54:41

### Chain 2: 802.11n20 High Channel 1G-26.5G

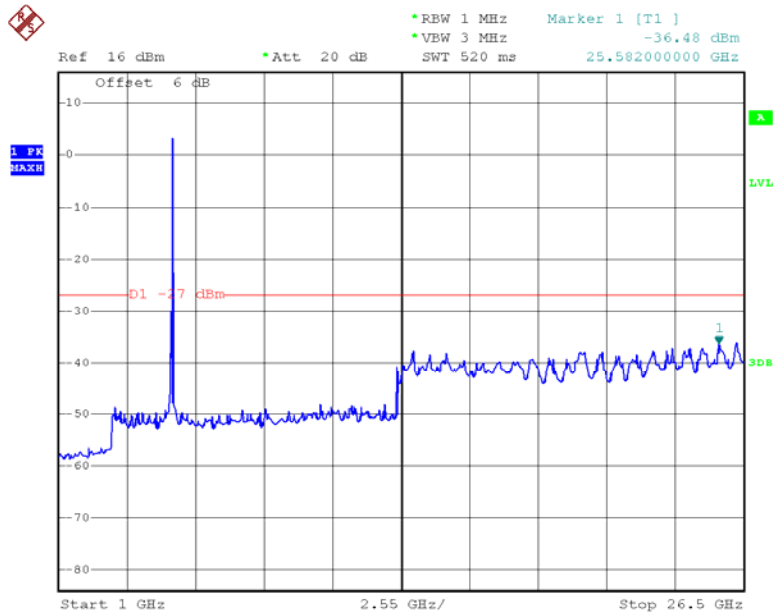

Date: 29.MAR.2013 13:47:00

### Chain 2: 802.11n20 High Channel 26.5-40G

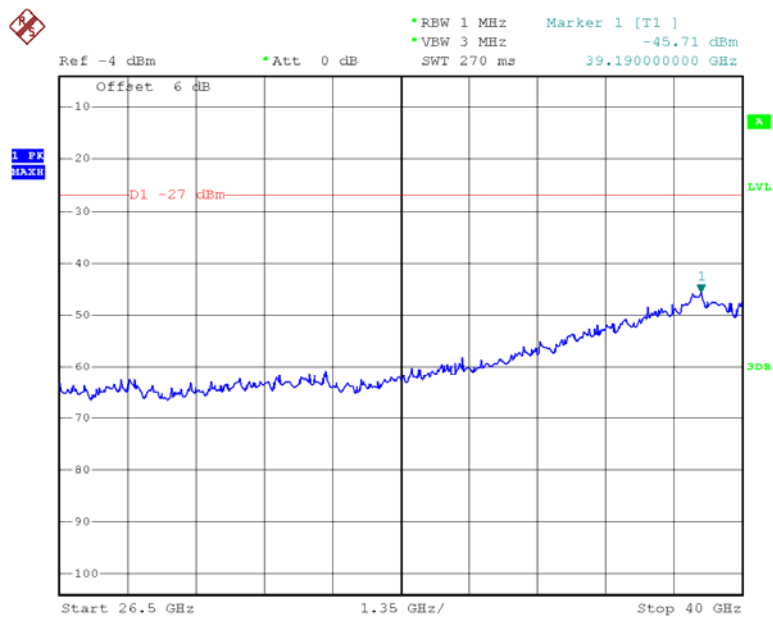

Date: 29.MAR.2013 13:56:36

### Chain 0: 802.11n40 Low Channel 30M-1G

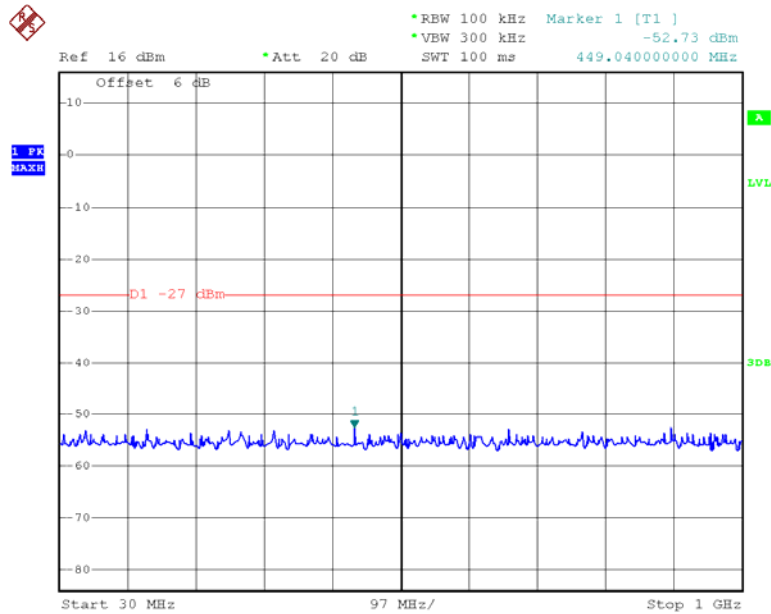

Date: 29.MAR.2013 14:00:32

### Chain 0: 802.11n40 Low Channel 1G-26.5G

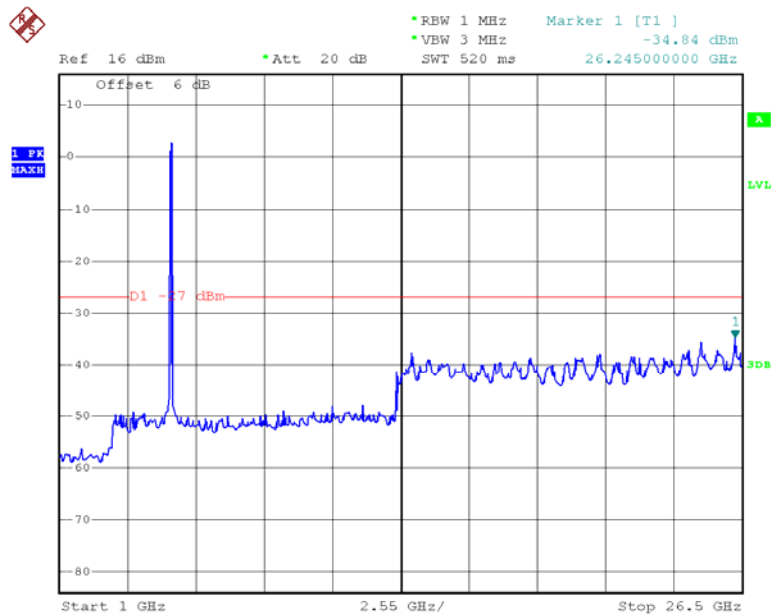

Date: 29.MAR.2013 13:59:10

### Chain 0: 802.11n40 Low Channel 26.5-40G

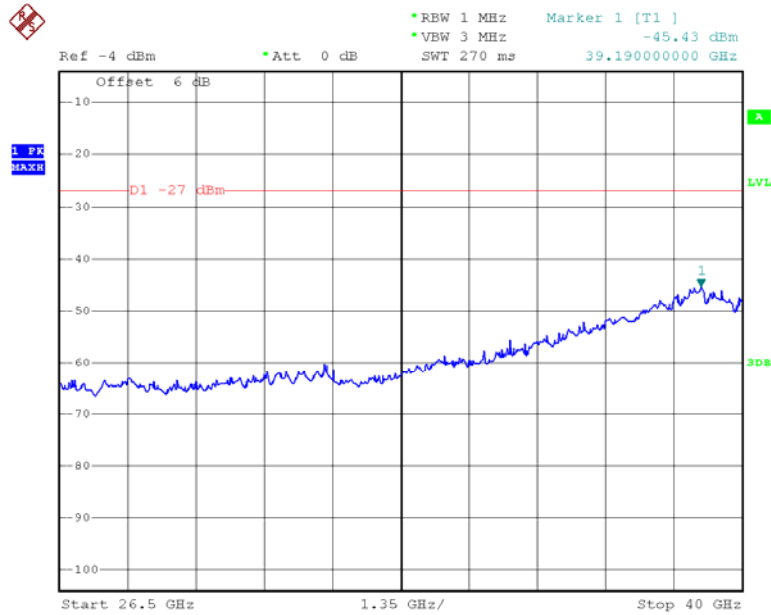

Date: 29.MAR.2013 14:01:47

### Chain 0: 802.11n40 High Channel 30M-1G

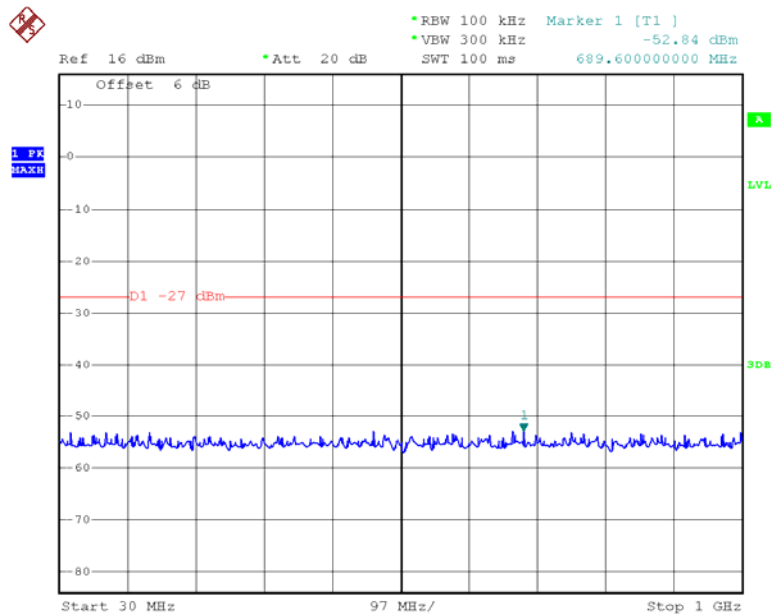

Date: 29.MAR.2013 14:00:48

### Chain 0: 802.11n40 High Channel 1G-26.5G

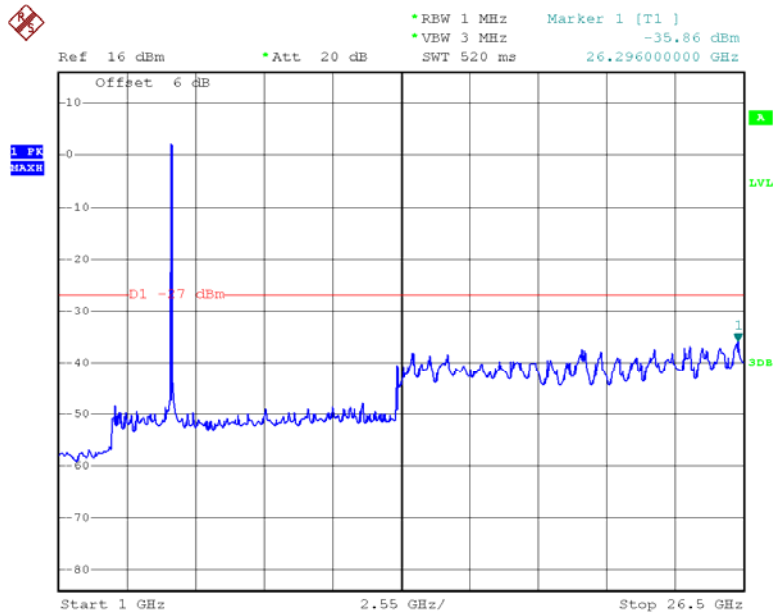

Date: 29.MAR.2013 13:59:40

### Chain 0: 802.11n40 High Channel 26.5-40G

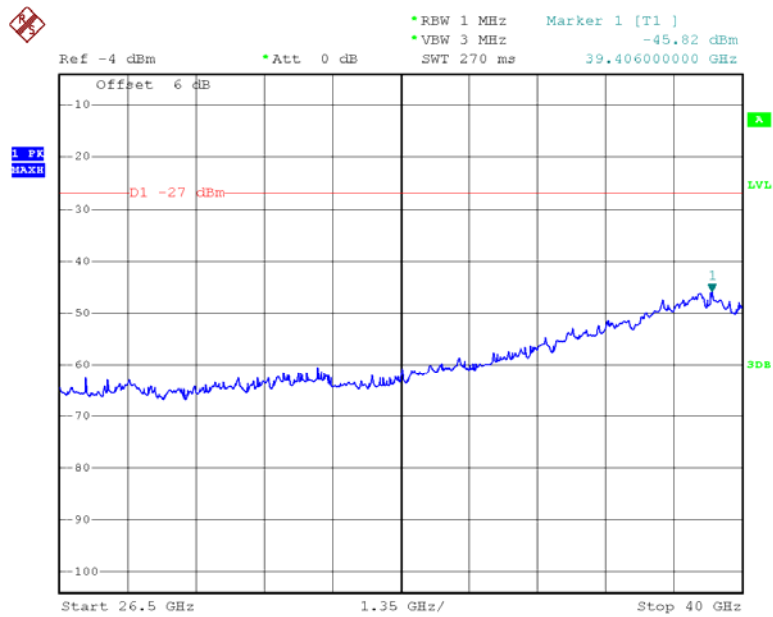

Date: 29.MAR.2013 14:02:01

### Chain 1: 802.11n40 Low Channel 30M-1G

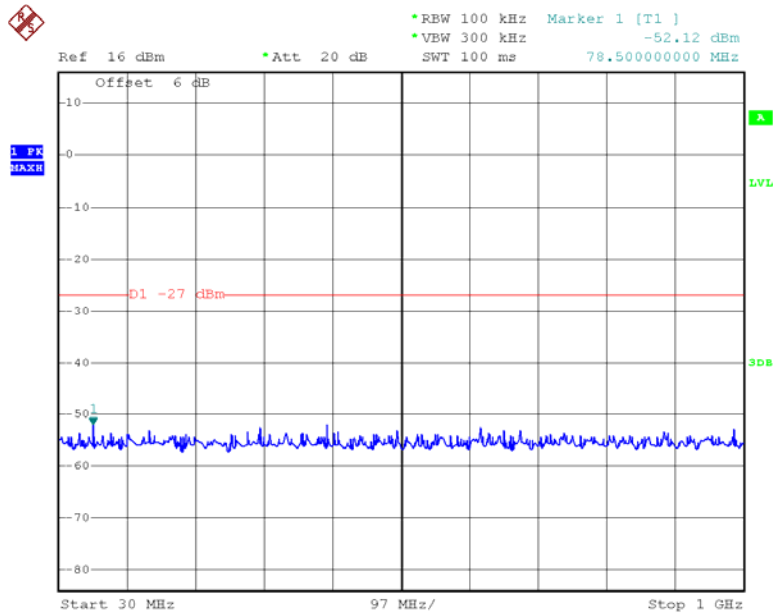

Date: 29.MAR.2013 14:01:02

### Chain 1: 802.11n40 Low Channel 1G-26.5G

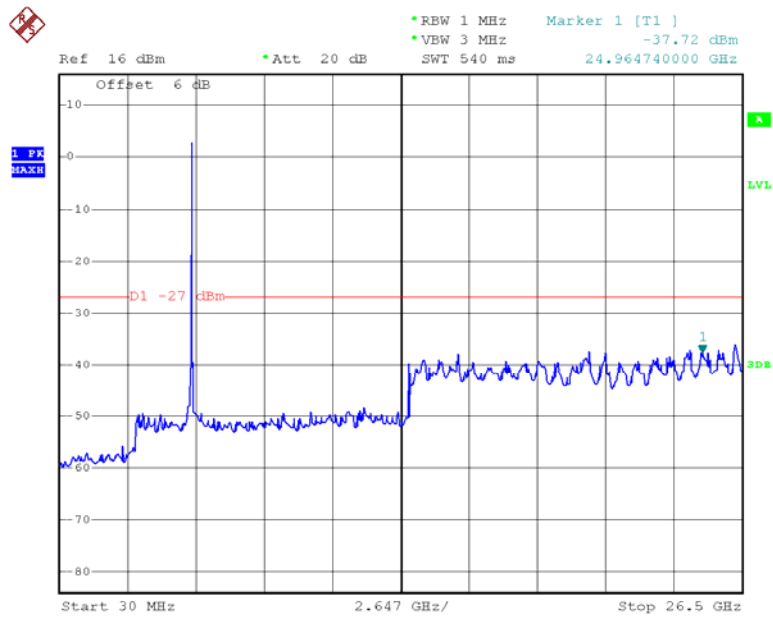

Date: 29.MAR.2013 14:05:27

### Chain 1: 802.11n40 Low Channel 26.5-40G

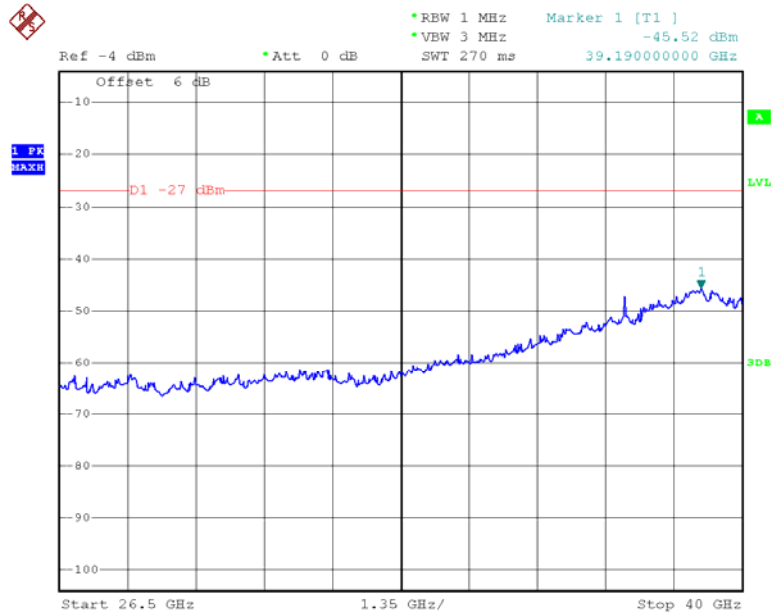

Date: 29.MAR.2013 14:03:09

### Chain 1: 802.11n40 High Channel 30M-1G

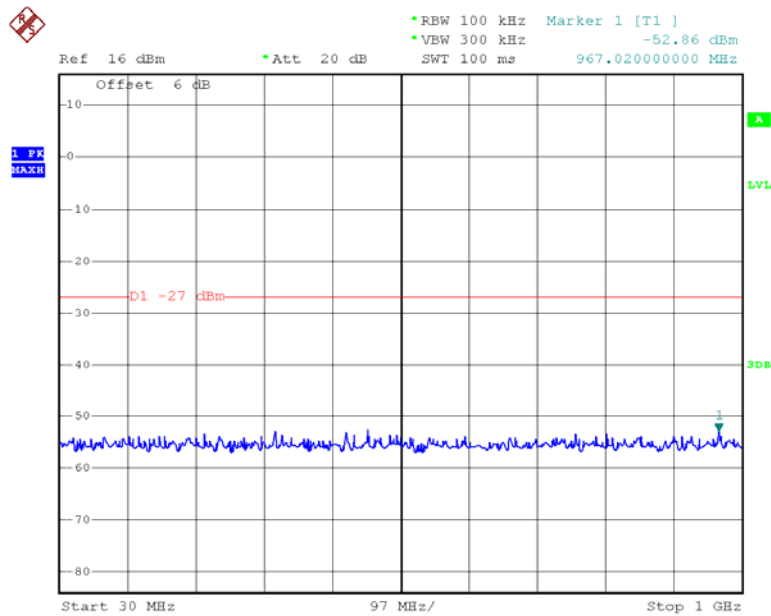

Date: 29.MAR.2013 14:01:13

### Chain 1: 802.11n40 High Channel 1G-26.5G

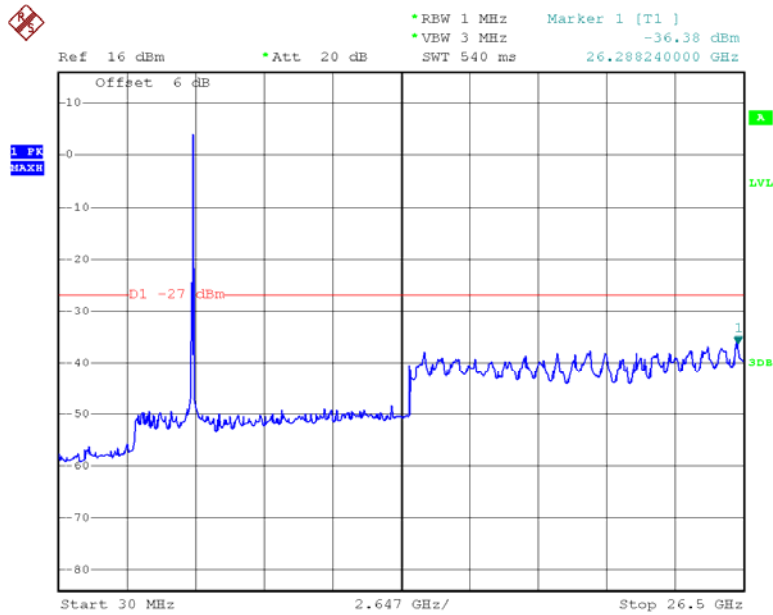

Date: 29.MAR.2013 14:05:50

### Chain 1: 802.11n40 High Channel 26.5-40G

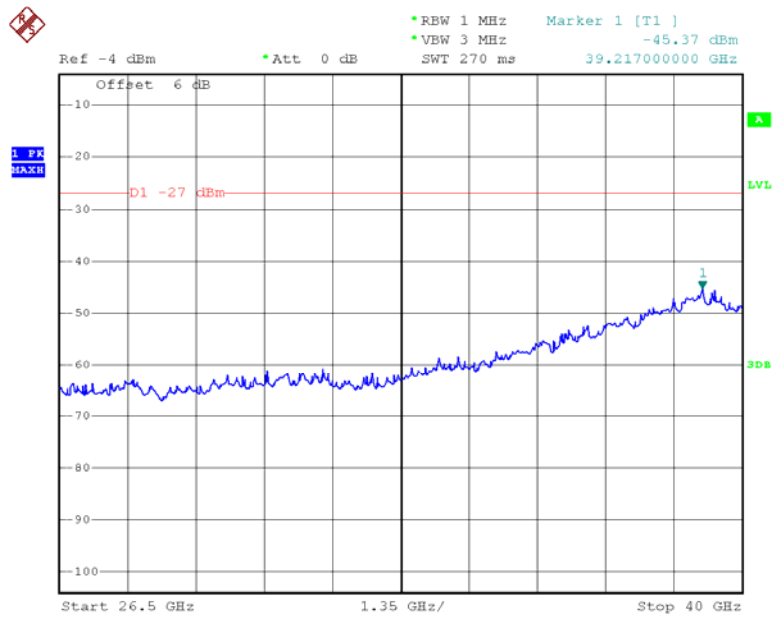

Date: 29.MAR.2013 14:03:14



### Chain 2: 802.11n40 Low Channel 30M-1G

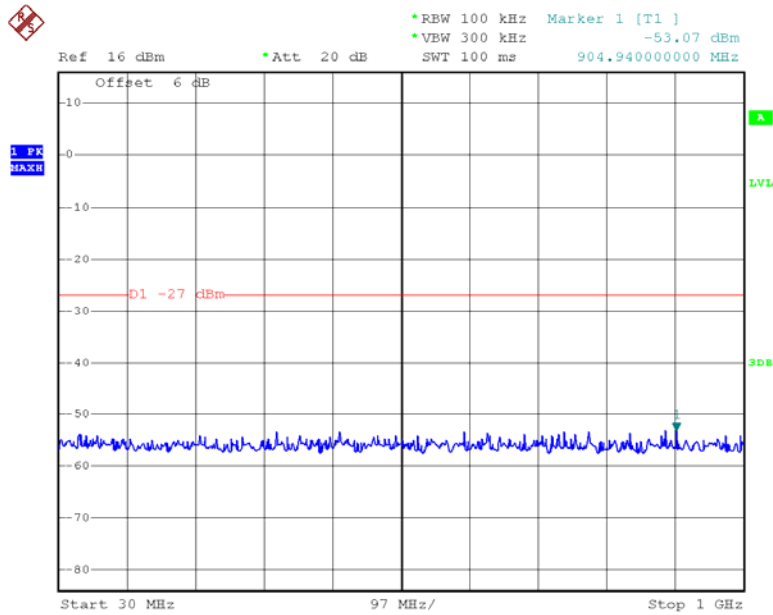

Date: 29.MAR.2013 14:01:19

### Chain 2: 802.11n40 Low Channel 1G-26.5G

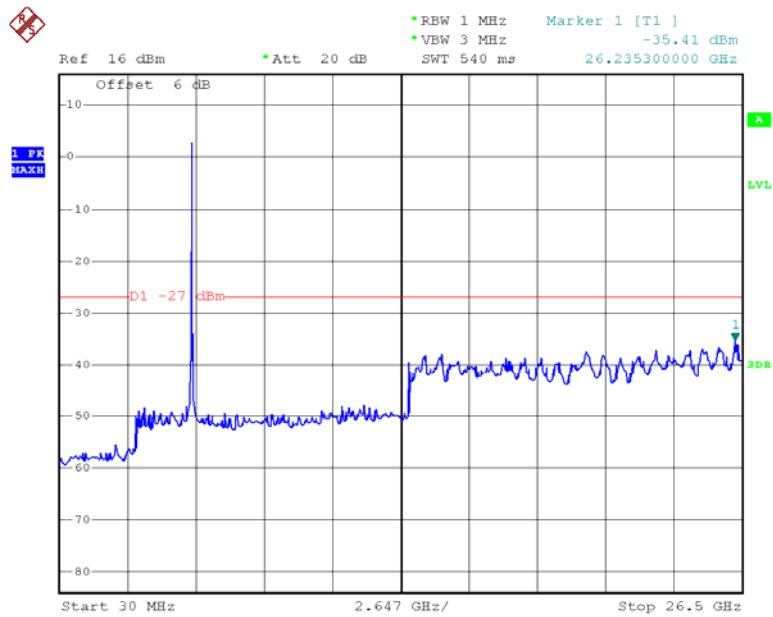

Date: 29.MAR.2013 14:04:36

### Chain 2: 802.11n40 Low Channel 26.5-40G

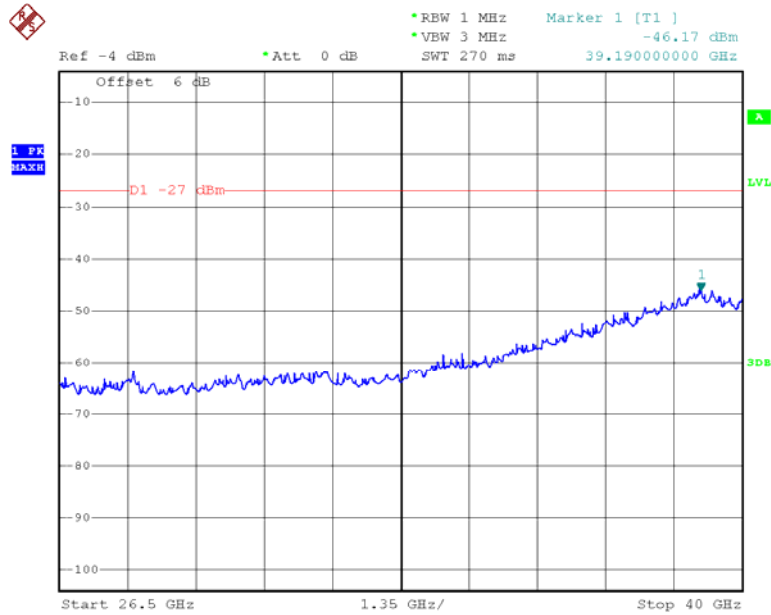

Date: 29.MAR.2013 14:03:19

### Chain 2: 802.11n40 High Channel 30M-1G

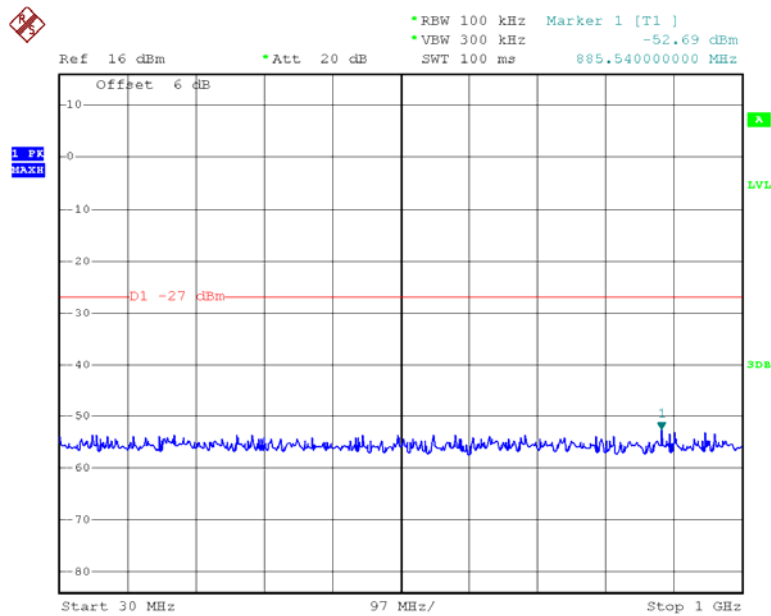

Date: 29.MAR.2013 14:01:25

### Chain 2: 802.11n40 High Channel 1G-26.5G

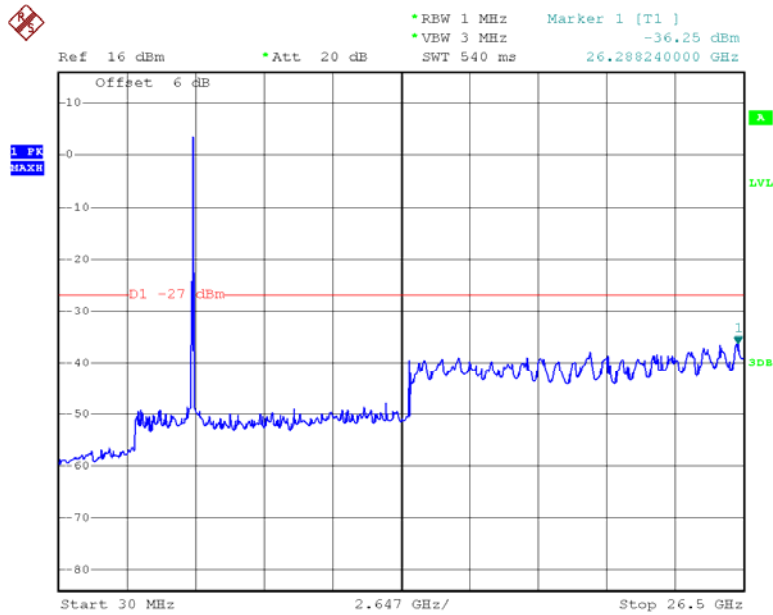

Date: 29.MAR.2013 14:04:15

### Chain 2: 802.11n40 High Channel 26.5-40G

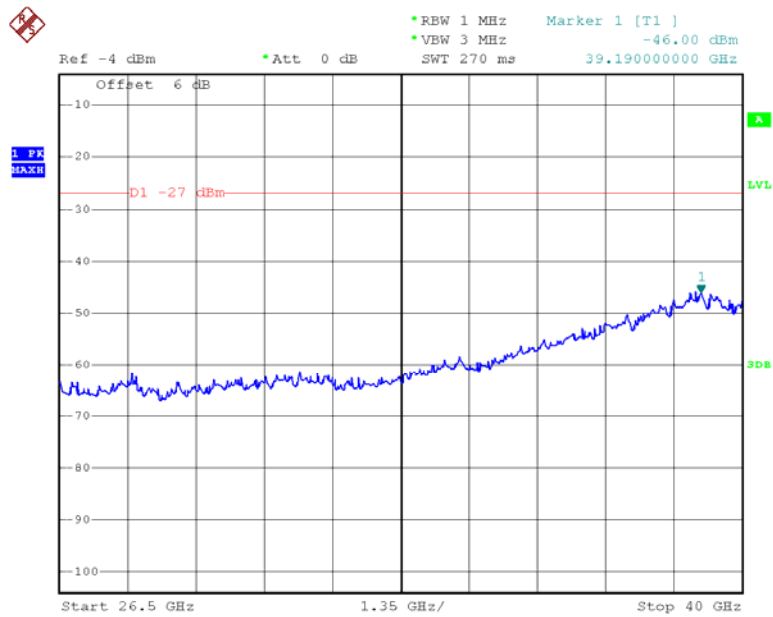

Date: 29.MAR.2013 14:03:23

## **FCC §15.407(b) (1) (2) (3) (4) – OUT OF BAND EMISSIONS**

### **Applicable Standard**

FCC §15.407 (b) (1),(2), (3), (4),;

For transmitters operating in the 5.15–5.25 GHz band: all emissions outside of the 5.15–5.35 GHz band shall not exceed an EIRP of –27 dBm/MHz.

For transmitters operating in the 5.25–5.35 GHz band: all emissions outside of the 5.15–5.35 GHz band shall not exceed an EIRP of –27 dBm/MHz. Devices operating in the 5.25–5.35 GHz band that generate emissions in the 5.15–5.25 GHz band must meet all applicable technical requirements for operation in the 5.15–5.25 GHz band (including indoor use) or alternatively meet an out-of-band emission EIRP limit of –27 dBm/MHz in the 5.15–5.25 GHz band.

For transmitters operating in the 5.47–5.725 GHz band: all emissions outside of the 5.47–5.725 GHz band shall not exceed an EIRP of –27 dBm/MHz.

For transmitters operating in the 5.725–5.825 GHz band: all emissions within the frequency range from the band edge to 10 MHz above or below the band edge shall not exceed an EIRP of –17 dBm/MHz; for frequencies 10 MHz or greater above or below the band edge, emissions shall not exceed an EIRP of –27 dBm/MHz.

### **Test Procedure**

1. Check the calibration of the measuring instrument using either an internal calibration or a known signal from an external generator.
2. Position the EUT without connection to measurement instrument. Turn on the EUT and connect its antenna terminal to measurement instrument via a low loss cable. Then set it to any one measured frequency within its operating range, and make sure the instrument is operated in its linear range.
3. Set RBW to 1 MHz and VBW to 3MHz of spectrum analyzer. Offset the antenna gain and cable loss.
4. Measure the highest amplitude appearing on spectral display and set it as a reference level. Plot the graph with marking the highest point and edge frequency.
5. Repeat above procedures until all measured frequencies were complete.

### **Test Equipment List and Details**

<b>Manufacturer</b>	<b>Description</b>	<b>Model</b>	<b>Serial Number</b>	<b>Calibration Date</b>	<b>Calibration Due Date</b>
Rohde & Schwarz	Spectrum Analyzer	FSP38	100478	2012-5-14	2013-5-13

\* Statement of Traceability: Bay Area Compliance Laboratories Corp. (Dongguan) attests that all calibrations have been performed in accordance to NVLAP requirements, traceable to National Primary Standards and International System of Units (SI).

**Test Data**

**Environmental Conditions**

<b>Temperature:</b>	25.5 °C
<b>Relative Humidity:</b>	56 %
<b>ATM Pressure:</b>	100.4 kPa

*The testing was performed by Leon Chen on 2013-03-28.*

Please refer to the following table and plots.

<b>Bandedge</b>	<b>Worst Reading Level (dBm)</b>	<b>Limit (dBm)</b>	<b>Result</b>
802.11a			
Left	-35.34	-27	PASS
Right	-54.65	-27	PASS
802.11n20 Chain 0			
Left	-40.94	-27	PASS
Right	-43.83	-27	PASS
802.11n20 Chain 1			
Left	-41.41	-27	PASS
Right	-44.03	-27	PASS
802.11n20 Chain 2			
Left	-41.34	-27	PASS
Right	-43.69	-27	PASS
802.11n20 Total:Chain 0+ Chain 1+ Chain 2			
Left	-36.45	-27	PASS
Right	-39.08	-27	PASS
802.11n40 Chain 0			
Left	-41.28	-27	PASS
Right	-43.36	-27	PASS
802.11n40 Chain 1			
Left	-40.84	-27	PASS
Right	-43.68	-27	PASS
802.11n40 Chain 2			
Left	-41.12	-27	PASS
Right	-43.66	-27	PASS
802.11n40 Total:Chain 0+ Chain 1+ Chain 2			
Left	-36.30	-27	PASS
Right	-38.79	-27	PASS

Note: the antenna gain is 5dBi, cable loss 1dB.

### 802.11a Left Bandedge

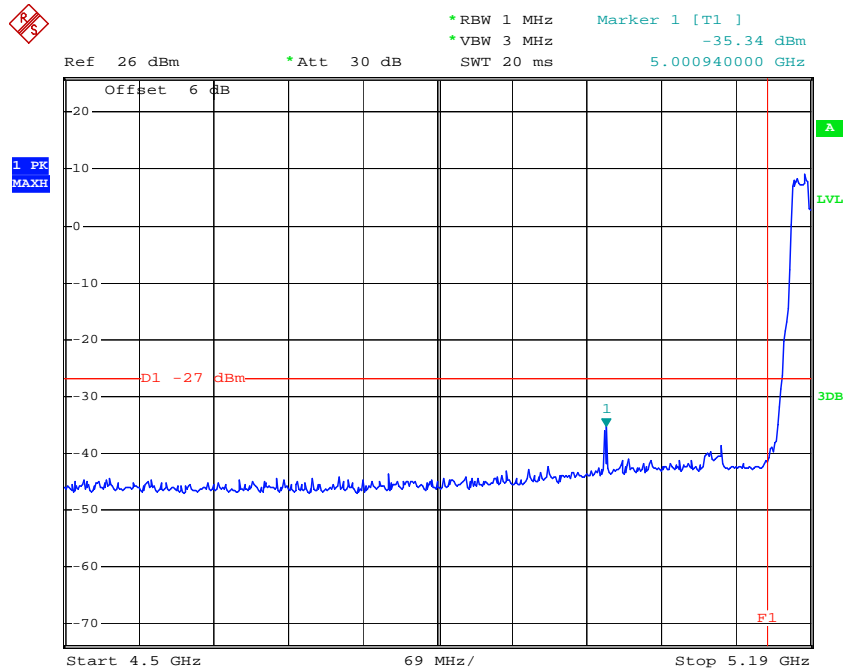

Date: 28.MAR.2013 13:45:06

### 802.11a Right Bandedge

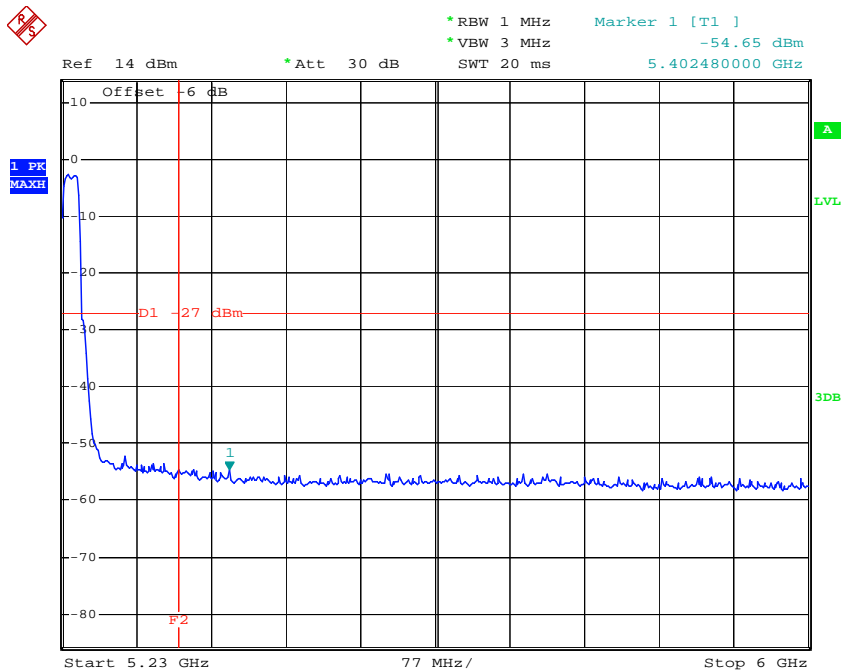

Date: 28.MAR.2013 13:52:30

v

### Chain 0:802.11n20 Left Bandedge

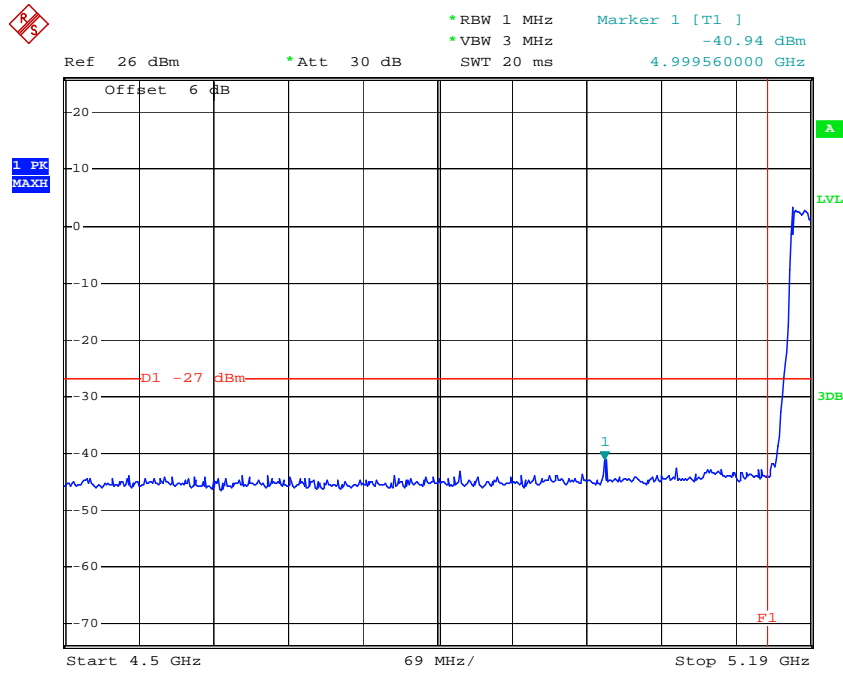

Date: 28.MAR.2013 15:22:54

### Chain 0:802.11n20 Right Bandedge

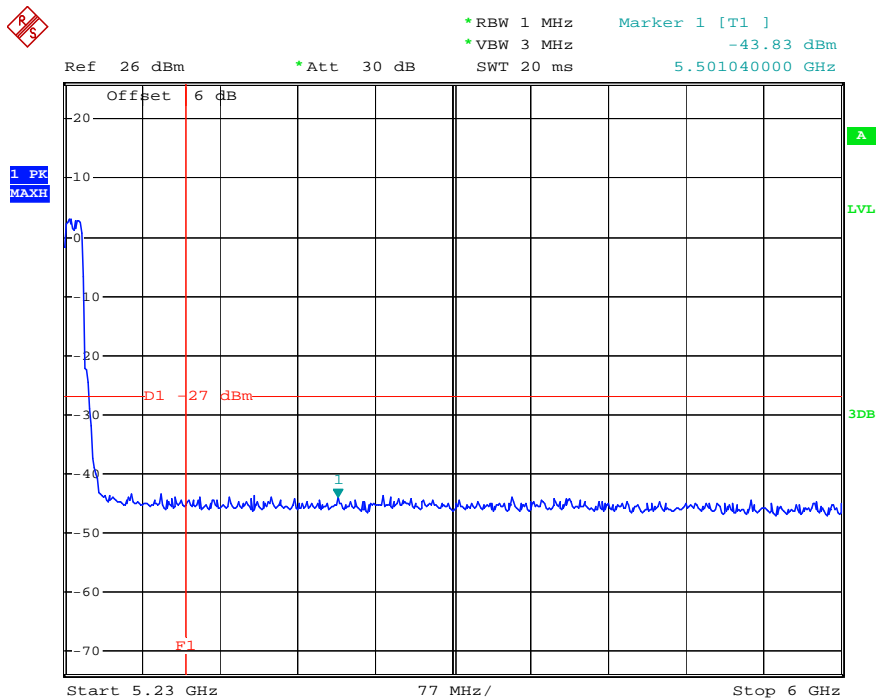

Date: 28.MAR.2013 15:33:46

### Chain 1:802.11n20 Left Bandedge

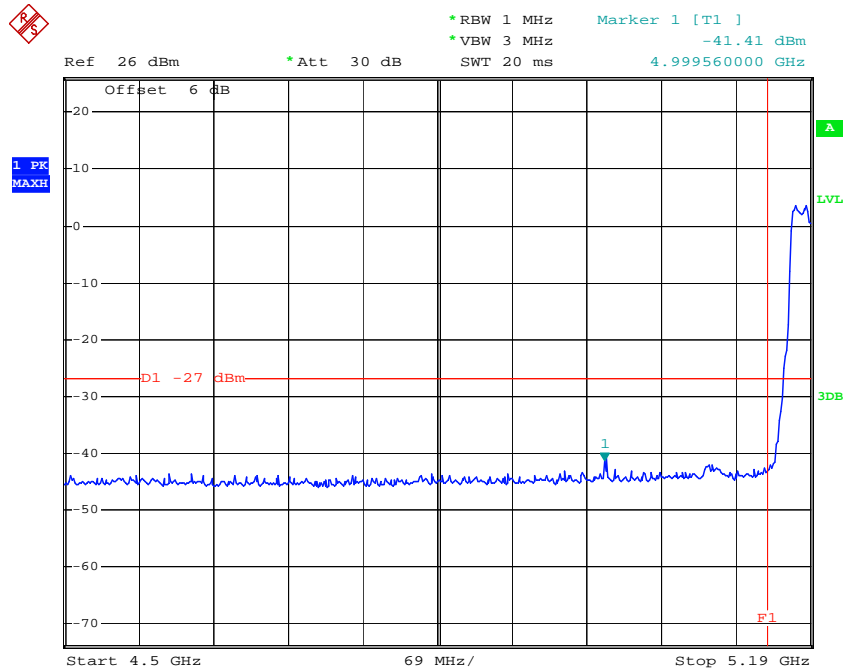

Date: 28.MAR.2013 15:23:52

### Chain 1:802.11n20 Right Bandedge

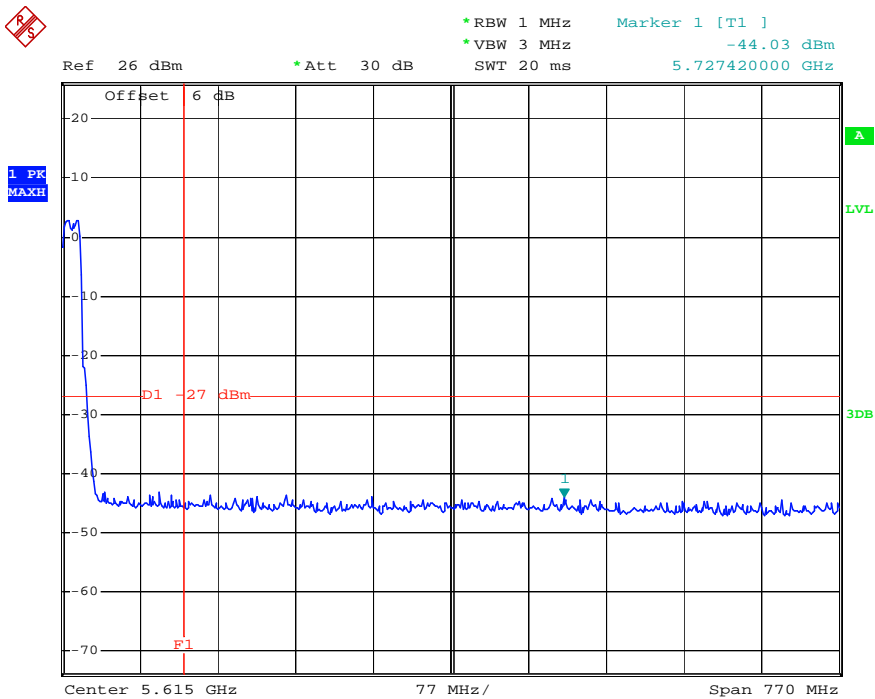

Date: 28.MAR.2013 15:34:22



### Chain 2:802.11n20 Left Bandedge

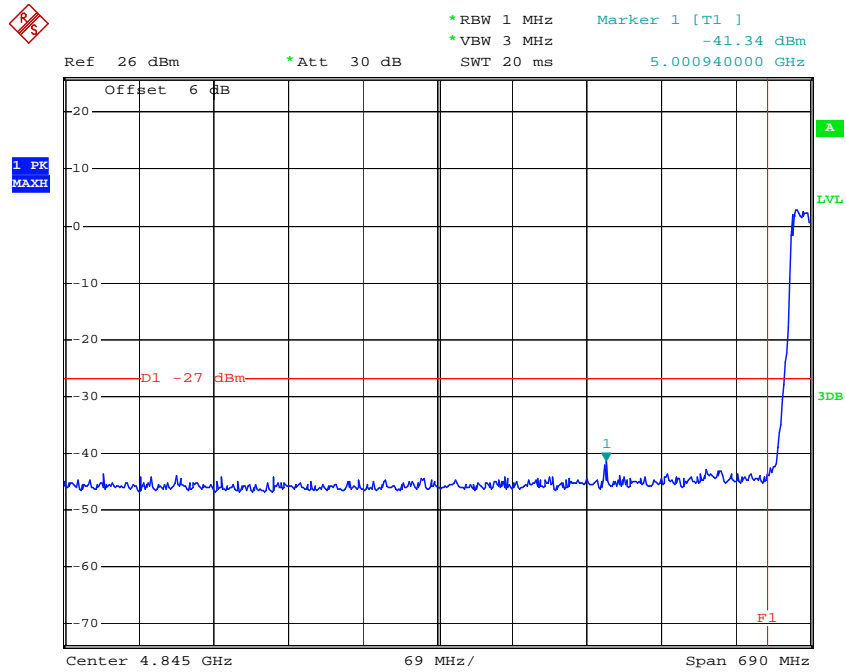

Date: 28.MAR.2013 15:24:29

### Chain 2:802.11n20 Right Bandedge

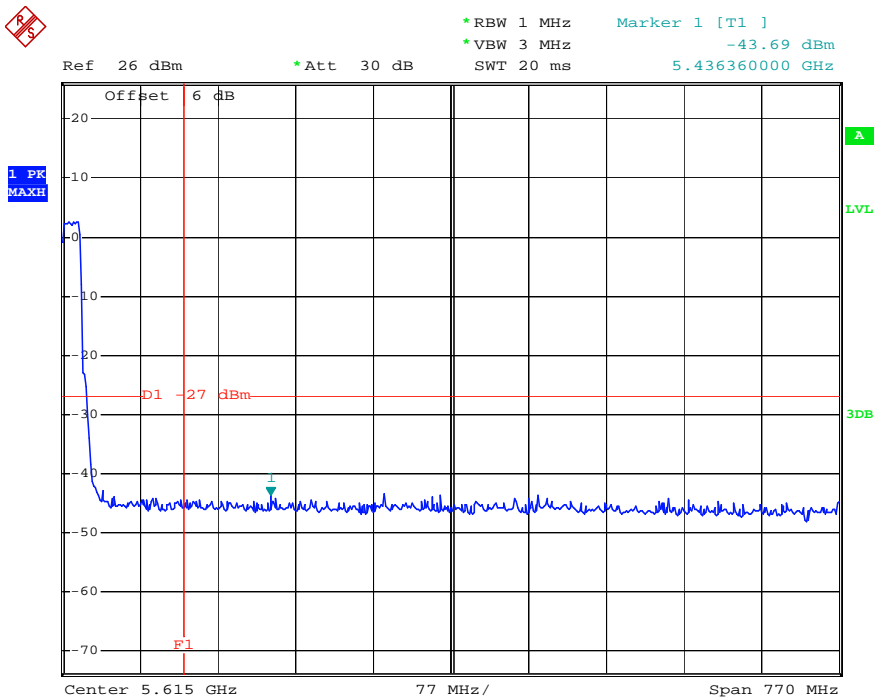

Date: 28.MAR.2013 15:34:57

### Chain 0:802.11n40 Left Bandedge

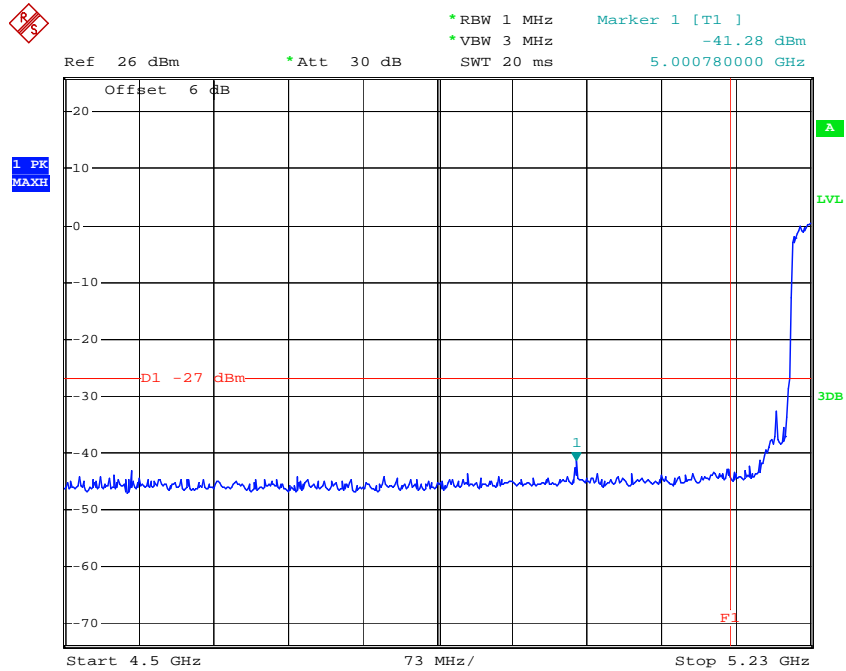

Date: 28.MAR.2013 16:02:52

### Chain 0:802.11n40 Right Bandedge

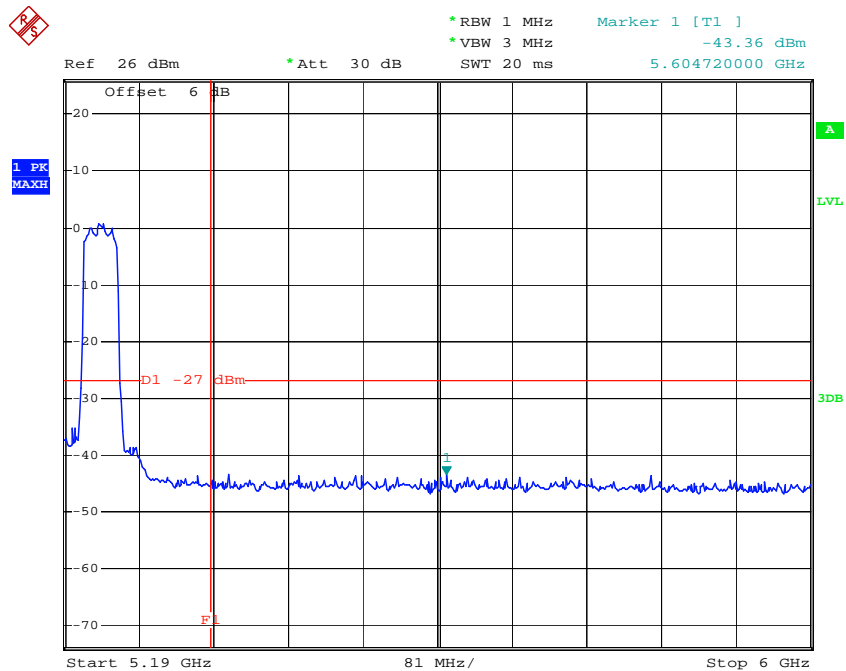

Date: 28.MAR.2013 16:00:13

### Chain 1:802.11n40 Left Bandedge

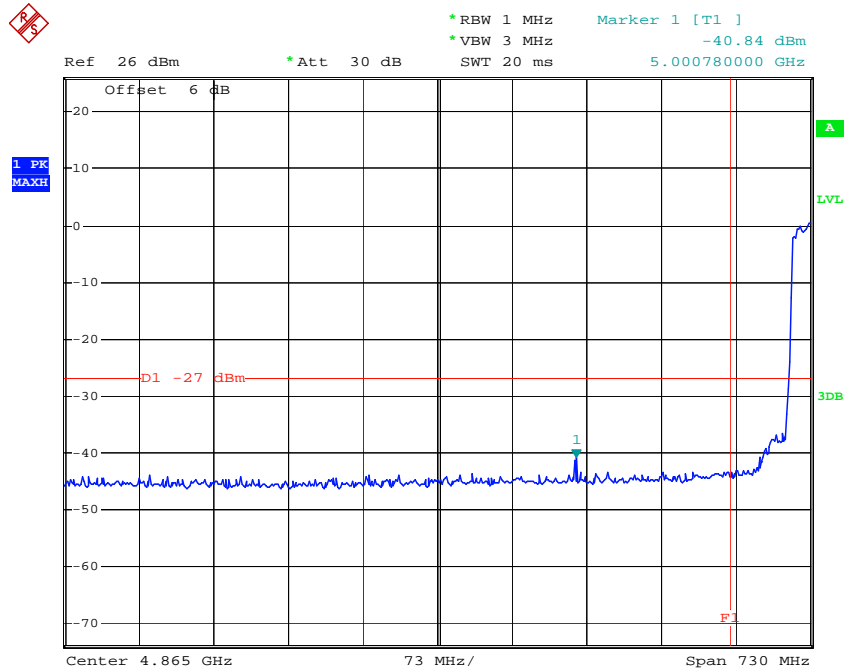

Date: 28.MAR.2013 16:03:20

### Chain 1:802.11n40 Right Bandedge

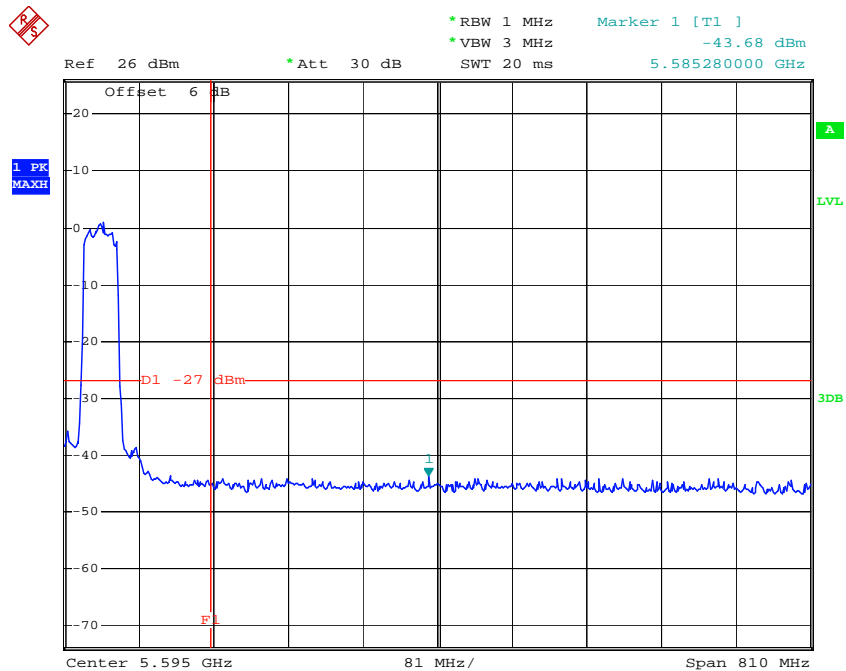

Date: 28.MAR.2013 16:01:02

### Chain 2:802.11n40 Left Bandedge

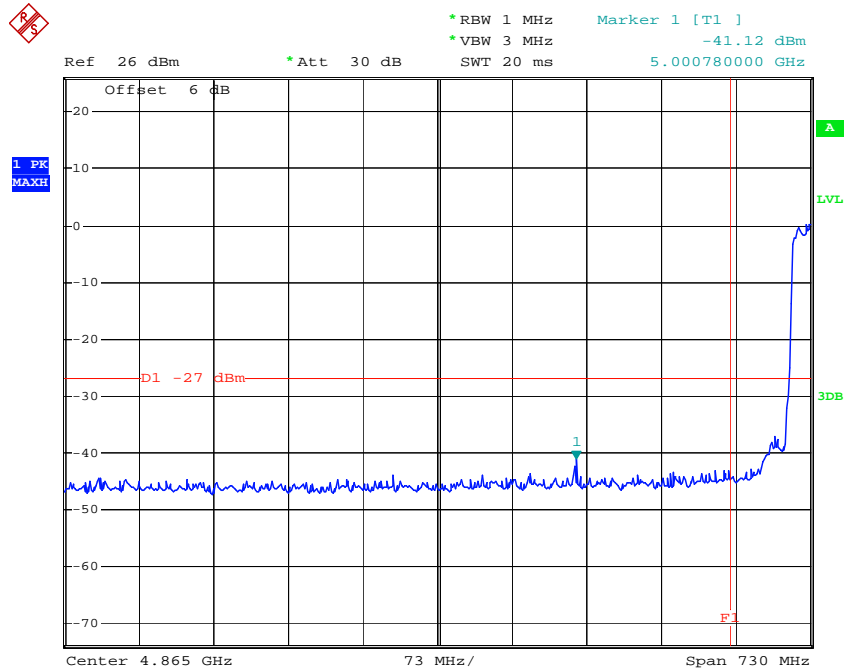

Date: 28.MAR.2013 16:03:47

### Chain 2:802.11n40 Right Bandedge

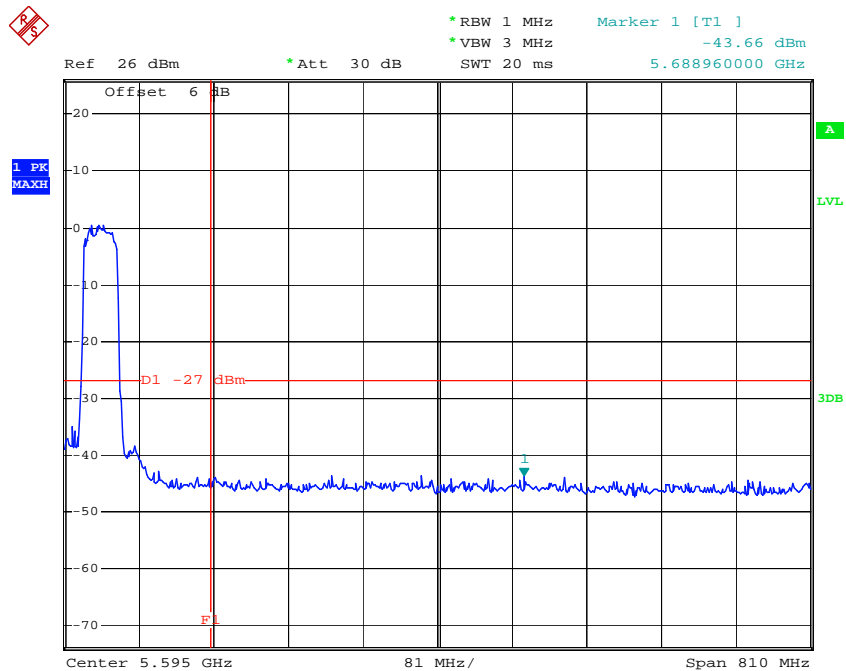

Date: 28.MAR.2013 16:01:53

**FCC §15.407(a) (1) – 26 dB OCCUPIED BANDWIDTH**

**Applicable Standard**

For the band 5.15–5.25 GHz, the maximum conducted output power over the frequency band of operation shall not exceed the lesser of 50 mW or 4 dBm + 10 log B, where B is the 26–dB emission bandwidth in MHz. In addition, the peak power spectral density shall not exceed 4 dBm in any 1–MHz band. If transmitting antennas of directional gain greater than 6 dBi are used, both the maximum conducted output power and the peak power spectral density shall be reduced by the amount in dB that the directional gain of the antenna exceeds 6 dBi.

**Test Equipment List and Details**

Manufacturer	Description	Model	Serial Number	Calibration Date	Calibration Due Date
Rohde & Schwarz	Spectrum Analyzer	FSP38	100478	2012-5-14	2013-5-13

\* Statement of Traceability: Bay Area Compliance Laboratories Corp. (Dongguan) attests that all calibrations have been performed in accordance to NVLAP requirements, traceable to National Primary Standards and International System of Units (SI).

**Test Procedure**

6. Check the calibration of the measuring instrument using either an internal calibrator or a known signal from an external generator.
7. Position the EUT without connection to measurement instrument. Turn on the EUT and connect it to measurement instrument. Then set it to any one convenient frequency within its operating range. Set a reference level on the measuring instrument equal to the highest peak value.
8. Use a RBW = approximately 1% of the emission bandwidth. Set the VBW > RBW. Use a peak detector. Do not use the Max Hold function. Rather, use the view button to capture the emission. Measure maximum width of the emission that is 26 dB down from the peak of the emission. Compare this with the RBW setting of the analyzer. Readjust RBW and repeat, measurement as needed until the RBW/EBW ratio is approximately 1%.
9. Repeat above procedures until all frequencies measured were complete.

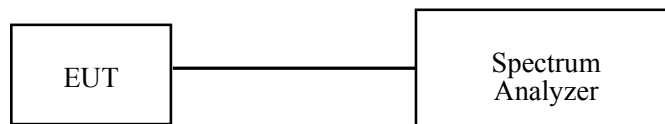

**Test Data**

**Environmental Conditions**

<b>Temperature:</b>	25.5 °C
<b>Relative Humidity:</b>	56 %
<b>ATM Pressure:</b>	100.4 kPa

The testing was performed by Leon Chen on 2013-03-28.

**Test Result:** Pass.

Please refer to the following tables and plots.

*Test mode: Transmitting*

Channel	Frequency	26 dB Bandwidth (MHz)
	(MHz)	
802.11a mode		
Low	5180	27.28
Middle	5200	26.96
High	5240	27.36
chain 0:802.11n20 mode		
Low	5180	27.28
Middle	5200	27.28
High	5240	27.28
chain 1:802.11n20 mode		
Low	5180	27.28
Middle	5200	27.28
High	5240	27.28
chain 2:802.11n20 mode		
Low	5180	27.28
Middle	5200	27.28
High	5240	27.28
chain 0:802.11n40 mode		
Low	5190	40.48
High	5230	40.48
Chain1:802.11n40 mode		
Low	5190	40.48
High	5230	40.48
Chain2:802.11n40 mode		
Low	5190	40.48
High	5230	40.48

### 802.11a Low Channel

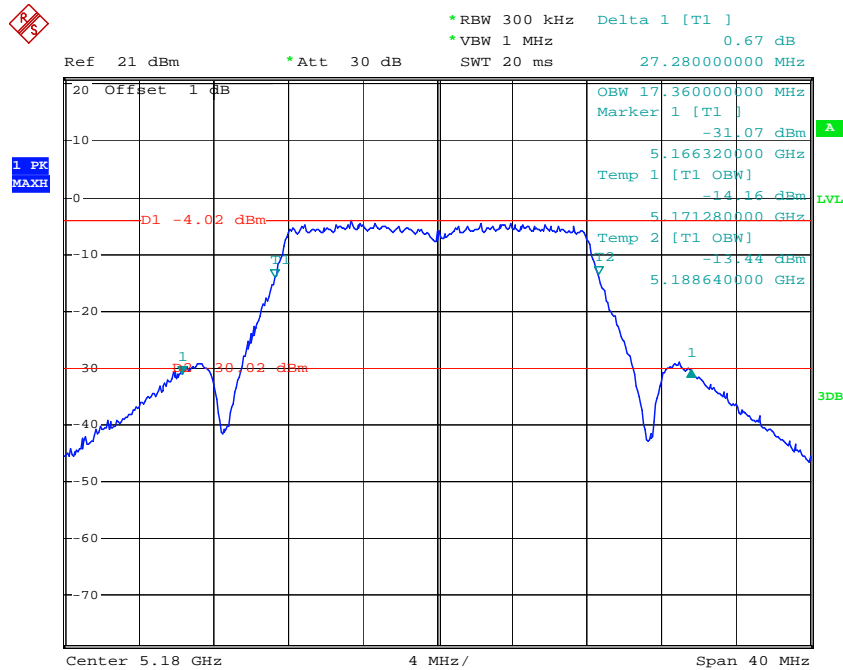

Date: 28.MAR.2013 13:00:08

### 802.11a Middle Channel

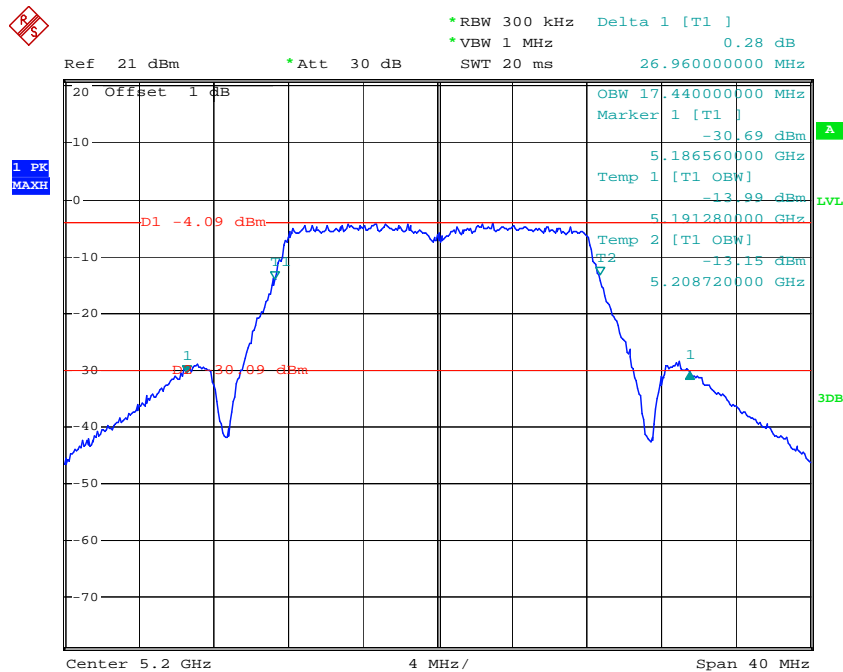

Date: 28.MAR.2013 12:58:20

### 802.11a High Channel

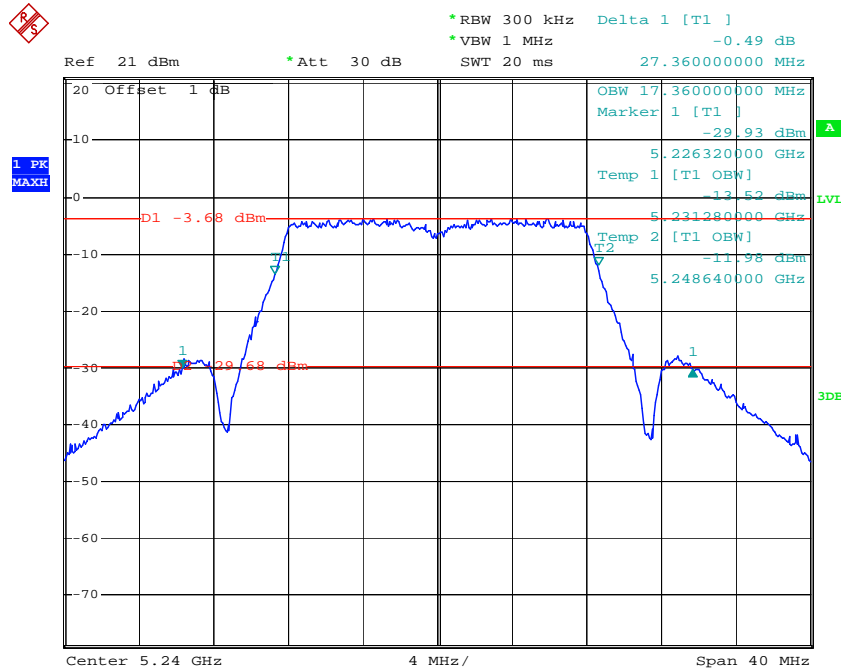

Date: 28.MAR.2013 13:02:50

### Chain 0:802.11n20 Low Channel

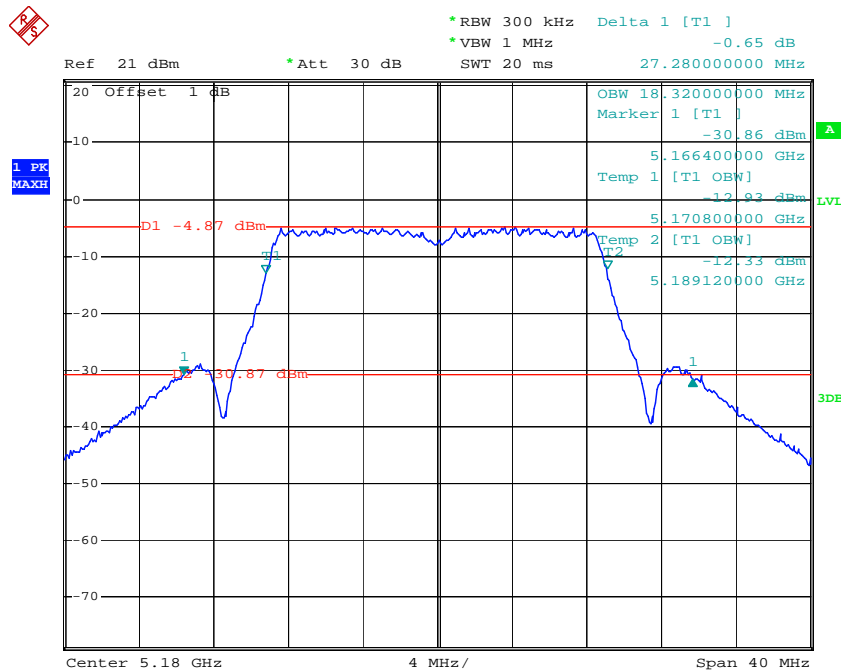

Date: 28.MAR.2013 13:55:30



**Chain 0:802.11n20 Middle Channel**

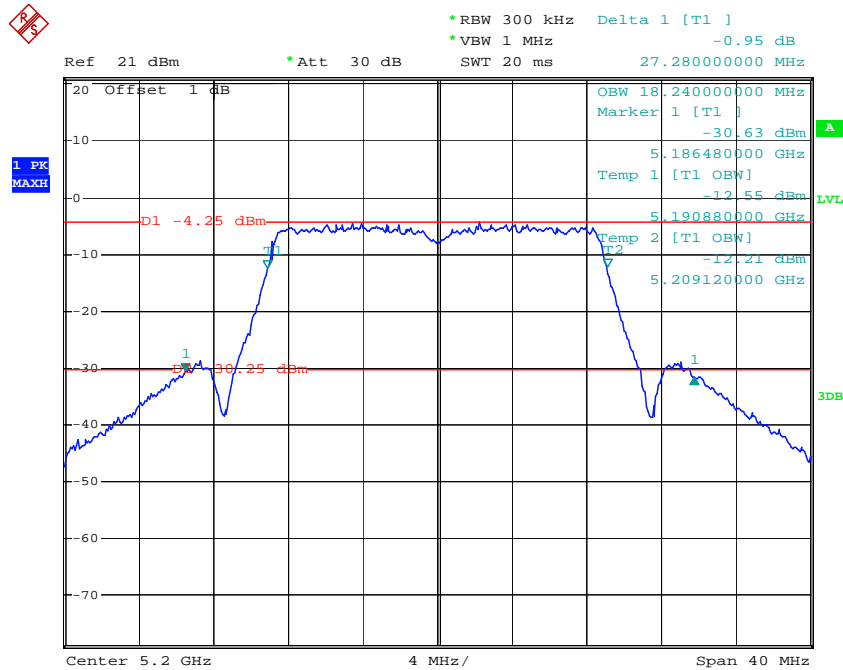

Date: 28.MAR.2013 14:00:14

**Chain 0:802.11n20 High Channel**

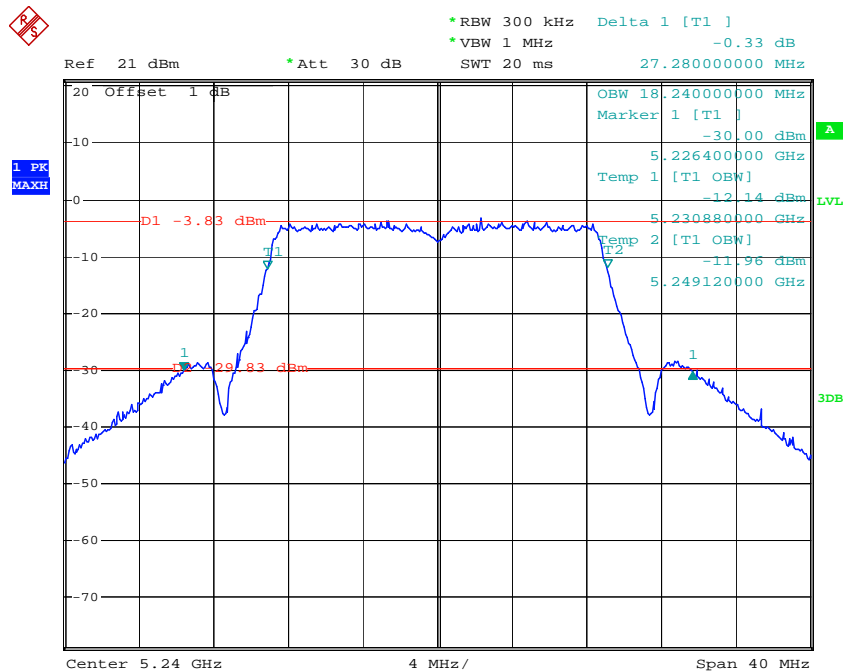

Date: 28.MAR.2013 14:04:33

**Chain 1:802.11n20 Low Channel**

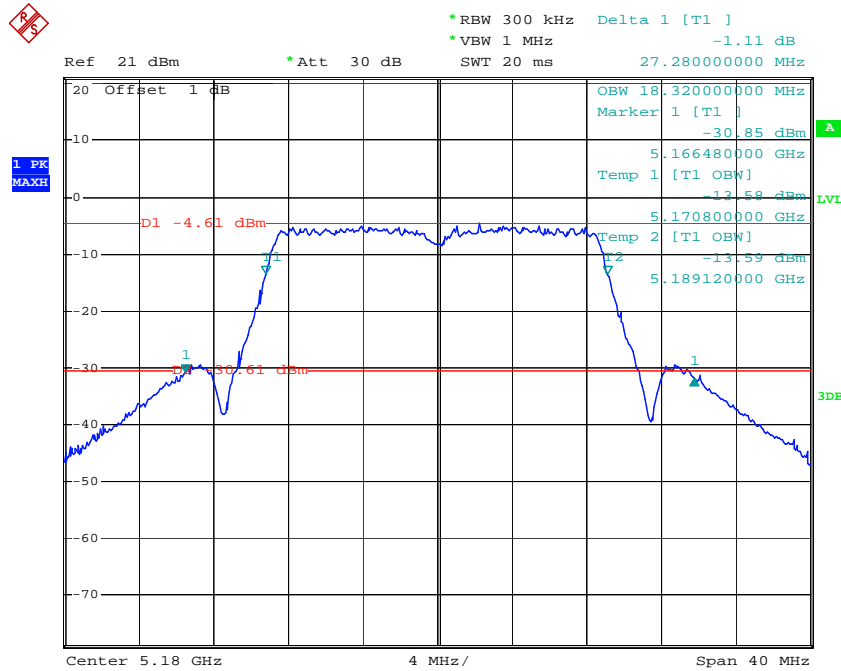

Date: 28.MAR.2013 13:57:10

**Chain 1:802.11n20 Middle Channel**

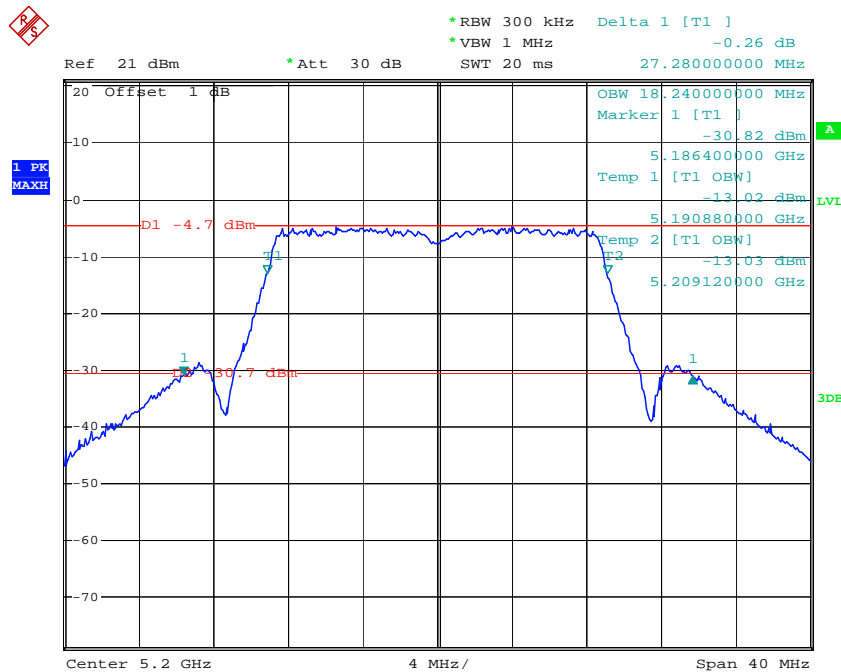

Date: 28.MAR.2013 14:02:16

### Chain 1:802.11n20 High Channel

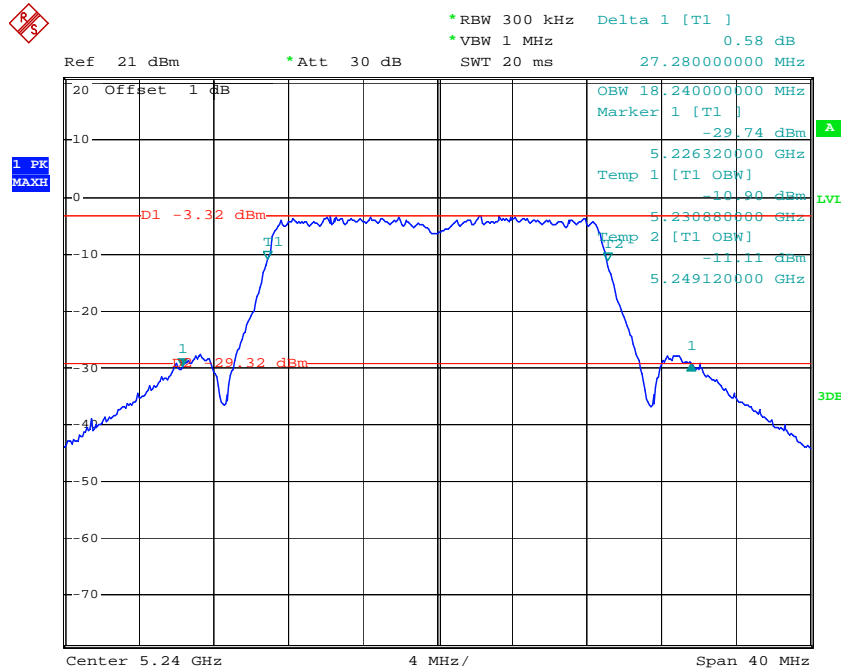

Date: 28.MAR.2013 14:32:54

### Chain 2:802.11n20 Low Channel

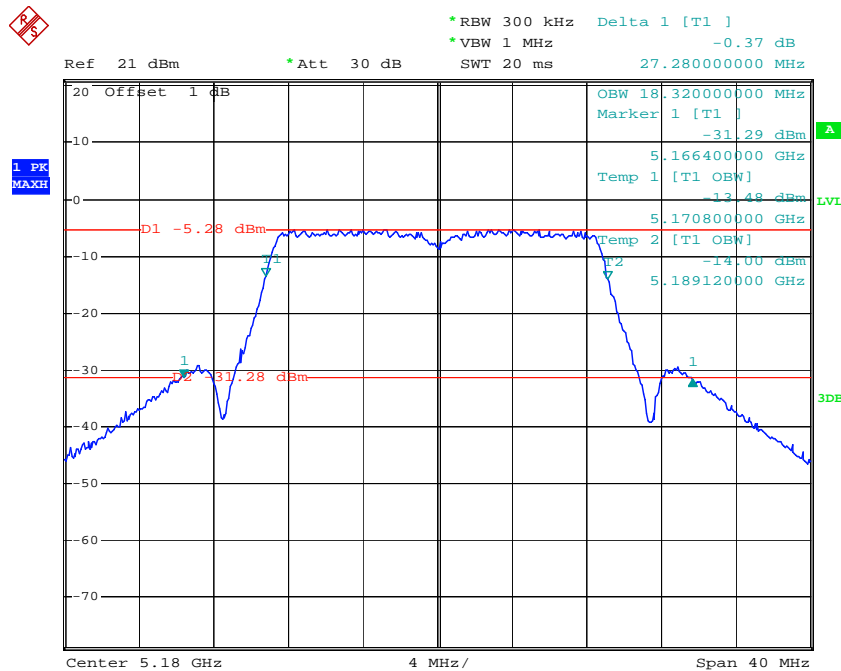

Date: 28.MAR.2013 13:58:30

**Chain 2:802.11n20 Middle Channel**

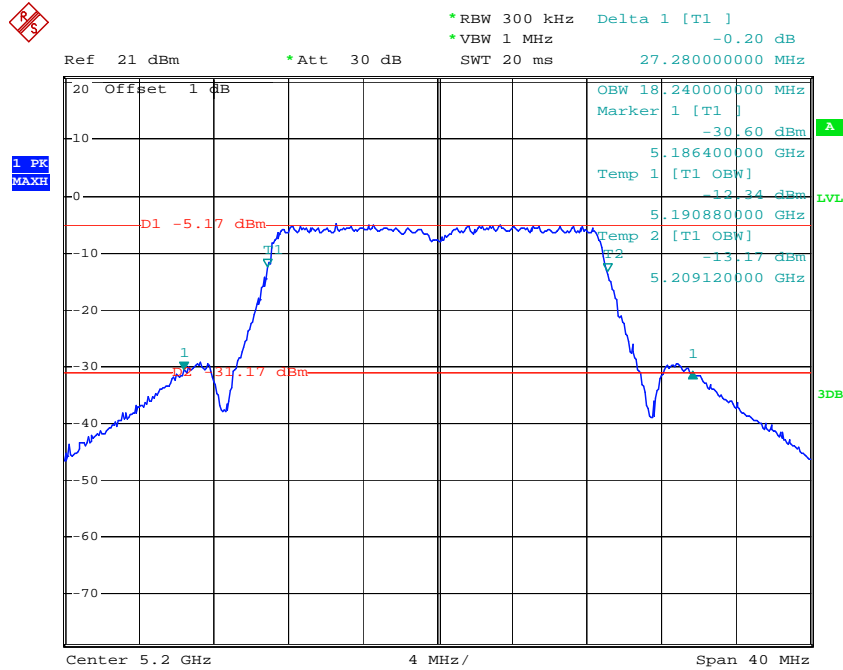

Date: 28.MAR.2013 14:03:19

**Chain 2:802.11n20 High Channel**

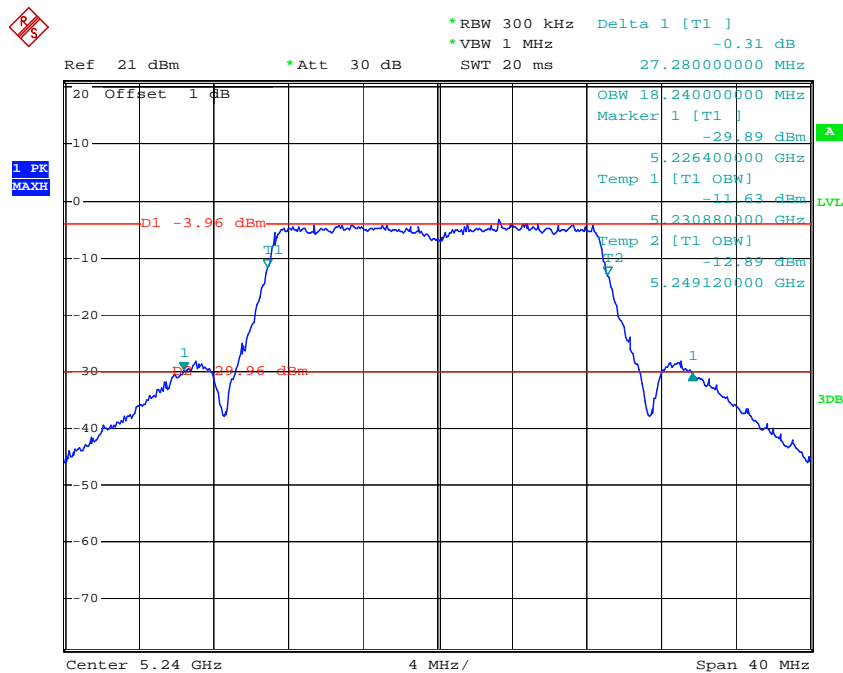

Date: 28.MAR.2013 14:34:14

**Chain 0:802.11n40 Low Channel**

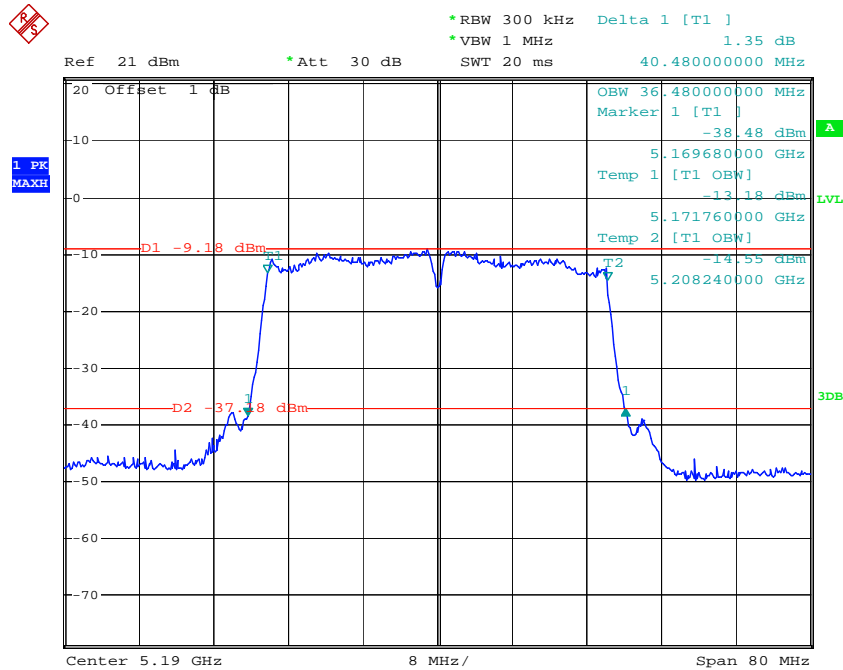

Date: 28.MAR.2013 15:40:19

**Chain 0:802.11n40 High Channel**

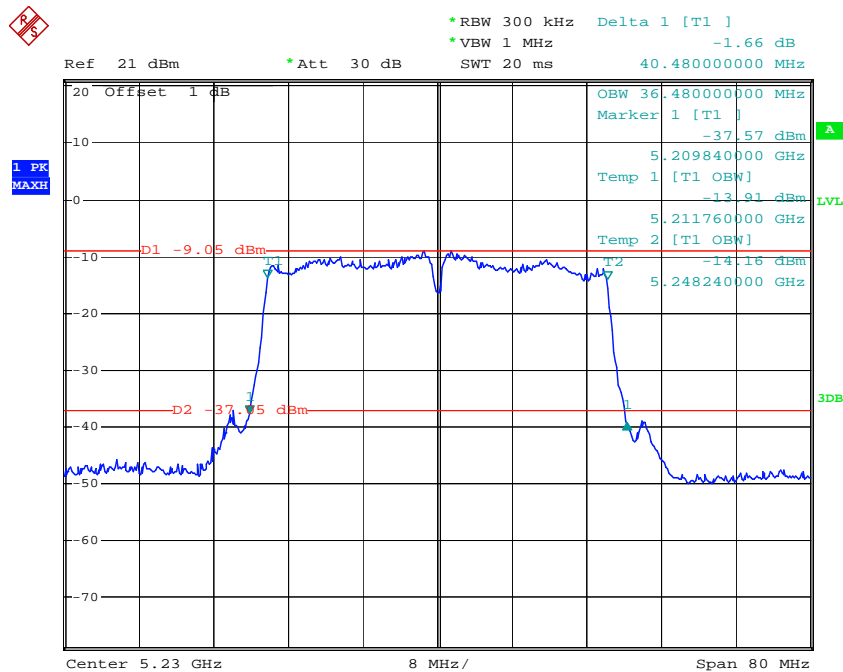

Date: 28.MAR.2013 15:43:20

### Chain 1:802.11n40 Low Channel

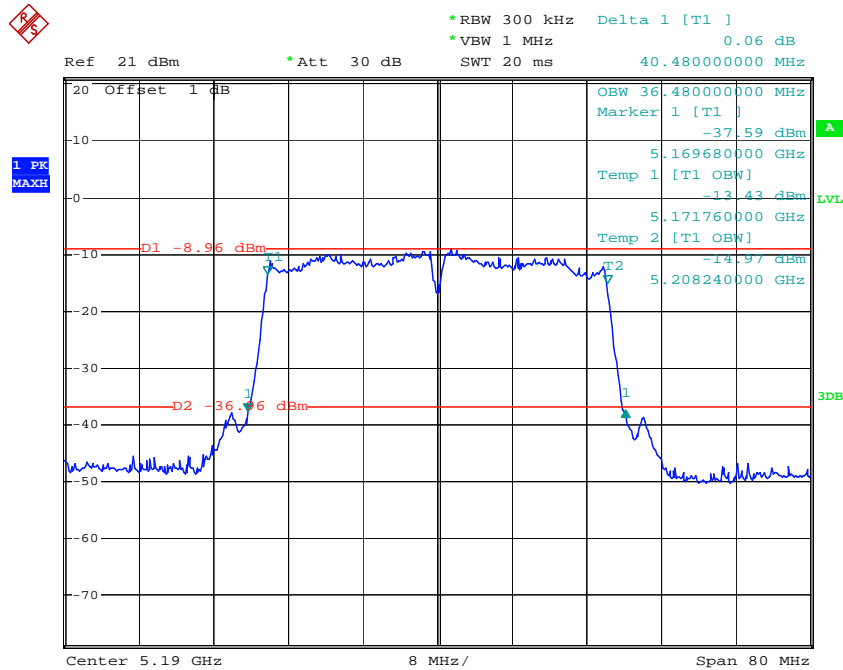

Date: 28.MAR.2013 15:44:57

### Chain 1:802.11n40 High Channel

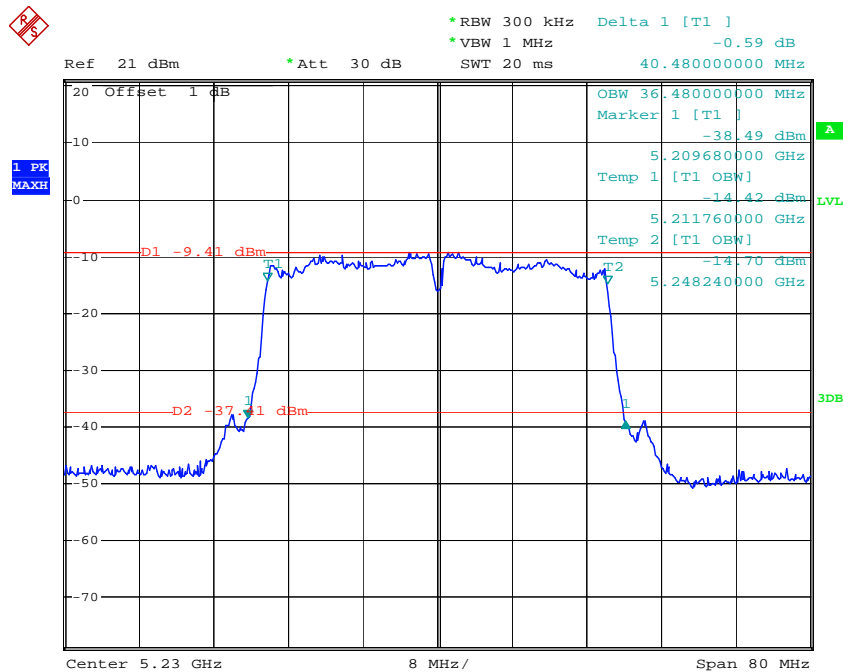

Date: 28.MAR.2013 15:46:48

### Chain 2:802.11n40 Low Channel

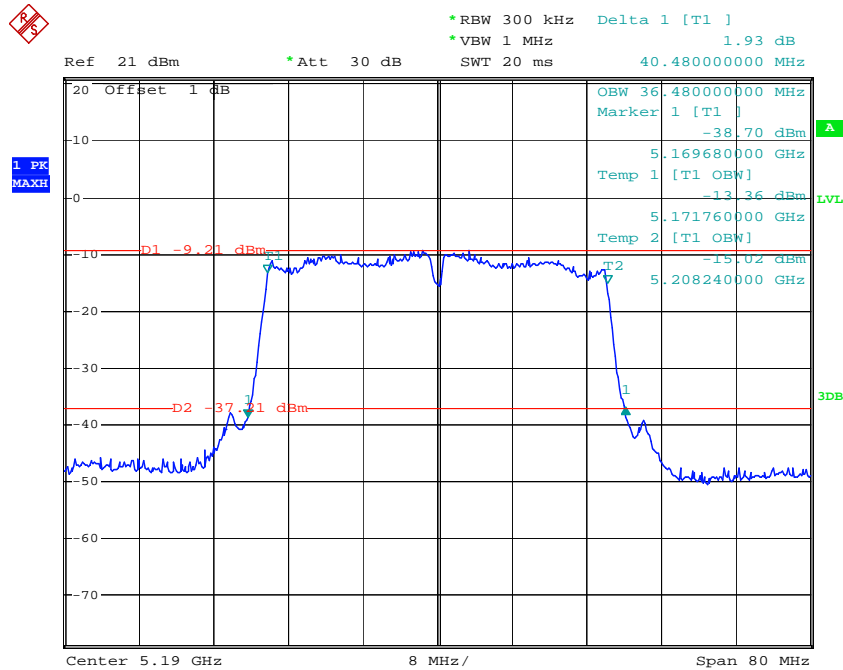

Date: 28.MAR.2013 15:48:14

### Chain 2:802.11n40 High Channel

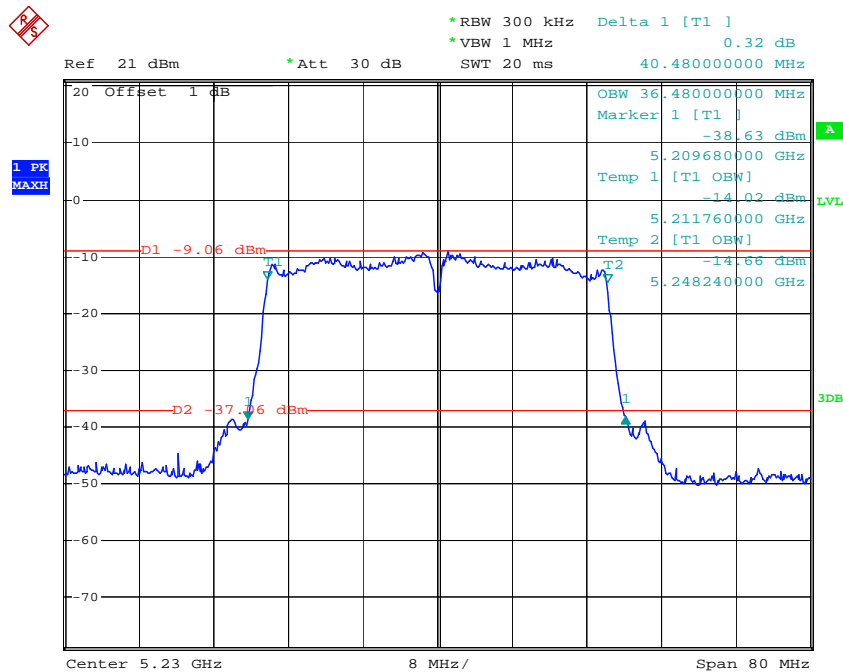

Date: 28.MAR.2013 15:49:15

## **FCC §15.407(a) (1) – CONDUCTED TRANSMITTER OUTPUT POWER**

### **Applicable Standard**

For the band 5.15–5.25 GHz, the maximum conducted output power over the frequency band of operation shall not exceed the lesser of 50 mW or  $4 \text{ dBm} + 10 \log B$ , where B is the 26-dB emission bandwidth in MHz. In addition, the peak power spectral density shall not exceed 4 dBm in any 1-MHz band. If transmitting antennas of directional gain greater than 6 dBi are used, both the maximum conducted output power and the peak power spectral density shall be reduced by the amount in dB that the directional gain of the antenna exceeds 6 dBi.

### **Test Equipment List and Details**

<b>Manufacturer</b>	<b>Description</b>	<b>Model</b>	<b>Serial Number</b>	<b>Calibration Date</b>	<b>Calibration Due Date</b>
Rohde & Schwarz	Spectrum Analyzer	FSP38	100478	2012-5-14	2013-5-13

\* Statement of Traceability: Bay Area Compliance Laboratories Corp. (Dongguan) attests that all calibrations have been performed in accordance to NVLAP requirements, traceable to National Primary Standards and International System of Units (SI).

### **Test Procedure**

1. Check the calibration of the measuring instrument using either an internal calibrator or a known signal from an external generator.
2. Position the EUT was set without connection to measurement instrument. Turn on the EUT and connect its antenna terminal to measurement instrument via a low loss cable. Then set it to any one measured frequency within its operating range, and make sure the instrument is operated in its linear range.
3. Set span to encompass the entire emission bandwidth (EBW) of the signal. Set RBW = 1 MHz. Set VBW  $\geq$  3 MHz. Use sample detector mode Use a video trigger with the trigger level set to enable triggering only on full power pulses. Transmitter must operate at full control power for entire sweep of every sweep. If the device transmits continuously, with no off intervals or reduced power intervals, the trigger may be set to “free run”. Trace average 100 traces in power averaging mode. Compute power by integrating the spectrum across the 26 dB EBW of the signal. The integration can be performed using the spectrum analyzer’s band power measurement function with band limits set equal to the EBW band edges or by summing power levels in each 1 MHz band in linear power terms. The 1 MHz band power levels to be summed can be obtained by averaging, in linear power terms, power levels in each frequency bin across the 1 MHz.
4. Repeat above procedures until all frequencies measured were complete.



**Test Data**

**Environmental Conditions**

<b>Temperature:</b>	25.5 °C
<b>Relative Humidity:</b>	56 %
<b>ATM Pressure:</b>	100.4 kPa

*The testing was performed by Leon Chen on 2013-03-28.*

*Test Mode: Transmitting*

Channel	Frequency	Conducted Output Power	Limit	Result
	(MHz)	(dBm)	(dBm)	
802.11a mode				
Low	5180	13.38	17	PASS
Middle	5200	14.17	17	PASS
High	5240	13.67	17	PASS
chain 0:802.11n20 mode				
Low	5180	8.12	17	PASS
Middle	5200	7.94	17	PASS
High	5240	7.92	17	PASS
chain 1:802.11n20 mode				
Low	5180	8.09	17	PASS
Middle	5200	7.83	17	PASS
High	5240	7.74	17	PASS
chain 2:802.11n20 mode				
Low	5180	8.16	17	PASS
Middle	5200	7.73	17	PASS
High	5240	7.68	17	PASS
chain 0:802.11n40 mode				
Low	5190	7.38	17	PASS
High	5230	7.53	17	PASS
chain 1:802.11n40 mode				
Low	5190	7.48	17	PASS
High	5230	7.46	17	PASS
chain 2:802.11n40 mode				
Low	5190	7.60	17	PASS
High	5230	7.29	17	PASS

*Total power of 802.11n: chain 0+ chain 1+chain 2*

Channel	Frequency	Conducted Output Power	Limit	Result
	(MHz)	(dBm)	(dBm)	
Total:802.11n20 mode				
Low	5180	12.89	17	PASS
Middle	5200	12.61	17	PASS
High	5240	12.55	17	PASS
Total:802.11n40 mode				
Low	5190	12.26	17	PASS
High	5230	12.20	17	PASS

### 802.11a RF Output Power, Low Channel

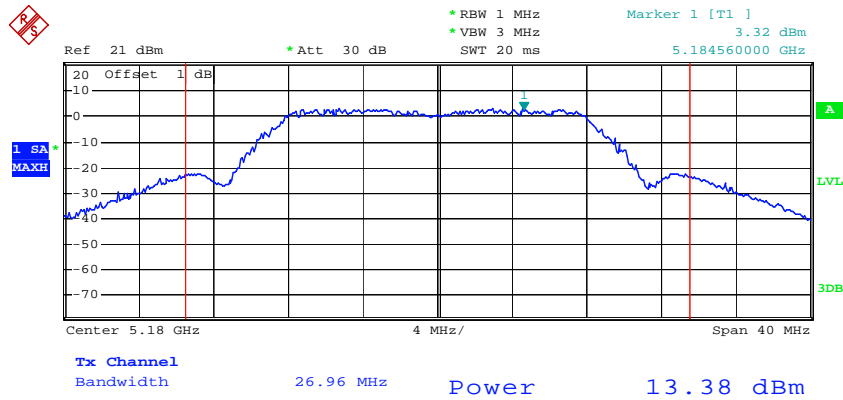

Date: 28.MAR.2013 13:48:06

### 802.11a RF Output Power, Middle Channel

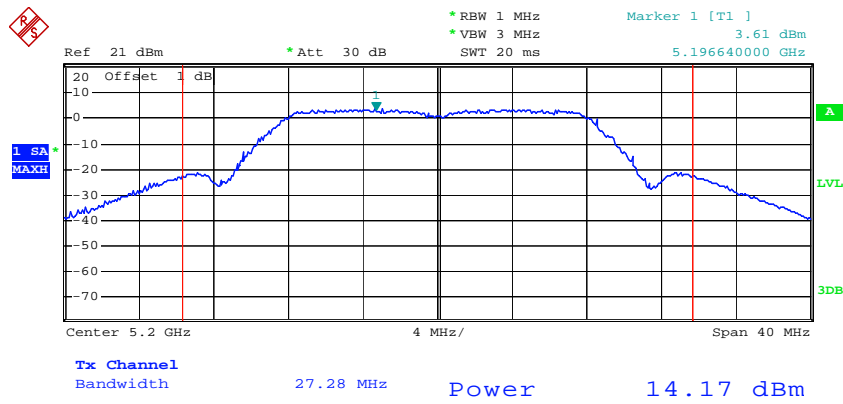

Date: 28.MAR.2013 13:39:05

### 802.11a RF Output Power, High Channel

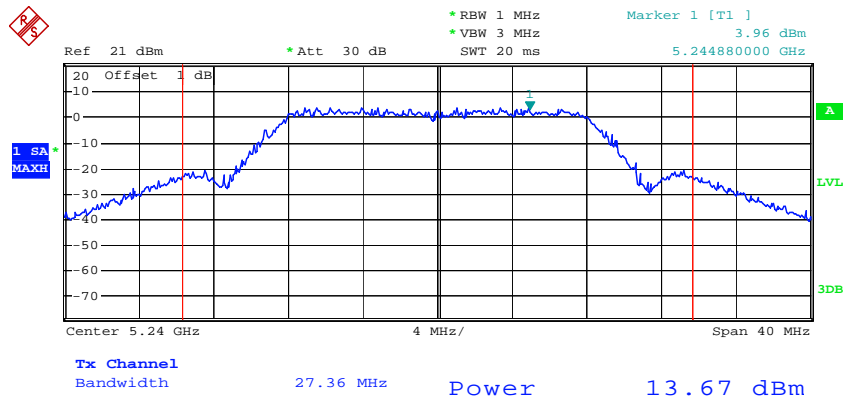

Date: 28.MAR.2013 13:49:33

### Chain 0:802.11n20 RF Output Power, Low Channel

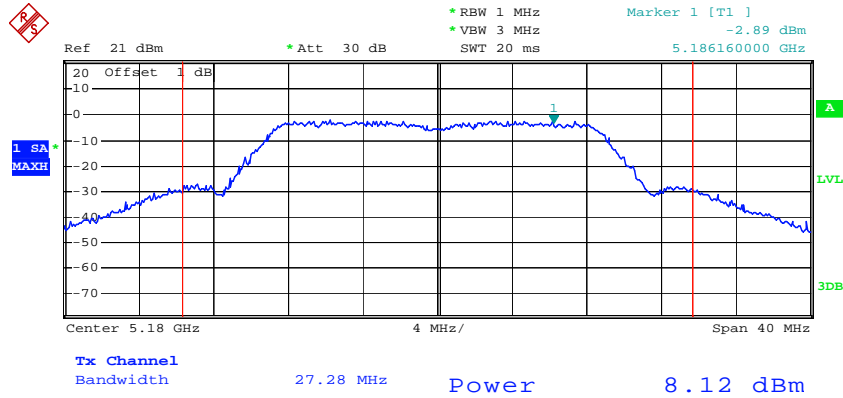

Date: 28.MAR.2013 15:09:04

### Chain 0:802.11n20 RF Output Power, Middle Channel

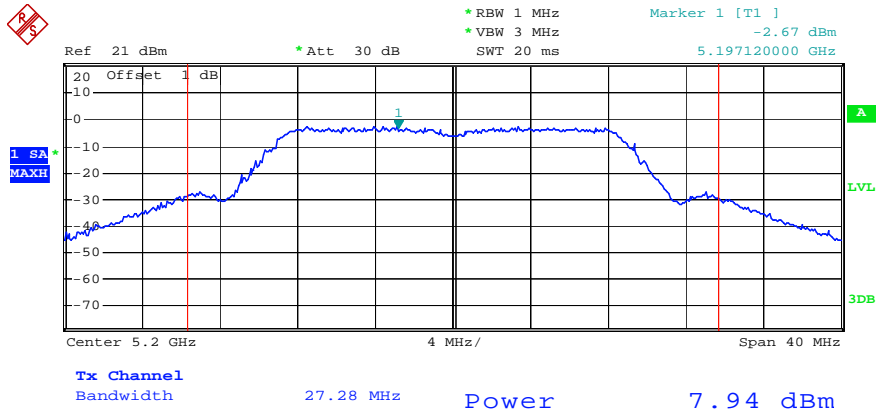

Date: 28.MAR.2013 15:32:40

### Chain 0:802.11n20 RF Output Power, High Channel

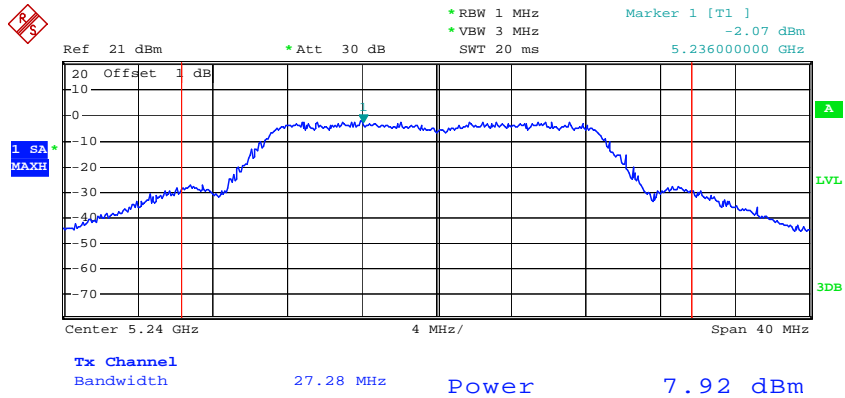

Date: 28.MAR.2013 14:51:34

### Chain 1:802.11n20 RF Output Power, Low Channel

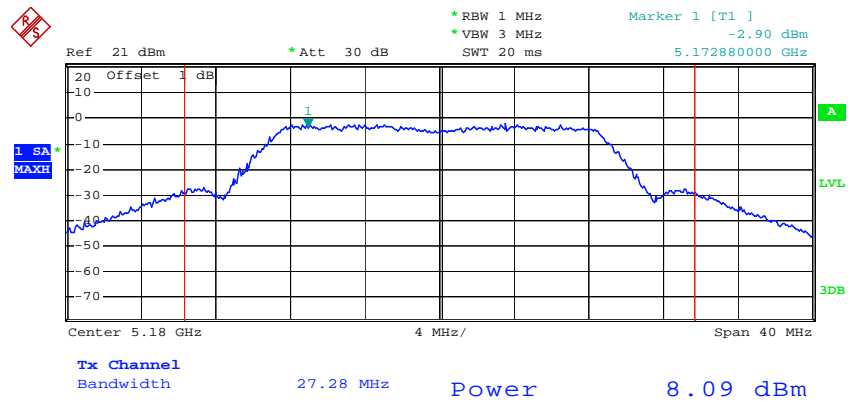

Date: 28.MAR.2013 15:09:55

### Chain 1:802.11n20 RF Output Power, Middle Channel

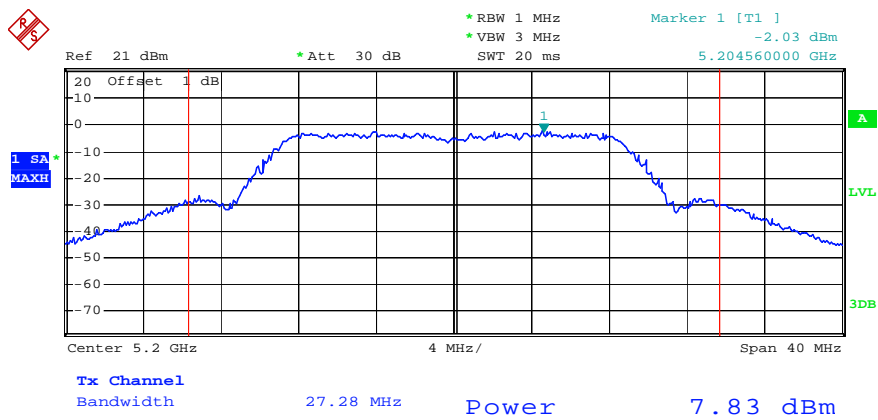

Date: 28.MAR.2013 15:31:46

**Chain 1:802.11n20 RF Output Power, High Channel**

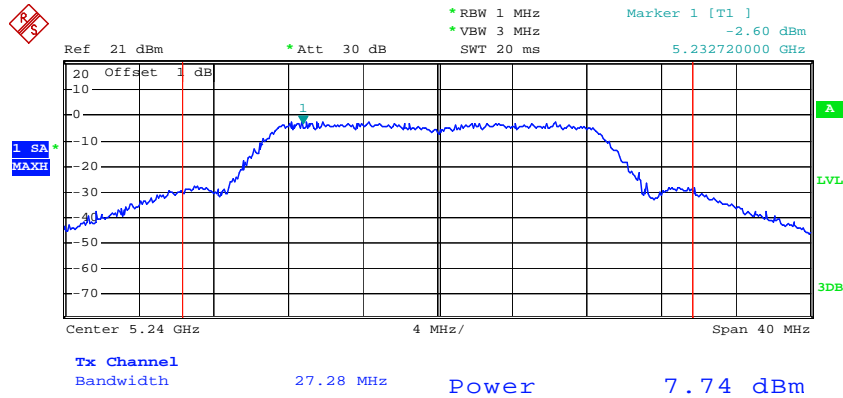

Date: 28.MAR.2013 14:53:01

**Chain 2:802.11n20 RF Output Power, Low Channel**

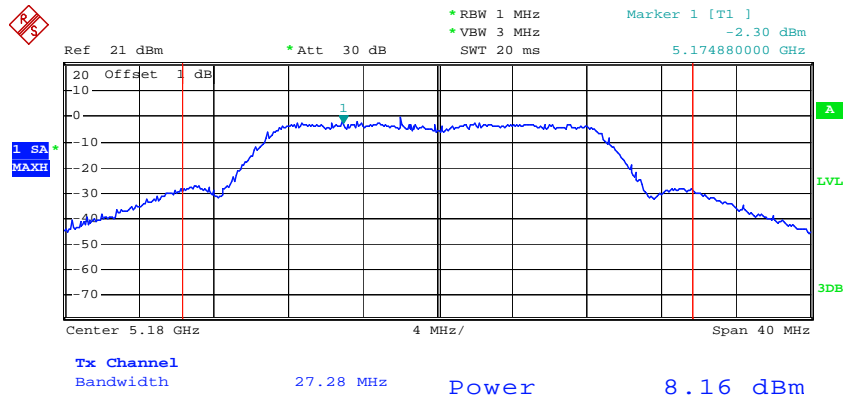

Date: 28.MAR.2013 15:10:51

**Chain 2:802.11n20 RF Output Power, Middle Channel**

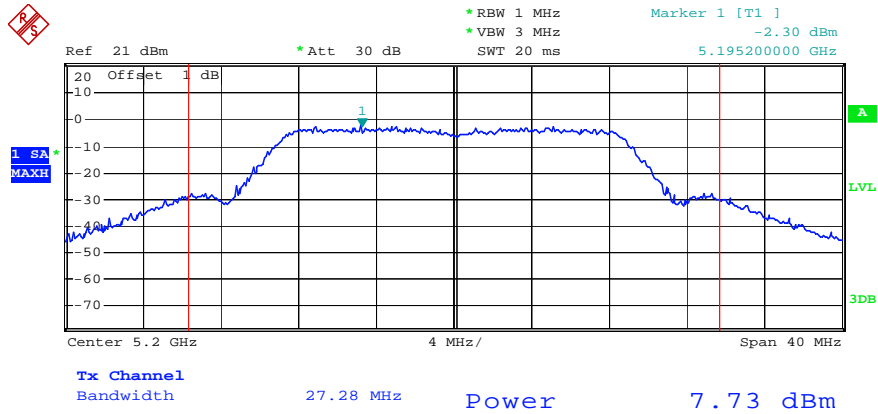

Date: 28.MAR.2013 15:31:07

**Chain 2:802.11n20 RF Output Power, High Channel**

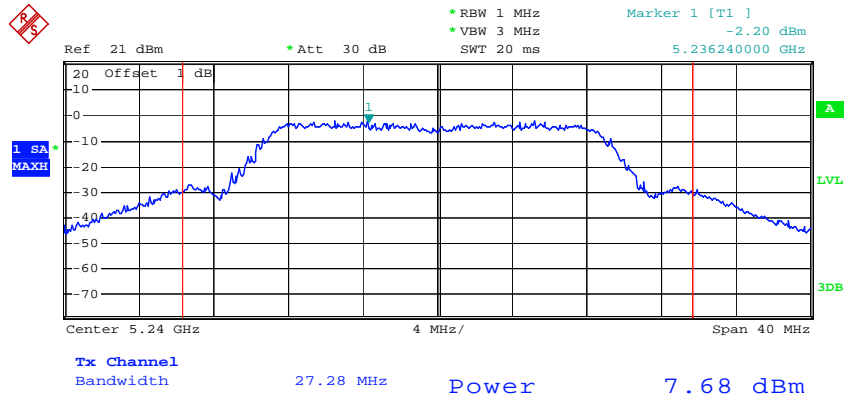

Date: 28.MAR.2013 14:54:22



**Chain 0:802.11n40 RF Output Power, Low Channel**

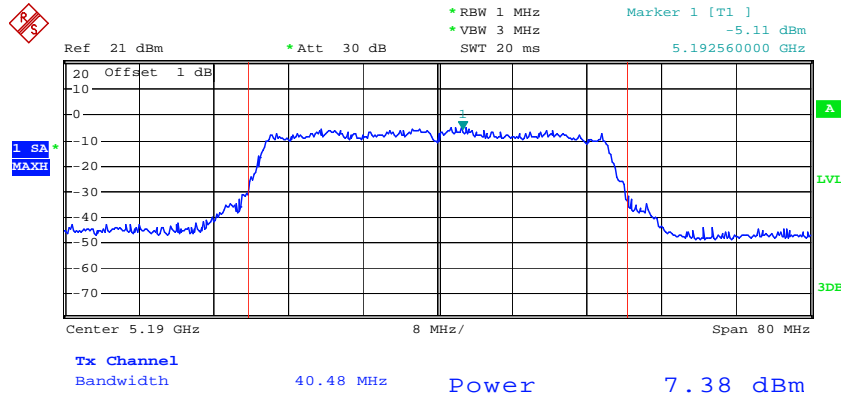

Date: 28.MAR.2013 16:13:57

**Chain 0:802.11n40 RF Output Power, High Channel**

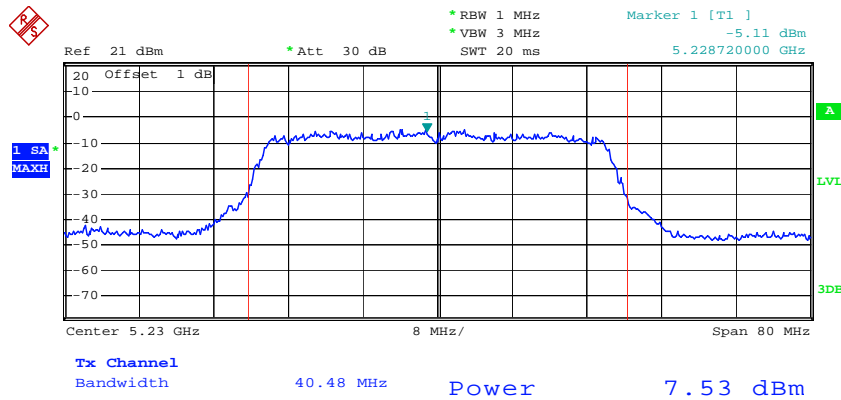

Date: 28.MAR.2013 15:50:39

### Chain 1:802.11n40 RF Output Power, Low Channel

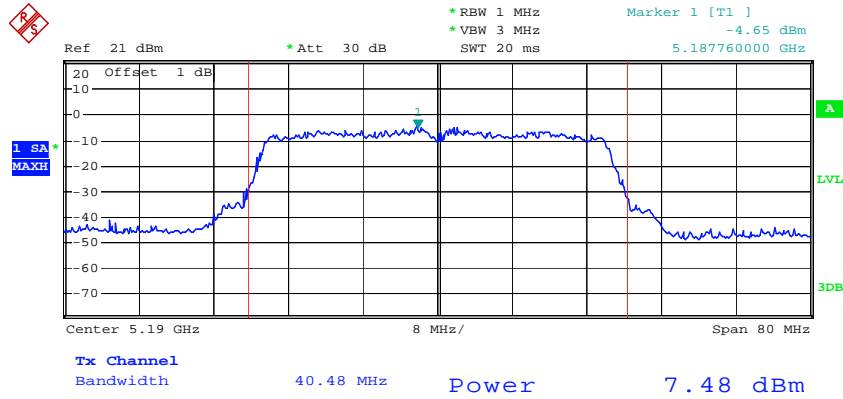

Date: 28.MAR.2013 16:17:00

### Chain 1:802.11n40 RF Output Power, High Channel

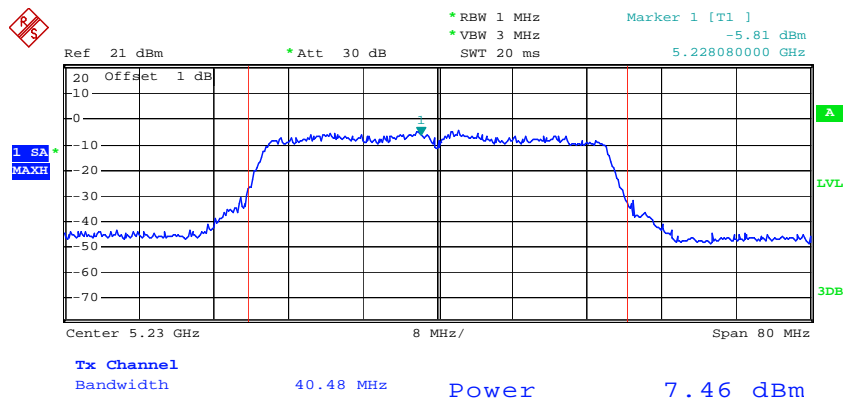

Date: 28.MAR.2013 15:54:46

### Chain 2:802.11n40 RF Output Power, Low Channel

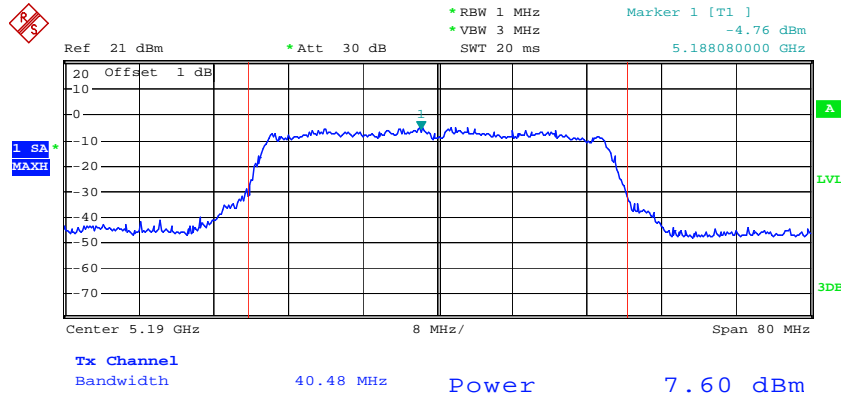

Date: 28.MAR.2013 16:19:43

### Chain 2:802.11n40 RF Output Power, High Channel

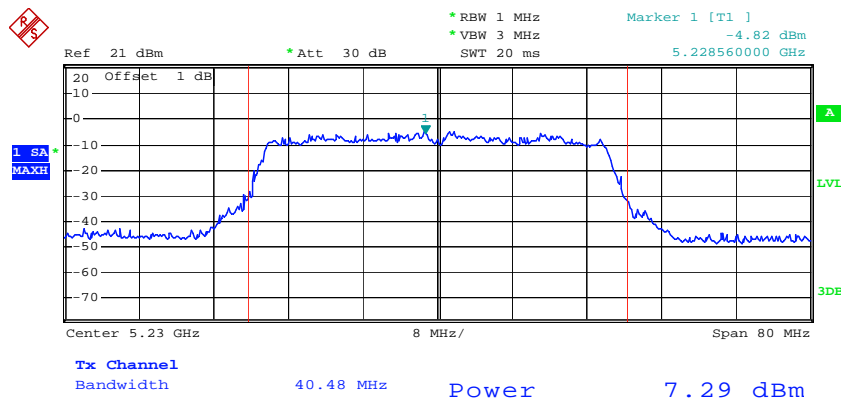

Date: 28.MAR.2013 15:55:35

## **FCC §15.407(a) (1) (5) - POWER SPECTRAL DENSITY**

### **Applicable Standard**

For the band 5.15–5.25 GHz, the maximum conducted output power over the frequency band of operation shall not exceed the lesser of 50 mW or  $4 \text{ dBm} + 10 \log B$ , where B is the 26-dB emission bandwidth in MHz. In addition, the peak power spectral density shall not exceed 4 dBm in any 1-MHz band. If transmitting antennas of directional gain greater than 6 dBi are used, both the maximum conducted output power and the peak power spectral density shall be reduced by the amount in dB that the directional gain of the antenna exceeds 6 dBi.

The peak power spectral density is measured as a conducted emission by direct connection of a calibrated test instrument to the equipment under test. If the device cannot be connected directly, alternative techniques acceptable to the Commission may be used. Measurements are made over a bandwidth of 1 MHz or the 26 dB emission bandwidth of the device, whichever is less. A resolution bandwidth less than the measurement bandwidth can be used, provided that the measured power is integrated to show total power over the measurement bandwidth. If the resolution bandwidth is approximately equal to the measurement bandwidth, and much less than the emission bandwidth of the equipment under test, the measured results shall be corrected to account for any difference between the resolution bandwidth of the test instrument and its actual noise bandwidth.

### **Test Procedure**

1. Check the calibration of the measuring instrument using either an internal calibrator or a known signal from an external generator.
2. Position the EUT was set without connection to measurement instrument. Turn on the EUT and connect its antenna terminal to measurement instrument via a low loss cable. Then set it to any one measured frequency within its operating range, and make sure the instrument is operated in its linear range.
3. Use sample detector and power averaging (not video averaging) mode. Set RBW= 1 MHz, VBW > 1 MHz. The PPSD is the highest level found across the emission in any 1-MHz band after 100 sweeps of averaging. This method is permitted only if the transmission pulse or sequence of pulses remains at maximum transmits power throughout each of the 100 sweeps of averaging and that the interval between pulses is not included in any of the sweeps.
4. Repeat above procedures until all frequencies measured were complete.

### **Test Equipment List and Details**

<b>Manufacturer</b>	<b>Description</b>	<b>Model</b>	<b>Serial Number</b>	<b>Calibration Date</b>	<b>Calibration Due Date</b>
Rohde & Schwarz	Spectrum Analyzer	FSP38	100478	2012-5-14	2013-5-13

\* Statement of Traceability: Bay Area Compliance Laboratories Corp. (Dongguan) attests that all calibrations have been performed in accordance to NVLAP requirements, traceable to National Primary Standards and International System of Units (SI).

**Test Data**

**Environmental Conditions**

<b>Temperature:</b>	25.5 °C
<b>Relative Humidity:</b>	56 %
<b>ATM Pressure:</b>	100.4 kPa

*The testing was performed by Leon Chen on 2013-03-28.*

*Test Mode: Transmitting*

**Test Result: Pass**

*Test mode: Transmitting*

Channel	Power Spectral Density	Limit	Result
	(dBm/MHz)	(dBm/MHz)	
802.11a mode			
Low	3.06	4	PASS
Middle	3.78	4	PASS
High	3.98	4	PASS
Chain 0:802.11n20 mode			
Low	-1.91	4	PASS
Middle	-2.51	4	PASS
High	-2.62	4	PASS
Chain 1:802.11n20 mode			
Low	-2.36	4	PASS
Middle	-2.53	4	PASS
High	-2.34	4	PASS
Chain 2:802.11n20 mode			
Low	-2.37	4	PASS
Middle	-2.81	4	PASS
High	-2.01	4	PASS
Chain 0:802.11n40 mode			
Low	-5.33	4	PASS
High	-4.60	4	PASS
Chain 1:802.11n40 mode			
Low	-5.13	4	PASS
High	-4.86	4	PASS
Chain 2:802.11n40 mode			
Low	-5.26	4	PASS
High	-4.48	4	PASS

Total power of 802.11n: chain 0+ chain 1+chain 2

Channel	Power Spectral Density	Limit	Result
	(dBm/MHz)	(dBm/MHz)	
Total:802.11n20 mode			
Low	2.56	4	PASS
Middle	2.16	4	PASS
High	2.46	4	PASS
Total:802.11n40 mode			
Low	-0.47	4	PASS
High	0.13	4	PASS

### Power Spectral Density, 802.11a Low Channel

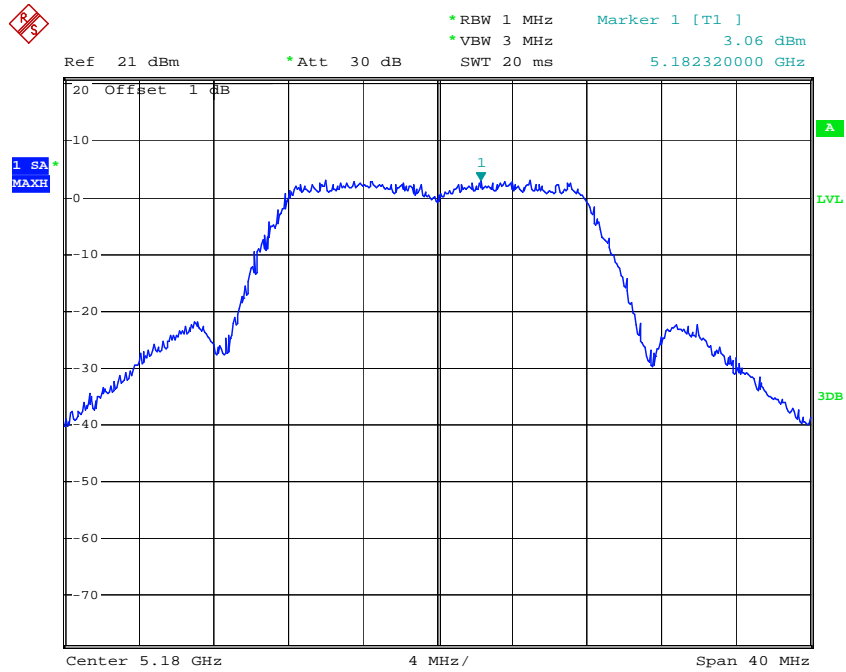

Date: 28.MAR.2013 13:42:09

### Power Spectral Density, 802.11a Middle Channel

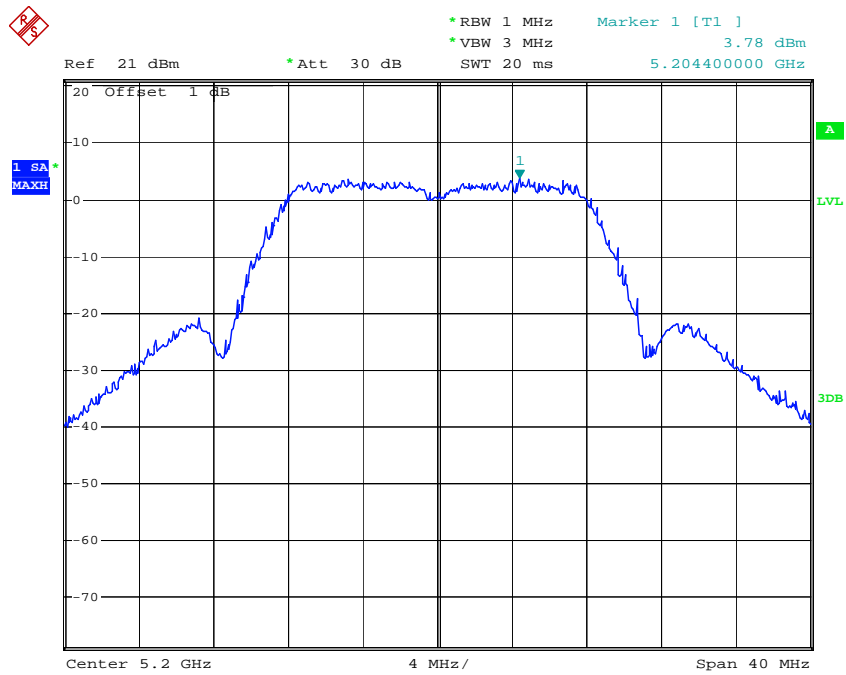

Date: 28.MAR.2013 13:36:23

### Power Spectral Density, 802.11a High Channel

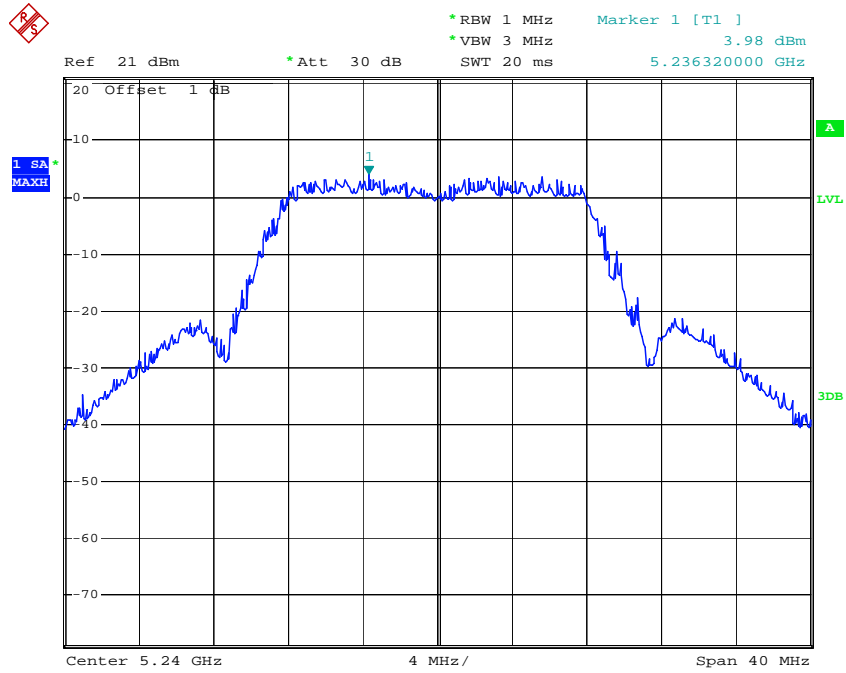

Date: 28.MAR.2013 13:50:29

### Chain 0:Power Spectral Density, 802.11n20 Low Channel

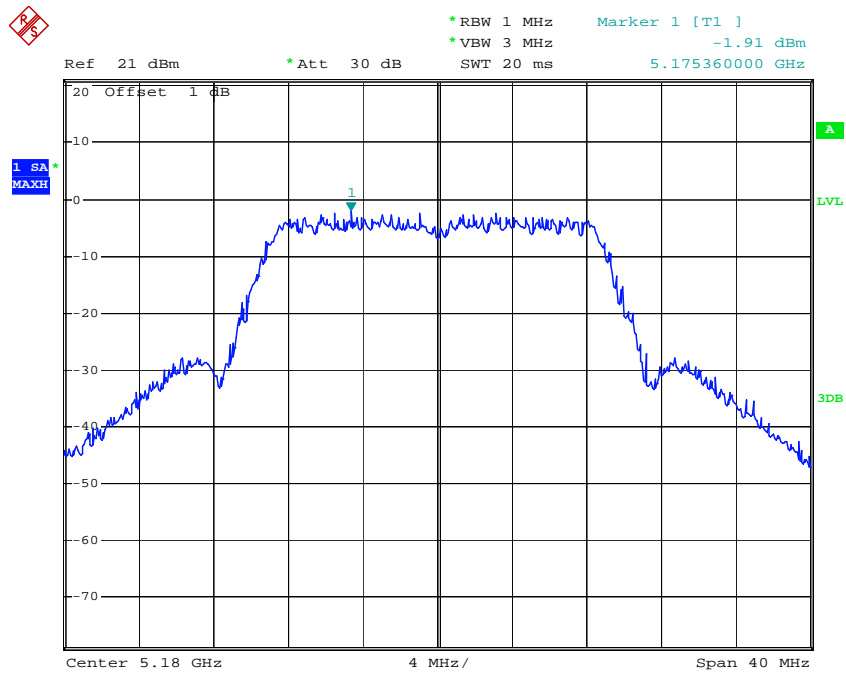

Date: 28.MAR.2013 15:11:22



### Chain 0: Power Spectral Density, 802.11n20 Middle Channel

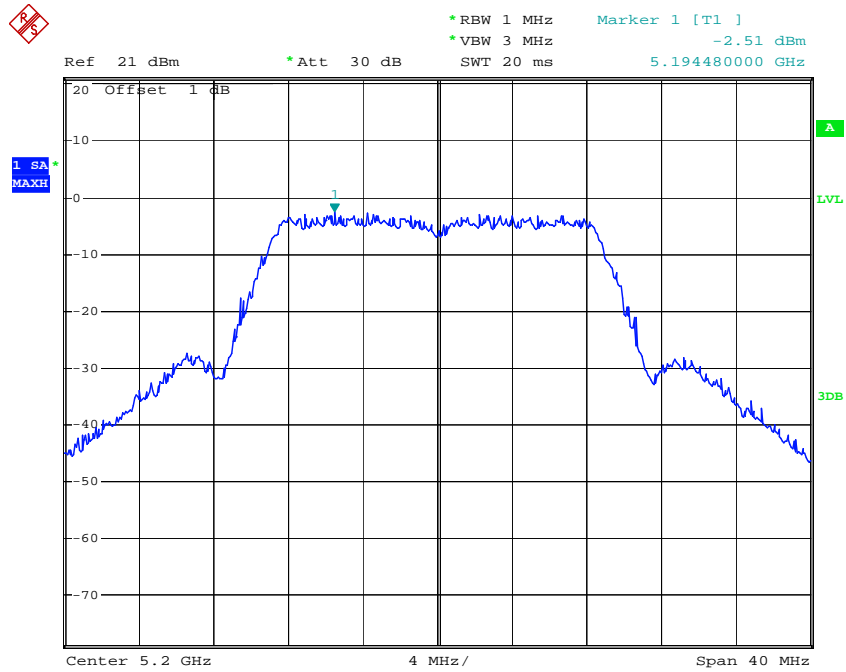

Date: 28.MAR.2013 15:26:13

### Chain 0: Power Spectral Density, 802.11n20 High Channel

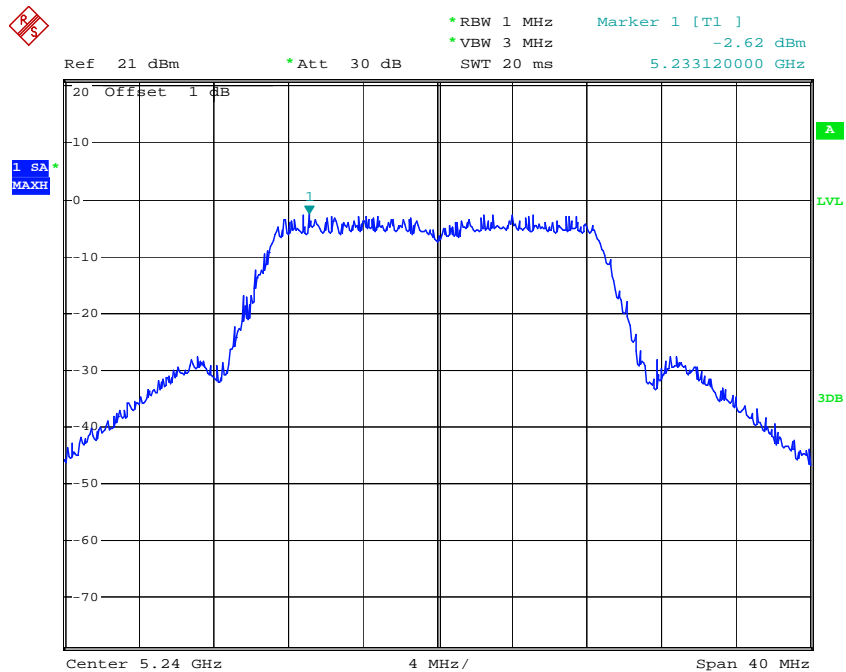

Date: 28.MAR.2013 14:55:58

### Chain 1:Power Spectral Density, 802.11 n20 Low Channel

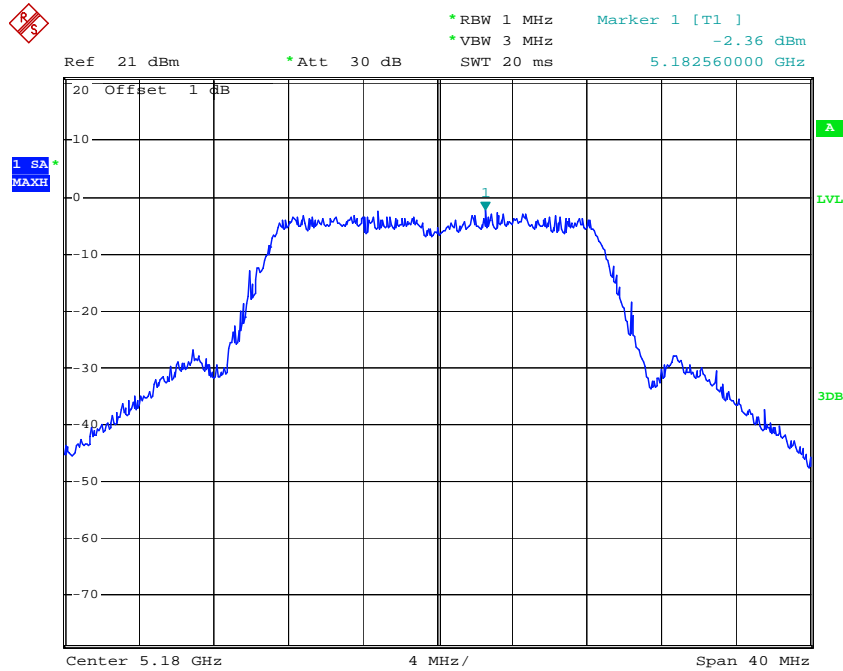

Date: 28.MAR.2013 15:14:41

### Chain 1:Power Spectral Density, 802.11n20 Middle Channel

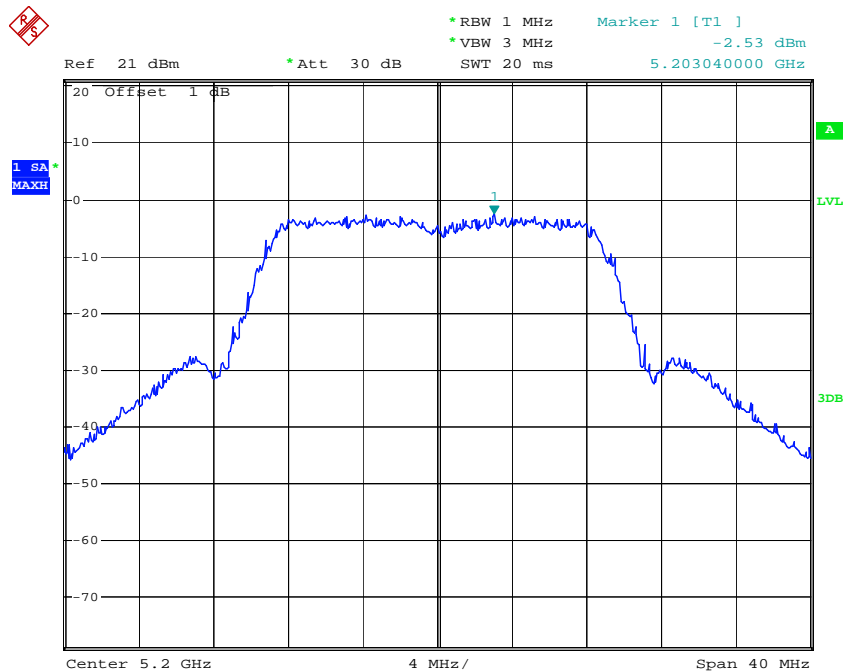

Date: 28.MAR.2013 15:28:50

### Chain 1: Power Spectral Density, 802.11n20 High Channel

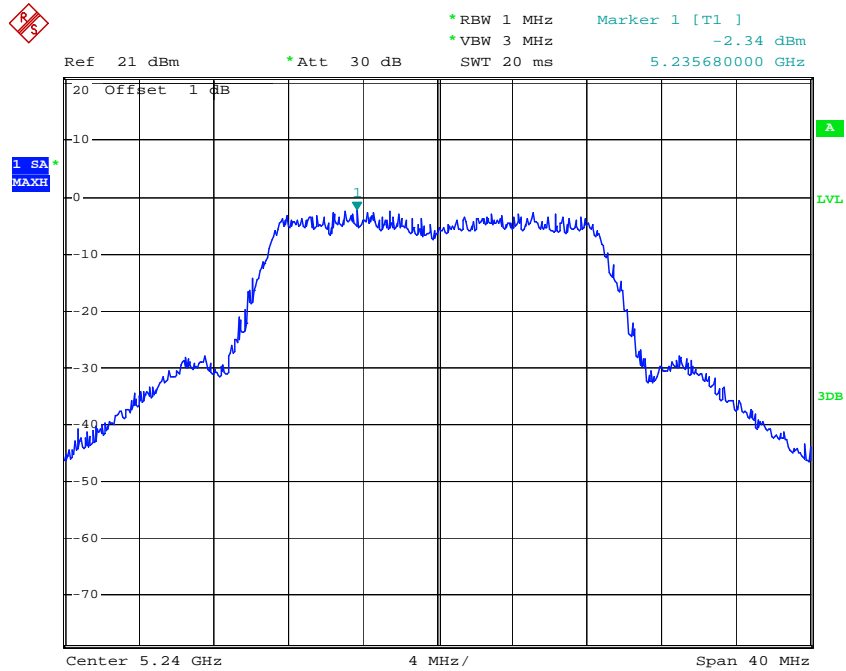

Date: 28.MAR.2013 14:59:10

### Chain 2: Power Spectral Density, 802.11 n20 Low Channel

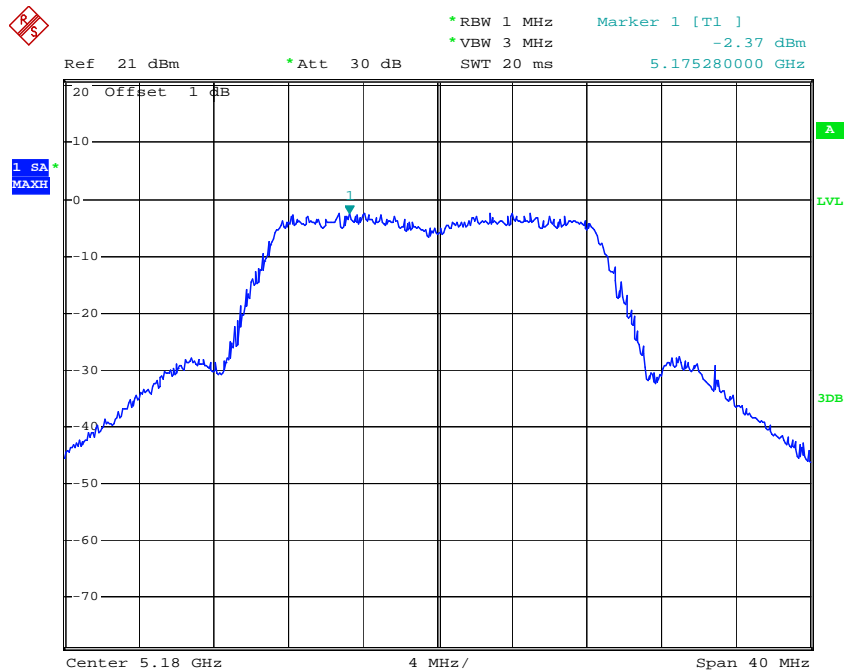

Date: 28.MAR.2013 15:15:32

### Chain 2: Power Spectral Density, 802.11n20 Middle Channel

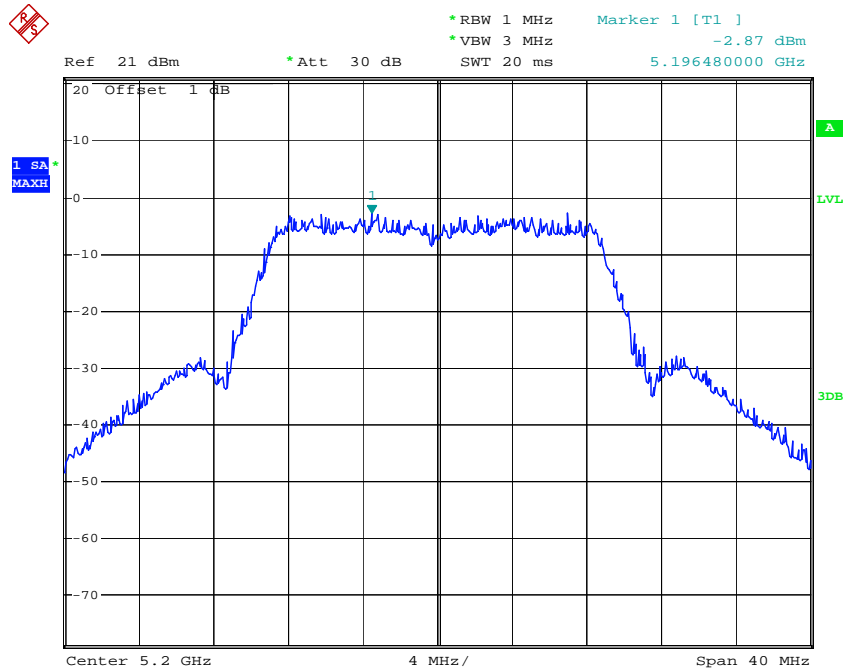

Date: 28.MAR.2013 15:29:31

### Chain 2: Power Spectral Density, 802.11n20 High Channel

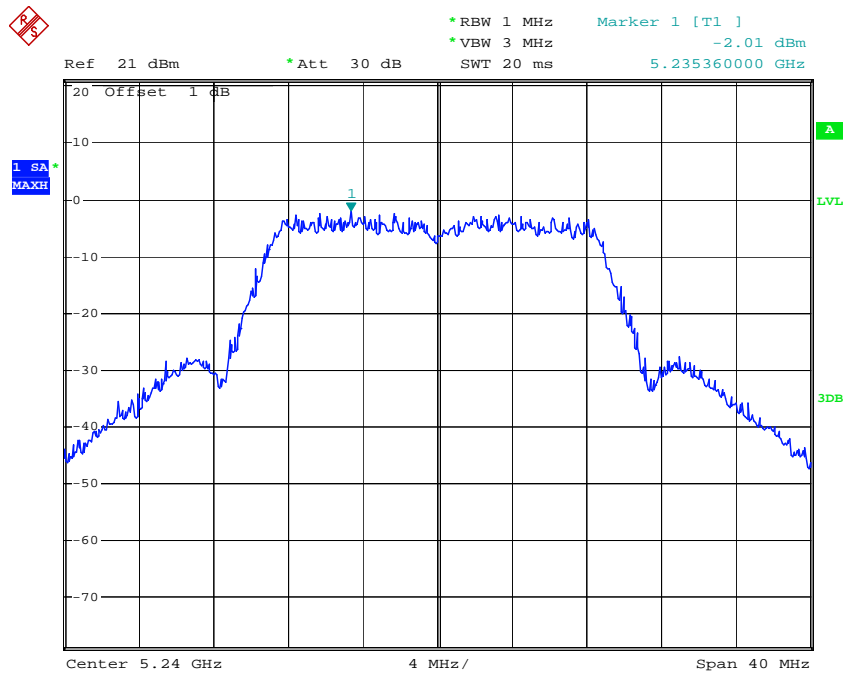

Date: 28.MAR.2013 15:01:51

### Chain 0: Power Spectral Density, 802.11n40 Low Channel

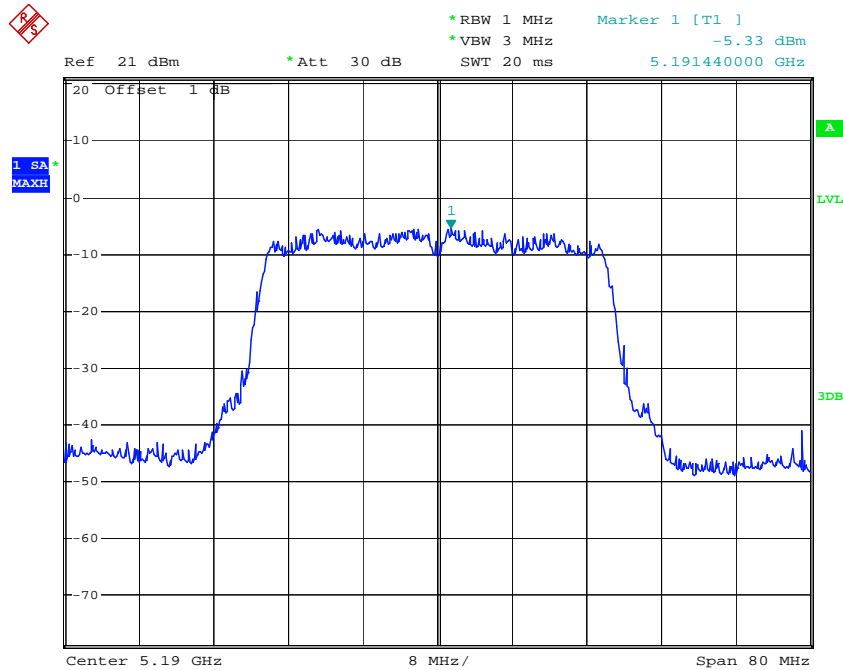

Date: 28.MAR.2013 16:14:54

### Chain 0: Power Spectral Density, 802.11n40 High Channel

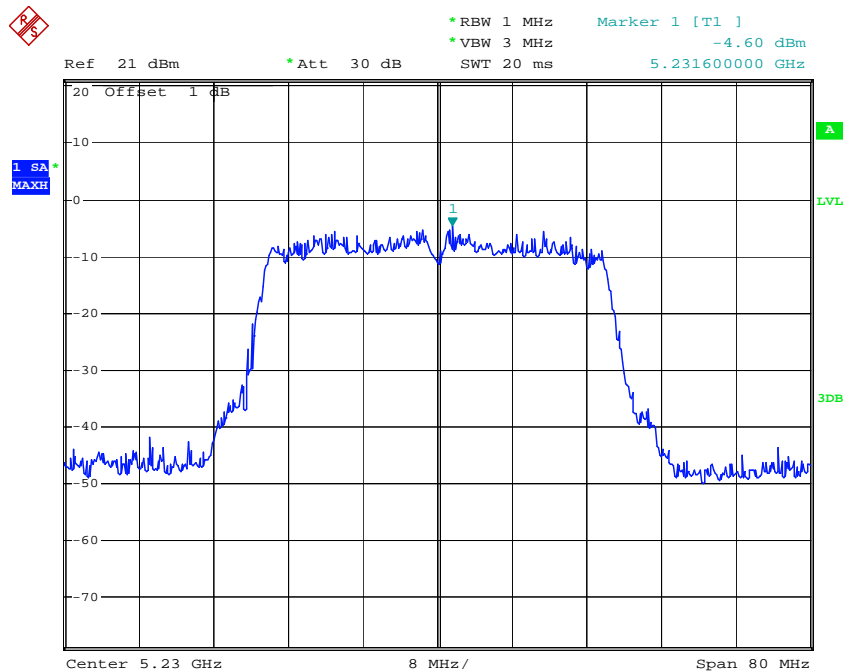

Date: 28.MAR.2013 15:51:31

### Chain 1: Power Spectral Density, 802.11n40 Low Channel

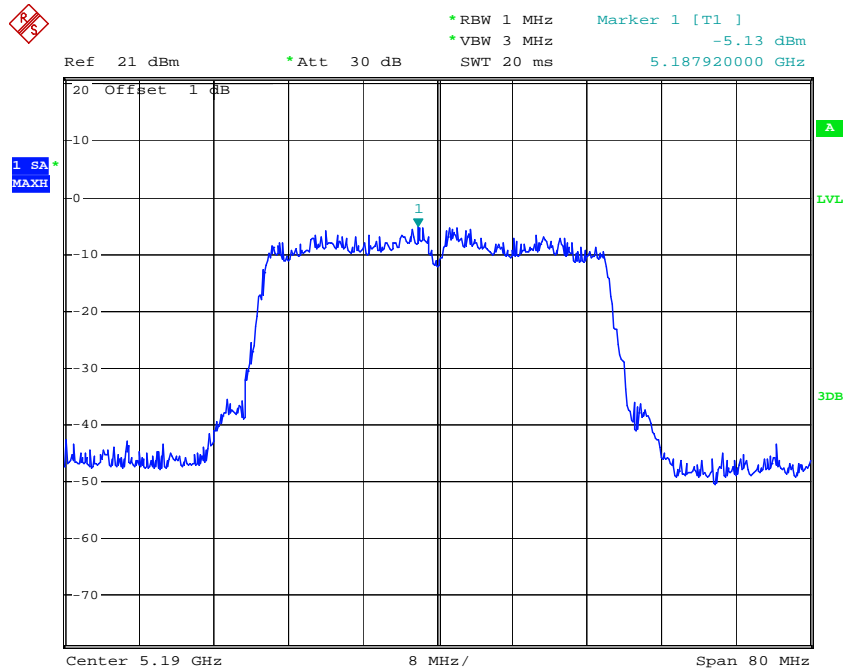

Date: 28.MAR.2013 16:17:41

### Chain 1: Power Spectral Density, 802.11n40 High Channel

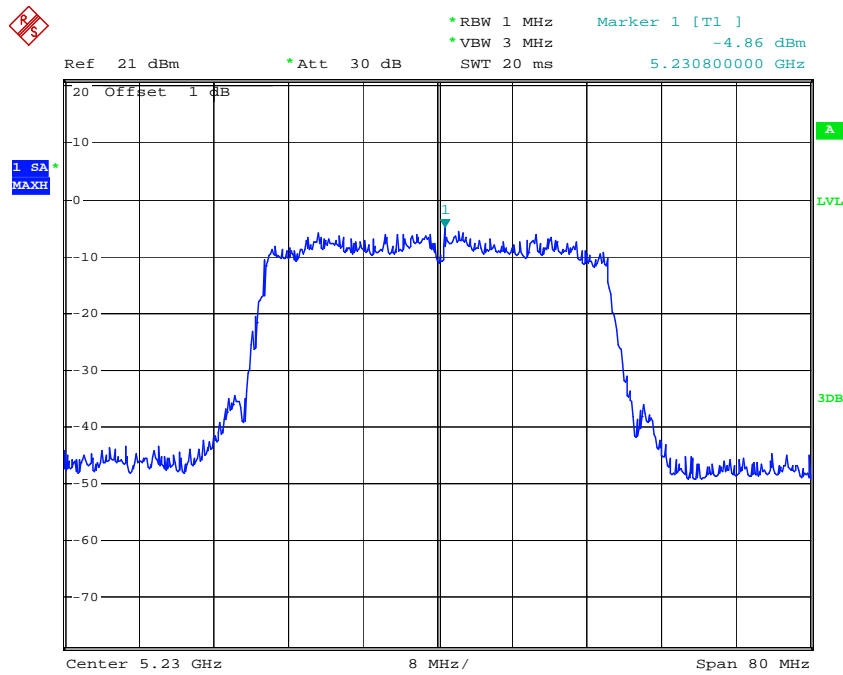

Date: 28.MAR.2013 15:53:54

### Chain 2: Power Spectral Density, 802.11n40 Low Channel

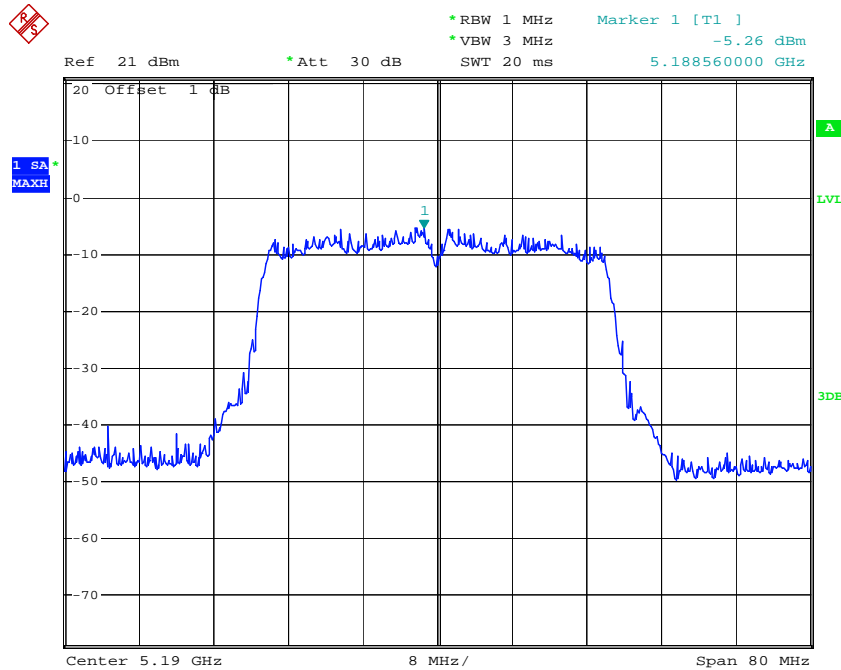

Date: 28.MAR.2013 16:20:20

### Chain 2: Power Spectral Density, 802.11n40 High Channel

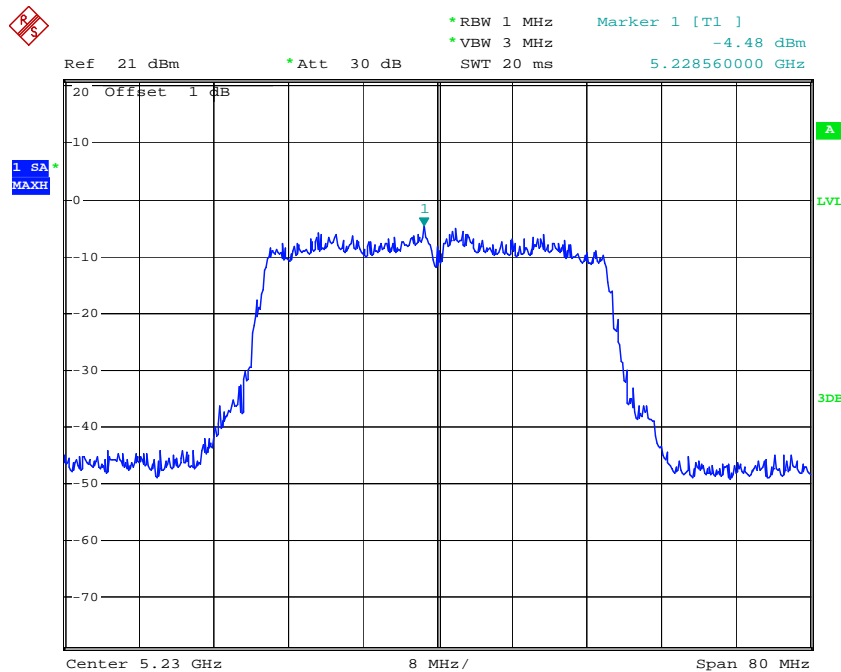

Date: 28.MAR.2013 15:56:18

## FCC §15.407(a) (6) – PEAK EXCURSION RATIO

### Applicable Standard

According to §15.407(a) (6), the ratio of the peak excursion of the modulation envelope (measured using a peak hold function) to the maximum conducted output power (measured as specified above) shall not exceed 13 dB across any 1 MHz bandwidth or the emission bandwidth whichever is less.

### Test Procedure

Set the spectrum analyzer span to view the entire emission bandwidth. The largest difference between the following two traces must be  $\leq 13$  dB for all frequencies across the emission bandwidth. Submit a plot.

**1st Trace:**

- Set RBW = 1 MHz, VBW  $\geq 3$  MHz with peak detector and maxhold settings.

**2nd Trace:**

- create the 2nd trace using the settings described in the setion “FCC §15.407(a)(1)(2) – CONDUCTED TRANSMITTER OUTPUT POWER”.

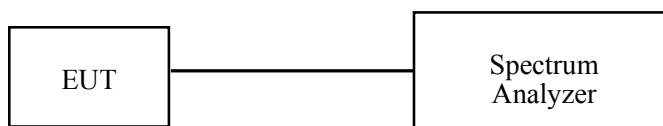

### Test Equipment List and Details

Manufacturer	Description	Model	Serial Number	Calibration Date	Calibration Due Date
Rohde & Schwarz	Spectrum Analyzer	FSP38	100478	2012-5-14	2013-5-13

\* Statement of Traceability: Bay Area Compliance Laboratories Corp. (Dongguan) attests that all calibrations have been performed in accordance to NVLAP requirements, traceable to National Primary Standards and International System of Units (SI).

### Test Data

#### Environmental Conditions

Temperature:	25.5 °C
Relative Humidity:	56 %
ATM Pressure:	100.4 kPa

The testing was performed by Leon Chen on 2013-03-28.



*Test Mode: Transmitting*

Channel	Peak Excursion Ratio	Limit	Result
	(dB)	(dB)	
802.11a mode			
Low	1.61	13	PASS
Middle	1.17	13	PASS
High	2.02	13	PASS
Chain 0:802.11n20 mode			
Low	1.12	13	PASS
Middle	1.82	13	PASS
High	1.18	13	PASS
Chain 1:802.11n20 mode			
Low	1.84	13	PASS
Middle	1.51	13	PASS
High	1.29	13	PASS
Chain 2:802.11n20 mode			
Low	0.76	13	PASS
Middle	1.26	13	PASS
High	1.29	13	PASS
Chain 0:802.11n40 mode			
Low	1.29	13	PASS
High	0.96	13	PASS
Chain 1:802.11n40 mode			
Low	0.99	13	PASS
High	2.25	13	PASS
Chain 2:802.11n40 mode			
Low	3.14	13	PASS
High	2.20	13	PASS

### 802.11a Peak Excursion, Low Channel

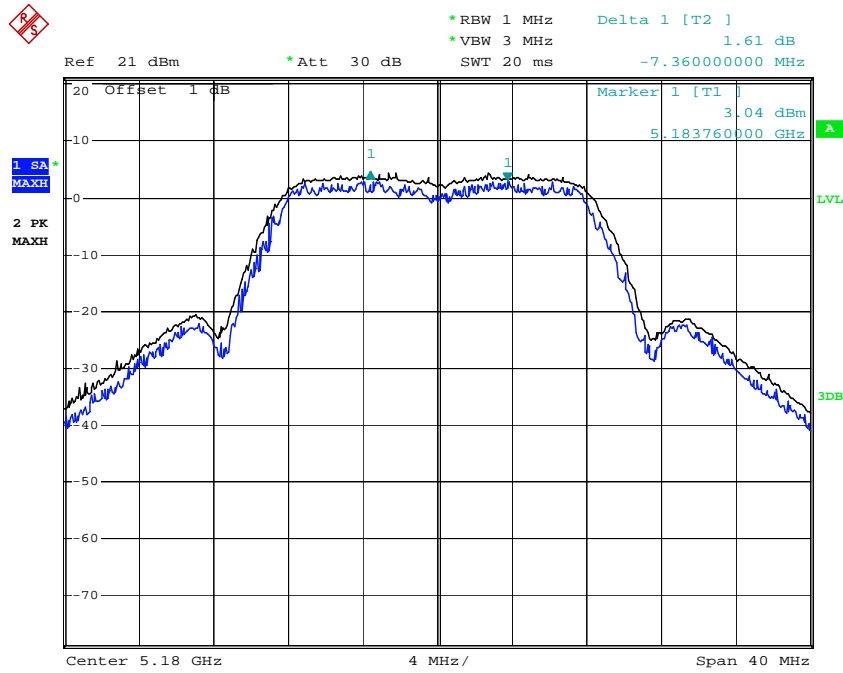

Date: 28.MAR.2013 13:43:07

### 802.11a Peak Excursion, Middle Channel

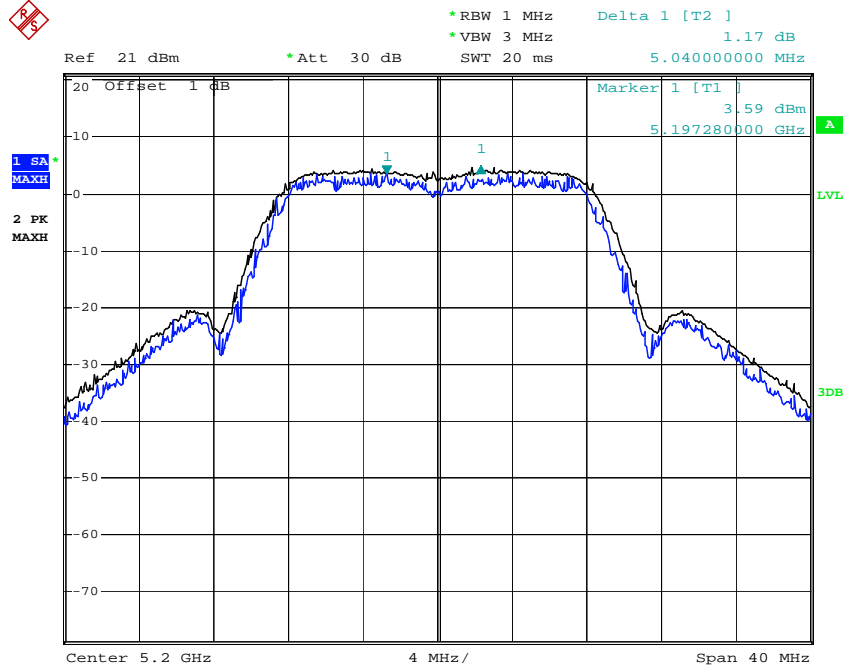

Date: 28.MAR.2013 13:40:11

### 802.11a Peak Excursion, High Channel

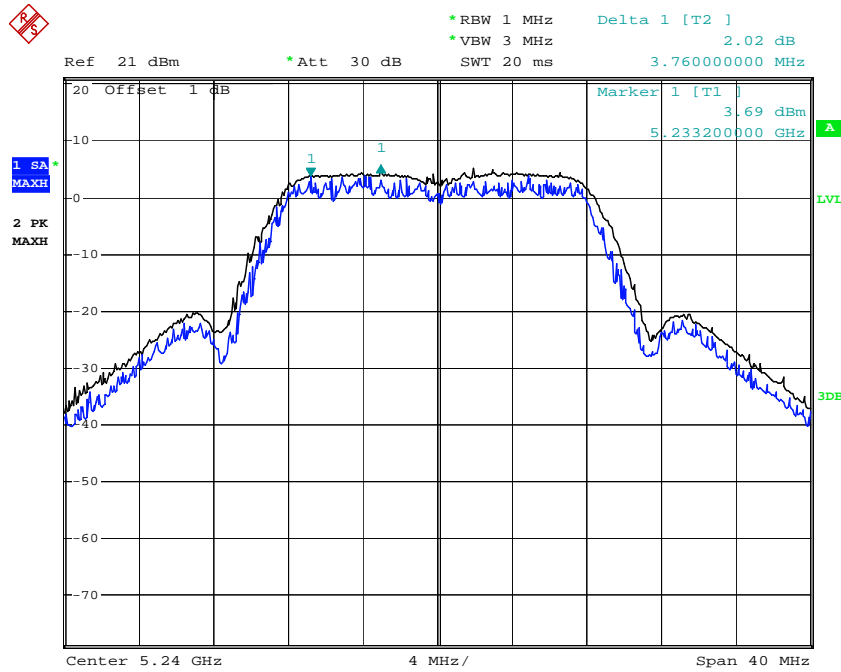

Date: 28.MAR.2013 13:51:26

### Chain 0:802.11 n20 Peak Excursion, Low Channel

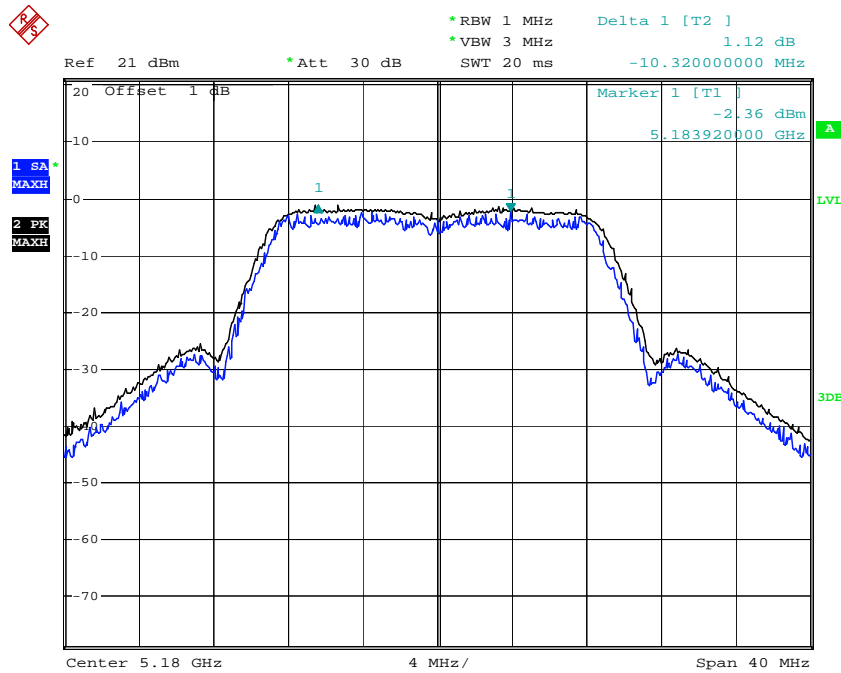

Date: 28.MAR.2013 15:12:16

### Chain 0:802.11 n20 Peak Excursion, Middle Channel

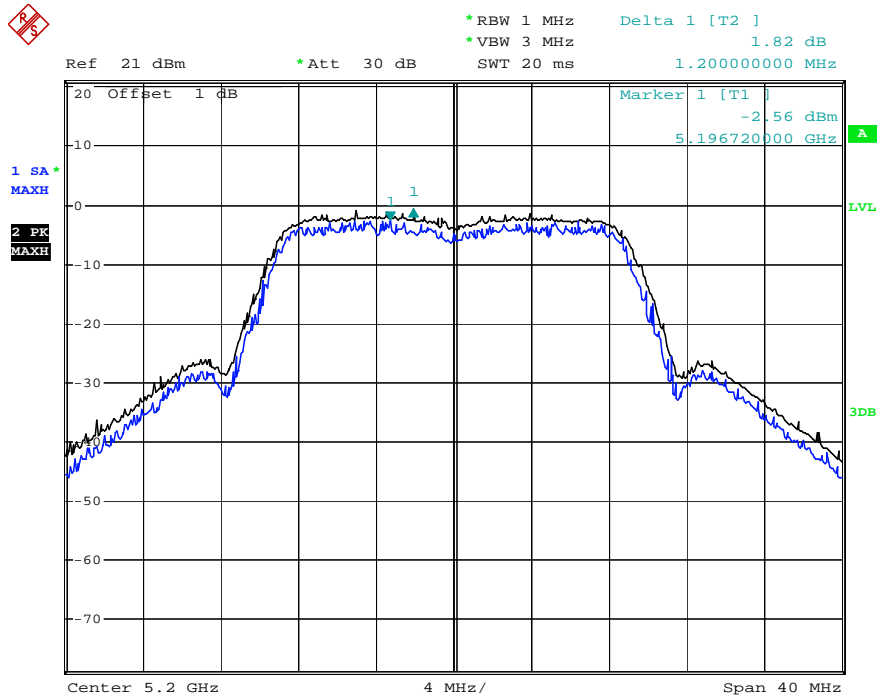

Date: 28.MAR.2013 15:27:07

### Chain 0:802.11 n20 Peak Excursion, High Channel

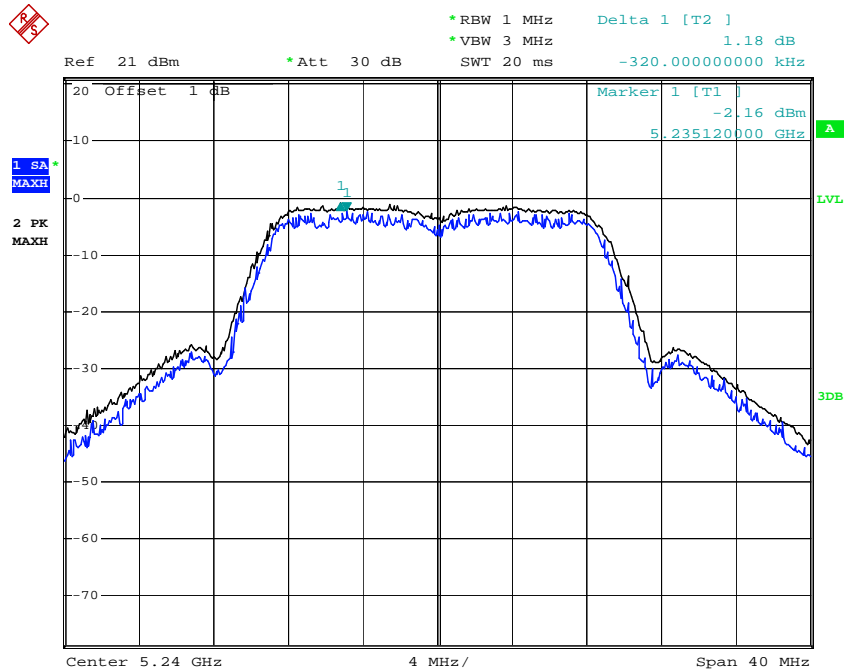

Date: 28.MAR.2013 14:57:21

### Chain 1:802.11 n20 Peak Excursion, Low Channel

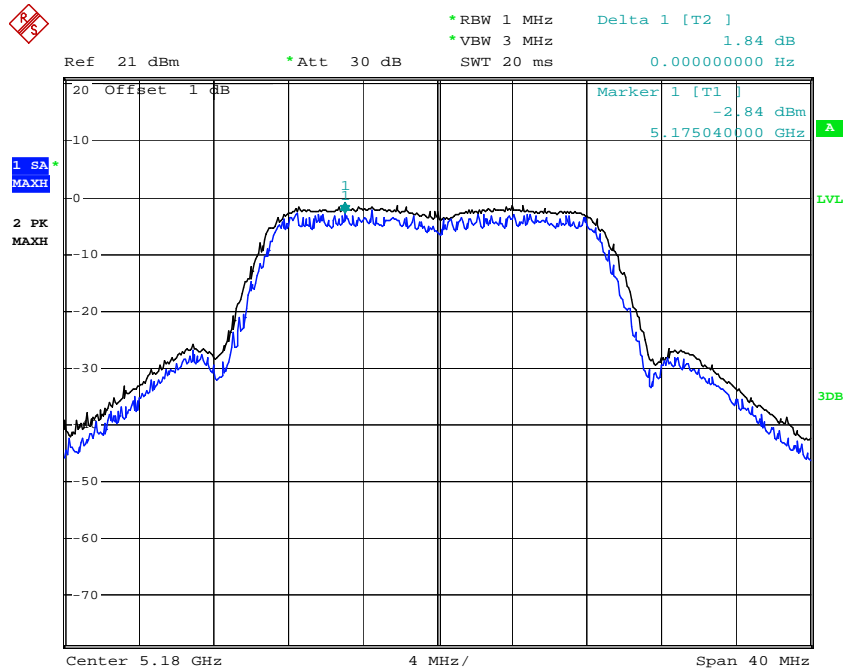

Date: 28.MAR.2013 15:13:43

### Chain 1:802.11 n20 Peak Excursion, Middle Channel

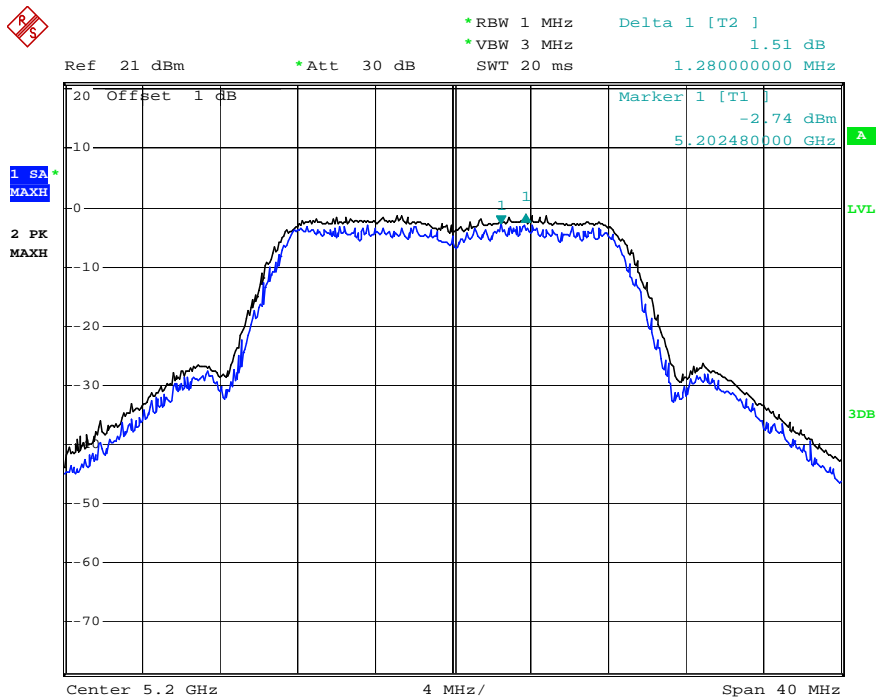

Date: 28.MAR.2013 15:28:02

### Chain 1:802.11 n20 Peak Excursion, High Channel

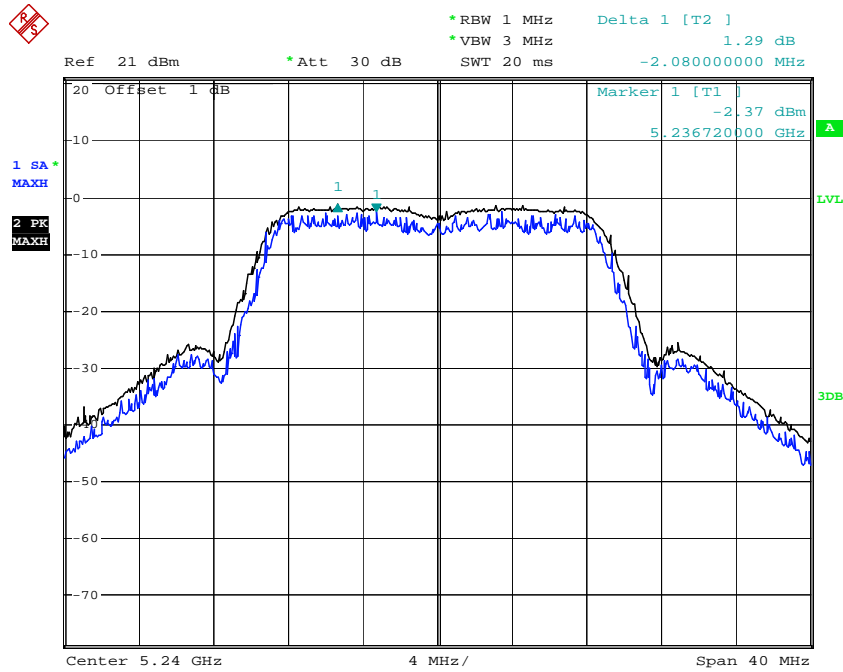

Date: 28.MAR.2013 15:00:51

### Chain 2:802.11 n20 Peak Excursion, Low Channel

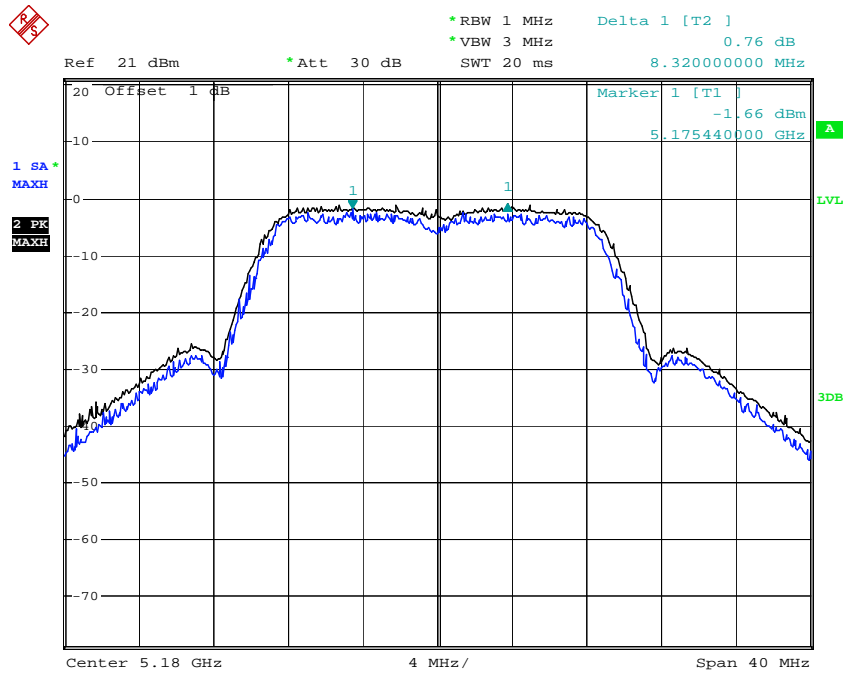

Date: 28.MAR.2013 15:16:45

### Chain 2:802.11 n20 Peak Excursion, Middle Channel

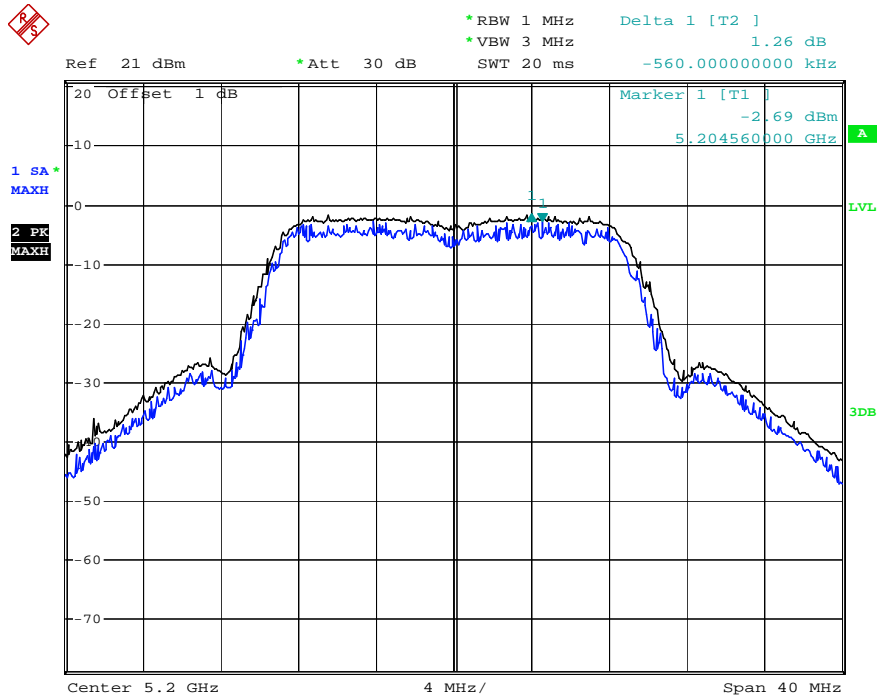

Date: 28.MAR.2013 15:30:14

### Chain 2:802.11 n20 Peak Excursion, High Channel

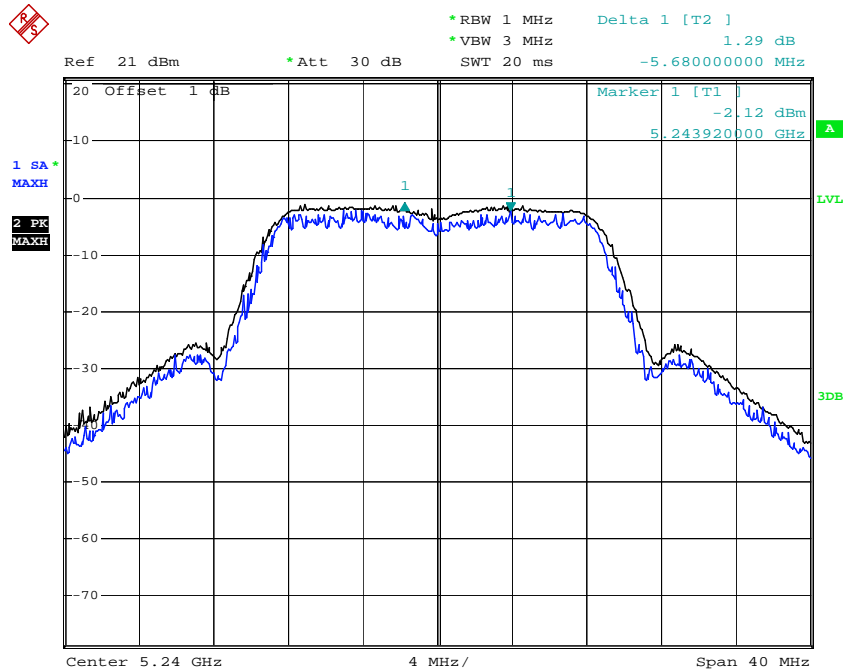

Date: 28.MAR.2013 15:02:36

### Chain 0:802.11 n40 Peak Excursion, Low Channel

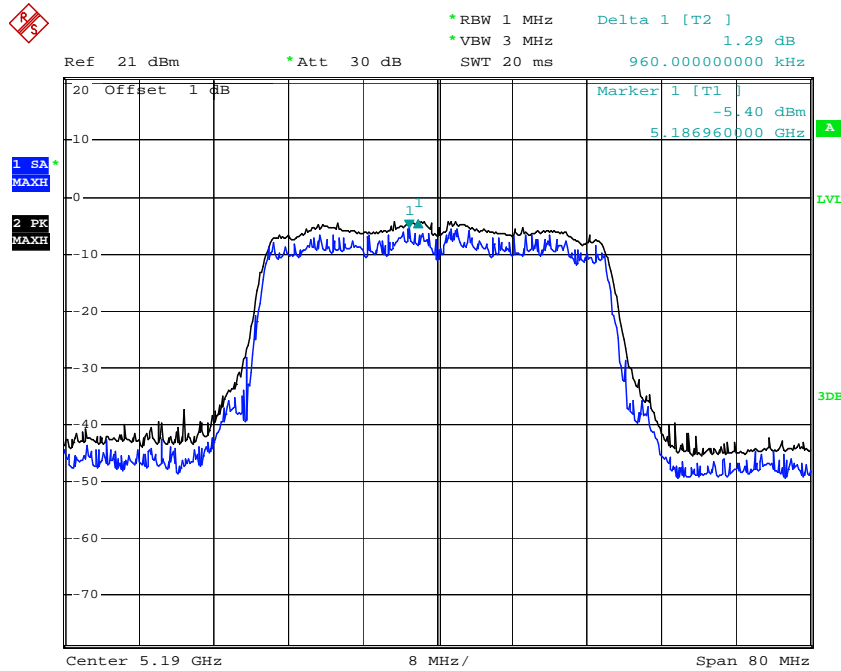

Date: 28.MAR.2013 16:15:36

### Chain 0:802.11 n40 Peak Excursion, High Channel

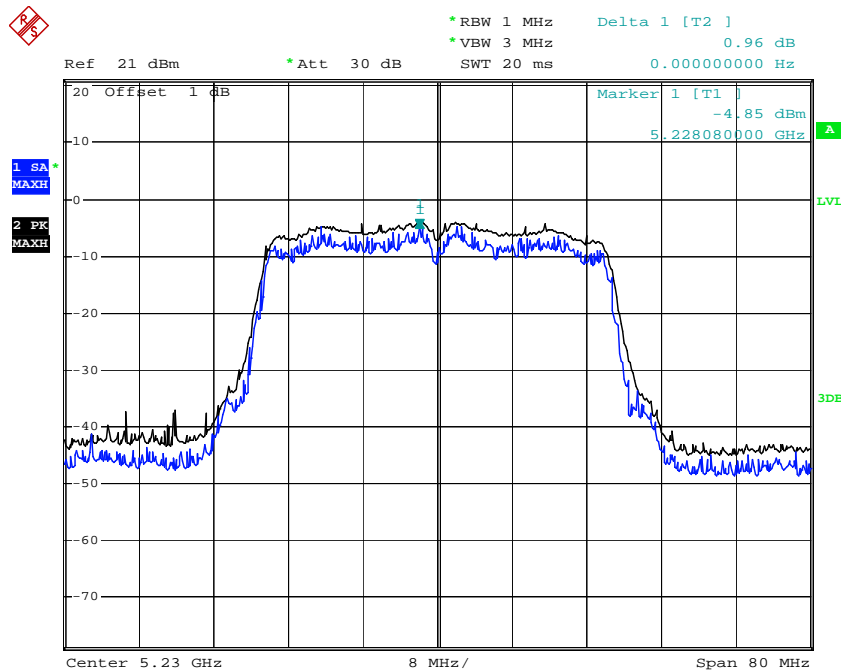

Date: 28.MAR.2013 15:52:15



**Chain 1:802.11 n40 Peak Excursion, Low Channel**

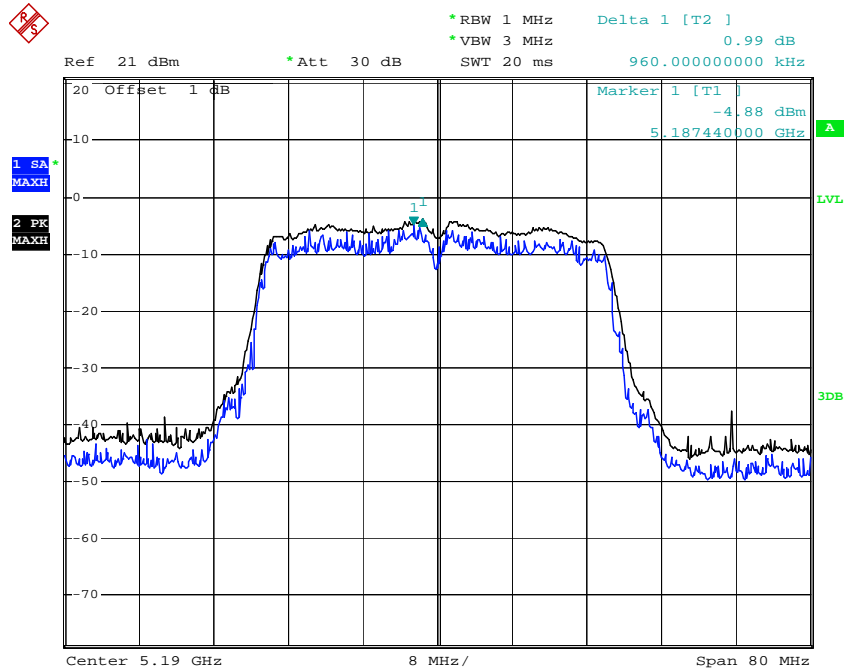

Date: 28.MAR.2013 16:18:25

**Chain 1:802.11 n40 Peak Excursion, High Channel**

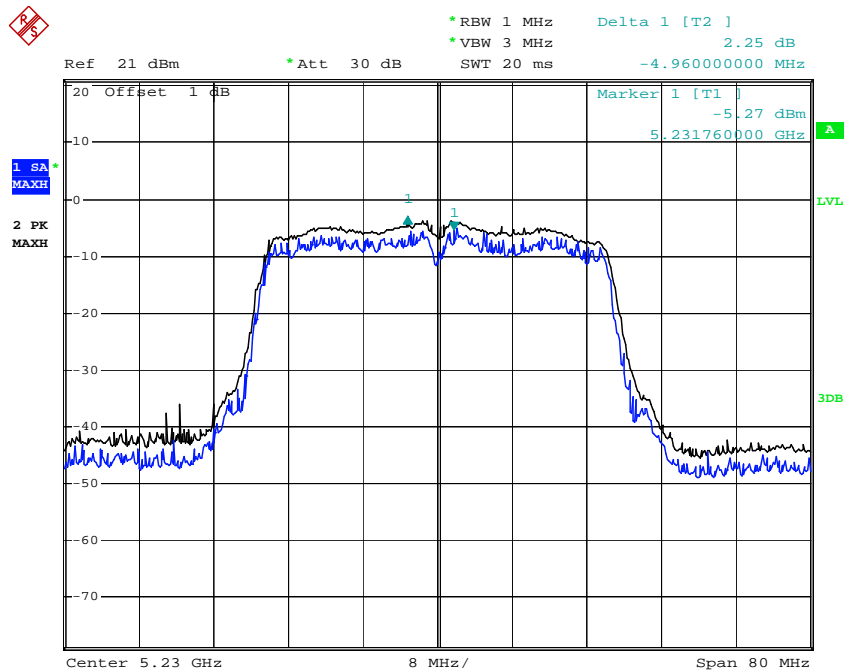

Date: 28.MAR.2013 15:53:14

**Chain 2:802.11 n40 Peak Excursion, Low Channel**

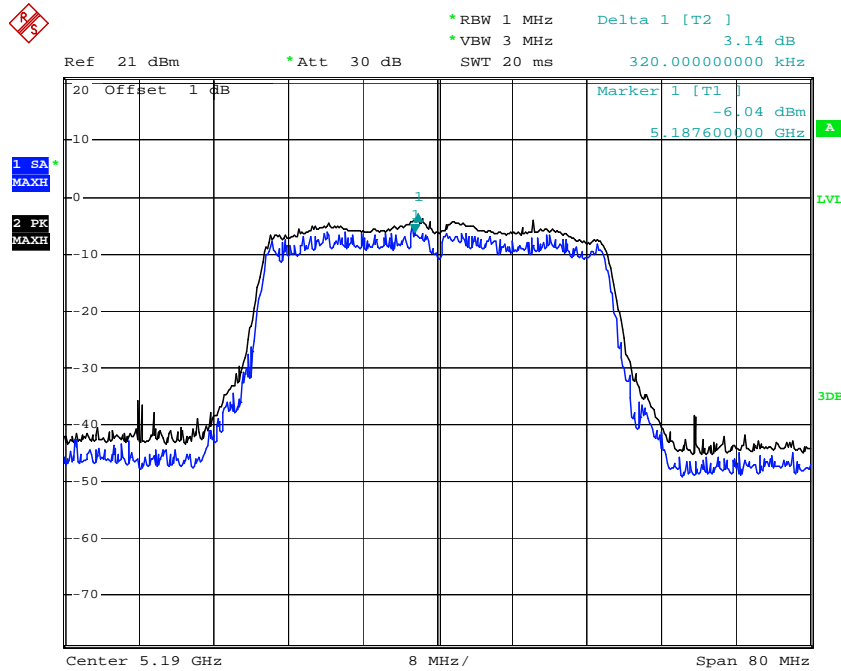

Date: 28.MAR.2013 16:21:09

**Chain 2:802.11 n40 Peak Excursion, High Channel**

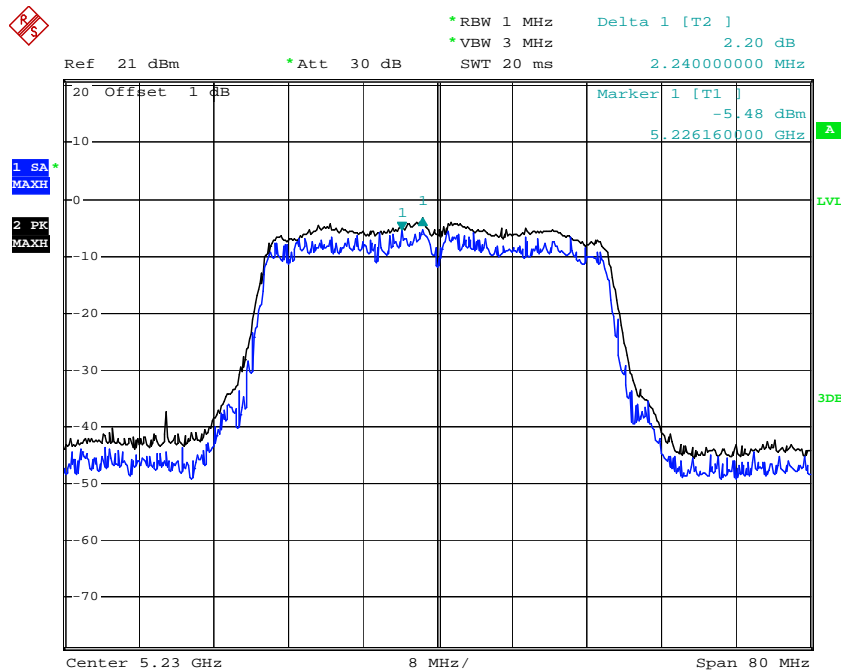

Date: 28.MAR.2013 15:56:55

\*\*\*\*\* END OF REPORT \*\*\*\*\*