



FCC PART 15B, CLASS B

TEST REPORT

For

SHENZHEN TENDA TECHNOLOGY CO.,LTD.

Tenda Industrial Park, No. 34-1, Shilong Rd., Shiyan Town, Bao'an District, Shenzhen, P.R.China

FCC ID: V7TN80

Report Type: Original Report	Product Type: Wireless N900 Concurrent Dual-Band Gigabit Router
Test Engineer: Leon Chen	<i>Leon Chen</i>
Report Number: R2DG130314004-00A	
Report Date: 2013-03-29	
Reviewed By: RF Leader	<i>Ivan Cao</i>
Test Laboratory: Bay Area Compliance Laboratories Corp. (Dongguan) No.69 Pulongcun, Puxinhu Industrial Zone, Tangxia, Dongguan, Guangdong, China Tel: +86-769-86858888 Fax: +86-769-86858891 www.baclcorp.com.cn	

Note: This test report is prepared for the customer shown above and for the device described herein. It may not be duplicated or used in part without prior written consent from Bay Area Compliance Laboratories Corp. This report **must not** be used by the customer to claim product certification, approval, or endorsement by NVLAP*, or any agency of the Federal Government.

* This report may contain data that are not covered by the NVLAP accreditation and shall be marked with an asterisk "★" (Rev.2)

TABLE OF CONTENTS

GENERAL INFORMATION.....3

 PRODUCT DESCRIPTION FOR EQUIPMENT UNDER TEST (EUT)3

 OBJECTIVE3

 RELATED SUBMITTAL(S)/GRANT(S).....3

 TEST FACILITY4

SYSTEM TEST CONFIGURATION.....5

 JUSTIFICATION5

 EUT EXERCISE SOFTWARE5

 EQUIPMENT MODIFICATIONS5

 SUPPORT EQUIPMENT LIST AND DETAILS5

 EXTERNAL CABLE.....5

 BLOCK DIAGRAM OF TEST SETUP6

SUMMARY OF TEST RESULTS7

FCC §15.107 – AC LINE CONDUCTED EMISSIONS.....8

 MEASUREMENT UNCERTAINTY8

 EUT SETUP8

 EMI TEST RECEIVER SETUP.....9

 TEST PROCEDURE9

 CORRECTED AMPLITUDE & MARGIN CALCULATION9

 TEST EQUIPMENT LIST AND DETAILS.....10

 TEST RESULTS SUMMARY10

 TEST DATA10

FCC §15.109 - RADIATED EMISSIONS13

 MEASUREMENT UNCERTAINTY13

 EUT SETUP13

 EMI TEST RECEIVER SETUP.....14

 TEST PROCEDURE14

 CORRECTED AMPLITUDE & MARGIN CALCULATION15

 TEST EQUIPMENT LIST AND DETAILS.....15

 TEST RESULTS SUMMARY15

 TEST DATA15

GENERAL INFORMATION

Product Description for Equipment under Test (EUT)

The *SHENZHEN TENDA TECHNOLOGY CO.,LTD.*'s product, model number: *N80 (FCC ID: V7TN80)* or ("EUT") in this report is *Wireless N900 Concurrent Dual-Band Gigabit Router*, which was measured approximately: 21.6 cm (L) x 15.6 cm (W) x 3.9 cm (H), rated input voltage: DC 12V from adapter. The highest operating frequency is 500MHz.

Adapter information: Honor
Model: ADS-40FSG-12 12030GPCU
Input: AC 100-240V, 50/60Hz, Max.1.0A
Output: DC 12V, 2.5A

** All measurement and test data in this report was gathered from production sample serial number: 130314004 (Assigned by BACL, Dongguan). The EUT was received on 2013-03-15.*

Objective

This report is prepared on behalf of *SHENZHEN TENDA TECHNOLOGY CO.,LTD.* in accordance with Part 2, Subpart J, Part 15, Subparts A and B of the Federal Communications Commission rules.

The objective of the manufacturer is to determine compliance with FCC Part 15B, Class B.

Related Submittal(s)/Grant(s)

FCC Part 15C DTS submissions with FCC ID: *V7TN80*.
FCC Part 15E NII submissions with FCC ID: *V7TN80*.

Test Facility

The Test site used by Bay Area Compliance Laboratories Corp. (Dongguan) to collect test data is located on the No.69 Pulongcun, Puxinhu Industrial Zone, Tangxia, Dongguan, Guangdong, China

Test site at Bay Area Compliance Laboratories Corp. (Dongguan) has been fully described in reports submitted to the Federal Communication Commission (FCC). The details of these reports have been found to be in compliance with the requirements of Section 2.948 of the FCC Rules on February 02, 2012. The facility also complies with the radiated and AC line conducted test site criteria set forth in ANSI C63.4-2003.

The Federal Communications Commission has the reports on file and is listed under FCC Registration No.: 273710. The test site has been approved by the FCC for public use and is listed in the FCC Public Access Link (PAL) database.

Additionally, Bay Area Compliance Laboratories Corp. (Dongguan) is an ISO/IEC 17025 accredited laboratory, and is accredited by National Voluntary Laboratory Accredited Program (Lab Code 500069-0).



The current scope of accreditations can be found at <http://ts.nist.gov/standards/scopes/5000690.htm>

SYSTEM TEST CONFIGURATION

Justification

The system was configured for testing in a typical fashion (as normally used by a typical user).

EUT Exercise Software

The software 'Broadcom MTool 2.0.0.3' was used for testing, which was provided by manufacturer.

Equipment Modifications

No modification was made to the EUT.

Support Equipment List and Details

Manufacturer	Description	Model	Serial Number
HP	Printer	C3941A	JPTVOB2337
SAST	Modem	AEM-2100	0293
DELL	Keyboard	L100	CNORH656658907BL05DC
DELL	Laptop	PP11L	N/A
Kinston	Flash Disk	4G	/
DELL	PC	GX620	/

External Cable

Cable Description	Length (m)	From Port	To
Shielded Detachable Printer Cable	1.2	Parallel Port of Laptop	Printer
Shielded Detachable Serial Cable	1.2	Serial Port of Laptop	Modem
Shielded Detachable Keyboard Cable	1.5	Keyboard Port of Laptop	Keyboard
RJ 45 Cable	1.0	Laptop	EUT
RJ45 Cable*4	10	EUT	PC

Block Diagram of Test Setup

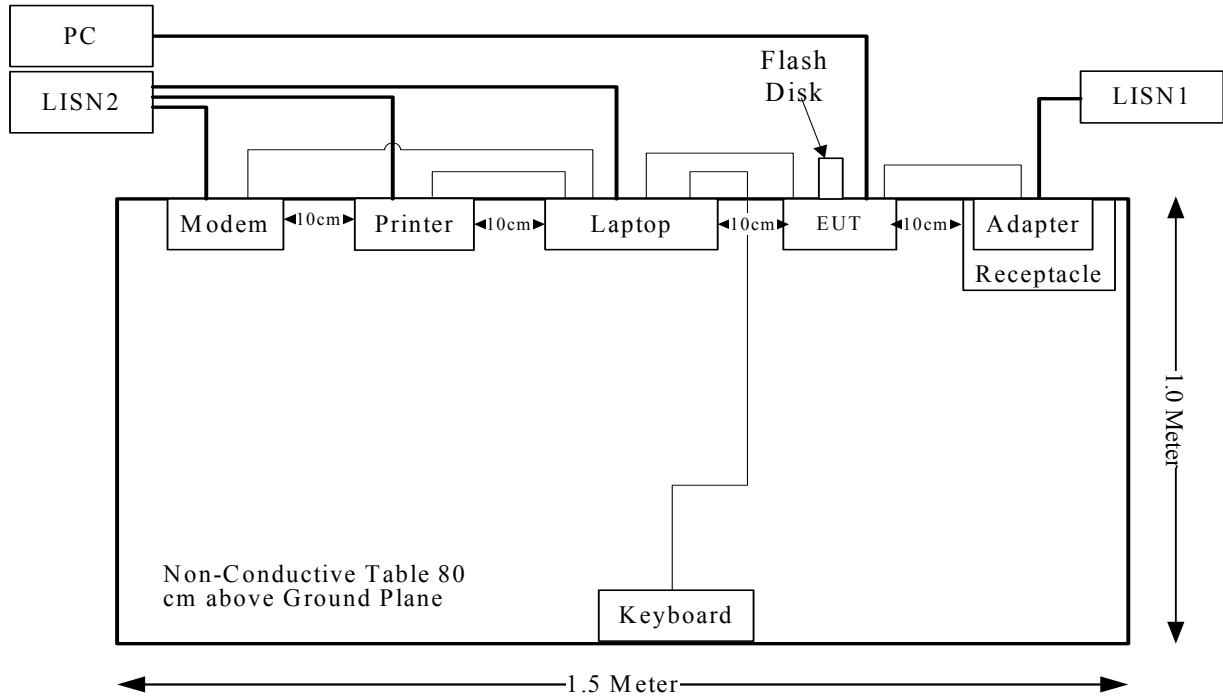

SUMMARY OF TEST RESULTS

FCC Rules	Description of Test	Results
§15.107	AC Line Conducted Emissions	Compliance
§15.109	Radiated Emissions	Compliance

FCC §15.107 – AC LINE CONDUCTED EMISSIONS

Measurement Uncertainty

Compliance or non-compliance with a disturbance limit shall be determined in the following manner:

If U_{lab} is less than or equal to U_{cispr} of Table 1, then:

- compliance is deemed to occur if no measured disturbance level exceeds the disturbance limit;
- non-compliance is deemed to occur if any measured disturbance level exceeds the disturbance limit.

If U_{lab} is greater than U_{cispr} of Table 1, then:

- compliance is deemed to occur if no measured disturbance level, increased by $(U_{lab} - U_{cispr})$, exceeds the disturbance limit;
- non-compliance is deemed to occur if any measured disturbance level, increased by $(U_{lab} - U_{cispr})$, exceeds the disturbance limit.

Based on CISPR 16-4-2: 2011, measurement uncertainty of conducted disturbance at mains port using AMN at Bay Area Compliance Laboratories Corp. (Dongguan) is 3.46 dB (150 kHz to 30 MHz).

Table 1 – Values of U_{cispr}

Measurement	U_{cispr}
Conducted disturbance at mains port using AMN (150 kHz to 30 MHz)	3.4 dB

EUT Setup

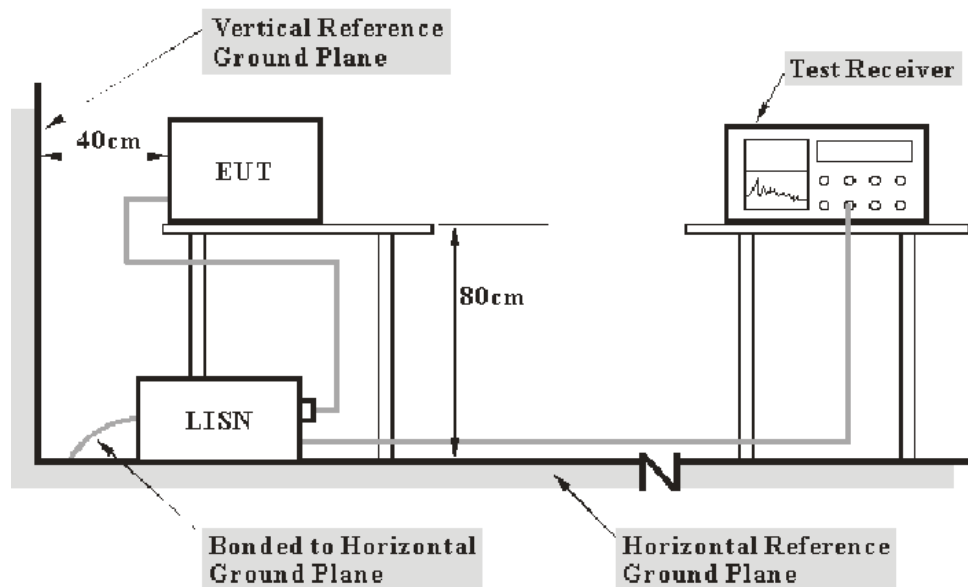

- Note: 1. Support units were connected to second LISN.
 2. Both of LISNs (AMN) 80 cm from EUT and at the least 80 cm from other units and other metal planes support units.

The setup of EUT is according with per ANSI C63.4-2003 measurement procedure. The specification used was with the FCC Part 15.107 Class B limits.

The adapter was connected to a 120 VAC/60 Hz power source.

EMI Test Receiver Setup

The EMI test receiver was set to investigate the spectrum from 150 kHz to 30 MHz.

During the conducted emission test, the EMI test receiver was set with the following configurations:

<i>Frequency Range</i>	<i>IF B/W</i>
150 kHz – 30 MHz	9 kHz

Test Procedure

During the conducted emission test, the adapter was connected to the outlet of the first LISN and the other support equipments were connected to the outlet of the second LISN.

Maximizing procedure was performed on the six (6) highest emissions of the EUT.

All data was recorded in the Quasi-peak and average detection mode.

Corrected Amplitude & Margin Calculation

The basic equation is as follows:

$$V_C = V_R + A_C + VDF$$

$$C_f = A_C + VDF$$

Herein,

V_C (cord. Reading): corrected voltage amplitude

V_R : reading voltage amplitude

A_C : attenuation caused by cable loss

VDF : voltage division factor of AMN

C_f : Correction Factor

The “**Margin**” column of the following data tables indicates the degree of compliance within the applicable limit. For example, a margin of 7dB means the emission is 7dB below the maximum limit. The equation for margin calculation is as follows:

$$\text{Margin} = \text{Limit} - \text{Corrected Amplitude}$$

Test Equipment List and Details

Manufacturer	Description	Model	Serial Number	Calibration Date	Calibration Due Date
R&S	EMI Test Receiver	ESCS 30	830245/006	2012-11-29	2013-11-28
R&S	LISN1	ESH3-Z5	843331/015	2012-09-17	2013-09-16
R&S	LISN2	ESH3-Z5	100113	2012-11-29	2013-11-28
BACL	Test Software	BACL-EMC	V1.0-2010	N/A	N/A

* Statement of Traceability: Bay Area Compliance Laboratories Corp. (Dongguan) attests that all calibrations have been performed in accordance to NVLAP requirements, traceable to National Primary Standards and International System of Units (SI).

Test Results Summary

According to the recorded data in following table, the EUT complied with the FCC Part 15.107, with the worst margin reading of:

12.28 dB at 0.260 MHz in the **Neutral** conducted mode.

Test Data

Environmental Conditions

Temperature:	26.1 °C
Relative Humidity:	61 %
ATM Pressure:	100.4 kPa

The testing was performed by Leon Chen on 2013-03-28.

Test mode: operating

120 V, 60 Hz, Line:

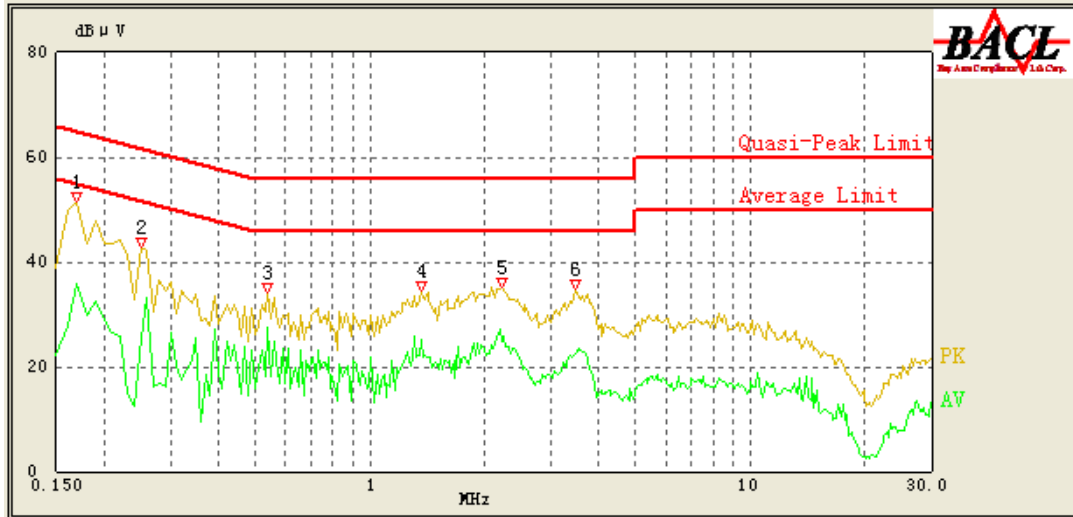

Frequency (MHz)	Cord. Reading (dBμV)	Correction Factor (dB)	Limit (dBμV)	Margin (dB)	Detector (PK/AV/QP)
0.170	49.08	1.03	65.43	16.35	QP
0.170	35.92	1.03	55.43	19.51	AV
0.250	37.31	0.89	63.14	25.83	QP
0.250	25.57	0.89	53.14	27.57	AV
0.540	31.41	0.51	56.00	24.59	QP
0.540	27.55	0.51	46.00	18.45	AV
1.360	31.22	0.33	56.00	24.78	QP
1.360	25.20	0.33	46.00	20.80	AV
2.230	30.37	0.37	56.00	25.63	QP
2.220	24.76	0.37	46.00	21.24	AV
3.470	28.95	0.41	56.00	27.05	QP
3.470	22.40	0.41	46.00	23.60	AV

120 V, 60 Hz, Neutral:

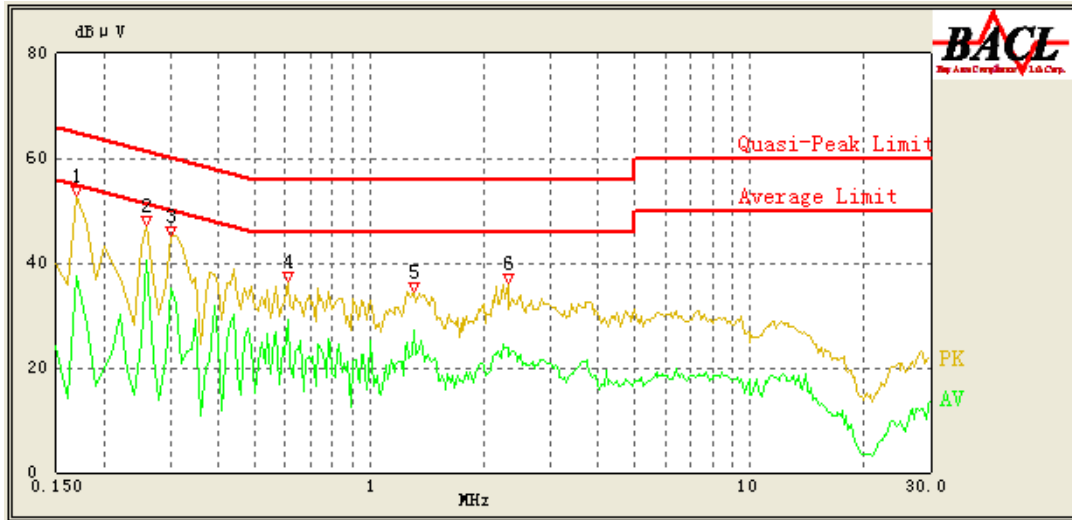

Frequency (MHz)	Cord. Reading (dBμV)	Correction Factor (dB)	Limit (dBμV)	Margin (dB)	Detector (PK/AV/QP)
0.170	49.37	1.74	65.43	16.06	QP
0.170	37.38	1.74	55.43	18.05	AV
0.260	44.13	1.28	62.86	18.73	QP
0.260	40.58	1.28	52.86	12.28	AV
0.300	42.58	1.07	61.71	19.13	QP
0.300	35.28	1.07	51.71	16.43	AV
0.610	34.44	0.48	56.00	21.56	QP
0.610	29.23	0.48	46.00	16.77	AV
1.310	32.67	0.24	56.00	23.33	QP
1.310	27.06	0.24	46.00	18.94	AV
2.320	31.04	0.28	56.00	24.96	QP
2.320	23.86	0.28	46.00	22.14	AV

FCC §15.109 - RADIATED EMISSIONS

Measurement Uncertainty

Compliance or non-compliance with a disturbance limit shall be determined in the following manner:

If U_{lab} is less than or equal to U_{cispr} of Table 2, then:

- compliance is deemed to occur if no measured disturbance level exceeds the disturbance limit;
- non-compliance is deemed to occur if any measured disturbance level exceeds the disturbance limit.

If U_{lab} is greater than U_{cispr} of Table 1, then:

- compliance is deemed to occur if no measured disturbance level, increased by $(U_{lab} - U_{cispr})$, exceeds the disturbance limit;
- non-compliance is deemed to occur if any measured disturbance level, increased by $(U_{lab} - U_{cispr})$, exceeds the disturbance limit.

Based on CISPR 16-4-2: 2011, measurement uncertainty of radiated emission at a distance of 3m at Bay Area Compliance Laboratories Corp. (Dongguan) is:

- 30M~200MHz: 5.0 dB
- 200M~1GHz: 6.2 dB
- 1G~6GHz: 4.45 dB
- 6G~18GHz: 5.23 dB

Table 2 – Values of U_{cispr}

Measurement	U_{cispr}
Radiated disturbance (electric field strength at an OATS or in a SAC) (30 MHz to 1000 MHz)	6.3 dB
Radiated disturbance (electric field strength in a FAR) (1 GHz to 6 GHz)	5.2 dB
Radiated disturbance (electric field strength in a FAR) (6 GHz to 18 GHz)	5.5 dB

EUT Setup

Below 1 GHz:

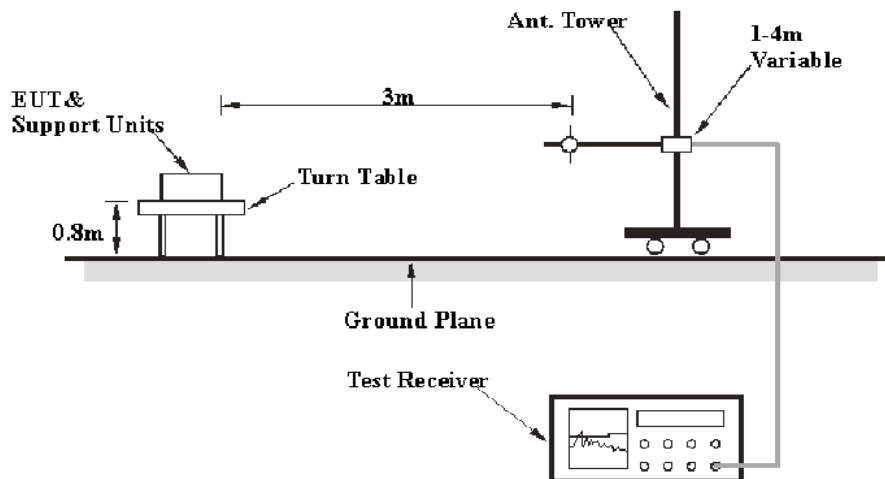

Above 1 G:

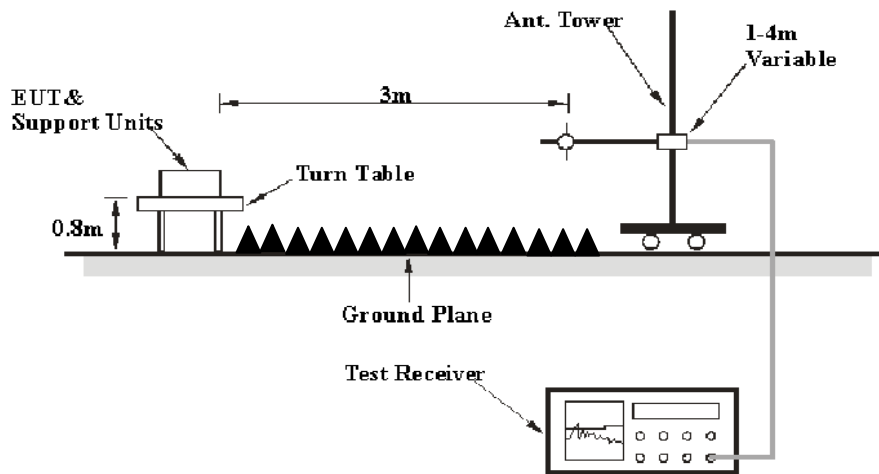

The radiated emission tests were performed in the 3 meters chamber test site, using the setup accordance with the ANSI C63.4-2003. The specification used was the FCC Part 15.109, Class B limits.

The external I/O cables were draped along the test table and formed a bundle 30 to 40 cm long in the middle.

The adapter connected to a 120 VAC/60 Hz power source.

EMI Test Receiver Setup

According to FCC 15.33 requirements, the system was measured from 30 MHz to 6 GHz.

During the radiated emission test, the EMI test receiver was set with the following configurations:

<i>Frequency Range</i>	<i>RBW</i>	<i>Video B/W</i>	<i>Detector</i>
30 MHz – 1000 MHz	120 kHz	300 kHz	QP
Above 1 GHz	1MHz	3 MHz	Peak
Above 1 GHz	1MHz	10 Hz	Ave

Test Procedure

For the radiated emissions test, the adapter was connected to the first AC floor outlet and the other support equipments were connected to the second AC floor outlet.

Maximizing procedure was performed on the highest emissions to ensure that the EUT complied with all installation combinations.

The data was recorded in Quasi-peak detection mode for 30 MHz to 1 GHz, Peak and average detection mode above 1 GHz.

Corrected Amplitude & Margin Calculation

The Corrected Amplitude is calculated by adding the Antenna Loss and Cable Loss, and subtracting the Amplifier Gain from the Meter Reading. The basic equation is as follows:

$$\text{Corrected Amplitude} = \text{Meter Reading} + \text{Antenna Loss} + \text{Cable Loss} - \text{Amplifier Gain}$$

The “**Margin**” column of the following data tables indicates the degree of compliance with the applicable limit. For example, a margin of 7dB means the emission is 7dB below the limit. The equation for margin calculation is as follows:

$$\text{Margin} = \text{Limit} - \text{Corrected Amplitude}$$

Test Equipment List and Details

Manufacturer	Description	Model	Serial Number	Calibration Date	Calibration Due Date
R&S	EMI TEST RECIEVER	ESCI	100224	2012-5-14	2013-5-13
Sunol Sciences	Antenna	JB3	A060611-1	2012-9-6	2013-9-5
HP	HP AMPLIFIER	8447E	2434A02181	N/A	N/A
R&S	Spectrum analyzer	FSEM 30	849016/001	2012-9-4	2013-9-3
ETS LINDGREN	horn antenna	3115	000 527 35	2012-9-6	2013-9-5
Mini-Circuit	Amplifier	ZVA-213-S+	054201245	N/A	N/A
Rohde & Schwarz	Spectrum Analyzer	FSP38	100478	2012-5-14	2013-5-13

* Statement of Traceability: Bay Area Compliance Laboratories Corp. (Dongguan) attests that all calibrations have been performed in accordance to NVLAP requirements, traceable to National Primary Standards and International System of Units (SI).

Test Results Summary

According to the data in the following table, the EUT complied with the FCC §15.109, Class B, with the worst margin reading of:

3.17 dB at 79.4700 MHz in the Vertical polarization below 1GHz

Test Data

Environmental Conditions

Temperature:	24.8°C
Relative Humidity:	68 %
ATM Pressure:	100.8 kPa

The testing was performed by Leon Chen on 2013-03-27

Test mode: operating

Below 1G:

Horizontal:

80.0 dBuV/m

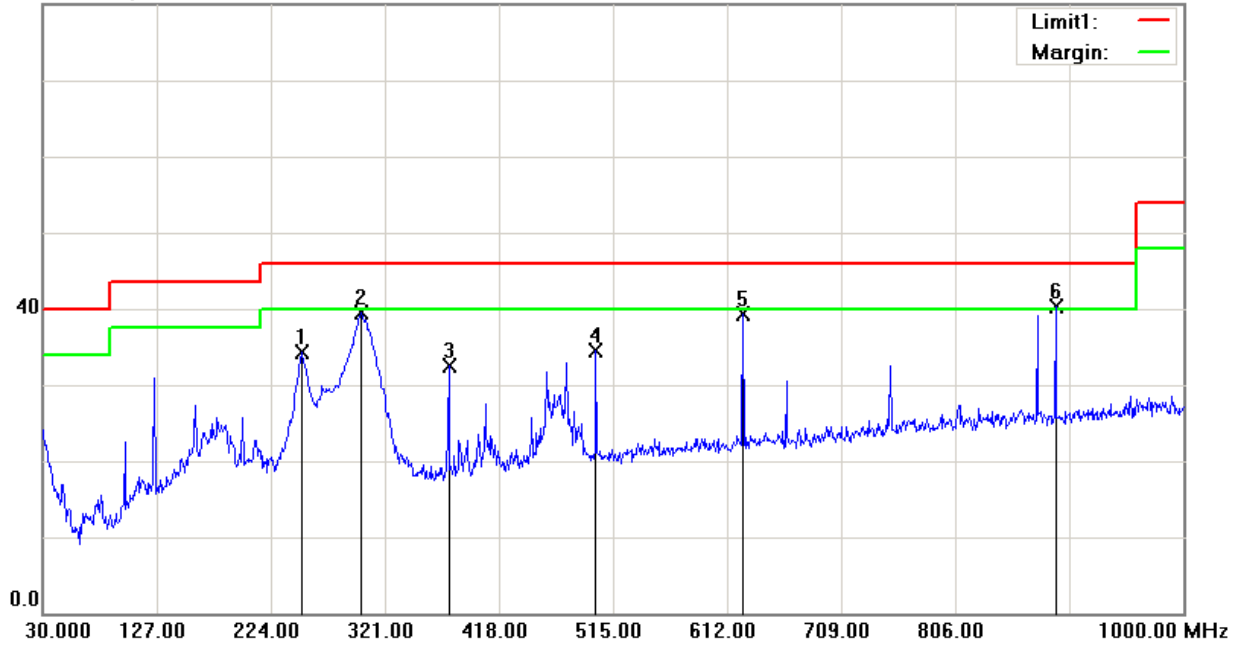

Frequency (MHz)	Receiver Reading (dBuV/m)	Detector (PK/QP/Ave)	Correction Factor (dB)	Cord. Amp. (dBuV/m)	Limit (dBuV/m)	Margin (dB)
250.1900	42.57	QP	-8.18	34.39	46.00	11.61
300.6300	45.67	QP	-6.17	39.50	46.00	6.50
375.3200	37.00	QP	-4.50	32.50	46.00	13.50
500.4500	36.75	QP	-2.27	34.48	46.00	11.52
625.5800	39.88	QP	-0.50	39.38	46.00	6.62
891.3600	37.54	QP	2.85	40.39	46.00	5.61*

*Within measurement uncertainty!

Vertical:

80.0 dBuV/m

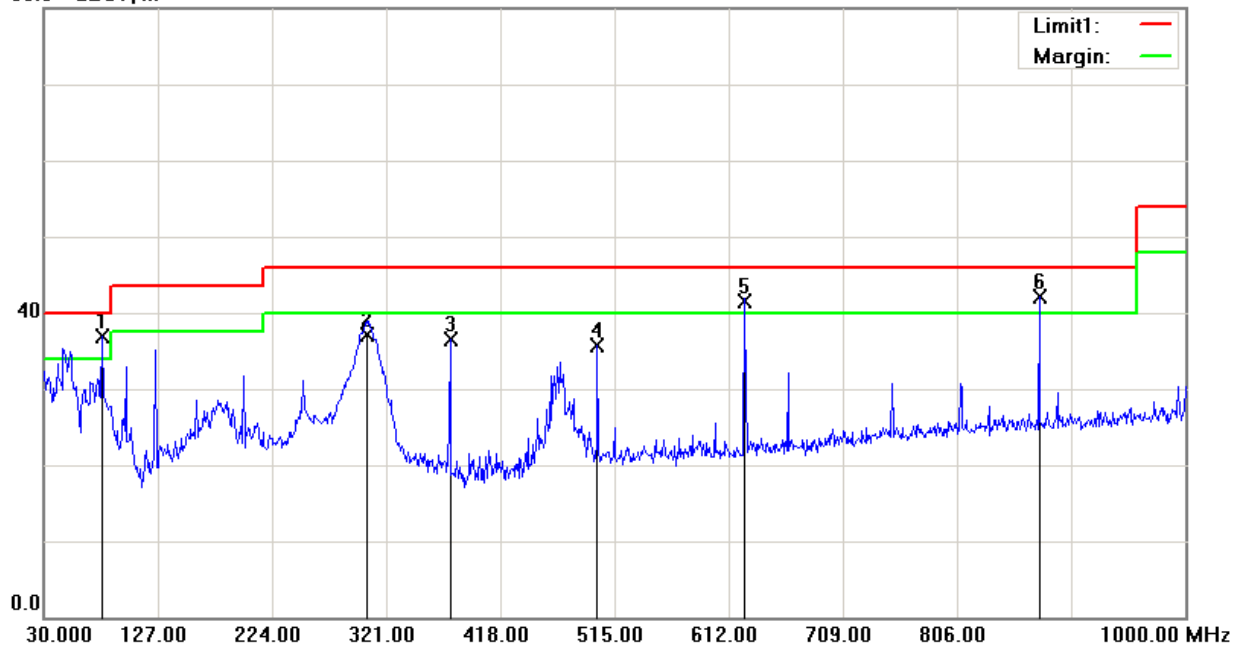

Frequency (MHz)	Receiver Reading (dBuV/m)	Detector (PK/QP/Ave)	Correction Factor (dB)	Cord. Amp. (dBuV/m)	Limit (dBuV/m)	Margin (dB)
79.4700	49.43	QP	-12.60	36.83	40.00	3.17*
304.5100	43.08	QP	-6.03	37.05	46.00	8.95
375.3200	41.02	QP	-4.50	36.52	46.00	9.48
500.4500	37.96	QP	-2.27	35.69	46.00	10.31
625.5800	42.07	QP	-0.50	41.57	46.00	4.43*
875.8400	39.51	QP	2.57	42.08	46.00	3.92*

*Within measurement uncertainty!

Above 1G:

Horizontal:

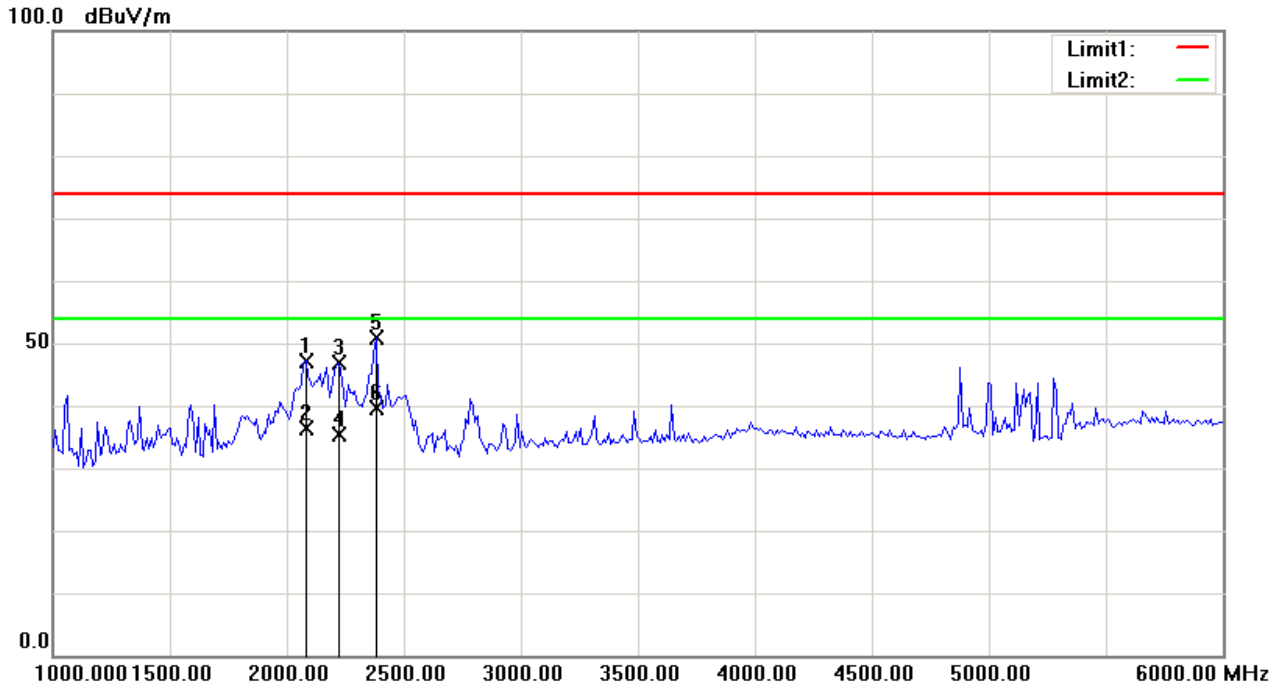

Frequency (MHz)	Receiver Reading (dBuV/m)	Detector (PK/QP/Ave)	Correction Factor (dB)	Cord. Amp. (dBuV/m)	Limit (dBuV/m)	Margin (dB)
2082.164	49.49	peak	-2.37	47.12	74.00	26.88
2082.164	38.84	AVG	-2.37	36.47	54.00	17.53
2222.445	48.86	peak	-2.07	46.79	74.00	27.21
2222.445	37.39	AVG	-2.07	35.32	54.00	18.68
2382.765	52.54	peak	-1.54	51.00	74.00	23.00
2382.765	41.10	AVG	-1.54	39.56	54.00	14.44

Vertical:

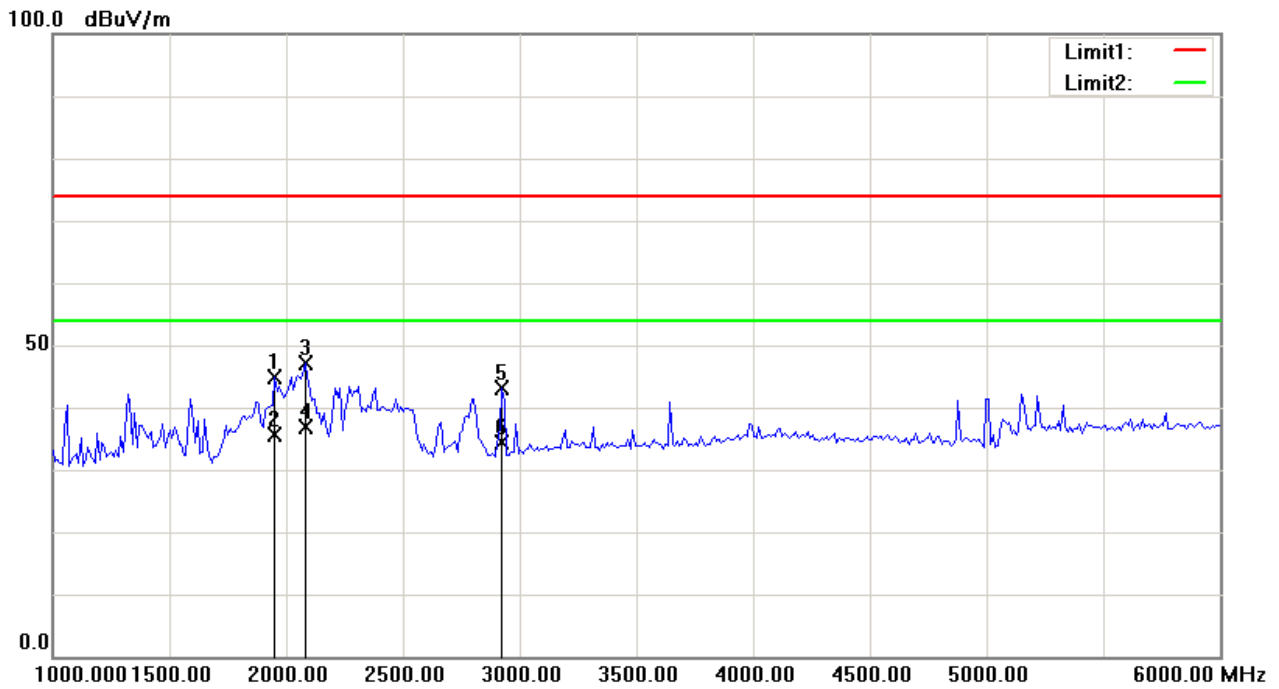

Frequency (MHz)	Receiver Reading (dBuV/m)	Detector (PK/QP/Ave)	Correction Factor (dB)	Cord. Amp. (dBuV/m)	Limit (dBuV/m)	Margin (dB)
1951.904	47.39	peak	-2.60	44.79	74.00	29.21
1951.904	38.27	AVG	-2.60	35.67	54.00	18.33
2082.164	49.39	peak	-2.37	47.02	74.00	26.98
2082.164	39.31	AVG	-2.37	36.94	54.00	17.06
2923.848	43.68	peak	-0.43	43.25	74.00	30.75
2923.848	34.71	AVG	-0.43	34.28	54.00	19.72

***** END OF REPORT *****