

# FCC Radio Test Report

## FCC ID: V7TMESH5

This report concerns (check one):  Original Grant  Class I Change  Class II Change

**Project No.** : 1806C125  
**Equipment** : AC1200 Whole Home Mesh WiFi System  
**Test Model** : Mesh5  
**Series Model** : N/A  
**Applicant** : SHENZHEN TENDA TECHNOLOGY CO.,LTD.  
**Address** : 6-8 Floor, Tower E3, No. 1001, Zhongshanyuan Road, Nanshan District, Shenzhen, China. 518052

**Date of Receipt** : Jun. 21, 2018  
**Date of Test** : Jun. 25, 2018 ~ Jul. 09, 2018  
**Issued Date** : Jul. 17, 2018  
**Tested by** : BTL Inc.

**Testing Engineer** : Jivey Jiang  
(Jivey Jiang)

**Technical Manager** : David Mao  
(David Mao)

**Authorized Signatory** : Steven Lu  
(Steven Lu)

# **B T L I N C .**

No.3, Jinshagang 1st Road, Shixia, Dalang Town, Dongguan, Guangdong, China.

TEL: +86-769-8318-3000 FAX: +86-769-8319-6000



### **Declaration**

**BTL** represents to the client that testing is done in accordance with standard procedures as applicable and that test instruments used has been calibrated with standards traceable to international standard(s) and/or national standard(s).

**BTL's** reports apply only to the specific samples tested under conditions. It is manufacture's responsibility to ensure that additional production units of this model are manufactured with the identical electrical and mechanical components. **BTL** shall have no liability for any declarations, inferences or generalizations drawn by the client or others from **BTL** issued reports.

The report must not be used by the client to claim product certification, approval, or endorsement by NVLAP, NIST, or any agency of the U.S. Government.

This report is the confidential property of the client. As a mutual protection to the clients, the public and ourselves, the test report shall not be reproduced, except in full, without our written approval.

**BTL's** laboratory quality assurance procedures are in compliance with the **ISO Guide 17025** requirements, and accredited by the conformity assessment authorities listed in this test report.

**BTL** is not responsible for the sampling stage, so the results only apply to the sample as received.

The information, data and test plan are provided by manufacturer, so it is manufacturer's responsibility to ensure that the apparatus meets the essential requirements in all the possible configurations as representative of its intended use.

### **Limitation**

For the use of the authority's logo is limited unless the Test Standard(s)/Scope(s)/Item(s) mentioned in this test report is (are) included in the conformity assessment authorities acceptance respective.

<b>Table of Contents</b>	<b>Page</b>
<b>1 . CERTIFICATION</b>	<b>6</b>
<b>2 . SUMMARY OF TEST RESULTS</b>	<b>7</b>
2.1 TEST FACILITY	8
2.2 MEASUREMENT UNCERTAINTY	8
<b>3 . GENERAL INFORMATION</b>	<b>9</b>
3.1 GENERAL DESCRIPTION OF EUT	9
3.2 DESCRIPTION OF TEST MODES	11
3.3 TABLE OF PARAMETERS OF TEXT SOFTWARE SETTING	13
3.4 BLOCK DIAGRAM SHOWING THE CONFIGURATION OF SYSTEM TESTED	14
3.5 DESCRIPTION OF SUPPORT UNITS	14
<b>4 . EMC EMISSION TEST</b>	<b>15</b>
4.1 CONDUCTED EMISSION MEASUREMENT	15
4.1.1 POWER LINE CONDUCTED EMISSION LIMITS	15
4.1.2 TEST PROCEDURE	15
4.1.3 DEVIATION FROM TEST STANDARD	15
4.1.4 TEST SETUP	16
4.1.5 EUT OPERATING CONDITIONS	16
4.1.6 EUT TEST CONDITIONS	16
4.1.7 TEST RESULTS	16
4.2 RADIATED EMISSION MEASUREMENT	17
4.2.1 RADIATED EMISSION LIMITS	17
4.2.2 TEST PROCEDURE	18
4.2.3 DEVIATION FROM TEST STANDARD	18
4.2.4 TEST SETUP	19
4.2.5 EUT OPERATING CONDITIONS	20
4.2.6 EUT TEST CONDITIONS	20
4.2.7 TEST RESULTS (9KHZ TO 30MHZ)	20
4.2.8 TEST RESULTS (30MHZ TO 1000MHZ)	20
4.2.9 TEST RESULTS (ABOVE 1000MHZ)	20
<b>5 . BANDWIDTH TEST</b>	<b>21</b>
5.1 APPLIED PROCEDURES	21
5.1.1 TEST PROCEDURE	21
5.1.2 DEVIATION FROM STANDARD	21
5.1.3 TEST SETUP	21
5.1.4 EUT OPERATION CONDITIONS	21
5.1.5 EUT TEST CONDITIONS	21
5.1.6 TEST RESULTS	21
<b>6 . MAXIMUM PEAK CONDUCTED OUTPUT POWER TEST</b>	<b>22</b>

<b>Table of Contents</b>	<b>Page</b>
<b>6.1 APPLIED PROCEDURES / LIMIT</b>	<b>22</b>
6.1.1 TEST PROCEDURE	22
6.1.2 DEVIATION FROM STANDARD	22
6.1.3 TEST SETUP	22
6.1.4 EUT OPERATION CONDITIONS	22
6.1.5 EUT TEST CONDITIONS	22
6.1.6 TEST RESULTS	22
<b>7 . ANTENNA CONDUCTED SPURIOUS EMISSION</b>	<b>23</b>
7.1 APPLIED PROCEDURES / LIMIT	23
7.1.1 TEST PROCEDURE	23
7.1.2 DEVIATION FROM STANDARD	23
7.1.3 TEST SETUP	23
7.1.4 EUT OPERATION CONDITIONS	23
7.1.5 EUT TEST CONDITIONS	23
7.1.6 TEST RESULTS	23
<b>8 . POWER SPECTRAL DENSITY TEST</b>	<b>24</b>
8.1 APPLIED PROCEDURES / LIMIT	24
8.1.1 TEST PROCEDURE	24
8.1.2 DEVIATION FROM STANDARD	24
8.1.3 TEST SETUP	24
8.1.4 EUT OPERATION CONDITIONS	24
8.1.5 EUT TEST CONDITIONS	24
8.1.6 TEST RESULTS	24
<b>9 . MEASUREMENT INSTRUMENTS LIST</b>	<b>25</b>
<b>10 . EUT TEST PHOTO</b>	<b>27</b>
<b>APPENDIX A - CONDUCTED EMISSION</b>	<b>34</b>
<b>APPENDIX B - RADIATED EMISSION (9KHZ TO 30MHZ)</b>	<b>39</b>
<b>APPENDIX C - RADIATED EMISSION (30MHZ TO 1000MHZ)</b>	<b>48</b>
<b>APPENDIX D - RADIATED EMISSION (ABOVE 1000MHZ)</b>	<b>61</b>
<b>APPENDIX E - BANDWIDTH</b>	<b>110</b>
<b>APPENDIX F - MAXIMUM PEAK CONDUCTED OUTPUT POWER</b>	<b>123</b>
<b>APPENDIX G - ANTENNA CONDUCTED SPURIOUS EMISSION</b>	<b>129</b>
<b>APPENDIX H - POWER SPECTRAL DENSITY</b>	<b>192</b>

### REPORT ISSUED HISTORY

Issued No.	Description	Issued Date
BTL-FCCP-1-1806C125	Original Issue.	Jul. 16, 2018
MDG1807017	Change the applicant and manufacturer.	Jul. 17, 2018

## 1. CERTIFICATION

Equipment : AC1200 Whole Home Mesh WiFi System  
Brand Name : Tenda  
Test Model : Mesh5  
Series Model : N/A  
Applicant : SHENZHEN TENDA TECHNOLOGY CO.,LTD.  
Manufacturer : SHENZHEN TENDA TECHNOLOGY CO.,LTD.  
Address : 6-8 Floor, Tower E3, No. 1001, Zhongshanyuan Road, Nanshan District,  
Shenzhen, China. 518052  
Date of Test : Jun. 25, 2018 ~ Jul. 09, 2018  
Test Sample : Engineering Sample No.:D180605171  
Standard(s) : FCC Part15, Subpart C (15.247) / ANSI C63.10-2013

The above equipment has been tested and found compliance with the requirement of the relative standards by BTL Inc.

The test data, data evaluation, and equipment configuration contained in our test report (Ref No. BTL-FCCP-1-1806C125) were obtained utilizing the test procedures, test instruments, test sites that has been accredited by the Authority of NVLAP according to the ISO-17025 quality assessment standard and technical standard(s).

## 2. SUMMARY OF TEST RESULTS

Test procedures according to the technical standard(s):

Applied Standard(s): FCC Part15 (15.247) , Subpart C			
Standard(s) Section	Test Item	Judgment	Remark
15.207	Conducted Emission	PASS	
15.247(d)	Antenna conducted Spurious Emission	PASS	
15.247(a)(2)	6dB Bandwidth	PASS	
15.247(b)(3)	Peak Output Power	PASS	
15.247(e)	Power Spectral Density	PASS	
15.203	Antenna Requirement	PASS	
15.247(d)/ 15.205/ 15.209	Transmitter Radiated Emissions	PASS	

**NOTE:**

(1) "N/A" denotes test is not applicable in this test report.

## 2.1 TEST FACILITY

The test facilities used to collect the test data in this report is at the location of No.3,Jinshagang 1st Road, Shixia, Dalang Town, Dongguan, Guangdong, China.

BTL's test firm number for FCC: 854385

BTL's designation number for FCC: CN5020

## 2.2 MEASUREMENT UNCERTAINTY

The measurement uncertainty figures shall be calculated according the methods described in the ETSI TR 100 028 and shall correspond to an expansion factor (coverage factor)  $k=1.96$  or  $k=2$ (which provide confidence levels of respectively 90% and 95.45% in the case where the distributions characterizing the actual measurement uncertainties are normal (Gaussian)). Measurement Uncertainty for a Level of Confidence of 95 %,  $U=2xUc(y)$ .

The BTL measurement uncertainty as below table:

### A. Conducted Measurement:

Test Site	Method	Measurement Frequency Range	U, (dB)
DG-C02	CISPR	150 KHz ~ 30MHz	2.32

### B. Radiated Measurement:

Test Site	Method	Measurement Frequency Range	Ant. H / V	U, (dB)
DG-CB03	CISPR	9KHz~30MHz	V	3.79
		9KHz~30MHz	H	3.57
		30MHz ~ 200MHz	V	3.82
		30MHz ~ 200MHz	H	3.78
		200MHz ~ 1,000MHz	V	4.10
		200MHz ~ 1,000MHz	H	4.06
		1GHz~18GHz	V	3.12
		1GHz~18GHz	H	3.68
		18GHz~40GHz	V	4.15
		18GHz~40GHz	H	4.14

Note: Unless specifically mentioned, the uncertainty of measurement has not been taken into account to declare the compliance or non-compliance to the specification.



### 3. GENERAL INFORMATION

#### 3.1 GENERAL DESCRIPTION OF EUT

Equipment	AC1200 Whole Home Mesh WiFi System	
Brand Name	Tenda	
Test Model	Mesh5	
Series Model	N/A	
Model Difference	N/A	
Product Description	Operation Frequency	2412~2462 MHz
	Modulation Technology	802.11b:DSSS 802.11g:OFDM 802.11n:OFDM
	Bit Rate of Transmitter	802.11b: 11/5.5/2/1 Mbps 802.11g: 54/48/36/24/18/12/9/6 Mbps 802.11n up to 300 Mbps
	Output Power (Max.) Non-Beamforming	802.11b: 29.56dBm 802.11g: 29.85dBm 802.11n(20MHz): 29.57dBm 802.11n(40MHz): 29.77dBm
	Output Power (Max.) Beamforming	802.11n(20MHz): 26.55dBm 802.11n(40MHz): 26.82dBm
Power Source	DC voltage supplied from AC/DC adapter. #1 Model:BN071-A12012U #2 Model:BN036-A12012U	
Power Rating	#1 I/P:100-240V~50/60Hz 0.4A O/P:12V $\equiv$ 1.0A #2 I/P:100-240V~50/60Hz 0.4A O/P:12V $\equiv$ 1.0A	

Note:

- For a more detailed features description, please refer to the manufacturer's specifications or the user's manual.
- Channel List:

CH01 - CH11 for 802.11b, 802.11g, 802.11n(20MHz) CH03 - CH09 for 802.11n(40MHz)							
Channel	Frequency (MHz)	Channel	Frequency (MHz)	Channel	Frequency (MHz)	Channel	Frequency (MHz)
01	2412	04	2427	07	2442	10	2457
02	2417	05	2432	08	2447	11	2462
03	2422	06	2437	09	2452		

### 3. Table for Filed Antenna

Ant.	Brand	Model Name	Antenna Type	Connector	Gain (dBi)
1	Tenda	N/A	PCB	IPEX	3
2	Tenda	N/A	PCB	IPEX	3

Note:

The EUT incorporates a MIMO function. Physically, the EUT provides two completed transmitters and receivers (2T2R), all transmit signals are completely correlated, then,

for non-beamforming function,

Direction gain =  $G_{ANT} + 10\log(N)$  dBi =  $3 + 10\log(2)$ , that is Directional gain = 6.01.

So, the out power limit is  $30 - 6.01 + 6 = 29.99$ ,

the power density limit is  $17 - 6.01 + 6 = 16.99$ .

for beamforming function,

Beamforming Gain = 3 dBi, Direction gain = 6.01.

So, the out power limit is  $30 - 6.01 - 3 + 6 = 26.99$ ,

the power density limit is  $17 - 6.01 - 3 + 6 = 13.99$ .

### 3.2 DESCRIPTION OF TEST MODES

To investigate the maximum EMI emission characteristics generated from EUT, the test system was pre-scanning tested based on the consideration of following EUT operation mode or test configuration mode which possibly have effect on EMI emission level. Each of these EUT operation mode(s) or test configuration mode(s) mentioned above was evaluated respectively.

Pretest Mode	Description
Mode 1	TX B MODE CHANNEL 01/06/11
Mode 2	TX G MODE CHANNEL 01/06/11
Mode 3	TX N-20MHZ MODE CHANNEL 01/06/11
Mode 4	TX N-40MHZ MODE CHANNEL 03/06/09
Mode 5	TX MODE

The EUT system operated these modes were found to be the worst case during the pre-scanning test as following:

For Conducted Test	
Final Test Mode	Description
Mode 5	TX MODE

For Radiated Test	
Final Test Mode	Description
Mode 1	TX B MODE CHANNEL 01/06/11
Mode 2	TX G MODE CHANNEL 01/06/11
Mode 3	TX N-20MHZ MODE CHANNEL 01/06/11
Mode 4	TX N-40MHZ MODE CHANNEL 03/06/09

For Band Edge Test	
Final Test Mode	Description
Mode 1	TX B MODE CHANNEL 01/06/11
Mode 2	TX G MODE CHANNEL 01/06/11
Mode 3	TX N-20MHZ MODE CHANNEL 01/06/11
Mode 4	TX N-40MHZ MODE CHANNEL 03/06/09

6dB Spectrum Bandwidth	
Final Test Mode	Description
Mode 1	TX B MODE CHANNEL 01/06/11
Mode 2	TX G MODE CHANNEL 01/06/11
Mode 3	TX N-20MHZ MODE CHANNEL 01/06/11
Mode 4	TX N-40MHZ MODE CHANNEL 03/06/09

Maximum Conducted Output Power	
Final Test Mode	Description
Mode 1	TX B MODE CHANNEL 01/06/11
Mode 2	TX G MODE CHANNEL 01/06/11
Mode 3	TX N-20MHZ MODE CHANNEL 01/06/11
Mode 4	TX N-40MHZ MODE CHANNEL 03/06/09

Power Spectral Density	
Final Test Mode	Description
Mode 1	TX B MODE CHANNEL 01/06/11
Mode 2	TX G MODE CHANNEL 01/06/11
Mode 3	TX N-20MHZ MODE CHANNEL 01/06/11
Mode 4	TX N-40MHZ MODE CHANNEL 03/06/09

**Note:**

- (1) The measurements are performed at the high, middle, low available channels.
- (2) 802.11b mode: DBPSK (1Mbps)  
 802.11g mode: OFDM (6Mbps)  
 802.11n HT20 mode : BPSK (13Mbps)  
 802.11n HT40 mode : BPSK (27Mbps)  
 For radiated emission tests, the highest output powers were set for final test.
- (3) For radiated below 1G test, the 802.11b is found to be the worst case and recorded.
- (4) The EUT was programmed to be in continuously transmitting mode and the transmit duty cycle is not less than 98%.

### 3.3 TABLE OF PARAMETERS OF TEXT SOFTWARE SETTING

During testing, channel & power controlling software provided by the customer was used to control the operating channel as well as the output power level. The RF output power selection is for the setting of RF output power expected by the customer and is going to be fixed on the firmware of the final end product power parameters of WLAN

#### Non-Beamforming

Test software version	MP_TEST		
Frequency (MHz)	2412	2437	2462
802.11b	33	44	40
802.11g	29	31	33
802.11n (20MHz)	24/27	25/28	26/29
Frequency (MHz)	2422	2437	2452
802.11n (40MHz)	26/29	27/29	28/30

#### Beamforming

Test software version	MP_TEST		
Frequency (MHz)	2412	2437	2462
802.11n (20MHz)	24/27	25/28	26/29
Frequency (MHz)	2422	2437	2452
802.11n (40MHz)	26/29	27/29	28/30

### 3.4 BLOCK DIAGRAM SHOWING THE CONFIGURATION OF SYSTEM TESTED

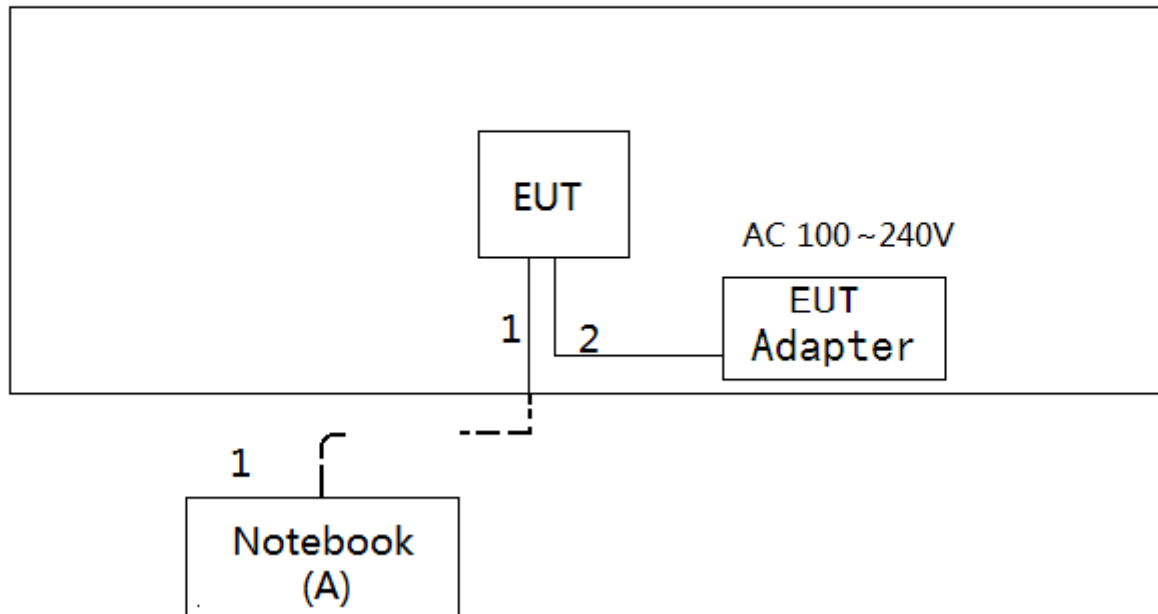

### 3.5 DESCRIPTION OF SUPPORT UNITS

The EUT has been tested as an independent unit together with other necessary accessories or support units. The following support units or accessories were used to form a representative test configuration during the tests.

Item	Equipment	Mfr/Brand	Model/Type No.	FCC ID	Series No.
A	NOTEBOOK	DELL	INSPIRON 1420	N/A	JX193A01SDC2

Item	Shielded Type	Ferrite Core	Length	Note
1	NO	NO	10m	RJ45
2	NO	NO	1.2m	DC Cable

## 4. EMC EMISSION TEST

### 4.1 CONDUCTED EMISSION MEASUREMENT

#### 4.1.1 POWER LINE CONDUCTED EMISSION LIMITS (Frequency Range 150KHz-30MHz)

Frequency of Emission (MHz)	Conducted Limit (dB $\mu$ V)	
	Quasi-peak	Average
0.15 -0.50	60 to 56*	56 to 46*
0.50 -5.0	56	46
5.0 -30.0	60	50

Note:

- (1) The limit of " \* " decreases with the logarithm of the frequency
- (2) The test result calculated as following:  
 Measurement Value = Reading Level + Correct Factor  
 Correct Factor = Insertion Loss + Cable Loss + Attenuator Factor(if use)  
 Margin Level = Measurement Value - Limit Value

The following table is the setting of the receiver

Receiver Parameters	Setting
Attenuation	10 dB
Start Frequency	0.15 MHz
Stop Frequency	30 MHz
IF Bandwidth	9 KHz

#### 4.1.2 TEST PROCEDURE

- a. The EUT was placed 0.8 meters from the horizontal ground plane with EUT being connected to the power mains through a line impedance stabilization network (LISN). All other support equipment powered from additional LISN(s). The LISN provide 50 Ohm/ 50uH of coupling impedance for the measuring instrument.
- b. Interconnecting cables that hang closer than 40 cm to the ground plane shall be folded back and forth in the center forming a bundle 30 to 40 cm long.
- c. I/O cables that are not connected to a peripheral shall be bundled in the center. The end of the cable may be terminated, if required, using the correct terminating impedance. The overall length shall not exceed 1 m.
- d. LISN at least 80 cm from nearest part of EUT chassis.
- e. For the actual test configuration, please refer to the related Item -EUT Test Photos.

#### 4.1.3 DEVIATION FROM TEST STANDARD

No deviation

#### 4.1.4 TEST SETUP

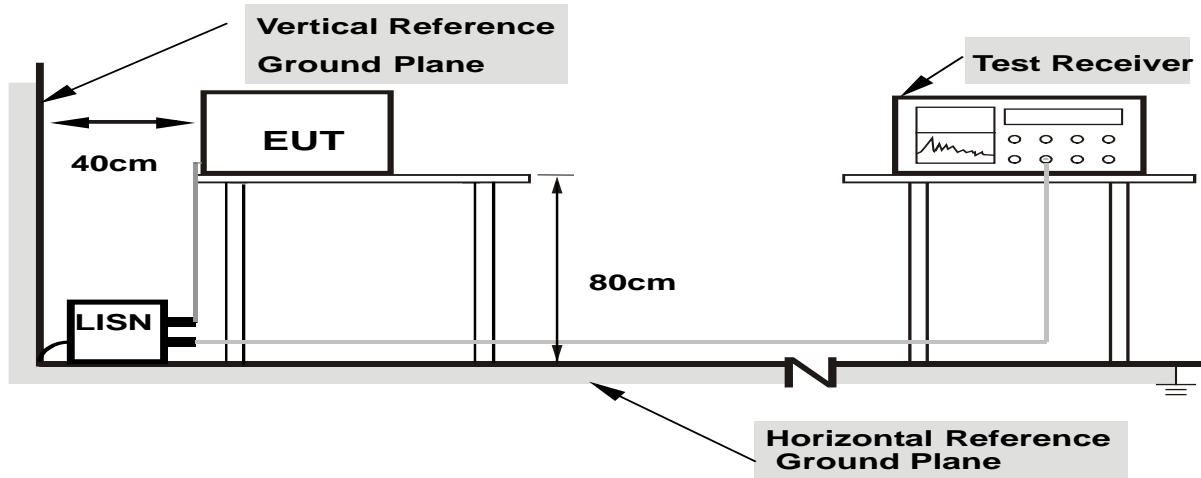

- Note:**
1. Support units were connected to second LISN.
  2. Both of LISNs (AMN) are 80 cm from EUT and at least 80 from other units and other metal planes

#### 4.1.5 EUT OPERATING CONDITIONS

The EUT was placed on the test table and programmed in normal function.

#### 4.1.6 EUT TEST CONDITIONS

Temperature: 25°C    Relative Humidity: 55%    Test Voltage: AC 120V/60Hz

#### 4.1.7 TEST RESULTS

Please refer to the Appendix A.



## 4.2 RADIATED EMISSION MEASUREMENT

### 4.2.1 RADIATED EMISSION LIMITS

In case the emission fall within the restricted band specified on 15.205(a), then the 15.209(a) limit in the table below has to be followed.

#### LIMITS OF RADIATED EMISSION MEASUREMENT (9KHz-1000MHz)

Frequency (MHz)	Field Strength (microvolts/meter)	Measurement Distance (meters)
0.009~0.490	2400/F(KHz)	300
0.490~1.705	24000/F(KHz)	30
1.705~30.0	30	30
30~88	100	3
88~216	150	3
216~960	200	3
960~1000	500	3

#### LIMITS OF RADIATED EMISSION MEASUREMENT (Above 1000MHz)

Frequency (MHz)	(dBuV/m) (at 3 meters)	
	PEAK	AVERAGE
Above 1000	74	54

#### Notes:

- (1) The limit for radiated test was performed according to FCC PART 15C.
- (2) The tighter limit applies at the band edges.
- (3) Emission level (dBuV/m)=20log Emission level (uV/m).
- (4) The test result calculated as following:  
 Measurement Value = Reading Level + Correct Factor  
 Correct Factor = Antenna Factor + Cable Loss - Amplifier Gain(if use)  
 Margin Level = Measurement Value - Limit Value

Spectrum Parameter	Setting
Attenuation	Auto
Start Frequency	1000 MHz
Stop Frequency	10th carrier harmonic
RBW / VBW (Emission in restricted band)	1MHz / 3MHz for Peak, 1MHz / 1/T for Average

Receiver Parameter	Setting
Attenuation	Auto
Start ~ Stop Frequency	9KHz~90KHz for PK/AVG detector
Start ~ Stop Frequency	90KHz~110KHz for QP detector
Start ~ Stop Frequency	110KHz~490KHz for PK/AVG detector
Start ~ Stop Frequency	490KHz~30MHz for QP detector
Start ~ Stop Frequency	30MHz~1000MHz for QP detector

#### 4.2.2 TEST PROCEDURE

- a. The measuring distance of 3 m shall be used for measurements. The EUT was placed on the top of a rotating table 0.8 meter above the ground at a 3 meter semi-anechoic chamber. The table was rotated 360 degrees to determine the position of the highest radiation.(below 1GHz)
- b. The measuring distance of 3 m shall be used for measurements. The EUT was placed on the top of a rotating table 1.5 meter above the ground at a 3 meter semi-anechoic chamber. The table was rotated 360 degrees to determine the position of the highest radiation.(above 1GHz)
- c. The height of the equipment or of the substitution antenna shall be 0.8m or 1.5m; the height of the test antenna shall vary between 1 m to 4 m. Both horizontal and vertical polarizations of the antenna are set to make the measurement.
- d. For each suspected emission, the EUT was arranged to its worst case and then the antenna was tuned to heights find the maximum reading (used Bore sight function).
- e. The receiver system was set to peak and average detect function and specified bandwidth with maximum hold mode when the test frequency is above 1GHz.
- f. The initial step in collecting radiated emission data is a receiver peak detector mode pre-scanning the measurement frequency range. Significant peaks are then marked and then Quasi Peak detector mode re-measured.
- g. All readings are Peak unless otherwise stated QP in column of Note. Peak denotes that the Peak reading compliance with the QP Limits and then QP Mode measurement didn't perform. (below 1GHz)
- h. All readings are Peak Mode value unless otherwise stated AVG in column of Note. If the Peak Mode Measured value compliance with the Peak Limits and lower than AVG Limits, the EUT shall be deemed to meet both Peak & AVG Limits and then only Peak Mode was measured, but AVG Mode didn't perform. (above 1GHz)
- i. For the actual test configuration, please refer to the related Item -EUT Test Photos.

#### 4.2.3 DEVIATION FROM TEST STANDARD

No deviation

**4.2.4 TEST SETUP**

(A) Radiated Emission Test Set-Up Frequency Below 1 GHz

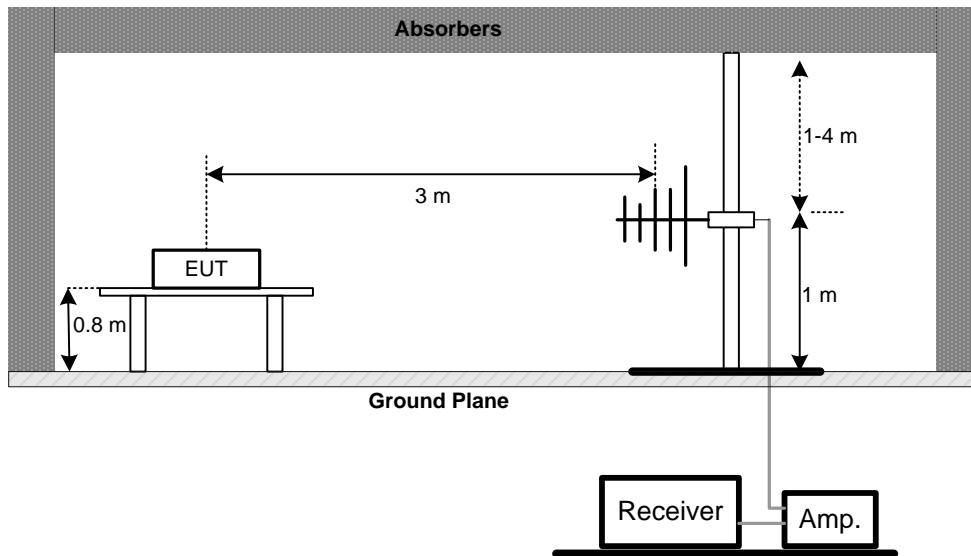

(B) Radiated Emission Test Set-Up Frequency Above 1 GHz

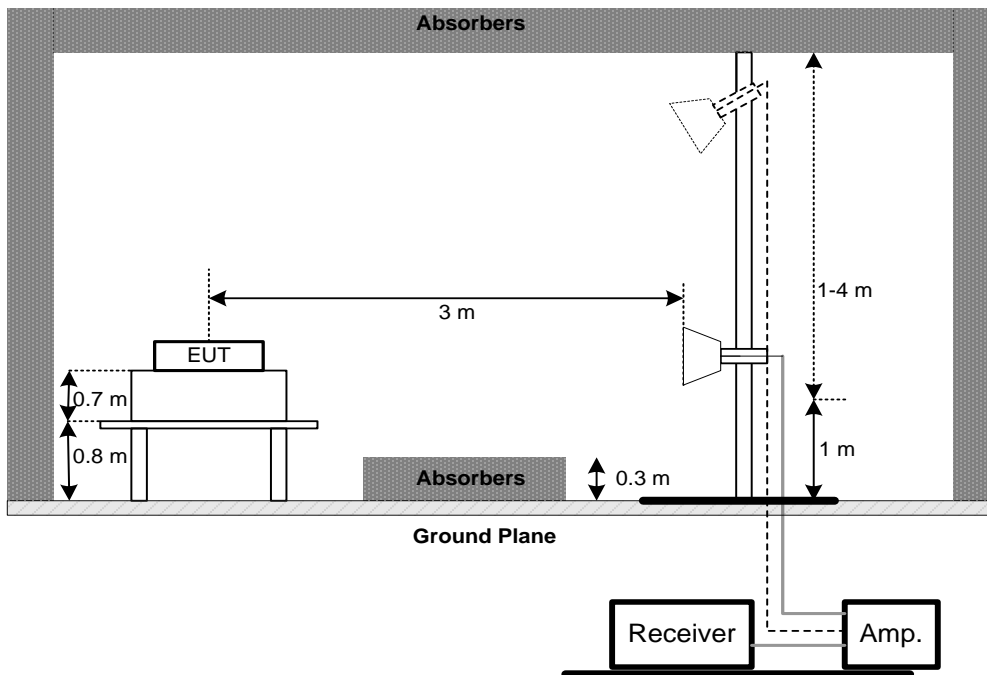

(C) For Radiated Emissions Below 30MHz

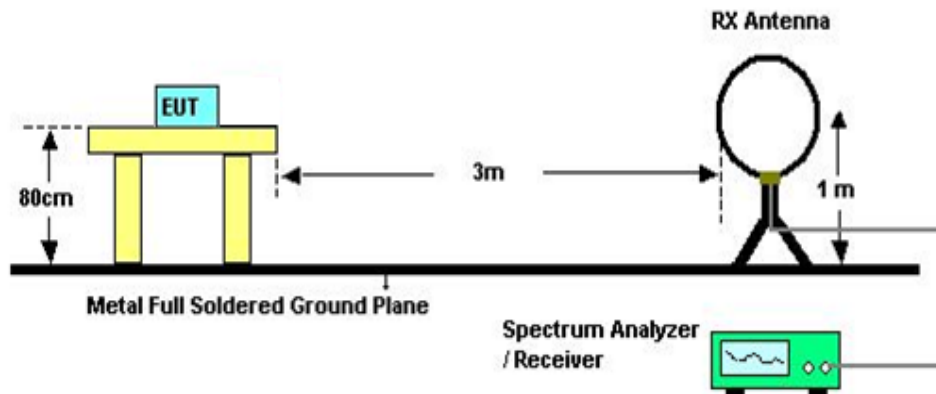

#### 4.2.5 EUT OPERATING CONDITIONS

The EUT was programmed to be in continuously transmitting mode.

#### 4.2.6 EUT TEST CONDITIONS

Temperature: 25°C    Relative Humidity: 55%    Test Voltage: AC 120V/60Hz

#### 4.2.7 TEST RESULTS (9KHZ TO 30MHZ)

Please refer to the Appendix B

Remark:

- (1) The amplitude of spurious emissions which are attenuated by more than 20 dB below the permissible value has no need to be reported.
- (2) Distance extrapolation factor =  $40 \log (\text{specific distance} / \text{test distance})$  (dB).
- (3) Limit line = specific limits (dBuV) + distance extrapolation factor.

#### 4.2.8 TEST RESULTS (30MHZ TO 1000MHZ)

Please refer to the Appendix C.

#### 4.2.9 TEST RESULTS (ABOVE 1000MHZ)

Please refer to the Appendix D.

Remark:

- (1) No limit: This is fundamental signal, the judgment is not applicable.  
For fundamental signal judgment was referred to Peak output test.

## 5. BANDWIDTH TEST

### 5.1 APPLIED PROCEDURES

FCC Part15 (15.247) , Subpart C			
Section	Test Item	Frequency Range (MHz)	Result
15.247(a)(2)	Bandwidth	2400-2483.5	PASS

#### 5.1.1 TEST PROCEDURE

- a. The EUT was directly connected to the spectrum analyzer and antenna output port as show in the block diagram below,
- b. Spectrum Setting: RBW= 100KHz, VBW=300KHz, Sweep time = 2.5 ms.

#### 5.1.2 DEVIATION FROM STANDARD

No deviation.

#### 5.1.3 TEST SETUP



#### 5.1.4 EUT OPERATION CONDITIONS

The EUT was programmed to be in continuously transmitting mode.

#### 5.1.5 EUT TEST CONDITIONS

Temperature: 25°C    Relative Humidity: 55%    Test Voltage: AC 120V/60Hz

#### 5.1.6 TEST RESULTS

Please refer to the Appendix E.

## 6. MAXIMUM PEAK CONDUCTED OUTPUT POWER TEST

### 6.1 APPLIED PROCEDURES / LIMIT

FCC Part15 (15.247) , Subpart C				
Section	Test Item	Limit	Frequency Range (MHz)	Result
15.247(b)(3)	Maximum Output Power	1 Watt or 30dBm	2400-2483.5	PASS

#### 6.1.1 TEST PROCEDURE

- a. The EUT was directly connected to the power meter and antenna output port as show in the block diagram below,
- b. The maximum peak conducted output power was performed in accordance with method 9.1.2 of FCC KDB 558074 D01 v04 DTS Meas Guidance.

#### 6.1.2 DEVIATION FROM STANDARD

No deviation.

#### 6.1.3 TEST SETUP



#### 6.1.4 EUT OPERATION CONDITIONS

The EUT was programmed to be in continuously transmitting mode.

#### 6.1.5 EUT TEST CONDITIONS

Temperature: 25°C    Relative Humidity: 55%    Test Voltage: AC 120V/60Hz

#### 6.1.6 TEST RESULTS

Please refer to the Appendix F.

## 7. ANTENNA CONDUCTED SPURIOUS EMISSION

### 7.1 APPLIED PROCEDURES / LIMIT

In any 100 kHz bandwidth outside the frequency band in which the spread spectrum or digitally modulated device is operating, the RF power that is produced shall be at least 20 dB below that in the 100 kHz bandwidth within the band that contains the highest level of the desired power, based on either an RF conducted or a radiated measurement, provided that the transmitter demonstrates compliance with the peak conducted power limits.

#### 7.1.1 TEST PROCEDURE

- a. The EUT was directly connected to the spectrum analyzer and antenna output port as show in the block diagram below,
- b. Spectrum Setting: RBW= 100KHz, VBW=300KHz, Sweep time = Auto.
- c. Offset=antenna gain+cable loss

#### 7.1.2 DEVIATION FROM STANDARD

No deviation.

#### 7.1.3 TEST SETUP

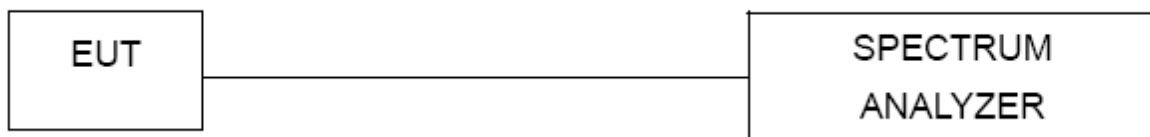

#### 7.1.4 EUT OPERATION CONDITIONS

The EUT was programmed to be in continuously transmitting mode.

#### 7.1.5 EUT TEST CONDITIONS

Temperature: 25°C    Relative Humidity: 55%    Test Voltage: AC 120V/60Hz

#### 7.1.6 TEST RESULTS

Please refer to the Appendix G.

## 8. POWER SPECTRAL DENSITY TEST

### 8.1 APPLIED PROCEDURES / LIMIT

FCC Part15 (15.247) , Subpart C				
Section	Test Item	Limit	Frequency Range (MHz)	Result
15.247(e)	Power Spectral Density	8 dBm (in any 3KHz)	2400-2483.5	PASS

#### 8.1.1 TEST PROCEDURE

- a. The EUT was directly connected to the spectrum analyzer and antenna output port as show in the block diagram below,
- b. Spectrum Setting: RBW=3KHz, VBW=10KHz, Sweep time = Auto.

#### 8.1.2 DEVIATION FROM STANDARD

No deviation.

#### 8.1.3 TEST SETUP



#### 8.1.4 EUT OPERATION CONDITIONS

The EUT was programmed to be in continuously transmitting mode.

#### 8.1.5 EUT TEST CONDITIONS

Temperature: 25°C    Relative Humidity: 55%    Test Voltage: AC 120V/60Hz

#### 8.1.6 TEST RESULTS

Please refer to the Appendix H.



## 9. MEASUREMENT INSTRUMENTS LIST

Conducted Emission Measurement					
Item	Kind of Equipment	Manufacturer	Type No.	Serial No.	Calibrated until
1	EMI Test Receiver	R&S	ESCI	100382	Mar. 11, 2019
2	LISN	EMCO	3816/2	52765	Mar. 11, 2019
3	50Ω Terminator	SHX	TF2-3G-A	8122901	Mar. 11, 2019
4	TWO-LINE V-NETWORK	R&S	ENV216	101447	Mar. 11, 2019
5	Measurement Software	Farad	EZ-EMC Ver.NB-03A1-01	N/A	N/A
6	Cable	N/A	RG223	12m	Oct. 19, 2018

Radiated Emission Measurement - Below 1GHz					
Item	Kind of Equipment	Manufacturer	Type No.	Serial No.	Calibrated until
1	Antenna	Schwarbeck	VULB9160	9160-3232	Mar. 11, 2019
2	Amplifier	HP	8447D	2944A09673	Oct. 19, 2018
3	Receiver	Agilent	N9038A	MY52130039	Aug. 20, 2018
4	Cable	emci	LMR-400(30MHz-1 GHz)(8m+5m)	N/A	Jun. 26, 2019
5	Controller	CT	SC100	N/A	N/A
6	Controller	MF	MF-7802	MF780208416	N/A
7	Measurement Software	Farad	EZ-EMC Ver.NB-03A1-01	N/A	N/A
8	Antenna	EM	EM-6876-1	230	Feb. 07, 2019

Radiated Emission Measurement - Above 1GHz					
Item	Kind of Equipment	Manufacturer	Type No.	Serial No.	Calibrated until
1	Double Ridged Guide Antenna	ETS	3115	75789	Mar. 11, 2019
2	Broad-Band Horn Antenna	Schwarzbeck	BBHA 9170	9170319	Jun. 30, 2019
3	Amplifier	Agilent	8449B	3008A02274	Mar. 11, 2019
4	Microwave Preamplifier With Adaptor	EMC INSTRUMENT	EMC2654045	980039 & HA01	Mar. 11, 2019
5	Receiver	Agilent	N9038A	MY52130039	Aug. 20, 2018
6	Controller	CT	SC100	N/A	N/A
7	Controller	MF	MF-7802	MF780208416	N/A
8	Cable	emci	EMC104-SM-SM-1 2000(12m)	N/A	Jun. 26, 2019
9	Measurement Software	Farad	EZ-EMC Ver.NB-03A1-01	N/A	N/A

6dB Bandwidth					
Item	Kind of Equipment	Manufacturer	Type No.	Serial No.	Calibrated until
1	Spectrum Analyzer	R&S	FSP40	100185	Aug. 20, 2018

Peak Output Power					
Item	Kind of Equipment	Manufacturer	Type No.	Serial No.	Calibrated until
1	Power Meter	ANRITSU	ML2495A	1128009	Mar. 11, 2019
2	Pulse Power Sensor	ANRITSU	MA 2411B	1027500	Mar. 11, 2019

Antenna Conducted Spurious Emission					
Item	Kind of Equipment	Manufacturer	Type No.	Serial No.	Calibrated until
1	Spectrum Analyzer	R&S	FSP40	100185	Aug. 20, 2018

Power Spectral Density					
Item	Kind of Equipment	Manufacturer	Type No.	Serial No.	Calibrated until
1	Spectrum Analyzer	R&S	FSP40	100185	Aug. 20, 2018

Remark: "N/A" denotes no model name, serial no. or calibration specified.  
 All calibration period of equipment list is one year.

**10. EUT TEST PHOTO****Conducted Measurement Photos****Adapter:BN036-A12012U**

**Conducted Measurement Photos**

**Adapter:BN071-A12012U**



## Radiated Measurement Photos

9KHz to 30MHz

Adapter:BN036-A12012U

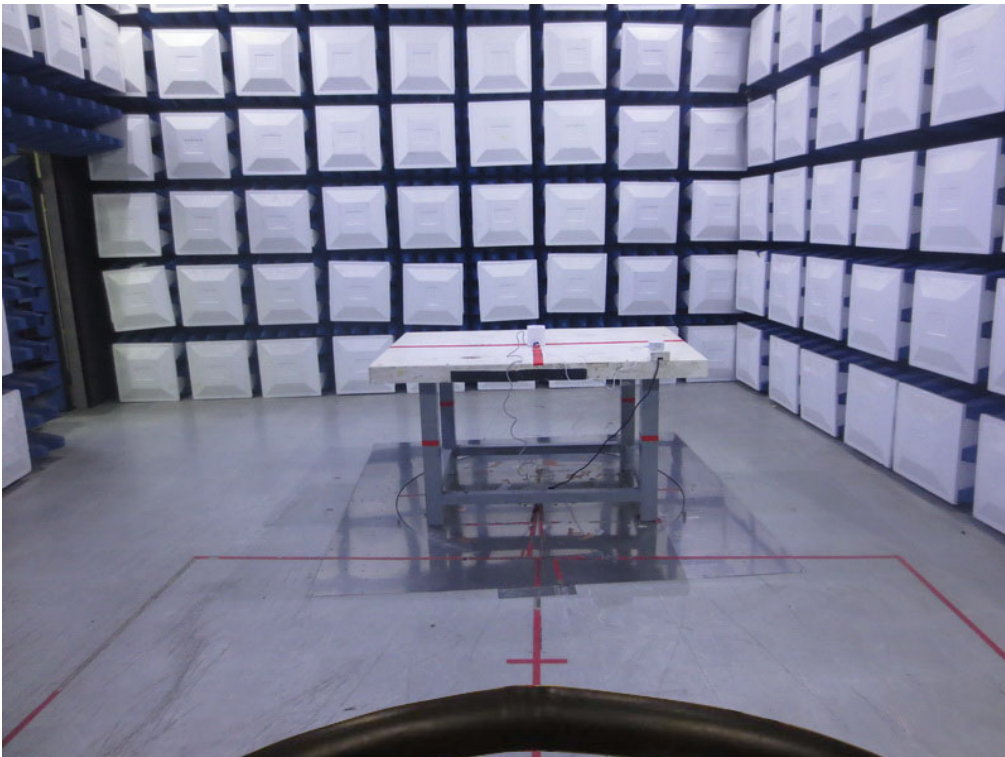
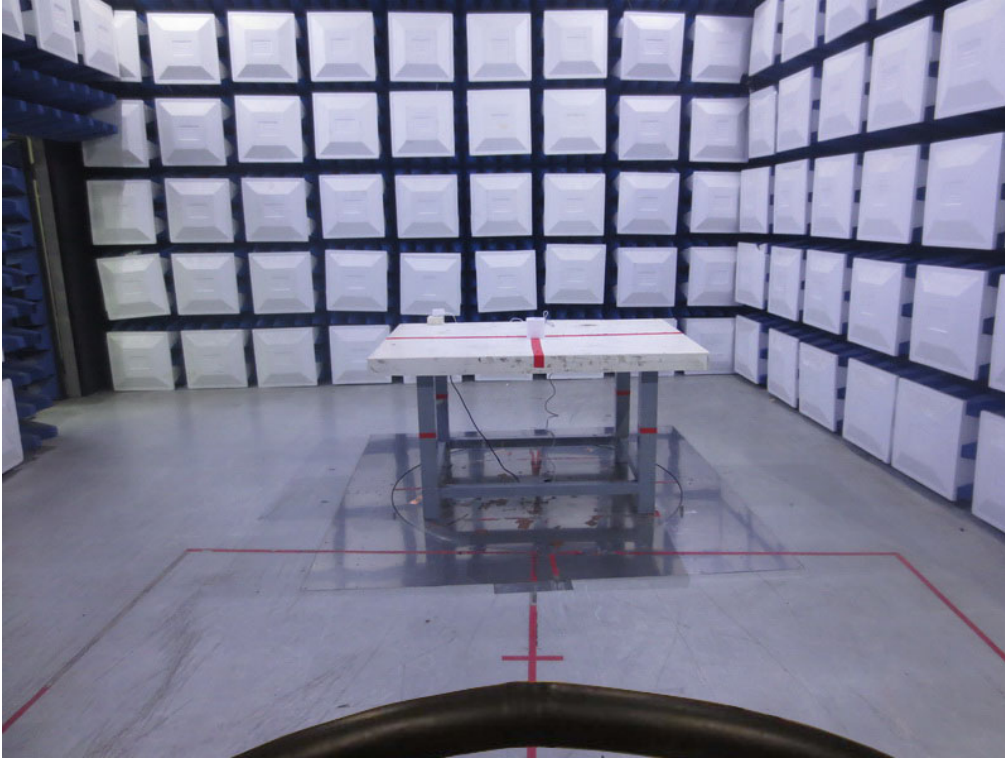

## Radiated Measurement Photos

9KHz to 30MHz

Adapter:BN071-A12012U

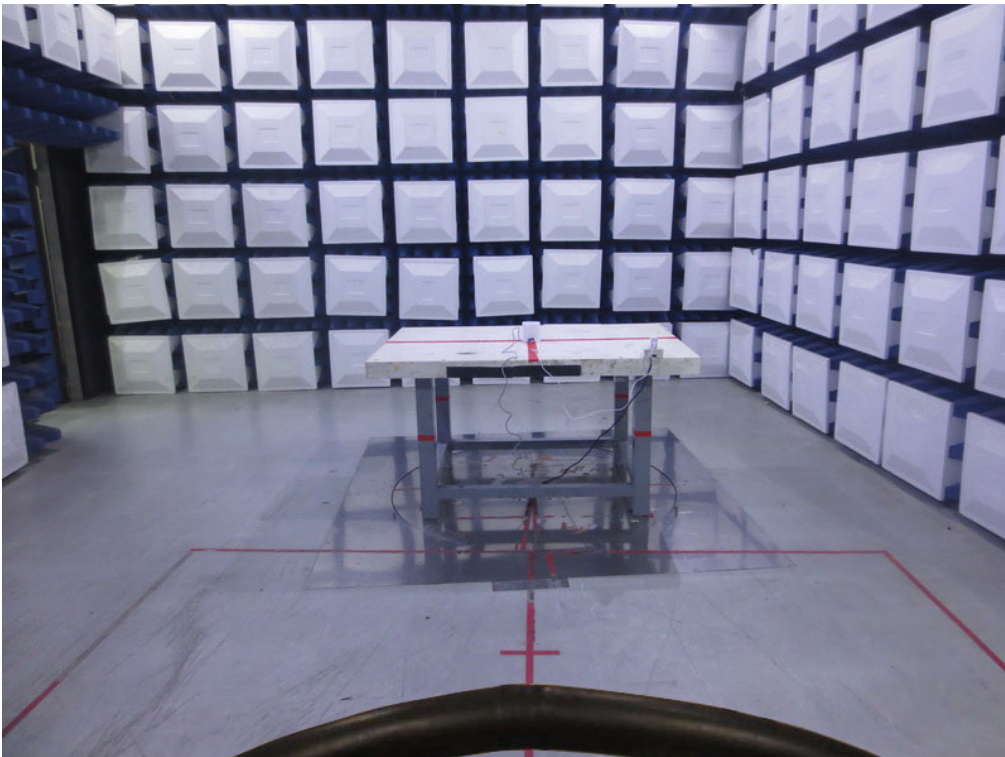

## Radiated Measurement Photos

30MHz to 1000MHz

Adapter:BN036-A12012U

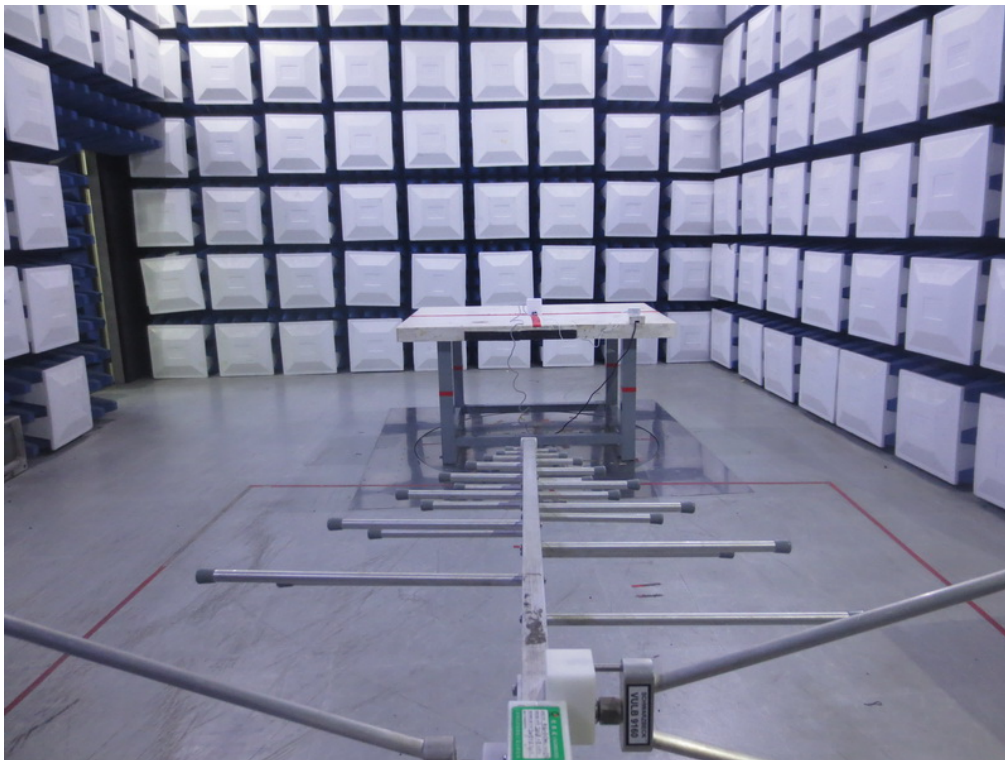

**Radiated Measurement Photos**

**30MHz to 1000MHz**

**Adapter:BN036-A12012U**

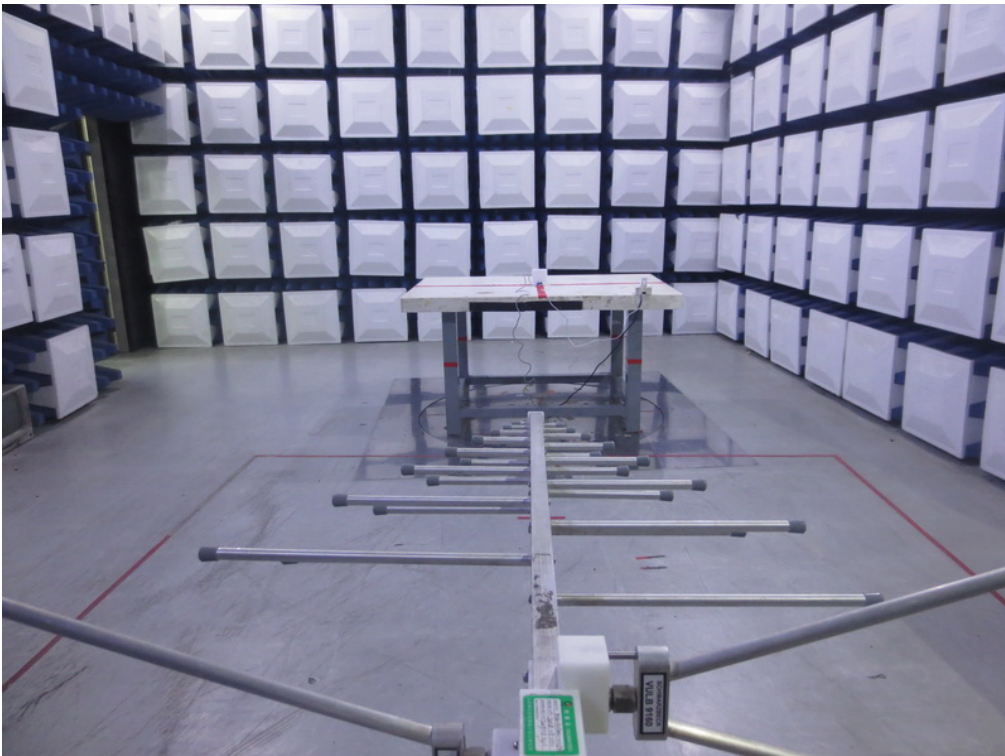



**Radiated Measurement Photos**

**Above 1000MHz**

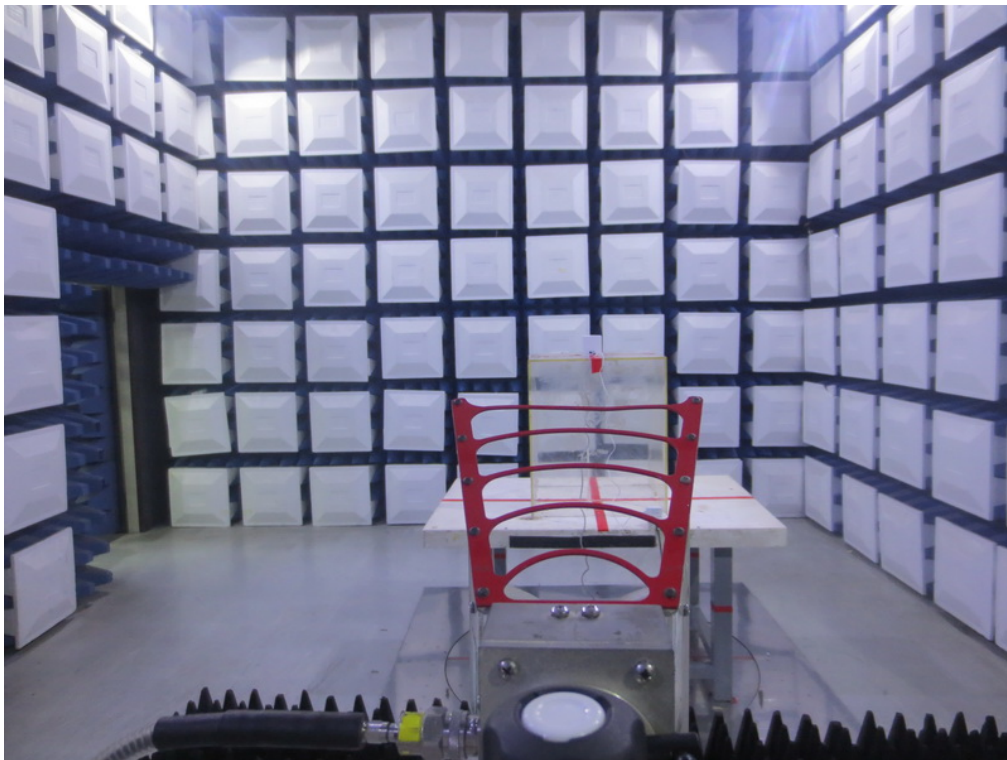

## APPENDIX A - CONDUCTED EMISSION

Test Mode : TX MODE(Adapter:BN036-A12012U)

Line

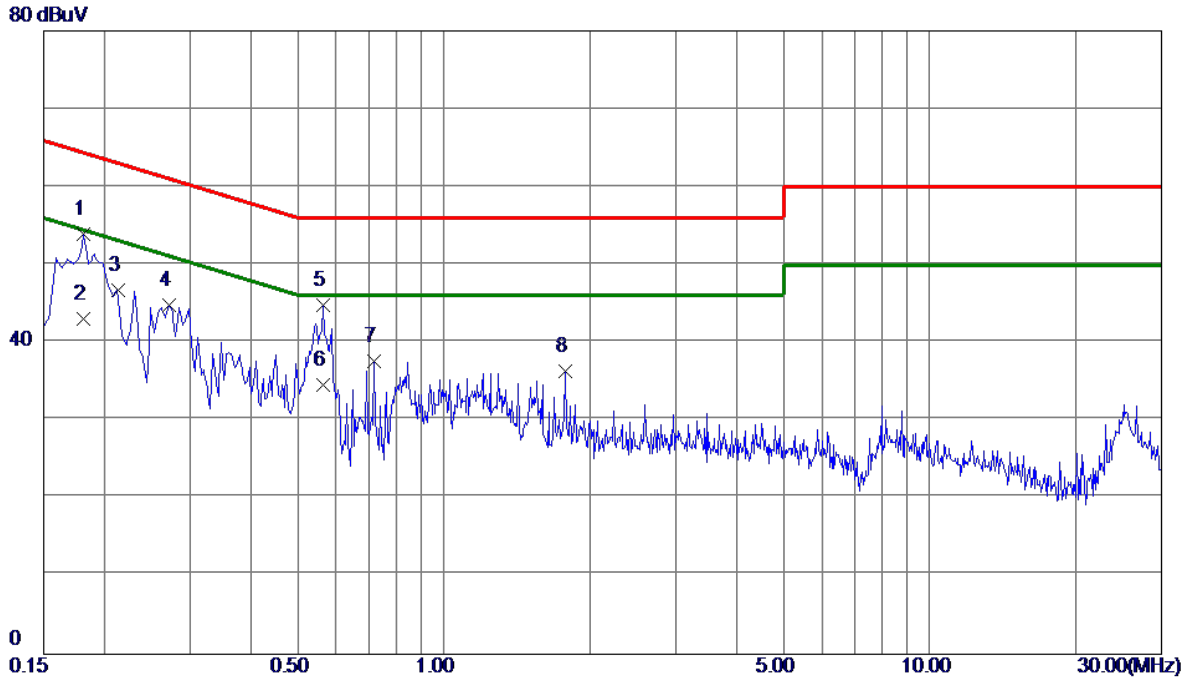

No.	Freq. MHz	Reading Level dBuV	Correct Factor dB	Measure ment dBuV	Limit dBuV	Margin dB	Detector	Comment
1 *	0.1815	44.03	9.82	53.85	64.42	-10.57	Peak	
2	0.1815	33.21	9.82	43.03	54.42	-11.39	AVG	
3	0.2130	36.94	9.82	46.76	63.09	-16.33	Peak	
4	0.2714	35.04	9.82	44.86	61.07	-16.21	Peak	
5	0.5639	35.00	9.82	44.82	56.00	-11.18	Peak	
6	0.5639	24.70	9.82	34.52	46.00	-11.48	AVG	
7	0.7170	27.76	9.88	37.64	56.00	-18.36	Peak	
8	1.7745	26.41	9.98	36.39	56.00	-19.61	Peak	

Test Mode : TX MODE (Adapter:BN036-A12012U)

**Neutral**

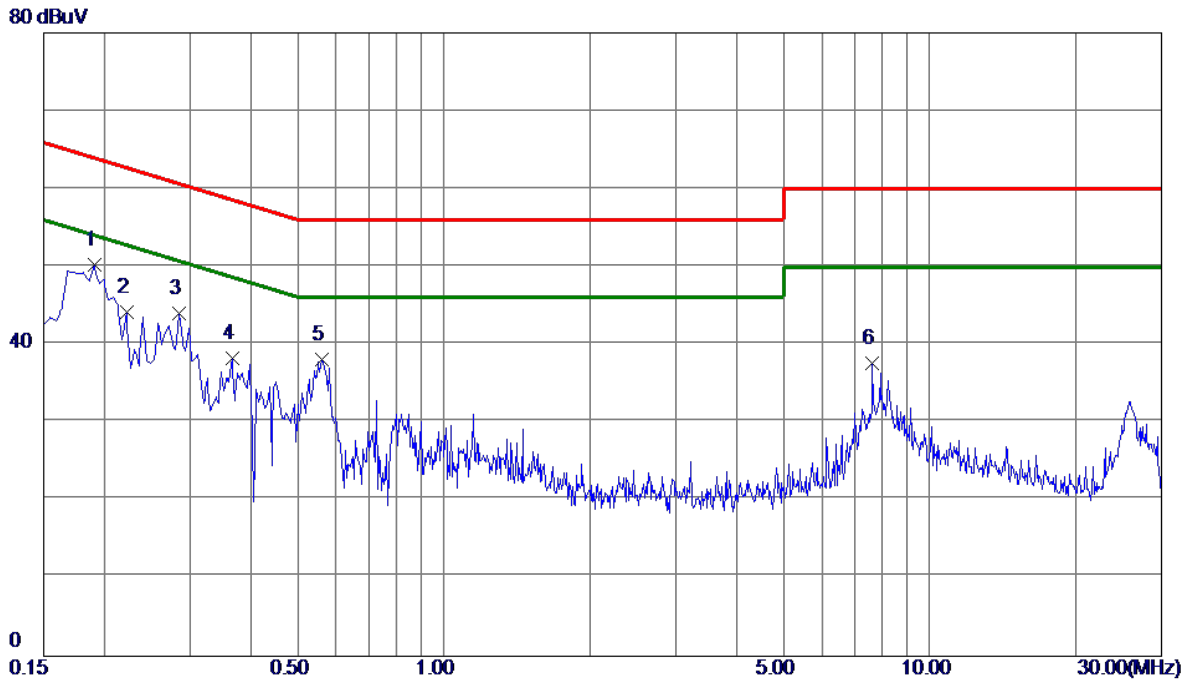

No.	Freq. MHz	Reading Level dBuV	Correct Factor dB	Measure ment dBuV	Limit dBuV	Margin dB	Detector	Comment
1 *	0.1905	40.35	9.91	50.26	64.01	-13.75	Peak	
2	0.2220	34.28	9.91	44.19	62.74	-18.55	Peak	
3	0.2850	34.06	9.93	43.99	60.67	-16.68	Peak	
4	0.3660	28.22	9.95	38.17	58.59	-20.42	Peak	
5	0.5595	28.08	9.96	38.04	56.00	-17.96	Peak	
6	7.6155	26.91	10.62	37.53	60.00	-22.47	Peak	

Test Mode : TX MODE (Adapter:BN071-A12012U)

Line

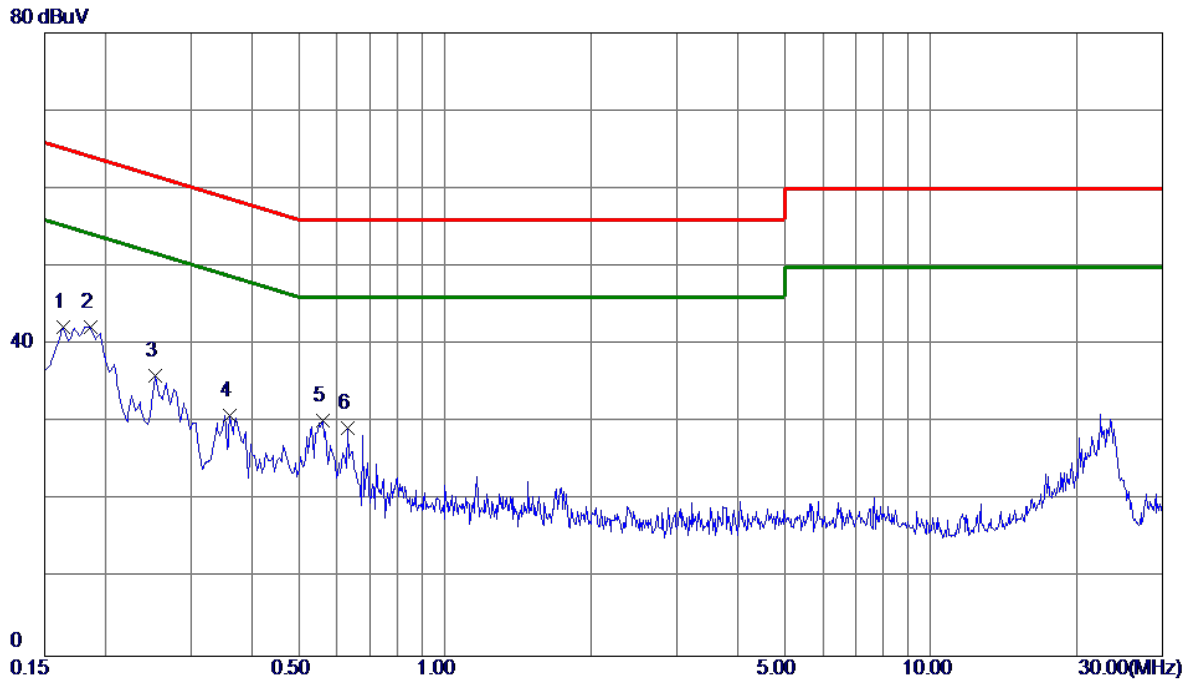

No.	Freq. MHz	Reading Level dBuV	Correct Factor dB	Measure ment dBuV	Limit dBuV	Margin dB	Detector	Comment
1	0.1635	32.48	9.82	42.30	65.28	-22.98	Peak	
2 *	0.1860	32.46	9.82	42.28	64.21	-21.93	Peak	
3	0.2535	26.13	9.82	35.95	61.64	-25.69	Peak	
4	0.3615	21.07	9.81	30.88	58.69	-27.81	Peak	
5	0.5595	20.39	9.81	30.20	56.00	-25.80	Peak	
6	0.6315	19.46	9.84	29.30	56.00	-26.70	Peak	

Test Mode : TX MODE (Adapter:BN071-A12012U)

### Neutral

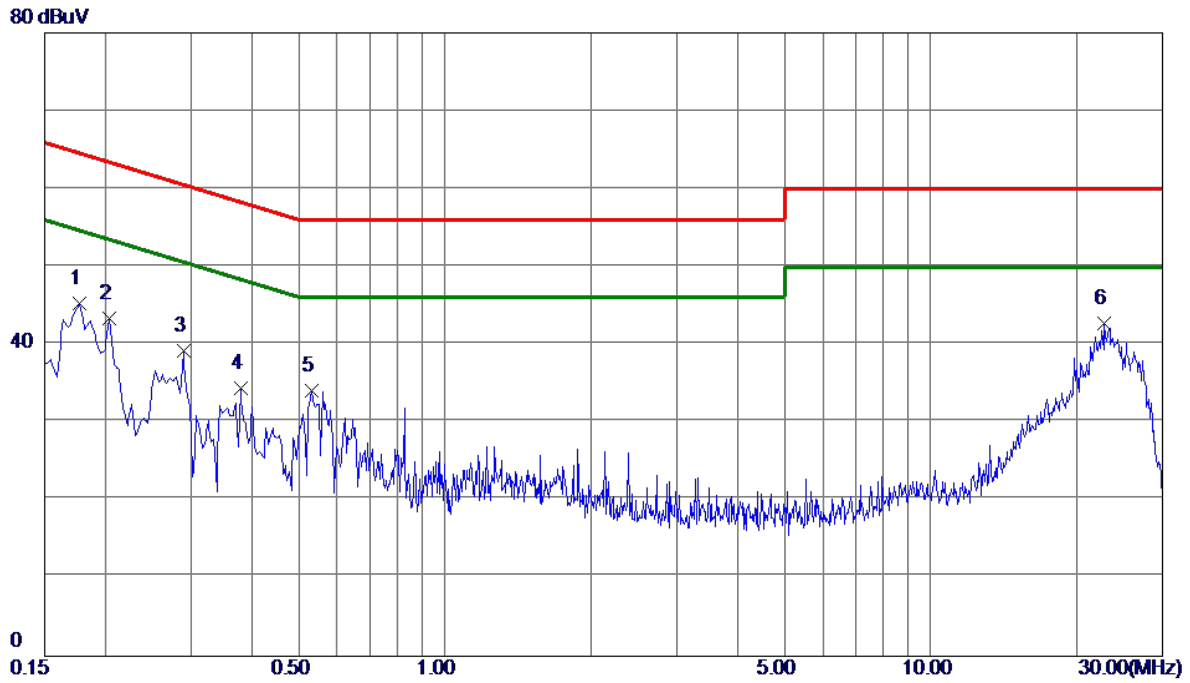

No.	Freq. MHz	Reading Level dBuV	Correct Factor dB	Measure ment dBuV	Limit dBuV	Margin dB	Detector	Comment
1	0.1770	35.33	9.91	45.24	64.63	-19.39	Peak	
2	0.2040	33.47	9.91	43.38	63.45	-20.07	Peak	
3	0.2895	29.30	9.93	39.23	60.54	-21.31	Peak	
4	0.3795	24.43	9.95	34.38	58.29	-23.91	Peak	
5	0.5325	24.07	9.95	34.02	56.00	-21.98	Peak	
6 *	22.8030	31.23	11.48	42.71	60.00	-17.29	Peak	

## APPENDIX B - RADIATED EMISSION (9KHZ TO 30MHZ)

Test Mode: TX MODE CHANNEL 01(Adapter:BN036-A12012U)

Ant 0°

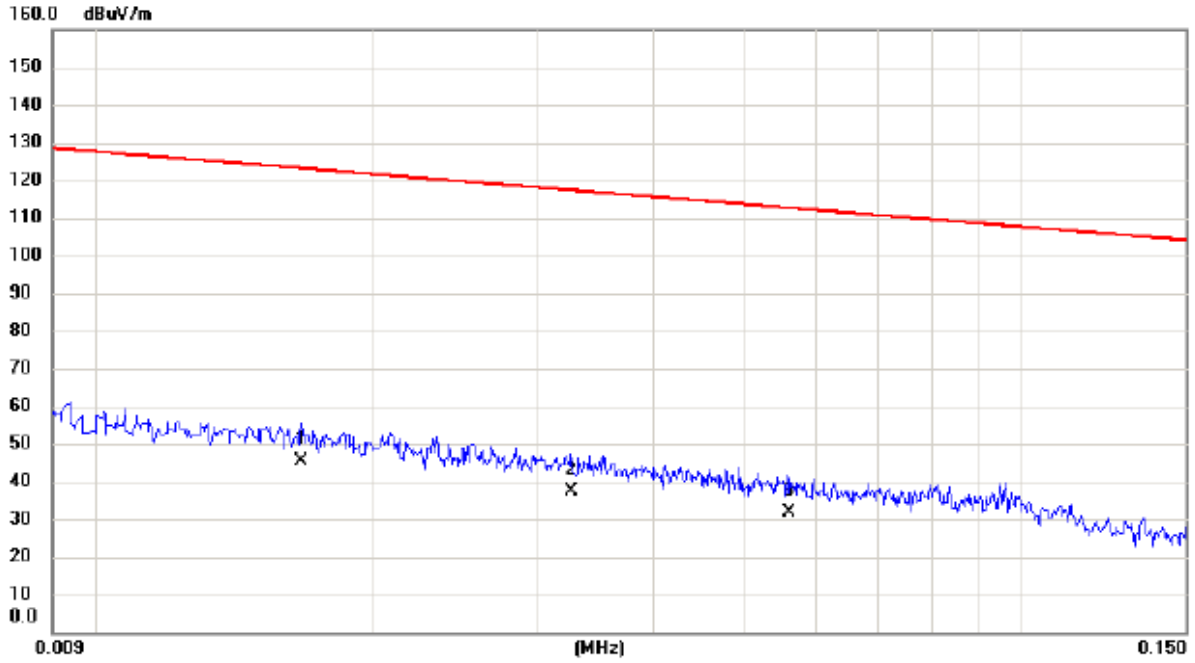

No.	Mk.	Freq. MHz	Reading Level dBuV	Correct Factor dB	Measure- ment dBuV/m	Limit dBuV/m	Margin dB	Detector	Comment
1	*	0.0167	24.85	20.48	45.33	123.15	-77.82	AVG	
2		0.0326	17.46	19.81	37.27	117.34	-80.07	AVG	
3		0.0560	12.50	19.41	31.91	112.64	-80.73	AVG	



Test Mode: TX MODE CHANNEL 01(Adapter:BN036-A12012U)

Ant 0°

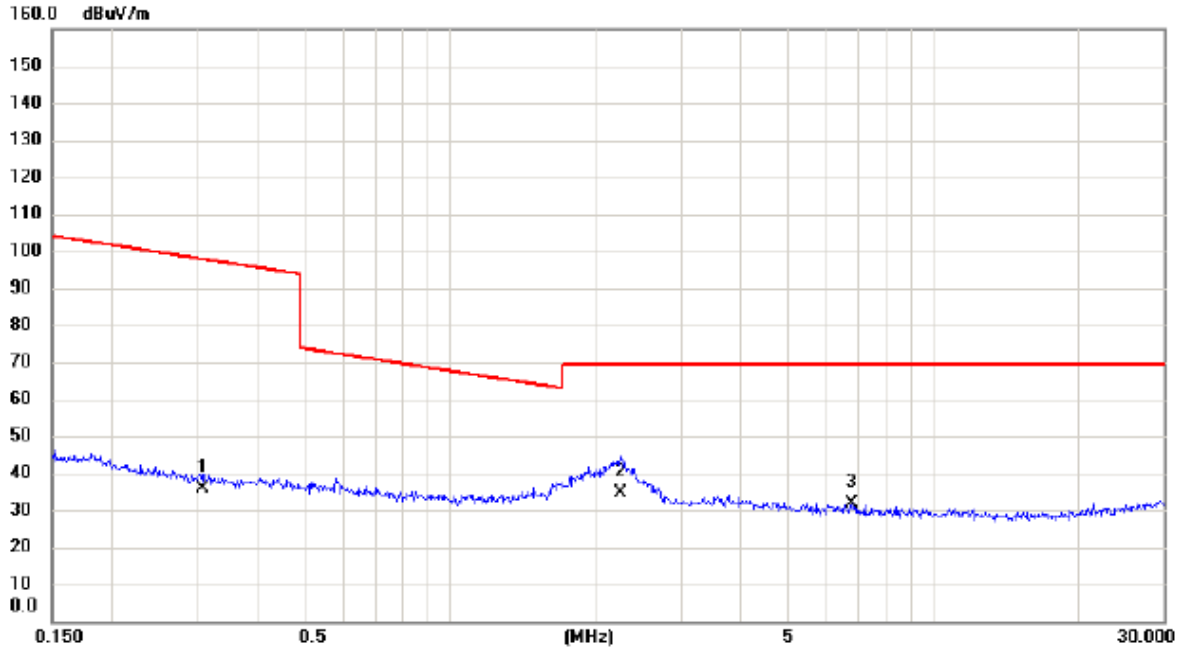

No.	Mk.	Freq. MHz	Reading Level dBuV	Correct Factor dB	Measure- ment dBuV/m	Limit dBuV/m	Margin dB	Detector	Comment
1		0.3082	18.76	17.04	35.80	97.83	-62.03	AVG	
2	*	2.2486	17.83	16.96	34.79	69.54	-34.75	QP	
3		6.7691	16.98	14.88	31.86	69.54	-37.68	QP	

Test Mode: TX MODE CHANNEL 01(Adapter:BN036-A12012U)

Ant 90°

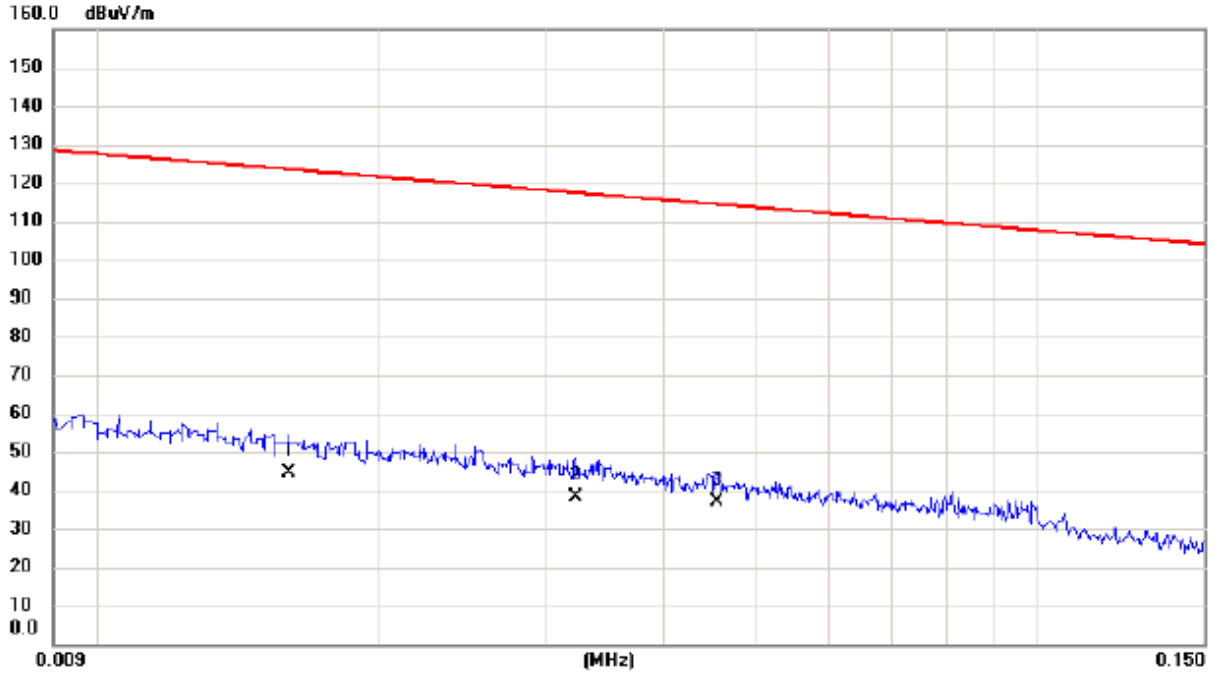

No.	Mk.	Freq. MHz	Reading Level dBuV	Correct Factor dB	Measure- ment dBuV/m	Limit dBuV/m	Margin dB	Detector	Comment
1		0.0160	23.96	20.58	44.54	123.52	-78.98	AVG	
2		0.0323	18.46	19.82	38.28	117.42	-79.14	AVG	
3	*	0.0456	17.34	19.59	36.93	114.43	-77.50	AVG	

Test Mode: TX MODE CHANNEL 01(Adapter:BN036-A12012U)

Ant 90°

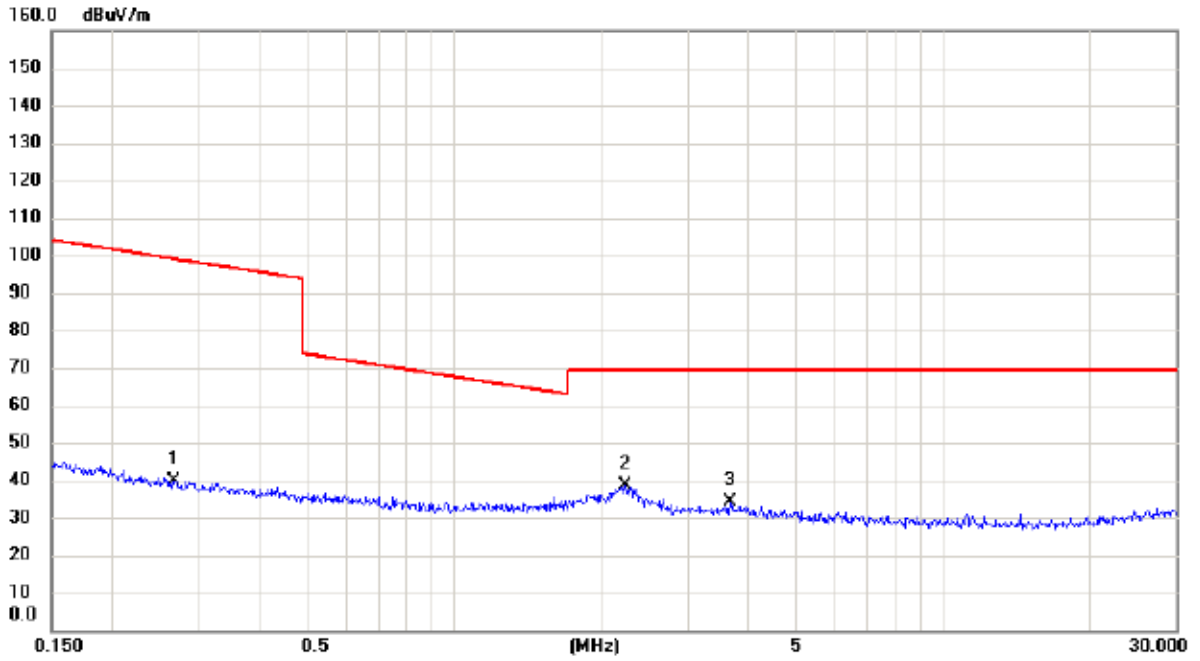

No.	Mk.	Freq. MHz	Reading Level dBuV	Correct Factor dB	Measure- ment dBuV/m	Limit dBuV/m	Margin dB	Detector	Comment
1		0.2672	22.71	17.05	39.76	99.07	-59.31	AVG	
2	*	2.2367	21.56	16.97	38.53	69.54	-31.01	QP	
3		3.6611	18.01	16.01	34.02	69.54	-35.52	QP	

Test Mode: TX MODE CHANNEL 01(Adapter:BN071-A12012U)

Ant 0°

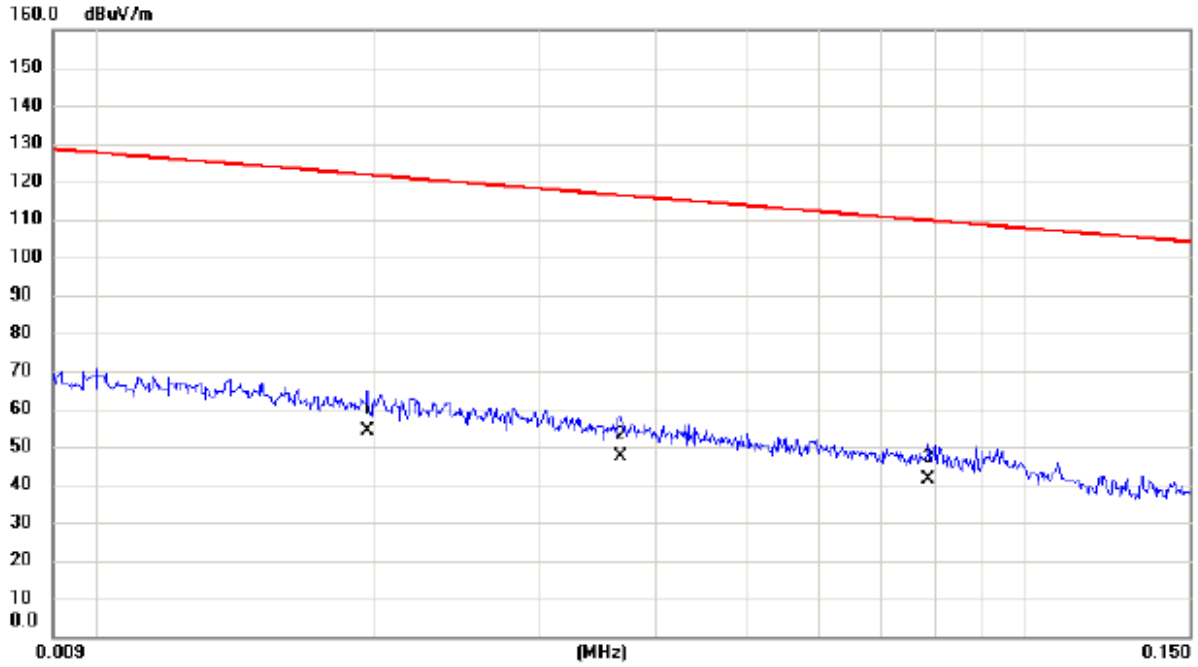

No.	Mk.	Freq.	Reading Level	Correct Factor	Measurement	Limit	Margin	Detector	Comment
		MHz	dBuV	dB	dBuV/m	dBuV/m	dB		
1	*	0.0196	34.10	20.08	54.18	121.76	-67.58	AVG	
2		0.0367	27.80	19.74	47.54	116.31	-68.77	AVG	
3		0.0785	22.30	18.95	41.25	109.71	-68.46	AVG	

Test Mode: TX MODE CHANNEL 01(Adapter:BN071-A12012U)

Ant 0°

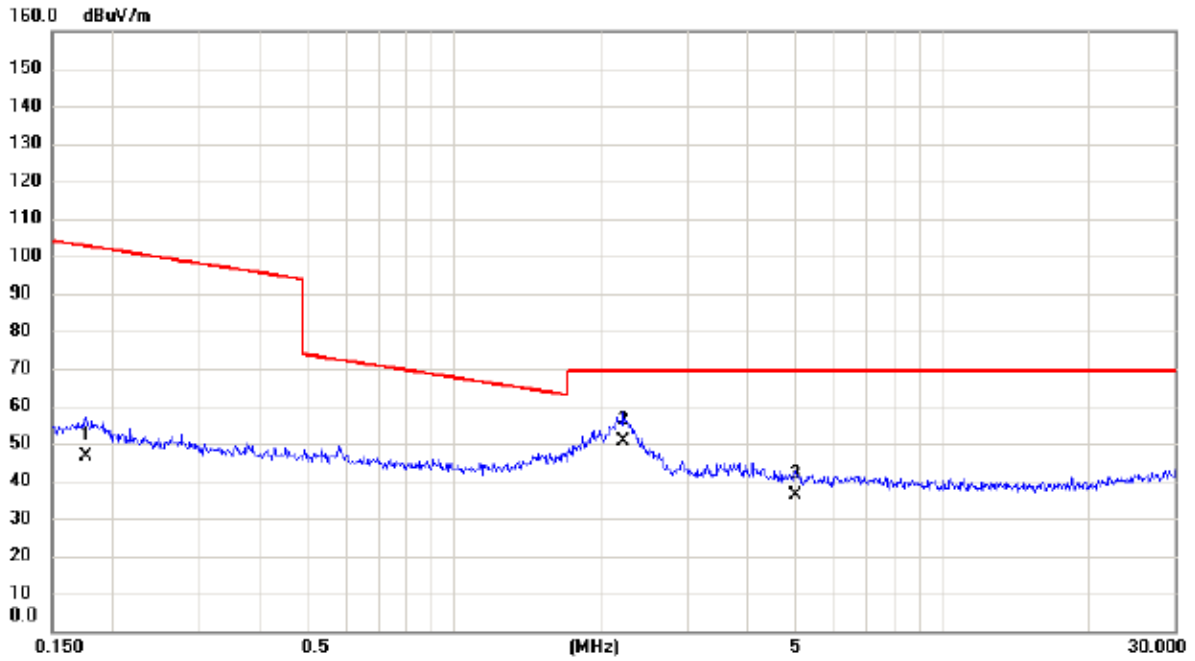

No.	Mk.	Freq. MHz	Reading Level dBuV	Correct Factor dB	Measure- ment dBuV/m	Limit dBuV/m	Margin dB	Detector	Comment
1		0.1758	29.30	17.20	46.50	102.71	-56.21	AVG	
2	*	2.2132	33.50	16.98	50.48	69.54	-19.06	QP	
3		5.0046	21.10	15.17	36.27	69.54	-33.27	QP	

Test Mode: TX MODE CHANNEL 01(Adapter:BN071-A12012U)

Ant 90°

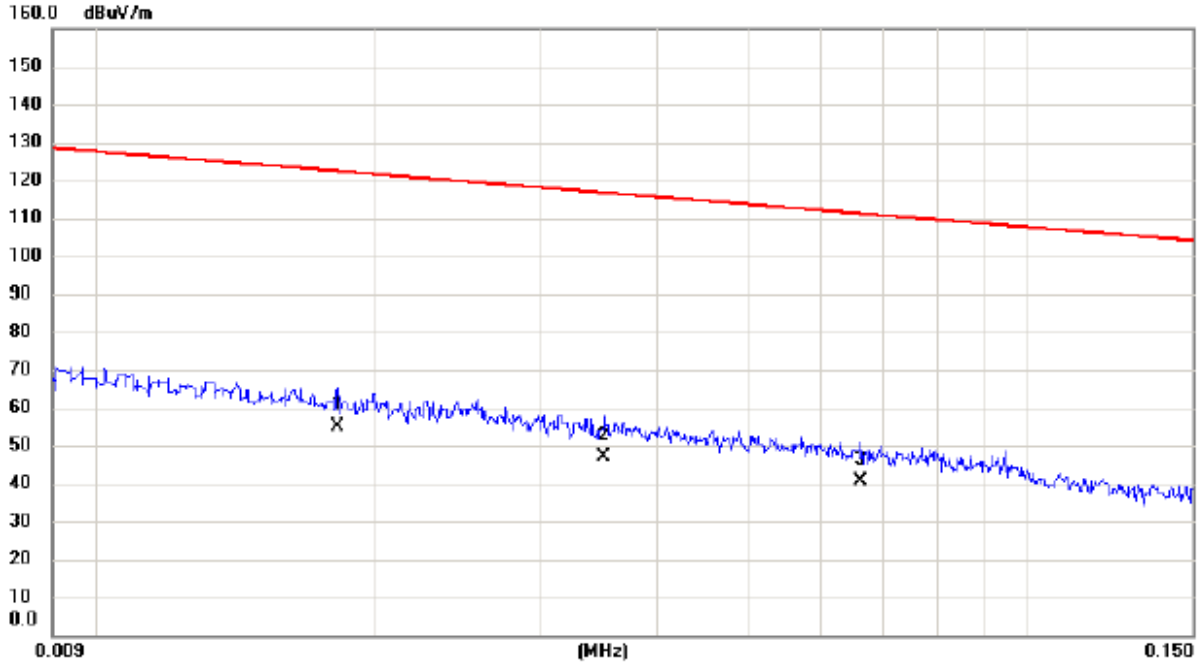

No.	Mk.	Freq. MHz	Reading Level dBuV	Correct Factor dB	Measure- ment dBuV/m	Limit dBuV/m	Margin dB	Detector	Comment
1	*	0.0182	34.70	20.27	54.97	122.40	-67.43	AVG	
2		0.0351	27.30	19.77	47.07	116.70	-69.63	AVG	
3		0.0662	21.50	19.21	40.71	111.19	-70.48	AVG	

Test Mode: TX MODE CHANNEL 01 (Adapter:BN071-A12012U)

Ant 90°

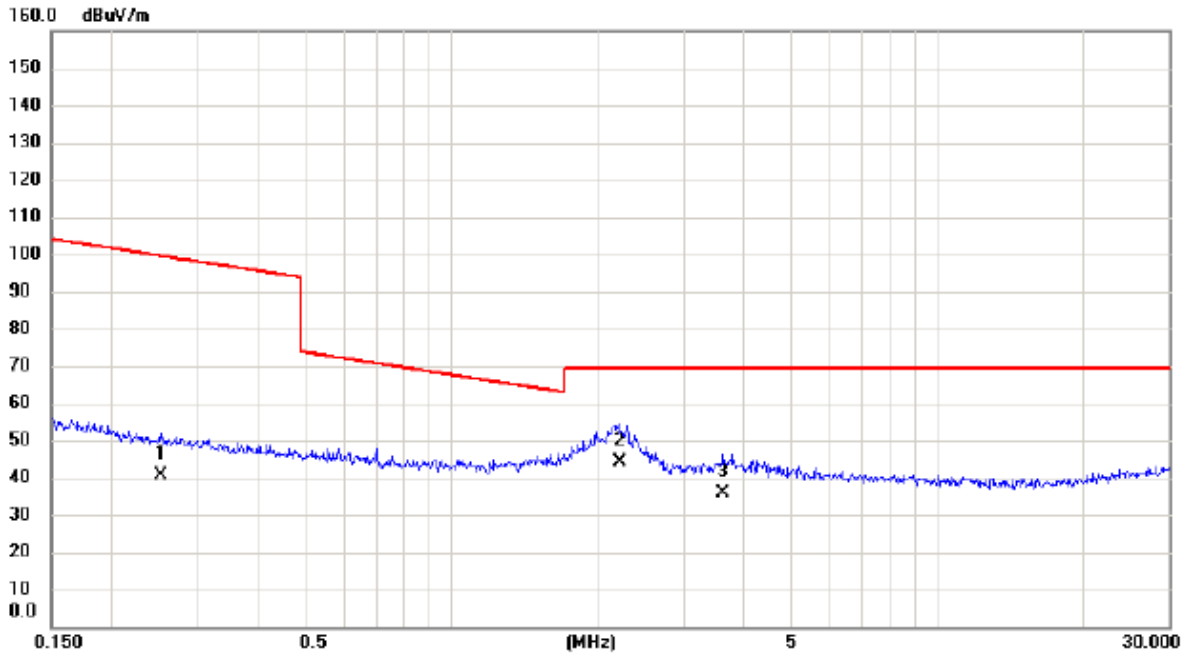

No.	Mk.	Freq. MHz	Reading Level dBuV	Correct Factor dB	Measure- ment dBuV/m	Limit dBuV/m	Margin dB	Detector	Comment
1		0.2521	23.50	17.06	40.56	99.57	-59.01	AVG	
2	*	2.2132	27.30	16.98	44.28	69.54	-25.26	QP	
3		3.6225	19.80	16.04	35.84	69.54	-33.70	QP	

## APPENDIX C - RADIATED EMISSION (30MHZ TO 1000MHZ)



Test Mode: TX B MODE CHANNEL 01(Adapter:BN036-A12012U)

**Vertical**

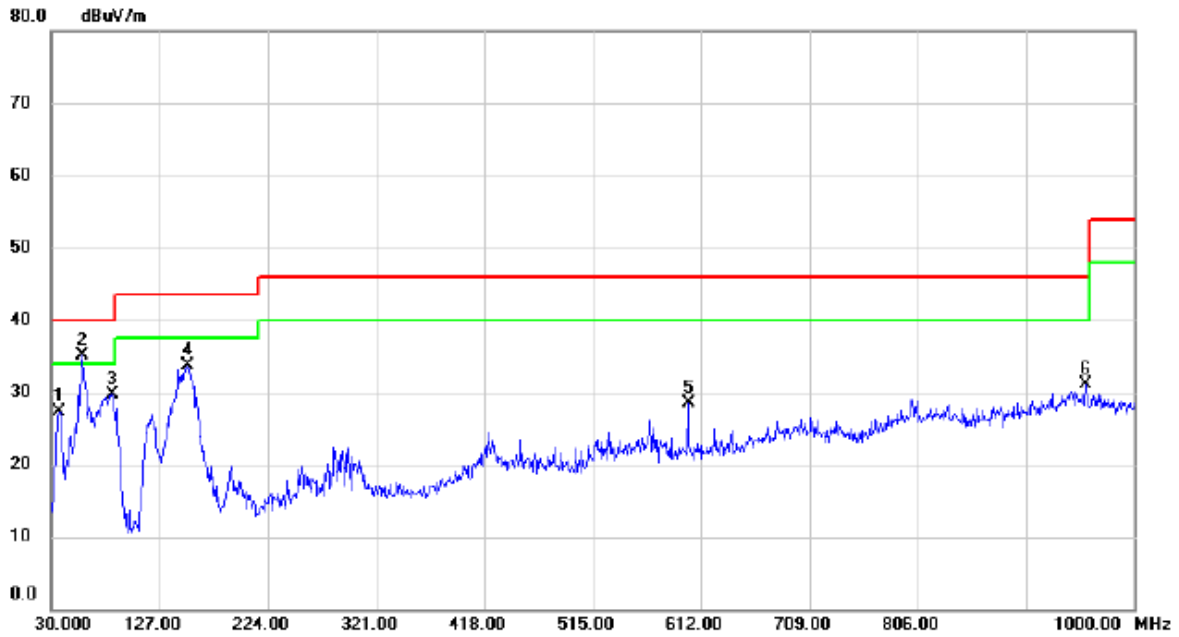

No.	Mk.	Freq. MHz	Reading Level dBuV	Correct Factor dB	Measure- ment dBuV/m	Limit dBuV/m	Margin dB	Detector	Comment
1		36.790	42.23	-14.86	27.37	40.00	-12.63	peak	
2	*	57.160	50.37	-15.25	35.12	40.00	-4.88	peak	
3		85.290	48.88	-19.15	29.73	40.00	-10.27	peak	
4		152.220	44.95	-11.29	33.66	43.50	-9.84	peak	
5		600.360	34.85	-6.29	28.56	46.00	-17.44	peak	
6		956.350	29.78	1.26	31.04	46.00	-14.96	peak	

Test Mode: TX B MODE CHANNEL 01(Adapter:BN036-A12012U)

Horizontal

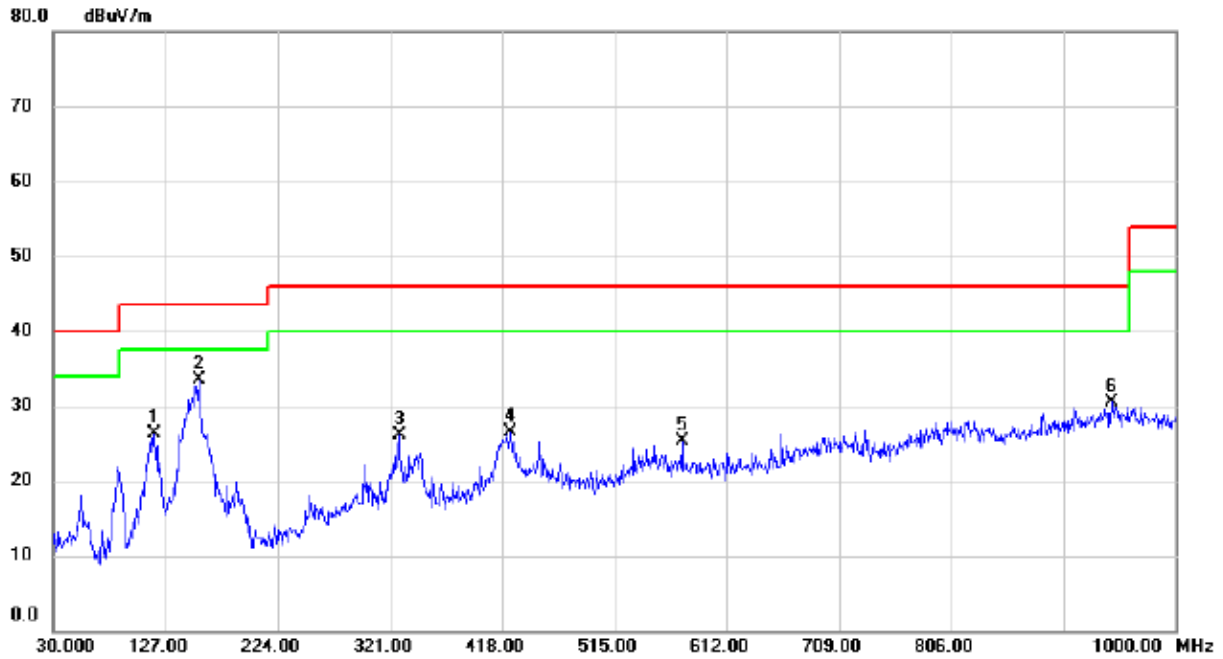

No. Mk.	Freq. MHz	Reading Level dBuV	Correct Factor dB	Measurement dBuV/m	Limit dBuV/m	Margin dB	Detector	Comment
1	117.300	41.51	-15.12	26.39	43.50	-17.11	peak	
2 *	156.100	44.37	-10.94	33.43	43.50	-10.07	peak	
3	328.760	36.81	-10.77	26.04	46.00	-19.96	peak	
4	424.790	34.82	-8.41	26.41	46.00	-19.59	peak	
5	573.200	31.19	-5.85	25.34	46.00	-20.66	peak	
6	944.710	29.23	1.20	30.43	46.00	-15.57	peak	

Test Mode: TX B MODE CHANNEL 06 (Adapter:BN036-A12012U)

**Vertical**

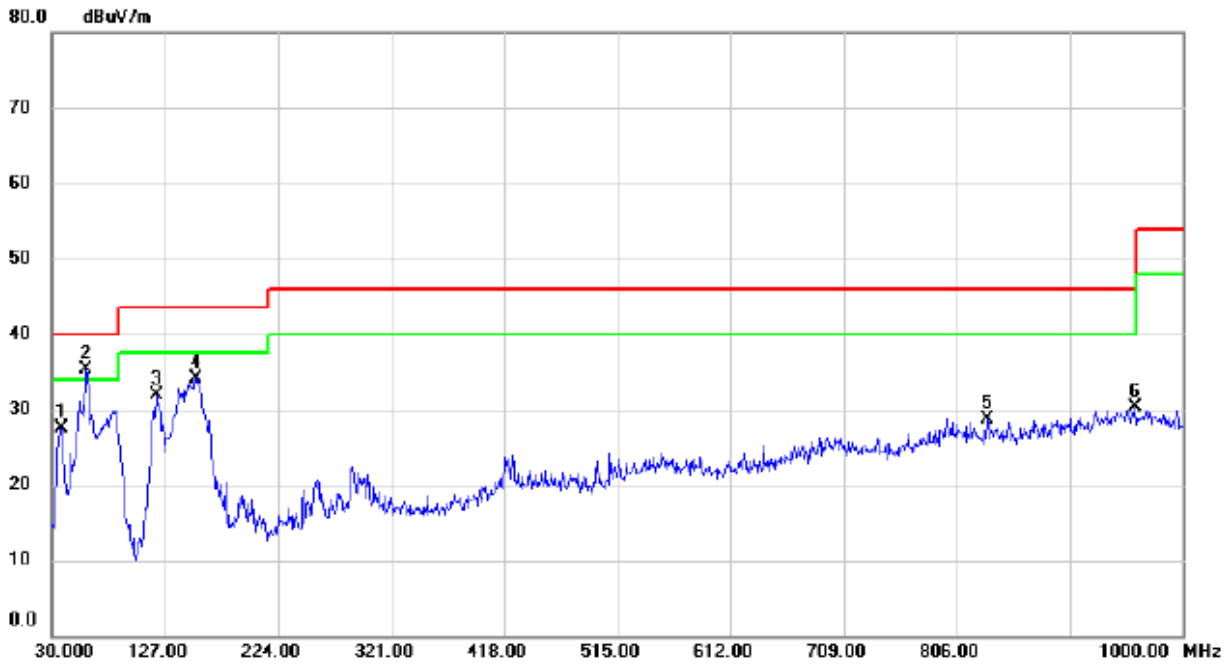

No.	Mk.	Freq. MHz	Reading Level dBuV	Correct Factor dB	Measure- ment dBuV/m	Limit dBuV/m	Margin dB	Detector	Comment
1		37.760	42.14	-14.71	27.43	40.00	-12.57	peak	
2	*	59.100	50.85	-15.55	35.30	40.00	-4.70	peak	
3		119.240	46.62	-14.80	31.82	43.50	-11.68	peak	
4		153.190	45.28	-11.20	34.08	43.50	-9.42	peak	
5		832.190	30.32	-1.54	28.78	46.00	-17.22	peak	
6		959.260	29.09	1.19	30.28	46.00	-15.72	peak	

Test Mode: TX B MODE CHANNEL 06(Adapter:BN036-A12012U)

Horizontal

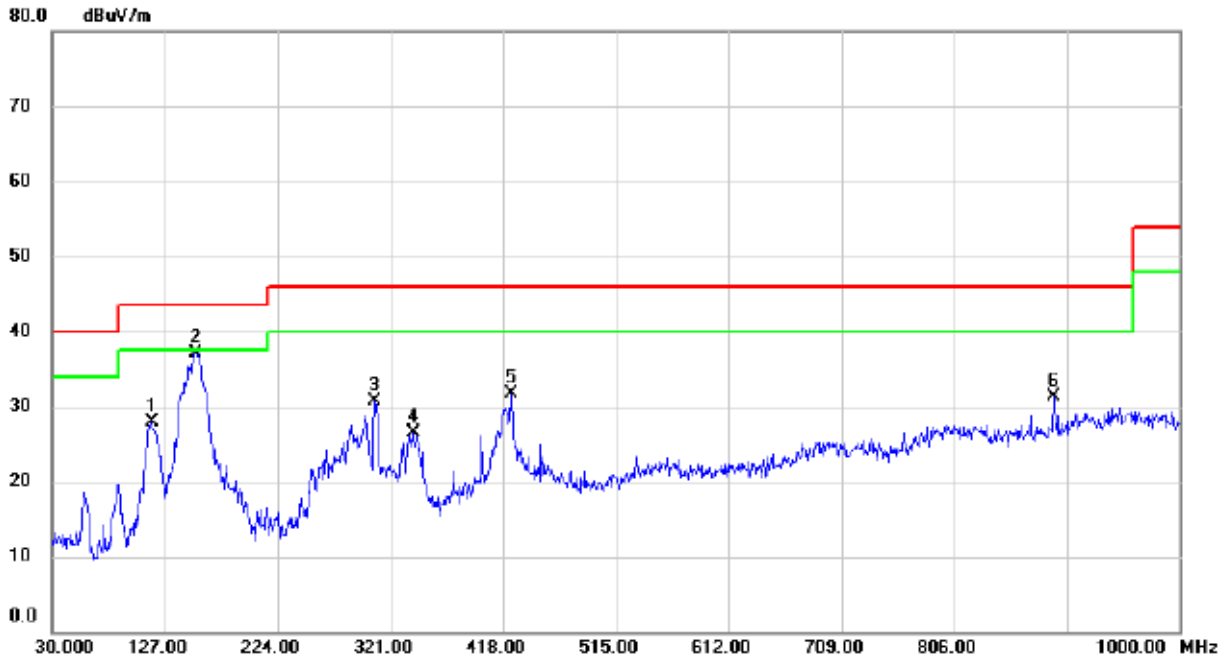

No.	Mk.	Freq. MHz	Reading Level dBuV	Correct Factor dB	Measure- ment dBuV/m	Limit dBuV/m	Margin dB	Detector	Comment
1		115.360	43.38	-15.43	27.95	43.50	-15.55	peak	
2	*	153.190	48.25	-11.20	37.05	43.50	-6.45	peak	
3		307.420	41.13	-10.47	30.66	46.00	-15.34	peak	
4		340.400	37.39	-10.95	26.44	46.00	-19.56	peak	
5		424.790	40.12	-8.41	31.71	46.00	-14.29	peak	
6		891.360	32.12	-0.81	31.31	46.00	-14.69	peak	

Test Mode: TX B MODE CHANNEL 11 (Adapter:BN036-A12012U)

**Vertical**

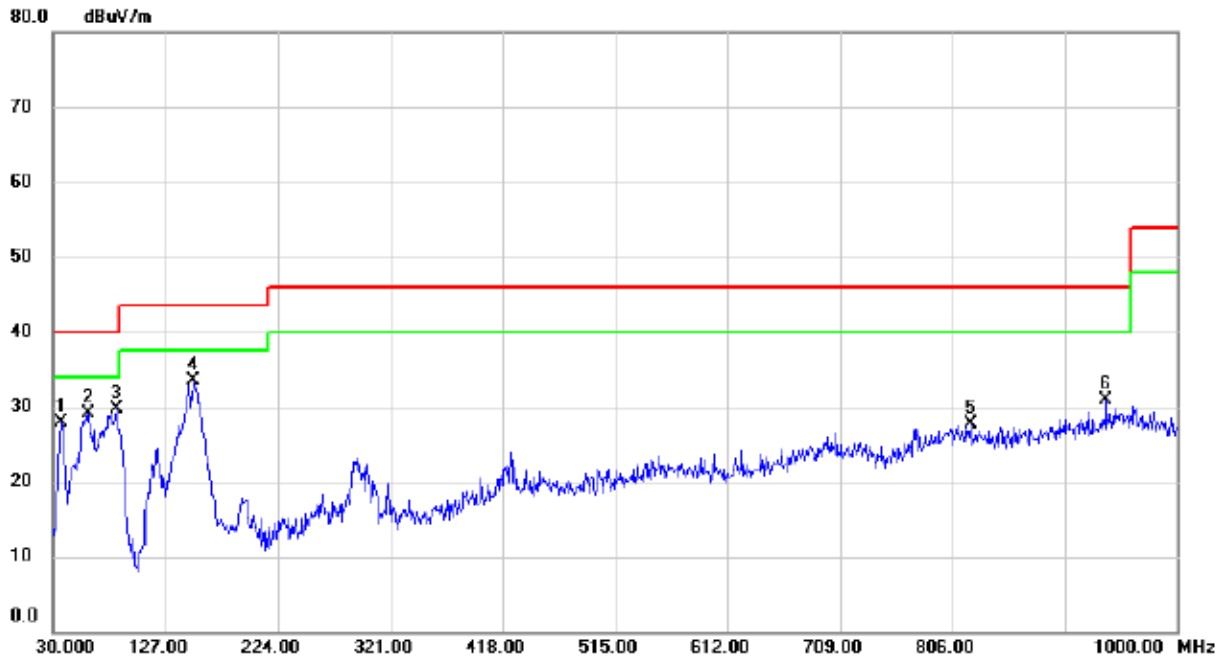

No.	Mk.	Freq. MHz	Reading Level dBuV	Correct Factor dB	Measure- ment dBuV/m	Limit dBuV/m	Margin dB	Detector	Comment
1		36.790	42.82	-14.86	27.96	40.00	-12.04	peak	
2		60.070	44.79	-15.69	29.10	40.00	-10.90	peak	
3		84.320	48.69	-19.05	29.64	40.00	-10.36	peak	
4	*	151.250	44.94	-11.39	33.55	43.50	-9.95	peak	
5		821.520	29.09	-1.38	27.71	46.00	-18.29	peak	
6		938.890	30.00	0.96	30.96	46.00	-15.04	peak	

Test Mode: TX B MODE CHANNEL 11(Adapter:BN036-A12012U)

**Horizontal**

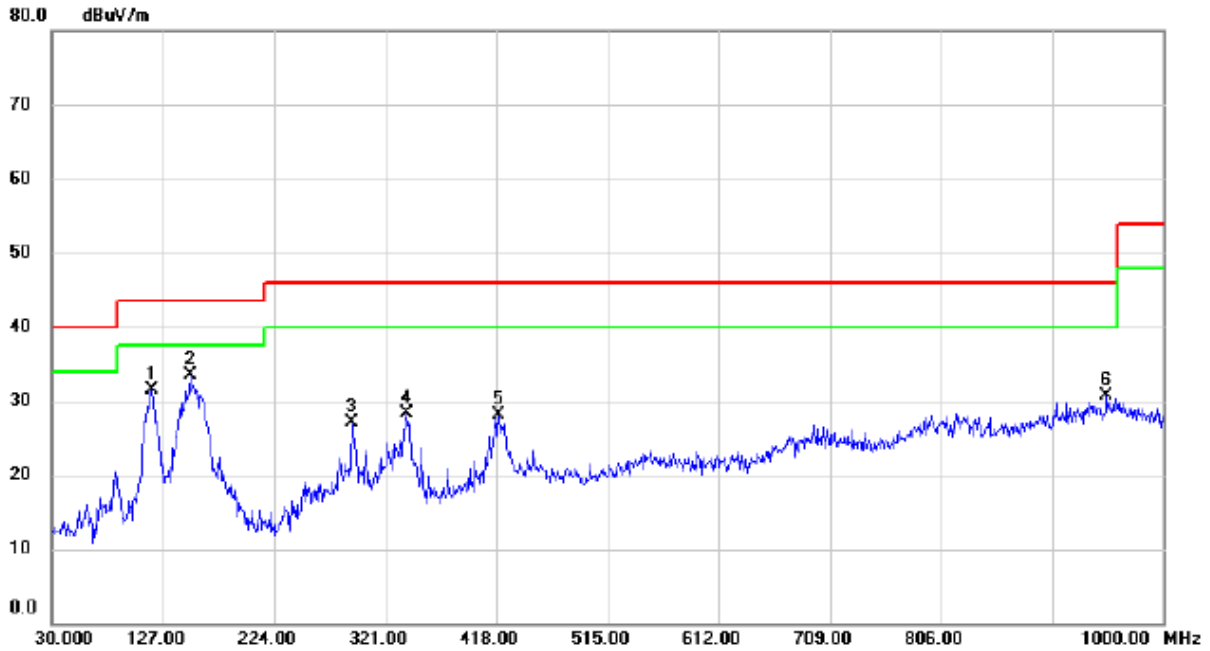

No.	Mk.	Freq. MHz	Reading Level dBuV	Correct Factor dB	Measure- ment dBuV/m	Limit dBuV/m	Margin dB	Detector	Comment
1		117.300	46.55	-15.12	31.43	43.50	-12.07	peak	
2	*	150.280	44.97	-11.47	33.50	43.50	-10.00	peak	
3		291.900	37.88	-10.84	27.04	46.00	-18.96	peak	
4		339.430	39.17	-10.92	28.25	46.00	-17.75	peak	
5		419.940	36.78	-8.59	28.19	46.00	-17.81	peak	
6		950.530	29.36	1.40	30.76	46.00	-15.24	peak	

Test Mode: TX B MODE CHANNEL 01 (Adapter:BN071-A12012U)

**Vertical**

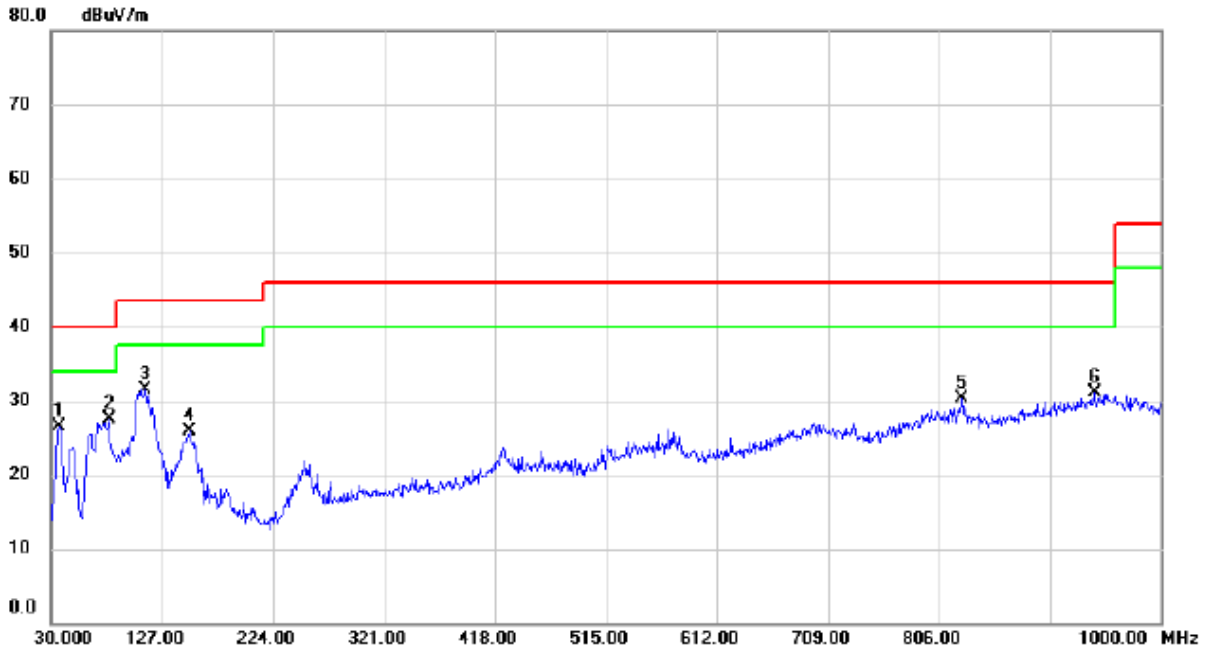

No.	Mk.	Freq. MHz	Reading Level dBuV	Correct Factor dB	Measure- ment dBuV/m	Limit dBuV/m	Margin dB	Detector	Comment
1		36.790	41.39	-14.86	26.53	40.00	-13.47	peak	
2		80.440	46.12	-18.62	27.50	40.00	-12.50	peak	
3	*	112.450	47.44	-15.89	31.55	43.50	-11.95	peak	
4		150.280	37.32	-11.47	25.85	43.50	-17.65	peak	
5		826.370	31.72	-1.45	30.27	46.00	-15.73	peak	
6		941.800	30.04	1.07	31.11	46.00	-14.89	peak	

Test Mode: TX B MODE CHANNEL 01 (Adapter:BN071-A12012U)

Horizontal



No.	Mk.	Freq. MHz	Reading Level dBuV	Correct Factor dB	Measure- ment dBuV/m	Limit dBuV/m	Margin dB	Detector	Comment
1		36.790	41.39	-14.86	26.53	40.00	-13.47	peak	
2		80.440	46.12	-18.62	27.50	40.00	-12.50	peak	
3	*	112.450	47.44	-15.89	31.55	43.50	-11.95	peak	
4		150.280	37.32	-11.47	25.85	43.50	-17.65	peak	
5		826.370	31.72	-1.45	30.27	46.00	-15.73	peak	
6		941.800	30.04	1.07	31.11	46.00	-14.89	peak	



Test Mode: TX B MODE CHANNEL 06 (Adapter:BN071-A12012U)

**Vertical**

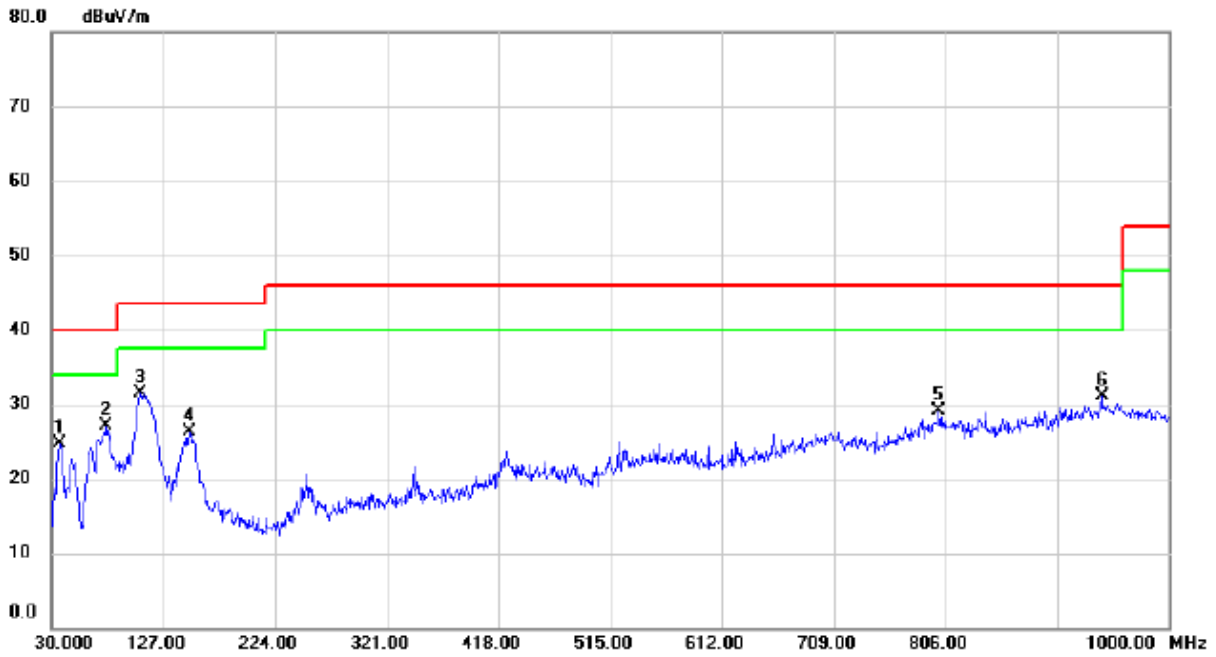

No.	Mk.	Freq. MHz	Reading Level dBuV	Correct Factor dB	Measure- ment dBuV/m	Limit dBuV/m	Margin dB	Detector	Comment
1		36.790	39.55	-14.86	24.69	40.00	-15.31	peak	
2		77.530	45.61	-18.49	27.12	40.00	-12.88	peak	
3	*	106.630	48.51	-16.96	31.55	43.50	-11.95	peak	
4		149.310	37.87	-11.53	26.34	43.50	-17.16	peak	
5		800.180	30.09	-1.04	29.05	46.00	-16.95	peak	
6		941.800	30.09	1.07	31.16	46.00	-14.84	peak	

Test Mode: TX B MODE CHANNEL 06 (Adapter:BN071-A12012U)

**Horizontal**

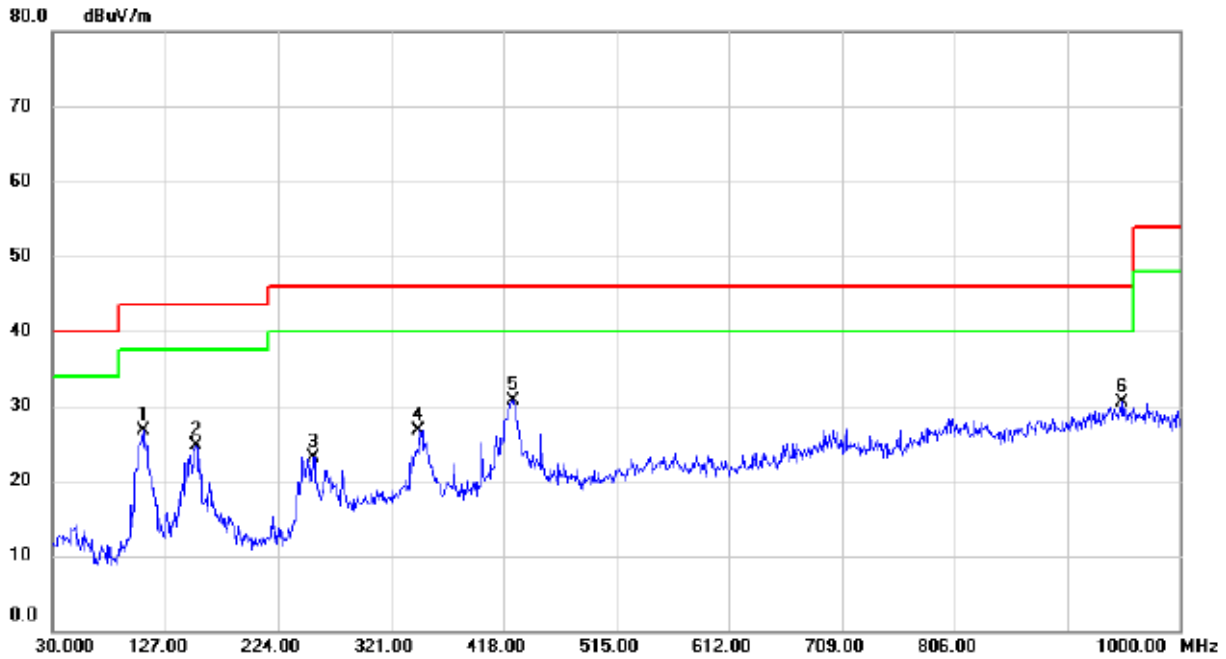

No.	Mk.	Freq. MHz	Reading Level dBuV	Correct Factor dB	Measure- ment dBuV/m	Limit dBuV/m	Margin dB	Detector	Comment
1		107.600	43.51	-16.77	26.74	43.50	-16.76	peak	
2		153.190	35.94	-11.20	24.74	43.50	-18.76	peak	
3		254.070	37.12	-13.98	23.14	46.00	-22.86	peak	
4		345.250	37.80	-11.00	26.80	46.00	-19.20	peak	
5	*	426.730	39.07	-8.33	30.74	46.00	-15.26	peak	
6		950.530	29.07	1.40	30.47	46.00	-15.53	peak	

Test Mode: TX B MODE CHANNEL 11 (Adapter:BN071-A12012U)

**Vertical**

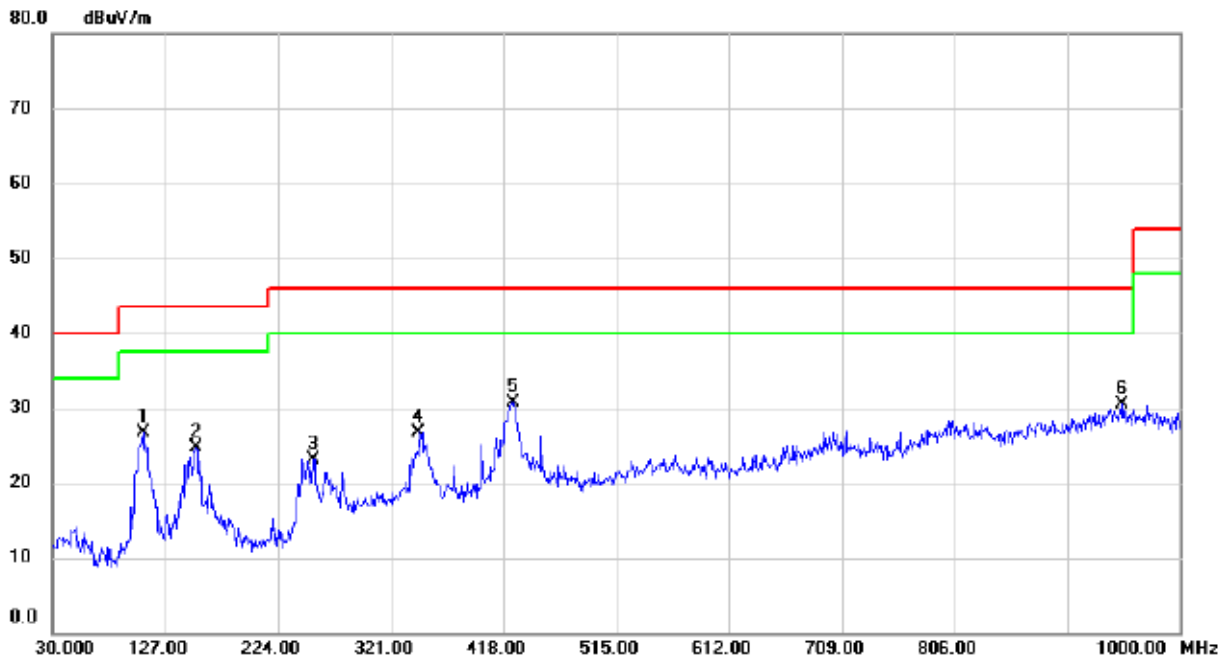

No.	Mk.	Freq. MHz	Reading Level dBuV	Correct Factor dB	Measure- ment dBuV/m	Limit dBuV/m	Margin dB	Detector	Comment
1		107.600	43.51	-16.77	26.74	43.50	-16.76	peak	
2		153.190	35.94	-11.20	24.74	43.50	-18.76	peak	
3		254.070	37.12	-13.98	23.14	46.00	-22.86	peak	
4		345.250	37.80	-11.00	26.80	46.00	-19.20	peak	
5	*	426.730	39.07	-8.33	30.74	46.00	-15.26	peak	
6		950.530	29.07	1.40	30.47	46.00	-15.53	peak	

Test Mode: TX B MODE CHANNEL 11 (Adapter:BN071-A12012U)

Horizontal

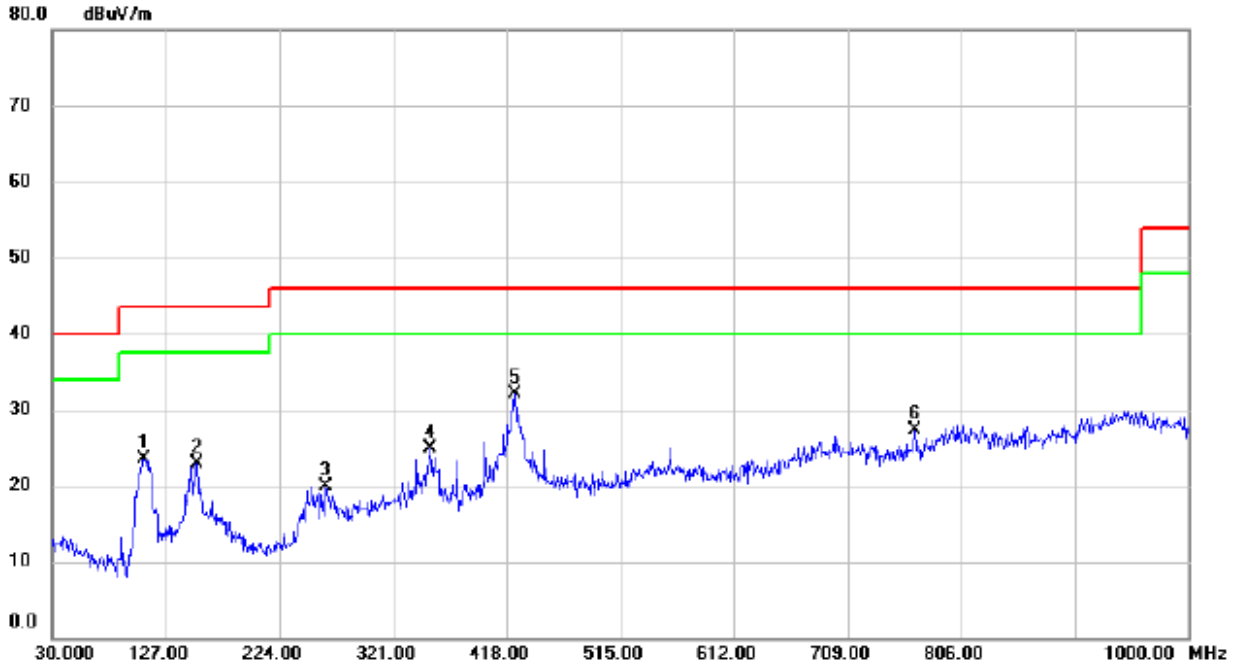

No.	Mk.	Freq. MHz	Reading Level dBuV	Correct Factor dB	Measure- ment dBuV/m	Limit dBuV/m	Margin dB	Detector	Comment
1		108.5700	40.12	-16.56	23.56	43.50	-19.94	peak	
2		153.1900	34.18	-11.20	22.98	43.50	-20.52	peak	
3		263.7700	33.09	-13.14	19.95	46.00	-26.05	peak	
4		353.0100	35.97	-10.98	24.99	46.00	-21.01	peak	
5	*	424.7900	40.46	-8.41	32.05	46.00	-13.95	peak	
6		766.2300	30.32	-3.06	27.26	46.00	-18.74	peak	

## APPENDIX D - RADIATED EMISSION (ABOVE 1000MHZ)

Orthogonal Axis :	X
Test Mode :	TX B MODE 2412MHz

**Vertical**

130 dBuV/m

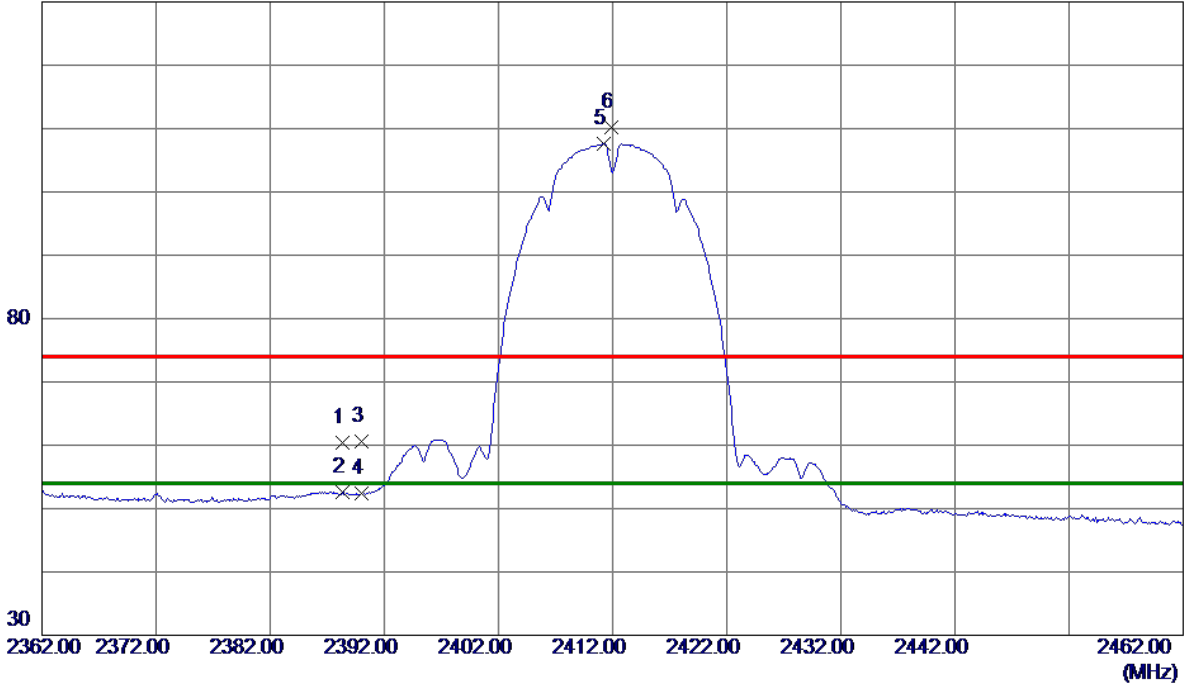

No.	Freq. MHz	Reading Level dBuV/m	Correct Factor dB	Measure ment dBuV/m	Limit dBuV/m	Margin dB	Detector	Comment
1	2388.3000	49.04	11.32	60.36	74.00	-13.64	Peak	
2	2388.3000	41.25	11.32	52.57	54.00	-1.43	AVG	
3	2390.0000	49.30	11.32	60.62	74.00	-13.38	Peak	
4	2390.0000	41.16	11.32	52.48	54.00	-1.52	AVG	
5 *	2411.2000	96.33	11.33	107.66	54.00	53.66	AVG	No Limit
6	2411.9000	98.85	11.33	110.18	74.00	36.18	Peak	No Limit

Orthogonal Axis :	X
Test Mode :	TX B MODE 2412MHz

**Vertical**

80 dBuV/m

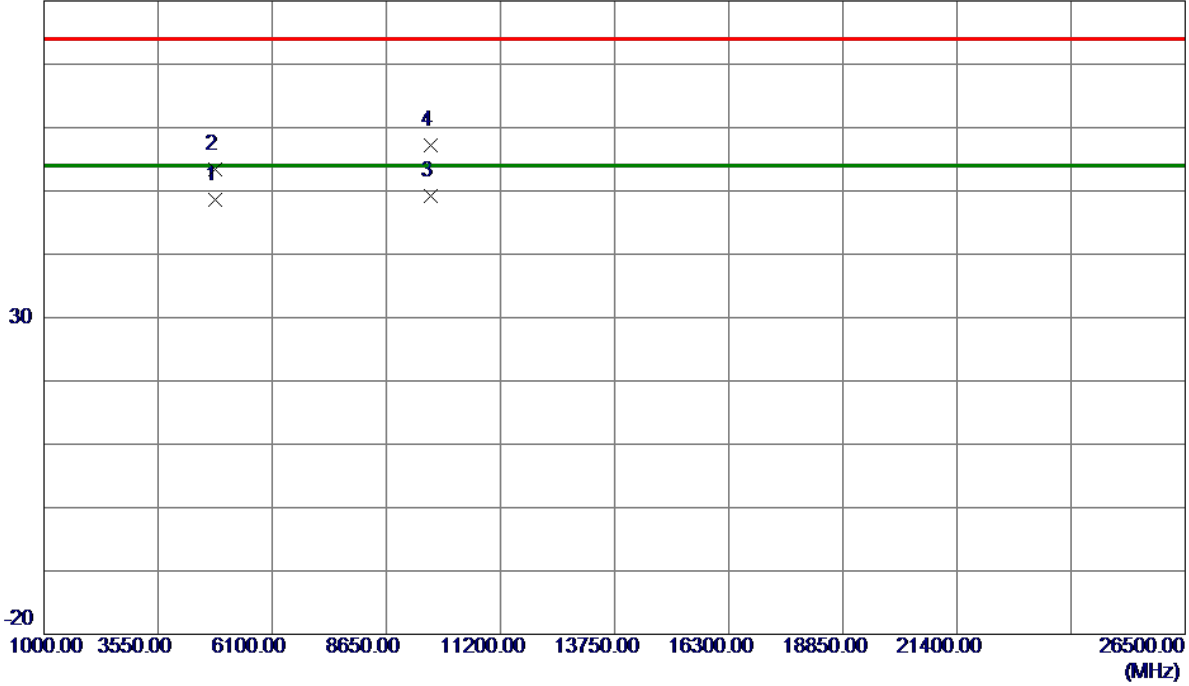

No.	Freq. MHz	Reading Level dBuV/m	Correct Factor dB	Measure ment dBuV/m	Limit dBuV/m	Margin dB	Detector	Comment
1	4823.9900	38.68	10.01	48.69	54.00	-5.31	AVG	
2	4824.2559	43.37	10.02	53.39	74.00	-20.61	Peak	
3 *	9647.8550	29.84	19.45	49.29	54.00	-4.71	AVG	
4	9647.8600	37.74	19.45	57.19	74.00	-16.81	Peak	

Orthogonal Axis :	X
Test Mode :	TX B MODE 2412MHz

### Horizontal

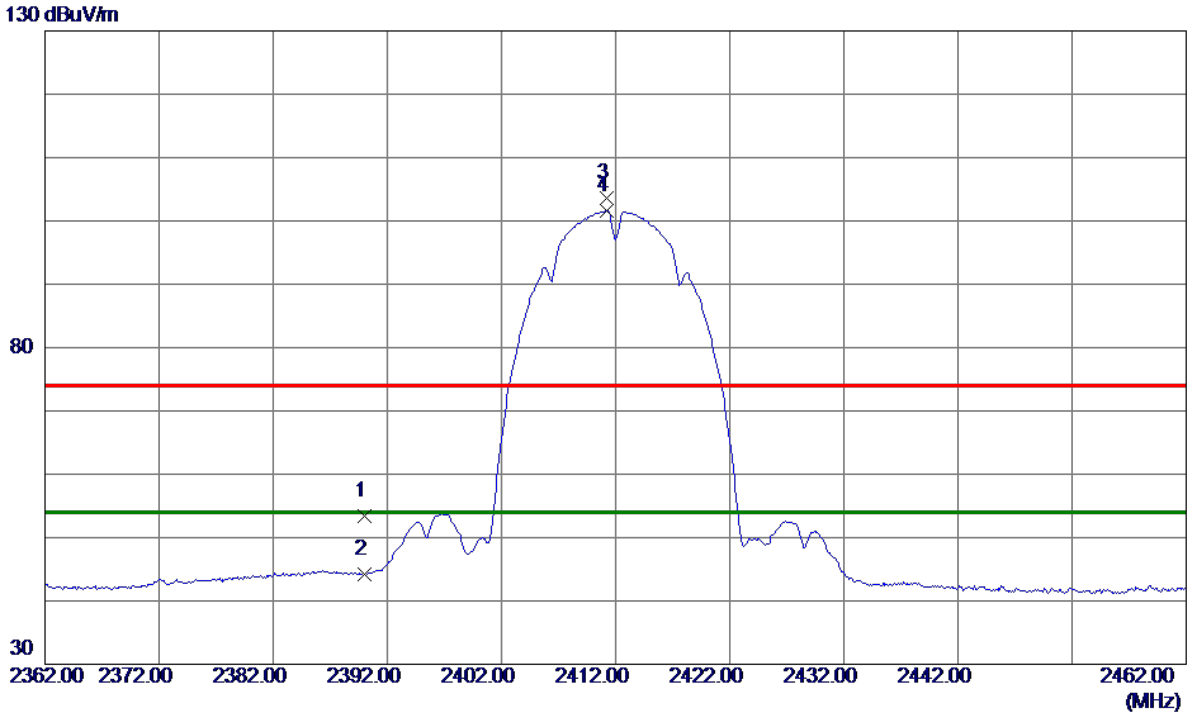

No.	Freq. MHz	Reading Level dBuV/m	Correct Factor dB	Measure ment dBuV/m	Limit dBuV/m	Margin dB	Detector	Comment
1	2390.0000	42.01	11.32	53.33	74.00	-20.67	Peak	
2	2390.0000	32.91	11.32	44.23	54.00	-9.77	AVG	
3	2411.2000	92.34	11.33	103.67	74.00	29.67	Peak	No Limit
4 *	2411.2000	90.32	11.33	101.65	54.00	47.65	AVG	No Limit



Orthogonal Axis :	X
Test Mode :	TX B MODE 2412MHz

### Horizontal

80 dBuV/m

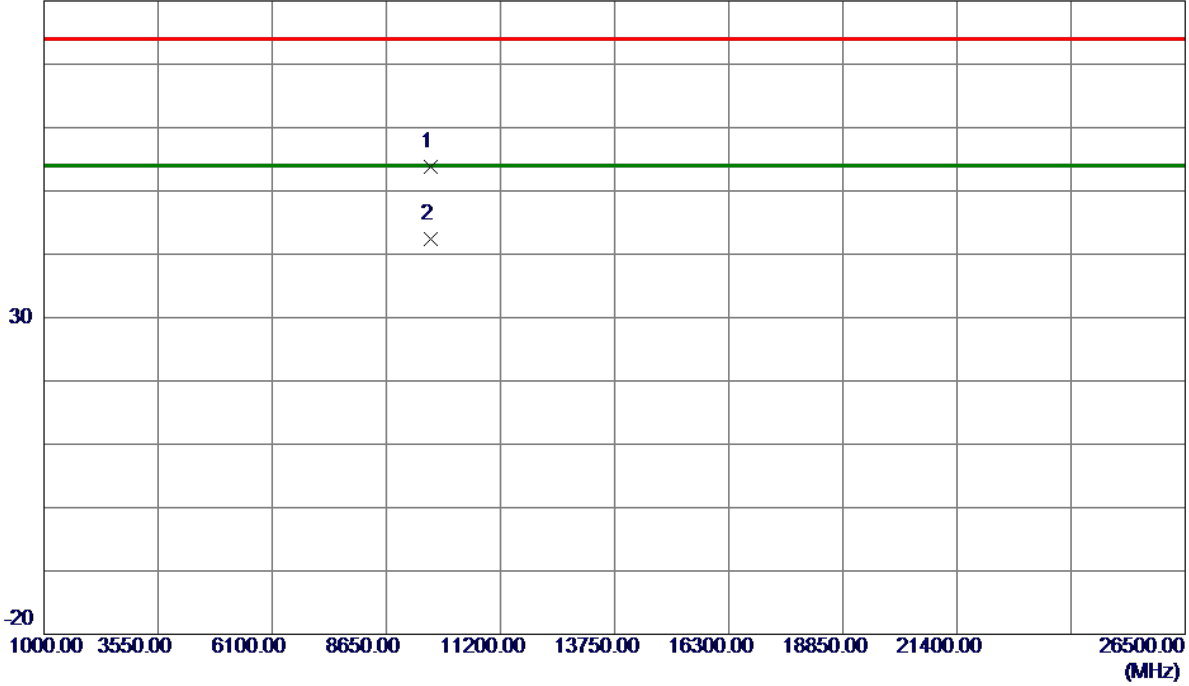

No.	Freq. MHz	Reading Level dBuV/m	Correct Factor dB	Measure ment dBuV/m	Limit dBuV/m	Margin dB	Detector	Comment
1	9644.8500	34.30	19.45	53.75	74.00	-20.25	Peak	
2 *	9647.8600	22.86	19.45	42.31	54.00	-11.69	AVG	

Orthogonal Axis :	X
Test Mode :	TX B MODE 2437MHz

**Vertical**

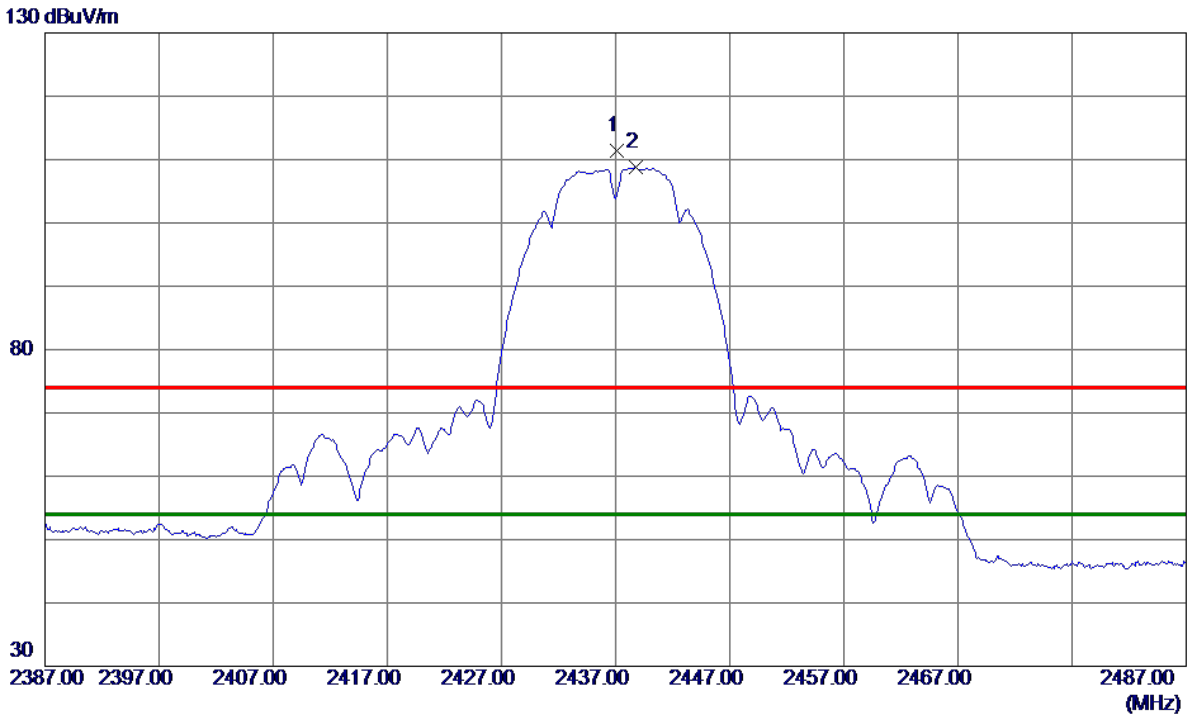

No.	Freq. MHz	Reading Level dBuV/m	Correct Factor dB	Measure ment dBuV/m	Limit dBuV/m	Margin dB	Detector	Comment
1	2437.1000	100.12	11.33	111.45	74.00	37.45	Peak	No Limit
2 *	2438.8000	97.43	11.33	108.76	54.00	54.76	AVG	No Limit

Orthogonal Axis :	X
Test Mode :	TX B MODE 2437MHz

**Vertical**

80 dBuV/m

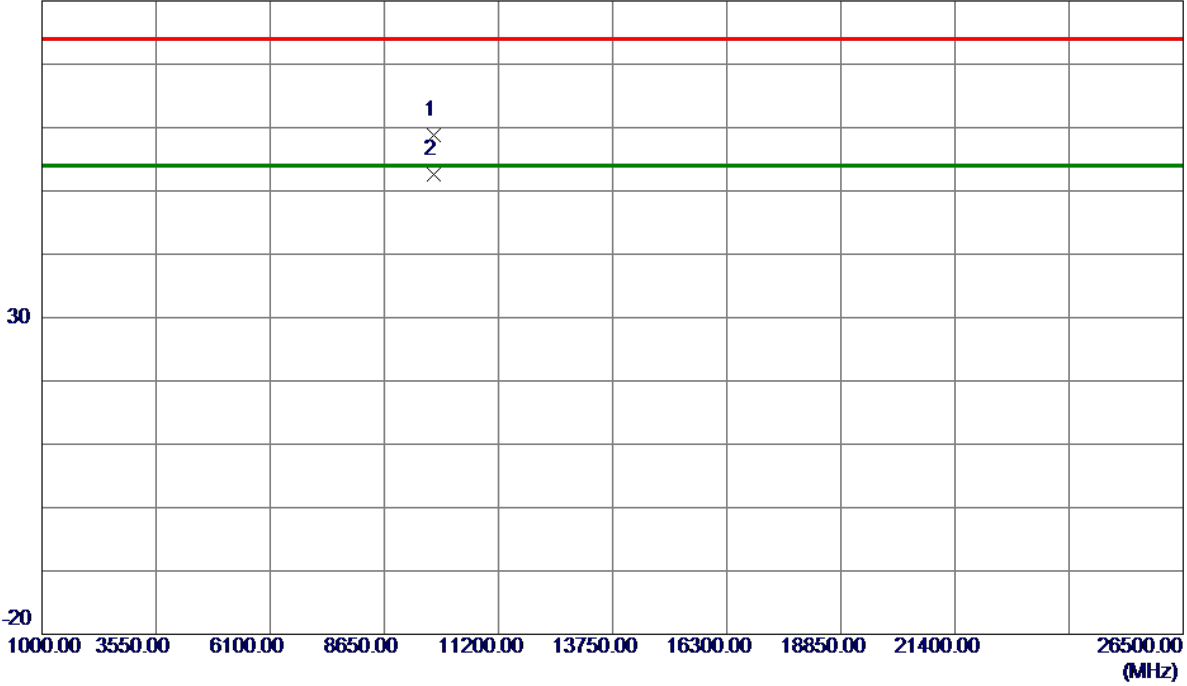

No.	Freq. MHz	Reading Level dBuV/m	Correct Factor dB	Measure ment dBuV/m	Limit dBuV/m	Margin dB	Detector	Comment
1	9747.8500	39.21	19.55	58.76	74.00	-15.24	Peak	
2 *	9747.9400	33.10	19.55	52.65	54.00	-1.35	AVG	

Orthogonal Axis :	X
Test Mode :	TX B MODE 2437MHz

### Horizontal

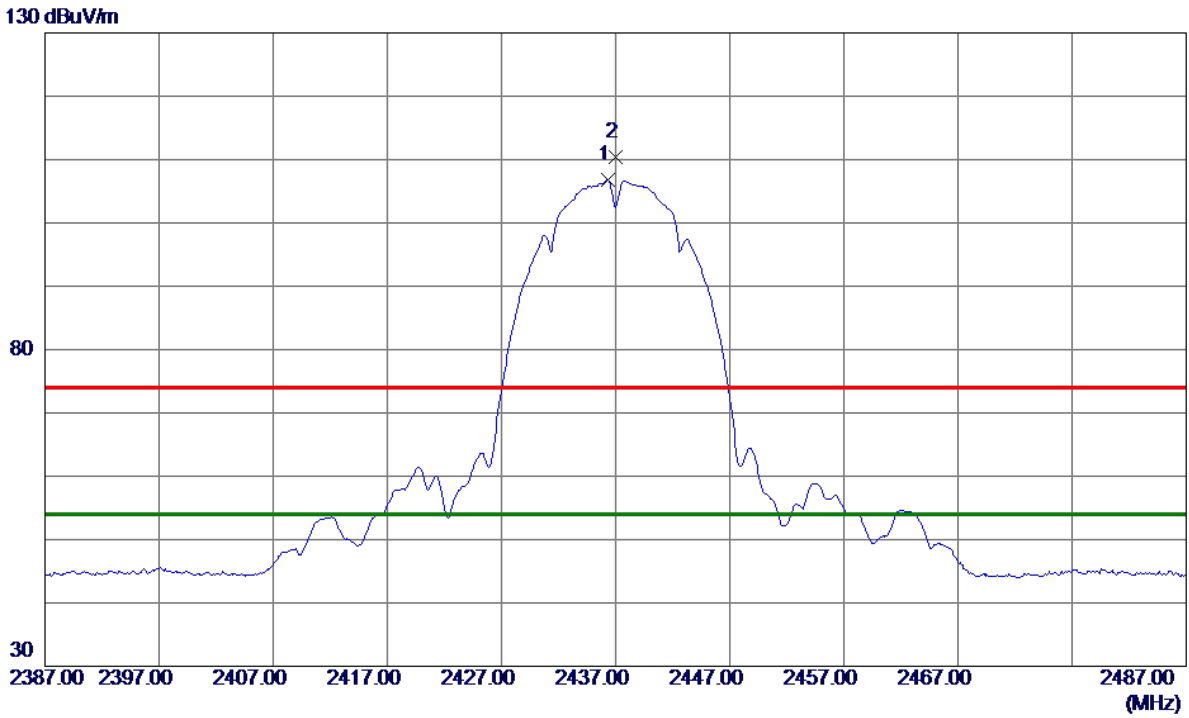

No.	Freq. MHz	Reading Level dBuV/m	Correct Factor dB	Measure ment dBuV/m	Limit dBuV/m	Margin dB	Detector	Comment
1 *	2436.3000	95.40	11.33	106.73	54.00	52.73	AVG	No Limit
2	2437.0000	99.13	11.33	110.46	74.00	36.46	Peak	No Limit

Orthogonal Axis :	X
Test Mode :	TX B MODE 2437MHz

**Horizontal**

80 dBuV/m

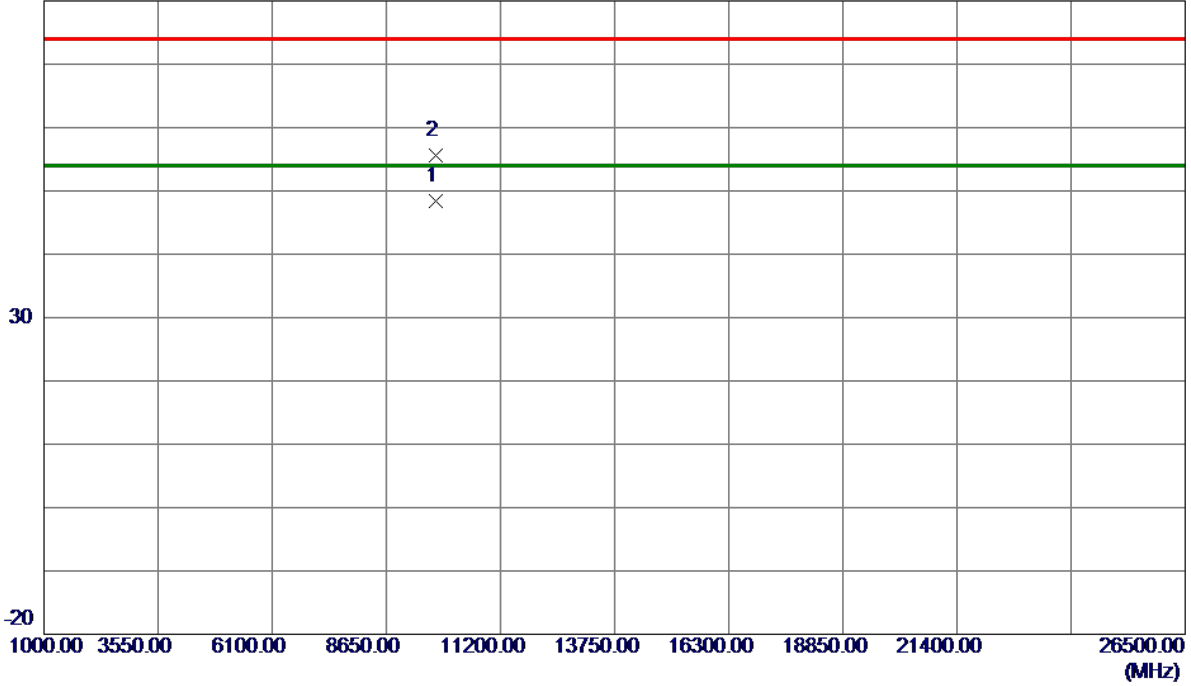

No.	Freq. MHz	Reading Level dBuV/m	Correct Factor dB	Measure ment dBuV/m	Limit dBuV/m	Margin dB	Detector	Comment
1 *	9747.9300	28.90	19.55	48.45	54.00	-5.55	AVG	
2	9748.2800	36.01	19.55	55.56	74.00	-18.44	Peak	

Orthogonal Axis :	X
Test Mode :	TX B MODE 2462MHz

**Vertical**

130 dBuV/m

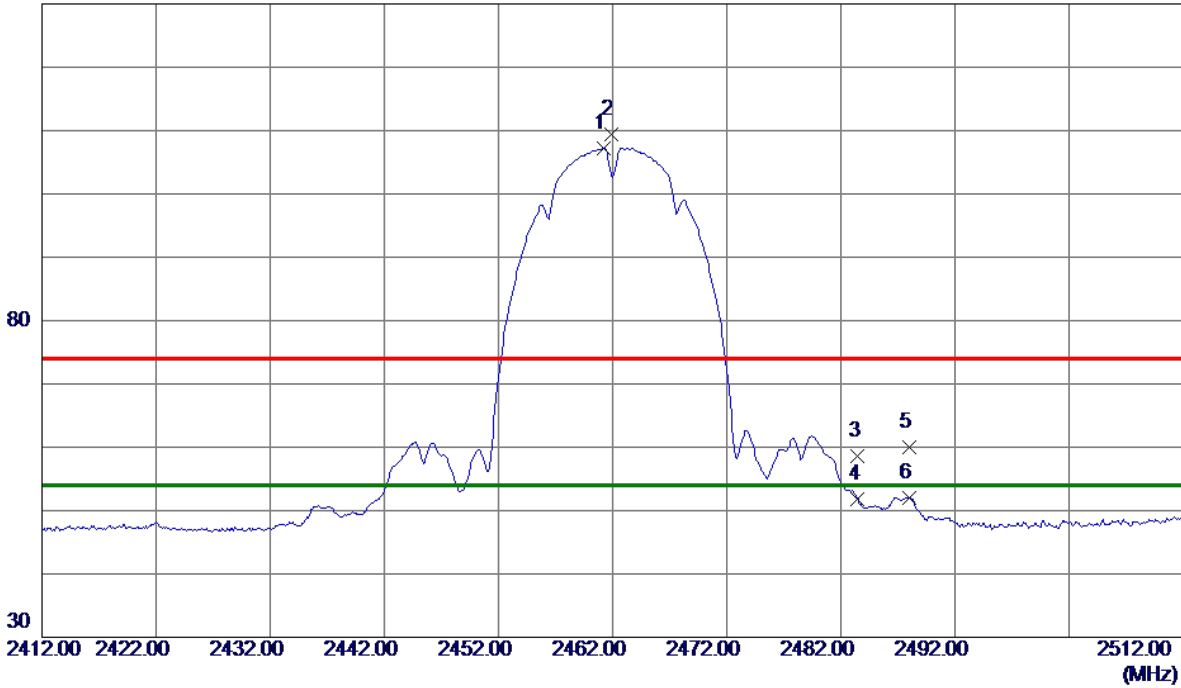

No.	Freq. MHz	Reading Level dBuV/m	Correct Factor dB	Measure ment dBuV/m	Limit dBuV/m	Margin dB	Detector	Comment
1 *	2461.2000	95.84	11.34	107.18	54.00	53.18	AVG	No Limit
2	2461.9000	98.10	11.34	109.44	74.00	35.44	Peak	No Limit
3	2483.5000	47.27	11.35	58.62	74.00	-15.38	Peak	
4	2483.5000	40.39	11.35	51.74	54.00	-2.26	AVG	
5	2488.0000	48.66	11.35	60.01	74.00	-13.99	Peak	
6	2488.0000	40.71	11.35	52.06	54.00	-1.94	AVG	

Orthogonal Axis :	X
Test Mode :	TX B MODE 2462MHz

**Vertical**

80 dBuV/m

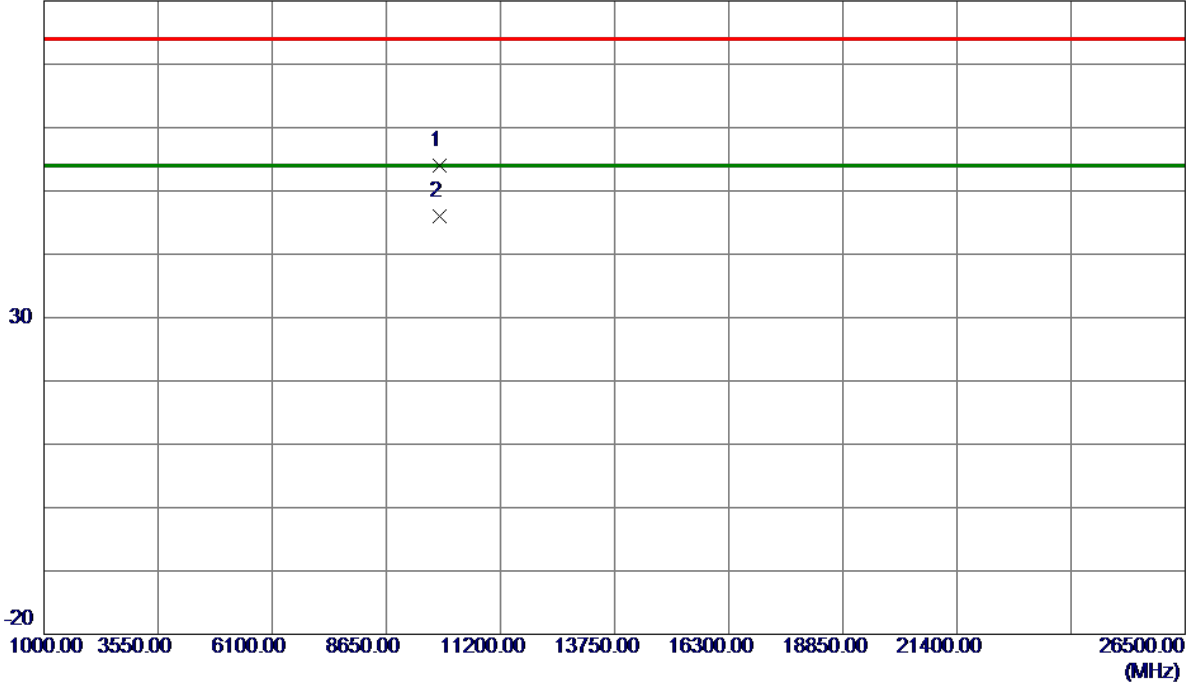

No.	Freq. MHz	Reading Level dBuV/m	Correct Factor dB	Measure ment dBuV/m	Limit dBuV/m	Margin dB	Detector	Comment
1	9847.7500	34.42	19.65	54.07	74.00	-19.93	Peak	
2 *	9847.9800	26.43	19.65	46.08	54.00	-7.92	AVG	

Orthogonal Axis :	X
Test Mode :	TX B MODE 2462MHz

### Horizontal

130 dBuV/m

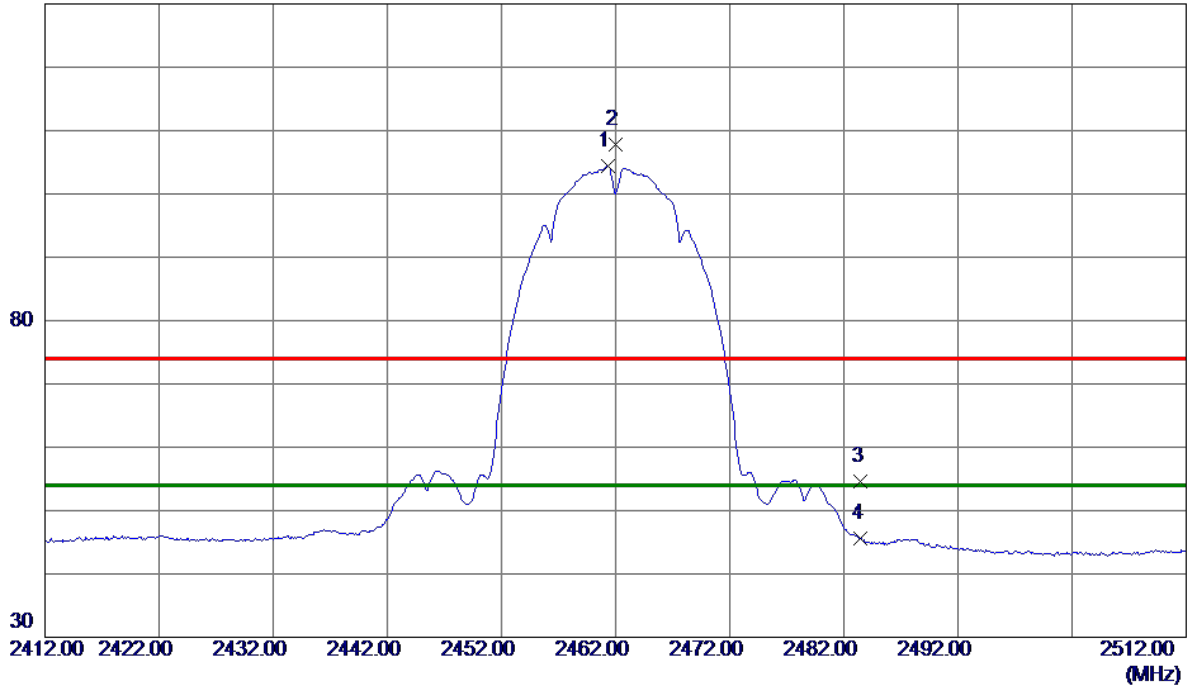

No.	Freq. MHz	Reading Level dBuV/m	Correct Factor dB	Measure ment dBuV/m	Limit dBuV/m	Margin dB	Detector	Comment
1 *	2461.3000	93.01	11.34	104.35	54.00	50.35	AVG	No Limit
2	2462.0000	96.54	11.34	107.88	74.00	33.88	Peak	No Limit
3	2483.5000	43.24	11.35	54.59	74.00	-19.41	Peak	
4	2483.5000	34.18	11.35	45.53	54.00	-8.47	AVG	



Orthogonal Axis :	X
Test Mode :	TX B MODE 2462MHz

### Horizontal

80 dBuV/m

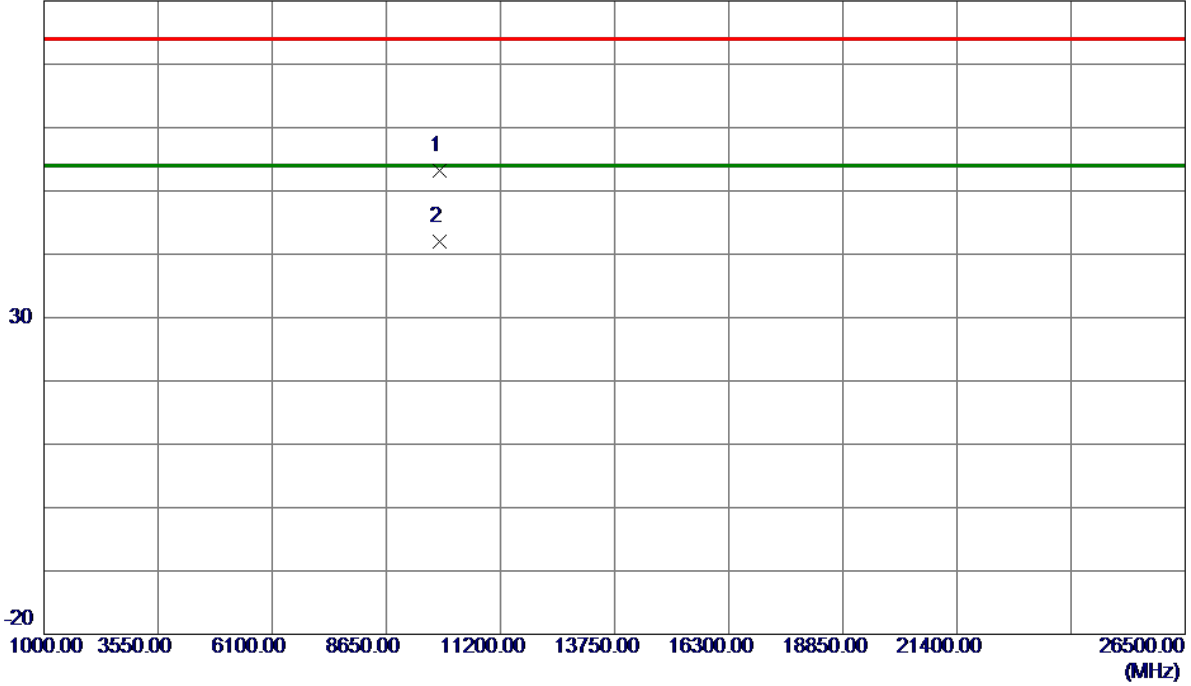

No.	Freq. MHz	Reading Level dBuV/m	Correct Factor dB	Measure ment dBuV/m	Limit dBuV/m	Margin dB	Detector	Comment
1	9847.0900	33.64	19.65	53.29	74.00	-20.71	Peak	
2 *	9847.9000	22.28	19.65	41.93	54.00	-12.07	AVG	

Orthogonal Axis :	X
Test Mode :	TX G MODE 2412MHz

**Vertical**

130 dBuV/m

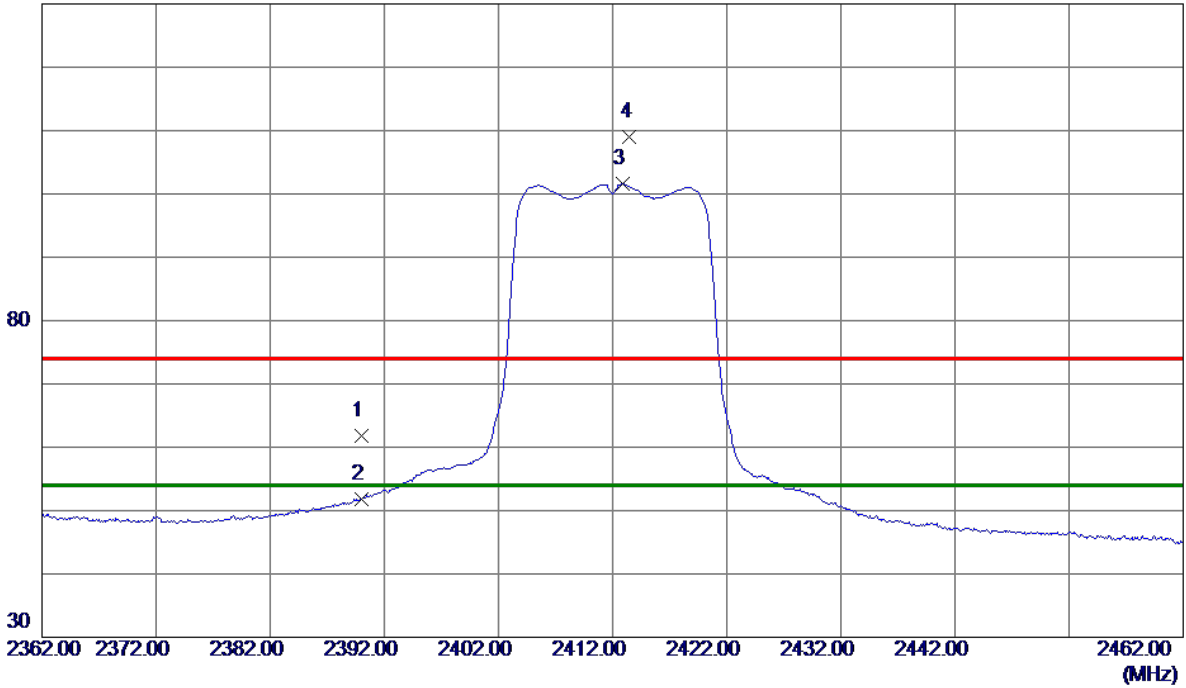

No.	Freq. MHz	Reading Level dBuV/m	Correct Factor dB	Measure ment dBuV/m	Limit dBuV/m	Margin dB	Detector	Comment
1	2390.0000	50.43	11.32	61.75	74.00	-12.25	Peak	
2	2390.0000	40.53	11.32	51.85	54.00	-2.15	AVG	
3 *	2412.9000	90.19	11.33	101.52	54.00	47.52	AVG	No Limit
4	2413.5000	97.68	11.33	109.01	74.00	35.01	Peak	No Limit

Orthogonal Axis :	X
Test Mode :	TX G MODE 2412MHz

**Vertical**

80 dBuV/m

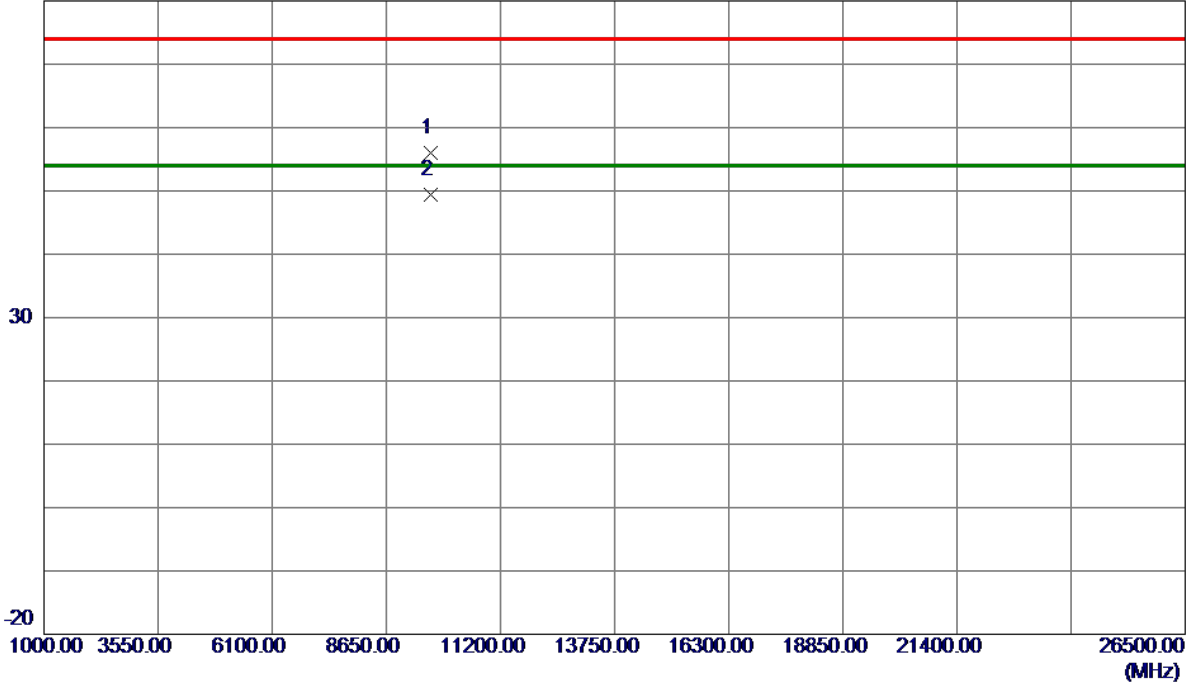

No.	Freq. MHz	Reading Level dBuV/m	Correct Factor dB	Measure ment dBuV/m	Limit dBuV/m	Margin dB	Detector	Comment
1	9647.8900	36.50	19.45	55.95	74.00	-18.05	Peak	
2 *	9648.0199	29.87	19.46	49.33	54.00	-4.67	AVG	

Orthogonal Axis :	X
Test Mode :	TX G MODE 2412MHz

### Horizontal

130 dBuV/m

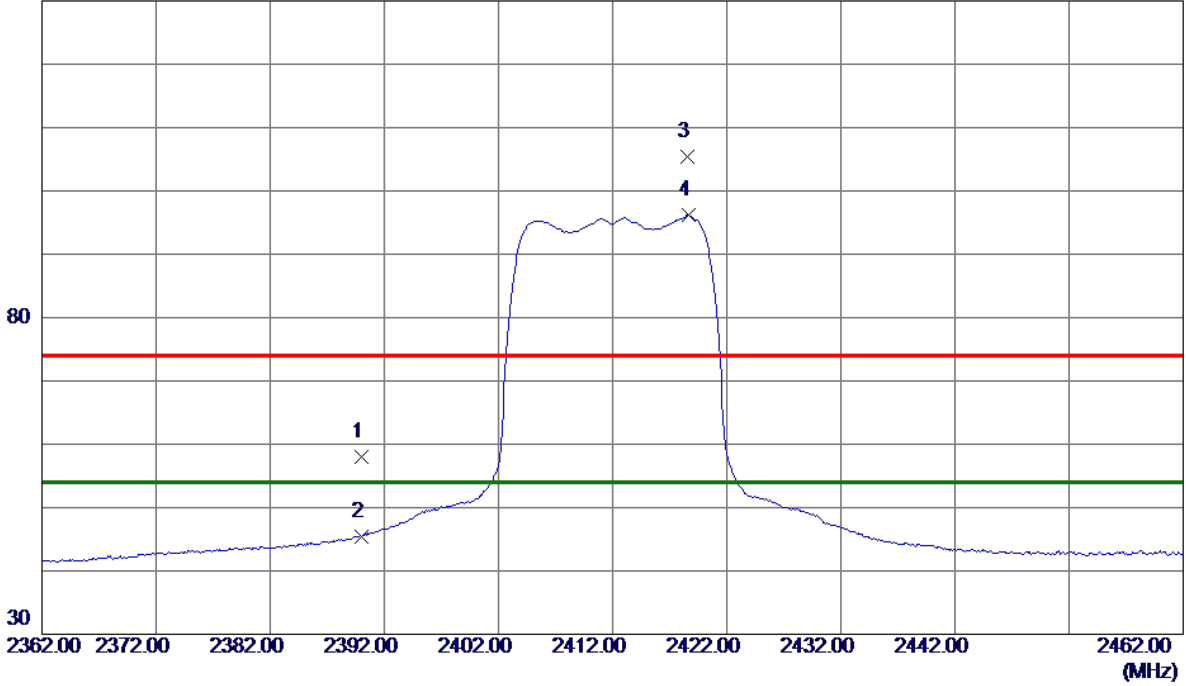

No.	Freq. MHz	Reading Level dBuV/m	Correct Factor dB	Measure ment dBuV/m	Limit dBuV/m	Margin dB	Detector	Comment
1	2390.0000	46.67	11.32	57.99	74.00	-16.01	Peak	
2	2390.0000	34.15	11.32	45.47	54.00	-8.53	AVG	
3	2418.6000	94.04	11.33	105.37	74.00	31.37	Peak	No Limit
4 *	2418.7000	84.79	11.33	96.12	54.00	42.12	AVG	No Limit

Orthogonal Axis :	X
Test Mode :	TX G MODE 2412MHz

### Horizontal

80 dBuV/m

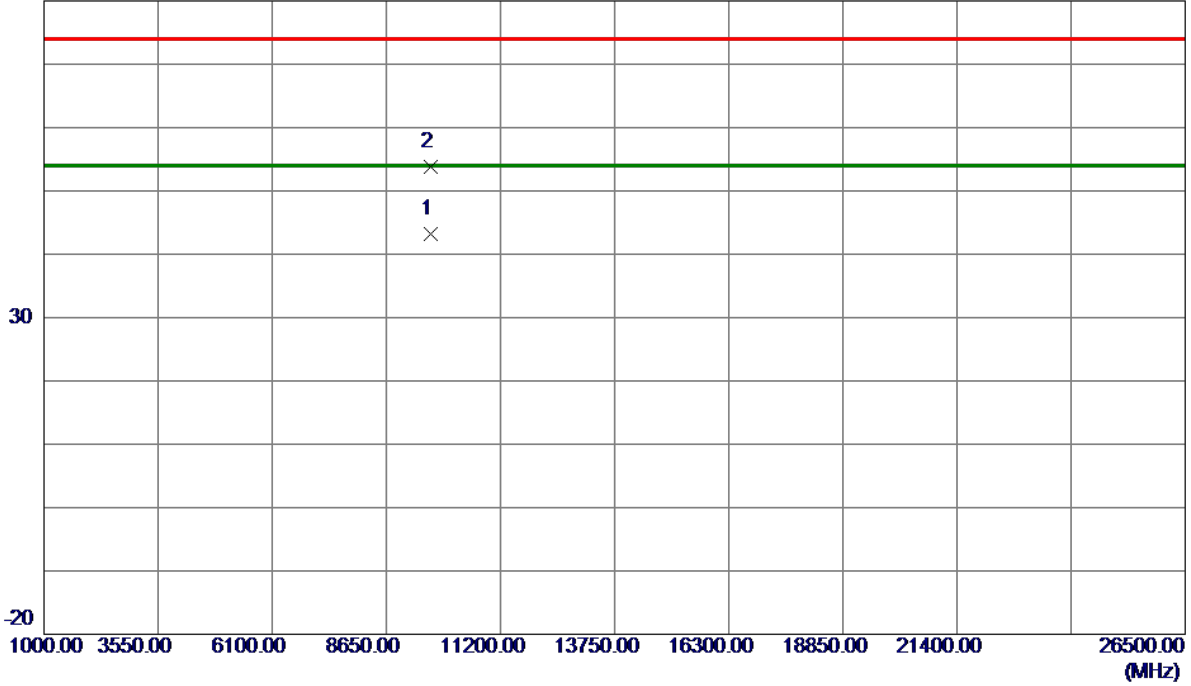

No.	Freq. MHz	Reading Level dBuV/m	Correct Factor dB	Measure ment dBuV/m	Limit dBuV/m	Margin dB	Detector	Comment
1 *	9647.9800	23.76	19.46	43.22	54.00	-10.78	AVG	
2	9648.0400	34.25	19.46	53.71	74.00	-20.29	Peak	

Orthogonal Axis :	X
Test Mode :	TX G MODE 2437MHz

**Vertical**

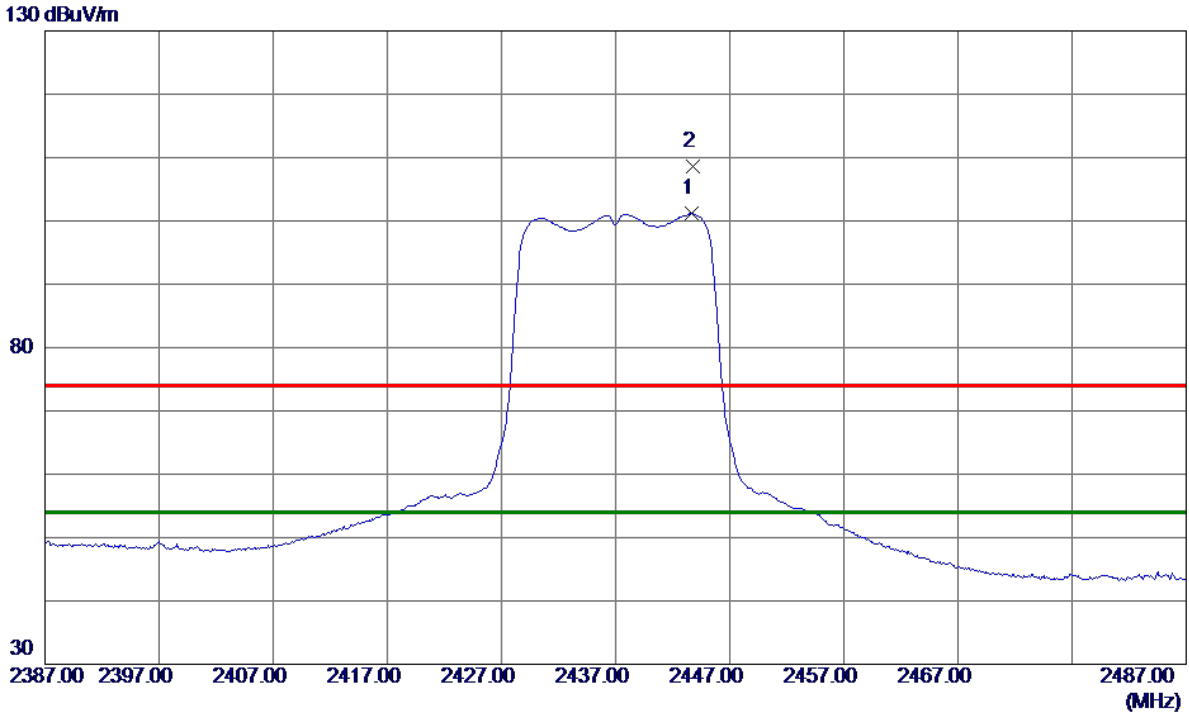

No.	Freq. MHz	Reading Level dBuV/m	Correct Factor dB	Measure ment dBuV/m	Limit dBuV/m	Margin dB	Detector	Comment
1 *	2443.7000	89.88	11.33	101.21	54.00	47.21	AVG	No Limit
2	2443.8000	97.20	11.33	108.53	74.00	34.53	Peak	No Limit

Orthogonal Axis :	X
Test Mode :	TX G MODE 2437MHz

**Vertical**

80 dBuV/m

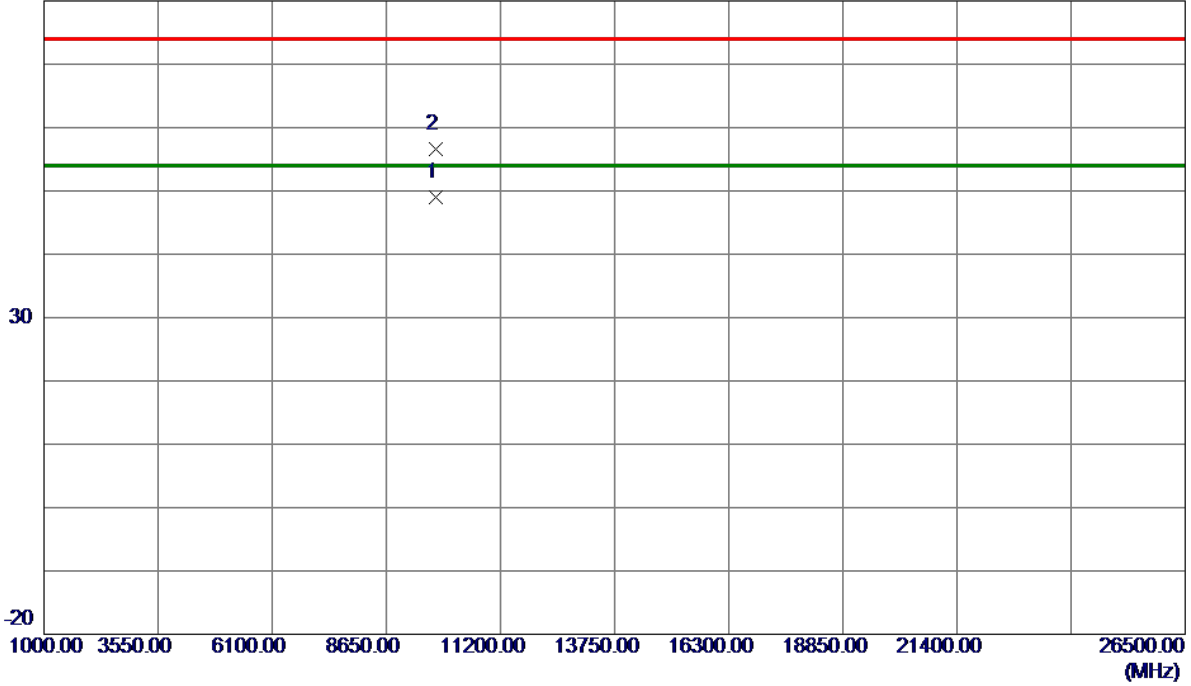

No.	Freq. MHz	Reading Level dBuV/m	Correct Factor dB	Measure ment dBuV/m	Limit dBuV/m	Margin dB	Detector	Comment
1 *	9747.9300	29.43	19.55	48.98	54.00	-5.02	AVG	
2	9748.2000	37.14	19.55	56.69	74.00	-17.31	Peak	

Orthogonal Axis :	X
Test Mode :	TX G MODE 2437MHz

### Horizontal

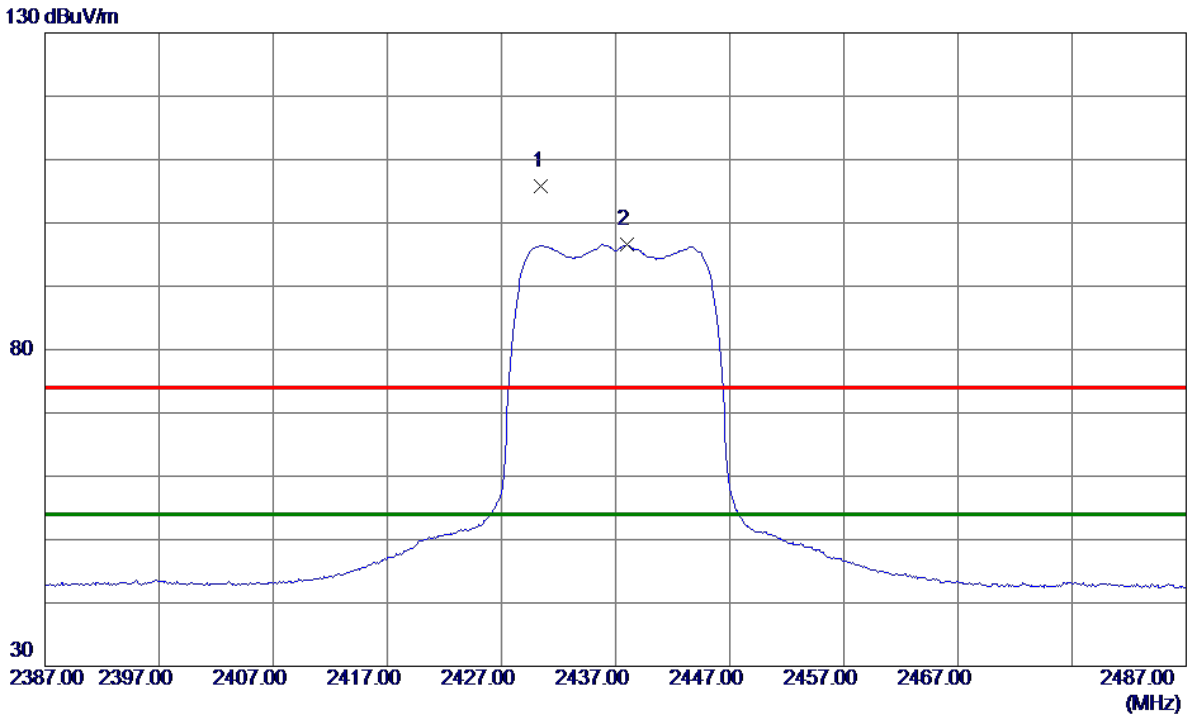

No.	Freq. MHz	Reading Level dBuV/m	Correct Factor dB	Measure ment dBuV/m	Limit dBuV/m	Margin dB	Detector	Comment
1	2430.5000	94.51	11.33	105.84	74.00	31.84	Peak	No Limit
2 *	2438.0000	85.22	11.33	96.55	54.00	42.55	AVG	No Limit



Orthogonal Axis :	X
Test Mode :	TX G MODE 2437MHz

### Horizontal

80 dBuV/m

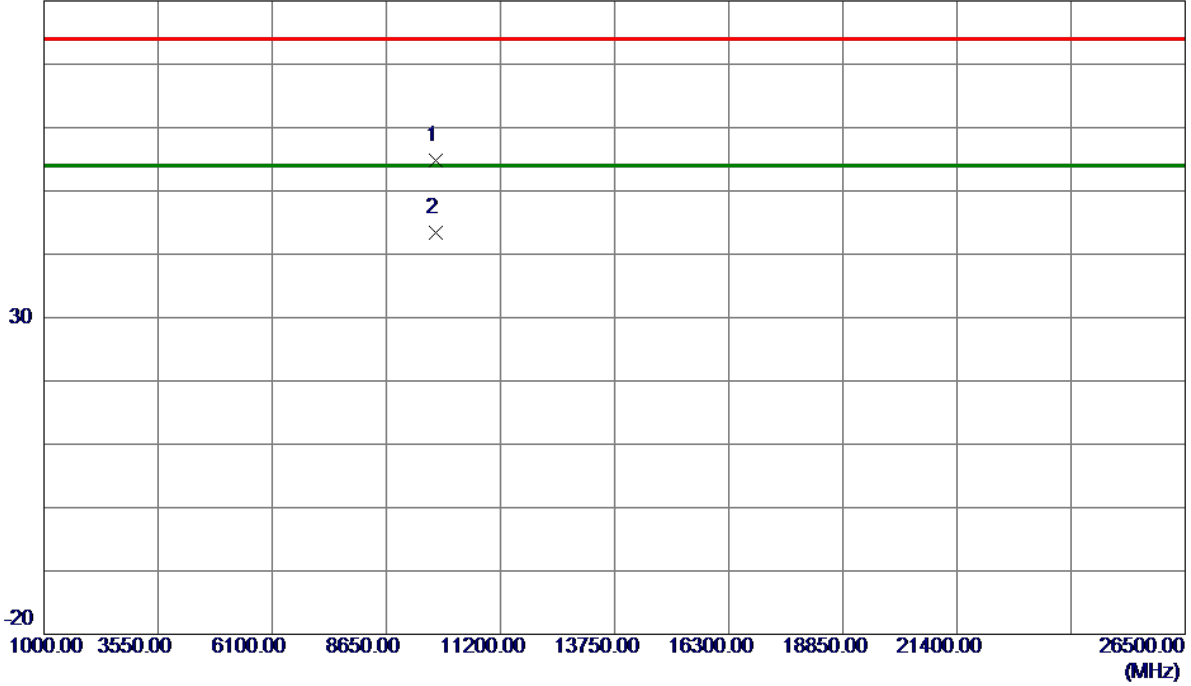

No.	Freq. MHz	Reading Level dBuV/m	Correct Factor dB	Measure ment dBuV/m	Limit dBuV/m	Margin dB	Detector	Comment
1	9747.3099	35.29	19.55	54.84	74.00	-19.16	Peak	
2 *	9747.8600	23.91	19.55	43.46	54.00	-10.54	AVG	

Orthogonal Axis :	X
Test Mode :	TX G MODE 2462MHz

**Vertical**

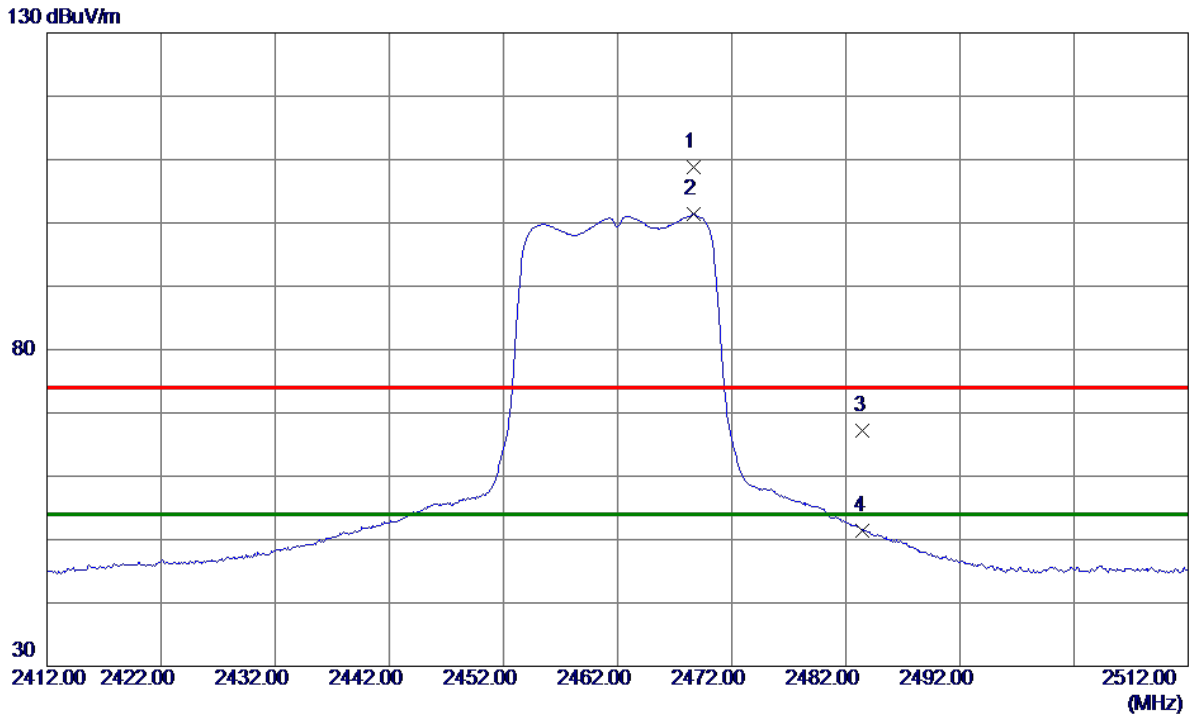

No.	Freq. MHz	Reading Level dBuV/m	Correct Factor dB	Measure ment dBuV/m	Limit dBuV/m	Margin dB	Detector	Comment
1	2468.7000	97.41	11.34	108.75	74.00	34.75	Peak	No Limit
2 *	2468.7000	89.98	11.34	101.32	54.00	47.32	AVG	No Limit
3	2483.5000	55.79	11.35	67.14	74.00	-6.86	Peak	
4	2483.5000	40.10	11.35	51.45	54.00	-2.55	AVG	

Orthogonal Axis :	X
Test Mode :	TX G MODE 2462MHz

**Vertical**

80 dBuV/m

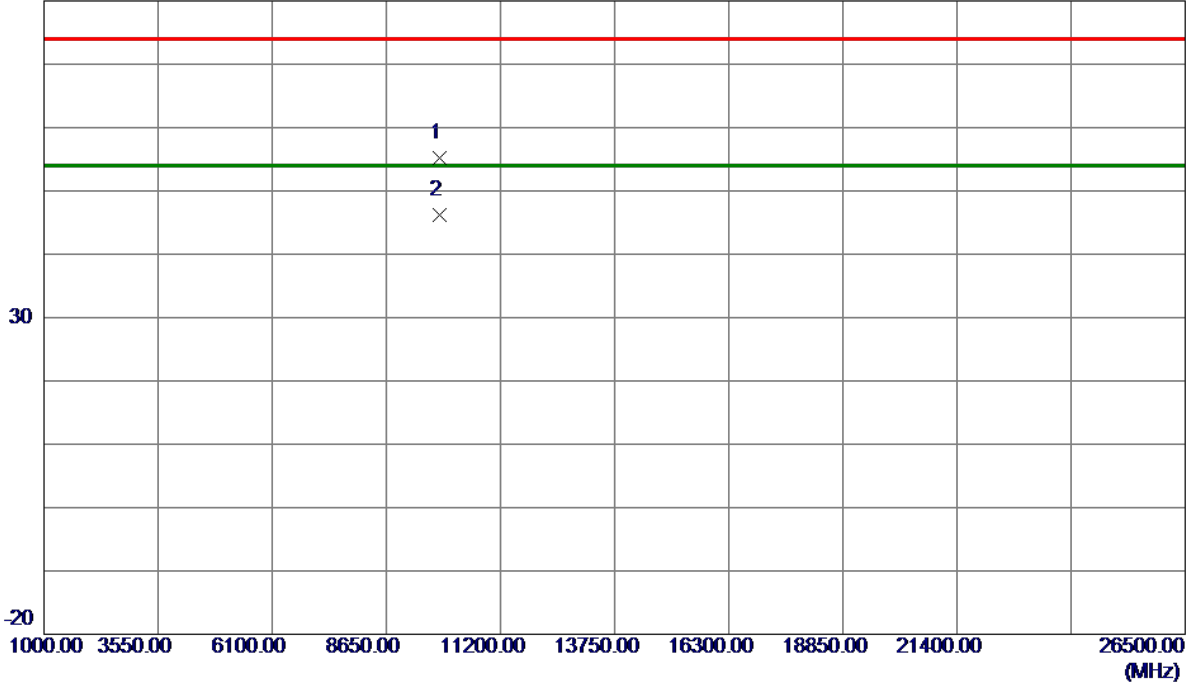

No.	Freq. MHz	Reading Level dBuV/m	Correct Factor dB	Measure ment dBuV/m	Limit dBuV/m	Margin dB	Detector	Comment
1	9847.9600	35.55	19.65	55.20	74.00	-18.80	Peak	
2 *	9848.0000	26.56	19.65	46.21	54.00	-7.79	AVG	

Orthogonal Axis :	X
Test Mode :	TX G MODE 2462MHz

### Horizontal

130 dBuV/m

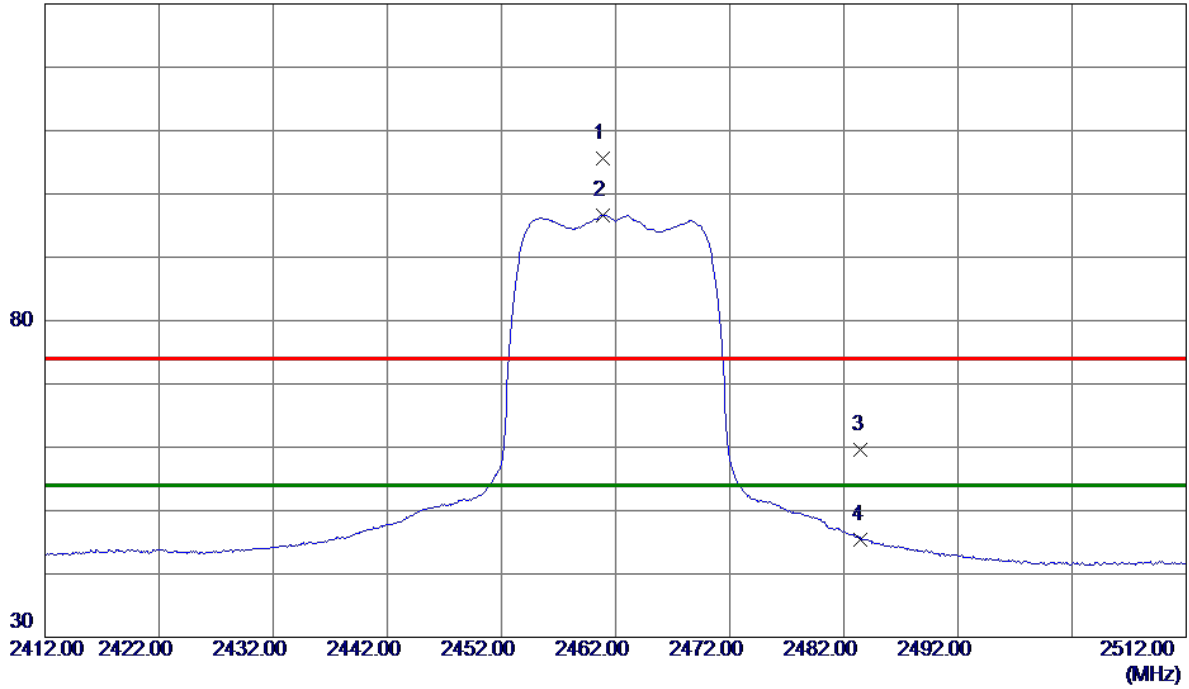

No.	Freq. MHz	Reading Level dBuV/m	Correct Factor dB	Measure ment dBuV/m	Limit dBuV/m	Margin dB	Detector	Comment
1	2460.9000	94.35	11.34	105.69	74.00	31.69	Peak	No Limit
2 *	2460.9000	85.34	11.34	96.68	54.00	42.68	AVG	No Limit
3	2483.5000	48.27	11.35	59.62	74.00	-14.38	Peak	
4	2483.5000	34.13	11.35	45.48	54.00	-8.52	AVG	

Orthogonal Axis :	X
Test Mode :	TX G MODE 2462MHz

### Horizontal

80 dBuV/m

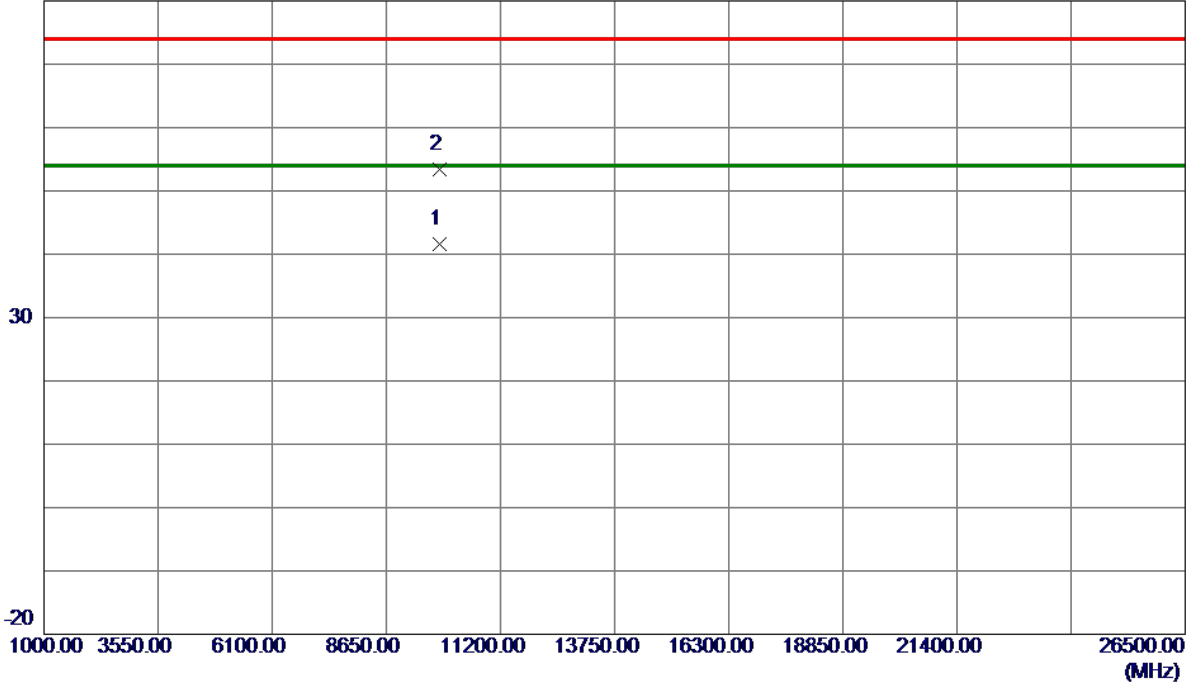

No.	Freq. MHz	Reading Level dBuV/m	Correct Factor dB	Measure ment dBuV/m	Limit dBuV/m	Margin dB	Detector	Comment
1 *	9847.8700	22.02	19.65	41.67	54.00	-12.33	AVG	
2	9848.1600	33.79	19.65	53.44	74.00	-20.56	Peak	

Orthogonal Axis :	X
Test Mode :	TX N-20M MODE 2412MHz

**Vertical**

130 dBuV/m

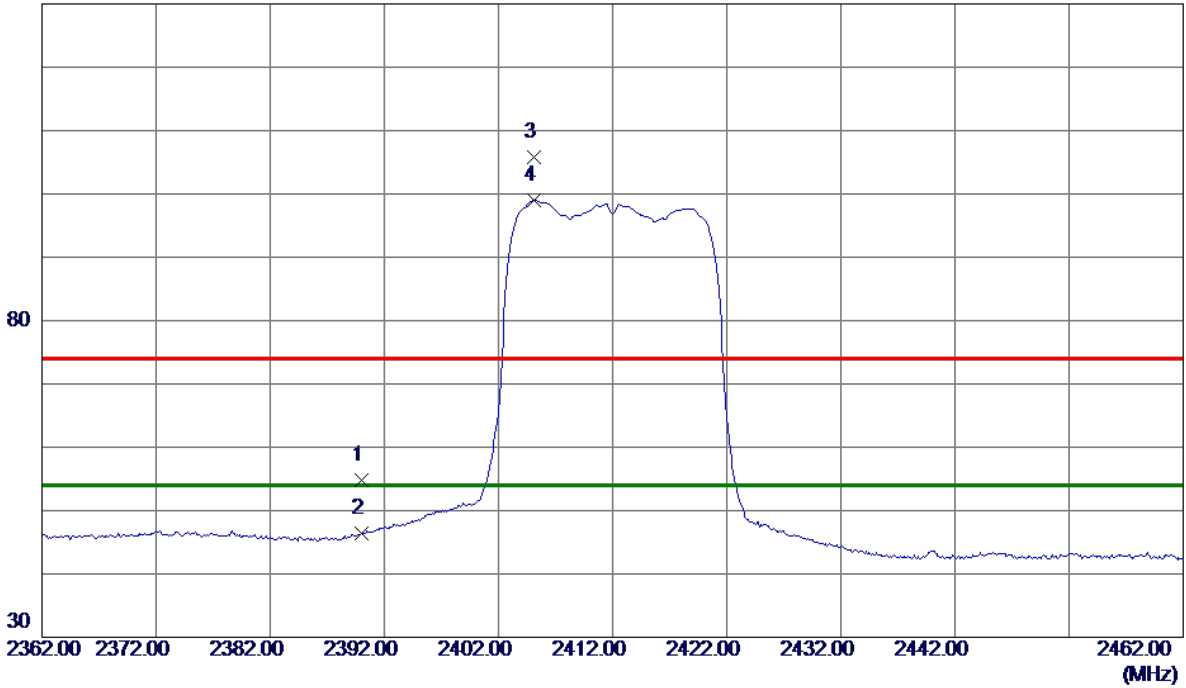

No.	Freq. MHz	Reading Level dBuV/m	Correct Factor dB	Measure ment dBuV/m	Limit dBuV/m	Margin dB	Detector	Comment
1	2390.0000	43.54	11.32	54.86	74.00	-19.14	Peak	
2	2390.0000	34.99	11.32	46.31	54.00	-7.69	AVG	
3	2405.1000	94.51	11.32	105.83	74.00	31.83	Peak	No Limit
4 *	2405.1000	87.67	11.32	98.99	54.00	44.99	AVG	No Limit

Orthogonal Axis :	X
Test Mode :	TX N-20M MODE 2412MHz

**Vertical**

80 dBuV/m

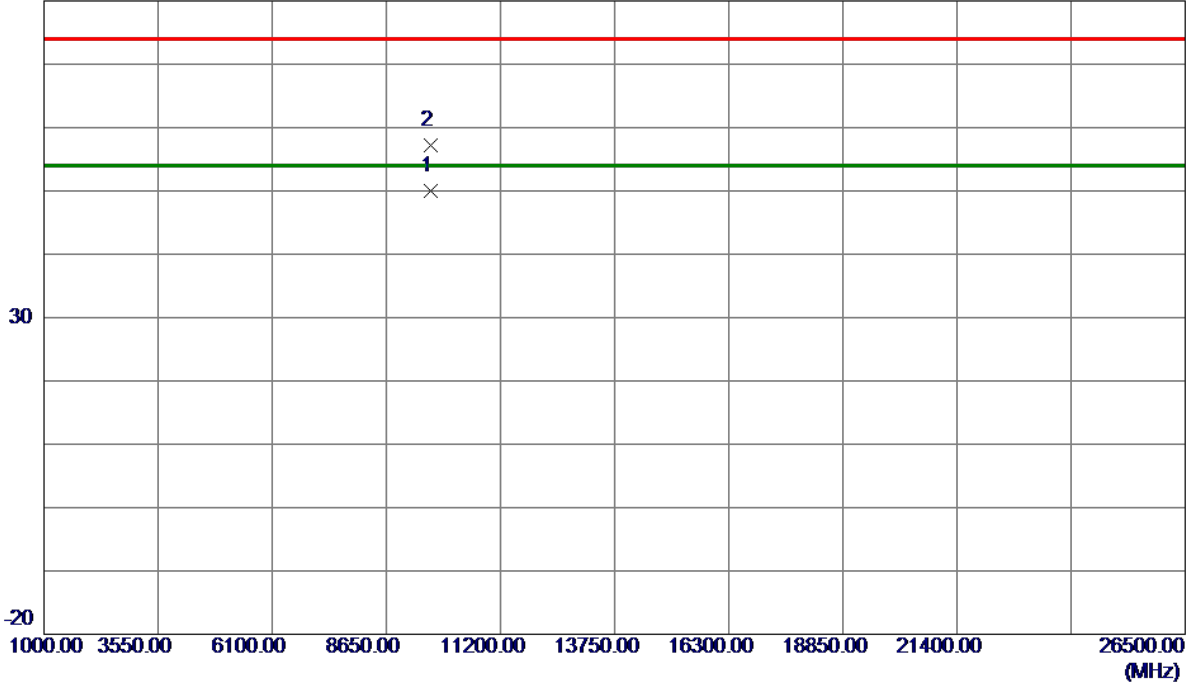

No.	Freq. MHz	Reading Level dBuV/m	Correct Factor dB	Measure ment dBuV/m	Limit dBuV/m	Margin dB	Detector	Comment
1 *	9647.9850	30.58	19.46	50.04	54.00	-3.96	AVG	
2	9648.2000	37.69	19.46	57.15	74.00	-16.85	Peak	

Orthogonal Axis :	X
Test Mode :	TX N-20M MODE 2412MHz

### Horizontal

130 dBuV/m

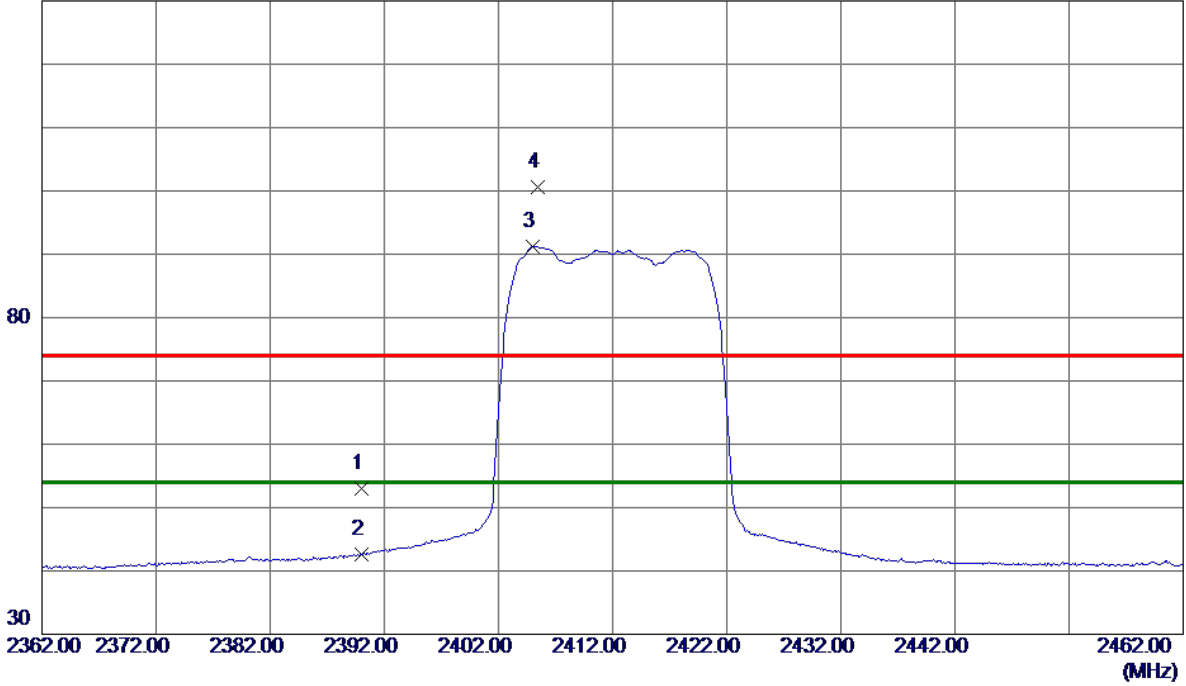

No.	Freq. MHz	Reading Level dBuV/m	Correct Factor dB	Measure ment dBuV/m	Limit dBuV/m	Margin dB	Detector	Comment
1	2390.0000	41.72	11.32	53.04	74.00	-20.96	Peak	
2	2390.0000	31.32	11.32	42.64	54.00	-11.36	AVG	
3 *	2405.0000	79.91	11.32	91.23	54.00	37.23	AVG	No Limit
4	2405.4000	89.19	11.32	100.51	74.00	26.51	Peak	No Limit



Orthogonal Axis :	X
Test Mode :	TX N-20M MODE 2412MHz

**Horizontal**

80 dBuV/m

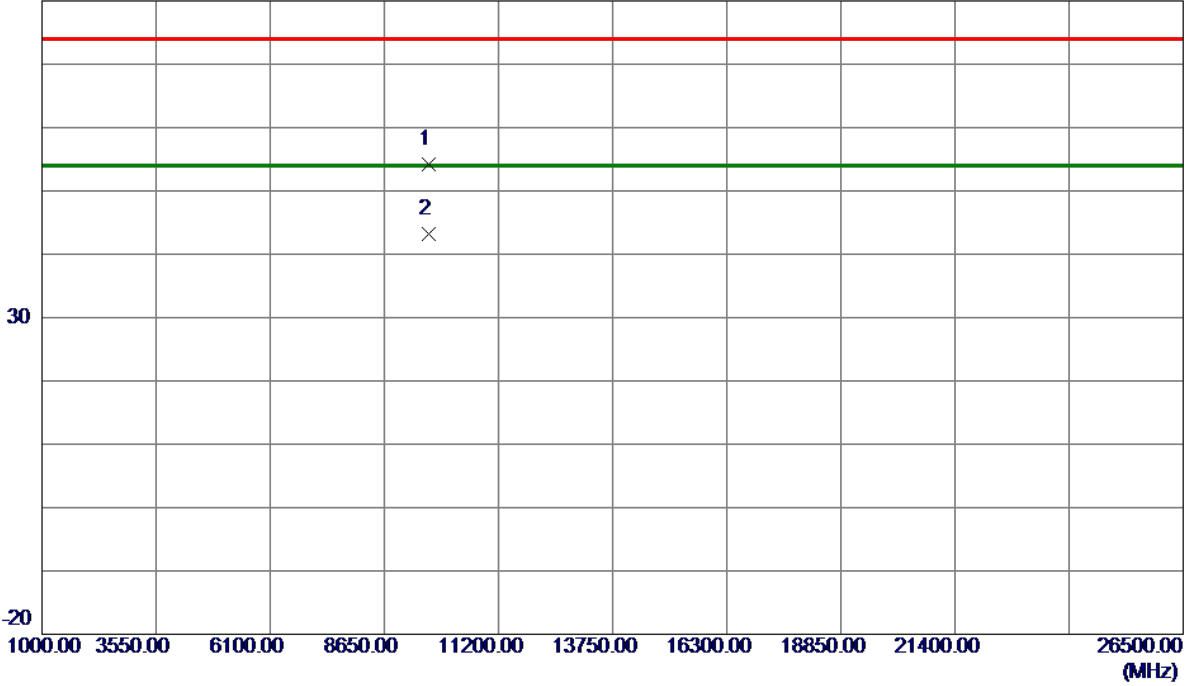

No.	Freq. MHz	Reading Level dBuV/m	Correct Factor dB	Measure ment dBuV/m	Limit dBuV/m	Margin dB	Detector	Comment
1	9647.9100	34.78	19.45	54.23	74.00	-19.77	Peak	
2 *	9648.0199	23.68	19.46	43.14	54.00	-10.86	AVG	

Orthogonal Axis :	X
Test Mode :	TX N-20M MODE 2437MHz

**Vertical**

130 dBuV/m

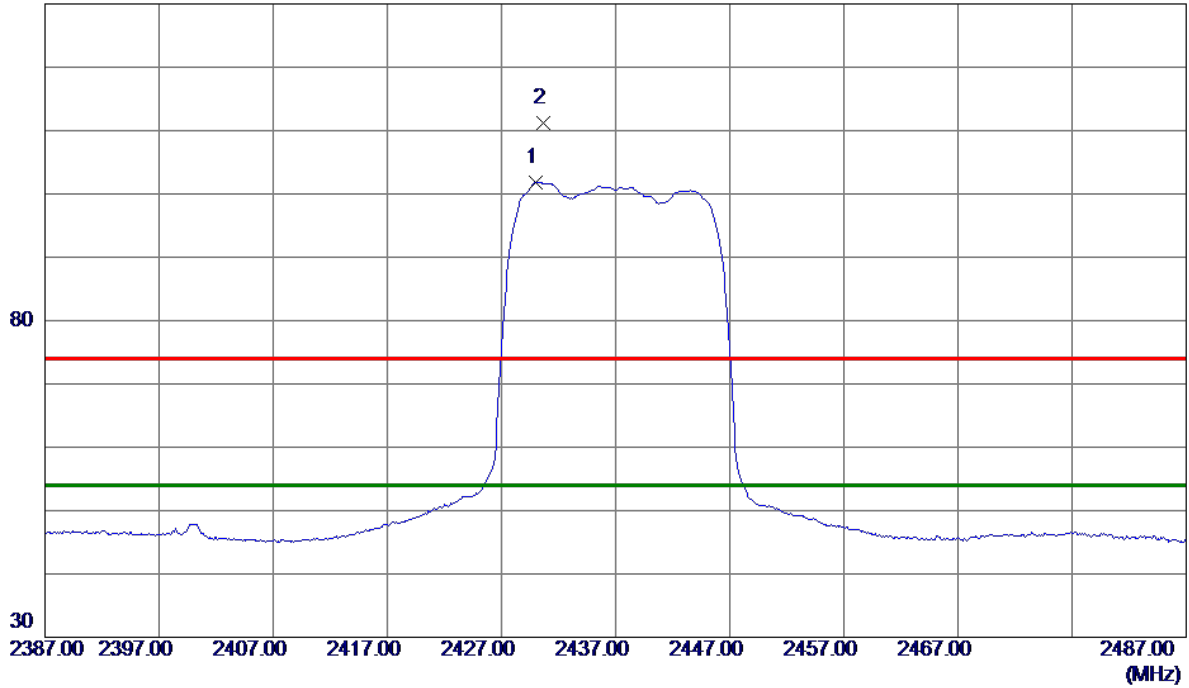

No.	Freq. MHz	Reading Level dBuV/m	Correct Factor dB	Measure ment dBuV/m	Limit dBuV/m	Margin dB	Detector	Comment
1 *	2430.0000	90.48	11.33	101.81	54.00	47.81	AVG	No Limit
2	2430.7000	99.82	11.33	111.15	74.00	37.15	Peak	No Limit

Orthogonal Axis :	X
Test Mode :	TX N-20M MODE 2437MHz

**Vertical**

80 dBuV/m

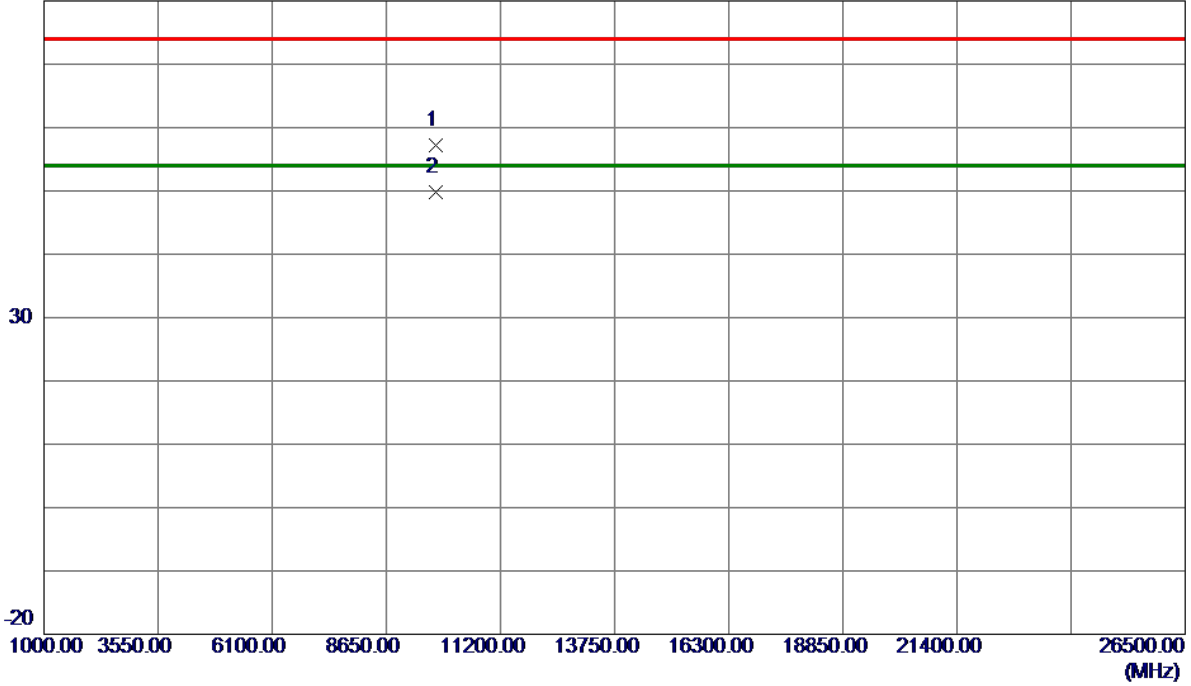

No.	Freq. MHz	Reading Level dBuV/m	Correct Factor dB	Measure ment dBuV/m	Limit dBuV/m	Margin dB	Detector	Comment
1	9748.0000	37.74	19.55	57.29	74.00	-16.71	Peak	
2 *	9748.0050	30.19	19.55	49.74	54.00	-4.26	AVG	

Orthogonal Axis :	X
Test Mode :	TX N-20M MODE 2437MHz

**Horizontal**

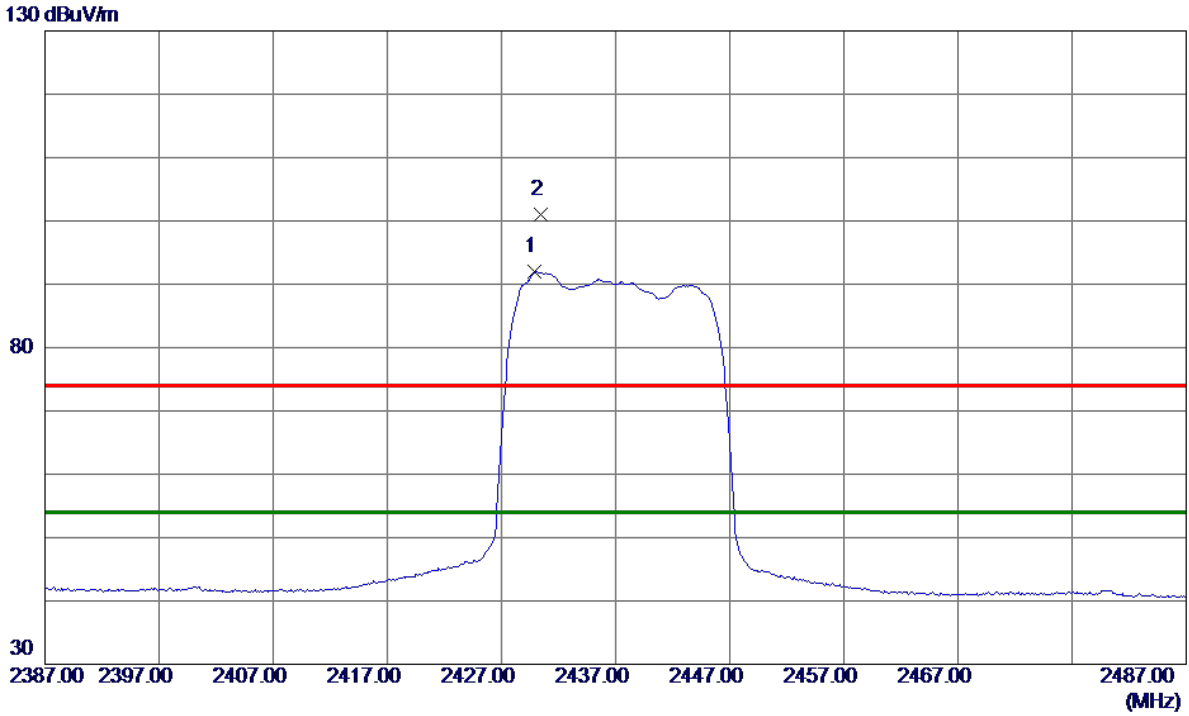

No.	Freq. MHz	Reading Level dBuV/m	Correct Factor dB	Measure ment dBuV/m	Limit dBuV/m	Margin dB	Detector	Comment
1 *	2429.9000	80.64	11.33	91.97	54.00	37.97	AVG	No Limit
2	2430.4000	89.76	11.33	101.09	74.00	27.09	Peak	No Limit

Orthogonal Axis :	X
Test Mode :	TX N-20M MODE 2437MHz

**Horizontal**

80 dBuV/m

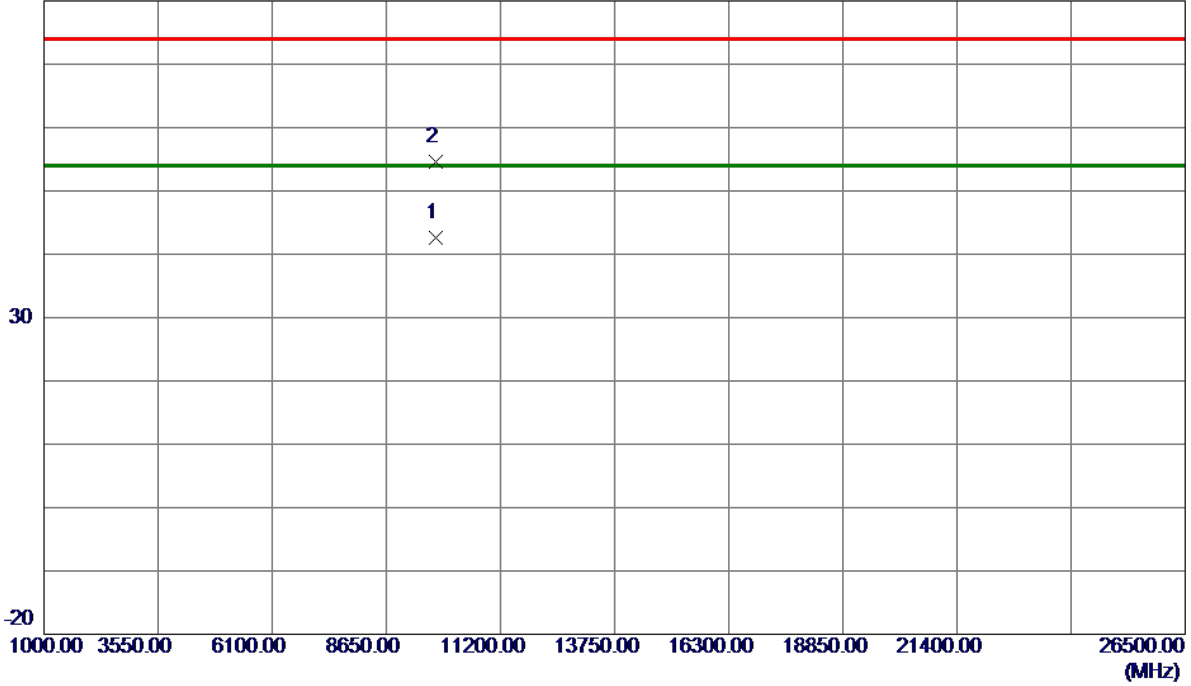

No.	Freq. MHz	Reading Level dBuV/m	Correct Factor dB	Measure ment dBuV/m	Limit dBuV/m	Margin dB	Detector	Comment
1 *	9747.8900	23.00	19.55	42.55	54.00	-11.45	AVG	
2	9748.3200	35.12	19.55	54.67	74.00	-19.33	Peak	

Orthogonal Axis :	X
Test Mode :	TX N-20M MODE 2462MHz

**Vertical**

130 dBuV/m

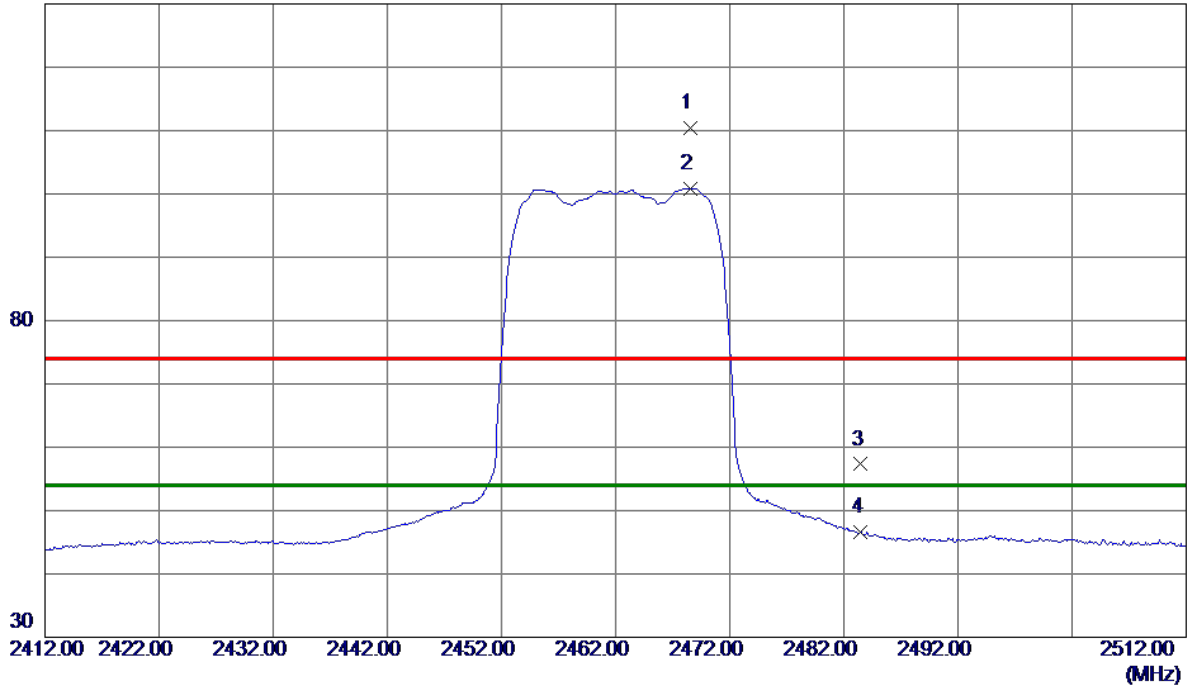

No.	Freq. MHz	Reading Level dBuV/m	Correct Factor dB	Measure ment dBuV/m	Limit dBuV/m	Margin dB	Detector	Comment
1	2468.6000	99.02	11.34	110.36	74.00	36.36	Peak	No Limit
2 *	2468.6000	89.55	11.34	100.89	54.00	46.89	AVG	No Limit
3	2483.5000	45.95	11.35	57.30	74.00	-16.70	Peak	
4	2483.5000	35.19	11.35	46.54	54.00	-7.46	AVG	

Orthogonal Axis :	X
Test Mode :	TX N-20M MODE 2462MHz

**Vertical**

80 dBuV/m

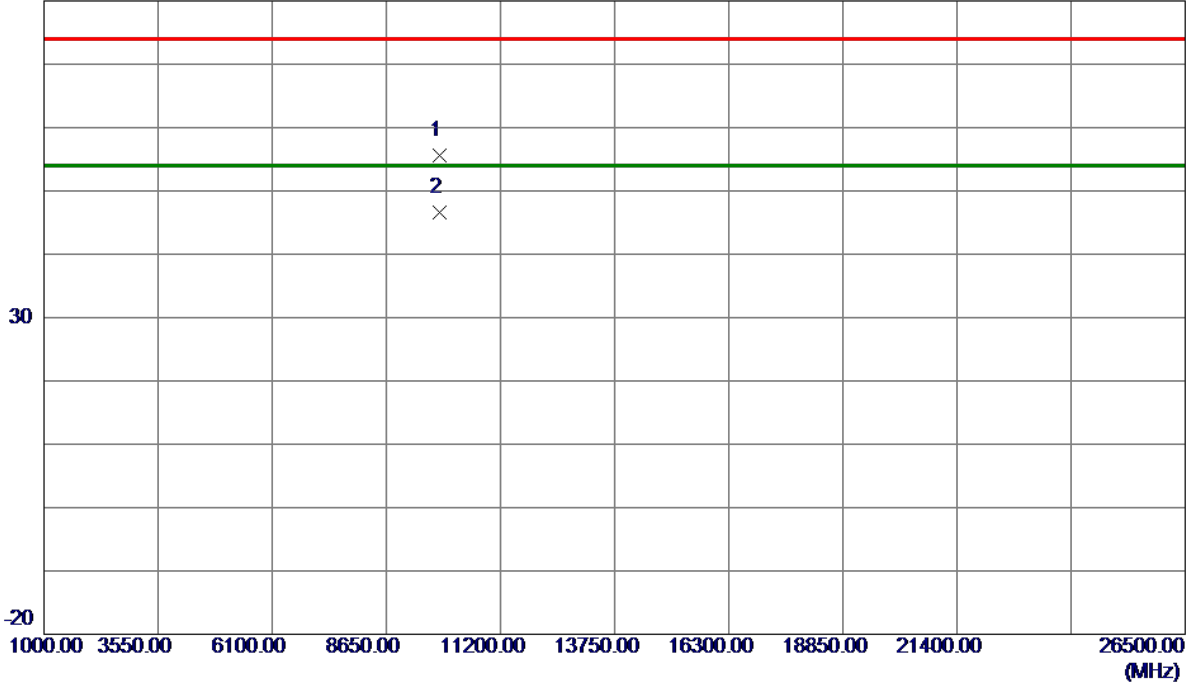

No.	Freq. MHz	Reading Level dBuV/m	Correct Factor dB	Measure ment dBuV/m	Limit dBuV/m	Margin dB	Detector	Comment
1	9847.7400	35.88	19.65	55.53	74.00	-18.47	Peak	
2 *	9848.0450	26.94	19.65	46.59	54.00	-7.41	AVG	

Orthogonal Axis :	X
Test Mode :	TX N-20M MODE 2462MHz

### Horizontal

130 dBuV/m

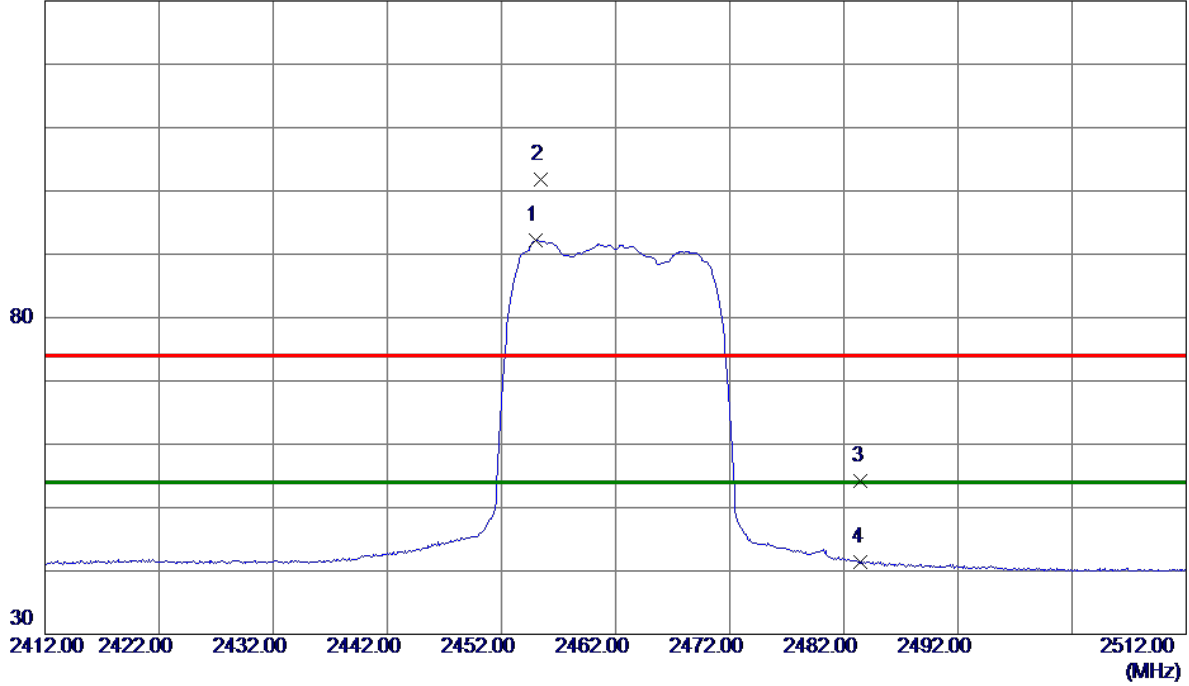

No.	Freq. MHz	Reading Level dBuV/m	Correct Factor dB	Measure ment dBuV/m	Limit dBuV/m	Margin dB	Detector	Comment
1 *	2455.0000	80.93	11.34	92.27	54.00	38.27	AVG	No Limit
2	2455.4000	90.50	11.34	101.84	74.00	27.84	Peak	No Limit
3	2483.5000	42.78	11.35	54.13	74.00	-19.87	Peak	
4	2483.5000	30.09	11.35	41.44	54.00	-12.56	AVG	



Orthogonal Axis :	X
Test Mode :	TX N-20M MODE 2462MHz

### Horizontal

80 dBuV/m

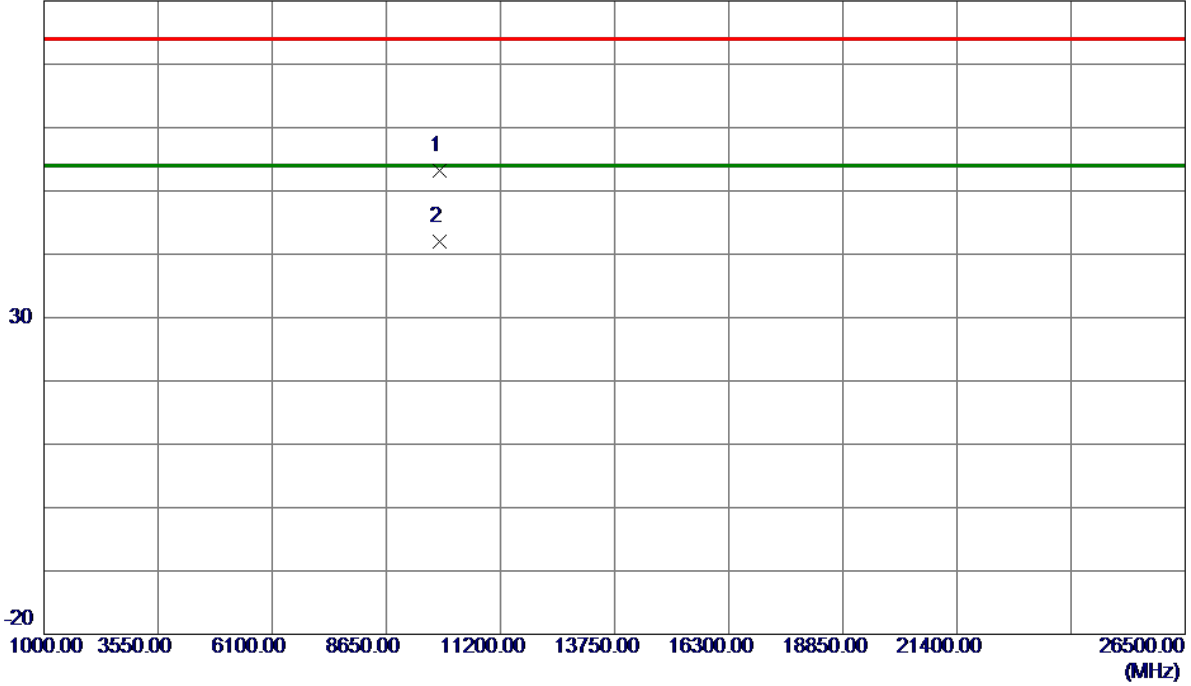

No.	Freq. MHz	Reading Level dBuV/m	Correct Factor dB	Measure ment dBuV/m	Limit dBuV/m	Margin dB	Detector	Comment
1	9845.9500	33.57	19.65	53.22	74.00	-20.78	Peak	
2 *	9847.9200	22.26	19.65	41.91	54.00	-12.09	AVG	

Orthogonal Axis :	X
Test Mode :	TX N-40M MODE 2422MHz

**Vertical**

130 dBuV/m

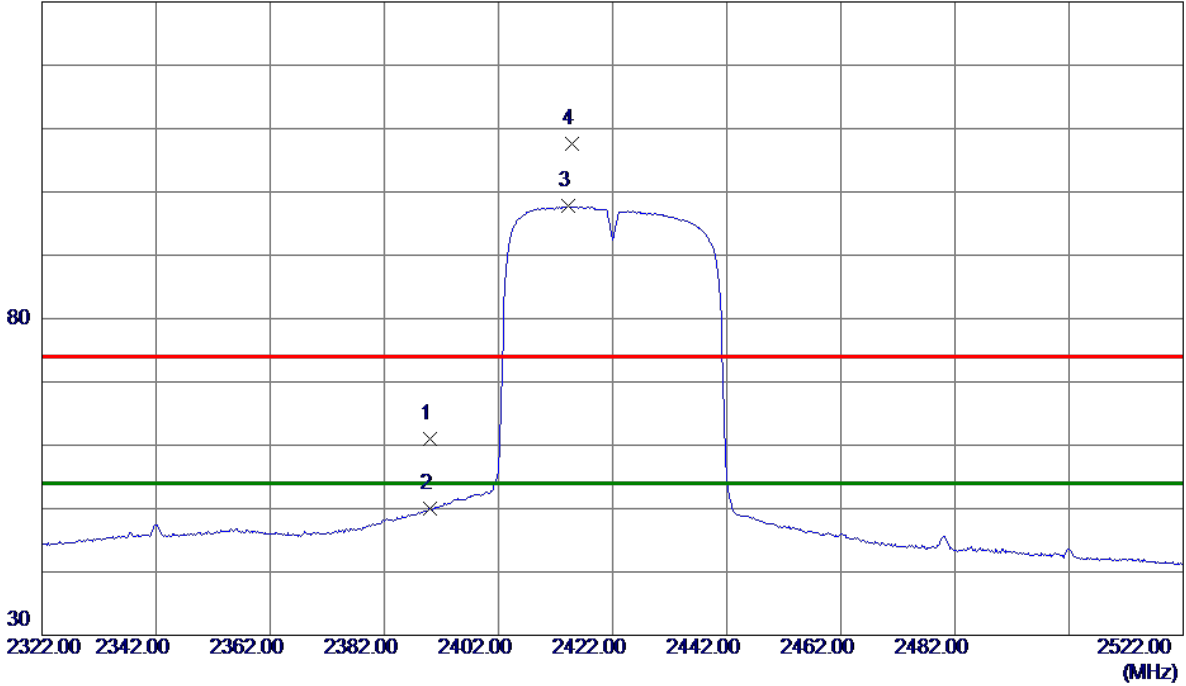

No.	Freq. MHz	Reading Level dBuV/m	Correct Factor dB	Measure ment dBuV/m	Limit dBuV/m	Margin dB	Detector	Comment
1	2390.0000	49.61	11.32	60.93	74.00	-13.07	Peak	
2	2390.0000	38.62	11.32	49.94	54.00	-4.06	AVG	
3 *	2414.2000	86.41	11.33	97.74	54.00	43.74	AVG	No Limit
4	2414.8000	96.25	11.33	107.58	74.00	33.58	Peak	No Limit

Orthogonal Axis :	X
Test Mode :	TX N-40M MODE 2422MHz

**Vertical**

80 dBuV/m

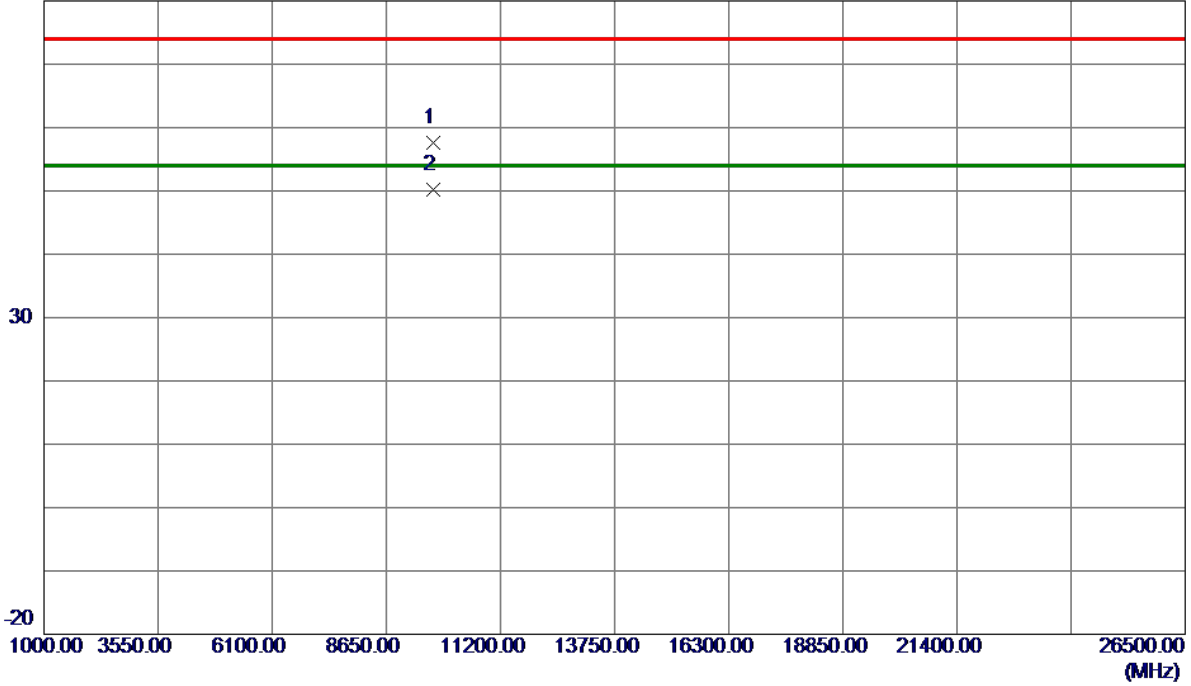

No.	Freq. MHz	Reading Level dBuV/m	Correct Factor dB	Measure ment dBuV/m	Limit dBuV/m	Margin dB	Detector	Comment
1	9687.9400	38.18	19.49	57.67	74.00	-16.33	Peak	
2 *	9688.0050	30.76	19.49	50.25	54.00	-3.75	AVG	

Orthogonal Axis :	X
Test Mode :	TX N-40M MODE 2422MHz

### Horizontal

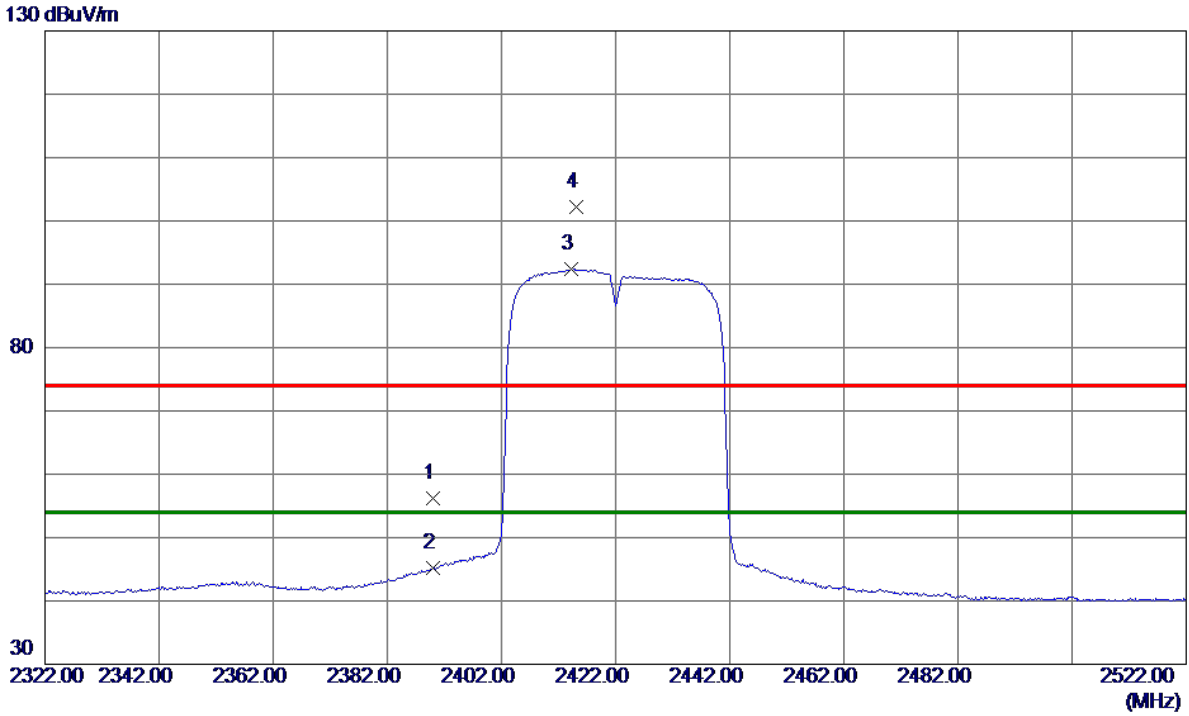

No.	Freq. MHz	Reading Level dBuV/m	Correct Factor dB	Measure ment dBuV/m	Limit dBuV/m	Margin dB	Detector	Comment
1	2390.0000	44.84	11.32	56.16	74.00	-17.84	Peak	
2	2390.0000	33.92	11.32	45.24	54.00	-8.76	AVG	
3 *	2414.2000	81.09	11.33	92.42	54.00	38.42	AVG	No Limit
4	2415.2000	90.85	11.33	102.18	74.00	28.18	Peak	No Limit

Orthogonal Axis :	X
Test Mode :	TX N-40M MODE 2422MHz

### Horizontal

80 dBuV/m

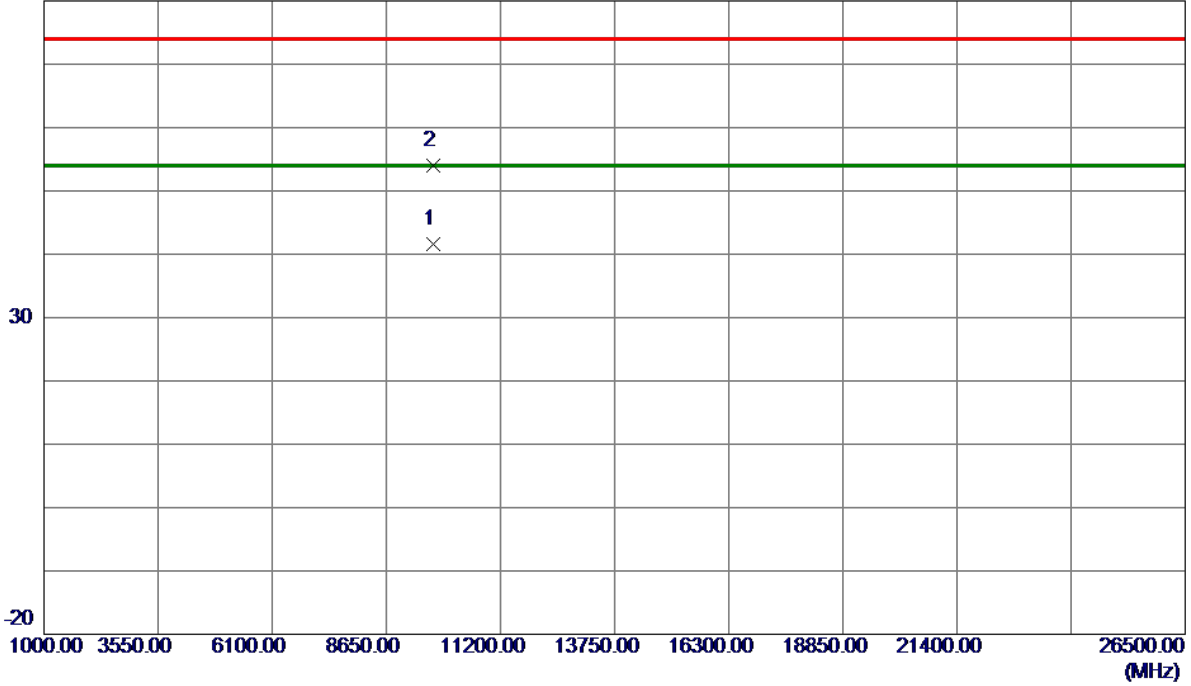

No.	Freq. MHz	Reading Level dBuV/m	Correct Factor dB	Measure ment dBuV/m	Limit dBuV/m	Margin dB	Detector	Comment
1 *	9687.5900	22.09	19.49	41.58	54.00	-12.42	AVG	
2	9689.2500	34.49	19.50	53.99	74.00	-20.01	Peak	

Orthogonal Axis :	X
Test Mode :	TX N-40M MODE 2437MHz

**Vertical**

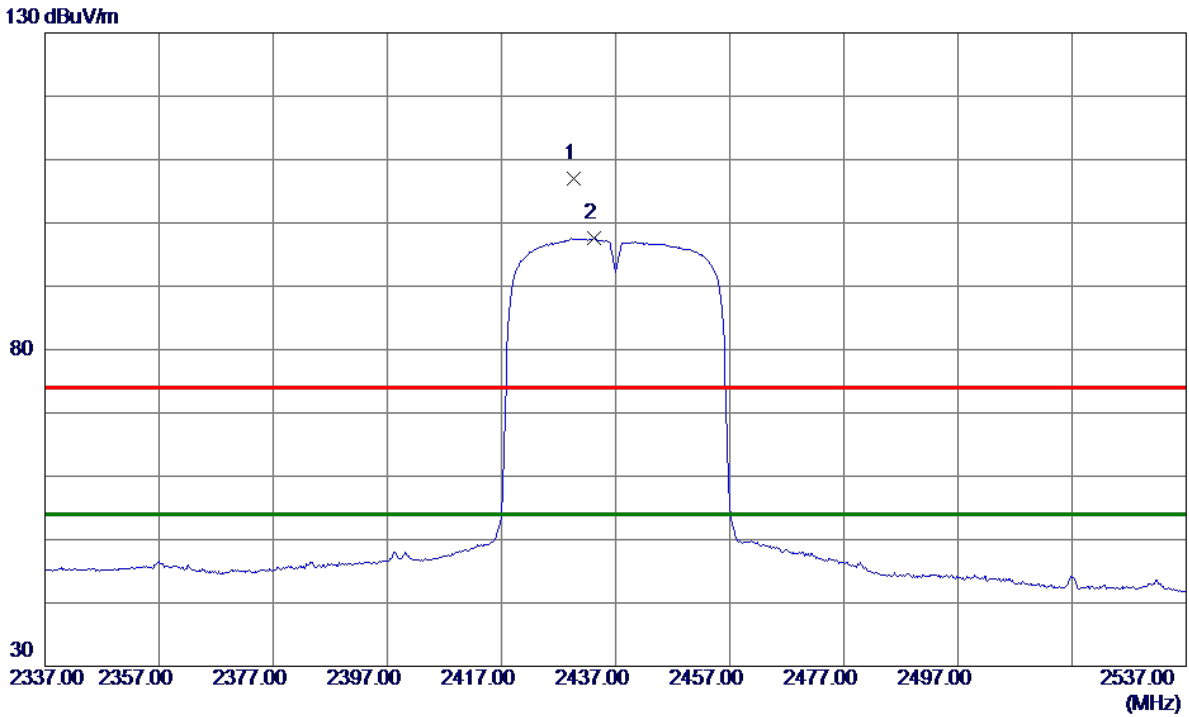

No.	Freq. MHz	Reading Level dBuV/m	Correct Factor dB	Measure ment dBuV/m	Limit dBuV/m	Margin dB	Detector	Comment
1	2429.6000	95.71	11.33	107.04	74.00	33.04	Peak	No Limit
2 *	2433.2000	86.22	11.33	97.55	54.00	43.55	AVG	No Limit

Orthogonal Axis :	X
Test Mode :	TX N-40M MODE 2437MHz

**Vertical**

80 dBuV/m

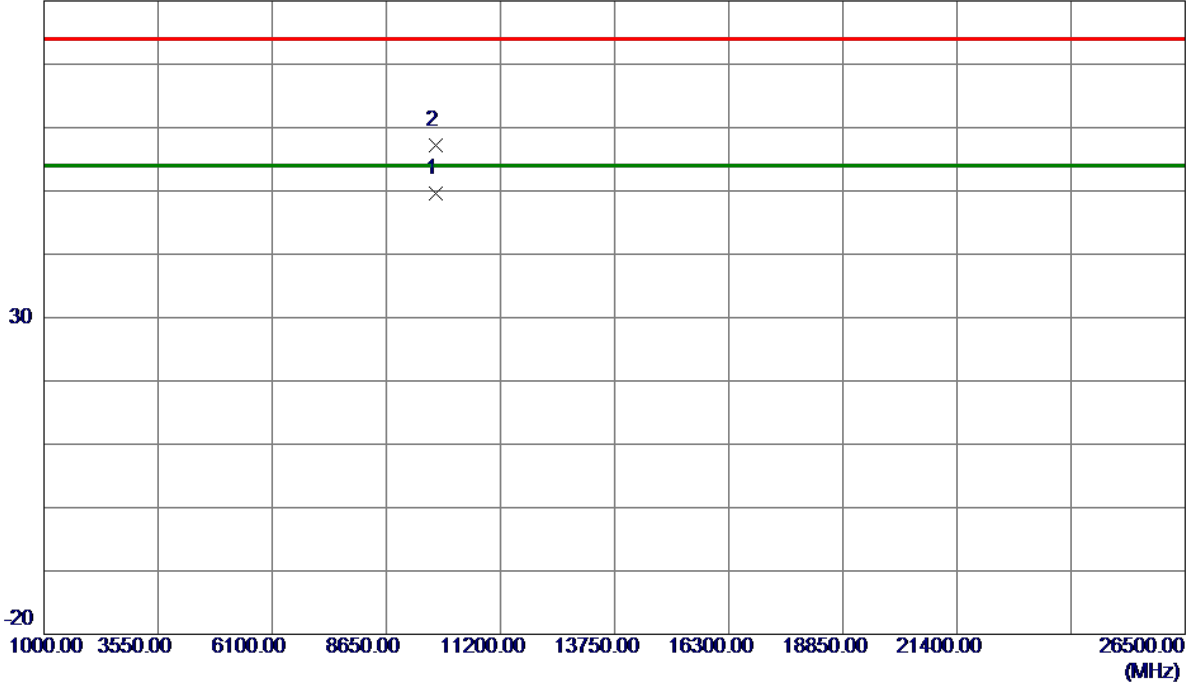

No.	Freq. MHz	Reading Level dBuV/m	Correct Factor dB	Measure ment dBuV/m	Limit dBuV/m	Margin dB	Detector	Comment
1 *	9747.9550	30.09	19.55	49.64	54.00	-4.36	AVG	
2	9748.1600	37.72	19.55	57.27	74.00	-16.73	Peak	

Orthogonal Axis :	X
Test Mode :	TX N-40M MODE 2437MHz

### Horizontal

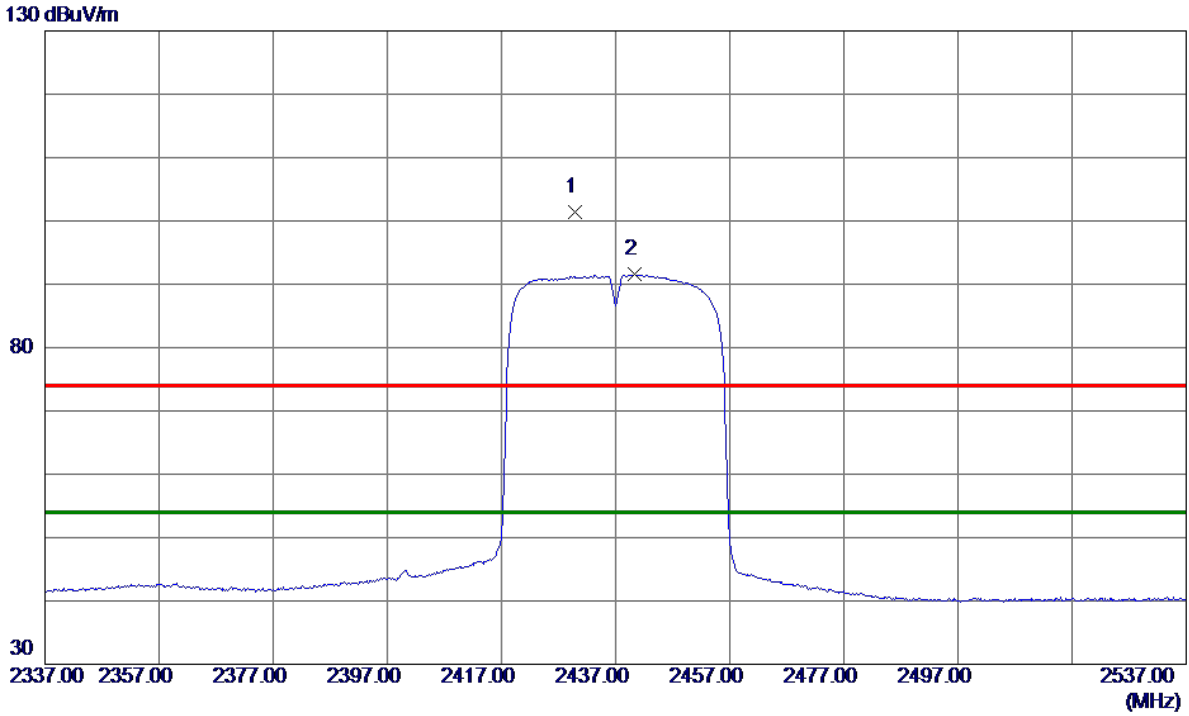

No.	Freq. MHz	Reading Level dBuV/m	Correct Factor dB	Measure ment dBuV/m	Limit dBuV/m	Margin dB	Detector	Comment
1	2429.8000	90.09	11.33	101.42	74.00	27.42	Peak	No Limit
2 *	2440.4000	80.20	11.33	91.53	54.00	37.53	AVG	No Limit



Orthogonal Axis :	X
Test Mode :	TX N-40M MODE 2437MHz

### Horizontal

80 dBuV/m

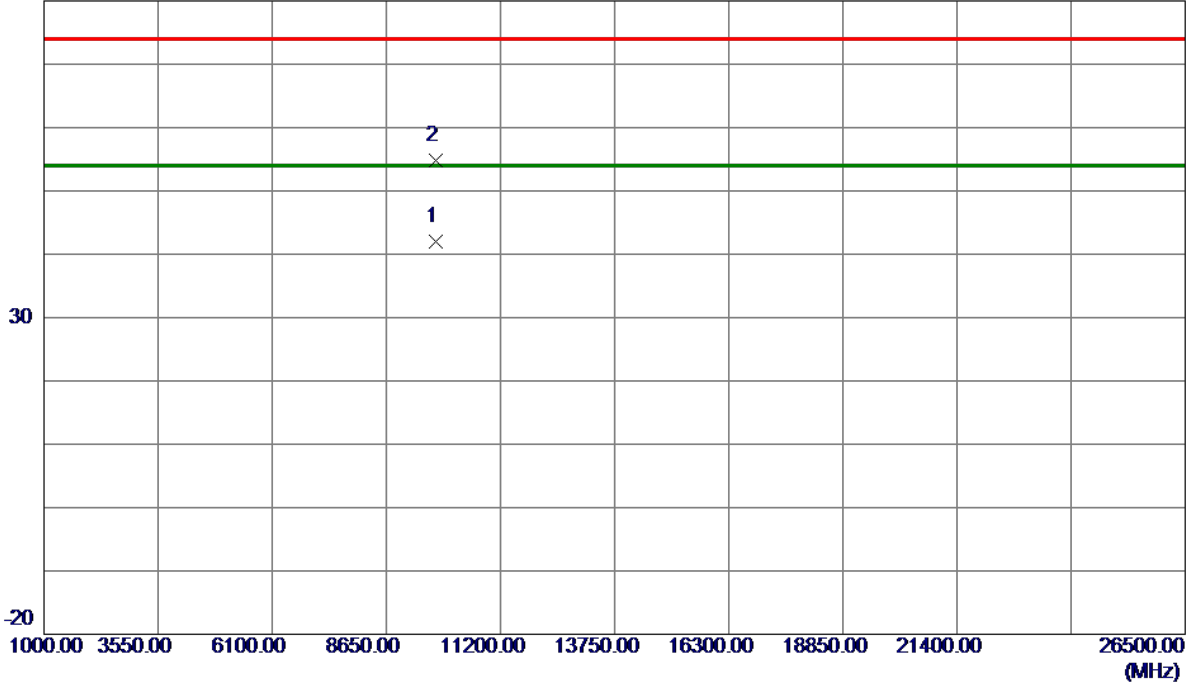

No.	Freq. MHz	Reading Level dBuV/m	Correct Factor dB	Measure ment dBuV/m	Limit dBuV/m	Margin dB	Detector	Comment
1 *	9746.6800	22.51	19.55	42.06	54.00	-11.94	AVG	
2	9750.1500	35.24	19.56	54.80	74.00	-19.20	Peak	

Orthogonal Axis :	X
Test Mode :	TX N-40M MODE 2452MHz

**Vertical**

130 dBuV/m

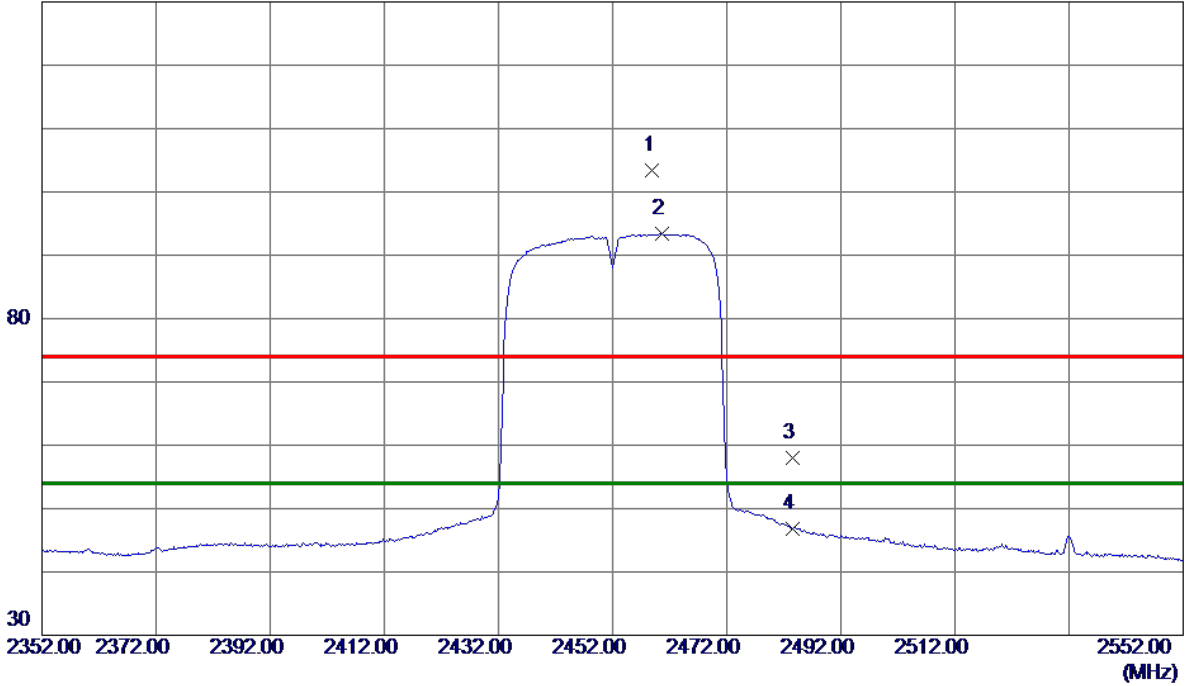

No.	Freq. MHz	Reading Level dBuV/m	Correct Factor dB	Measure ment dBuV/m	Limit dBuV/m	Margin dB	Detector	Comment
1	2459.0000	92.01	11.34	103.35	74.00	29.35	Peak	No Limit
2 *	2460.6000	82.03	11.34	93.37	54.00	39.37	AVG	No Limit
3	2483.5000	46.65	11.35	58.00	74.00	-16.00	Peak	
4	2483.5000	35.52	11.35	46.87	54.00	-7.13	AVG	

Orthogonal Axis :	X
Test Mode :	TX N-40M MODE 2452MHz

**Vertical**

80 dBuV/m

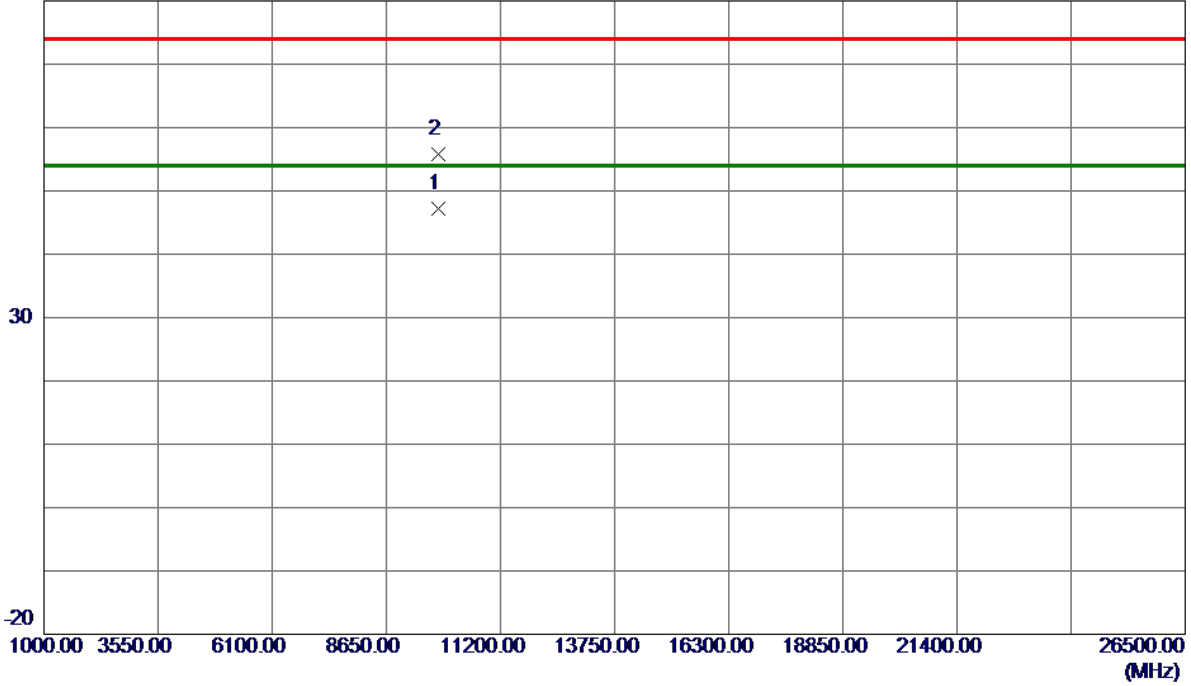

No.	Freq. MHz	Reading Level dBuV/m	Correct Factor dB	Measure ment dBuV/m	Limit dBuV/m	Margin dB	Detector	Comment
1 *	9807.9600	27.66	19.61	47.27	54.00	-6.73	AVG	
2	9808.3300	36.21	19.61	55.82	74.00	-18.18	Peak	

Orthogonal Axis :	X
Test Mode :	TX N-40M MODE 2452MHz

**Horizontal**

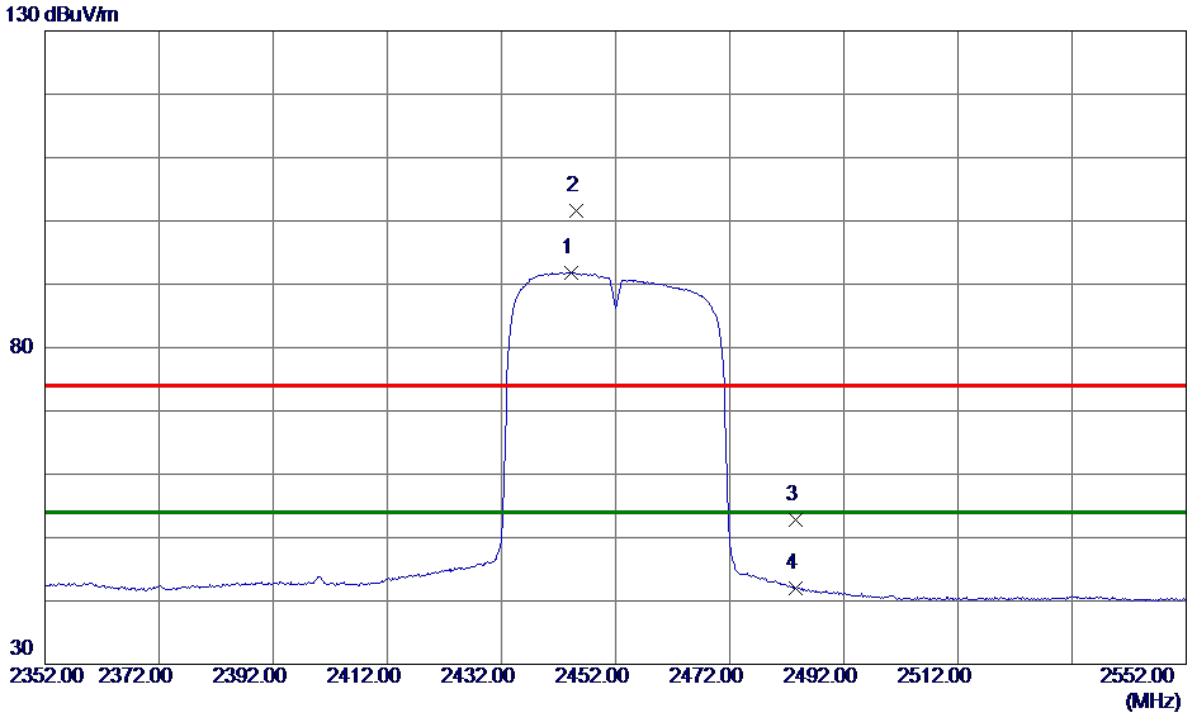

No.	Freq. MHz	Reading Level dBuV/m	Correct Factor dB	Measure ment dBuV/m	Limit dBuV/m	Margin dB	Detector	Comment
1 *	2444.2000	80.55	11.33	91.88	54.00	37.88	AVG	No Limit
2	2445.2000	90.32	11.33	101.65	74.00	27.65	Peak	No Limit
3	2483.5000	41.45	11.35	52.80	74.00	-21.20	Peak	
4	2483.5000	30.63	11.35	41.98	54.00	-12.02	AVG	

Orthogonal Axis :	X
Test Mode :	TX N-40M MODE 2452MHz

**Horizontal**

80 dBuV/m

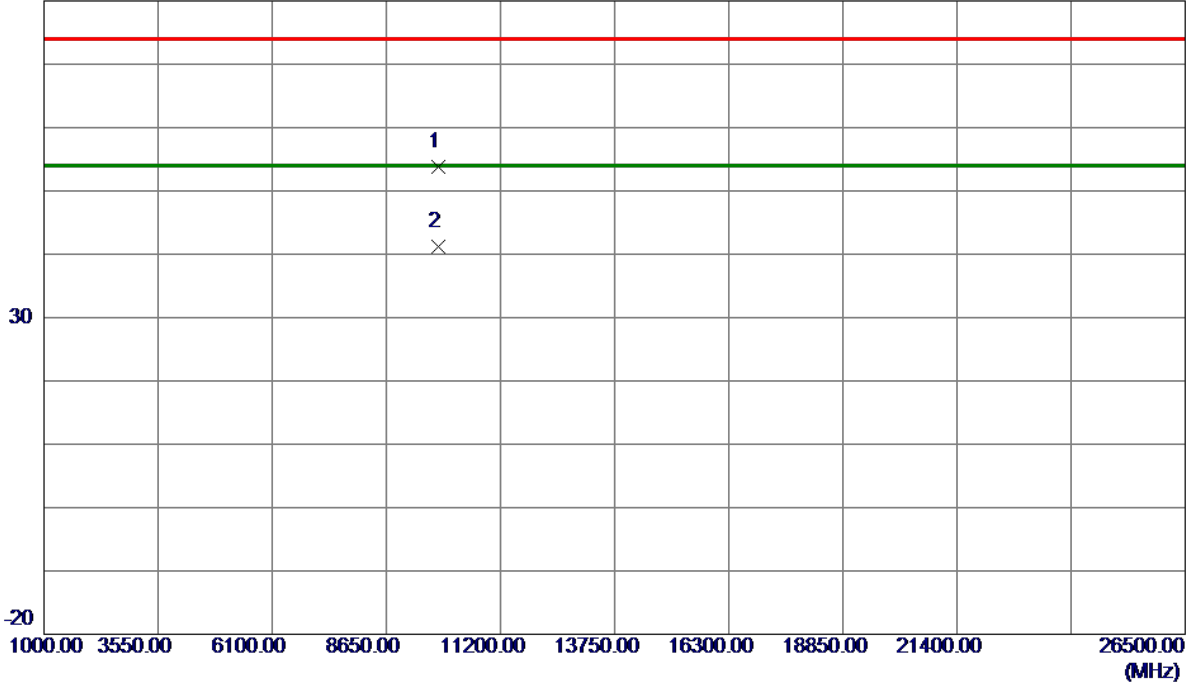

No.	Freq. MHz	Reading Level dBuV/m	Correct Factor dB	Measure ment dBuV/m	Limit dBuV/m	Margin dB	Detector	Comment
1	9807.6150	34.24	19.61	53.85	74.00	-20.15	Peak	
2 *	9808.0450	21.64	19.61	41.25	54.00	-12.75	AVG	

## APPENDIX E - BANDWIDTH

### Non-Beamforming

**Test Mode : TX B Mode\_CH01/06/11**

Frequency (MHz)	6dB Bandwidth (MHz)	99% Occupied BW (MHz)	Min. Limit (kHz)	Test Result
2412	10.10	14.56	500	Complies
2437	10.14	15.44	500	Complies
2462	10.11	14.80	500	Complies

#### TX CH01

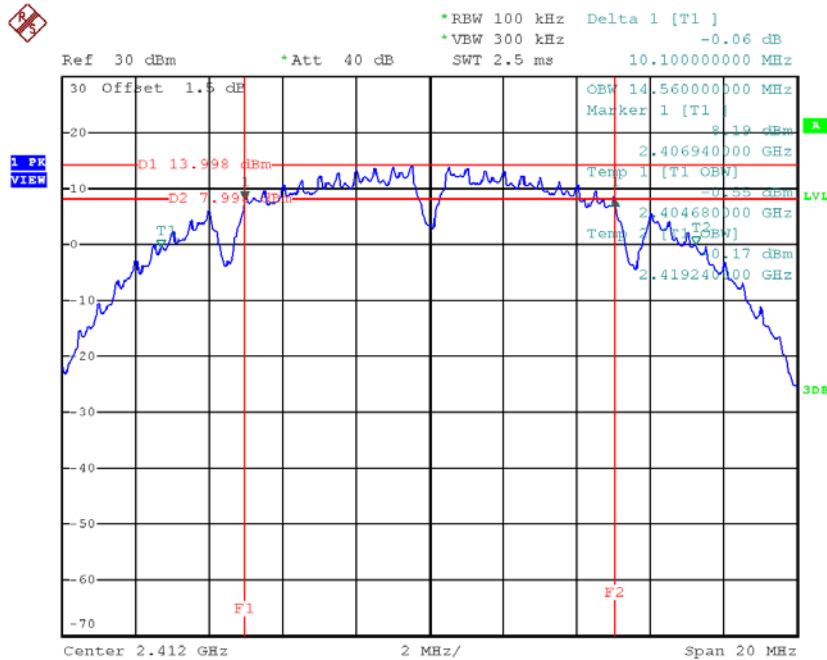

Date: 5.JUL.2018 10:49:16

### TX CH06

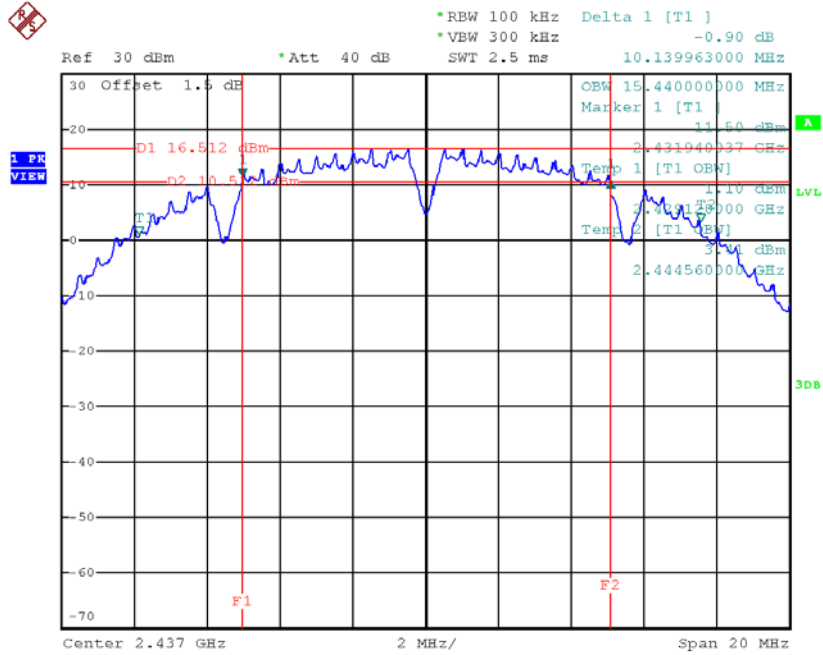

Date: 5.JUL.2018 10:51:10

### TX CH11

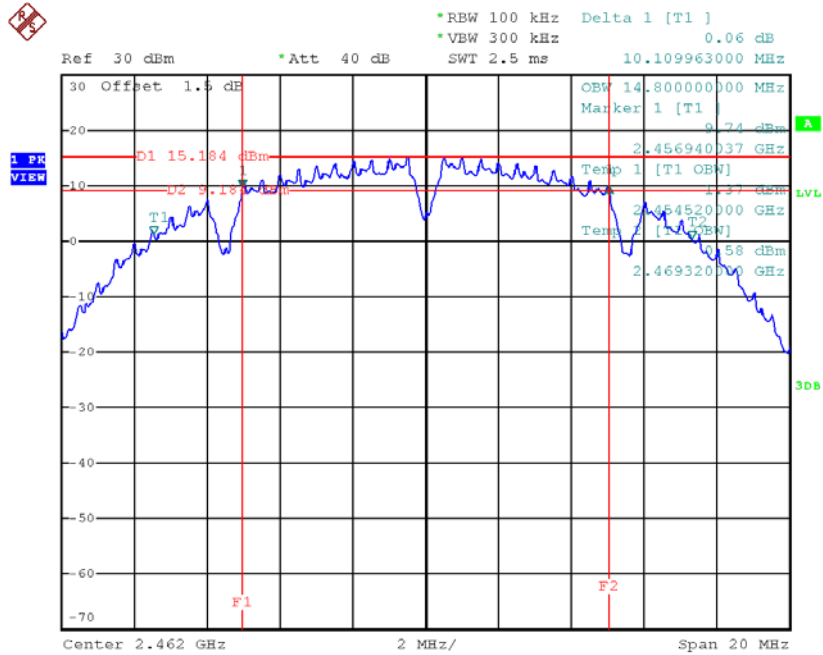

Date: 5.JUL.2018 10:52:46



**Test Mode: TX G Mode\_CH01/06/11**

Frequency (MHz)	6dB Bandwidth (MHz)	99% Occupied BW (MHz)	Min. Limit (kHz)	Test Result
2412	16.50	16.40	500	Complies
2437	16.50	16.40	500	Complies
2462	16.50	16.40	500	Complies

**TX CH01**

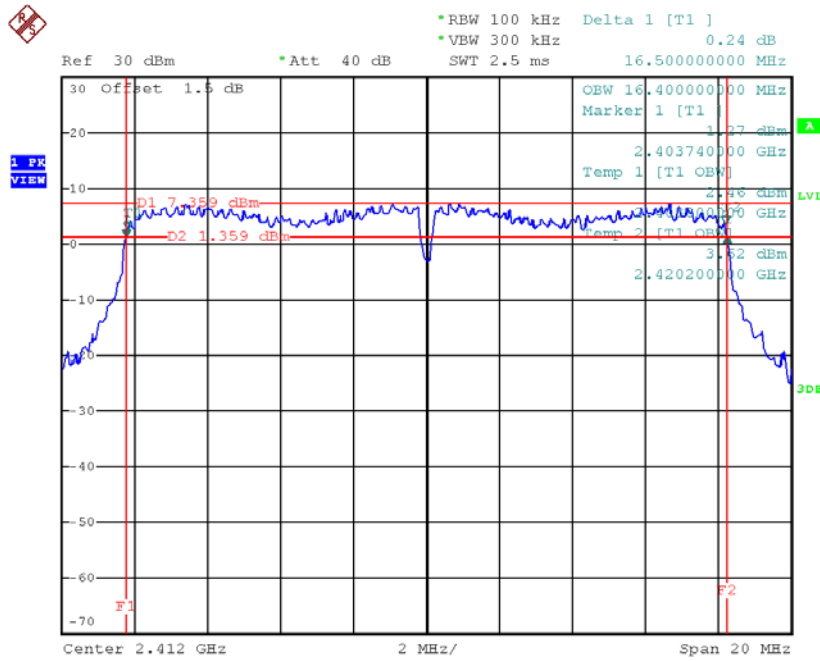

Date: 5.JUL.2018 10:54:48

**TX CH06**

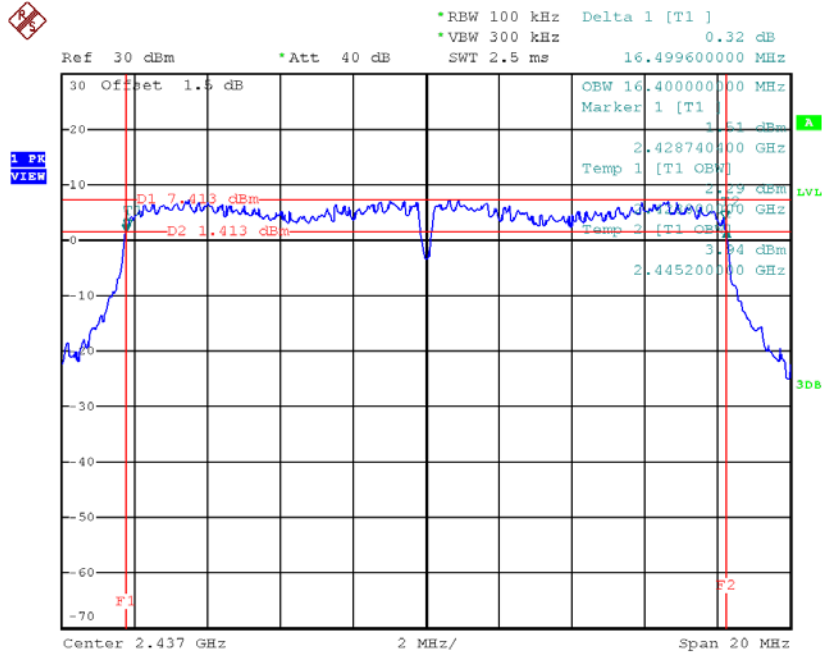

Date: 5.JUL.2018 10:56:35

**TX CH11**

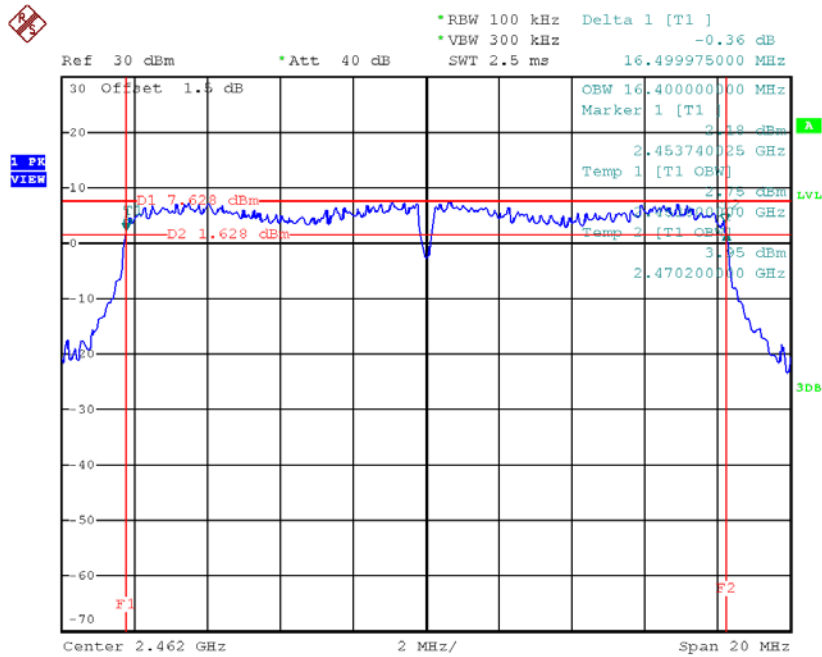

Date: 5.JUL.2018 10:57:57

**Test Mode : TX N-20MHz Mode\_CH01/06/11**

Frequency (MHz)	6dB Bandwidth (MHz)	99% Occupied BW (MHz)	Min. Limit (kHz)	Test Result
2412	17.20	17.40	500	Complies
2437	17.44	17.44	500	Complies
2462	17.39	17.44	500	Complies

**TX CH01**

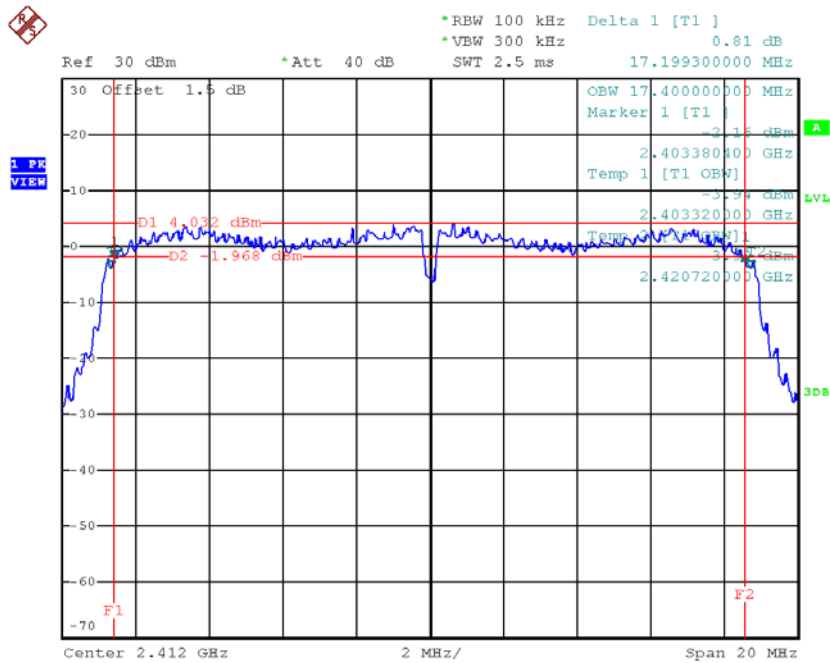

Date: 5.JUL.2018 10:59:32

**TX CH06**

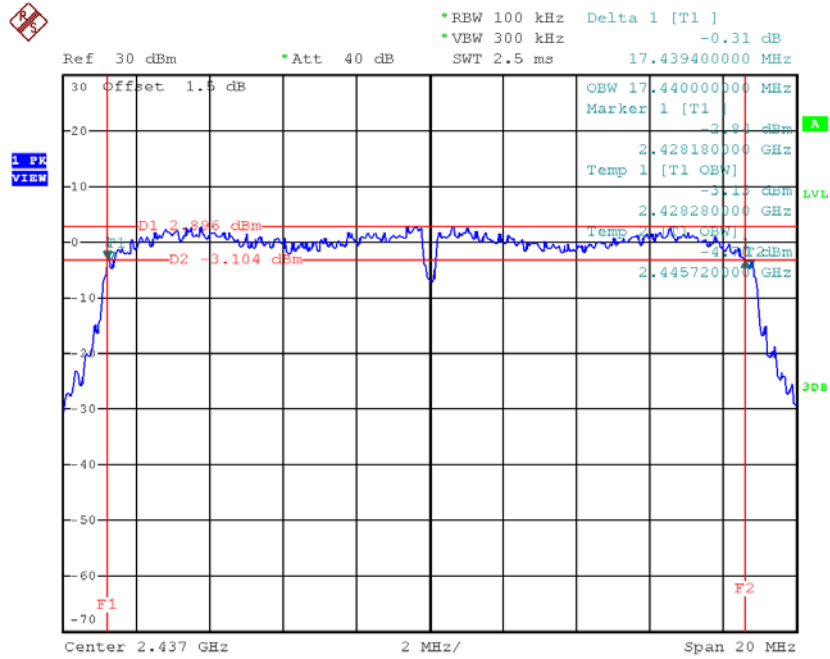

Date: 5.JUL.2018 11:01:18

**TX CH11**

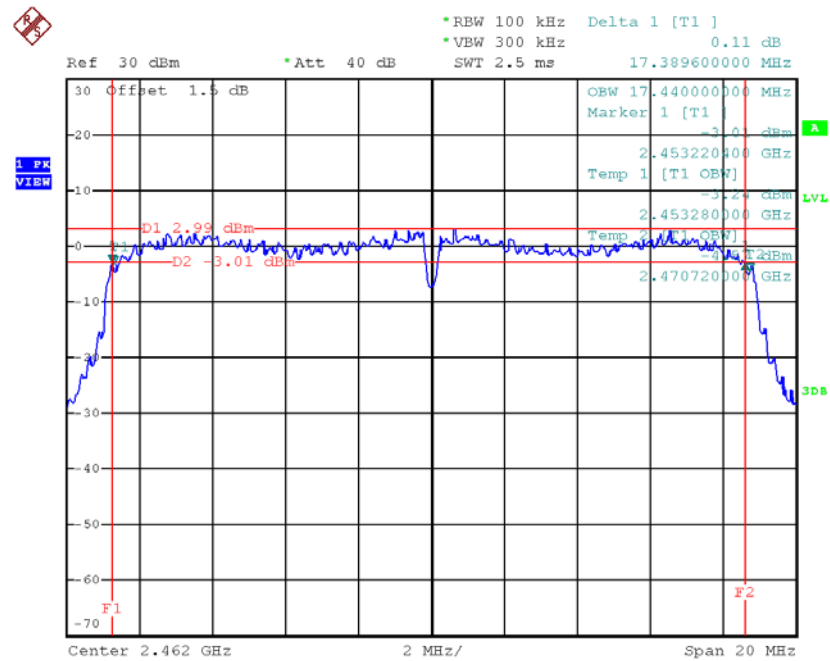

Date: 5.JUL.2018 11:04:03

**Test Mode : TX N-40MHz Mode\_CH03/06/09**

Frequency (MHz)	6dB Bandwidth (MHz)	99% Occupied BW (MHz)	Min. Limit (kHz)	Test Result
2422	35.56	35.60	500	Complies
2437	35.51	35.60	500	Complies
2452	35.28	35.60	500	Complies

**TX CH03**

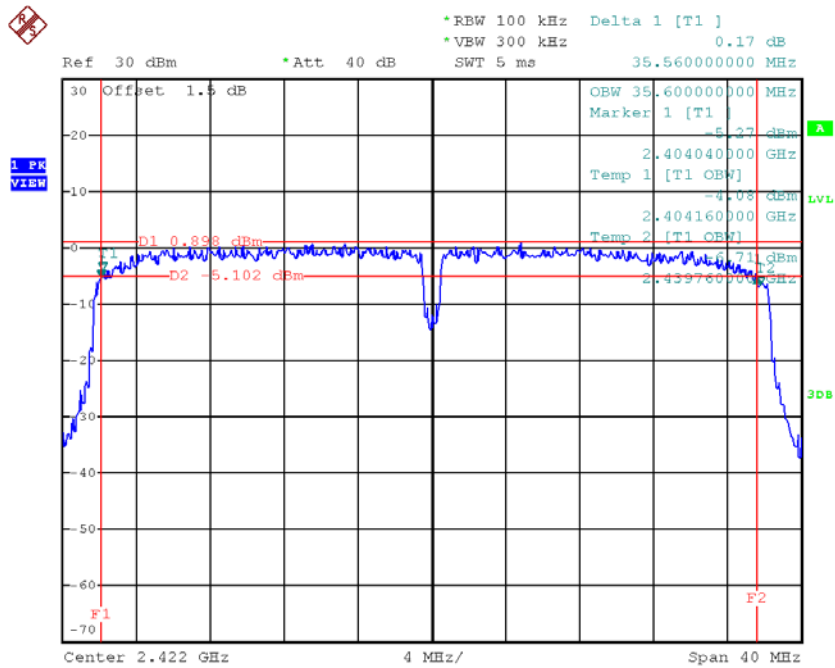

Date: 5.JUL.2018 11:05:45

### TX CH06

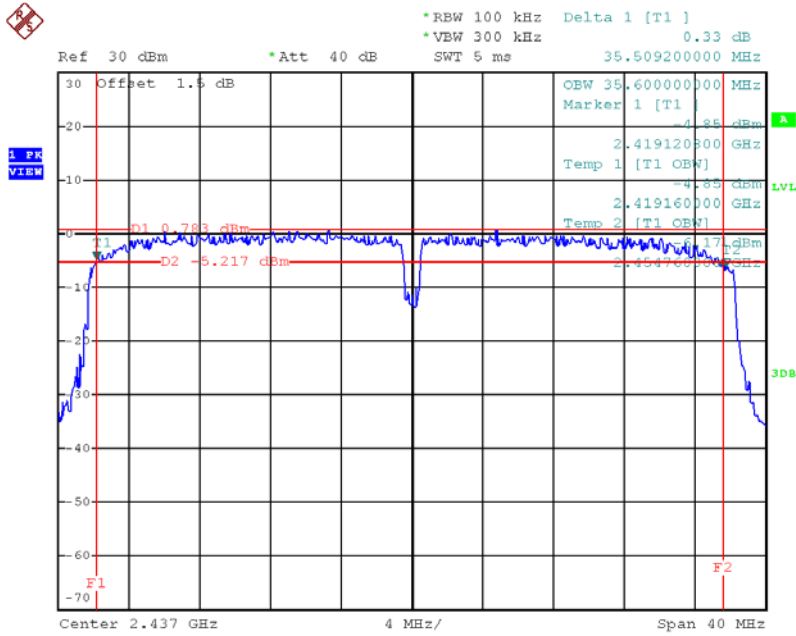

Date: 5.JUL.2018 11:07:19

### TX CH09

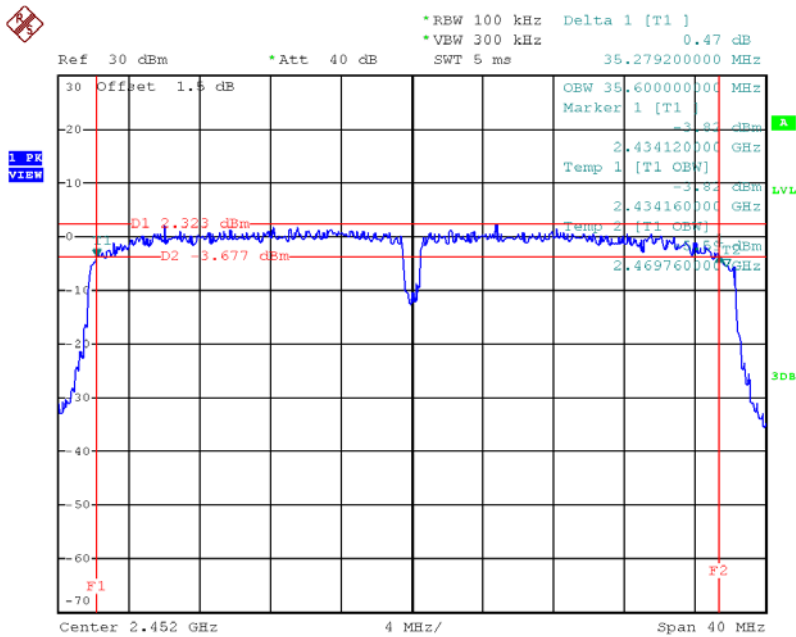

Date: 5.JUL.2018 11:09:32

### Beamforming

**Test Mode : TX N-20MHz Mode\_CH01/06/11**

Frequency (MHz)	6dB Bandwidth (MHz)	99% Occupied BW (MHz)	Min. Limit (kHz)	Test Result
2412	17.36	17.44	500	Complies
2437	17.40	17.44	500	Complies
2462	17.41	17.44	500	Complies

### TX CH01

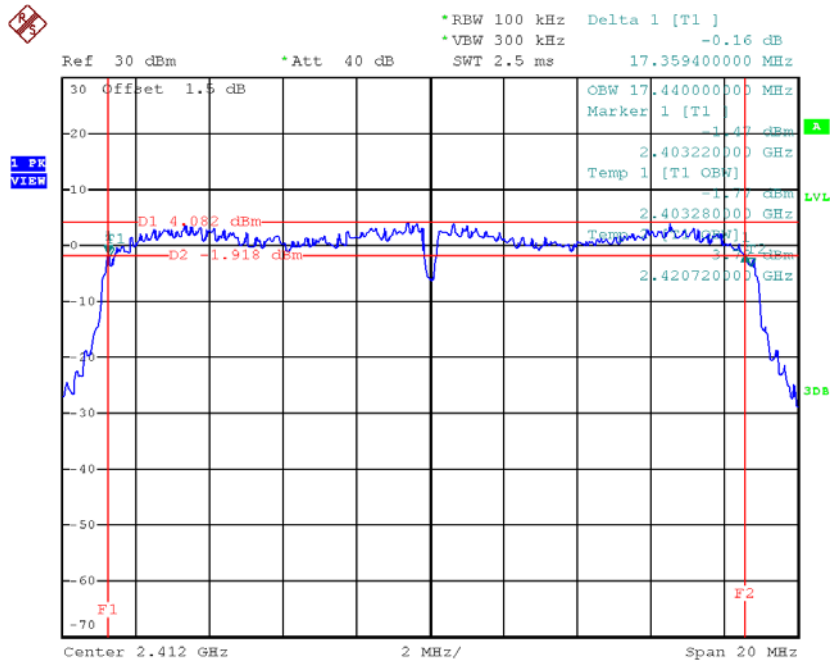

Date: 5.JUL.2018 11:35:37

**TX CH06**

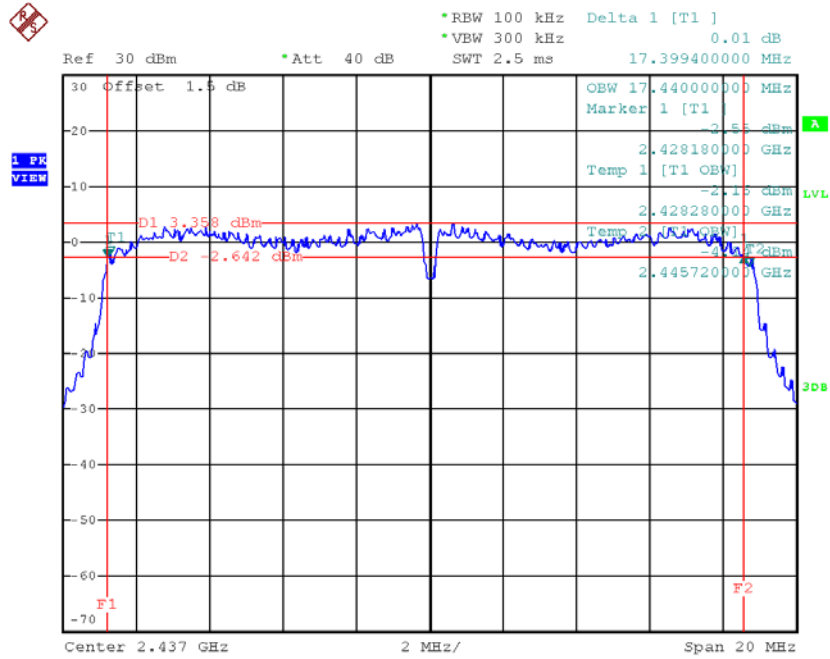

Date: 5.JUL.2018 11:37:36

**TX CH11**

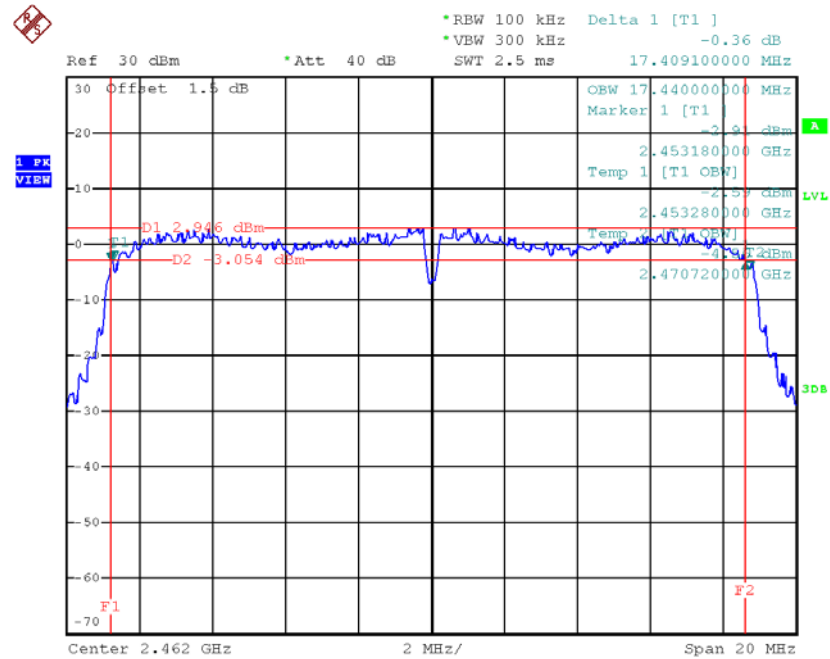

Date: 5.JUL.2018 11:39:08



**Test Mode : TX N-40MHz Mode\_CH03/06/09**

Frequency (MHz)	6dB Bandwidth (MHz)	99% Occupied BW (MHz)	Min. Limit (kHz)	Test Result
2422	35.48	35.60	500	Complies
2437	35.52	35.60	500	Complies
2452	35.43	35.60	500	Complies

**TX CH03**

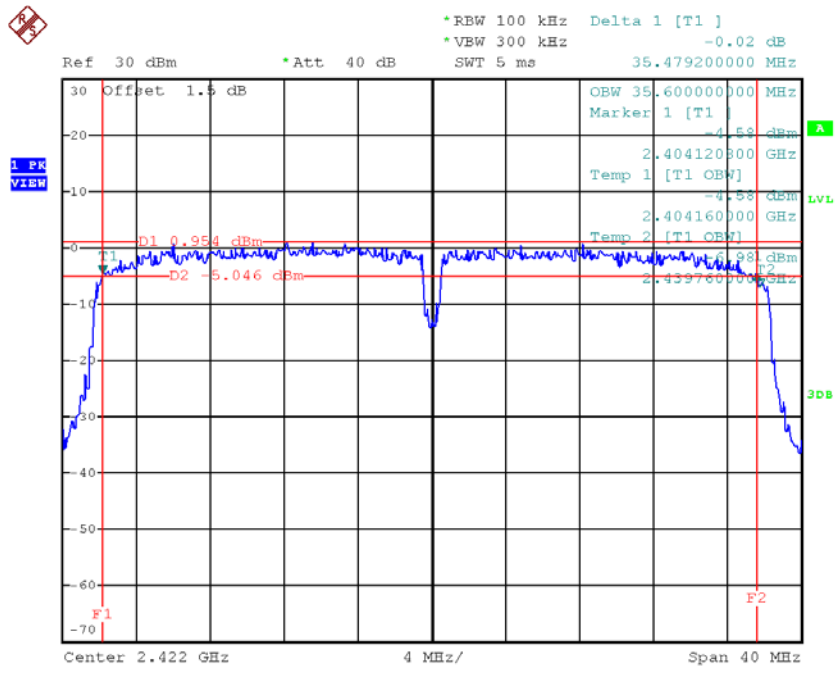

Date: 5.JUL.2018 11:40:37

**TX CH06**

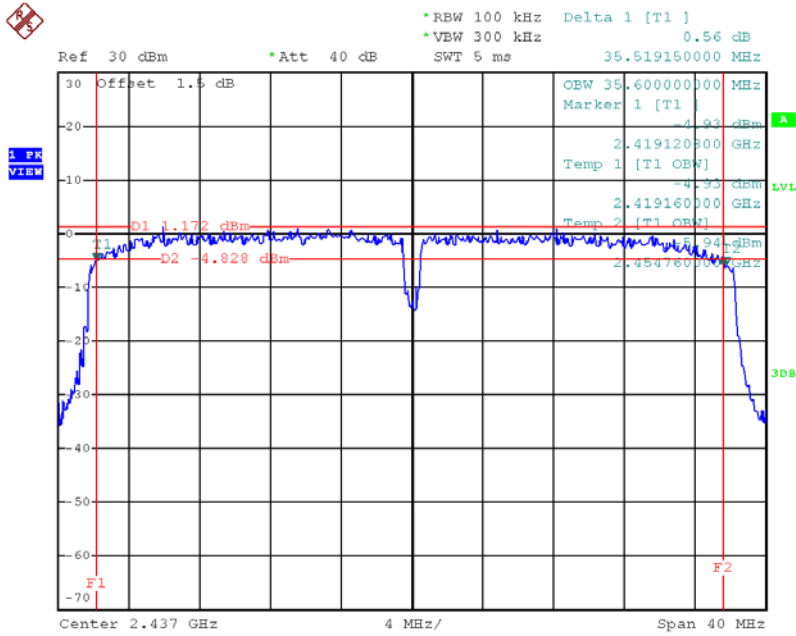

Date: 5.JUL.2018 11:42:05

**TX CH09**

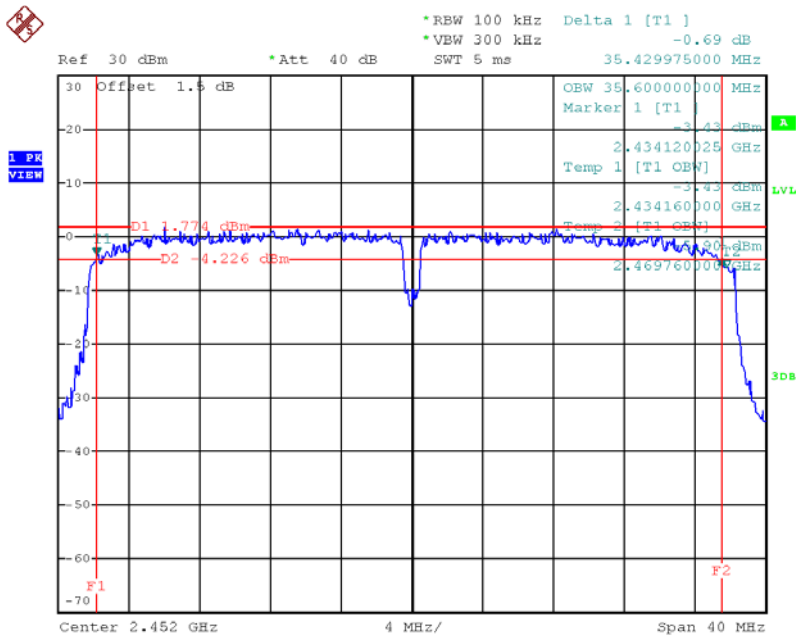

Date: 5.JUL.2018 11:43:25

# APPENDIX F - MAXIMUM PEAK CONDUCTED OUTPUT POWER

### Non-Beamforming

Test Mode :TX B Mode_CH01/06/11					
Frequency (MHz)	Conducted Power (dBm)	Conducted Power (W)	Max. Limit (dBm)	Max. Limit (W)	Result
2412	27.58	0.57	30.00	1.00	Complies
2437	29.56	0.90	30.00	1.00	Complies
2462	28.37	0.69	30.00	1.00	Complies

Test Mode :TX G Mode_CH01/06/11					
Frequency (MHz)	Conducted Power (dBm)	Conducted Power (W)	Max. Limit (dBm)	Max. Limit (W)	Result
2412	29.66	0.92	30.00	1.00	Complies
2437	29.78	0.95	30.00	1.00	Complies
2462	29.85	0.97	30.00	1.00	Complies

Test Mode :TX N20 Mode_CH01/06/11_ANT 1					
Frequency (MHz)	Conducted Power (dBm)	Conducted Power (W)	Max. Limit (dBm)	Max. Limit (W)	Result
2412	26.38	0.43	29.99	1.00	Complies
2437	26.87	0.49	29.99	1.00	Complies
2462	26.45	0.44	29.99	1.00	Complies

Test Mode :TX N20 Mode_CH01/06/11_ANT 2					
Frequency (MHz)	Conducted Power (dBm)	Conducted Power (W)	Max. Limit (dBm)	Max. Limit (W)	Result
2412	24.37	0.27	29.99	1.00	Complies
2437	26.23	0.42	29.99	1.00	Complies
2462	26.06	0.40	29.99	1.00	Complies

Test Mode :TX N20 Mode_CH01/06/11_Total					
Frequency (MHz)	Conducted Power (dBm)	Conducted Power (W)	Max. Limit (dBm)	Max. Limit (W)	Result
2412	28.50	0.71	29.99	1.00	Complies
2437	29.57	0.91	29.99	1.00	Complies
2462	29.27	0.85	29.99	1.00	Complies

Test Mode :TX N40 Mode_CH03/06/09_ANT 1					
Frequency (MHz)	Conducted Power (dBm)	Conducted Power (W)	Max. Limit (dBm)	Max. Limit (W)	Result
2422	26.52	0.45	29.99	1.00	Complies
2437	26.47	0.44	29.99	1.00	Complies
2452	26.86	0.49	29.99	1.00	Complies

Test Mode :TX N40 Mode_CH03/06/09_ANT 2					
Frequency (MHz)	Conducted Power (dBm)	Conducted Power (W)	Max. Limit (dBm)	Max. Limit (W)	Result
2422	26.99	0.50	29.99	1.00	Complies
2437	26.69	0.47	29.99	1.00	Complies
2452	26.47	0.44	29.99	1.00	Complies

Test Mode :TX N40 Mode_CH03/06/09_Total					
Frequency (MHz)	Conducted Power (dBm)	Conducted Power (W)	Max. Limit (dBm)	Max. Limit (W)	Result
2422	29.77	0.95	29.99	1.00	Complies
2437	29.59	0.91	29.99	1.00	Complies
2452	29.68	0.93	29.99	1.00	Complies

### Beamforming

Test Mode :TX N20 Mode_CH01/06/11_ANT 1					
Frequency (MHz)	Conducted Power (dBm)	Conducted Power (W)	Max. Limit (dBm)	Max. Limit (W)	Result
2412	23.44	0.22	26.99	0.50	Complies
2437	23.75	0.24	26.99	0.50	Complies
2462	23.57	0.23	26.99	0.50	Complies

Test Mode :TX N20 Mode_CH01/06/11_ANT 2					
Frequency (MHz)	Conducted Power (dBm)	Conducted Power (W)	Max. Limit (dBm)	Max. Limit (W)	Result
2412	23.63	0.23	26.99	0.50	Complies
2437	22.45	0.18	26.99	0.50	Complies
2462	22.52	0.18	26.99	0.50	Complies

Test Mode :TX N20 Mode_CH01/06/11_Total					
Frequency (MHz)	Conducted Power (dBm)	Conducted Power (W)	Max. Limit (dBm)	Max. Limit (W)	Result
2412	26.55	0.45	26.99	0.50	Complies
2437	26.16	0.41	26.99	0.50	Complies
2462	26.09	0.41	26.99	0.50	Complies

Test Mode :TX N40 Mode_CH03/06/09_ANT 1					
Frequency (MHz)	Conducted Power (dBm)	Conducted Power (W)	Max. Limit (dBm)	Max. Limit (W)	Result
2422	23.46	0.22	26.99	0.50	Complies
2437	23.89	0.24	26.99	0.50	Complies
2452	23.78	0.24	26.99	0.50	Complies

Test Mode :TX N40 Mode_CH03/06/09_ANT 2					
Frequency (MHz)	Conducted Power (dBm)	Conducted Power (W)	Max. Limit (dBm)	Max. Limit (W)	Result
2422	23.53	0.23	26.99	0.50	Complies
2437	23.42	0.22	26.99	0.50	Complies
2452	23.84	0.24	26.99	0.50	Complies

Test Mode :TX N40 Mode_CH03/06/09_Total					
Frequency (MHz)	Conducted Power (dBm)	Conducted Power (W)	Max. Limit (dBm)	Max. Limit (W)	Result
2422	26.51	0.45	26.99	0.50	Complies
2437	26.67	0.46	26.99	0.50	Complies
2452	26.82	0.48	26.99	0.50	Complies



# APPENDIX G - ANTENNA CONDUCTED SPURIOUS EMISSION

**Non-Beamforming**

**Test Mode : TX B Mode**

**TX B mode CH01**

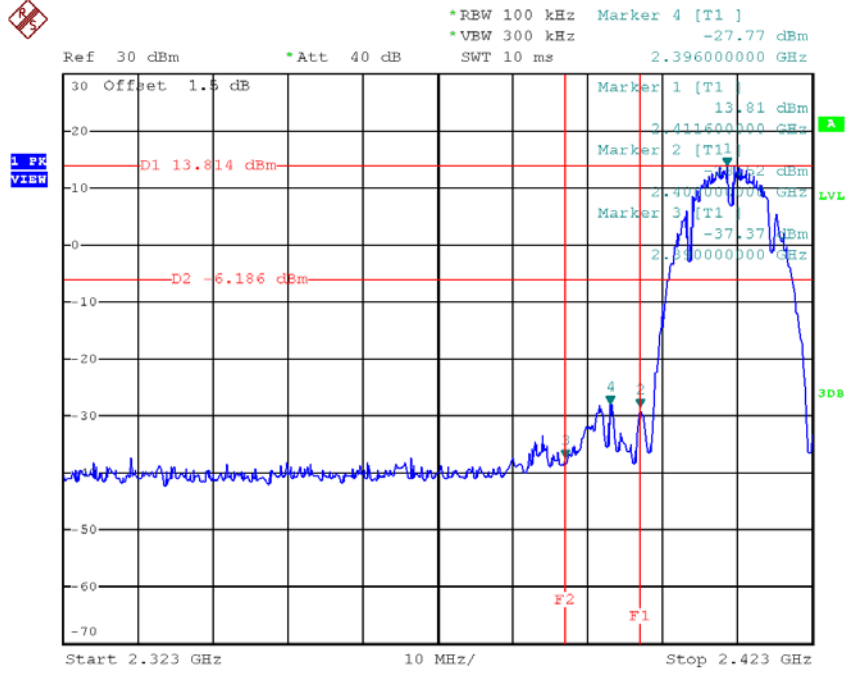

Date: 5.JUL.2018 10:49:24

### TX B mode CH11

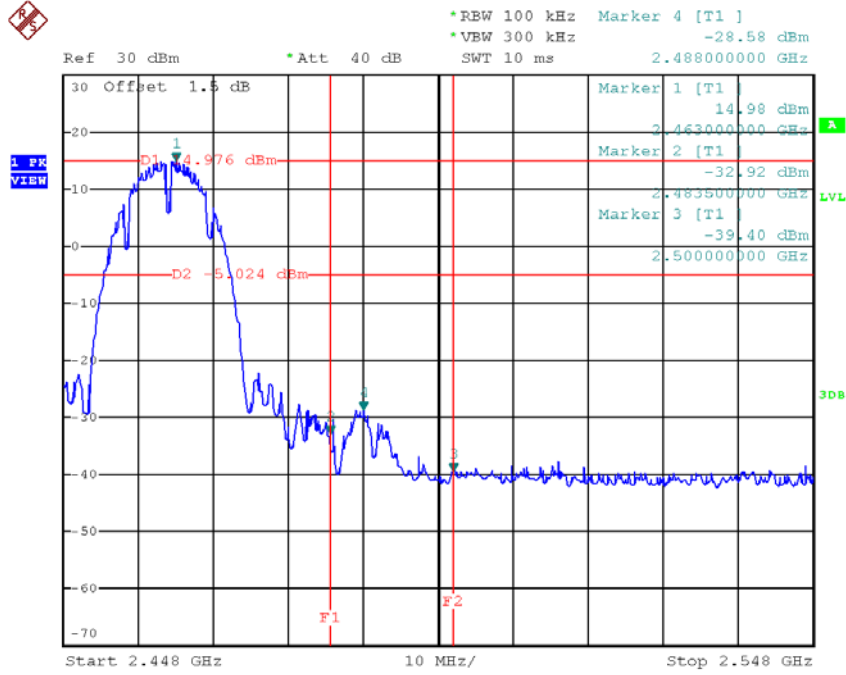

Date: 5.JUL.2018 10:53:10

### TX B mode CH01 (10 Harmonic of the frequency)

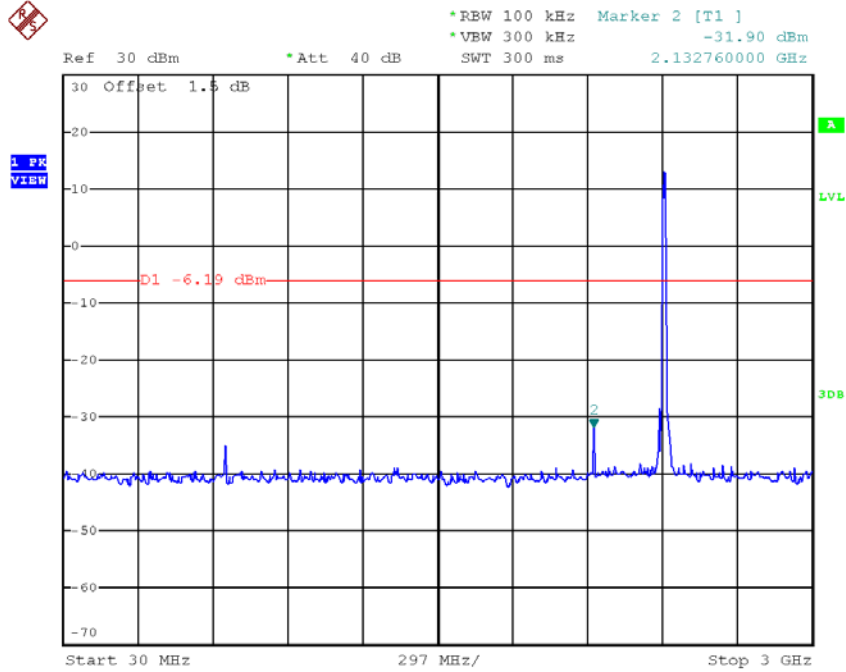

Date: 5.JUL.2018 10:49:37