



**中认信通**  
CHINA CERTIFICATION ICT CO., LTD (DONGGUAN)



## TEST REPORT

**Applicant: SHENZHEN TENDA TECHNOLOGY CO.,LTD.**

Address: 6-8 Floor, Tower E3, No. 1001, Zhongshanyuan Road, Nanshan District, Shenzhen, China. 518052

**FCC ID: V7TMESH3X**

**Product Name: Whole Home Mesh Wi-Fi 6 System**

**Model Number: Mesh3X, MX3, EX3**

**Standard(s): 47 CFR Part 15, Subpart E(15.407)  
ANSI C63.10-2013  
KDB 789033 D02 General U-NII Test Procedures New  
Rules v02r01**

The above equipment has been tested and found compliant with the requirement of the relative standards by China Certification ICT Co., Ltd (Dongguan)

**Report Number: CR221157793-00B**

**Date Of Issue: 2023/2/10**

**Reviewed By: Sun Zhong**

*Sun Zhong*

Title: Manager

**Test Laboratory: China Certification ICT Co., Ltd (Dongguan)**

No. 113, Pingkang Road, Dalang Town, Dongguan,  
Guangdong, China  
Tel: +86-769-82016888

## Test Facility

The Test site used by China Certification ICT Co., Ltd (Dongguan) to collect test data is located on the No. 113, Pingkang Road, Dalang Town, Dongguan, Guangdong, China.

The lab has been recognized as the FCC accredited lab under the KDB 974614 D01 and is listed in the FCC Public Access Link (PAL) database, FCC Registration No. : 442868, the FCC Designation No. : CN1314.

The lab has been recognized by Innovation, Science and Economic Development Canada to test to Canadian radio equipment requirements, the CAB identifier: CN0123.

## Declarations

China Certification ICT Co., Ltd (Dongguan) is not responsible for the authenticity of any test data provided by the applicant. Data included from the applicant that may affect test results are marked with a triangle symbol “▲”. Customer model name, addresses, names, trademarks etc. are not considered data.

Unless otherwise stated the results shown in this test report refer only to the sample(s) tested.

This report cannot be reproduced except in full, without prior written approval of the Company.

This report is valid only with a valid digital signature. The digital signature may be available only under the Adobe software above version 7.0.

This report may contain data that are not covered by the accreditation scope and shall be marked with an asterisk “★”.

## CONTENTS

<b>TEST FACILITY .....</b>	<b>2</b>
<b>DECLARATIONS.....</b>	<b>2</b>
<b>1. GENERAL INFORMATION .....</b>	<b>6</b>
<b>1.1 PRODUCT DESCRIPTION FOR EQUIPMENT UNDER TEST (EUT) .....</b>	<b>6</b>
<b>1.2 DESCRIPTION OF TEST CONFIGURATION.....</b>	<b>8</b>
1.2.2 Support Equipment List and Details .....	11
1.2.3 Support Cable List and Details .....	11
1.2.4 Block Diagram of Test Setup.....	11
<b>1.3 MEASUREMENT UNCERTAINTY .....</b>	<b>13</b>
<b>2. SUMMARY OF TEST RESULTS .....</b>	<b>14</b>
<b>3. REQUIREMENTS AND TEST PROCEDURES .....</b>	<b>15</b>
<b>3.1 AC LINE CONDUCTED EMISSIONS.....</b>	<b>15</b>
3.1.1 Applicable Standard.....	15
3.1.2 EUT Setup.....	16
3.1.3 EMI Test Receiver Setup .....	16
3.1.4 Test Procedure .....	17
3.1.5 Corrected Amplitude & Margin Calculation.....	17
<b>3.2 RADIATION SPURIOUS EMISSIONS.....</b>	<b>18</b>
3.2.1 Applicable Standard.....	18
3.2.2 EUT Setup.....	19
3.2.3 EMI Test Receiver & Spectrum Analyzer Setup .....	19
3.2.4 Test Procedure .....	20
3.2.5 Corrected Amplitude & Margin Calculation.....	20
<b>3.3 EMISSION BANDWIDTH: .....</b>	<b>21</b>
3.3.1 Applicable Standard.....	21
3.3.2 EUT Setup.....	21
3.3.3 Test Procedure .....	21
<b>3.4 MAXIMUM CONDUCTED OUTPUT POWER:.....</b>	<b>23</b>
3.4.1 Applicable Standard.....	23
3.4.2 EUT Setup.....	23
3.4.3 Test Procedure .....	24
<b>3.5 MAXIMUM POWER SPECTRAL DENSITY: .....</b>	<b>25</b>
3.5.1 Applicable Standard.....	25
3.5.2 EUT Setup.....	25
3.5.3 Test Procedure .....	26
<b>3.7 DUTY CYCLE:.....</b>	<b>26</b>
3.7.1 EUT Setup.....	26
3.7.2 Test Procedure .....	26
<b>3.8 ANTENNA REQUIREMENT.....</b>	<b>27</b>
3.8.1 Applicable Standard.....	27
3.8.2 Judgment.....	27

**4. Test DATA AND RESULTS..... 28**

**4.1 AC LINE CONDUCTED EMISSIONS.....28**

**4.2 RADIATION SPURIOUS EMISSIONS .....31**

**4.3 EMISSION BANDWIDTH: .....56**

**4.4 MAXIMUM CONDUCTED OUTPUT POWER: .....86**

**4.5 MAXIMUM POWER SPECTRAL DENSITY: .....90**

**4.6 DUTY CYCLE:.....121**

**5. RF EXPOSURE EVALUATION ..... 125**

**5.1 APPLICABLE STANDARD.....125**

**5.2 MEASUREMENT RESULT ..... 125**

## DOCUMENT REVISION HISTORY

Revision Number	Report Number	Description of Revision	Date of Revision
1.0	CR221157793-00B	Original Report	2023/2/10

## 1. GENERAL INFORMATION

### 1.1 Product Description for Equipment under Test (EUT)

#### 1.1.1 General:

<b>EUT Name:</b>	Whole Home Mesh Wi-Fi 6 System
<b>EUT Model:</b>	Mesh3X
<b>Multiple Model:</b>	MX3, EX3
<b>Operation Frequency:</b>	5180-5240 MHz (802.11a/n ht20/ac vht20/ax hew20) 5190-5230 MHz(802.11n ht40/ac vht40/ax hew40) 5210 MHz(802.11ac vht80/ax hew80) 5745-5825 MHz (802.11a/n ht20/ac vht20/ax hew20) 5755-5795 MHz(802.11n ht40/ac vht40/ax hew40) 5775 MHz(802.11ac vht80/ax hew80)
<b>Maximum Average Output Power (Conducted):</b>	25.02 dBm (5150-5250 MHz) 25.75 dBm (5725-5850 MHz)
<b>Modulation Type:</b>	802.11a/n/ac: OFDM-BPSK, QPSK, 16QAM, 64QAM, 256QAM 802.11ax: OFDMA- BPSK, QPSK, 16QAM, 64QAM, 256QAM, 1024QAM
<b>Rated Input Voltage:</b>	DC 12V from Adapter
<b>Serial Number:</b>	1ST2
<b>EUT Received Date:</b>	2022/11/28
<b>EUT Received Status:</b>	Good
Note: The Multiple models are electrically identical with the test model. Please refer to the declaration letter for more detail, which was provided by manufacturer.	

#### 1.1.2 Operation Frequency Detail:

##### For 802.11a/n ht20/ac vht20/ax hew20:

5150-5250MHz Band		5725-5850MHz Band	
Channel	Frequency (MHz)	Channel	Frequency (MHz)
36	5180	149	5745
40	5200	153	5765
44	5220	157	5785
48	5240	161	5805
/	/	165	5825
Per section 15.31(m), the below frequencies were performed the test as below:			
36	5180	149	5745
40	5200	157	5785
48	5240	165	5825

##### For 802.11n ht40/ac vht40/ax hew40:

5150-5250MHz Band		5725-5850MHz Band	
Channel	Frequency (MHz)	Channel	Frequency (MHz)
38	5190	151	5755
46	5230	159	5795
Per section 15.31(m), the below frequencies were performed the test as below:			
38	5190	151	5755
46	5230	159	5795

**For 802.11ac vht80/ax hew80:**

5150-5250MHz Band		5725-5850MHz Band	
Channel	Frequency (MHz)	Channel	Frequency (MHz)
42	5210	155	5775
Per section 15.31(m), the below frequencies were performed the test as below:			
42	5210	155	5775

**1.1.3 Antenna Information Detail▲:**

Antenna Chain	Manufacturer	Antenna Type	input impedance (Ohm)	Frequency Range	Antenna Gain
Chain 0	SHENZHEN TENDA TECHNOLOGY CO.,LTD.	Dipole	50	2400-2500MHz	3.39 dBi
				5150-5250MHz	3.01 dBi
				5725-5850MHz	2.80 dBi
Chain 1	SHENZHEN TENDA TECHNOLOGY CO.,LTD.	Dipole	50	2400-2500MHz	2.86 dBi
				5150-5250MHz	3.32 dBi
				5725-5850MHz	3.38 dBi

The Method of §15.203 Compliance:

- Antenna must be permanently attached to the unit.  
 Antenna must use a unique type of connector to attach to the EUT.  
 Unit must be professionally installed, and installer shall be responsible for verifying that the correct antenna is employed with the unit.

**1.1.4 Accessory Information:**

Accessory Description	Manufacturer	Model	Parameters
Adapter	SHENZHEN HEWEISHUN NETWORK TECHNOLOGY CO.,LTD.	BN073-A12012U	Input:100-240V, 50~60Hz,0.4A Output:12V,1A

## 1.2 Description of Test Configuration

### 1.2.1 EUT Operation Condition:

<b>EUT Operation Mode:</b>	The system was configured for testing in Engineering Mode, which was provided by the manufacturer.
<b>Equipment Modifications:</b>	No
<b>EUT Exercise Software:</b>	MP_AX.exe
The software "Access Mtool" was provided by manufacturer. The maximum power was configured as below, that was provided by the manufacturer ▲:	



Band	Mode	Channel	Frequency (MHz)	Data Rate	RU Config.	Power level	
						Chain 0	Chain 1
5150-5250 MHz	802.11a	Low	5180	6Mbps	N/A	20	21
		Middle	5200	6Mbps	N/A	23	25
		High	5240	6Mbps	N/A	24	24
	802.11n ht20	Low	5180	MCS8	N/A	20	20
		Middle	5200	MCS8	N/A	24	24
		High	5240	MCS8	N/A	24	23
	802.11n ht40	Low	5190	MCS8	N/A	19	19
		High	5230	MCS8	N/A	30	30
	802.11ac vht20	Low	5180	MCS8	N/A	20	20
		Middle	5200	MCS8	N/A	23	23
		High	5240	MCS8	N/A	23	23
	802.11ac vht40	Low	5190	MCS8	N/A	17	17
		High	5230	MCS8	N/A	30	30
	802.11ac vht80	Middle	5210	MCS8	N/A	16	16
	802.11ax hew20	Low	5180	MCS8	26/0	21	21
					52/37	21	21
					106/53	21	21
					242/61	21	21
		Middle	5200	MCS8	26/0	23	23
					52/37	23	23
					106/53	23	23
					242/61	23	23
		High	5240	MCS8	26/0	23	23
					52/37	23	23
					106/53	23	23
					242/61	23	23
	802.11ax hew40	Low	5190	MCS8	26/0	18	18
					52/37	18	18
					106/53	18	18
					242/61	18	18
High		5230	MCS8	484/65	18	18	
				26/0	23	23	
				52/37	23	23	
				106/53	23	23	
802.11ax hew80	Middle	5210	MCS8	242/61	23	23	
				484/65	23	23	
				26/0	18	18	
				52/37	18	18	
	Middle	5210	MCS8	106/53	18	18	
				242/61	18	18	
				484/65	18	18	
				996/67	18	18	

Band	Mode	Channel	Frequency (MHz)	Data Rate	RU Config.	Power level	
						Chain 0	Chain 1
5725-5850 MHz	802.11a	Low	5745	6Mbps	N/A	30	30
		Middle	5785	6Mbps	N/A	30	30
		High	5825	6Mbps	N/A	30	30
	802.11n ht20	Low	5745	MCS8	N/A	30	30
		Middle	5785	MCS8	N/A	30	30
		High	5825	MCS8	N/A	30	30
	802.11n ht40	Low	5755	MCS8	N/A	30	30
		High	5795	MCS8	N/A	30	30
	802.11ac vht20	Low	5745	MCS8	N/A	30	30
		Middle	5785	MCS8	N/A	30	30
		High	5825	MCS8	N/A	30	30
	802.11ac vht40	Low	5755	MCS8	N/A	23	23
		High	5795	MCS8	N/A	24	24
	802.11ac vht80	Middle	5775	MCS8	N/A	21	21
	802.11ax hew20	Low	5745	MCS8	26/0	30	30
					52/37	30	30
					106/53	30	30
					242/61	30	30
		Middle	5785	MCS8	26/0	30	30
					52/37	30	30
					106/53	30	30
					242/61	30	30
		High	5825	MCS8	26/0	30	30
					52/37	30	30
					106/53	30	30
					242/61	30	30
	802.11ax hew40	Low	5755	MCS8	26/0	22	22
					52/37	22	22
					106/53	22	22
					242/61	22	22
High		5795	MCS8	26/0	23	23	
				52/37	23	23	
				106/53	23	23	
				242/61	23	23	
802.11ax hew80	Middle	5775	MCS8	484/65	23	23	
				26/0	21	21	
				52/37	21	21	
				106/53	21	21	
				242/61	21	21	
				484/65	21	21	
				996/67	21	21	

The above are the worst-case data rates, which are determined for each mode based upon investigations by measuring the average power and PSD across all data rates, bandwidths, and modulations. The device supports SISO in all modes, and MIMO 2T2R in 802.11n/ac/ax modes, per pretest, 2T2R mode was the worst mode and reported for 802.11n/ac/ax modes.

The system supports Beamforming and Non-beamforming modes at 802.11n/ac/ax modes. The two modes have same output power, and the Beamforming mode has an additional 3dBi gain▲, which are declared by manufacturer. Therefore, the all RF conducted test were performed at Non-beamforming mode only. For 802.11 ax testing, all different tone and RU index configurations was performed for output power, the maximum result is in Full RU Configuration, so the other test was only performed at Full RU configuration(802.11ax hew20:242/61, 802.11ax hew40: 484/65, 802.11ax hew80: 996/67).

### 1.2.2 Support Equipment List and Details

Manufacturer	Description	Model	Serial Number
Lenovo	Laptop	T460S	60PDTEK8
Unknown	Load	Load-1	Load-1

### 1.2.3 Support Cable List and Details

Cable Description	Shielding Type	Ferrite Core	Length (m)	From Port	To
RJ45 Cable	Yes	No	5	EUT	Laptop
RJ45 Cable	Yes	No	5	EUT	Load
DC Cable	No	No	1.2	Adapter	EUT

### 1.2.4 Block Diagram of Test Setup

AC line conducted emissions:

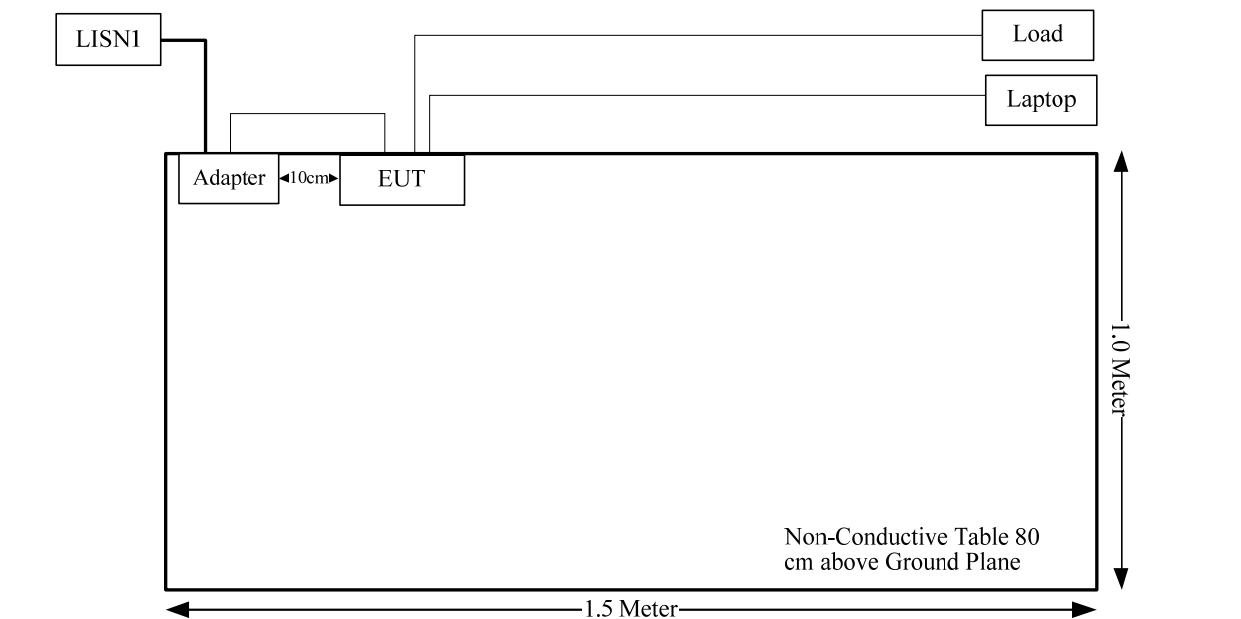

Spurious Emissions:

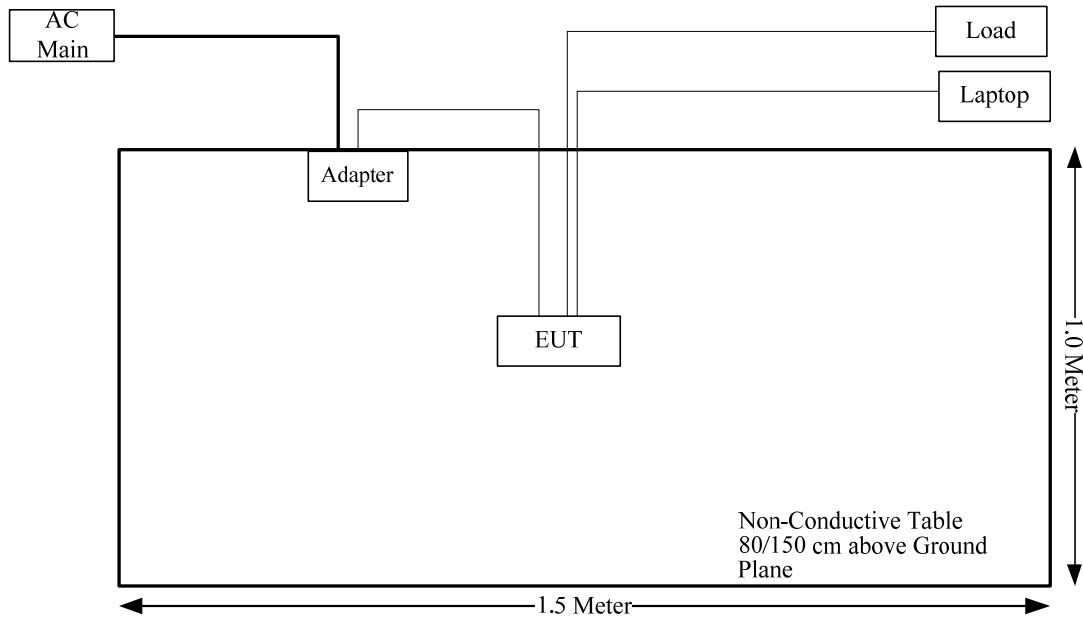

### 1.3 Measurement Uncertainty

Otherwise required by the applicant or Product Regulations, Decision Rule in this report did not consider the uncertainty. The extended uncertainty given in this report is obtained by combining the standard uncertainty times the coverage factor K with the 95% confidence interval.

Parameter	Measurement Uncertainty
Occupied Channel Bandwidth	±5 %
RF output power, conducted	±0.61dB
Power Spectral Density, conducted	±0.61 dB
Unwanted Emissions, radiated	30M~200MHz: 4.15 dB,200M~1GHz: 5.61 dB,1G~6GHz: 5.14 dB, 6G~18GHz: 5.93 dB,18G~26.5G:5.47 dB,26.5G~40G:5.63 dB
Unwanted Emissions, conducted	±1.26 dB
Temperature	±1 °C
Humidity	±5%
DC and low frequency voltages	±0.4%
Duty Cycle	1%
AC Power Lines Conducted Emission	2.8 dB (150 kHz to 30 MHz)

## 2. SUMMARY OF TEST RESULTS

Standard(s) Section	Test Items	Result
FCC§15.207(a)	AC line conducted emissions	Compliant
FCC§15.205& §15.209 &§15.407(b)	Undesirable Emission& Restricted Bands	Compliant
FCC§15.407(a) (e)	Emission Bandwidth	Compliant
FCC§15.407(a)	Conducted Transmitter Output Power	Compliant
FCC§15.407 (a)	Power Spectral Density	Compliant
FCC§15.203	Antenna Requirement	Compliant
§15.407 (f) & §1.1307 & §2.1091	RF Exposure Evaluation	Compliant

### 3. REQUIREMENTS AND TEST PROCEDURES

#### 3.1 AC Line Conducted Emissions

##### 3.1.1 Applicable Standard

FCC§15.207(a).

(a) Except as shown in paragraphs (b) and (c) of this section, for an intentional radiator that is designed to be connected to the public utility (AC) power line, the radio frequency voltage that is conducted back onto the AC power line on any frequency or frequencies, within the band 150 kHz to 30 MHz, shall not exceed the limits in the following table, as measured using a 50  $\mu$ H/50 ohms line impedance stabilization network (LISN). Compliance with the provisions of this paragraph shall be based on the measurement of the radio frequency voltage between each power line and ground at the power terminal. The lower limit applies at the boundary between the frequency ranges.

Frequency of emission (MHz)	Conducted limit (dB $\mu$ V)	
	Quasi-peak	Average
0.15-0.5	66 to 56*	56 to 46*
0.5-5	56	46
5-30	60	50

\*Decreases with the logarithm of the frequency.

(b) The limit shown in paragraph (a) of this section shall not apply to carrier current systems operating as intentional radiators on frequencies below 30 MHz. In lieu thereof, these carrier current systems shall be subject to the following standards:

(1) For carrier current system containing their fundamental emission within the frequency band 535-1705 kHz and intended to be received using a standard AM broadcast receiver: no limit on conducted emissions.

(2) For all other carrier current systems: 1000  $\mu$ V within the frequency band 535-1705 kHz, as measured using a 50  $\mu$ H/50 ohms LISN.

(3) Carrier current systems operating below 30 MHz are also subject to the radiated emission limits in §15.205, §15.209, §15.221, §15.223, or §15.227, as appropriate.

(c) Measurements to demonstrate compliance with the conducted limits are not required for devices which only employ battery power for operation and which do not operate from the AC power lines or contain provisions for operation while connected to the AC power lines. Devices that include, or make provisions for, the use of battery chargers which permit operating while charging, AC adapters or battery eliminators or that connect to the AC power lines indirectly, obtaining their power through another device which is connected to the AC power lines, shall be tested to demonstrate compliance with the conducted limits.

### 3.1.2 EUT Setup

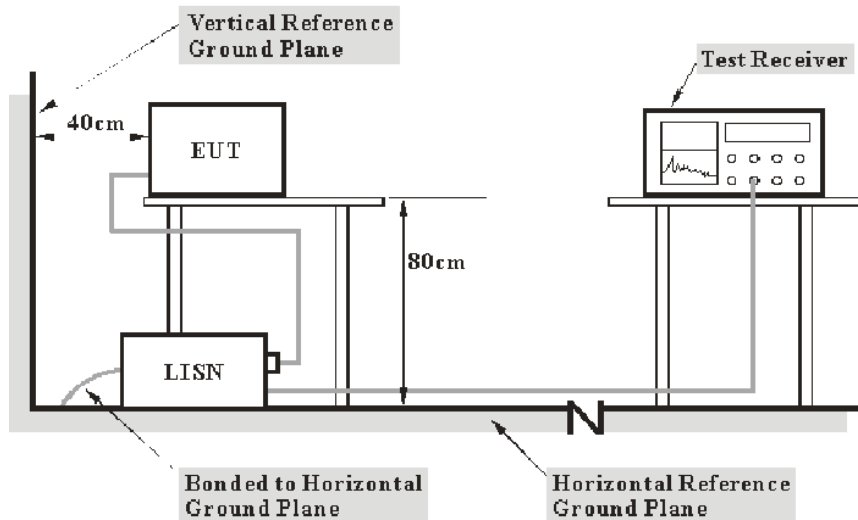

- Note: 1. Support units were connected to second LISN.  
 2. Both of LISNs (AMN) 80 cm from EUT and at the least 80 cm from other units and other metal planes support units.

The setup of EUT is according with per ANSI C63.10-2013 measurement procedure. The specification used was with the FCC Part 15.207 limits.

The spacing between the peripherals was 10 cm.

The adapter or EUT was connected to the main LISN with a 120 V/60 Hz AC power source.

### 3.1.3 EMI Test Receiver Setup

The EMI test receiver was set to investigate the spectrum from 150 kHz to 30 MHz.

During the conducted emission test, the EMI test receiver was set with the following configurations:

Frequency Range	IF B/W
150 kHz – 30 MHz	9 kHz



### 3.1.4 Test Procedure

The frequency and amplitude of the six highest ac power-line conducted emissions relative to the limit, measured over all the current-carrying conductors of the EUT power cords, and the operating frequency or frequency to which the EUT is tuned (if appropriate), should be reported, unless such emissions are more than 20 dB below the limit. AC power-line conducted emissions measurements are to be separately carried out only on each of the phase (“hot”) line(s) and (if used) on the neutral line(s), but not on the ground [protective earth] line(s). If less than six emission frequencies are within 20 dB of the limit, then the noise level of the measuring instrument at representative frequencies should be reported. The specific conductor of the power-line cord for each of the reported emissions should be identified. Measure the six highest emissions with respect to the limit on each current-carrying conductor of each power cord associated with the EUT (but not the power cords of associated or peripheral equipment that are part of the test configuration). Then, report the six highest emissions with respect to the limit from among all the measurements identifying the frequency and specific current-carrying conductor identified with the emission. The six highest emissions should be reported for each of the current-carrying conductors, or the six highest emissions may be reported over all the current-carrying conductors.

### 3.1.5 Corrected Amplitude & Margin Calculation

The basic equation is as follows:

Result = Reading + Factor

Factor = attenuation caused by cable loss + voltage division factor of AMN

The “**Margin**” column of the following data tables indicates the degree of compliance within the applicable limit. The equation for margin calculation is as follows:

Margin = Limit – Result

## 3.2 Radiation Spurious Emissions

### 3.2.1 Applicable Standard

FCC §15.407 (b);

*Undesirable emission limits.* Except as shown in paragraph (b)(7) of this section, the maximum emissions outside of the frequency bands of operation shall be attenuated in accordance with the following limits:

(1) For transmitters operating in the 5.15-5.25 GHz band: All emissions outside of the 5.15-5.35 GHz band shall not exceed an e.i.r.p. of - 27 dBm/MHz.

(2) For transmitters operating in the 5.25-5.35 GHz band: All emissions outside of the 5.15-5.35 GHz band shall not exceed an e.i.r.p. of - 27 dBm/MHz.

(3) For transmitters operating in the 5.47-5.725 GHz band: All emissions outside of the 5.47-5.725 GHz band shall not exceed an e.i.r.p. of - 27 dBm/MHz.

(4) For transmitters operating solely in the 5.725-5.850 GHz band:

(i) All emissions shall be limited to a level of - 27 dBm/MHz at 75 MHz or more above or below the band edge increasing linearly to 10 dBm/MHz at 25 MHz above or below the band edge, and from 25 MHz above or below the band edge increasing linearly to a level of 15.6 dBm/MHz at 5 MHz above or below the band edge, and from 5 MHz above or below the band edge increasing linearly to a level of 27 dBm/MHz at the band edge.

(ii) Devices certified before March 2, 2017 with antenna gain greater than 10 dBi may demonstrate compliance with the emission limits in § 15.247(d), but manufacturing, marketing and importing of devices certified under this alternative must cease by March 2, 2018. Devices certified before March 2, 2018 with antenna gain of 10 dBi or less may demonstrate compliance with the emission limits in § 15.247(d), but manufacturing, marketing and importing of devices certified under this alternative must cease before March 2, 2020.

(8) The emission measurements shall be performed using a minimum resolution bandwidth of 1 MHz. A lower resolution bandwidth may be employed near the band edge, when necessary, provided the measured energy is integrated to show the total power over 1 MHz.

(9) Unwanted emissions below 1 GHz must comply with the general field strength limits set forth in § 15.209. Further, any U-NII devices using an AC power line are required to comply also with the conducted limits set forth in § 15.207.

(10) The provisions of § 15.205 apply to intentional radiators operating under this section.

(11) When measuring the emission limits, the nominal carrier frequency shall be adjusted as close to the upper and lower frequency band edges as the design of the equipment permits.

(c) The device shall automatically discontinue transmission in case of either absence of information to transmit or operational failure. These provisions are not intended to preclude the transmission of control or signalling information or the use of repetitive codes used by certain digital technologies to complete frame or burst intervals. Applicants shall include in their application for equipment authorization a description of how this requirement is met.

### 3.2.2 EUT Setup

#### Below 1GHz:

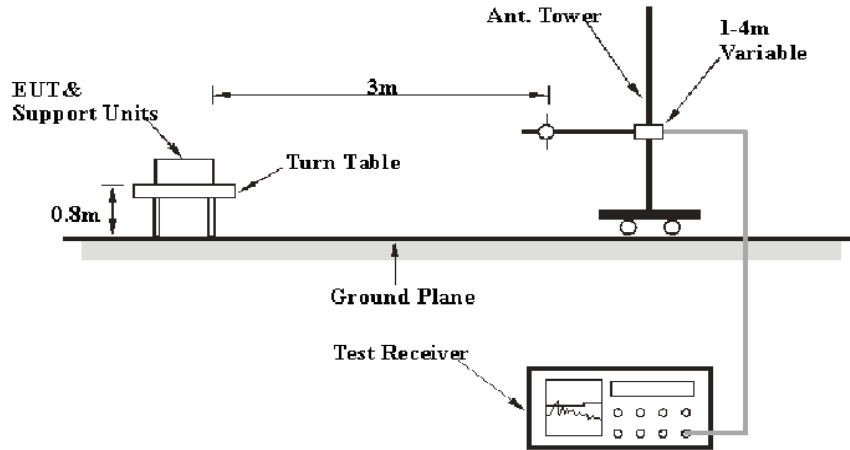

#### 1-40 GHz:

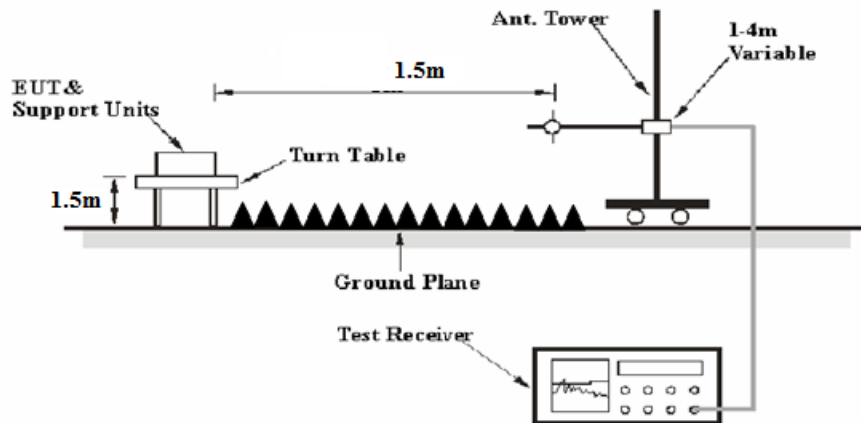

The radiated emission tests were performed in the 3 meters chamber test site, using the setup accordance with the ANSI C63.10-2013. The specification used was FCC 15.209, FCC 15.407 limits.

The external I/O cables were draped along the test table and formed a bundle 30 to 40 cm long in the middle.

The spacing between the peripherals was 10 cm.

### 3.2.3 EMI Test Receiver & Spectrum Analyzer Setup

The system was investigated from 30 MHz to 40 GHz.

During the radiated emission test, the EMI test receiver & Spectrum Analyzer Setup were set with the following configurations:

30-1000MHz:

Detector	RBW	Video B/W	IF B/W
QP	120 kHz	300 kHz	120kHz

1GHz- 40GHz:

Measurement	Duty cycle	RBW	Video B/W
PK	Any	1MHz	3 MHz
AV	>98%	1MHz	10 Hz
	<98%	1MHz	1/T

Note: T is minimum transmission duration

If the maximized peak measured value complies with under the QP/Average limit more than 6dB, then it is unnecessary to perform an QP/Average measurement.

### 3.2.4 Test Procedure

During the radiated emission test, the adapter was connected to the first AC floor outlet.

Data was recorded in Quasi-peak detection mode for frequency range of 30 MHz-1GHz, peak and Average detection modes for frequencies above 1GHz.

According to KDB 789033 D02 General UNII Test Procedures New Rules v02r01, emission shall be computed as:  $E [dB\mu V/m] = EIRP[dBm] + 95.2$ , for  $d = 3$  meters.

According to C63.10, the above 1G test result shall be extrapolated to the specified distance using an extrapolation Factor of 20dB/decade from 3m to 1.5m

Distance extrapolation Factor =  $20 \log (\text{specific distance } [3m] / \text{test distance } [1.5m])$  dB = 6.02 dB

All emissions under the average limit and under the noise floor have not recorded in the report.

### 3.2.5 Corrected Amplitude & Margin Calculation

The basic equation is as follows:

Factor = Antenna Factor + Cable Loss- Amplifier Gain

For 30MHz-1GHz:

Result = Reading + Factor

For 1GHz-40GHz

Result = Reading + Factor - Distance extrapolation Factor

The “**Margin**” column of the following data tables indicates the degree of compliance within the applicable limit. The equation for margin calculation is as follows:

Margin = Limit – Result

### 3.3 Emission Bandwidth:

#### 3.3.1 Applicable Standard

FCC §15.407 (a),(h)

(h)(2) Radar Detection Function of Dynamic Frequency Selection (DFS). U-NII devices operating with any part of its 26 dB emission bandwidth in the 5.25-5.35 GHz and 5.47-5.725 GHz bands shall employ a DFS radar detection mechanism to detect the presence of radar systems and to avoid co-channel operation with radar systems.

FCC §15.407 (e)

Within the 5.725-5.850 GHz and 5.850-5.895 GHz bands, the minimum 6 dB bandwidth of U-NII devices shall be at least 500 kHz.

#### 3.3.2 EUT Setup

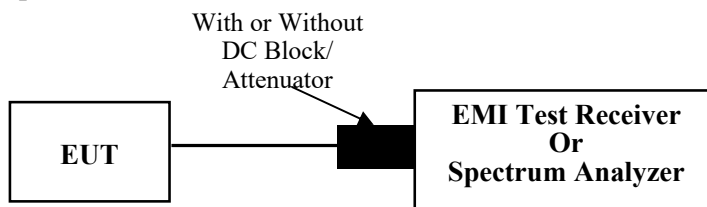

#### 3.3.3 Test Procedure

##### 26dB Emission Bandwidth:

According to ANSI C63.10-2013 Section 12.4.1

- a) Set RBW = approximately 1% of the emission bandwidth.
- b) Set the VBW > RBW.
- c) Detector = peak.
- d) Trace mode = max hold
- e) Measure the maximum width of the emission that is 26 dB down from the peak of the emission. Compare this with the RBW setting of the instrument. Readjust RBW and repeat measurement as needed until the RBW/EBW ratio is approximately 1%.

##### 6 dB emission bandwidth:

According to KDB 789033 D02 General UNII Test Procedures New Rules v02r01

- a) Set RBW = 100 kHz.
- b) Set the video bandwidth (VBW)  $\geq 3$  RBW.
- c) Detector = Peak.
- d) Trace mode = max hold.
- e) Sweep = auto couple.
- f) Allow the trace to stabilize.
- g) Measure the maximum width of the emission that is constrained by the frequencies associated with the two outermost amplitude points (upper and lower frequencies) that are attenuated by 6 dB relative to the maximum level measured in the fundamental emission.

Note: The automatic bandwidth measurement capability of a spectrum analyzer or EMI receiver may be employed if it implements the functionality described in this section. For devices that use channel aggregation refer to III.A and III.C for determining emission bandwidth.

**99% Occupied Bandwidth:**

According to ANSI C63.10-2013 Section 12.4.2&6.9.3

The occupied bandwidth is the frequency bandwidth such that, below its lower and above its upper frequency limits, the mean powers are each equal to 0.5% of the total mean power of the given emission. The following procedure shall be used for measuring 99% power bandwidth:

- a) The instrument center frequency is set to the nominal EUT channel center frequency. The frequency span for the spectrum analyzer shall be between 1.5 times and 5.0 times the OBW.
- b) The nominal IF filter bandwidth (3 dB RBW) shall be in the range of 1% to 5% of the OBW, and VBW shall be approximately three times the RBW, unless otherwise specified by the applicable requirement.
- c) Set the reference level of the instrument as required, keeping the signal from exceeding the maximum input mixer level for linear operation. In general, the peak of the spectral envelope shall be more than  $[10 \log (OBW/RBW)]$  below the reference level. Specific guidance is given in 4.1.5.2.
- d) Step a) through step c) might require iteration to adjust within the specified range.
- e) Video averaging is not permitted. Where practical, a sample detection and single sweep mode shall be used. Otherwise, peak detection and max hold mode (until the trace stabilizes) shall be used.
- f) Use the 99% power bandwidth function of the instrument (if available) and report the measured bandwidth.
- g) If the instrument does not have a 99% power bandwidth function, then the trace data points are recovered and directly summed in linear power terms. The recovered amplitude data points, beginning at the lowest frequency, are placed in a running sum until 0.5% of the total is reached; that frequency is recorded as the lower frequency. The process is repeated until 99.5% of the total is reached; that frequency is recorded as the upper frequency. The 99% power bandwidth is the difference between these two frequencies.
- h) The occupied bandwidth shall be reported by providing plot(s) of the measuring instrument display; the plot axes and the scale units per division shall be clearly labeled. Tabular data may be reported in addition to the plot(s).

### 3.4 Maximum conducted output power:

#### 3.4.1 Applicable Standard

FCC §15.407(a) (1)

(i) For an outdoor access point operating in the band 5.15-5.25 GHz, the maximum conducted output power over the frequency band of operation shall not exceed 1 W provided the maximum antenna gain does not exceed 6 dBi. In addition, the maximum power spectral density shall not exceed 17 dBm in any 1 megahertz band. If transmitting antennas of directional gain greater than 6 dBi are used, both the maximum conducted output power and the maximum power spectral density shall be reduced by the amount in dB that the directional gain of the antenna exceeds 6 dBi. The maximum e.i.r.p. at any elevation angle above 30 degrees as measured from the horizon must not exceed 125 mW (21 dBm).

(ii) For an indoor access point operating in the band 5.15-5.25 GHz, the maximum conducted output power over the frequency band of operation shall not exceed 1 W provided the maximum antenna gain does not exceed 6 dBi. In addition, the maximum power spectral density shall not exceed 17 dBm in any 1 megahertz band. If transmitting antennas of directional gain greater than 6 dBi are used, both the maximum conducted output power and the maximum power spectral density shall be reduced by the amount in dB that the directional gain of the antenna exceeds 6 dBi.

(iv) For client devices in the 5.15-5.25 GHz band, the maximum conducted output power over the frequency band of operation shall not exceed 250 mW provided the maximum antenna gain does not exceed 6 dBi. In addition, the maximum power spectral density shall not exceed 11 dBm in any 1 megahertz band. If transmitting antennas of directional gain greater than 6 dBi are used, both the maximum conducted output power and the maximum power spectral density shall be reduced by the amount in dB that the directional gain of the antenna exceeds 6 dBi.

FCC §15.407(a) (3)(i)

For the band 5.725-5.850 GHz, the maximum conducted output power over the frequency band of operation shall not exceed 1 W. In addition, the maximum power spectral density shall not exceed 30 dBm in any 500-kHz band. If transmitting antennas of directional gain greater than 6 dBi are used, both the maximum conducted output power and the maximum power spectral density shall be reduced by the amount in dB that the directional gain of the antenna exceeds 6 dBi. However, fixed point-to-point U-NII devices operating in this band may employ transmitting antennas with directional gain greater than 6 dBi without any corresponding reduction in transmitter conducted power. Fixed, point-to-point operations exclude the use of point-to-multipoint systems, omnidirectional applications, and multiple collocated transmitters transmitting the same information. The operator of the U-NII device, or if the equipment is professionally installed, the installer, is responsible for ensuring that systems employing high gain directional antennas are used exclusively for fixed, point-to-point operations.

#### 3.4.2 EUT Setup

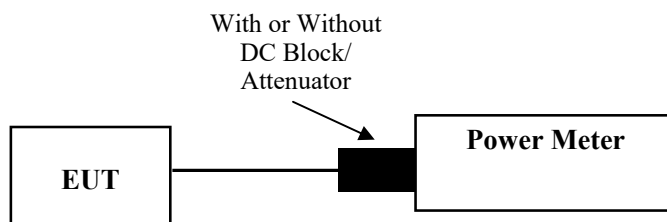

### **3.4.3 Test Procedure**

According to ANSI C63.10-2013 Section 11.9.1.3

Method PM-G is measurement using a gated RF average power meter. Measurements may be performed using a wideband gated RF power meter provided that the gate parameters are adjusted such that the power is measured only when the EUT is transmitting at its maximum power control level. Because the measurement is made only during the ON time of the transmitter, no duty cycle correction factor is required.



### 3.5 Maximum power spectral density:

#### 3.5.1 Applicable Standard

FCC §15.407(a) (1)

(i) For an outdoor access point operating in the band 5.15-5.25 GHz, the maximum conducted output power over the frequency band of operation shall not exceed 1 W provided the maximum antenna gain does not exceed 6 dBi. In addition, the maximum power spectral density shall not exceed 17 dBm in any 1 megahertz band. If transmitting antennas of directional gain greater than 6 dBi are used, both the maximum conducted output power and the maximum power spectral density shall be reduced by the amount in dB that the directional gain of the antenna exceeds 6 dBi. The maximum e.i.r.p. at any elevation angle above 30 degrees as measured from the horizon must not exceed 125 mW (21 dBm).

(ii) For an indoor access point operating in the band 5.15-5.25 GHz, the maximum conducted output power over the frequency band of operation shall not exceed 1 W provided the maximum antenna gain does not exceed 6 dBi. In addition, the maximum power spectral density shall not exceed 17 dBm in any 1 megahertz band. If transmitting antennas of directional gain greater than 6 dBi are used, both the maximum conducted output power and the maximum power spectral density shall be reduced by the amount in dB that the directional gain of the antenna exceeds 6 dBi.

(iv) For client devices in the 5.15-5.25 GHz band, the maximum conducted output power over the frequency band of operation shall not exceed 250 mW provided the maximum antenna gain does not exceed 6 dBi. In addition, the maximum power spectral density shall not exceed 11 dBm in any 1 megahertz band. If transmitting antennas of directional gain greater than 6 dBi are used, both the maximum conducted output power and the maximum power spectral density shall be reduced by the amount in dB that the directional gain of the antenna exceeds 6 dBi.

FCC §15.407(a) (3)(i)

For the band 5.725-5.850 GHz, the maximum conducted output power over the frequency band of operation shall not exceed 1 W. In addition, the maximum power spectral density shall not exceed 30 dBm in any 500-kHz band. If transmitting antennas of directional gain greater than 6 dBi are used, both the maximum conducted output power and the maximum power spectral density shall be reduced by the amount in dB that the directional gain of the antenna exceeds 6 dBi. However, fixed point-to-point U-NII devices operating in this band may employ transmitting antennas with directional gain greater than 6 dBi without any corresponding reduction in transmitter conducted power. Fixed, point-to-point operations exclude the use of point-to-multipoint systems, omnidirectional applications, and multiple collocated transmitters transmitting the same information. The operator of the U-NII device, or if the equipment is professionally installed, the installer, is responsible for ensuring that systems employing high gain directional antennas are used exclusively for fixed, point-to-point operations.

#### 3.5.2 EUT Setup

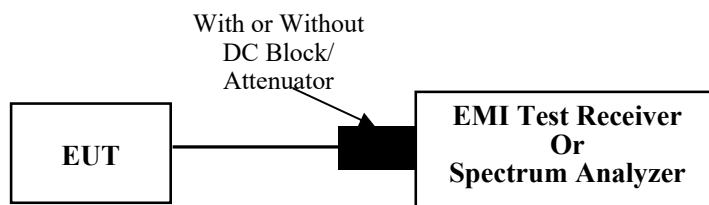

### 3.5.3 Test Procedure

According to KDB 789033 D02 General UNII Test Procedures New Rules v02r01

**Method SA-3** (power averaging (rms) detection with max hold):

(i) Set span to encompass the entire EBW (or, alternatively, the entire 99% occupied bandwidth) of the signal.

(ii) Set sweep trigger to “free run.”

(iii) Set RBW = 1 MHz.

(iv) Set VBW  $\geq$  3 MHz

(v) Number of points in sweep  $\geq 2 \times \text{span} / \text{RBW}$ . (This ensures that bin-to-bin spacing is  $\leq \text{RBW}/2$ , so that narrowband signals are not lost between frequency bins.)

(vi) Sweep time  $\leq (\text{number of points in sweep}) \times T$ , where  $T$  is defined in II.B.1.a).

Note: If this results in a sweep time less than the auto sweep time of the analyzer, Method SA-3 Alternative shall not be used. (The purpose of this step is to ensure that averaging time in each bin is less than or equal to the minimum time of a transmission.)

(vii) Detector = power averaging (rms).

(viii) Trace mode = max hold.

(ix) Allow max hold to run for at least 60 seconds, or longer as needed to allow the trace to stabilize.

For devices operating in the band 5.725–5.85 GHz, the rules specify a measurement bandwidth of 500 kHz. Many spectrum analyzers do not have 500 kHz RBW, thus a narrower RBW may need to be used.

## 3.7 Duty Cycle:

### 3.7.1 EUT Setup

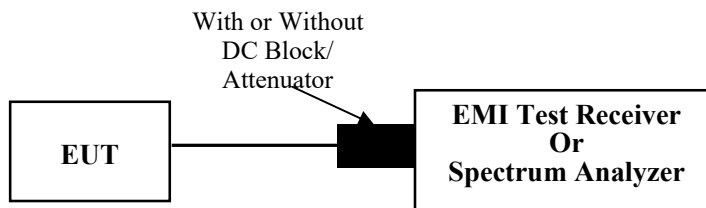

### 3.7.2 Test Procedure

According to ANSI C63.10-2013 Section 12.2

The zero-span mode on a spectrum analyzer or EMI receiver if the response time and spacing between bins on the sweep are sufficient to permit accurate measurements of the ON and OFF times of the transmitted signal:

- 1) Set the center frequency of the instrument to the center frequency of the transmission.
- 2) Set RBW  $\geq$  OBW if possible; otherwise, set RBW to the largest available value.
- 3) Set VBW  $\geq$  RBW. Set detector = peak or average.
- 4) The zero-span measurement method shall not be used unless both RBW and VBW are  $> 50/T$  and the number of sweep points across duration  $T$  exceeds 100. (For example, if VBW and/or RBW are limited to 3 MHz, then the zero-span method of measuring the duty cycle shall not be used if  $T \leq 16.7 \mu\text{s}$ .)

## **3.8 Antenna Requirement**

### **3.8.1 Applicable Standard**

FCC §15.203

An intentional radiator shall be designed to ensure that no antenna other than that furnished by the responsible party shall be used with the device. The use of a permanently attached antenna or of an antenna that uses a unique coupling to the intentional radiator shall be considered sufficient to comply with the provisions of this section. The manufacturer may design the unit so that a broken antenna can be replaced by the user, but the use of a standard antenna jack or electrical connector is prohibited. This requirement does not apply to carrier current devices or to devices operated under the provisions of §§15.211, 15.213, 15.217, 15.219, 15.221, or §15.236. Further, this requirement does not apply to intentional radiators that must be professionally installed, such as perimeter protection systems and some field disturbance sensors, or to other intentional radiators which, in accordance with §15.31(d), must be measured at the installation site. However, the installer shall be responsible for ensuring that the proper antenna is employed so that the limits in this part are not exceeded.

### **3.8.2 Judgment**

**Result: Compliant.** Please refer to the Antenna Information detail in Section 1.

## 4. Test DATA AND RESULTS

### 4.1 AC Line Conducted Emissions

Serial Number:	1ST2	Test Date:	2022/12/09
Test Site:	CE	Test Mode:	Transmitting (802.11a chain 0 5785MHz was the worst)
Tester:	Vic Du	Test Result:	Pass

#### Environmental Conditions:

Temperature: (°C)	21.8	Relative Humidity: (%)	54	ATM Pressure: (kPa)	101.7
----------------------	------	------------------------------	----	------------------------	-------

#### Test Equipment List and Details:

Manufacturer	Description	Model	Serial Number	Calibration Date	Calibration Due Date
R&S	LISN	ENV216	101134	2022/04/01	2023/03/31
R&S	EMI Test Receiver	ESR3	102726	2022/07/15	2023/07/14
MICRO-COAX	Coaxial Cable	UTIFLEX	C-0200-01	2022/08/07	2023/08/06
Audix	Test Software	E3	190306 (V9)	N/A	N/A

\* Statement of Traceability: China Certification ICT Co., Ltd (Dongguan) attests that all calibrations have been performed, traceable to National Primary Standards and International System of Units (SI).

Test Mode: Transmitting  
 Port: Line  
 Note:

Date: 2022-12-09

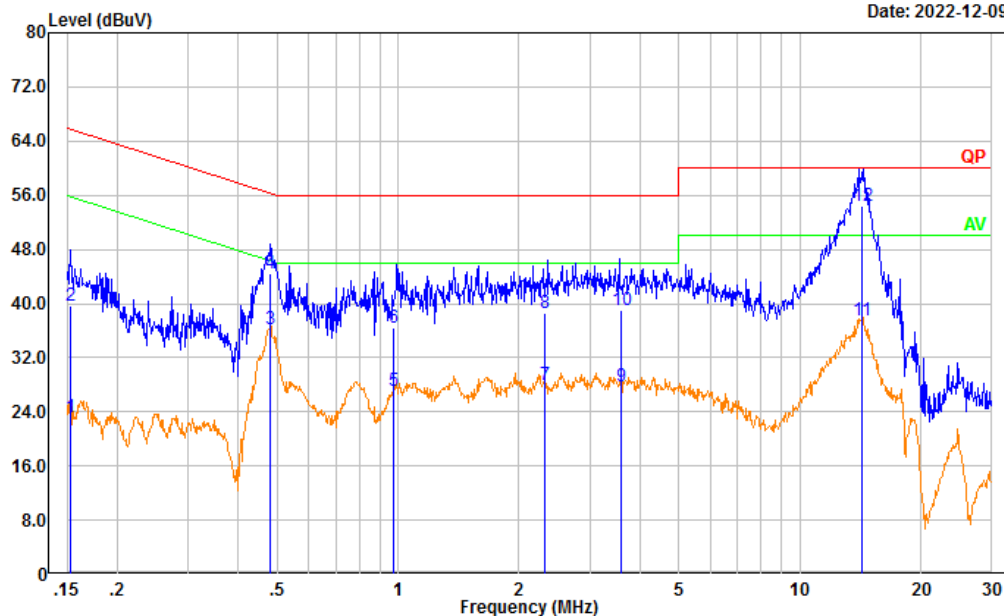

No.	Frequency (MHz)	Reading (dBμV)	Factor (dB)	Result (dBμV)	Limit (dBμV)	Margin (dB)	Detector
1	0.154	13.53	9.61	23.14	55.80	32.66	Average
2	0.154	30.06	9.61	39.67	65.80	26.13	QP
3	0.482	26.65	9.61	36.26	46.30	10.04	Average
4	0.482	34.73	9.61	44.34	56.30	11.96	QP
5	0.972	17.40	9.62	27.02	46.00	18.98	Average
6	0.972	26.80	9.62	36.42	56.00	19.58	QP
7	2.324	18.24	9.64	27.88	46.00	18.12	Average
8	2.324	29.06	9.64	38.70	56.00	17.30	QP
9	3.598	18.20	9.65	27.85	46.00	18.15	Average
10	3.598	29.45	9.65	39.10	56.00	16.90	QP
11	14.236	27.89	9.68	37.57	50.00	12.43	Average
12	14.236	44.76	9.68	54.44	60.00	5.56	QP

Test Mode: Transmitting  
 Port: neutral  
 Note:

Date: 2022-12-09

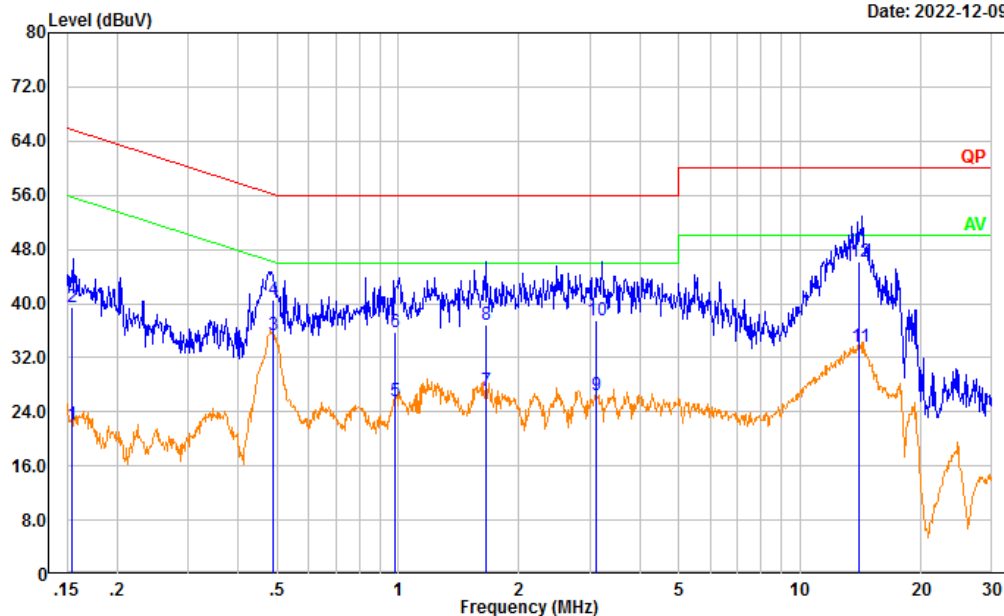

No.	Frequency (MHz)	Reading (dBuV)	Factor (dB)	Result (dBuV)	Limit (dBuV)	Margin (dB)	Detector
1	0.155	12.51	9.61	22.12	55.74	33.62	Average
2	0.155	29.91	9.61	39.52	65.74	26.22	QP
3	0.491	25.70	9.61	35.31	46.16	10.85	Average
4	0.491	31.03	9.61	40.64	56.16	15.52	QP
5	0.980	15.95	9.62	25.57	46.00	20.43	Average
6	0.980	26.25	9.62	35.87	56.00	20.13	QP
7	1.649	17.41	9.63	27.04	46.00	18.96	Average
8	1.649	27.27	9.63	36.90	56.00	19.10	QP
9	3.123	16.70	9.65	26.35	46.00	19.65	Average
10	3.123	27.93	9.65	37.58	56.00	18.42	QP
11	14.050	23.84	9.68	33.52	50.00	16.48	Average
12	14.050	36.52	9.68	46.20	60.00	13.80	QP

## 4.2 Radiation Spurious Emissions

Serial Number:	1ST2	Test Date:	2022/12/14~2022/12/18
Test Site:	966-1, 966-2	Test Mode:	Transmitting
Tester:	Carl Xue, Mack Huang	Test Result:	Pass

### Environmental Conditions:

Temperature: (°C)	20.8~23.2	Relative Humidity: (%)	44~48	ATM Pressure: (kPa)	101.8~102.4
----------------------	-----------	------------------------------	-------	------------------------	-------------

### Test Equipment List and Details:

Manufacturer	Description	Model	Serial Number	Calibration Date	Calibration Due Date
Sunol Sciences	Antenna	JB6	A082520-5	2020/10/19	2023/10/18
R&S	EMI Test Receiver	ESR3	102724	2022/07/15	2023/07/14
TIMES MICROWAVE	Coaxial Cable	LMR-600-UltraFlex	C-0470-02	2022/07/17	2023/07/16
TIMES MICROWAVE	Coaxial Cable	LMR-600-UltraFlex	C-0780-01	2022/07/17	2023/07/16
Sonoma	Amplifier	310N	186165	2022/07/17	2023/07/16
Audix	Test Software	E3	201021 (V9)	N/A	N/A
ETS-Lindgren	Horn Antenna	3115	9912-5985	2020/10/13	2023/10/12
R&S	Spectrum Analyzer	FSV40	101591	2022/07/15	2023/07/14
MICRO-COAX	Coaxial Cable	UFA210A-1-1200-70U300	217423-008	2022/08/07	2023/08/06
MICRO-COAX	Coaxial Cable	UFA210A-1-2362-300300	235780-001	2022/08/07	2023/08/06
Mini	Pre-amplifier	ZVA-183-S+	5969001149	2022/11/09	2023/11/08
PASTERNAK	Horn Antenna	PE9852/2F-20	112002	2021/02/05	2024/02/04
AH	Preamplifier	PAM-1840VH	190	2022/11/09	2023/11/08
MICRO-COAX	Coaxial Cable	UFB142A-1-2362-200200	235772-001	2022/08/07	2023/08/06
E-Microwave	Band Rejection Filter	5150-5850MHz	OE01902423	2022/08/07	2023/08/06
Mini Circuits	High Pass Filter	VHF-6010+	31119	2022/08/07	2023/08/06
PASTERNAK	Horn Antenna	PE9850/2F-20	072001	2021/02/05	2024/02/04

\* Statement of Traceability: China Certification ICT Co., Ltd (Dongguan) attests that all calibrations have been performed, traceable to National Primary Standards and International System of Units (SI).

### Test Data:

Please refer to the below table and plots.

1) 30MHz-1GHz(802.11a Chain 0 5785MHz was the worst)

Test Mode: Transmitting  
 Polarization: horizontal  
 Note:

Date: 2022-12-14

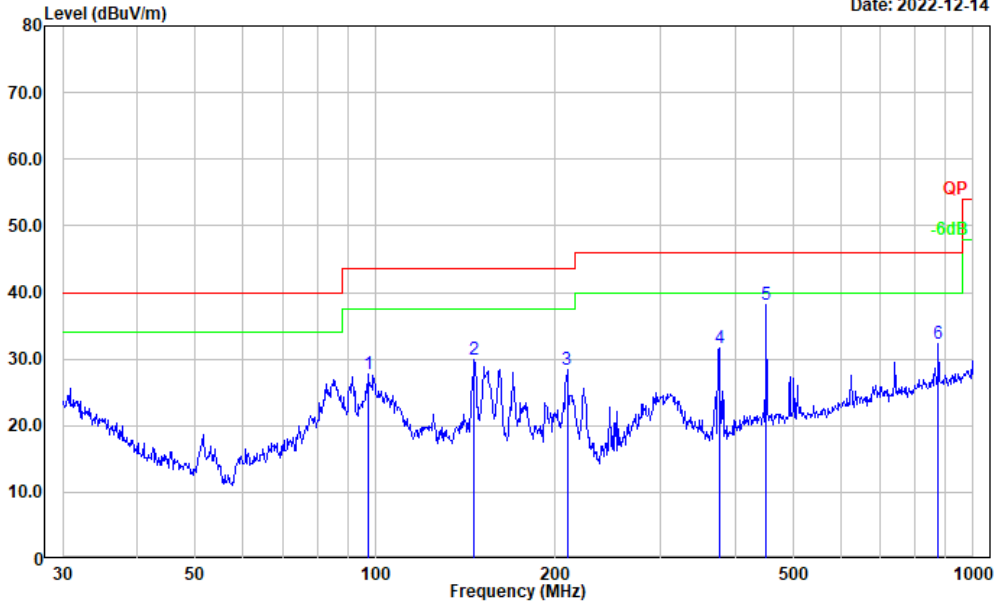

No.	Frequency (MHz)	Reading (dBμV)	Factor (dB/m)	Result (dBμV/m)	Limit (dBμV/m)	Margin (dB)	Detector
1	97.115	42.72	-15.05	27.67	43.50	15.83	Peak
2	146.374	41.85	-11.98	29.87	43.50	13.63	Peak
3	209.313	40.77	-12.46	28.31	43.50	15.19	Peak
4	375.939	40.97	-9.29	31.68	46.00	14.32	Peak
5	451.135	45.16	-6.91	38.25	46.00	7.75	Peak
6	875.247	33.59	-1.18	32.41	46.00	13.59	Peak



Test Mode: Transmitting  
 Polarization: vertical  
 Note:

Date: 2022-12-14

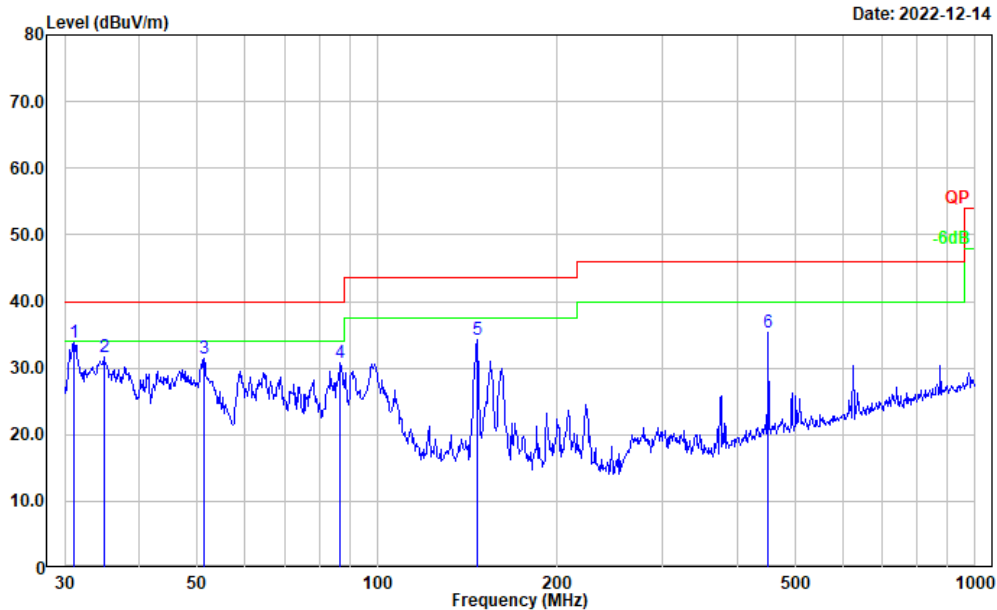

No.	Frequency (MHz)	Reading (dBμV)	Factor (dB/m)	Result (dBμV/m)	Limit (dBμV/m)	Margin (dB)	Detector
1	31.071	38.21	-4.43	33.78	40.00	6.22	Peak
2	34.882	39.12	-7.39	31.73	40.00	8.27	Peak
3	51.301	48.75	-17.21	31.54	40.00	8.46	Peak
4	86.807	47.89	-17.10	30.79	40.00	9.21	Peak
5	146.888	46.27	-11.98	34.29	43.50	9.21	Peak
6	451.135	42.22	-6.91	35.31	46.00	10.69	Peak

## 2) 1GHz-40GHz:

5150-5250MHz

802.11a, Chain 0:

Frequency (MHz)	Receiver		Polar (H/V)	Factor (dB/m)	Result (dB $\mu$ V/m)	Limit (dB $\mu$ V/m)	Margin (dB)
	Reading (dB $\mu$ V)	Detector					
Low Channel: 5180MHz							
5180.000	70.34	PK	H	38.68	103.00	N/A	N/A
5180.000	60.16	AV	H	38.68	92.82	N/A	N/A
5180.000	82.19	PK	V	38.68	114.85	N/A	N/A
5180.000	72.50	AV	V	38.68	105.16	N/A	N/A
5150.000	37.77	PK	V	38.64	70.39	74.00	3.61
5150.000	19.70	AV	V	38.64	52.32	54.00	1.68
10360.000	34.18	PK	V	19.18	47.34	68.20	20.86
15540.000	43.30	PK	V	22.44	59.72	74.00	14.28
15540.000	30.15	AV	V	22.44	46.57	54.00	7.43
Middle Channel: 5200 MHz							
5200.000	70.55	PK	H	38.70	103.23	N/A	N/A
5200.000	60.24	AV	H	38.70	92.92	N/A	N/A
5200.000	80.31	PK	V	38.70	112.99	N/A	N/A
5200.000	70.59	AV	V	38.70	103.27	N/A	N/A
10400.000	32.93	PK	V	19.16	46.07	68.20	22.13
15600.000	49.04	PK	V	22.41	65.43	74.00	8.57
15600.000	36.02	AV	V	22.41	52.41	54.00	1.59
High Channel: 5240 MHz							
5240.000	73.74	PK	H	38.85	106.57	N/A	N/A
5240.000	63.58	AV	H	38.85	96.41	N/A	N/A
5240.000	81.38	PK	V	38.85	114.21	N/A	N/A
5240.000	71.60	AV	V	38.85	104.43	N/A	N/A
5350.000	29.48	PK	V	39.03	62.49	74.00	11.51
5350.000	16.61	AV	V	39.03	49.62	54.00	4.38
10480.000	36.88	PK	V	18.86	49.72	68.20	18.48
15720.000	49.58	PK	V	22.28	65.84	74.00	8.16
15720.000	36.39	AV	V	22.28	52.65	54.00	1.35

## 802.11a, Chain 1:

Frequency (MHz)	Receiver		Polar (H/V)	Factor (dB/m)	Result (dBµV/m)	Limit (dBµV/m)	Margin (dB)
	Reading (dBµV)	Detector					
Low Channel: 5180MHz							
5180.000	64.39	PK	H	38.68	97.05	N/A	N/A
5180.000	54.26	AV	H	38.68	86.92	N/A	N/A
5180.000	76.41	PK	V	38.68	109.07	N/A	N/A
5180.000	66.83	AV	V	38.68	99.49	N/A	N/A
5150.000	38.18	PK	V	38.64	70.80	74.00	3.20
5150.000	20.03	AV	V	38.64	52.65	54.00	1.35
10360.000	33.12	PK	V	19.18	46.28	68.20	21.92
15540.000	48.82	PK	V	22.44	65.24	74.00	8.76
15540.000	35.41	AV	V	22.44	51.83	54.00	2.17
Middle Channel: 5200 MHz							
5200.000	67.29	PK	H	38.70	99.97	N/A	N/A
5200.000	57.34	AV	H	38.70	90.02	N/A	N/A
5200.000	79.62	PK	V	38.70	112.30	N/A	N/A
5200.000	69.37	AV	V	38.70	102.05	N/A	N/A
10400.000	33.56	PK	V	19.16	46.70	68.20	21.50
15600.000	49.35	PK	V	22.41	65.74	74.00	8.26
15600.000	36.18	AV	V	22.41	52.57	54.00	1.43
High Channel: 5240 MHz							
5240.000	66.37	PK	H	38.85	99.20	N/A	N/A
5240.000	56.21	AV	H	38.85	89.04	N/A	N/A
5240.000	79.00	PK	V	38.85	111.83	N/A	N/A
5240.000	69.53	AV	V	38.85	102.36	N/A	N/A
5350.000	29.30	PK	V	39.03	62.31	74.00	11.69
5350.000	16.63	AV	V	39.03	49.64	54.00	4.36
10480.000	36.90	PK	V	18.86	49.74	68.20	18.46
15720.000	48.88	PK	V	22.28	65.14	74.00	8.86
15720.000	35.44	AV	V	22.28	51.70	54.00	2.30

**802.11n ht20(2TX Non-beamforming mode was the worst):**

Frequency (MHz)	Receiver		Polar (H/V)	Factor (dB/m)	Result (dB $\mu$ V/m)	Limit (dB $\mu$ V/m)	Margin (dB)
	Reading (dB $\mu$ V)	Detector					
Low Channel: 5180MHz							
5180.000	69.65	PK	H	38.68	102.31	N/A	N/A
5180.000	59.36	AV	H	38.68	92.02	N/A	N/A
5180.000	79.97	PK	V	38.68	112.63	N/A	N/A
5180.000	69.51	AV	V	38.68	102.17	N/A	N/A
5150.000	34.40	PK	V	38.64	67.02	74.00	6.98
5150.000	19.86	AV	V	38.64	52.48	54.00	1.52
10360.000	33.34	PK	V	19.18	46.50	68.20	21.70
15540.000	40.69	PK	V	22.44	57.11	74.00	16.89
15540.000	28.35	AV	V	22.44	44.77	54.00	9.23
Middle Channel: 5200 MHz							
5200.000	71.58	PK	H	38.70	104.26	N/A	N/A
5200.000	61.47	AV	H	38.70	94.15	N/A	N/A
5200.000	83.68	PK	V	38.70	116.36	N/A	N/A
5200.000	73.02	AV	V	38.70	105.70	N/A	N/A
10400.000	33.72	PK	V	19.16	46.86	68.20	21.34
15600.000	49.12	PK	V	22.41	65.51	74.00	8.49
15600.000	36.06	AV	V	22.41	52.45	54.00	1.55
High Channel: 5240 MHz							
5240.000	71.54	PK	H	38.85	104.37	N/A	N/A
5240.000	61.23	AV	H	38.85	94.06	N/A	N/A
5240.000	83.53	PK	V	38.85	116.36	N/A	N/A
5240.000	73.07	AV	V	38.85	105.90	N/A	N/A
5350.000	29.56	PK	V	39.03	62.57	74.00	11.43
5350.000	16.64	AV	V	39.03	49.65	54.00	4.35
10480.000	40.17	PK	V	18.86	53.01	68.20	15.19
15720.000	48.85	PK	V	22.28	65.11	74.00	8.89
15720.000	35.43	AV	V	22.28	51.69	54.00	2.31

**802.11n ht40(2TX Non-beamforming mode was the worst):**

Frequency (MHz)	Receiver		Polar (H/V)	Factor (dB/m)	Result (dB $\mu$ V/m)	Limit (dB $\mu$ V/m)	Margin (dB)
	Reading (dB $\mu$ V)	Detector					
Low Channel: 5190MHz							
5190.000	67.46	PK	H	38.69	100.13	N/A	N/A
5190.000	57.22	AV	H	38.69	89.89	N/A	N/A
5190.000	77.18	PK	V	38.69	109.85	N/A	N/A
5190.000	67.83	AV	V	38.69	100.50	N/A	N/A
5150.000	36.44	PK	V	38.64	69.06	74.00	4.94
5150.000	20.07	AV	V	38.64	52.69	54.00	1.31
10380.000	33.45	PK	V	19.17	46.60	68.20	21.60
15570.000	37.41	PK	V	22.43	53.82	74.00	20.18
15570.000	24.21	AV	V	22.43	40.62	54.00	13.38
High Channel: 5230 MHz							
5230.000	72.05	PK	H	38.81	104.84	N/A	N/A
5230.000	62.41	AV	H	38.81	95.20	N/A	N/A
5230.000	81.86	PK	V	38.81	114.65	N/A	N/A
5230.000	71.47	AV	V	38.81	104.26	N/A	N/A
5350.000	31.61	PK	V	39.03	64.62	74.00	9.38
5350.000	17.28	AV	V	39.03	50.29	54.00	3.71
10460.000	34.64	PK	V	18.94	47.56	68.20	20.64
15690.000	47.78	PK	V	22.29	64.05	74.00	9.95
15690.000	34.39	AV	V	22.29	50.66	54.00	3.34

**802.11ac vht20(2TX Non-beamforming mode was the worst):**

Frequency (MHz)	Receiver		Polar (H/V)	Factor (dB/m)	Result (dB $\mu$ V/m)	Limit (dB $\mu$ V/m)	Margin (dB)
	Reading (dB $\mu$ V)	Detector					
Low Channel: 5180MHz							
5180.000	70.97	PK	H	38.68	103.63	N/A	N/A
5180.000	60.51	AV	H	38.68	93.17	N/A	N/A
5180.000	80.96	PK	V	38.68	113.62	N/A	N/A
5180.000	70.42	AV	V	38.68	103.08	N/A	N/A
5150.000	34.68	PK	V	38.64	67.30	74.00	6.70
5150.000	18.94	AV	V	38.64	51.56	54.00	2.44
10360.000	37.11	PK	V	19.18	50.27	68.20	17.93
15540.000	45.44	PK	V	22.44	61.86	74.00	12.14
15540.000	32.22	AV	V	22.44	48.64	54.00	5.36
Middle Channel: 5200 MHz							
5200.000	71.93	PK	H	38.70	104.61	N/A	N/A
5200.000	61.29	AV	H	38.70	93.97	N/A	N/A
5200.000	84.49	PK	V	38.70	117.17	N/A	N/A
5200.000	74.28	AV	V	38.70	106.96	N/A	N/A
10400.000	34.69	PK	V	19.16	47.83	68.20	20.37
15600.000	48.58	PK	V	22.41	64.97	74.00	9.03
15600.000	35.29	AV	V	22.41	51.68	54.00	2.32
High Channel: 5240 MHz							
5240.000	72.16	PK	H	38.85	104.99	N/A	N/A
5240.000	62.63	AV	H	38.85	95.46	N/A	N/A
5240.000	84.33	PK	V	38.85	117.16	N/A	N/A
5240.000	74.36	AV	V	38.85	107.19	N/A	N/A
5350.000	29.39	PK	V	39.03	62.40	74.00	11.60
5350.000	16.60	AV	V	39.03	49.61	54.00	4.39
10480.000	41.59	PK	V	18.86	54.43	68.20	13.77
15720.000	48.07	PK	V	22.28	64.33	74.00	9.67
15720.000	35.03	AV	V	22.28	51.29	54.00	2.71

**802.11ac vht40((2TX Non-beamforming mode was the worst):**

Frequency (MHz)	Receiver		Polar (H/V)	Factor (dB/m)	Result (dB $\mu$ V/m)	Limit (dB $\mu$ V/m)	Margin (dB)
	Reading (dB $\mu$ V)	Detector					
Low Channel: 5190 MHz							
5190.000	65.91	PK	H	38.69	98.58	N/A	N/A
5190.000	55.47	AV	H	38.69	88.14	N/A	N/A
5190.000	76.24	PK	V	38.69	108.91	N/A	N/A
5190.000	66.47	AV	V	38.69	99.14	N/A	N/A
5150.000	38.40	PK	V	38.64	71.02	74.00	2.98
5150.000	18.55	AV	V	38.64	51.17	54.00	2.83
10380.000	34.85	PK	V	19.17	48.00	68.20	20.20
15570.000	35.52	PK	V	22.43	51.93	74.00	22.07
15570.000	23.26	AV	V	22.43	39.67	54.00	14.33
High Channel: 5230 MHz							
5230.000	71.94	PK	H	38.81	104.73	N/A	N/A
5230.000	61.58	AV	H	38.81	94.37	N/A	N/A
5230.000	82.57	PK	V	38.81	115.36	N/A	N/A
5230.000	72.10	AV	V	38.81	104.89	N/A	N/A
5350.000	34.78	PK	V	39.03	67.79	74.00	6.21
5350.000	18.14	AV	V	39.03	51.15	54.00	2.85
10460.000	36.45	PK	V	18.94	49.37	68.20	18.83
15690.000	48.71	PK	V	22.29	64.98	74.00	9.02
15690.000	35.36	AV	V	22.29	51.63	54.00	2.37

**802.11ac vht80(2TX Non-beamforming mode was the worst):**

Frequency (MHz)	Receiver		Polar (H/V)	Factor (dB/m)	Result (dB $\mu$ V/m)	Limit (dB $\mu$ V/m)	Margin (dB)
	Reading (dB $\mu$ V)	Detector					
Middle Channel: 5210 MHz							
5210.000	63.31	PK	H	38.74	96.03	N/A	N/A
5210.000	53.46	AV	H	38.74	86.18	N/A	N/A
5210.000	73.25	PK	V	38.74	105.97	N/A	N/A
5210.000	63.44	AV	V	38.74	96.16	N/A	N/A
5150.000	36.95	PK	V	38.64	69.57	74.00	4.43
5150.000	17.92	AV	V	38.64	50.54	54.00	3.46
5350.000	29.38	PK	V	39.03	62.39	74.00	11.61
5350.000	16.62	AV	V	39.03	49.63	54.00	4.37
10420.000	34.51	PK	V	19.09	47.58	68.20	20.62
15630.000	45.63	PK	V	22.37	61.98	74.00	12.02
15630.000	33.32	AV	V	22.37	49.67	54.00	4.33

**802.11ax hew20(2TX Non-beamforming mode was the worst):**

Frequency (MHz)	Receiver		Polar (H/V)	Factor (dB/m)	Result (dB $\mu$ V/m)	Limit (dB $\mu$ V/m)	Margin (dB)
	Reading (dB $\mu$ V)	Detector					
Low Channel: 5180MHz							
5180.000	71.71	PK	H	38.68	104.37	N/A	N/A
5180.000	61.34	AV	H	38.68	94.00	N/A	N/A
5180.000	82.17	PK	V	38.68	114.83	N/A	N/A
5180.000	72.79	AV	V	38.68	105.45	N/A	N/A
5150.000	39.29	PK	V	38.64	71.91	74.00	2.09
5150.000	20.15	AV	V	38.64	52.77	54.00	1.23
10360.000	33.57	PK	V	19.18	46.73	68.20	21.47
15540.000	48.54	PK	V	22.44	64.96	74.00	9.04
15540.000	35.27	AV	V	22.44	51.69	54.00	2.31
Middle Channel: 5200 MHz							
5200.000	71.63	PK	H	38.70	104.31	N/A	N/A
5200.000	61.74	AV	H	38.70	94.42	N/A	N/A
5200.000	84.12	PK	V	38.70	116.80	N/A	N/A
5200.000	74.31	AV	V	38.70	106.99	N/A	N/A
10400.000	34.01	PK	V	19.16	47.15	68.20	21.05
15600.000	49.41	PK	V	22.41	65.80	74.00	8.20
15600.000	36.21	AV	V	22.41	52.60	54.00	1.40
High Channel: 5240 MHz							
5240.000	72.83	PK	H	38.85	105.66	N/A	N/A
5240.000	62.41	AV	H	38.85	95.24	N/A	N/A
5240.000	84.06	PK	V	38.85	116.89	N/A	N/A
5240.000	74.22	AV	V	38.85	107.05	N/A	N/A
5350.000	29.49	PK	V	39.03	62.50	74.00	11.50
5350.000	16.61	AV	V	39.03	49.62	54.00	4.38
10480.000	41.81	PK	V	18.86	54.65	68.20	13.55
15720.000	48.32	PK	V	22.28	64.58	74.00	9.42
15720.000	35.16	AV	V	22.28	51.42	54.00	2.58



**802.11ax hew40((2TX Non-beamforming mode was the worst):**

Frequency (MHz)	Receiver		Polar (H/V)	Factor (dB/m)	Result (dB $\mu$ V/m)	Limit (dB $\mu$ V/m)	Margin (dB)
	Reading (dB $\mu$ V)	Detector					
Low Channel: 5190 MHz							
5190.000	67.10	PK	H	38.69	99.77	N/A	N/A
5190.000	57.42	AV	H	38.69	90.09	N/A	N/A
5190.000	77.39	PK	V	38.69	110.06	N/A	N/A
5190.000	67.16	AV	V	38.69	99.83	N/A	N/A
5150.000	39.83	PK	V	38.64	72.45	74.00	1.55
5150.000	19.88	AV	V	38.64	52.50	54.00	1.50
10380.000	36.12	PK	V	19.17	49.27	68.20	18.93
15570.000	40.56	PK	V	22.43	56.97	74.00	17.03
15570.000	27.28	AV	V	22.43	43.69	54.00	10.31
High Channel: 5230 MHz							
5230.000	71.70	PK	H	38.81	104.49	N/A	N/A
5230.000	61.36	AV	H	38.81	94.15	N/A	N/A
5230.000	81.52	PK	V	38.81	114.31	N/A	N/A
5230.000	71.07	AV	V	38.81	103.86	N/A	N/A
5350.000	31.83	PK	V	39.03	64.84	74.00	9.16
5350.000	17.22	AV	V	39.03	50.23	54.00	3.77
10460.000	33.95	PK	V	18.94	46.87	68.20	21.33
15690.000	46.56	PK	V	22.29	62.83	74.00	11.17
15690.000	33.28	AV	V	22.29	49.55	54.00	4.45

**802.11ax hew80(2TX Non-beamforming mode was the worst):**

Frequency (MHz)	Receiver		Polar (H/V)	Factor (dB/m)	Result (dB $\mu$ V/m)	Limit (dB $\mu$ V/m)	Margin (dB)
	Reading (dB $\mu$ V)	Detector					
Middle Channel: 5210 MHz							
5210.000	64.68	PK	H	38.74	97.40	N/A	N/A
5210.000	54.21	AV	H	38.74	86.93	N/A	N/A
5210.000	74.25	PK	V	38.74	106.97	N/A	N/A
5210.000	64.37	AV	V	38.74	97.09	N/A	N/A
5150.000	39.43	PK	V	38.64	72.05	74.00	1.95
5150.000	19.96	AV	V	38.64	52.58	54.00	1.42
5350.000	30.09	PK	V	39.03	63.10	74.00	10.90
5350.000	16.83	AV	V	39.03	49.84	54.00	4.16
10420.000	33.64	PK	V	19.09	46.71	68.20	21.49
15630.000	40.55	PK	V	22.37	56.90	74.00	17.10
15630.000	27.28	AV	V	22.37	43.63	54.00	10.37

Note:

Result = Reading + Factor- Distance extrapolation Factor

For 1-40GHz:

Distance extrapolation Factor =  $20 \log(\text{specific distance [3m]}/\text{test distance [1.5m]})$  dB = 6.02 dB

**5725-5850MHz:****802.11a, Chain 0:**

Frequency (MHz)	Receiver		Polar (H/V)	Factor (dB/m)	Result (dB $\mu$ V/m)	Limit (dB $\mu$ V/m)	Margin (dB)
	Reading (dB $\mu$ V)	Detector					
Low Channel: 5745MHz							
5745.000	73.97	PK	H	39.46	107.41	N/A	N/A
5745.000	63.58	AV	H	39.46	97.02	N/A	N/A
5745.000	79.38	PK	V	39.46	112.82	N/A	N/A
5745.000	69.81	AV	V	39.46	103.25	N/A	N/A
5725.000	54.44	PK	V	39.48	87.90	122.20	34.30
5720.000	42.68	PK	V	39.49	76.15	110.80	34.65
5700.000	37.15	PK	V	39.51	70.64	105.20	34.56
5650.000	30.00	PK	V	39.49	63.47	68.20	4.73
11490.000	36.45	PK	V	20.67	51.10	74.00	22.90
11490.000	24.23	AV	V	20.67	38.88	54.00	15.12
17235.000	42.38	PK	V	26.76	63.12	68.20	5.08
Middle Channel: 5785 MHz							
5785.000	73.57	PK	H	39.44	106.99	N/A	N/A
5785.000	63.43	AV	H	39.44	96.85	N/A	N/A
5785.000	78.79	PK	V	39.44	112.21	N/A	N/A
5785.000	68.42	AV	V	39.44	101.84	N/A	N/A
11570.000	35.81	PK	V	20.83	50.62	74.00	23.38
11570.000	23.41	AV	V	20.83	38.22	54.00	15.78
17355.000	37.54	PK	V	27.74	59.26	68.20	8.94
High Channel: 5825 MHz							
5825.000	73.60	PK	H	39.46	107.04	N/A	N/A
5825.000	63.12	AV	H	39.46	96.56	N/A	N/A
5825.000	78.22	PK	V	39.46	111.66	N/A	N/A
5825.000	68.50	AV	V	39.46	101.94	N/A	N/A
5850.000	45.29	PK	V	39.49	78.76	122.20	43.44
5855.000	42.78	PK	V	39.51	76.27	110.80	34.53
5875.000	36.70	PK	V	39.60	70.28	105.20	34.92
5925.000	31.31	PK	V	39.68	64.97	68.20	3.23
11650.000	36.84	PK	V	21.07	51.89	74.00	22.11
11650.000	24.42	AV	V	21.07	39.47	54.00	14.53
17475.000	35.76	PK	V	28.61	58.35	68.20	9.85

## 802.11a,Chain 1:

Frequency (MHz)	Receiver		Polar (H/V)	Factor (dB/m)	Result (dBµV/m)	Limit (dBµV/m)	Margin (dB)
	Reading (dBµV)	Detector					
Low Channel: 5745MHz							
5745.000	67.04	PK	H	39.46	100.48	N/A	N/A
5745.000	57.38	AV	H	39.46	90.82	N/A	N/A
5745.000	77.23	PK	V	39.46	110.67	N/A	N/A
5745.000	67.61	AV	V	39.46	101.05	N/A	N/A
5725.000	45.68	PK	V	39.48	79.14	122.20	43.06
5720.000	40.08	PK	V	39.49	73.55	110.80	37.25
5700.000	35.72	PK	V	39.51	69.21	105.20	35.99
5650.000	31.56	PK	V	39.49	65.03	68.20	3.17
11490.000	36.19	PK	V	20.67	50.84	74.00	23.16
11490.000	24.10	AV	V	20.67	38.75	54.00	15.25
17235.000	37.38	PK	V	26.76	58.12	68.20	10.08
Middle Channel: 5785 MHz							
5785.000	66.60	PK	H	39.44	100.02	N/A	N/A
5785.000	56.42	AV	H	39.44	89.84	N/A	N/A
5785.000	77.42	PK	V	39.44	110.84	N/A	N/A
5785.000	67.16	AV	V	39.44	100.58	N/A	N/A
11570.000	35.81	PK	V	20.83	50.62	74.00	23.38
11570.000	23.41	AV	V	20.83	38.22	54.00	15.78
17355.000	37.48	PK	V	27.74	59.20	68.20	9.00
High Channel: 5825 MHz							
5825.000	67.69	PK	H	39.46	101.13	N/A	N/A
5825.000	57.34	AV	H	39.46	90.78	N/A	N/A
5825.000	77.62	PK	V	39.46	111.06	N/A	N/A
5825.000	67.99	AV	V	39.46	101.43	N/A	N/A
5850.000	42.34	PK	V	39.49	75.81	122.20	46.39
5855.000	40.38	PK	V	39.51	73.87	110.80	36.93
5875.000	32.94	PK	V	39.60	66.52	105.20	38.68
5925.000	31.40	PK	V	39.68	65.06	68.20	3.14
11650.000	38.22	PK	V	21.07	53.27	74.00	20.73
11650.000	26.11	AV	V	21.07	41.16	54.00	12.84
17475.000	37.62	PK	V	28.61	60.21	68.20	7.99

**802.11n ht20(2TX Non-beamforming mode was the worst):**

Frequency (MHz)	Receiver		Polar (H/V)	Factor (dB/m)	Result (dB $\mu$ V/m)	Limit (dB $\mu$ V/m)	Margin (dB)
	Reading (dB $\mu$ V)	Detector					
Low Channel: 5745MHz							
5745.000	75.86	PK	H	39.46	109.30	N/A	N/A
5745.000	65.63	AV	H	39.46	99.07	N/A	N/A
5745.000	82.41	PK	V	39.46	115.85	N/A	N/A
5745.000	72.53	AV	V	39.46	105.97	N/A	N/A
5725.000	46.87	PK	V	39.48	80.33	122.20	41.87
5720.000	39.27	PK	V	39.49	72.74	110.80	38.06
5700.000	33.34	PK	V	39.51	66.83	105.20	38.37
5650.000	29.77	PK	V	39.49	63.24	68.20	4.96
11490.000	38.55	PK	V	20.67	53.20	74.00	20.80
11490.000	26.28	AV	V	20.67	40.93	54.00	13.07
17235.000	37.57	PK	V	26.76	58.31	68.20	9.89
Middle Channel: 5785 MHz							
5785.000	75.19	PK	H	39.44	108.61	N/A	N/A
5785.000	65.47	AV	H	39.44	98.89	N/A	N/A
5785.000	80.97	PK	V	39.44	114.39	N/A	N/A
5785.000	70.29	AV	V	39.44	103.71	N/A	N/A
11570.000	35.42	PK	V	20.83	50.23	74.00	23.77
11570.000	23.21	AV	V	20.83	38.02	54.00	15.98
17355.000	39.63	PK	V	27.74	61.35	68.20	6.85
High Channel: 5825 MHz							
5825.000	74.32	PK	H	39.46	107.76	N/A	N/A
5825.000	64.20	AV	H	39.46	97.64	N/A	N/A
5825.000	80.40	PK	V	39.46	113.84	N/A	N/A
5825.000	70.23	AV	V	39.46	103.67	N/A	N/A
5850.000	42.15	PK	V	39.49	75.62	122.20	46.58
5855.000	39.71	PK	V	39.51	73.20	110.80	37.60
5875.000	31.99	PK	V	39.60	65.57	105.20	39.63
5925.000	31.97	PK	V	39.68	65.63	68.20	2.57
11650.000	39.14	PK	V	21.07	54.19	74.00	19.81
11650.000	27.07	AV	V	21.07	42.12	54.00	11.88
17475.000	35.65	PK	V	28.61	58.24	68.20	9.96

**802.11n ht40(2TX Non-beamforming mode was the worst):**

Frequency (MHz)	Receiver		Polar (H/V)	Factor (dB/m)	Result (dB $\mu$ V/m)	Limit (dB $\mu$ V/m)	Margin (dB)
	Reading (dB $\mu$ V)	Detector					
Low Channel: 5755 MHz							
5755.000	72.21	PK	H	39.45	105.64	N/A	N/A
5755.000	62.34	AV	H	39.45	95.77	N/A	N/A
5755.000	78.64	PK	V	39.45	112.07	N/A	N/A
5755.000	68.12	AV	V	39.45	101.55	N/A	N/A
5725.000	45.91	PK	V	39.48	79.37	122.20	42.83
5720.000	51.42	PK	V	39.49	84.89	110.80	25.91
5700.000	35.47	PK	V	39.51	68.96	105.20	36.24
5650.000	30.21	PK	V	39.49	63.68	68.20	4.52
11510.000	34.42	PK	V	20.67	49.07	74.00	24.93
11510.000	22.21	AV	V	20.67	36.86	54.00	17.14
17265.000	37.09	PK	V	26.94	58.01	68.20	10.19
High Channel: 5795 MHz							
5795.000	71.99	PK	H	39.43	105.40	N/A	N/A
5795.000	61.67	AV	H	39.43	95.08	N/A	N/A
5795.000	82.13	PK	V	39.43	115.54	N/A	N/A
5795.000	72.36	AV	V	39.43	105.77	N/A	N/A
5850.000	43.36	PK	V	39.49	76.83	122.20	45.37
5855.000	39.82	PK	V	39.51	73.31	110.80	37.49
5875.000	36.28	PK	V	39.60	69.86	105.20	35.34
5925.000	31.83	PK	V	39.68	65.49	68.20	2.71
11590.000	36.49	PK	V	20.88	51.35	74.00	22.65
11590.000	24.25	AV	V	20.88	39.11	54.00	14.89
17385.000	34.63	PK	V	28.07	56.68	68.20	11.52

**802.11ac vht20(2TX Non-beamforming mode was the worst):**

Frequency (MHz)	Receiver		Polar (H/V)	Factor (dB/m)	Result (dB $\mu$ V/m)	Limit (dB $\mu$ V/m)	Margin (dB)
	Reading (dB $\mu$ V)	Detector					
Low Channel: 5745MHz							
5745.000	74.49	PK	H	39.46	107.93	N/A	N/A
5745.000	64.55	AV	H	39.46	97.99	N/A	N/A
5745.000	82.55	PK	V	39.46	115.99	N/A	N/A
5745.000	72.43	AV	V	39.46	105.87	N/A	N/A
5725.000	50.62	PK	V	39.48	84.08	122.20	38.12
5720.000	44.67	PK	V	39.49	78.14	110.80	32.66
5700.000	35.73	PK	V	39.51	69.22	105.20	35.98
5650.000	30.59	PK	V	39.49	64.06	68.20	4.14
11490.000	40.58	PK	V	20.67	55.23	74.00	18.77
11490.000	28.29	AV	V	20.67	42.94	54.00	11.06
17235.000	40.71	PK	V	26.76	61.45	68.20	6.75
Middle Channel: 5785 MHz							
5785.000	74.09	PK	H	39.44	107.51	N/A	N/A
5785.000	64.12	AV	H	39.44	97.54	N/A	N/A
5785.000	82.10	PK	V	39.44	115.52	N/A	N/A
5785.000	72.37	AV	V	39.44	105.79	N/A	N/A
11570.000	38.15	PK	V	20.83	52.96	74.00	21.04
11570.000	26.08	AV	V	20.83	40.89	54.00	13.11
17355.000	41.09	PK	V	27.74	62.81	68.20	5.39
High Channel: 5825 MHz							
5825.000	73.91	PK	H	39.46	107.35	N/A	N/A
5825.000	63.30	AV	H	39.46	96.74	N/A	N/A
5825.000	80.92	PK	V	39.46	114.36	N/A	N/A
5825.000	70.64	AV	V	39.46	104.08	N/A	N/A
5850.000	45.53	PK	V	39.49	79.00	122.20	43.20
5855.000	40.00	PK	V	39.51	73.49	110.80	37.31
5875.000	34.45	PK	V	39.60	68.03	105.20	37.17
5925.000	31.19	PK	V	39.68	64.85	68.20	3.35
11650.000	39.64	PK	V	21.07	54.69	74.00	19.31
11650.000	27.32	AV	V	21.07	42.37	54.00	11.63
17475.000	36.69	PK	V	28.61	59.28	68.20	8.92

**802.11ac vht40(2TX Non-beamforming mode was the worst):**

Frequency (MHz)	Receiver		Polar (H/V)	Factor (dB/m)	Result (dB $\mu$ V/m)	Limit (dB $\mu$ V/m)	Margin (dB)
	Reading (dB $\mu$ V)	Detector					
Low Channel: 5755 MHz							
5755.000	70.43	PK	H	39.45	103.86	N/A	N/A
5755.000	60.39	AV	H	39.45	93.82	N/A	N/A
5755.000	81.05	PK	V	39.45	114.48	N/A	N/A
5755.000	71.28	AV	V	39.45	104.71	N/A	N/A
5725.000	55.61	PK	V	39.48	89.07	122.20	33.13
5720.000	53.56	PK	V	39.49	87.03	110.80	23.77
5700.000	42.57	PK	V	39.51	76.06	105.20	29.14
5650.000	33.29	PK	V	39.49	66.76	68.20	1.44
11510.000	36.20	PK	V	20.67	50.85	74.00	23.15
11510.000	24.10	AV	V	20.67	38.75	54.00	15.25
17265.000	40.30	PK	V	26.94	61.22	68.20	6.98
High Channel: 5795 MHz							
5795.000	70.99	PK	H	39.43	104.40	N/A	N/A
5795.000	60.48	AV	H	39.43	93.89	N/A	N/A
5795.000	81.92	PK	V	39.43	115.33	N/A	N/A
5795.000	71.46	AV	V	39.43	104.87	N/A	N/A
5850.000	46.60	PK	V	39.49	80.07	122.20	42.13
5855.000	42.43	PK	V	39.51	75.92	110.80	34.88
5875.000	39.83	PK	V	39.60	73.41	105.20	31.79
5925.000	33.19	PK	V	39.68	66.85	68.20	1.35
11590.000	36.57	PK	V	20.88	51.43	74.00	22.57
11590.000	24.29	AV	V	20.88	39.15	54.00	14.85
17385.000	36.45	PK	V	28.07	58.50	68.20	9.70

**802.11ac vht80(2TX Non-beamforming mode was the worst):**

Frequency (MHz)	Receiver		Polar (H/V)	Factor (dB/m)	Result (dB $\mu$ V/m)	Limit (dB $\mu$ V/m)	Margin (dB)
	Reading (dB $\mu$ V)	Detector					
Middle Channel: 5775 MHz							
5775.000	65.47	PK	H	39.44	98.89	N/A	N/A
5775.000	55.29	AV	H	39.44	88.71	N/A	N/A
5775.000	74.01	PK	V	39.44	107.43	N/A	N/A
5775.000	64.38	AV	V	39.44	97.80	N/A	N/A
5725.000	45.62	PK	V	39.48	79.08	122.20	43.12
5720.000	45.37	PK	V	39.49	78.84	110.80	31.96
5700.000	45.87	PK	V	39.51	79.36	105.20	25.84
5650.000	33.30	PK	V	39.49	66.77	68.20	1.43
5850.000	44.87	PK	V	39.49	78.34	122.20	43.86
5855.000	43.94	PK	V	39.51	77.43	110.80	33.37
5875.000	41.80	PK	V	39.60	75.38	105.20	29.82
5925.000	31.69	PK	V	39.68	65.35	68.20	2.85
11550.000	33.74	PK	V	20.78	48.50	74.00	25.50
11550.000	21.37	AV	V	20.78	36.13	54.00	17.87
17325.000	34.41	PK	V	27.41	55.80	68.20	12.40



**802.11ax hew20(2TX Non-beamforming mode was the worst):**

Frequency (MHz)	Receiver		Polar (H/V)	Factor (dB/m)	Result (dB $\mu$ V/m)	Limit (dB $\mu$ V/m)	Margin (dB)
	Reading (dB $\mu$ V)	Detector					
Low Channel: 5745MHz							
5745.000	74.97	PK	H	39.46	108.41	N/A	N/A
5745.000	64.28	AV	H	39.46	97.72	N/A	N/A
5745.000	81.99	PK	V	39.46	115.43	N/A	N/A
5745.000	71.58	AV	V	39.46	105.02	N/A	N/A
5725.000	53.61	PK	V	39.48	87.07	122.20	35.13
5720.000	47.33	PK	V	39.49	80.80	110.80	30.00
5700.000	38.06	PK	V	39.51	71.55	105.20	33.65
5650.000	30.05	PK	V	39.49	63.52	68.20	4.68
11490.000	39.99	PK	V	20.67	54.64	74.00	19.36
11490.000	27.50	AV	V	20.67	42.15	54.00	11.85
17235.000	39.91	PK	V	26.76	60.65	68.20	7.55
Middle Channel: 5785 MHz							
5785.000	74.50	PK	H	39.44	107.92	N/A	N/A
5785.000	64.43	AV	H	39.44	97.85	N/A	N/A
5785.000	81.95	PK	V	39.44	115.37	N/A	N/A
5785.000	71.33	AV	V	39.44	104.75	N/A	N/A
11570.000	38.32	PK	V	20.83	53.13	74.00	20.87
11570.000	26.16	AV	V	20.83	40.97	54.00	13.03
17355.000	39.80	PK	V	27.74	61.52	68.20	6.68
High Channel: 5825 MHz							
5825.000	74.65	PK	H	39.46	108.09	N/A	N/A
5825.000	64.34	AV	H	39.46	97.78	N/A	N/A
5825.000	80.93	PK	V	39.46	114.37	N/A	N/A
5825.000	70.42	AV	V	39.46	103.86	N/A	N/A
5850.000	45.79	PK	V	39.49	79.26	122.20	42.94
5855.000	42.85	PK	V	39.51	76.34	110.80	34.46
5875.000	35.75	PK	V	39.60	69.33	105.20	35.87
5925.000	31.22	PK	V	39.68	64.88	68.20	3.32
11650.000	40.13	PK	V	21.07	55.18	74.00	18.82
11650.000	28.07	AV	V	21.07	43.12	54.00	10.88
17475.000	36.26	PK	V	28.61	58.85	68.20	9.35

**802.11ax hew40((2TX Non-beamforming mode was the worst):**

Frequency (MHz)	Receiver		Polar (H/V)	Factor (dB/m)	Result (dB $\mu$ V/m)	Limit (dB $\mu$ V/m)	Margin (dB)
	Reading (dB $\mu$ V)	Detector					
Low Channel: 5755 MHz							
5755.000	69.75	PK	H	39.45	103.18	N/A	N/A
5755.000	59.53	AV	H	39.45	92.96	N/A	N/A
5755.000	80.38	PK	V	39.45	113.81	N/A	N/A
5755.000	70.41	AV	V	39.45	103.84	N/A	N/A
5725.000	54.01	PK	V	39.48	87.47	122.20	34.73
5720.000	47.84	PK	V	39.49	81.31	110.80	29.49
5700.000	39.96	PK	V	39.51	73.45	105.20	31.75
5650.000	33.38	PK	V	39.49	66.85	68.20	1.35
11510.000	35.40	PK	V	20.67	50.05	74.00	23.95
11510.000	23.20	AV	V	20.67	37.85	54.00	16.15
17265.000	39.11	PK	V	26.94	60.03	68.20	8.17
High Channel: 5795 MHz							
5795.000	71.35	PK	H	39.43	104.76	N/A	N/A
5795.000	61.47	AV	H	39.43	94.88	N/A	N/A
5795.000	81.32	PK	V	39.43	114.73	N/A	N/A
5795.000	71.58	AV	V	39.43	104.99	N/A	N/A
5850.000	43.19	PK	V	39.49	76.66	122.20	45.54
5855.000	43.36	PK	V	39.51	76.85	110.80	33.95
5875.000	37.48	PK	V	39.60	71.06	105.20	34.14
5925.000	32.60	PK	V	39.68	66.26	68.20	1.94
11590.000	35.92	PK	V	20.88	50.78	74.00	23.22
11590.000	23.46	AV	V	20.88	38.32	54.00	15.68
17385.000	36.42	PK	V	28.07	58.47	68.20	9.73

**802.11ax hew80(2TX Non-beamforming mode was the worst):**

Frequency (MHz)	Receiver		Polar (H/V)	Factor (dB/m)	Result (dB $\mu$ V/m)	Limit (dB $\mu$ V/m)	Margin (dB)
	Reading (dB $\mu$ V)	Detector					
Middle Channel: 5775 MHz							
5775.000	66.89	PK	H	39.44	100.31	N/A	N/A
5775.000	56.31	AV	H	39.44	89.73	N/A	N/A
5775.000	73.53	PK	V	39.44	106.95	N/A	N/A
5775.000	63.25	AV	V	39.44	96.67	N/A	N/A
5725.000	42.76	PK	V	39.48	76.22	122.20	45.98
5720.000	41.54	PK	V	39.49	75.01	110.80	35.79
5700.000	41.27	PK	V	39.51	74.76	105.20	30.44
5650.000	32.98	PK	V	39.49	66.45	68.20	1.75
5850.000	38.85	PK	V	39.49	72.32	122.20	49.88
5855.000	40.46	PK	V	39.51	73.95	110.80	36.85
5875.000	38.06	PK	V	39.60	71.64	105.20	33.56
5925.000	31.85	PK	V	39.68	65.51	68.20	2.69
11550.000	34.22	PK	V	20.78	48.98	74.00	25.02
11550.000	22.11	AV	V	20.78	36.87	54.00	17.13
17325.000	35.36	PK	V	27.41	56.75	68.20	11.45

Note:

Result = Reading + Factor- Distance extrapolation Factor

For 1-40GHz:

Distance extrapolation Factor =  $20 \log(\text{specific distance [3m]}/\text{test distance [1.5m]})$  dB = 6.02 dB

**Worst Test plots(802.11a chain 0 5240 MHz was the worst)**

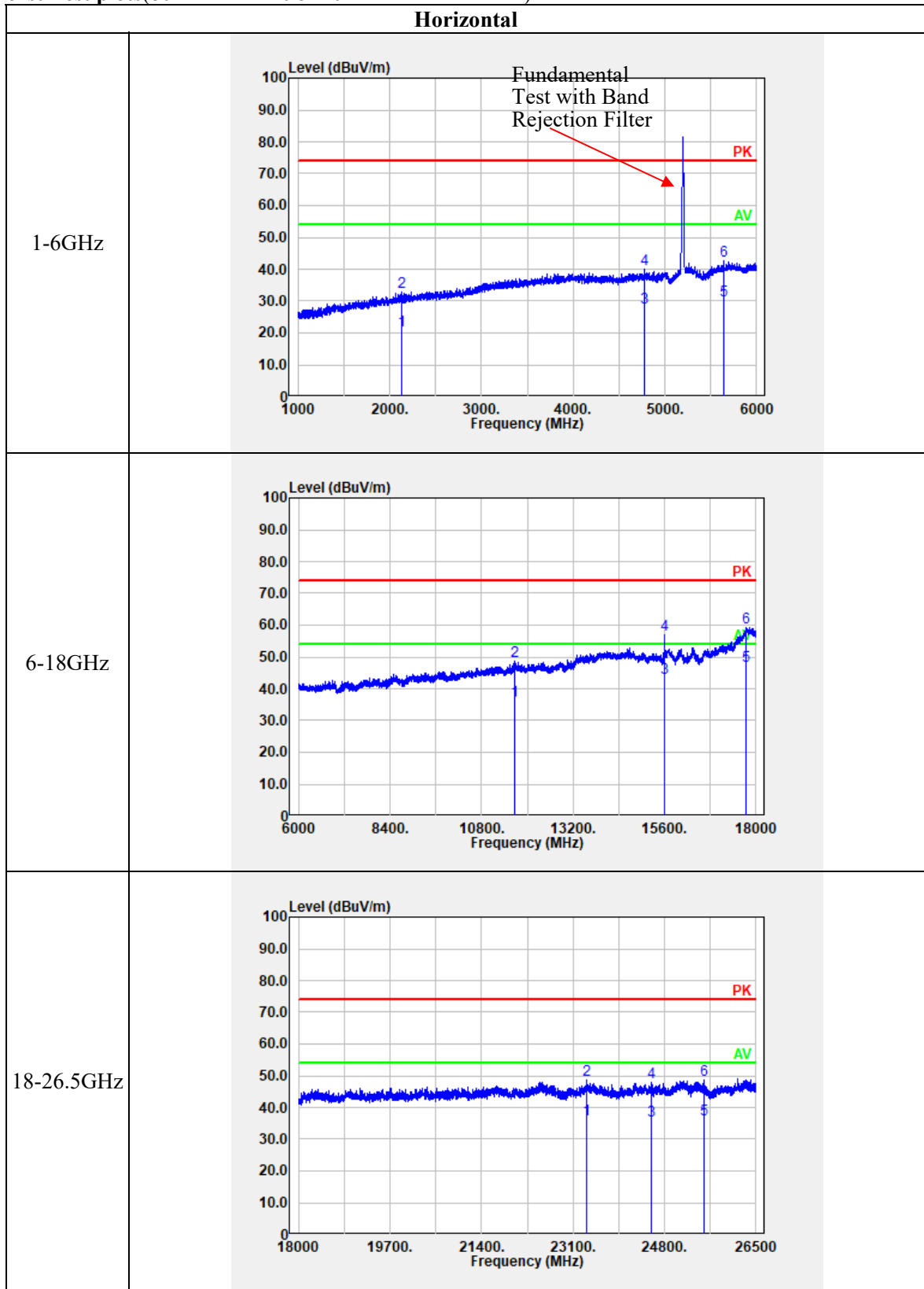

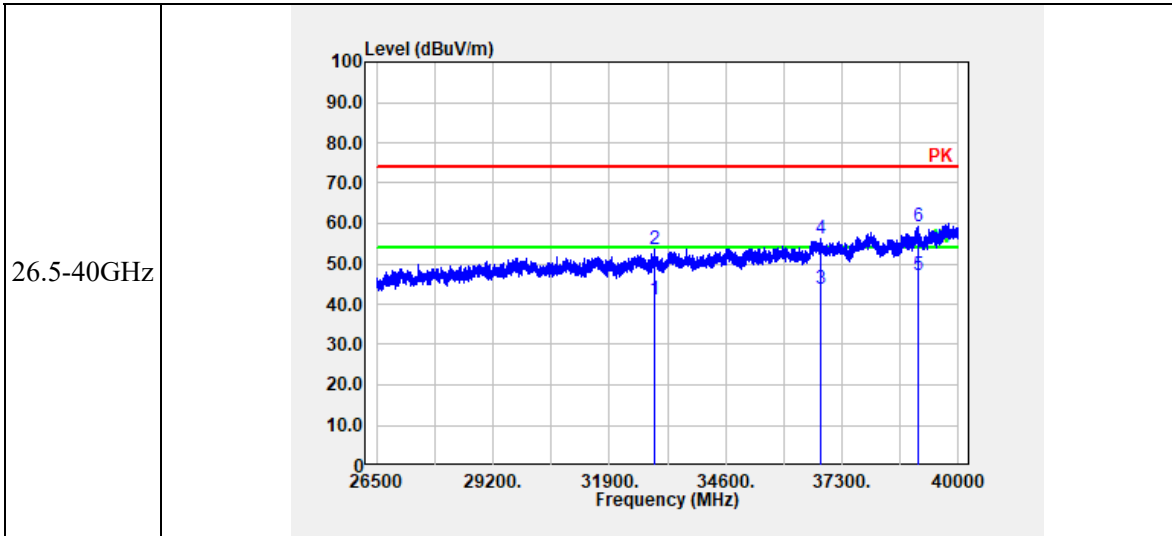

Vertical

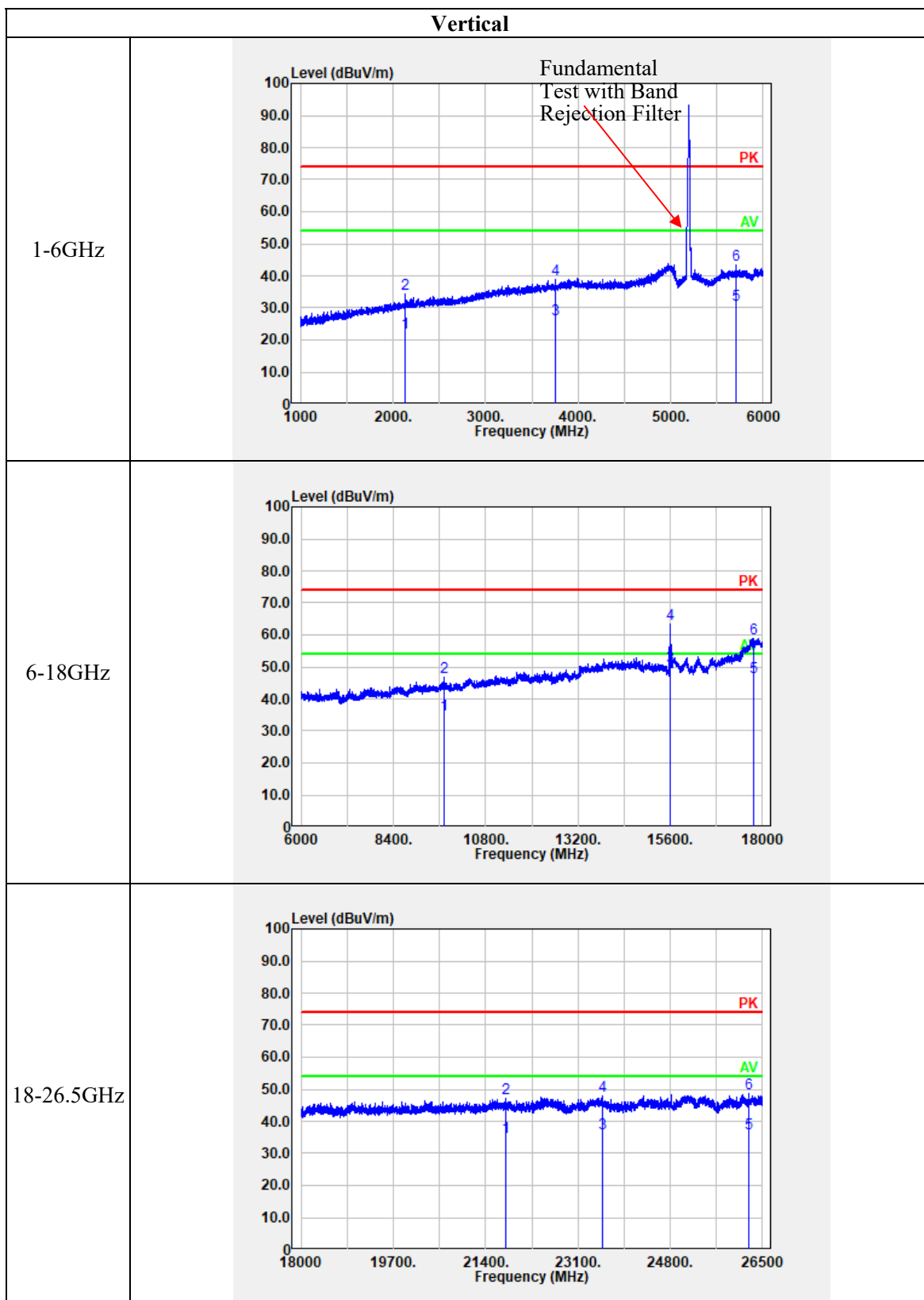

26.5-40GHz

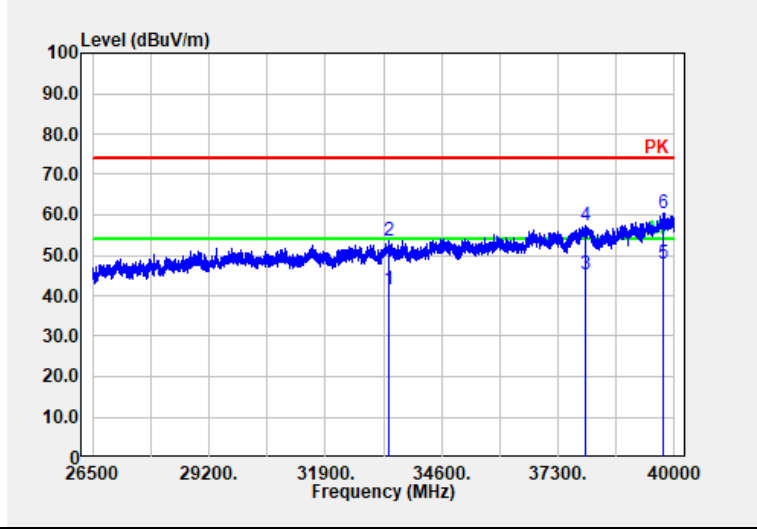

**4.3 Emission Bandwidth:**

Serial Number:	1ST2	Test Date:	2022/12/14~2022/12/30
Test Site:	RF	Test Mode:	Transmitting
Tester:	Arthur Su	Test Result:	Pass

**Environmental Conditions:**

Temperature: (°C)	21.3~22.4	Relative Humidity: (%)	38~41	ATM Pressure: (kPa)	101.4~102.1
----------------------	-----------	------------------------------	-------	------------------------	-------------

**Test Equipment List and Details:**

Manufacturer	Description	Model	Serial Number	Calibration Date	Calibration Due Date
R&S	Spectrum Analyzer	FSU26	200445	2022/04/05	2023/04/04
zhuoxiang	Coaxial Cable	SMA-178	211001	Each time	N/A
eastsheep	Coaxial Attenuator	2W-SMA-JK-18G	21060301	Each time	N/A

\* Statement of Traceability: China Certification ICT Co., Ltd (Dongguan) attests that all calibrations have been performed, traceable to National Primary Standards and International System of Units (SI).

**Test Data:**

5150-5250 MHz:

Test Modes	Test Frequency (MHz)	26 dB Bandwidth (MHz)	99% Occupied Bandwidth (MHz)
802.11a	5180	18.88	16.48
	5200	18.88	16.48
	5240	18.88	16.48
802.11n ht20	5180	19.84	17.6
	5200	19.84	17.6
	5240	19.84	17.6
802.11n ht40	5190	38.72	36.16
	5230	38.72	36.16
802.11ac vht20	5180	19.52	17.76
	5200	19.52	17.76
	5240	19.52	17.76
802.11ac vht40	5190	38.56	36.32
	5230	38.56	36.32
802.11ac vht80	5210	85.12	76.48
802.11ax hew20	5180	20.64	18.88
	5200	20.64	18.88
	5240	20.72	18.88
802.11ax hew40	5190	39.84	38.08
	5230	40	38.08
802.11ax hew80	5210	82.56	77.44

Note:

Test only was performed at Chain 0.

The 99% Occupied Bandwidth have not fall into the band 5250-5350MHz, please refer to the test plots of 99% Occupied Bandwidth.



## 5725-5850 MHz:

Test Modes	Test Frequency (MHz)	6 dB Bandwidth (MHz)	99% Occupied Bandwidth (MHz)
802.11a	5745	16.32	18.72
	5785	16.32	18.48
	5825	16.32	17.44
802.11n ht20	5745	17.12	17.84
	5785	17.28	17.92
	5825	17.12	17.84
802.11n ht40	5755	35.84	36.64
	5795	35.84	36.64
802.11ac vht20	5745	16.64	18.16
	5785	17.36	18.16
	5825	17.28	18.08
802.11ac vht40	5755	35.36	36.32
	5795	35.84	36.32
802.11ac vht80	5775	76.16	78.08
802.11ax hew20	5745	18	19.36
	5785	18.08	19.2
	5825	17.84	19.2
802.11ax hew40	5755	37.12	38.08
	5795	36.96	38.08
802.11ax hew80	5775	76.8	79.04

## Note:

6dB Emission Bandwidth Limit:  $\geq 0.5$  MHz

Test only was performed at Chain 0.

The 99% Occupied Bandwidth have not fall into the band 5470-5725MHz, please refer to the test plots of 99% Occupied Bandwidth.

5150-5250MHz:

<b>26dB Emission Bandwidth</b>	
802.11a Lowest Channel	<p>Ref 30 dBm * Att 25 dB RBW 300 kHz Delta 1 [T1] -0.18 dB          * VSW 1 MHz 18.88000000 MHz          SWT 20 ms          Marker 1 [T1] -20.25 dBm          5.17956000 GHz</p> <p>D1 5.67 dBm          D2 -18.33 dBm</p> <p>Center 5.18 GHz 4 MHz/ Span 40 MHz</p> <p>Date: 30.DEC.2022 08:06:23</p>
802.11a Middle Channel	<p>Ref 30 dBm * Att 25 dB RBW 300 kHz Delta 1 [T1] 0.42 dB          * VSW 1 MHz 18.88000000 MHz          SWT 20 ms          Marker 1 [T1] -20.60 dBm          5.19956000 GHz</p> <p>D1 5.82 dBm          D2 -18.18 dBm</p> <p>Center 5.2 GHz 4 MHz/ Span 40 MHz</p> <p>Date: 30.DEC.2022 08:07:08</p>
802.11a Highest Channel	<p>Ref 30 dBm * Att 25 dB RBW 300 kHz Delta 1 [T1] 0.49 dB          * VSW 1 MHz 18.88000000 MHz          SWT 20 ms          Marker 1 [T1] -21.08 dBm          5.23956000 GHz</p> <p>D1 6.08 dBm          D2 -18.02 dBm</p> <p>Center 5.24 GHz 4 MHz/ Span 40 MHz</p> <p>Date: 30.DEC.2022 08:07:59</p>

### 26dB Emission Bandwidth

<p>802.11n ht20 Lowest Channel</p>	<p>Date: 30.DEC.2022 08:10:25</p>
<p>802.11n ht20 Middle Channel</p>	<p>Date: 30.DEC.2022 08:09:38</p>
<p>802.11n ht20 Highest Channel</p>	<p>Date: 30.DEC.2022 08:08:47</p>

### 26dB Emission Bandwidth

<p>802.11n ht40 Lowest Channel</p>	<p>Date: 30.DEC.2022 08:14:04</p>
<p>802.11n ht40 Highest Channel</p>	<p>Date: 30.DEC.2022 08:14:54</p>

### 26dB Emission Bandwidth

<p>802.11ac vht20 Lowest Channel</p>	<p>Date: 30.DEC.2022 08:11:22</p>
<p>802.11ac vht20 Middle Channel</p>	<p>Date: 30.DEC.2022 08:12:06</p>
<p>802.11ac vht20 Highest Channel</p>	<p>Date: 30.DEC.2022 08:12:42</p>

### 26dB Emission Bandwidth

<p>802.11ac vht40 Lowest Channel</p>	<p>Date: 30.DEC.2022 08:17:11</p>
<p>802.11ac vht40 Highest Channel</p>	<p>Date: 30.DEC.2022 08:15:57</p>
<p>802.11ac vht80 Middle Channel</p>	<p>Date: 30.DEC.2022 08:19:22</p>

### 26dB Emission Bandwidth

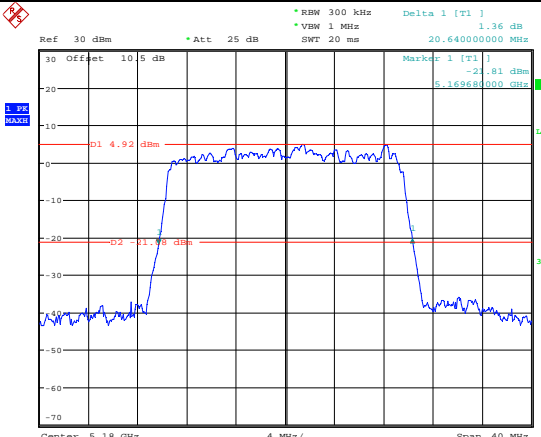
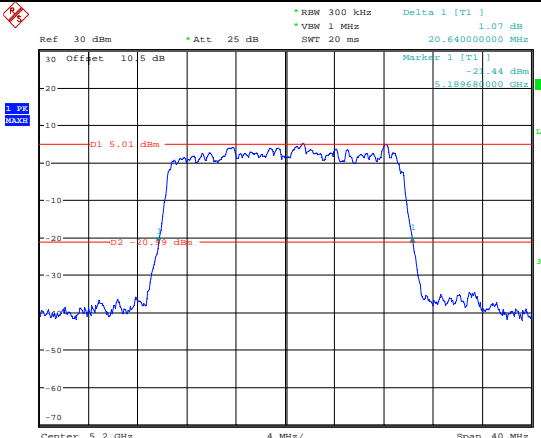
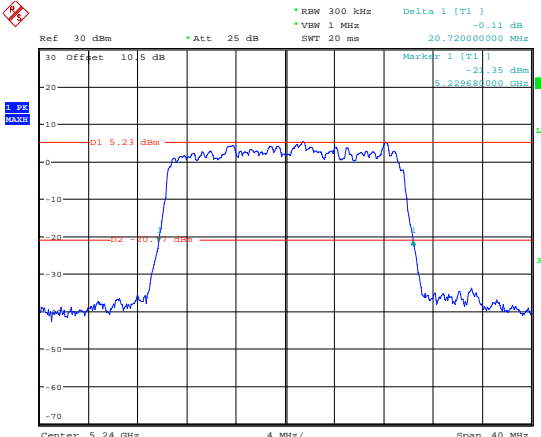
<p>802.11ax hew20 Lowest Channel</p>	 <p>Ref 30 dBm * Att 25 dB * RBW 300 kHz Delta 1 [T1] 1.36 dB * VBW 1 MHz 20.640000000 MHz SWT 20 ms</p> <p>30 Offset 10.5 dB Marker 1 [T1] -21.81 dBm 5.169680000 GHz</p> <p>D1 4.92 dBm D2 -21.81 dBm</p> <p>Center 5.18 GHz 4 MHz/ Span 40 MHz</p> <p>Date: 30.DEC.2022 07:50:48</p>
<p>802.11ax hew20 Middle Channel</p>	 <p>Ref 30 dBm * Att 25 dB * RBW 300 kHz Delta 1 [T1] 1.07 dB * VBW 1 MHz 20.640000000 MHz SWT 20 ms</p> <p>30 Offset 10.5 dB Marker 1 [T1] -21.44 dBm 5.189680000 GHz</p> <p>D1 5.01 dBm D2 -21.44 dBm</p> <p>Center 5.2 GHz 4 MHz/ Span 40 MHz</p> <p>Date: 30.DEC.2022 07:52:13</p>
<p>802.11ax hew20 Highest Channel</p>	 <p>Ref 30 dBm * Att 25 dB * RBW 300 kHz Delta 1 [T1] -0.11 dB * VBW 1 MHz 20.720000000 MHz SWT 20 ms</p> <p>30 Offset 10.5 dB Marker 1 [T1] -21.95 dBm 5.229680000 GHz</p> <p>D1 5.23 dBm D2 -21.95 dBm</p> <p>Center 5.24 GHz 4 MHz/ Span 40 MHz</p> <p>Date: 30.DEC.2022 07:53:01</p>

### 26dB Emission Bandwidth

<p>802.11ax hew40 Lowest Channel</p>	<p>Date: 30.DEC.2022 07:54:02</p>
<p>802.11ax hew40 Highest Channel</p>	<p>Date: 30.DEC.2022 07:54:40</p>
<p>802.11ax hew80 Middle Channel</p>	<p>Date: 30.DEC.2022 07:55:55</p>



**99% Emission Bandwidth**

<p>802.11a Lowest Channel</p>	<p>Ref 30 dBm * Att 25 dB * RBW 300 kHz Marker 1 [T1] 5.63 dBm          * VBW 1 MHz 5.175840000 GHz          * SWT 20 ms</p> <p>30 Offset 10 5 dB</p> <p>OBW 5.480000000 MHz          Temp 1 [T1] 0dBW -1.21 dBm          5.171760000 GHz          Temp 2 [T1] 0dBW -1.34 dBm          5.188240000 GHz</p> <p>Center 5.18 GHz 4 MHz/ Span 40 MHz</p> <p>Date: 30.DEC.2022 08:06:38</p>
<p>802.11a Middle Channel</p>	<p>Ref 30 dBm * Att 25 dB * RBW 300 kHz Marker 1 [T1] 5.79 dBm          * VBW 1 MHz 5.195840000 GHz          * SWT 20 ms</p> <p>30 Offset 10 5 dB</p> <p>OBW 5.480000000 MHz          Temp 1 [T1] 0dBW -1.17 dBm          5.191760000 GHz          Temp 2 [T1] 0dBW -1.34 dBm          5.208240000 GHz</p> <p>Center 5.2 GHz 4 MHz/ Span 40 MHz</p> <p>Date: 30.DEC.2022 08:07:23</p>
<p>802.11a Highest Channel</p>	<p>Ref 30 dBm * Att 25 dB * RBW 300 kHz Marker 1 [T1] 6.07 dBm          * VBW 1 MHz 5.235840000 GHz          * SWT 20 ms</p> <p>30 Offset 10 5 dB</p> <p>OBW 5.480000000 MHz          Temp 1 [T1] 0dBW -1.42 dBm          5.231760000 GHz          Temp 2 [T1] 0dBW -1.38 dBm          5.248240000 GHz</p> <p>Center 5.24 GHz 4 MHz/ Span 40 MHz</p> <p>Date: 30.DEC.2022 08:08:11</p>

**99% Emission Bandwidth**

<p>802.11n ht20 Lowest Channel</p>	<p>Ref 30 dBm *Att 25 dB *RBW 300 kHz Marker 1 [T1] 4.64 dBm          *VBW 1 MHz 5.174240000 GHz          *SWT 20 ms</p> <p>30 Offset 10 5 dB</p> <p>OBW 7.600000000 MHz          Temp 1 [T1] 0.42 dBm          5.171200000 GHz          Temp 2 [T1] 0.50 dBm          5.188800000 GHz</p> <p>Center 5.18 GHz 4 MHz/ Span 40 MHz</p> <p>Date: 30.DEC.2022 08:10:40</p>
<p>802.11n ht20 Middle Channel</p>	<p>Ref 30 dBm *Att 25 dB *RBW 300 kHz Marker 1 [T1] 4.70 dBm          *VBW 1 MHz 5.194320000 GHz          *SWT 20 ms</p> <p>30 Offset 10 5 dB</p> <p>OBW 7.600000000 MHz          Temp 1 [T1] 0.54 dBm          5.191200000 GHz          Temp 2 [T1] 0.43 dBm          5.208800000 GHz</p> <p>Center 5.2 GHz 4 MHz/ Span 40 MHz</p> <p>Date: 30.DEC.2022 08:09:53</p>
<p>802.11n ht20 Highest Channel</p>	<p>Ref 30 dBm *Att 25 dB *RBW 300 kHz Marker 1 [T1] 5.16 dBm          *VBW 1 MHz 5.234320000 GHz          *SWT 20 ms</p> <p>30 Offset 10 5 dB</p> <p>OBW 7.600000000 MHz          Temp 1 [T1] 4.15 dBm          5.231200000 GHz          Temp 2 [T1] 4.33 dBm          5.248800000 GHz</p> <p>Center 5.24 GHz 4 MHz/ Span 40 MHz</p> <p>Date: 30.DEC.2022 08:09:02</p>

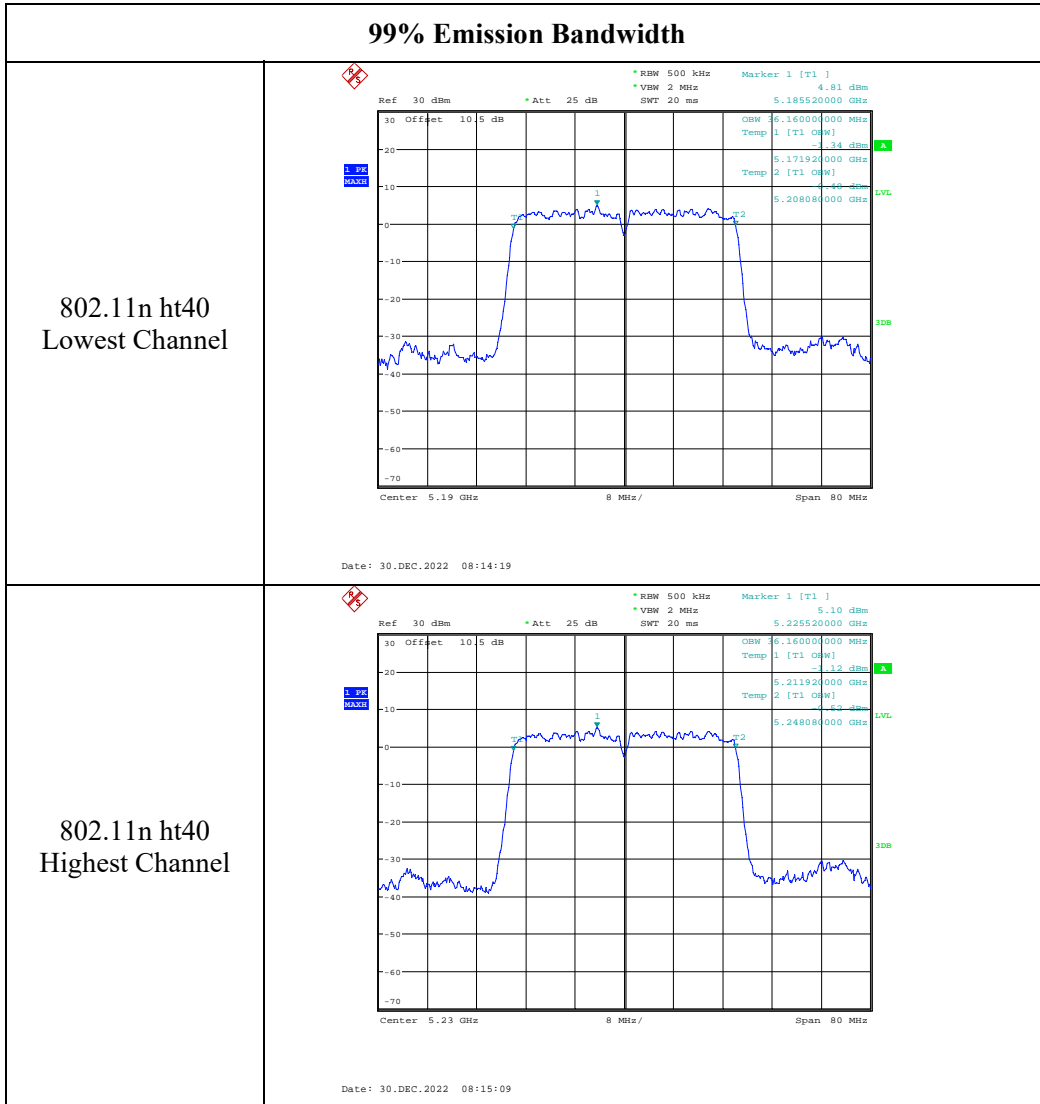

**99% Emission Bandwidth**

<p>802.11ac vht20 Lowest Channel</p>	<p>Ref 30 dBm * Att 25 dB * RBW 300 kHz Marker 1 [T1] 5.58 dBm * VBW 1 MHz 5.190640000 GHz SWT 20 ms</p> <p>30 Offset 10 5 dB</p> <p>OBW 7.760000000 MHz Temp 1 [T1] 0dBW -17 dBm 5.171120000 GHz Temp 2 [T1] 0dBW -30 dBm 5.188880000 GHz</p> <p>Center 5.18 GHz 4 MHz/ Span 40 MHz</p> <p>Date: 30.DEC.2022 08:11:34</p>
<p>802.11ac vht20 Middle Channel</p>	<p>Ref 30 dBm * Att 25 dB * RBW 300 kHz Marker 1 [T1] 5.57 dBm * VBW 1 MHz 5.200640000 GHz SWT 20 ms</p> <p>30 Offset 10 5 dB</p> <p>OBW 7.760000000 MHz Temp 1 [T1] 0dBW -17 dBm 5.191120000 GHz Temp 2 [T1] 0dBW -30 dBm 5.208880000 GHz</p> <p>Center 5.2 GHz 4 MHz/ Span 40 MHz</p> <p>Date: 30.DEC.2022 08:12:18</p>
<p>802.11ac vht20 Highest Channel</p>	<p>Ref 30 dBm * Att 25 dB * RBW 300 kHz Marker 1 [T1] 5.98 dBm * VBW 1 MHz 5.240640000 GHz SWT 20 ms</p> <p>30 Offset 10 5 dB</p> <p>OBW 7.760000000 MHz Temp 1 [T1] 0dBW -17 dBm 5.231120000 GHz Temp 2 [T1] 0dBW -30 dBm 5.248880000 GHz</p> <p>Center 5.24 GHz 4 MHz/ Span 40 MHz</p> <p>Date: 30.DEC.2022 08:12:54</p>

**99% Emission Bandwidth**

<p>802.11ac vht40 Lowest Channel</p>	<p>Date: 30.DEC.2022 08:17:22</p>
<p>802.11ac vht40 Highest Channel</p>	<p>Date: 30.DEC.2022 08:16:09</p>
<p>802.11ac vht80 Middle Channel</p>	<p>Date: 30.DEC.2022 08:19:37</p>

**99% Emission Bandwidth**

<p>802.11ax hew20 Lowest Channel</p>	<p>Ref 30 dBm * Att 25 dB * RBW 300 kHz Marker 1 [T1] 4.88 dBm          * VBW 1 MHz 5.181440000 GHz          * SWT 20 ms</p> <p>OSW 0.880000000 MHz          Temp 1 [T1 OSW] -1.91 dBm          5.170560000 GHz          Temp 2 [T1 OSW] -5.28 dBm          5.189440000 GHz</p> <p>Center 5.18 GHz 4 MHz/ Span 40 MHz</p> <p>Date: 30.DEC.2022 07:51:03</p>
<p>802.11ax hew20 Middle Channel</p>	<p>Ref 30 dBm * Att 25 dB * RBW 300 kHz Marker 1 [T1] 5.01 dBm          * VBW 1 MHz 5.201440000 GHz          * SWT 20 ms</p> <p>OSW 0.880000000 MHz          Temp 1 [T1 OSW] -1.87 dBm          5.190560000 GHz          Temp 2 [T1 OSW] -5.28 dBm          5.209440000 GHz</p> <p>Center 5.2 GHz 4 MHz/ Span 40 MHz</p> <p>Date: 30.DEC.2022 07:52:25</p>
<p>802.11ax hew20 Highest Channel</p>	<p>Ref 30 dBm * Att 25 dB * RBW 300 kHz Marker 1 [T1] 5.19 dBm          * VBW 1 MHz 5.241440000 GHz          * SWT 20 ms</p> <p>OSW 0.880000000 MHz          Temp 1 [T1 OSW] -1.42 dBm          5.230560000 GHz          Temp 2 [T1 OSW] -5.28 dBm          5.249440000 GHz</p> <p>Center 5.24 GHz 4 MHz/ Span 40 MHz</p> <p>Date: 30.DEC.2022 07:53:12</p>

**99% Emission Bandwidth**

<p>802.11ax hew40 Lowest Channel</p>	<p>Ref 30 dBm * Att 25 dB * RBW 500 kHz Marker 1 [T1] 4.29 dBm * VBW 2 MHz 5.193840000 GHz * SWT 20 ms</p> <p>30 Offset 10 5 dB</p> <p>OSW 8.080000000 MHz Temp 1 [T1] OSW] -1.93 dBm</p> <p>5.170960000 GHz Temp 2 [T1] OSW] -1.30 dBm</p> <p>5.209040000 GHz</p> <p>Center 5.19 GHz 8 MHz/ Span 80 MHz</p> <p>Date: 30.DEC.2022 07:54:14</p>
<p>802.11ax hew40 Highest Channel</p>	<p>Ref 30 dBm * Att 25 dB * RBW 500 kHz Marker 1 [T1] 4.43 dBm * VBW 2 MHz 5.233840000 GHz * SWT 20 ms</p> <p>30 Offset 10 5 dB</p> <p>OSW 8.080000000 MHz Temp 1 [T1] OSW] -1.00 dBm</p> <p>5.210960000 GHz Temp 2 [T1] OSW] -1.30 dBm</p> <p>5.249040000 GHz</p> <p>Center 5.23 GHz 8 MHz/ Span 80 MHz</p> <p>Date: 30.DEC.2022 07:54:52</p>
<p>802.11ax hew80 Middle Channel</p>	<p>Ref 30 dBm * Att 25 dB * RBW 1 MHz Marker 1 [T1] 3.85 dBm * VBW 3 MHz 5.218640000 GHz * SWT 20 ms</p> <p>30 Offset 10 5 dB</p> <p>OSW 7.440000000 MHz Temp 1 [T1] OSW] -1.51 dBm</p> <p>5.171280000 GHz Temp 2 [T1] OSW] -1.31 dBm</p> <p>5.248720000 GHz</p> <p>Center 5.21 GHz 16 MHz/ Span 160 MHz</p> <p>Date: 30.DEC.2022 07:56:10</p>

5725-5850MHz:

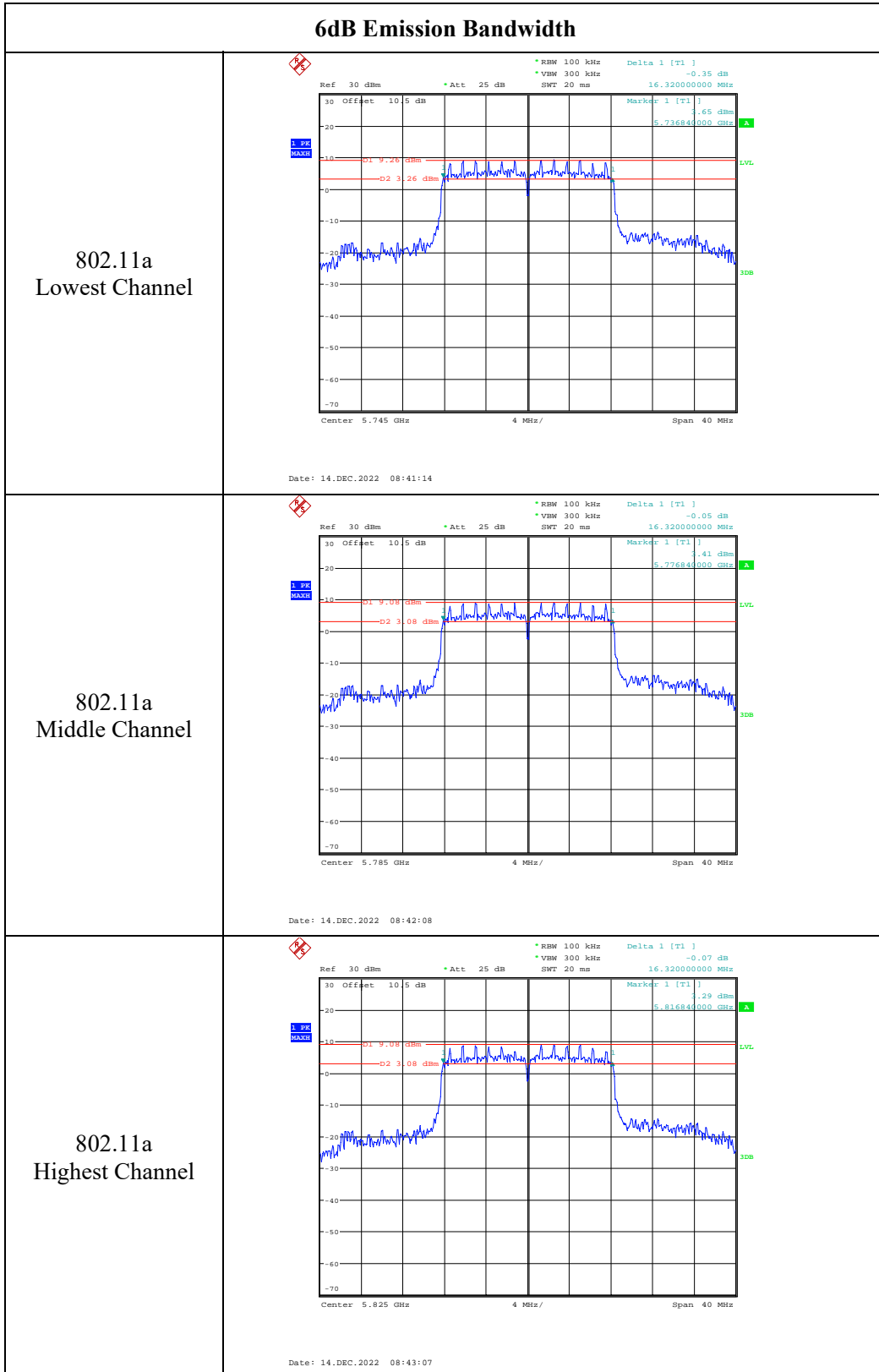



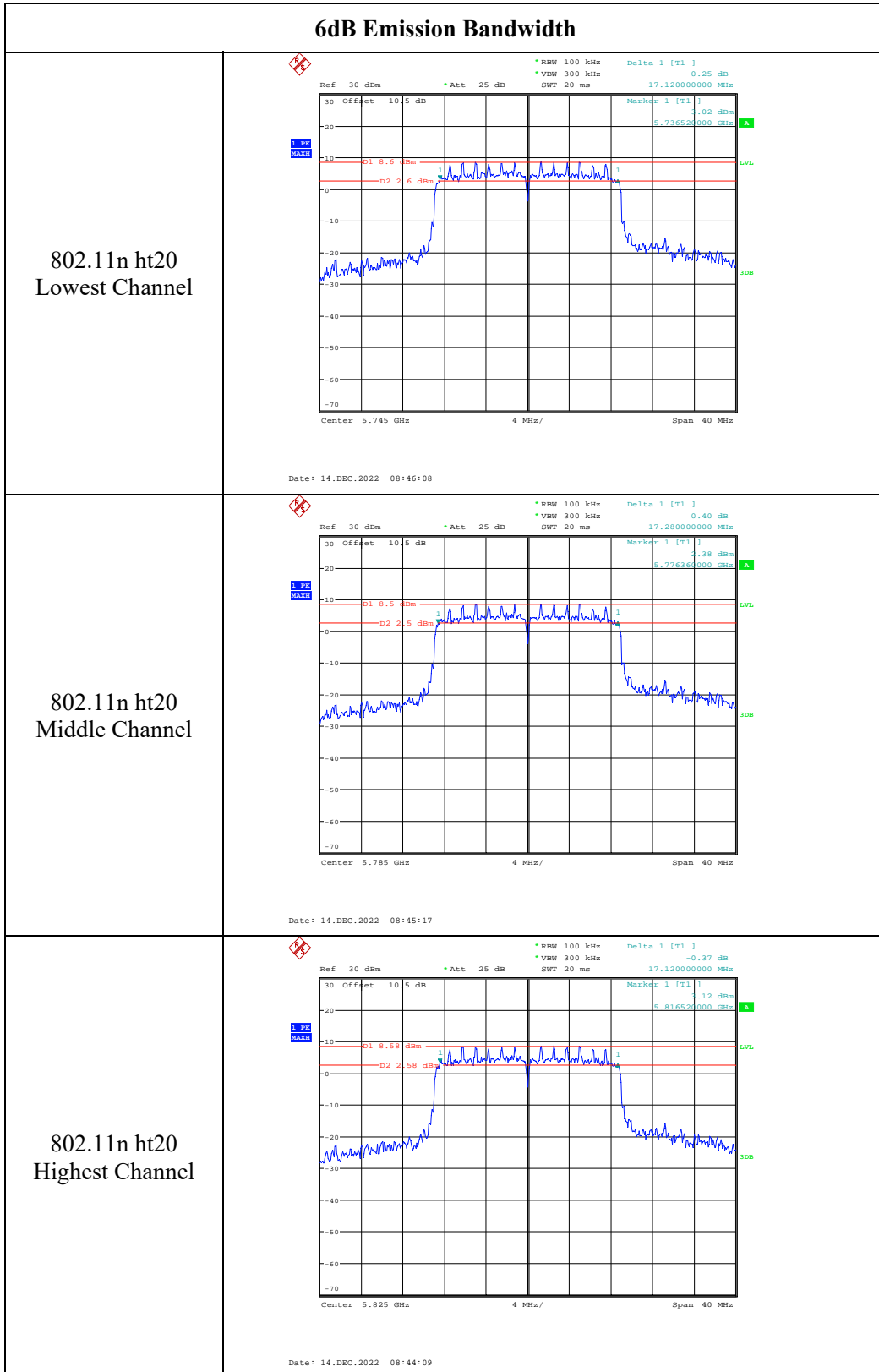

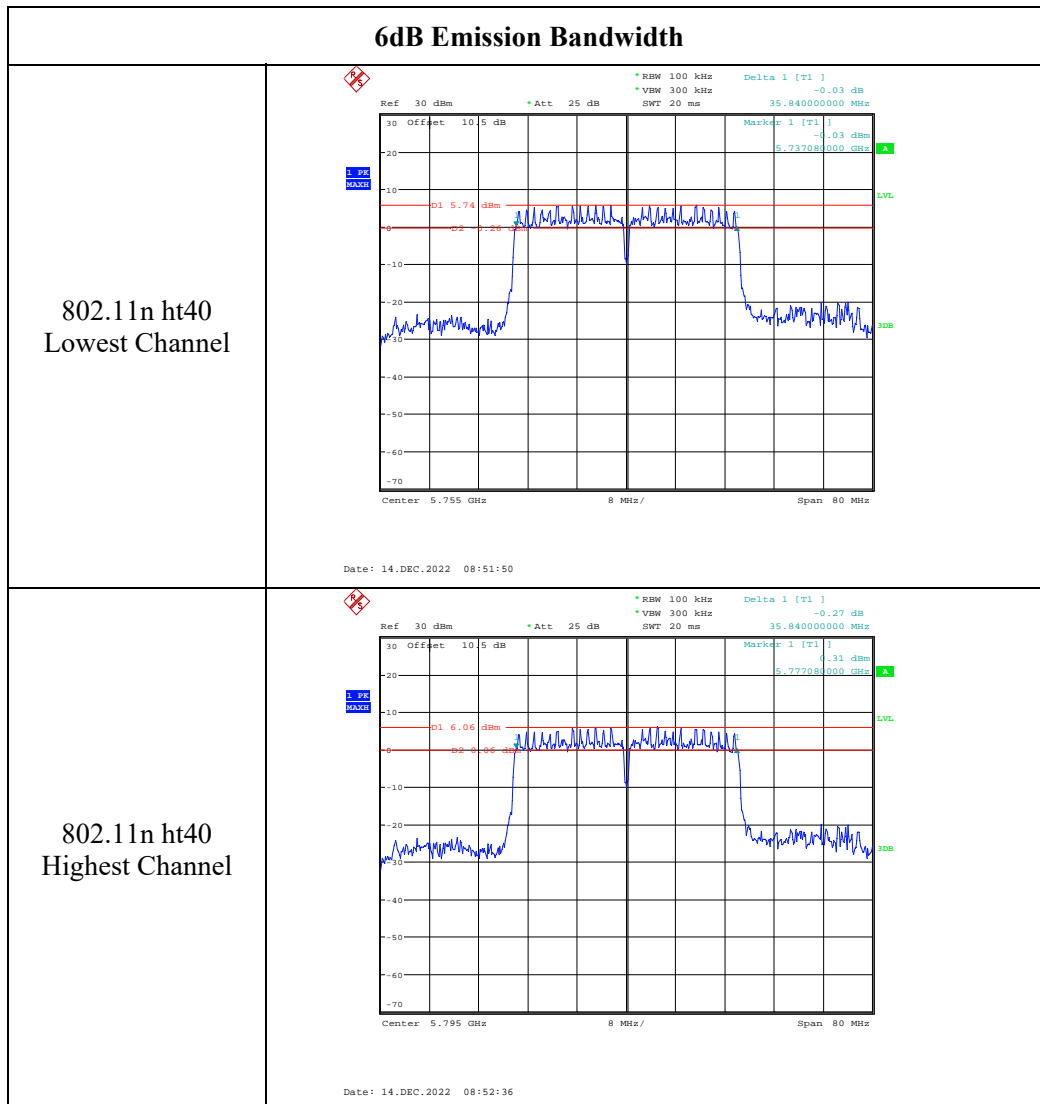

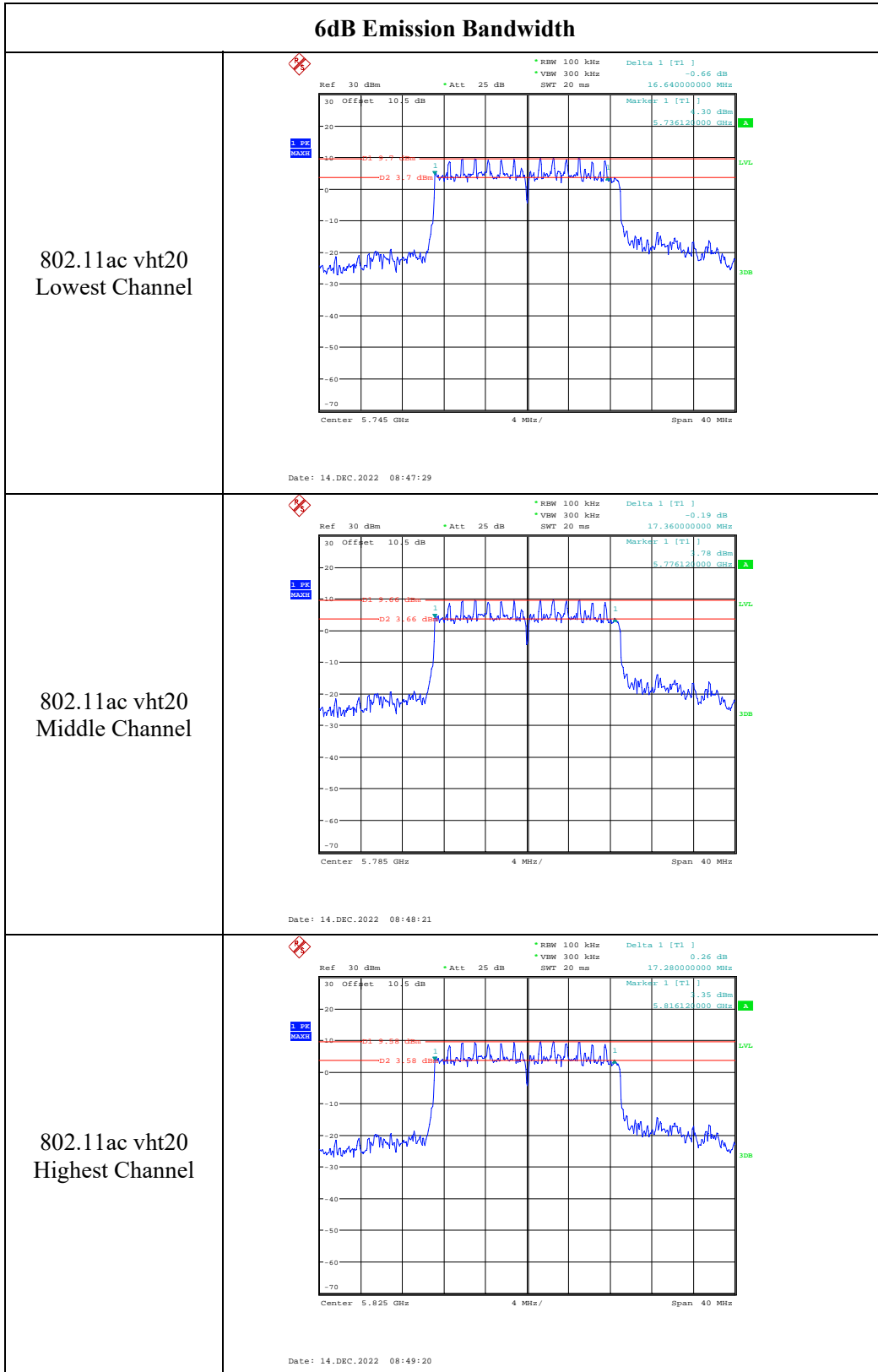

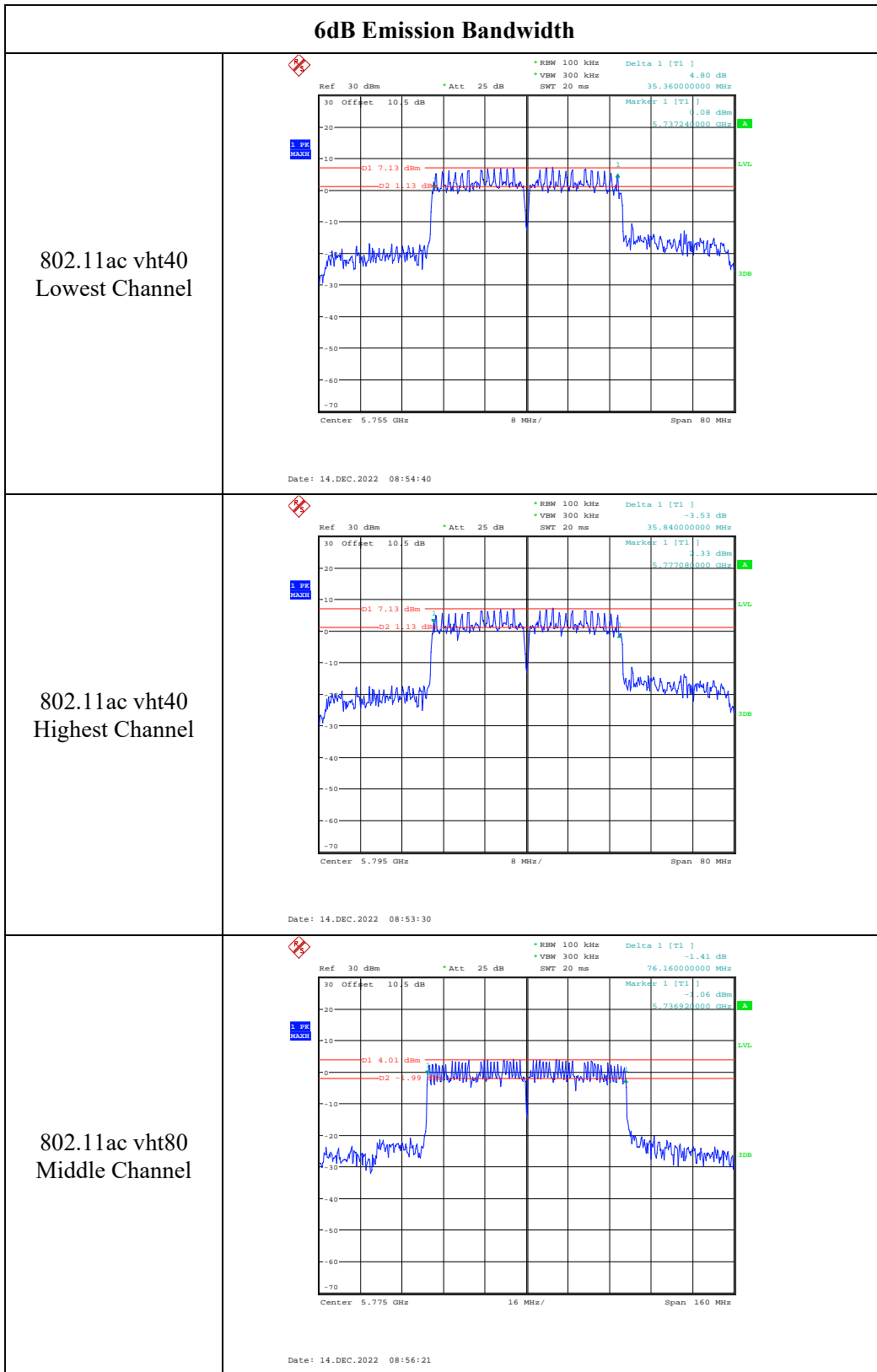

<b>6dB Emission Bandwidth</b>	
802.11ax hew20 Lowest Channel	<p>                     * RBW 100 kHz    Delta 1 [T1]    0.22 dB                      * VBW 300 kHz                      * Att. 25 dB    SWF 20 ms    19.00000000 MHz                      Ref 30 dBm    Offset 10.5 dB    Marker 1 [T1]    1.42 dBm                      5.73620000 GHz                      D1 9.29 dBm    D2 3.39 dBm                      Center 5.745 GHz    4 MHz/    Span 40 MHz                      Date: 14.DEC.2022 09:48:02                 </p>
802.11ax hew20 Middle Channel	<p>                     * RBW 100 kHz    Delta 1 [T1]    -1.54 dB                      * VBW 300 kHz                      * Att. 25 dB    SWF 20 ms    18.08000000 MHz                      Ref 30 dBm    Offset 10.5 dB    Marker 1 [T1]    4.50 dBm                      5.77620000 GHz                      D1 9.23 dBm    D2 3.23 dBm                      Center 5.785 GHz    4 MHz/    Span 40 MHz                      Date: 14.DEC.2022 09:48:57                 </p>
802.11ax hew20 Highest Channel	<p>                     * RBW 100 kHz    Delta 1 [T1]    -2.05 dB                      * VBW 300 kHz                      * Att. 25 dB    SWF 20 ms    17.84000000 MHz                      Ref 30 dBm    Offset 10.5 dB    Marker 1 [T1]    1.45 dBm                      5.81620000 GHz                      D1 9.31 dBm    D2 3.31 dBm                      Center 5.825 GHz    4 MHz/    Span 40 MHz                      Date: 14.DEC.2022 09:49:49                 </p>

<b>6dB Emission Bandwidth</b>	
802.11ax hew40 Lowest Channel	<p style="text-align: center;">Date: 14.DEC.2022 09:46:00</p>
802.11ax hew40 Highest Channel	<p style="text-align: center;">Date: 14.DEC.2022 09:46:47</p>
802.11ax hew80 Middle Channel	<p style="text-align: center;">Date: 14.DEC.2022 09:44:45</p>

**99% Emission Bandwidth**

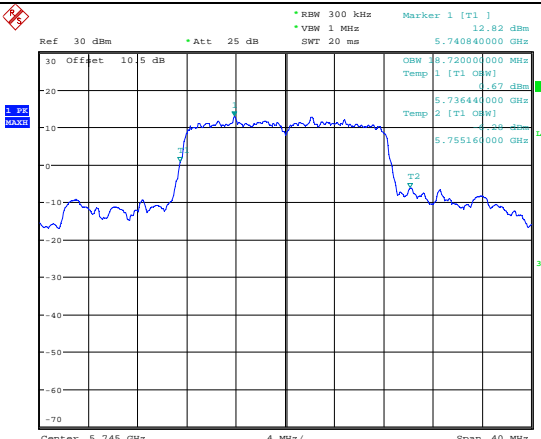
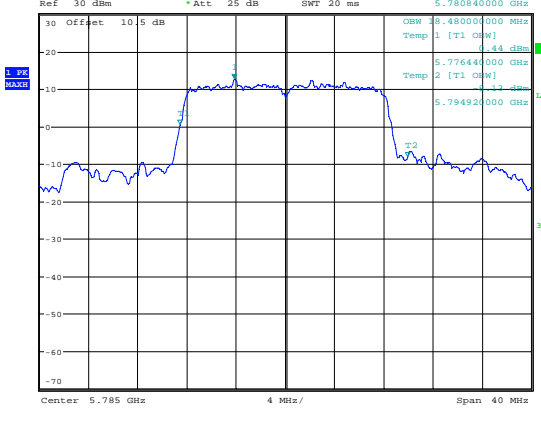
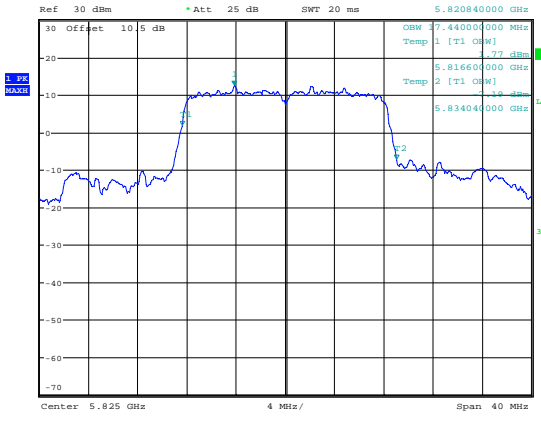
<p>802.11a Lowest Channel</p>	 <p>Ref 30 dBm * Att 25 dB * RBW 300 kHz Marker 1 [T1] 12.82 dBm          * VBW 1 MHz 5.740840000 GHz          * SWT 20 ms</p> <p>OSW 5.720000000 MHz          Temp 1 [T1] OSW] 12.67 dBm          5.736440000 GHz          Temp 2 [T1] OSW] 12.30 dBm          5.755150000 GHz</p> <p>Center 5.745 GHz 4 MHz/ Span 40 MHz</p> <p>Date: 14.DEC.2022 08:41:26</p>
<p>802.11a Middle Channel</p>	 <p>Ref 30 dBm * Att 25 dB * RBW 300 kHz Marker 1 [T1] 12.64 dBm          * VBW 1 MHz 5.780840000 GHz          * SWT 20 ms</p> <p>OSW 5.748000000 MHz          Temp 1 [T1] OSW] 12.44 dBm          5.776440000 GHz          Temp 2 [T1] OSW] 12.34 dBm          5.794920000 GHz</p> <p>Center 5.785 GHz 4 MHz/ Span 40 MHz</p> <p>Date: 14.DEC.2022 08:42:20</p>
<p>802.11a Highest Channel</p>	 <p>Ref 30 dBm * Att 25 dB * RBW 300 kHz Marker 1 [T1] 12.39 dBm          * VBW 1 MHz 5.820840000 GHz          * SWT 20 ms</p> <p>OSW 5.744000000 MHz          Temp 1 [T1] OSW] 12.72 dBm          5.816600000 GHz          Temp 2 [T1] OSW] 12.18 dBm          5.834040000 GHz</p> <p>Center 5.825 GHz 4 MHz/ Span 40 MHz</p> <p>Date: 14.DEC.2022 08:43:19</p>

**99% Emission Bandwidth**

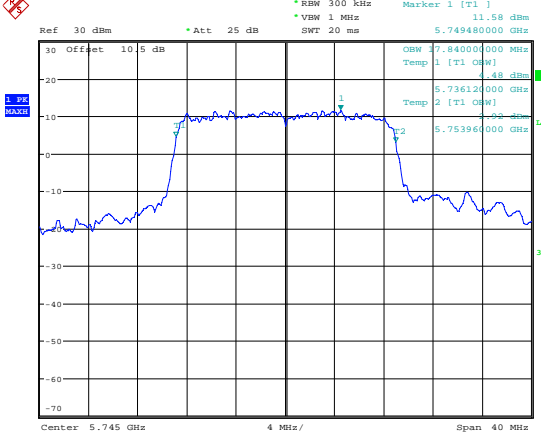
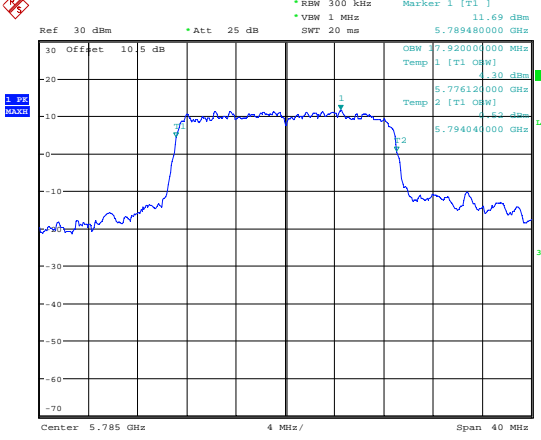
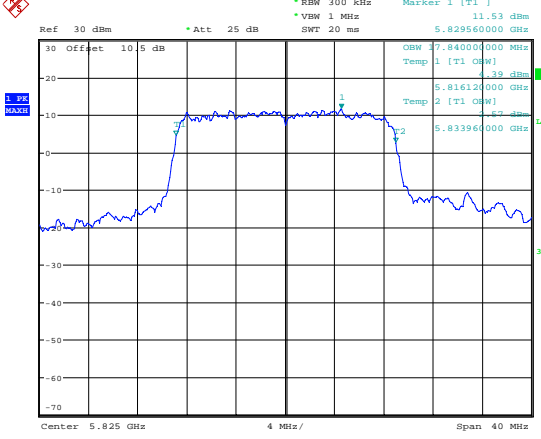
<p>802.11n ht20 Lowest Channel</p>	 <p>Ref 30 dBm * Att 25 dB * RBW 300 kHz Marker 1 [T1] 11.58 dBm * VBW 1 MHz 5.749480000 GHz * SWT 20 ms</p> <p>OSW 7.840000000 MHz Temp 1 [T1] OSW] 4.48 dBm 5.736120000 GHz Temp 2 [T1] OSW] 4.30 dBm 5.753960000 GHz</p> <p>Center 5.745 GHz 4 MHz/ Span 40 MHz</p> <p>Date: 14.DEC.2022 08:46:20</p>
<p>802.11n ht20 Middle Channel</p>	 <p>Ref 30 dBm * Att 25 dB * RBW 300 kHz Marker 1 [T1] 11.69 dBm * VBW 1 MHz 5.789480000 GHz * SWT 20 ms</p> <p>OSW 7.920000000 MHz Temp 1 [T1] OSW] 4.30 dBm 5.776120000 GHz Temp 2 [T1] OSW] 4.30 dBm 5.794040000 GHz</p> <p>Center 5.785 GHz 4 MHz/ Span 40 MHz</p> <p>Date: 14.DEC.2022 08:45:29</p>
<p>802.11n ht20 Highest Channel</p>	 <p>Ref 30 dBm * Att 25 dB * RBW 300 kHz Marker 1 [T1] 11.53 dBm * VBW 1 MHz 5.829560000 GHz * SWT 20 ms</p> <p>OSW 7.840000000 MHz Temp 1 [T1] OSW] 4.30 dBm 5.816120000 GHz Temp 2 [T1] OSW] 4.30 dBm 5.833960000 GHz</p> <p>Center 5.825 GHz 4 MHz/ Span 40 MHz</p> <p>Date: 14.DEC.2022 08:44:21</p>



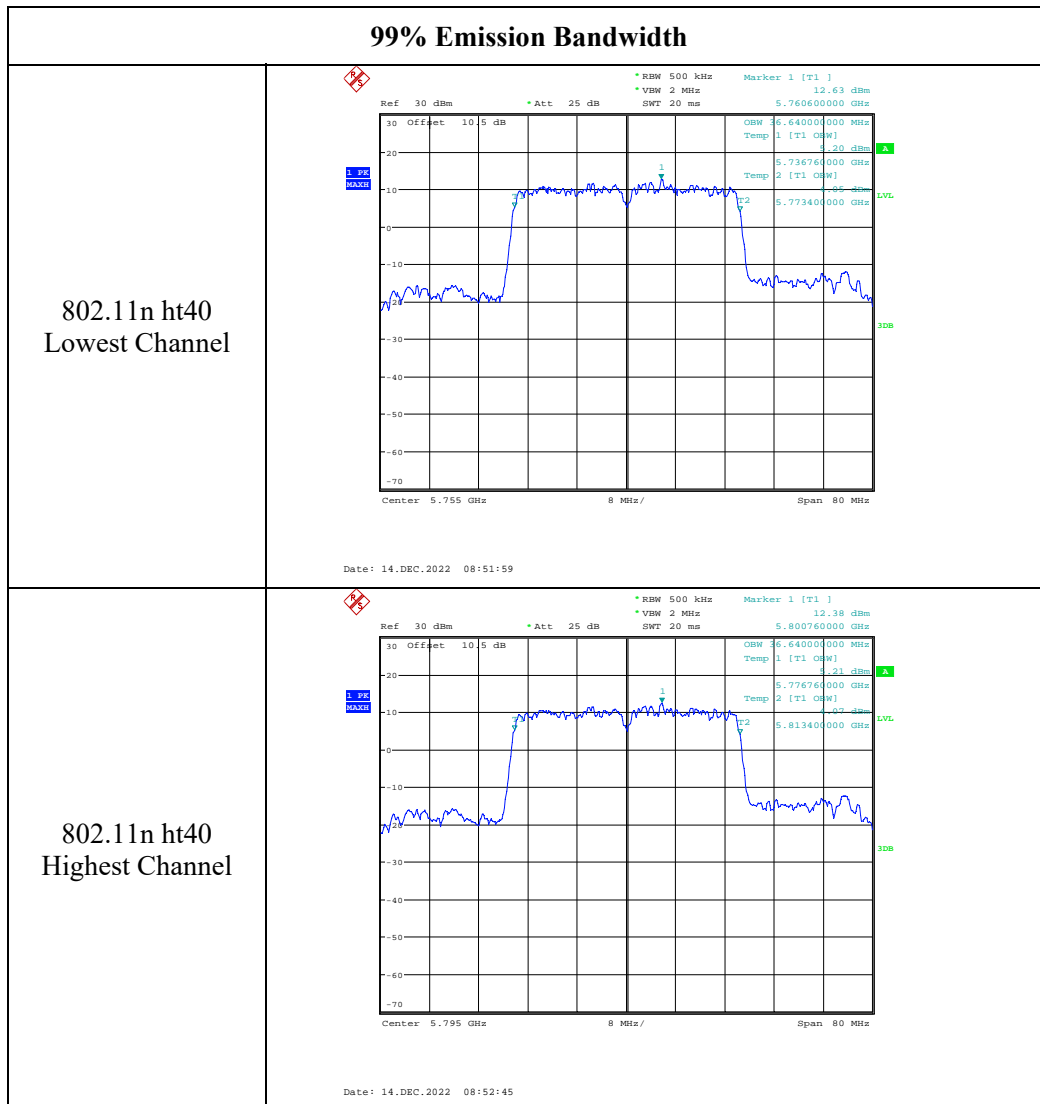

**99% Emission Bandwidth**

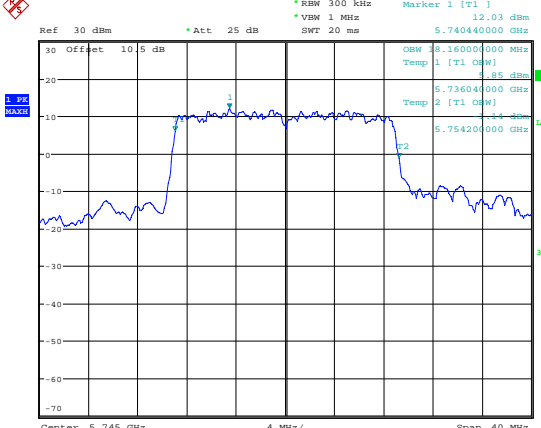
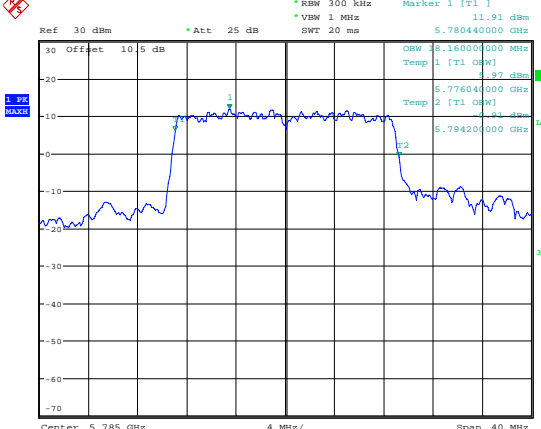
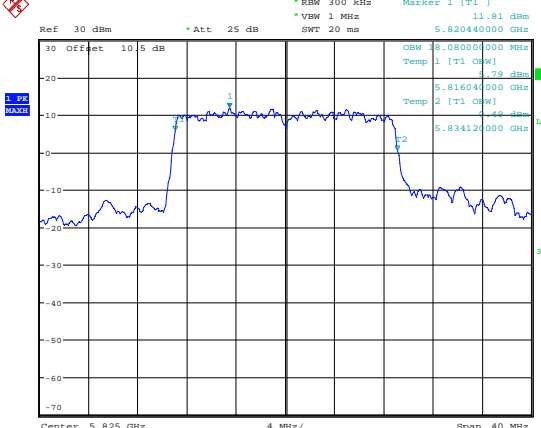
<p>802.11ac vht20 Lowest Channel</p>	 <p>Ref: 30 dBm, Offset: 10.5 dB, Att: 25 dB, RBW: 300 kHz, VBW: 1 MHz, SWT: 20 ms, Marker 1 [T1]: 5.740440000 GHz, 12.03 dBm</p> <p>OSW: 5.160000000 MHz, Temp 1 [T1 OSW]: 1.85 dBm</p> <p>OSW: 5.736040000 GHz, Temp 2 [T1 OSW]: 1.34 dBm</p> <p>OSW: 5.754200000 GHz</p> <p>Center: 5.745 GHz, 4 MHz/, Span: 40 MHz</p> <p>Date: 14.DEC.2022 08:47:39</p>
<p>802.11ac vht20 Middle Channel</p>	 <p>Ref: 30 dBm, Offset: 10.5 dB, Att: 25 dB, RBW: 300 kHz, VBW: 1 MHz, SWT: 20 ms, Marker 1 [T1]: 5.780440000 GHz, 11.91 dBm</p> <p>OSW: 5.160000000 MHz, Temp 1 [T1 OSW]: 1.97 dBm</p> <p>OSW: 5.776040000 GHz, Temp 2 [T1 OSW]: 1.43 dBm</p> <p>OSW: 5.794200000 GHz</p> <p>Center: 5.785 GHz, 4 MHz/, Span: 40 MHz</p> <p>Date: 14.DEC.2022 08:48:30</p>
<p>802.11ac vht20 Highest Channel</p>	 <p>Ref: 30 dBm, Offset: 10.5 dB, Att: 25 dB, RBW: 300 kHz, VBW: 1 MHz, SWT: 20 ms, Marker 1 [T1]: 5.820440000 GHz, 11.81 dBm</p> <p>OSW: 5.080000000 MHz, Temp 1 [T1 OSW]: 1.79 dBm</p> <p>OSW: 5.816040000 GHz, Temp 2 [T1 OSW]: 1.48 dBm</p> <p>OSW: 5.834120000 GHz</p> <p>Center: 5.825 GHz, 4 MHz/, Span: 40 MHz</p> <p>Date: 14.DEC.2022 08:49:28</p>

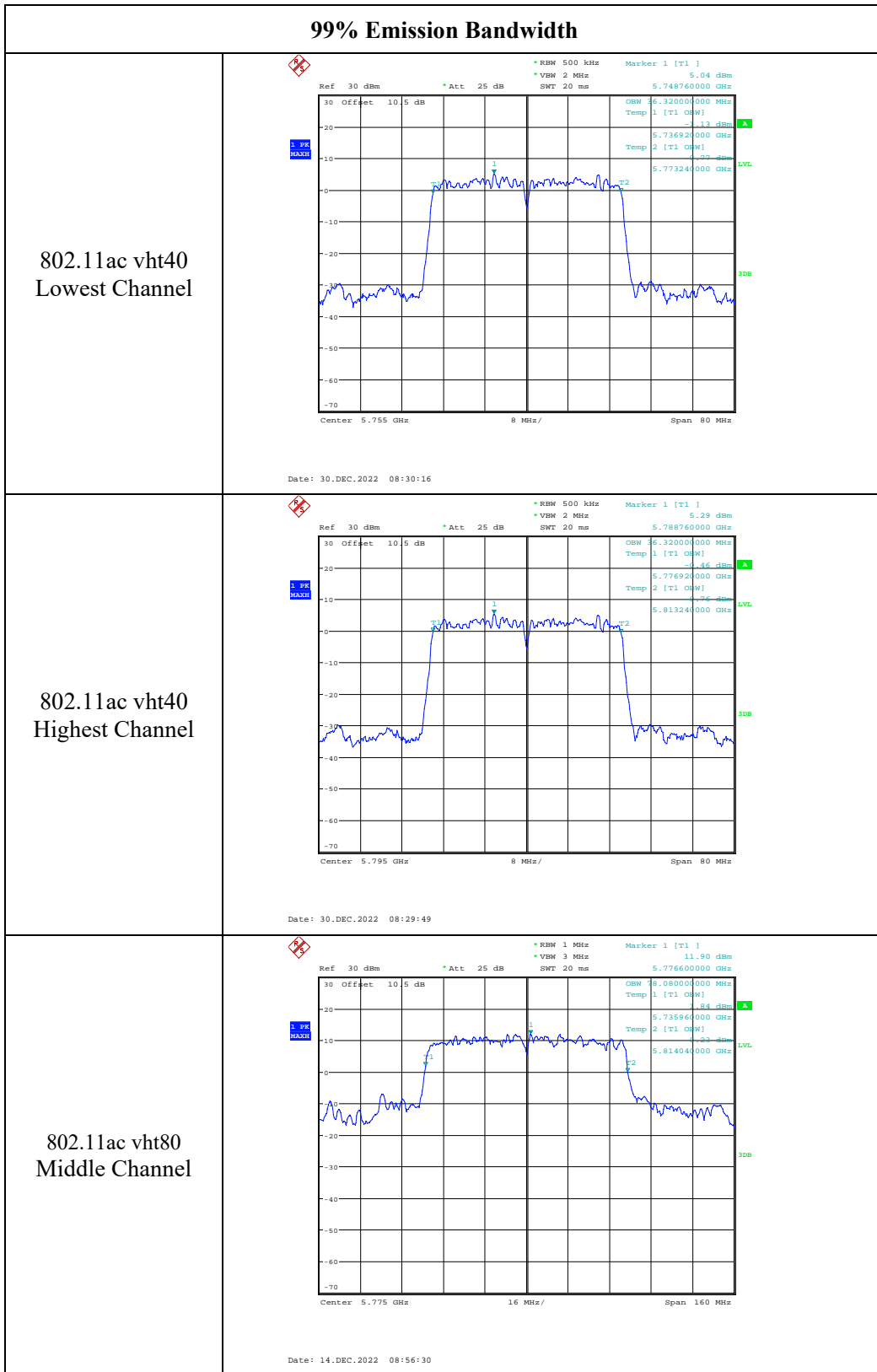

**99% Emission Bandwidth**

<p>802.11ax hew20 Lowest Channel</p>	<p>Ref 30 dBm * Att 25 dB * RBW 300 kHz Marker 1 [T1] 12.14 dBm * VBW 1 MHz 5.748200000 GHz SWT 20 ms</p> <p>30 Offset 10 5 dB</p> <p>30 Offset 10 5 dB</p> <p>OSW 9.260000000 MHz Temp 1 [T1] OSW] 1.72 dBm 5.735400000 GHz Temp 2 [T1] OSW] 1.83 dBm 5.754760000 GHz</p> <p>Center 5.745 GHz 4 MHz/ Span 40 MHz</p> <p>Date: 14.DEC.2022 09:48:11</p>
<p>802.11ax hew20 Middle Channel</p>	<p>Ref 30 dBm * Att 25 dB * RBW 300 kHz Marker 1 [T1] 11.93 dBm * VBW 1 MHz 5.788200000 GHz SWT 20 ms</p> <p>30 Offset 10 5 dB</p> <p>30 Offset 10 5 dB</p> <p>OSW 9.200000000 MHz Temp 1 [T1] OSW] 1.06 dBm 5.775480000 GHz Temp 2 [T1] OSW] 1.30 dBm 5.794680000 GHz</p> <p>Center 5.785 GHz 4 MHz/ Span 40 MHz</p> <p>Date: 14.DEC.2022 09:49:06</p>
<p>802.11ax hew20 Highest Channel</p>	<p>Ref 30 dBm * Att 25 dB * RBW 300 kHz Marker 1 [T1] 11.95 dBm * VBW 1 MHz 5.828200000 GHz SWT 20 ms</p> <p>30 Offset 10 5 dB</p> <p>30 Offset 10 5 dB</p> <p>OSW 9.200000000 MHz Temp 1 [T1] OSW] 1.70 dBm 5.815480000 GHz Temp 2 [T1] OSW] 1.65 dBm 5.834680000 GHz</p> <p>Center 5.825 GHz 4 MHz/ Span 40 MHz</p> <p>Date: 14.DEC.2022 09:49:57</p>

**99% Emission Bandwidth**

<p>802.11ax hew40 Lowest Channel</p>	<p>Ref 30 dBm *Att 25 dB *RBW 500 kHz Marker 1 [T1] 5.00 dBm *VBM 2 MHz 5.759680000 GHz SWT 20 ms 5.759680000 GHz</p> <p>30 Offset 10 5 dB OSW 8.080000000 MHz Temp 1 [T1 OSW] 4.62 dBm 5.735960000 GHz Temp 2 [T1 OSW] 4.33 dBm 5.774040000 GHz</p> <p>Center 5.755 GHz 8 MHz/ Span 80 MHz</p> <p>Date: 30.DEC.2022 08:27:12</p>
<p>802.11ax hew40 Highest Channel</p>	<p>Ref 30 dBm *Att 25 dB *RBW 500 kHz Marker 1 [T1] 5.00 dBm *VBM 2 MHz 5.798680000 GHz SWT 20 ms 5.798680000 GHz</p> <p>30 Offset 10 5 dB OSW 8.080000000 MHz Temp 1 [T1 OSW] 4.65 dBm 5.775960000 GHz Temp 2 [T1 OSW] 4.33 dBm 5.814040000 GHz</p> <p>Center 5.795 GHz 8 MHz/ Span 80 MHz</p> <p>Date: 30.DEC.2022 08:27:38</p>
<p>802.11ax hew80 Middle Channel</p>	<p>Ref 30 dBm *Att 25 dB *RBW 1 MHz Marker 1 [T1] 11.80 dBm *VBM 3 MHz 5.795480000 GHz SWT 20 ms 5.795480000 GHz</p> <p>30 Offset 10 5 dB OSW 9.040000000 MHz Temp 1 [T1 OSW] 4.65 dBm 5.735960000 GHz Temp 2 [T1 OSW] 4.41 dBm 5.815000000 GHz</p> <p>Center 5.775 GHz 16 MHz/ Span 160 MHz</p> <p>Date: 14.DEC.2022 09:44:58</p>

**4.4 Maximum Conducted Output Power:**

Serial Number:	1ST2	Test Date:	2022/12/12~2022/12/30
Test Site:	RF	Test Mode:	Transmitting
Tester:	Arthur Su	Test Result:	Pass

**Environmental Conditions:**

Temperature: (°C)	21.3~22.4	Relative Humidity: (%)	38~41	ATM Pressure: (kPa)	101.4~102.1
----------------------	-----------	------------------------------	-------	------------------------	-------------

**Test Equipment List and Details:**

Manufacturer	Description	Model	Serial Number	Calibration Date	Calibration Due Date
zhuoxiang	Coaxial Cable	SMA-178	211002	Each time	N/A
eastsheep	Coaxial Attenuator	2W-SMA-JK-18G	21060301	Each time	N/A
Agilent	USB Wideband Power Sensor	U2021XA	MY54080015	2022-07-15	2023-07-14

\* Statement of Traceability: China Certification ICT Co., Ltd (Dongguan) attests that all calibrations have been performed, traceable to National Primary Standards and International System of Units (SI).

**Test Data:****5150-5250 MHz:****802.11a/n/ac modes:**

Test Modes	Test Frequency (MHz)	Max. Conducted Average Output Power (dBm)				
		Chain 0	Chain 1	Total	Limit For Non-beamforming	Limit For Beamforming
802.11a	5180	19.55	21.68	/	30	/
	5200	22.69	22.34	/	30	/
	5240	22.18	21.84	/	30	/
802.11n ht20	5180	19.18	20.64	22.98	30	29.68
	5200	22.14	21.88	25.02	30	29.68
	5240	21.84	20.88	24.40	30	29.68
802.11n ht40	5190	18.08	17.99	21.05	30	29.68
	5230	21.78	21.14	24.48	30	29.68
802.11ac vht20	5180	20.14	21.48	23.87	30	29.68
	5200	22.44	21.32	24.93	30	29.68
	5240	21.9	21.36	24.65	30	29.68
802.11ac vht40	5190	16.87	16.79	19.84	30	29.68
	5230	22.32	21.68	25.02	30	29.68
802.11ac vht80	5210	14.48	14.13	17.32	30	29.68

**802.11ax modes:**

Test Modes	Test Frequency (MHz)	RU Config.	Max. Conducted Average Output Power (dBm)				
			Chain 0	Chain 1	Total	Limit For Non-beamforming	Limit For Beamforming
802.11ax hew20	5180	26/0	11.25	11.75	14.52	30	29.68
		52/37	14.56	14.98	17.79	30	29.68
		106/53	17.78	18.01	20.91	30	29.68
		242/61	20.92	21.19	24.07	30	29.68
	5200	26/0	12.04	11.36	14.72	30	29.68
		52/37	15.25	14.58	17.94	30	29.68
		106/53	18.48	17.98	21.25	30	29.68
		242/61	21.79	21.14	24.49	30	29.68
	5240	26/0	12.02	11.22	14.65	30	29.68
		52/37	15.35	14.78	18.08	30	29.68
		106/53	18.74	18.02	21.41	30	29.68
		242/61	21.92	21.27	24.62	30	29.68
802.11ax hew40	5190	26/0	5.02	5.12	8.08	30	29.68
		52/37	8.14	8.25	11.21	30	29.68
		106/53	11.51	11.41	14.47	30	29.68
		242/61	14.69	14.58	17.65	30	29.68
		484/65	17.84	17.7	20.78	30	29.68
	5230	26/0	8.25	7.05	10.70	30	29.68
		52/37	11.75	10.28	14.09	30	29.68
		106/53	14.98	13.69	17.39	30	29.68
		242/61	18.02	17.05	20.57	30	29.68
		484/65	21.27	20.4	23.87	30	29.68
802.11ax hew80	5210	26/0	-0.88	-0.22	2.47	30	29.68
		52/37	2.19	2.98	5.61	30	29.68
		106/53	5.44	6.28	8.89	30	29.68
		242/61	9.81	9.44	12.64	30	29.68
		484/65	12.98	12.55	15.78	30	29.68
		996/67	16.12	15.75	18.95	30	29.68

**Note:**

The duty cycle factor has been calculated into the result.

The device is an indoor AP. The device employed Cyclic Delay Diversity (CDD) for 802.11 MIMO transmitting, per KDB 662911 D01 Multiple Transmitter Output v02r01, for power measurements on IEEE 802.11 devices:

$$\text{Array Gain} = 0 \text{ dB (i.e., no array gain) for } N_{\text{ANT}} \leq 4;$$

So:

For Non-beamforming mode:

$$\text{Directional gain} = 3.32 \text{ dBi}$$

For Beamforming mode:

$$\text{Directional gain} = 3.32 + 3 = 6.32 \text{ dBi}$$

5725-5850 MHz:

Test Modes	Test Frequency (MHz)	Max. Conducted Average Output Power (dBm)				
		Chain 0	Chain 1	Total	Limit For Non-beamforming	Limit For Beamforming
802.11a	5745	22.84	21.33	/	30	/
	5785	22.66	21.09	/	30	/
	5825	22.52	20.99	/	30	/
802.11n ht20	5745	22.44	20.67	24.65	30	29.62
	5785	22.07	20.52	24.37	30	29.62
	5825	22.01	20.47	24.32	30	29.62
802.11n ht40	5755	21.58	19.45	23.65	30	29.62
	5795	21.21	19.26	23.35	30	29.62
802.11ac vht20	5745	23.42	21.93	<b>25.75</b>	30	29.62
	5785	23.3	21.61	25.55	30	29.62
	5825	23.19	21.52	25.45	30	29.62
802.11ac vht40	5755	21.1	19.1	23.22	30	29.62
	5795	21.86	20.07	24.07	30	29.62
802.11ac vht80	5775	17.85	15.5	19.84	30	29.62



**802.11ax mode:**

Test Modes	Test Frequency (MHz)	RU Config.	Max. Conducted Average Output Power (dBm)				
			Chain 0	Chain 1	Total	Limit For Non-beamforming	Limit For Beamforming
802.11ax hew20	5745	26/0	13.54	11.78	15.76	30	29.62
		52/37	16.98	14.98	19.10	30	29.62
		106/53	20.14	18.14	22.26	30	29.62
		242/61	23.24	21.6	25.51	30	29.62
	5785	26/0	13.25	11.69	15.55	30	29.62
		52/37	16.58	15.01	18.88	30	29.62
		106/53	19.87	18.22	22.13	30	29.62
		242/61	23.02	21.37	25.28	30	29.62
	5825	26/8	13.25	11.38	15.43	30	29.62
		52/40	16.54	14.98	18.84	30	29.62
		106/54	19.87	18.11	22.09	30	29.62
		242/61	22.9	21.32	25.19	30	29.62
802.11ax hew40	5755	26/0	7.50	5.25	9.53	30	29.62
		52/37	10.58	8.54	12.69	30	29.62
		106/53	13.99	11.87	16.07	30	29.62
		242/61	17.20	14.95	19.23	30	29.62
		484/65	20.32	18.22	22.41	30	29.62
	5795	26/0	8.01	5.36	9.89	30	29.62
		52/37	11.25	8.98	13.27	30	29.62
		106/53	14.69	12.02	16.57	30	29.62
		242/61	17.85	15.39	19.80	30	29.62
		484/65	20.89	18.79	22.98	30	29.62
802.11ax hew80	5775	26/0	1.02	-1.02	3.13	30	29.62
		52/37	4.92	2.30	6.81	30	29.62
		106/53	7.98	5.36	9.87	30	29.62
		242/61	11.02	8.77	13.05	30	29.62
		484/65	14.36	12.01	16.35	30	29.62
		996/67	17.46	15.3	19.52	30	29.62

**Note:**

The duty cycle factor has been calculated into the result.

The device employed Cyclic Delay Diversity (CDD) for 802.11 MIMO transmitting, per KDB 662911 D01 Multiple Transmitter Output v02r01, for power measurements on IEEE 802.11 devices:

$$\text{Array Gain} = 0 \text{ dB (i.e., no array gain) for } N_{\text{ANT}} \leq 4;$$

So:

For Non-beamforming mode:

$$\text{Directional gain} = 3.38 \text{ dBi}$$

For Beamforming mode:

$$\text{Directional gain} = 3.38 + 3 = 6.38 \text{ dBi}$$

**4.5 Maximum power spectral density:**

Serial Number:	1ST2	Test Date:	2022/12/12~2022/12/30
Test Site:	RF	Test Mode:	Transmitting
Tester:	Arthur Su	Test Result:	Pass

**Environmental Conditions:**

Temperature: (°C)	21.3~22.4	Relative Humidity: (%)	38~41	ATM Pressure: (kPa)	101.4~102.1
----------------------	-----------	------------------------------	-------	------------------------	-------------

**Test Equipment List and Details:**

Manufacturer	Description	Model	Serial Number	Calibration Date	Calibration Due Date
R&S	Spectrum Analyzer	FSU26	200445	2022/04/05	2023/04/04
zhuoxiang	Coaxial Cable	SMA-178	211001	Each time	N/A
eastsheep	Coaxial Attenuator	2W-SMA-JK-18G	21060301	Each time	N/A

\* *Statement of Traceability: China Certification ICT Co., Ltd (Dongguan) attests that all calibrations have been performed, traceable to National Primary Standards and International System of Units (SI).*

**Test Data:**

5150-5250 MHz:

Test Modes	Test Frequency (MHz)	Maximum Power Spectral Density (dBm/MHz)			
		Chain 0	Chain 1	Total	Limit
802.11a	5180	8	10.84	/	17.00
	5200	10.9	11.47	/	17.00
	5240	10.41	10.72	/	17.00
802.11n ht20	5180	7.49	9.26	11.47	13.68
	5200	10.33	10.23	13.29	13.68
	5240	9.91	9.15	12.56	13.68
802.11n ht40	5190	4.14	3.79	6.98	13.68
	5230	7.74	7.88	10.82	13.68
802.11ac vht20	5180	8.42	10.17	12.39	13.68
	5200	10.89	10.11	13.53	13.68
	5240	10.08	10.27	13.19	13.68
802.11ac vht40	5190	3.49	3.05	6.29	13.68
	5230	8.69	8.82	11.77	13.68
802.11ac vht80	5210	-0.66	-0.74	2.31	13.68
802.11ax hew20	5180	9.43	10.42	12.95	13.68
	5200	10.51	10.27	13.40	13.68
	5240	10.61	10.36	13.50	13.68
802.11ax hew40	5190	3.78	3.99	6.90	13.68
	5230	7.38	7.48	10.44	13.68
802.11ax hew80	5210	0.95	0.73	3.85	13.68

**Note:**

The device employed Cyclic Delay Diversity (CDD) for 802.11 MIMO transmitting, per KDB 662911 D01 Multiple Transmitter Output v02r01, for power spectral density (PSD) measurements on the devices:

$$\text{Array Gain} = 10 \log(N_{\text{ANT}}/N_{\text{SS}}) \text{ dB.}$$

**So:**

Directional gain =  $G_{\text{ANT}} + \text{Array Gain} = 3.32 + 10 \cdot \log(2/1) = 6.32 \text{ dBi}$  for Non-beamforming mode

Directional gain =  $G_{\text{ANT}} + \text{Array Gain} = 3.32 + 3 + 10 \cdot \log(2/1) = 9.32 \text{ dBi}$  for Beamforming mode

The worst limit Beamforming mode was used in the table.

Method SA-3 in KDB 789033 D02 General UNII Test Procedures New Rules v02r01 was used for PSD test.

5725-5850 MHz:

Test Modes	Test Frequency (MHz)	Reading (dBm/300kHz)		Maximum Power Spectral Density (dBm/500kHz)			
		Chain 0	Chain 1	Chain 0	Chain 1	Total	Limit
802.11a	5745	6.53	4.7	8.75	6.92	/	30.00
	5785	6.11	4.1	8.33	6.32	/	30.00
	5825	6.16	4.02	8.38	6.24	/	30.00
802.11n ht20	5745	6.41	4.51	8.63	6.73	10.79	26.62
	5785	6.23	4.69	8.45	6.91	10.76	26.62
	5825	6.21	4.14	8.43	6.36	10.53	26.62
802.11n ht40	5755	3.37	2.03	5.59	4.25	7.98	26.62
	5795	3.16	1.71	5.38	3.93	7.73	26.62
802.11ac vht20	5745	7.2	5.76	9.42	7.98	11.77	26.62
	5785	7.28	5.51	9.5	7.73	11.71	26.62
	5825	7.18	5.46	9.4	7.68	11.63	26.62
802.11ac vht40	5755	3.33	1.81	5.55	4.03	7.87	26.62
	5795	4.03	2.71	6.25	4.93	8.65	26.62
802.11ac vht80	5775	-1.36	-3.12	0.86	-0.9	3.08	26.62
802.11ax hew20	5745	7.34	5.57	9.56	7.79	11.77	26.62
	5785	7.41	5.54	9.63	7.76	11.81	26.62
	5825	7.57	5.58	9.79	7.8	11.92	26.62
802.11ax hew40	5755	2.74	0.8	4.96	3.02	7.11	26.62
	5795	3.08	0.99	5.3	3.21	7.39	26.62
802.11ax hew80	5775	-2.33	-4.3	-0.11	-2.08	2.03	26.62

Note:

The device employed Cyclic Delay Diversity (CDD) for 802.11 MIMO transmitting, per KDB 662911 D01 Multiple Transmitter Output v02r01, for power spectral density (PSD) measurements on the devices:

$$\text{Array Gain} = 10 \log(N_{\text{ANT}}/N_{\text{SS}}) \text{ dB.}$$

So:

Directional gain =  $G_{\text{ANT}} + \text{Array Gain} = 3.38 + 10 \cdot \log(2/1) = 6.38 \text{ dBi}$  for Non-beamforming mode

Directional gain =  $G_{\text{ANT}} + \text{Array Gain} = 3.38 + 3 + 10 \cdot \log(2/1) = 9.38 \text{ dBi}$  for Beamforming mode

The worst limit Beamforming mode was used in the table.

Method SA-3 in KDB 789033 D02 General UNII Test Procedures New Rules v02r01 was used for PSD test.

If measurement bandwidth of Maximum PSD is specified in 500 kHz, add  $10 \log(500 \text{ kHz} / \text{RBW})$  to the measured result, whereas RBW (< 500 kHz) is the reduced resolution bandwidth of the spectrum analyzer set during measurement

5150-5250MHz:  
Chain0:

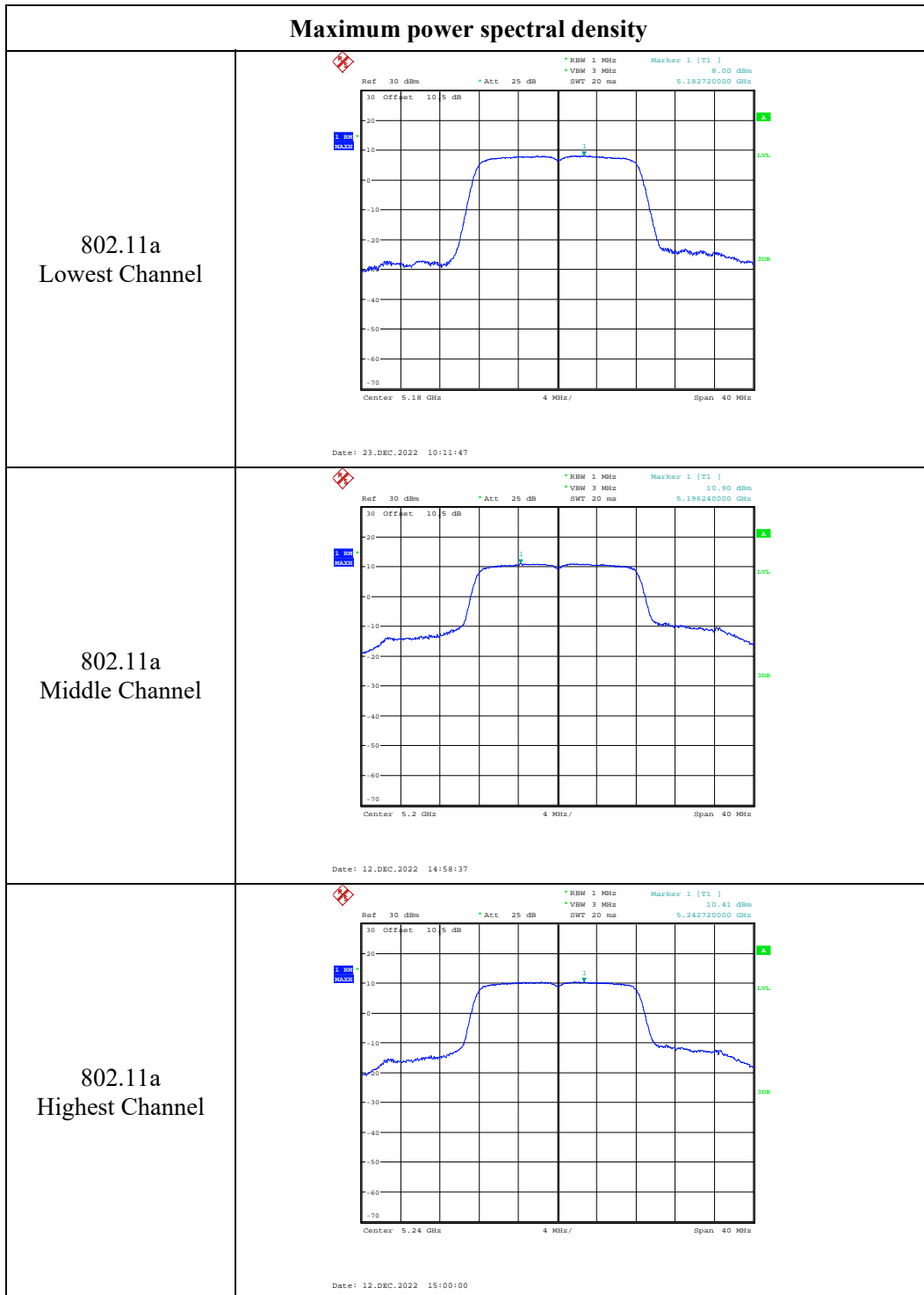

**Maximum power spectral density**

<p>802.11n ht20 Lowest Channel</p>	<p>Date: 23.DEC.2022 10:11:00</p>
<p>802.11n ht20 Middle Channel</p>	<p>Date: 12.DEC.2022 15:04:33</p>
<p>802.11n ht20 Highest Channel</p>	<p>Date: 12.DEC.2022 15:06:46</p>

**Maximum power spectral density**

<p>802.11n ht40 Lowest Channel</p>	<p>Ref 30 dBm    * Att 25 dB    * RBW 1 MHz    Marker 1 [T1] 4.14 dBm  * VBW 3 MHz  SWT 20 ms    5.196240000 GHz</p> <p>Offset 10.5 dB</p> <p>Center 5.19 GHz    8 MHz/    Span 80 MHz</p> <p>Date: 23.DEC.2022 10:06:31</p>
<p>802.11n ht40 Highest Channel</p>	<p>Ref 30 dBm    * Att 25 dB    * RBW 1 MHz    Marker 1 [T1] 7.74 dBm  * VBW 3 MHz  SWT 20 ms    5.234960000 GHz</p> <p>Offset 10.5 dB</p> <p>Center 5.23 GHz    8 MHz/    Span 80 MHz</p> <p>Date: 12.DEC.2022 15:18:07</p>

### Maximum power spectral density

802.11ac vht20  
Lowest Channel

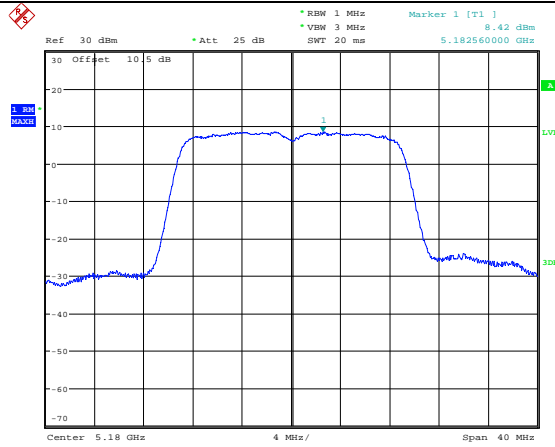

Date: 23.DEC.2022 10:09:52

802.11ac vht20  
Middle Channel

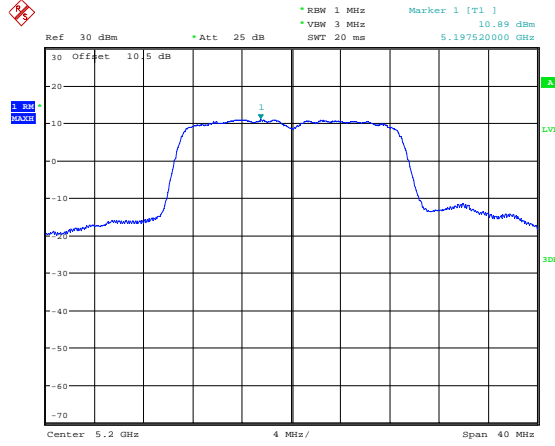

Date: 12.DEC.2022 15:09:49

802.11ac vht20  
Highest Channel

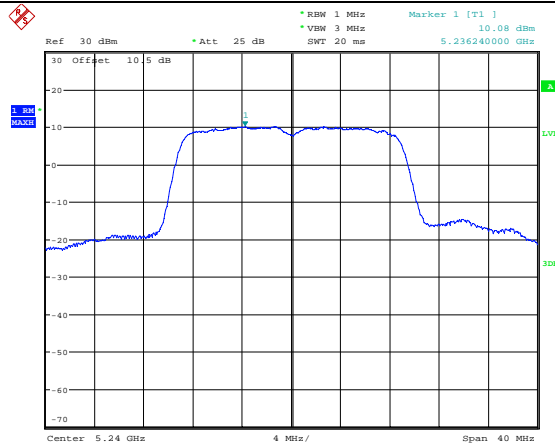

Date: 12.DEC.2022 15:11:07



### Maximum power spectral density

<p>802.11ac vht40 Lowest Channel</p>	<p>Ref 30 dBm * Att 25 dB * RBW 1 MHz * VBW 3 MHz * Marker 1 [T1] 3.49 dBm SWT 20 ms 5.193840000 GHz</p> <p>30 Offset 10 5 dB</p> <p>3 dB</p> <p>10 dB</p> <p>20</p> <p>10</p> <p>0</p> <p>-10</p> <p>-20</p> <p>-30</p> <p>-40</p> <p>-50</p> <p>-60</p> <p>-70</p> <p>Center 5.19 GHz 8 MHz/ Span 80 MHz</p> <p>Date: 23.DEC.2022 10:05:58</p>
<p>802.11ac vht40 Highest Channel</p>	<p>Ref 30 dBm * Att 25 dB * RBW 1 MHz * VBW 3 MHz * Marker 1 [T1] 8.69 dBm SWT 20 ms 5.233840000 GHz</p> <p>30 Offset 10 5 dB</p> <p>3 dB</p> <p>10 dB</p> <p>20</p> <p>10</p> <p>0</p> <p>-10</p> <p>-20</p> <p>-30</p> <p>-40</p> <p>-50</p> <p>-60</p> <p>-70</p> <p>Center 5.23 GHz 8 MHz/ Span 80 MHz</p> <p>Date: 12.DEC.2022 15:22:04</p>
<p>802.11ac vht80 Middle Channel</p>	<p>Ref 30 dBm * Att 25 dB * RBW 1 MHz * VBW 3 MHz * Marker 1 [T1] -0.66 dBm SWT 20 ms 5.207440000 GHz</p> <p>30 Offset 10 5 dB</p> <p>3 dB</p> <p>10 dB</p> <p>20</p> <p>10</p> <p>0</p> <p>-10</p> <p>-20</p> <p>-30</p> <p>-40</p> <p>-50</p> <p>-60</p> <p>-70</p> <p>Center 5.21 GHz 16 MHz/ Span 160 MHz</p> <p>Date: 23.DEC.2022 10:02:48</p>

**Maximum power spectral density**

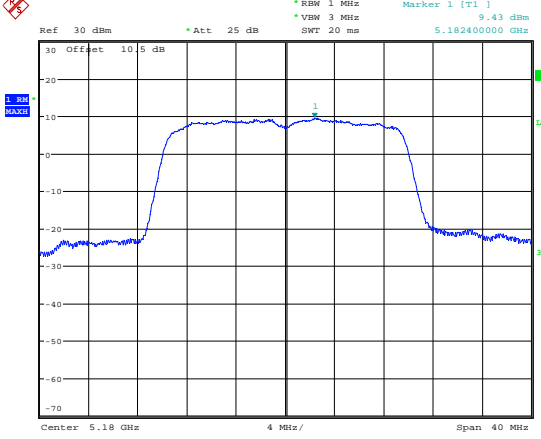
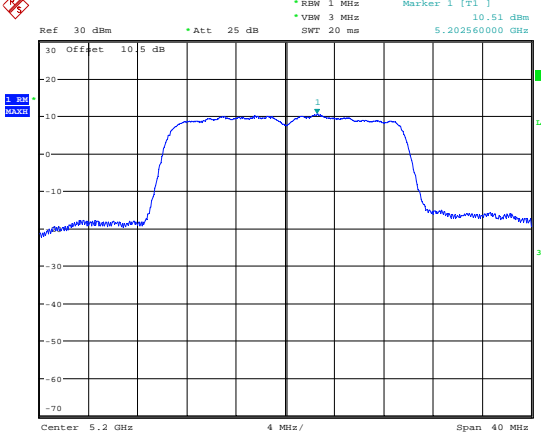
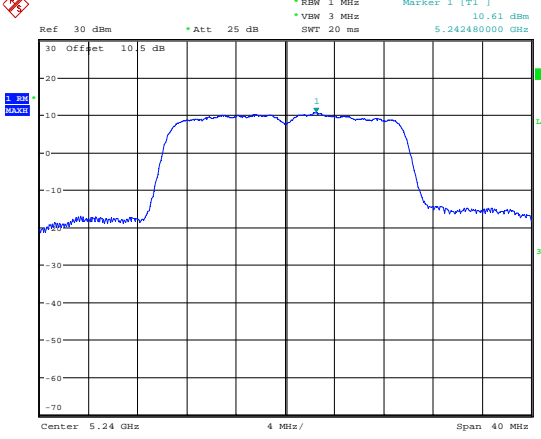
<p>802.11ax hew20 Lowest Channel</p>	 <p>Date: 23.DEC.2022 10:08:52</p>
<p>802.11ax hew20 Middle Channel</p>	 <p>Date: 13.DEC.2022 08:54:20</p>
<p>802.11ax hew20 Highest Channel</p>	 <p>Date: 13.DEC.2022 09:01:11</p>

**Maximum power spectral density**

<p>802.11ax hew40 Lowest Channel</p>	<p>Date: 23.DEC.2022 10:04:51</p>
<p>802.11ax hew40 Highest Channel</p>	<p>Date: 13.DEC.2022 09:06:08</p>
<p>802.11ax hew80 Middle Channel</p>	<p>Date: 23.DEC.2022 10:00:59</p>

Chain1:

<b>Maximum power spectral density</b>	
<p>802.11a Lowest Channel</p>	<p style="text-align: center;">Date: 13.DEC.2022 13:06:15</p>
<p>802.11a Middle Channel</p>	<p style="text-align: center;">Date: 13.DEC.2022 13:08:04</p>
<p>802.11a Highest Channel</p>	<p style="text-align: center;">Date: 13.DEC.2022 13:11:30</p>

### Maximum power spectral density

<p>802.11n ht20 Lowest Channel</p>	<p>Date: 13.DEC.2022 13:17:05</p>
<p>802.11n ht20 Middle Channel</p>	<p>Date: 13.DEC.2022 13:15:31</p>
<p>802.11n ht20 Highest Channel</p>	<p>Date: 13.DEC.2022 13:19:28</p>

**Maximum power spectral density**

<p>802.11n ht40 Lowest Channel</p>	<p>Date: 23.DEC.2022 10:36:53</p>
<p>802.11n ht40 Highest Channel</p>	<p>Date: 13.DEC.2022 13:24:39</p>

### Maximum power spectral density

<p>802.11ac vht20 Lowest Channel</p>	<p>Ref: 30 dBm    *Att: 25 dB    *RBW: 1 MHz    Marker 1 [T1] 10.17 dBm *VBW: 3 MHz    *SWT: 20 ms    5.175120000 GHz</p> <p>Center: 5.18 GHz    4 MHz/    Span: 40 MHz</p> <p>Date: 13.DEC.2022 13:21:02</p>
<p>802.11ac vht20 Middle Channel</p>	<p>Ref: 30 dBm    *Att: 25 dB    *RBW: 1 MHz    Marker 1 [T1] 10.11 dBm *VBW: 3 MHz    *SWT: 20 ms    5.197520000 GHz</p> <p>Center: 5.2 GHz    4 MHz/    Span: 40 MHz</p> <p>Date: 13.DEC.2022 13:21:57</p>
<p>802.11ac vht20 Highest Channel</p>	<p>Ref: 30 dBm    *Att: 25 dB    *RBW: 1 MHz    Marker 1 [T1] 10.27 dBm *VBW: 3 MHz    *SWT: 20 ms    5.235120000 GHz</p> <p>Center: 5.24 GHz    4 MHz/    Span: 40 MHz</p> <p>Date: 13.DEC.2022 13:22:42</p>

**Maximum power spectral density**

<p>802.11ac vht40 Lowest Channel</p>	<p>Date: 23.DEC.2022 10:34:19</p>
<p>802.11ac vht40 Highest Channel</p>	<p>Date: 13.DEC.2022 13:25:33</p>
<p>802.11ac vht80 Middle Channel</p>	<p>Date: 23.DEC.2022 10:32:21</p>



**Maximum power spectral density**

<p>802.11ax hew20 Lowest Channel</p>	<p>Ref 30 dBm *Att 25 dB *RBW 1 MHz Marker 1 [T1] 10.42 dBm *VBW 3 MHz 5.181280000 GHz SWT 20 ms</p> <p>30 Offset 10 5 dB</p> <p>1. PM MAX</p> <p>Center 5.18 GHz 4 MHz/ Span 40 MHz</p> <p>Date: 13.DEC.2022 13:33:22</p>
<p>802.11ax hew20 Middle Channel</p>	<p>Ref 30 dBm *Att 25 dB *RBW 1 MHz Marker 1 [T1] 10.27 dBm *VBW 3 MHz 5.201200000 GHz SWT 20 ms</p> <p>30 Offset 10 5 dB</p> <p>1. PM MAX</p> <p>Center 5.2 GHz 4 MHz/ Span 40 MHz</p> <p>Date: 13.DEC.2022 13:34:18</p>
<p>802.11ax hew20 Highest Channel</p>	<p>Ref 30 dBm *Att 25 dB *RBW 1 MHz Marker 1 [T1] 10.36 dBm *VBW 3 MHz 5.241280000 GHz SWT 20 ms</p> <p>30 Offset 10 5 dB</p> <p>1. PM MAX</p> <p>Center 5.24 GHz 4 MHz/ Span 40 MHz</p> <p>Date: 13.DEC.2022 13:34:51</p>

### Maximum power spectral density

<p>802.11ax hew40 Lowest Channel</p>	<p>Ref 30 dBm * Att 25 dB * RBW 1 MHz * VBW 3 MHz * SWT 20 ms Marker 1 [T1] 3.99 dBm 5.193840000 GHz</p> <p>Center 5.19 GHz 8 MHz/ Span 80 MHz</p> <p>Date: 23.DEC.2022 10:33:30</p>
<p>802.11ax hew40 Highest Channel</p>	<p>Ref 30 dBm * Att 25 dB * RBW 1 MHz * VBW 3 MHz * SWT 20 ms Marker 1 [T1] 7.48 dBm 5.233840000 GHz</p> <p>Center 5.23 GHz 8 MHz/ Span 80 MHz</p> <p>Date: 13.DEC.2022 13:32:33</p>
<p>802.11ax hew80 Middle Channel</p>	<p>Ref 30 dBm * Att 25 dB * RBW 1 MHz * VBW 3 MHz * SWT 20 ms Marker 1 [T1] 0.73 dBm 5.218640000 GHz</p> <p>Center 5.21 GHz 16 MHz/ Span 160 MHz</p> <p>Date: 23.DEC.2022 10:31:07</p>

5725-5850MHz  
Chain0:

Maximum power spectral density	
802.11a Lowest Channel	<p>Ref 30 dBm    * Att 25 dB    * RBW 300 kHz    Marker 1 [T1] 6.53 dBm * VBM 1 MHz    SWT 20 ms    5.743800000 GHz</p> <p>Center 5.745 GHz    4 MHz/    Span 40 MHz</p> <p>Date: 14.DEC.2022 08:41:34</p>
802.11a Middle Channel	<p>Ref 30 dBm    * Att 25 dB    * RBW 300 kHz    Marker 1 [T1] 6.11 dBm * VBM 1 MHz    SWT 20 ms    5.781240000 GHz</p> <p>Center 5.785 GHz    4 MHz/    Span 40 MHz</p> <p>Date: 14.DEC.2022 08:42:28</p>
802.11a Highest Channel	<p>Ref 30 dBm    * Att 25 dB    * RBW 300 kHz    Marker 1 [T1] 6.16 dBm * VBM 1 MHz    SWT 20 ms    5.823720000 GHz</p> <p>Center 5.825 GHz    4 MHz/    Span 40 MHz</p> <p>Date: 14.DEC.2022 08:43:27</p>

### Maximum power spectral density

<p>802.11n ht20 Lowest Channel</p>	
<p>802.11n ht20 Middle Channel</p>	
<p>802.11n ht20 Highest Channel</p>	

### Maximum power spectral density

802.11n ht40  
Lowest Channel

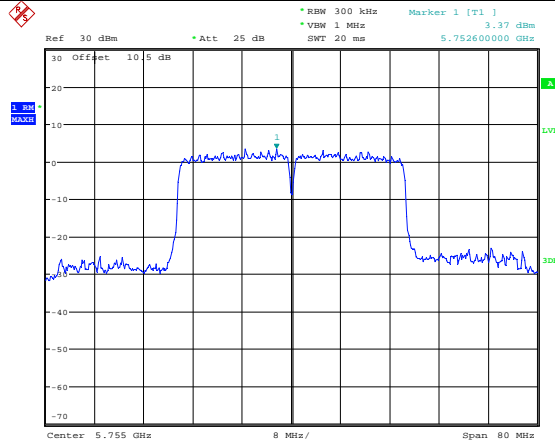

Date: 14.DEC.2022 08:52:07

802.11n ht40  
Highest Channel

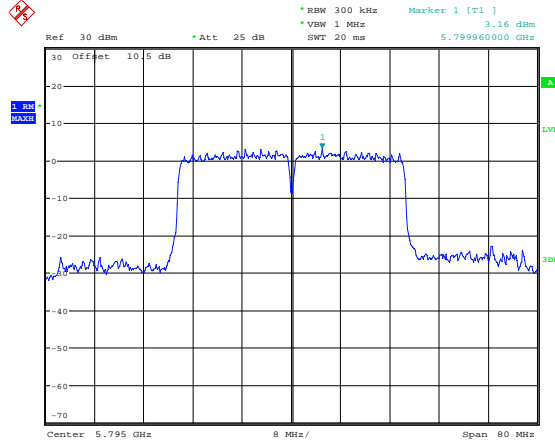

Date: 14.DEC.2022 08:52:53

**Maximum power spectral density**

802.11ac vht20  
Lowest Channel

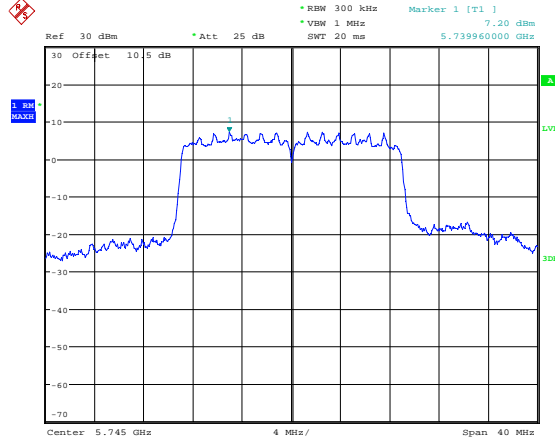

Date: 14.DEC.2022 08:47:46

802.11ac vht20  
Middle Channel

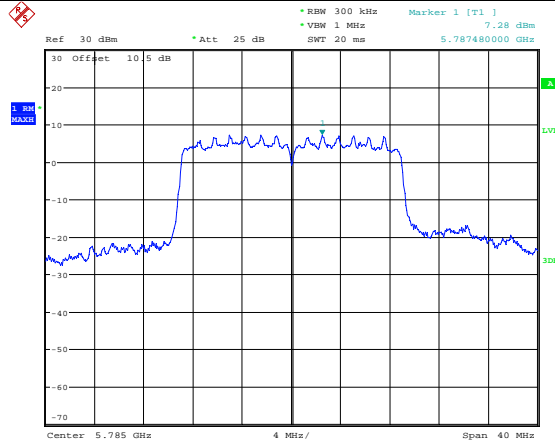

Date: 14.DEC.2022 08:48:38

802.11ac vht20  
Highest Channel

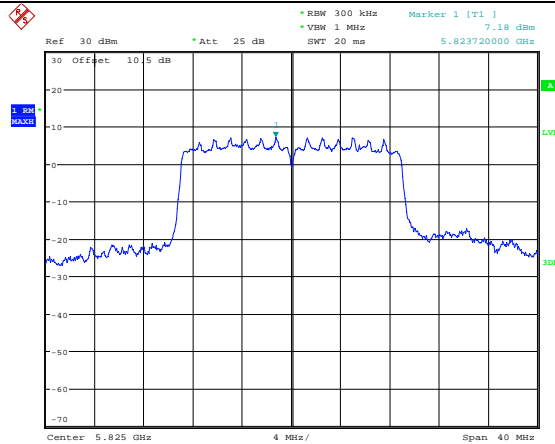

Date: 14.DEC.2022 08:49:36

### Maximum power spectral density

802.11ac vht40  
Lowest Channel

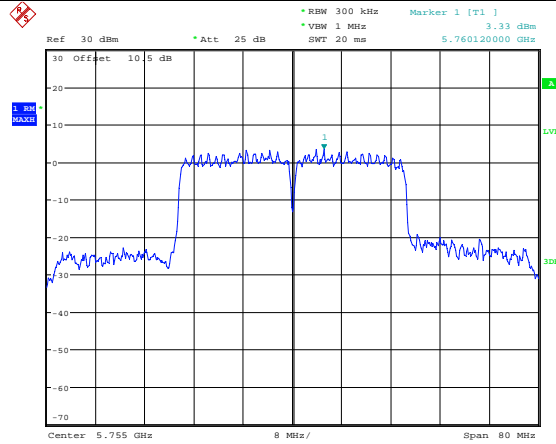

Date: 23.DEC.2022 10:59:09

802.11ac vht40  
Highest Channel

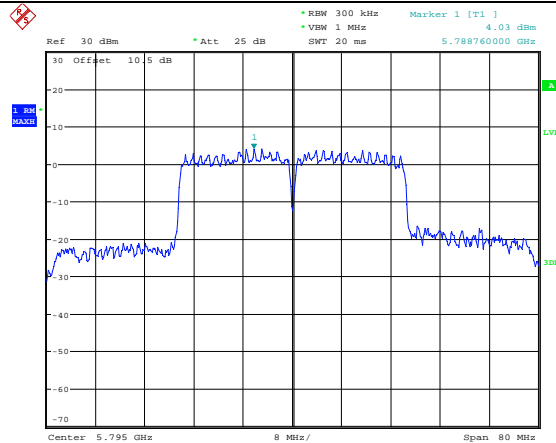

Date: 23.DEC.2022 10:59:42

802.11ac vht80  
Middle Channel

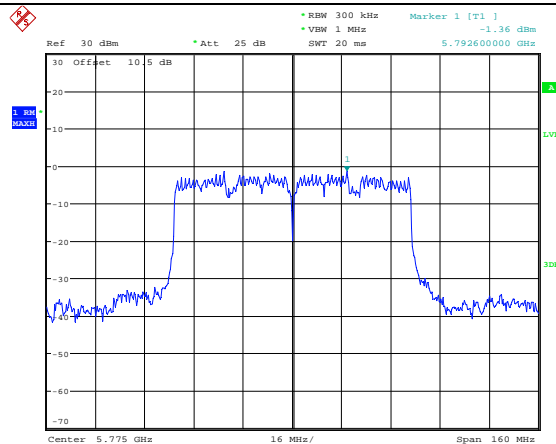

Date: 23.DEC.2022 12:05:42

**Maximum power spectral density**

<p>802.11ax hew20 Lowest Channel</p>	<p>Date: 14.DEC.2022 09:48:18</p>
<p>802.11ax hew20 Middle Channel</p>	<p>Date: 14.DEC.2022 09:49:13</p>
<p>802.11ax hew20 Highest Channel</p>	<p>Date: 14.DEC.2022 09:50:05</p>



### Maximum power spectral density

<p>802.11ax hew40 Lowest Channel</p>	<p>Date: 23.DEC.2022 12:02:21</p>
<p>802.11ax hew40 Highest Channel</p>	<p>Date: 23.DEC.2022 12:01:28</p>
<p>802.11ax hew80 Middle Channel</p>	<p>Date: 23.DEC.2022 12:04:37</p>

Chain1:

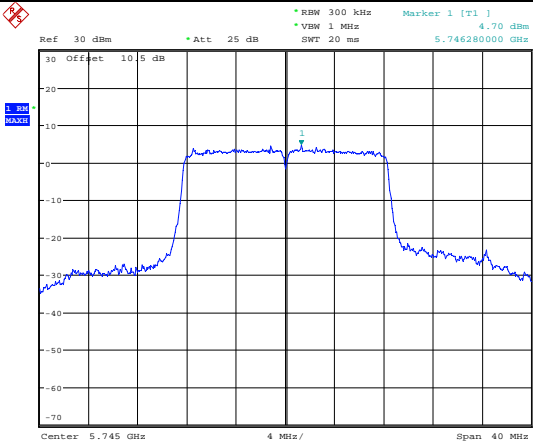
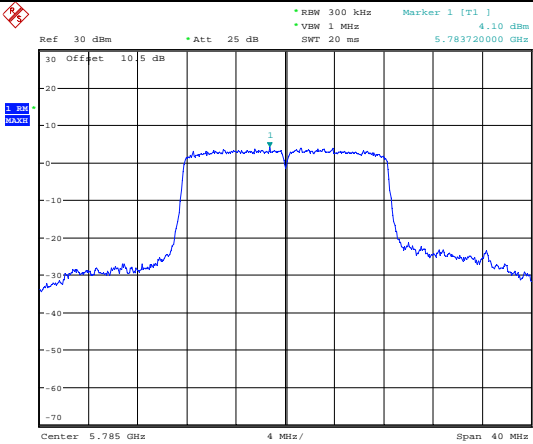
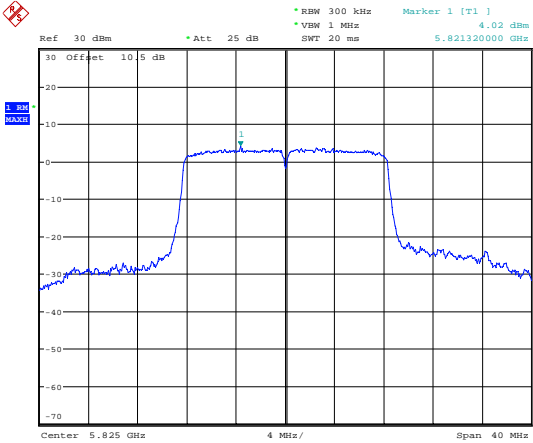
Maximum power spectral density	
802.11a Lowest Channel	 <p>Ref 30 dBm * Att 25 dB * RBW 300 kHz Marker 1 [T1] 4.70 dBm * VBW 1 MHz 5.746280000 GHz SWT 20 ms</p> <p>30 Offset 10 5 dB</p> <p>30 20 10 0 -10 -20 -30 -40 -50 -60 -70</p> <p>Center 5.745 GHz 4 MHz/ Span 40 MHz</p> <p>Date: 14.DEC.2022 09:28:05</p>
802.11a Middle Channel	 <p>Ref 30 dBm * Att 25 dB * RBW 300 kHz Marker 1 [T1] 4.10 dBm * VBW 1 MHz 5.783720000 GHz SWT 20 ms</p> <p>30 Offset 10 5 dB</p> <p>30 20 10 0 -10 -20 -30 -40 -50 -60 -70</p> <p>Center 5.785 GHz 4 MHz/ Span 40 MHz</p> <p>Date: 14.DEC.2022 09:28:53</p>
802.11a Highest Channel	 <p>Ref 30 dBm * Att 25 dB * RBW 300 kHz Marker 1 [T1] 4.02 dBm * VBW 1 MHz 5.821320000 GHz SWT 20 ms</p> <p>30 Offset 10 5 dB</p> <p>30 20 10 0 -10 -20 -30 -40 -50 -60 -70</p> <p>Center 5.825 GHz 4 MHz/ Span 40 MHz</p> <p>Date: 14.DEC.2022 09:29:53</p>

### Maximum power spectral density

<p>802.11n ht20 Lowest Channel</p>	<p>Date: 14.DEC.2022 09:21:27</p>
<p>802.11n ht20 Middle Channel</p>	<p>Date: 14.DEC.2022 09:22:48</p>
<p>802.11n ht20 Highest Channel</p>	<p>Date: 14.DEC.2022 09:23:49</p>

### Maximum power spectral density

802.11n ht40  
Lowest Channel

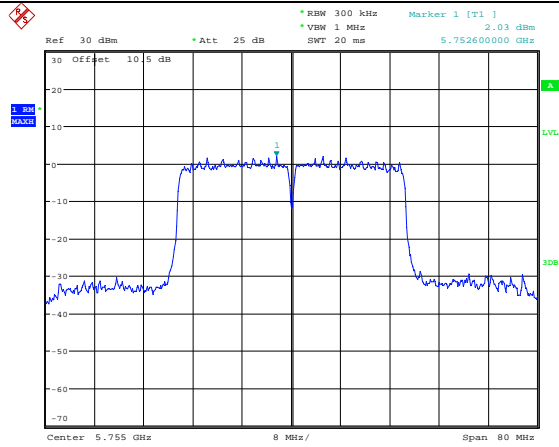

Date: 14.DEC.2022 09:17:03

802.11n ht40  
Highest Channel

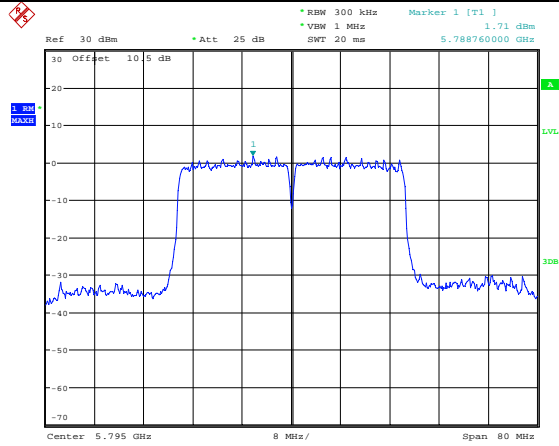

Date: 14.DEC.2022 09:17:56

**Maximum power spectral density**

<p>802.11ac vht20 Lowest Channel</p>	<p>Ref 30 dBm    * Att 25 dB    * RBW 300 kHz    Marker 1 [T1]    5.76 dBm          * VSW 1 MHz    * SWT 20 ms    5.748840000 GHz</p> <p>Center 5.745 GHz    4 MHz/    Span 40 MHz</p> <p>Date: 14.DEC.2022 09:26:50</p>
<p>802.11ac vht20 Middle Channel</p>	<p>Ref 30 dBm    * Att 25 dB    * RBW 300 kHz    Marker 1 [T1]    5.51 dBm          * VSW 1 MHz    * SWT 20 ms    5.788840000 GHz</p> <p>Center 5.785 GHz    4 MHz/    Span 40 MHz</p> <p>Date: 14.DEC.2022 09:25:54</p>
<p>802.11ac vht20 Highest Channel</p>	<p>Ref 30 dBm    * Att 25 dB    * RBW 300 kHz    Marker 1 [T1]    5.46 dBm          * VSW 1 MHz    * SWT 20 ms    5.823800000 GHz</p> <p>Center 5.825 GHz    4 MHz/    Span 40 MHz</p> <p>Date: 14.DEC.2022 09:25:04</p>

**Maximum power spectral density**

<p>802.11ac vht40 Lowest Channel</p>	<p>Date: 23.DEC.2022 10:57:48</p>
<p>802.11ac vht40 Highest Channel</p>	<p>Date: 23.DEC.2022 10:52:37</p>
<p>802.11ac vht80 Middle Channel</p>	<p>Date: 23.DEC.2022 10:48:39</p>

### Maximum power spectral density

<p>802.11ax hew20 Lowest Channel</p>	<p>Ref 30 dBm * Att 25 dB * RBW 300 kHz Marker 1 [T1] 5.57 dBm * VBW 1 MHz 5.743800000 GHz SWT 20 ms</p> <p>Center 5.745 GHz 4 MHz/ Span 40 MHz</p> <p>Date: 14.DEC.2022 09:40:06</p>
<p>802.11ax hew20 Middle Channel</p>	<p>Ref 30 dBm * Att 25 dB * RBW 300 kHz Marker 1 [T1] 5.54 dBm * VBW 1 MHz 5.783800000 GHz SWT 20 ms</p> <p>Center 5.785 GHz 4 MHz/ Span 40 MHz</p> <p>Date: 14.DEC.2022 09:39:14</p>
<p>802.11ax hew20 Highest Channel</p>	<p>Ref 30 dBm * Att 25 dB * RBW 300 kHz Marker 1 [T1] 5.58 dBm * VBW 1 MHz 5.823720000 GHz SWT 20 ms</p> <p>Center 5.825 GHz 4 MHz/ Span 40 MHz</p> <p>Date: 14.DEC.2022 09:38:18</p>

**Maximum power spectral density**

<p>802.11ax hew40 Lowest Channel</p>	<p>Date: 23.DEC.2022 10:50:48</p>
<p>802.11ax hew40 Highest Channel</p>	<p>Date: 23.DEC.2022 10:51:30</p>
<p>802.11ax hew80 Middle Channel</p>	<p>Date: 23.DEC.2022 10:47:29</p>



**4.6 Duty Cycle:**

Serial Number:	1ST2	Test Date:	2022/12/13
Test Site:	RF	Test Mode:	Transmitting
Tester:	Arthur Su	Test Result:	N/A

**Environmental Conditions:**

Temperature: (°C)	21.3	Relative Humidity: (%)	38	ATM Pressure: (kPa)	101.4
----------------------	------	---------------------------	----	------------------------	-------

**Test Equipment List and Details:**

Manufacturer	Description	Model	Serial Number	Calibration Date	Calibration Due Date
R&S	Spectrum Analyzer	FSU26	200445	2022/04/05	2023/04/04
zhuoxiang	Coaxial Cable	SMA-178	211001	Each time	N/A
eastsheep	Coaxial Attenuator	2W-SMA-JK-18G	21060301	Each time	N/A

\* Statement of Traceability: China Certification ICT Co., Ltd (Dongguan) attests that all calibrations have been performed, traceable to National Primary Standards and International System of Units (SI).

**Test Data:**

Test Modes	Ton (ms)	Ton+off (ms)	Duty cycle (%)
802.11a	1.393	1.473	94.57
802.11n ht20	0.614	0.7	87.71
802.11n ht40	0.316	0.415	76.14
802.11ac vht20	0.095	0.195	48.72
802.11ac vht40	0.079	0.178	44.38
802.11ac vht80	0.058	0.16	36.25
802.11ax hew20	0.104	0.204	50.98
802.11ax hew40	0.083	0.182	45.60
802.11ax hew80	0.074	0.174	42.53

Duty Cycle	
<p>802.11a</p>	<p>Ref 40 dBm *Att 55 dB RBW 50 MHz Marker 1 [T1 ] 0.47 dBm *VSW 30 MHz Delta 2 [T1 ] 2.370657 ms SWT 6 ms 40 Offset 10 5 dB Delta 2 [T1 ] 0.40 dB Delta 1 [T1 ] 1.47 dB Delta 1 [T1 ] 0.14 dB Center 5.2 GHz 600 <math>\mu</math>s/</p> <p>Date: 13.DEC.2022 10:02:39</p>
<p>802.11n ht20</p>	<p>Ref 40 dBm *Att 55 dB RBW 50 MHz Delta 2 [T1 ] 0.72 dB *VSW 30 MHz 699.951923 <math>\mu</math>s SWT 2.5 ms 40 Offset 10 5 dB Marker 1 [T1 ] 0.24 dBm Delta 2 [T1 ] 361.04 <math>\mu</math>s Delta 1 [T1 ] 0.04 dB Center 5.2 GHz 250 <math>\mu</math>s/</p> <p>Date: 13.DEC.2022 09:58:54</p>
<p>802.11n ht40</p>	<p>Ref 40 dBm *Att 55 dB RBW 50 MHz Delta 2 [T1 ] 0.08 dB *VSW 30 MHz 415.400641 <math>\mu</math>s SWT 1.5 ms 40 Offset 10 5 dB Marker 1 [T1 ] -0.50 dBm Delta 2 [T1 ] 582.13 <math>\mu</math>s Delta 1 [T1 ] -0.80 dB Center 5.19 GHz 150 <math>\mu</math>s/</p> <p>Date: 13.DEC.2022 10:00:55</p>

### Duty Cycle

<p><b>802.11ac vht20</b></p>	<p>Date: 13.DEC.2022 09:51:21</p>
<p><b>802.11ac vht40</b></p>	<p>Date: 13.DEC.2022 09:53:29</p>
<p><b>802.11ac vht80</b></p>	<p>Date: 13.DEC.2022 09:56:13</p>

### Duty Cycle

802.11ax hew20

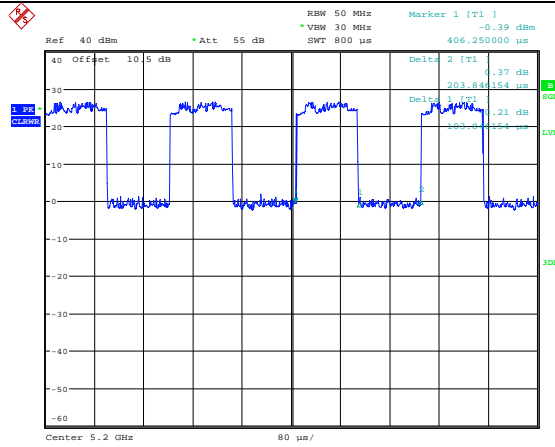

Date: 13.DEC.2022 09:38:35

802.11 ax hew40

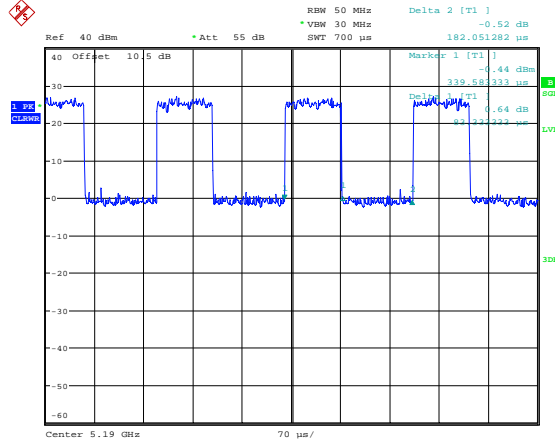

Date: 13.DEC.2022 09:36:51

802.11ax hew80

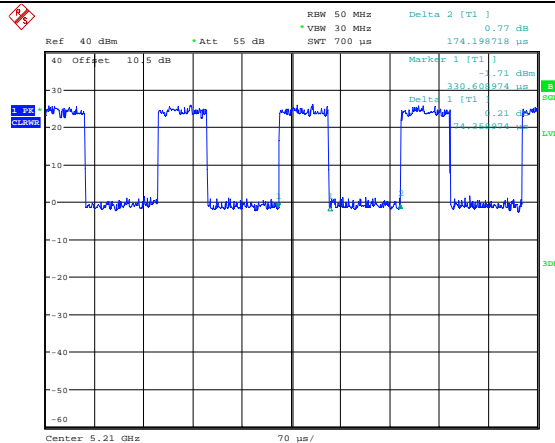

Date: 13.DEC.2022 09:35:27

## 5. RF EXPOSURE EVALUATION

### 5.1 Applicable Standard

According to §1.1307(b)(3)(i)

(B) Or the available maximum time-averaged power or effective radiated power (ERP), whichever is greater, is less than or equal to the threshold  $P_{th}$  (mW) described in the following formula. This method shall only be used at separation distances (cm) from 0.5 centimeters to 40 centimeters and at frequencies from 0.3 GHz to 6 GHz (inclusive).  $P_{th}$  is given by:

$$P_{th} \text{ (mW)} = \begin{cases} ERP_{20 \text{ cm}} (d/20 \text{ cm})^x & d \leq 20 \text{ cm} \\ ERP_{20 \text{ cm}} & 20 \text{ cm} < d \leq 40 \text{ cm} \end{cases}$$

Where

$$x = -\log_{10} \left( \frac{60}{ERP_{20 \text{ cm}} \sqrt{f}} \right) \text{ and } f \text{ is in GHz;}$$

and

$$ERP_{20 \text{ cm}} \text{ (mW)} = \begin{cases} 2040f & 0.3 \text{ GHz} \leq f < 1.5 \text{ GHz} \\ 3060 & 1.5 \text{ GHz} \leq f \leq 6 \text{ GHz} \end{cases}$$

$d$  = the separation distance (cm);

### 5.2 Measurement Result

Operation Modes	Frequency (MHz)	Distance (mm)	$P_{th}$		Maximum Conducted Power including Tune-up Tolerance (dBm)	Antenna Gain (dBi)	ERP (P) (dBm)	ERP (P) (mW)	Exemption
			(mW)	(dBm)					
WLAN 2.4G	2412-2462	200	3060	<b>34.86</b>	27	6.39	31.24	1330.45	Compliant
WLAN 5G	5150-5250	200	3060	<b>34.86</b>	26	6.32	30.17	1039.92	Compliant
	5725-5850	200	3060	<b>34.86</b>	26	6.38	30.23	1054.39	Compliant

Note:

Antenna gain includes beamforming gain. The Maximum Conducted Power including Tune-up Tolerance was declared by manufacturer.

WLAN 2.4G and 5G can't transmit simultaneously.

**Result: The device compliant the Exemption at 20cm distances.**

**===== END OF REPORT =====**