

FCC Radio Test Report

FCC ID: V7TMESH3FV31

This report concerns: Original Grant

Project No. : 2105C079
Equipment : AC1200 Whole Home Mesh WiFi System
Brand Name : Tenda
Test Model : Mesh3f
Series Model : MW3
Applicant : SHENZHEN TENDA TECHNOLOGY CO.,LTD
Address : 6-8 Floor, Tower E3, No. 1001, Zhongshanyuan Road, Nanshan District, Shenzhen, China. 518052
Manufacturer : SHENZHEN TENDA TECHNOLOGY CO.,LTD
Address : 6-8 Floor, Tower E3, No. 1001, Zhongshanyuan Road, Nanshan District, Shenzhen, China. 518052
Date of Receipt : May 14, 2021
Date of Test : May 17, 2021 ~ Jun. 19, 2021
Issued Date : Jul. 08, 2021
Report Version : R01
Test Sample : Engineering Sample No.: DG2021051721 for conducted, DG2021051722 for radiated.
Standard(s) : FCC CFR Title 47, Part 15, Subpart C
FCC KDB 558074 D01 15.247 Meas Guidance v05r02
FCC KDB 662911 D01 Multiple Transmitter Output v02r01
ANSI C63.10-2013

The above equipment has been tested and found compliance with the requirement of the relative standards by BTL Inc.



Prepared by : Antony Liang



Approved by : Ethan Ma

Add: No.3, Jinshagang 1st Road, Shixia, Dalang Town, Dongguan, Guangdong, China.

Tel: +86-769-8318-3000

Web: www.newbtl.com



TESTING CERT #5123.02

Declaration

BTL represents to the client that testing is done in accordance with standard procedures as applicable and that test instruments used has been calibrated with standards traceable to international standard(s) and/or national standard(s).

BTL's reports apply only to the specific samples tested under conditions. It is manufacture's responsibility to ensure that additional production units of this model are manufactured with the identical electrical and mechanical components. **BTL** shall have no liability for any declarations, inferences or generalizations drawn by the client or others from **BTL** issued reports.

The report must not be used by the client to claim product certification, approval, or endorsement by NVLAP, NIST, A2LA, or any agency of the U.S. Government.

This report is the confidential property of the client. As a mutual protection to the clients, the public and ourselves, the test report shall not be reproduced, except in full, without our written approval.

BTL's laboratory quality assurance procedures are in compliance with the **ISO/IEC 17025** requirements, and accredited by the conformity assessment authorities listed in this test report.

BTL is not responsible for the sampling stage, so the results only apply to the sample as received.

The information, data and test plan are provided by manufacturer which may affect the validity of results, so it is manufacturer's responsibility to ensure that the apparatus meets the essential requirements of applied standards and in all the possible configurations as representative of its intended use.

Limitation

For the use of the authority's logo is limited unless the Test Standard(s)/Scope(s)/Item(s) mentioned in this test report is (are) included in the conformity assessment authorities acceptance respective.

Please note that the measurement uncertainty is provided for informational purpose only and are not use in determining the Pass/Fail results.

Table of Contents	Page
REPORT ISSUED HISTORY	6
1 . SUMMARY OF TEST RESULTS	7
1.1 TEST FACILITY	8
1.2 MEASUREMENT UNCERTAINTY	8
1.3 TEST ENVIRONMENT CONDITIONS	9
2 . GENERAL INFORMATION	10
2.1 GENERAL DESCRIPTION OF EUT	10
2.2 DESCRIPTION OF TEST MODES	12
2.3 PARAMETERS OF TEST SOFTWARE	14
2.4 DUTY CYCLE	15
2.5 BLOCK DIAGRAM SHOWING THE CONFIGURATION OF SYSTEM TESTED	16
2.6 SUPPORT UNITS	16
3 . AC POWER LINE CONDUCTED EMISSIONS	17
3.1 LIMIT	17
3.2 TEST PROCEDURE	17
3.3 DEVIATION FROM TEST STANDARD	17
3.4 TEST SETUP	18
3.5 EUT OPERATION CONDITIONS	18
3.6 TEST RESULTS	18
4 . RADIATED EMISSIONS	19
4.1 LIMIT	19
4.2 TEST PROCEDURE	19
4.3 DEVIATION FROM TEST STANDARD	21
4.4 TEST SETUP	21
4.5 EUT OPERATION CONDITIONS	22
4.6 TEST RESULTS - 9 KHZ TO 30 MHZ	22
4.7 TEST RESULTS - 30 MHZ TO 1000 MHZ	22
4.8 TEST RESULTS - ABOVE 1000 MHZ	22
5 . BANDWIDTH	23
5.1 LIMIT	23
5.2 TEST PROCEDURE	23
5.3 DEVIATION FROM STANDARD	23
5.4 TEST SETUP	23

Table of Contents	Page
5.5 EUT OPERATION CONDITIONS	23
5.6 TEST RESULTS	23
6 . MAXIMUM OUTPUT POWER	24
6.1 LIMIT	24
6.2 TEST PROCEDURE	24
6.3 DEVIATION FROM STANDARD	24
6.4 TEST SETUP	24
6.5 EUT OPERATION CONDITIONS	24
6.6 TEST RESULTS	24
7 . CONDUCTED SPURIOUS EMISSIONS	25
7.1 LIMIT	25
7.2 TEST PROCEDURE	25
7.3 DEVIATION FROM STANDARD	25
7.4 TEST SETUP	25
7.5 EUT OPERATION CONDITIONS	25
7.6 TEST RESULTS	25
8 . POWER SPECTRAL DENSITY	26
8.1 LIMIT	26
8.2 TEST PROCEDURE	26
8.3 DEVIATION FROM STANDARD	26
8.4 TEST SETUP	26
8.5 EUT OPERATION CONDITIONS	26
8.6 TEST RESULTS	26
9 . MEASUREMENT INSTRUMENTS LIST	27
10 . EUT TEST PHOTO	29
APPENDIX A - AC POWER LINE CONDUCTED EMISSIONS	34
APPENDIX B - RADIATED EMISSION - 9 KHZ TO 30 MHZ	39
APPENDIX C - RADIATED EMISSION - 30 MHZ TO 1000 MHZ	44
APPENDIX D - RADIATED EMISSION- ABOVE 1000 MHZ	47
APPENDIX E - BANDWIDTH	98
APPENDIX F - MAXIMUM OUTPUT POWER	103
APPENDIX G - CONDUCTED SPURIOUS EMISSIONS	114

Table of Contents**Page****APPENDIX H - POWER SPECTRAL DENSITY****121**

REPORT ISSUED HISTORY

Report Version	Description	Issued Date
R00	Original Issue.	Jul. 05, 2021
R01	Modify the comments.	Jul. 08, 2021

1. SUMMARY OF TEST RESULTS

Test procedures according to the technical standard(s):

FCC CFR Title 47, Part 15, Subpart C				
Standard(s) Section	Test Item	Test Result	Judgment	Remark
15.207	AC Power Line Conducted Emissions	APPENDIX A	PASS	-----
15.247(d) 15.205(a) 15.209(a)	Radiated Emissions	APPENDIX B APPENDIX C APPENDIX D	PASS	-----
15.247(a)(2)	Bandwidth	APPENDIX E	PASS	-----
15.247(b)(3)	Maximum Output Power	APPENDIX F	PASS	-----
15.247(d)	Conducted Spurious Emissions	APPENDIX G	PASS	-----
15.247(e)	Power Spectral Density	APPENDIX H	PASS	-----
15.203	Antenna Requirement	-----	PASS	Note(2)

Note:

- (1) "N/A" denotes test is not applicable in this test report.
- (2) The device what use a permanently attached antenna were considered sufficient to comply with the provisions of 15.203.

1.1 TEST FACILITY

The test facilities used to collect the test data in this report is at the location of No.3, Jinshagang 1st Road, Shixia, Dalang Town, Dongguan, Guangdong, China
 BTL's Test Firm Registration Number for FCC: 357015
 BTL's Designation Number for FCC: CN1240

1.2 MEASUREMENT UNCERTAINTY

ISO/IEC 17025 requires that an estimate of the measurement uncertainties associated with the emissions test results be included in the report. The measurement uncertainties given below are based on a 95% confidence level (based on a coverage factor (k=2))
 The BTL measurement uncertainty as below table:

A. AC power line conducted emissions test:

Test Site	Method	Measurement Frequency Range	U, (dB)
DG-C02	CISPR	150kHz ~ 30MHz	2.68

B. Radiated emissions test:

Test Site	Method	Measurement Frequency Range	Ant. H / V	U, (dB)
DG-CB03	CISPR	9kHz ~ 30MHz	-	3.02
		30MHz ~ 200MHz	V	4.26
		30MHz ~ 200MHz	H	3.38
		200MHz ~ 1,000MHz	V	3.98
		200MHz ~ 1,000MHz	H	3.94
		1GHz ~ 6GHz	-	3.96
		6GHz ~ 18GHz	-	5.24
		18GHz ~ 26.5GHz	-	3.62
		26.5GHz ~ 40GHz	-	4.00

C. Other Measurement:

Test Item	Uncertainty
Bandwidth	±3.8 %
Maximum Output Power	±0.95 dB
Conducted Spurious Emission	±2.71 dB
Power Spectral Density	±0.86 dB
Temperature	±0.08 °C
Humidity	±1.5%

Note: Unless specifically mentioned, the uncertainty of measurement has not been taken into account to declare the compliance or non-compliance to the specification.

1.3 TEST ENVIRONMENT CONDITIONS

Test Item	Temperature	Humidity	Test Voltage	Tested By
AC Power Line Conducted Emissions	25°C	53%	AC 240V/50Hz AC 120V/60Hz	Gerry Zhao
Radiated Emissions-9kHz to 30 MHz	25°C	60%	AC 120V/60Hz	Hayden Chen
Radiated Emissions-30MHz to 1000MHz	22°C	54%	AC 120V/60Hz	Hayden Chen
Radiated Emissions-Above 1000MHz	22°C	54%	AC 120V/60Hz	Hayden Chen
Bandwidth	25°C	50%	DC 12V	Jesse Wang
Maximum Output Power	25°C	50%	DC 12V	Hand Huang
Conducted Spurious Emissions	25°C	50%	DC 12V	Jesse Wang
Power Spectral Density	25°C	50%	DC 12V	Jesse Wang

2. GENERAL INFORMATION

2.1 GENERAL DESCRIPTION OF EUT

Equipment	AC1200 Whole Home Mesh WiFi System
Brand Name	Tenda
Test Model	Mesh3f
Series Model	MW3
Model Difference(s)	Only the model name is different.
Power Source	DC Voltage supplied from AC adapter. Model: BN073-A12012U
Power Rating	I/P: 100-240V ~ 50/60Hz, 0.4A O/P: 12V $\overline{=}$ 1A
Operation Frequency	2412 MHz ~ 2462 MHz
Modulation Type	IEEE 802.11b: DSSS IEEE 802.11g: OFDM IEEE 802.11n: OFDM
Bit Rate of Transmitter	IEEE 802.11b: 11/5.5/2/1 Mbps IEEE 802.11g: 54/48/36/24/18/12/9/6 Mbps IEEE 802.11n: up to 300 Mbps
Maximum Output Power Non Beamforming	IEEE 802.11n(HT20): 29.94 dBm (0.9863 W)
Maximum Average Power Non Beamforming	IEEE 802.11b: 22.82 dBm (0.1914 W)
Maximum Output Power Beamforming	IEEE 802.11n(HT20): 29.73 dBm (0.9397 W)
Maximum Average Power Beamforming	IEEE 802.11n(HT20): 22.69 dBm (0.1858 W)

Note:

1. For a more detailed features description, please refer to the manufacturer's specifications or the user's manual.

2. Channel List:

CH01 - CH11 for IEEE 802.11b, IEEE 802.11g, IEEE 802.11n(HT20) CH03 - CH09 for IEEE 802.11n(HT40)							
Channel	Frequency (MHz)	Channel	Frequency (MHz)	Channel	Frequency (MHz)	Channel	Frequency (MHz)
01	2412	04	2427	07	2442	10	2457
02	2417	05	2432	08	2447	11	2462
03	2422	06	2437	09	2452		

3. Antenna Specification:

Ant.	Brand	Model Name	Antenna Type	Connector	Gain (dBi)
1	N/A	N/A	Internal	N/A	3
2	N/A	N/A	Internal	N/A	3

Note:

- This EUT supports CDD, and all antennas have the same gain, Directional gain = $G_{ANT} + \text{Array Gain}$. For power measurements, $\text{Array Gain} = 0\text{dB}$ ($N_{ANT} \leq 4$), so the Directional gain = 3. For power spectral density measurements, $N_{ANT} = 2$, $N_{SS} = 1$. So the Directional gain = $G_{ANT} + \text{Array Gain} = G_{ANT} + 10\log(N_{ANT}/N_{SS})\text{dBi} = 3 + 10\log(2/1)\text{dBi} = 6.01$. Then, the power spectral density limit is $8 - (6.01 - 6) = 7.99$.
- Beamforming gain: 3dB. Directional gain = $3 + 3 = 6\text{dB}$.
- The antenna gain and beamforming gain are provided by the manufacturer.

4. Table for Antenna Configuration:
For Non Beamforming:

Operating Mode	TX Mode	1TX	2TX
IEEE 802.11b		V (Ant. 1)	-
IEEE 802.11g		V (Ant. 1)	-
IEEE 802.11n(HT20)		-	V(Ant. 1 + Ant. 2)
IEEE 802.11n(HT40)		-	V(Ant. 1 + Ant. 2)

For Non Beamforming:

Operating Mode	TX Mode	2TX
IEEE 802.11n(HT20)		V(Ant. 1 + Ant. 2)
IEEE 802.11n(HT40)		V(Ant. 1 + Ant. 2)

2.2 DESCRIPTION OF TEST MODES

The test system was pre-tested based on the consideration of all possible combinations of EUT operation mode.

Pretest Mode	Description
Mode 1	TX B Mode Channel 01/06/11
Mode 2	TX G Mode Channel 01/06/11
Mode 3	TX N(HT20) Mode Channel 01/06/11
Mode 4	TX N(HT40) Mode Channel 03/06/09
Mode 5	TX N(HT20) Mode Channel 06

Following mode(s) was (were) found to be the worst case(s) and selected for the final test.

AC power line conducted emissions test	
Final Test Mode	Description
Mode 5	TX N(HT20) Mode Channel 06

Radiated emissions test - Below 1GHz	
Final Test Mode	Description
Mode 5	TX N(HT20) Mode Channel 06

Radiated emissions test- Above 1GHz	
Final Test Mode	Description
Mode 1	TX B Mode Channel 01/06/11
Mode 2	TX G Mode Channel 01/06/11
Mode 3	TX N(HT20) Mode Channel 01/06/11
Mode 4	TX N(HT40) Mode Channel 03/06/09

Conducted test	
Final Test Mode	Description
Mode 1	TX B Mode Channel 01/06/11
Mode 2	TX G Mode Channel 01/06/11
Mode 3	TX N(HT20) Mode Channel 01/06/11
Mode 4	TX N(HT40) Mode Channel 03/06/09

NOTE:

- (1) All the bit rate of transmitter have been tested and found the lowest rate is found to be the worst case and recorded.
- (2) For AC power line conducted emissions and radiated emission below 1 GHz test, the TX N(HT20) Mode Channel 06 is found to be the worst case and recorded.
- (3) For radiated emission above 1 GHz test, the spurious points of 1GHz~26.5GHz have been pre-tested and in this report only recorded the worst case. The remaining spurious points are all below the limit value of 20dB.
- (4) The measurements for Output Power are tested, the Non Beamforming and Beamforming are recorded in the report. The worst case is Non Beamforming and only the worst case is documented for other test items.
- (5) For AC power line conducted emissions and radiated emissions below 1 GHz test, all adapters had been pre-tested and in this report only recorded the worst case.
- (6) For radiated emissions, the TX WLAN 2.4G B Mode 2437MHz + WLAN 5G A Mode 5745MHz was found the worst case of simultaneous transmission and recorded.

2.3 PARAMETERS OF TEST SOFTWARE

Non Beamforming

Test Software Version	MP_TEST		
Frequency (MHz)	2412	2437	2462
IEEE 802.11b	103	116	94
IEEE 802.11g	83	100	74
IEEE 802.11n(HT20)	79/72	97/90	75/68
Frequency (MHz)	2422	2437	2452
IEEE 802.11n(HT40)	80/73	80/73	67/61

Beamforming

Test Software Version	MP_TEST		
Frequency (MHz)	2412	2437	2462
IEEE 802.11n(HT20)	78/71	96/89	74/67
Frequency (MHz)	2422	2437	2452
IEEE 802.11n(HT40)	79/72	79/72	66/60

2.4 DUTY CYCLE

IEEE 802.11b

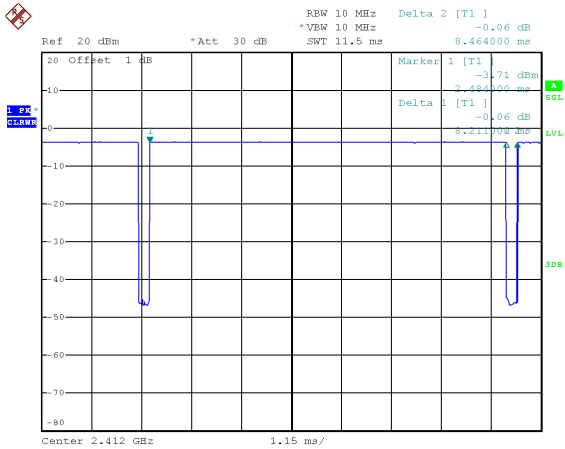

Date: 18.MAY.2021 10:23:01

Duty cycle = 8.211 ms / 8.464 ms = 97.01%
 Duty Factor = $10 \log(1/\text{Duty cycle}) = 0.13$

IEEE 802.11g

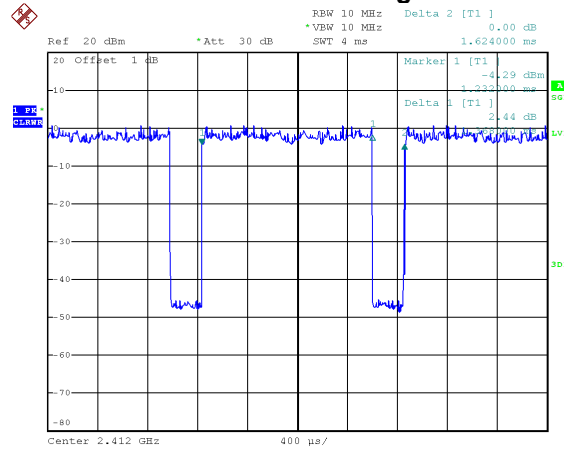

Date: 18.MAY.2021 10:23:23

Duty cycle = 1.368 ms / 1.624 ms = 84.24%
 Duty Factor = $10 \log(1/\text{Duty cycle}) = 0.74$

IEEE 802.11n(HT20)

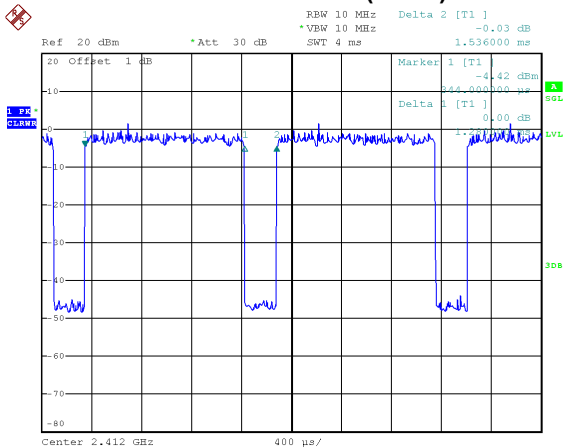

Date: 18.MAY.2021 10:23:45

Duty cycle = 1.280 ms / 1.536 ms = 83.33%
 Duty Factor = $10 \log(1/\text{Duty cycle}) = 0.79$

IEEE 802.11n(HT40)

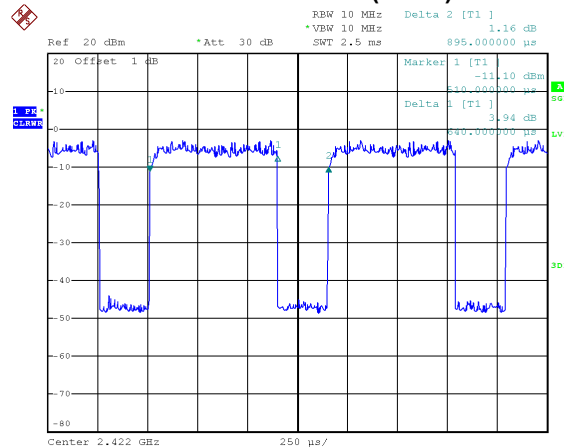

Date: 18.MAY.2021 10:24:01

Duty cycle = 0.640 ms / 0.895 ms = 71.51%
 Duty Factor = $10 \log(1/\text{Duty cycle}) = 1.46$

NOTE:

For IEEE 802.11b:

For radiated emissions frequency above 1 GHz, the resolution bandwidth of test receiver/spectrum analyzer is 1 MHz and the video bandwidth is 122 Hz.

For IEEE 802.11g:

For radiated emissions frequency above 1 GHz, the resolution bandwidth of test receiver/spectrum analyzer is 1 MHz and the video bandwidth is 731 Hz.

For IEEE 802.11n(HT20):

For radiated emissions frequency above 1 GHz, the resolution bandwidth of test receiver/spectrum analyzer is 1 MHz and the video bandwidth is 781 Hz.

For IEEE 802.11n(HT40):

For radiated emissions frequency above 1 GHz, the resolution bandwidth of test receiver/spectrum analyzer is 1 MHz and the video bandwidth is 1562 Hz.

2.5 BLOCK DIAGRAM SHOWING THE CONFIGURATION OF SYSTEM TESTED

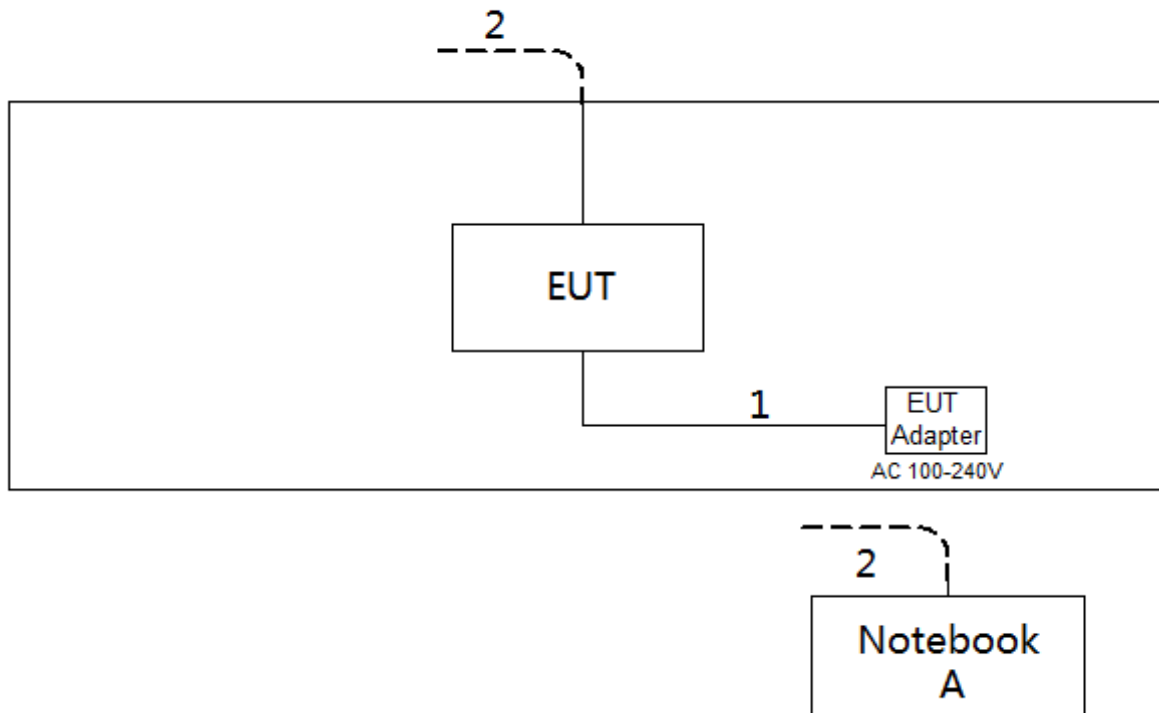

2.6 SUPPORT UNITS

Item	Equipment	Brand	Model No.	Series No.
A	Notebook	Dell	Inspiron 15-7559	N/A

Item	Cable Type	Shielded Type	Ferrite Core	Length
1	DC Cable	NO	NO	1.5m
2	RJ45 Cable	NO	NO	10m

3. AC POWER LINE CONDUCTED EMISSIONS

3.1 LIMIT

Frequency of Emission (MHz)	Limit (dB μ V)	
	Quasi-peak	Average
0.15 - 0.5	66 to 56*	56 to 46*
0.5 - 5.0	56	46
5.0 - 30.0	60	50

NOTE:

- (1) The tighter limit applies at the band edges.
- (2) The limit of "*" marked band means the limitation decreases linearly with the logarithm of the frequency in the range.

3.2 TEST PROCEDURE

- a. The EUT was placed 0.8 meters from the horizontal ground plane with EUT being connected to the power mains through a line impedance stabilization network (LISN). All other support equipment powered from additional LISN(s). The LISN provide 50 Ohm/ 50uH of coupling impedance for the measuring instrument.
- b. Interconnecting cables that hang closer than 40 cm to the ground plane shall be folded back and forth in the center forming a bundle 30 to 40 cm long.
- c. I/O cables that are not connected to a peripheral shall be bundled in the center. The end of the cable may be terminated, if required, using the correct terminating impedance. The overall length shall not exceed 1 m.
- d. LISN at least 80 cm from nearest part of EUT chassis.
- e. For the actual test configuration, please refer to the related Item -EUT Test Photos.

The following table is the setting of the receiver:

Receiver Parameters	Setting
Start Frequency	0.15 MHz
Stop Frequency	30 MHz
IF Bandwidth	9 kHz

3.3 DEVIATION FROM TEST STANDARD

No deviation.

3.4 TEST SETUP

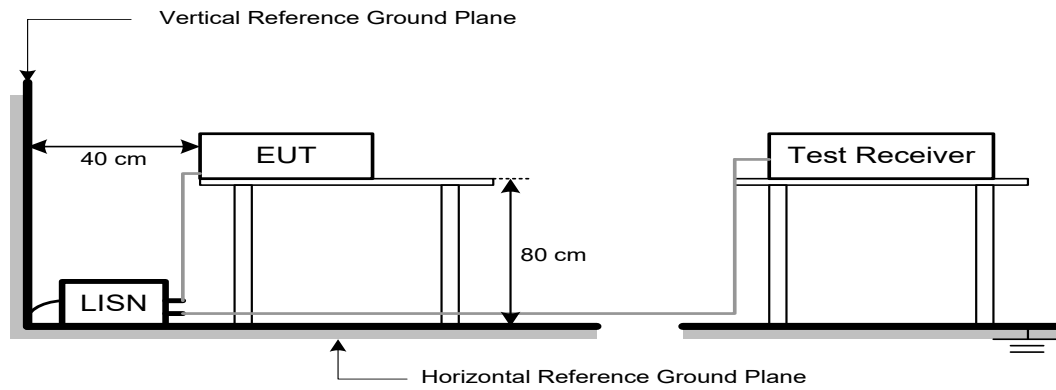

3.5 EUT OPERATION CONDITIONS

EUT was programmed to be in continuously transmitting mode.

3.6 TEST RESULTS

Please refer to the APPENDIX A.

4. RADIATED EMISSIONS

4.1 LIMIT

In case the emission fall within the restricted band specified on 15.205(a), then the 15.209(a) limit in the table below has to be followed.

LIMITS OF RADIATED EMISSION MEASUREMENT (9 kHz-1000 MHz)

Frequency (MHz)	Field Strength (microvolts/meter)	Measurement Distance (meters)
0.009-0.490	2400/F(kHz)	300
0.490-1.705	24000/F(kHz)	30
1.705-30.0	30	30
30-88	100	3
88-216	150	3
216-960	200	3
Above 960	500	3

LIMITS OF RADIATED EMISSION MEASUREMENT (Above 1000 MHz)

Frequency (MHz)	(dBuV/m at 3 m)	
	Peak	Average
Above 1000	74	54

NOTE:

- (1) The limit for radiated test was performed according to FCC CFR Title 47, Part 15, Subpart C.
- (2) The tighter limit applies at the band edges.
- (3) Emission level (dBuV/m)=20log Emission level (uV/m).

4.2 TEST PROCEDURE

- a. The measuring distance of 3 m shall be used for measurements. The EUT was placed on the top of a rotating table 0.8 meter above the ground at a 3 meter semi-anechoic chamber. The table was rotated 360 degrees to determine the position of the highest radiation.(below 1 GHz)
- b. The measuring distance of 3 m shall be used for measurements. The EUT was placed on the top of a rotating table 1.5 meter above the ground at a 3 meter semi-anechoic chamber. The table was rotated 360 degrees to determine the position of the highest radiation.(above 1 GHz)
- c. The height of the equipment or of the substitution antenna shall be 0.8m or 1.5m; the height of the test antenna shall vary between 1 m to 4 m. Both horizontal and vertical polarizations of the antenna are set to make the measurement.
- d. For each suspected emission, the EUT was arranged to its worst case and then the antenna was tuned to heights find the maximum reading (used Bore sight function).
- e. The receiver system was set to peak and average detect function and specified bandwidth with maximum hold mode when the test frequency is above 1 GHz.
- f. The initial step in collecting radiated emission data is a receiver peak detector mode pre-scanning the measurement frequency range. Significant peaks are then marked and then Quasi Peak detector mode re-measured.
- g. All readings are Peak unless otherwise stated QP in column of Note. Peak denotes that the Peak reading compliance with the QP Limits and then QP Mode measurement didn't perform. (below 1 GHz)
- h. All readings are Peak Mode value unless otherwise stated AVG in column of Note. If the Peak Mode Measured value compliance with the Peak Limits and lower than AVG Limits, the EUT shall be deemed to meet both Peak & AVG Limits and then only Peak Mode was measured, but AVG Mode didn't perform. (above 1 GHz)
- i. For the actual test configuration, please refer to the related Item -EUT Test Photos.

The following table is the setting of the receiver:

Spectrum Parameters	Setting
Start ~ Stop Frequency	9 kHz~150 kHz for RBW 200 Hz
Start ~ Stop Frequency	0.15 MHz~30 MHz for RBW 9 kHz
Start ~ Stop Frequency	30 MHz~1000 MHz for RBW 100 kHz

Spectrum Parameters	Setting
Start Frequency	1000 MHz
Stop Frequency	10th carrier harmonic
RBW / VBW (Emission in restricted band)	1 MHz / 3 MHz for PK value 1 MHz / 1/T Hz for AVG value

Receiver Parameters	Setting
Start ~ Stop Frequency	9 kHz~90 kHz for PK/AVG detector
Start ~ Stop Frequency	90 kHz~110 kHz for QP detector
Start ~ Stop Frequency	110 kHz~490 kHz for PK/AVG detector
Start ~ Stop Frequency	490 kHz~30 MHz for QP detector
Start ~ Stop Frequency	30 MHz~1000 MHz for QP detector
Start ~ Stop Frequency	1 GHz~26.5 GHz for PK/AVG detector

4.3 DEVIATION FROM TEST STANDARD

No deviation.

4.4 TEST SETUP

9 kHz to 30 MHz

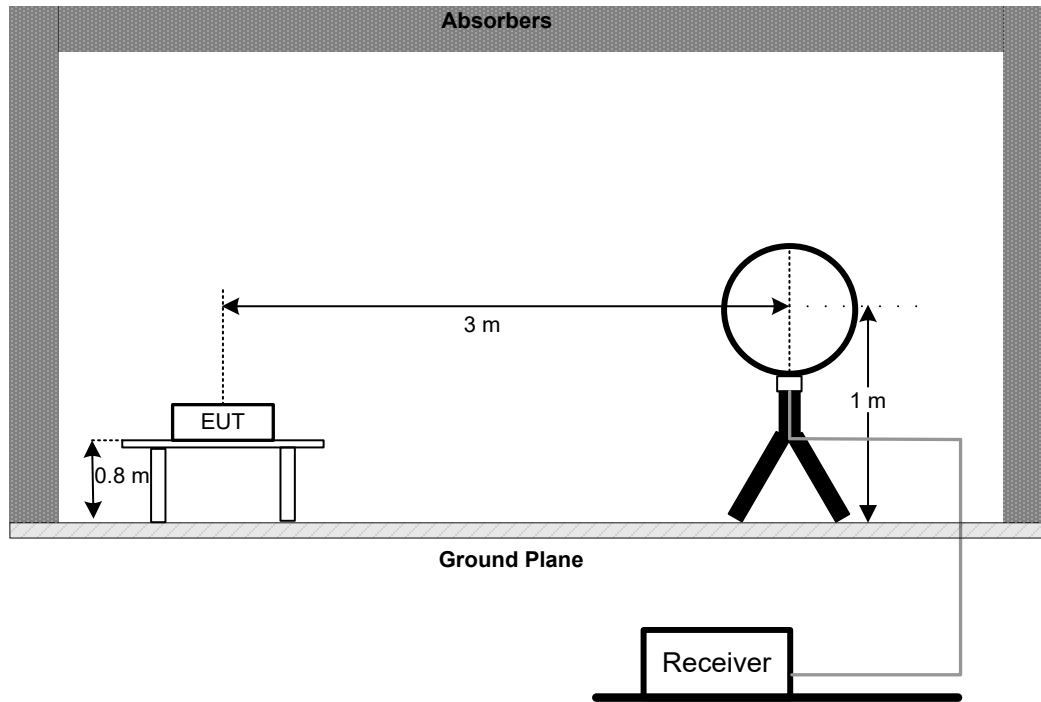

30 MHz to 1 GHz

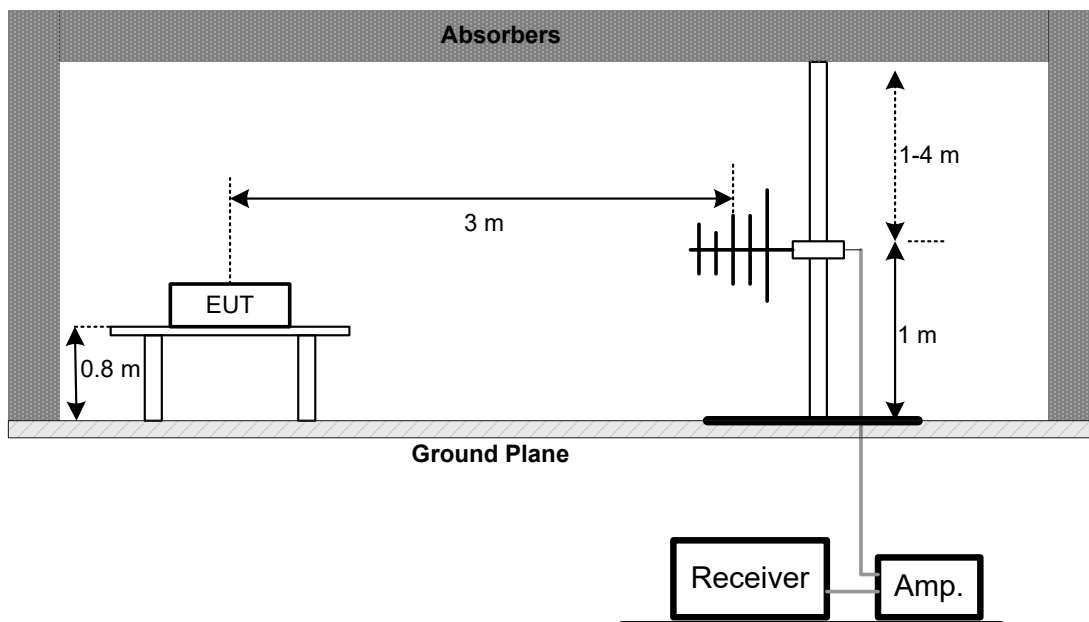

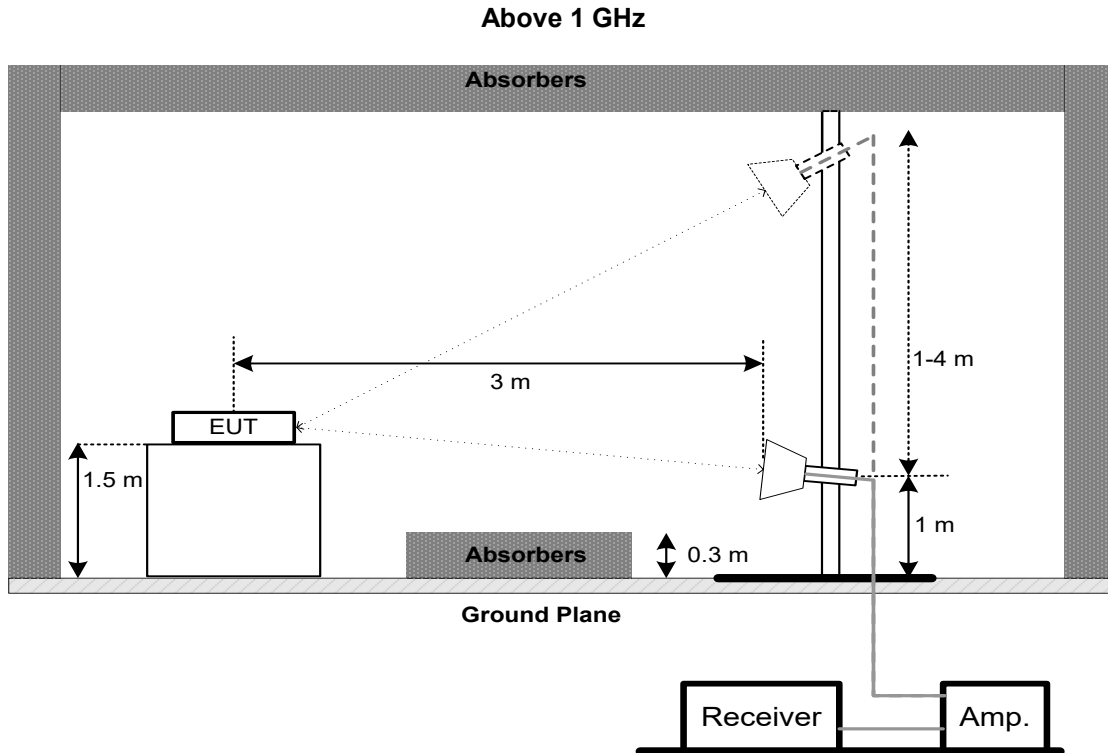

4.5 EUT OPERATION CONDITIONS

The EUT was programmed to be in continuously transmitting mode.

4.6 TEST RESULTS - 9 KHZ TO 30 MHZ

Please refer to the APPENDIX B.

Remark:

- (1) Distance extrapolation factor = $40 \log (\text{specific distance} / \text{test distance})$ (dB).
- (2) Limit line = specific limits (dBuV) + distance extrapolation factor.

4.7 TEST RESULTS - 30 MHZ TO 1000 MHZ

Please refer to the APPENDIX C.

4.8 TEST RESULTS - ABOVE 1000 MHZ

Please refer to the APPENDIX D.

Remark:

- (1) No limit: This is fundamental signal, the judgment is not applicable.
For fundamental signal judgment was referred to Peak output test.

5. BANDWIDTH

5.1 LIMIT

Section	Test Item	Limit
FCC 15.247(a)(2)	6 dB Bandwidth	Minimum 500 kHz
	99% Emission Bandwidth	-

5.2 TEST PROCEDURE

- The EUT was directly connected to the spectrum analyzer and antenna output port as show in the block diagram below.
- The following table is the setting of the spectrum analyzer:

For 6 dB Bandwidth:

Spectrum Parameters	Setting
Span Frequency	> Measurement Bandwidth
RBW	100 kHz
VBW	300 kHz
Detector	Peak
Trace	Max Hold
Sweep Time	Auto

For 99% Emission Bandwidth:

Spectrum Parameters	Setting
Span Frequency	Between 1.5 times and 5.0 times the OBW
RBW	300 kHz For 20MHz 1 MHz For 40MHz
VBW	1 MHz For 20MHz 3 MHz For 40MHz
Detector	Peak
Trace	Max Hold
Sweep Time	Auto

5.3 DEVIATION FROM STANDARD

No deviation.

5.4 TEST SETUP

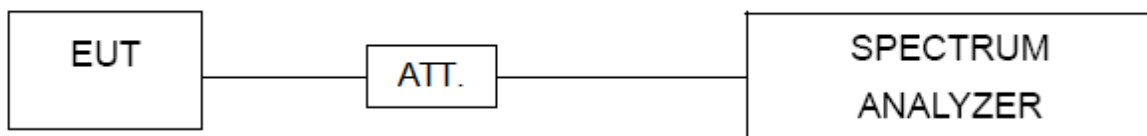

5.5 EUT OPERATION CONDITIONS

The EUT was programmed to be in continuously transmitting mode.

5.6 TEST RESULTS

Please refer to the APPENDIX E.

6. MAXIMUM OUTPUT POWER

6.1 LIMIT

Section	Test Item	Limit
FCC 15.247(b)(3)	Maximum Output Power	1.0000 Watt or 30.00 dBm

6.2 TEST PROCEDURE

- The EUT was directly connected to the power meter and antenna output port as show in the block diagram below.
- The maximum conducted output power was performed in accordance with method 11.9.1.3 of ANSI C63.10-2013 and FCC KDB 662911 D01 v02r01 Multiple Transmitter Output.

6.3 DEVIATION FROM STANDARD

No deviation.

6.4 TEST SETUP

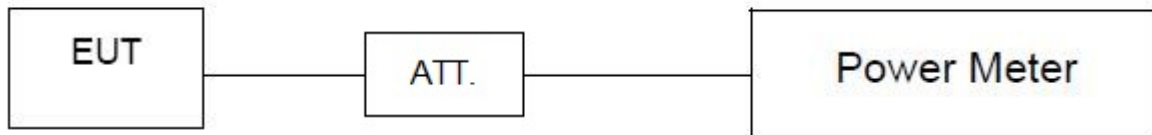

6.5 EUT OPERATION CONDITIONS

The EUT was programmed to be in continuously transmitting mode.

6.6 TEST RESULTS

Please refer to the APPENDIX F.

7. CONDUCTED SPURIOUS EMISSIONS

7.1 LIMIT

In any 100 kHz bandwidth outside the frequency band in which the spread spectrum or digitally modulated intentional radiator is operating, the radio frequency power that is produced by the intentional radiator shall be at least 20 dB below that in the 100 kHz bandwidth within the band that contains the highest level of the desired power, based on either an RF conducted or a radiated measurement, provided the transmitter demonstrates compliance with the peak Output Power limits. If the transmitter complies with the Output Power limits based on the use of RMS averaging over a time interval, as permitted under paragraph (b)(3) of this section, the attenuation required under this paragraph shall be 30 dB instead of 20 dB. Attenuation below the general limits specified in Section 15.209(a) is not required.

7.2 TEST PROCEDURE

- a. The EUT was directly connected to the spectrum analyzer and antenna output port as show in the block diagram below.
- b. The following table is the setting of the spectrum analyzer:

Spectrum Parameters	Setting
Start Frequency	30 MHz
Stop Frequency	26.5 GHz
RBW	100 kHz
VBW	300 kHz
Detector	Peak
Trace	Max Hold
Sweep Time	Auto

7.3 DEVIATION FROM STANDARD

No deviation.

7.4 TEST SETUP

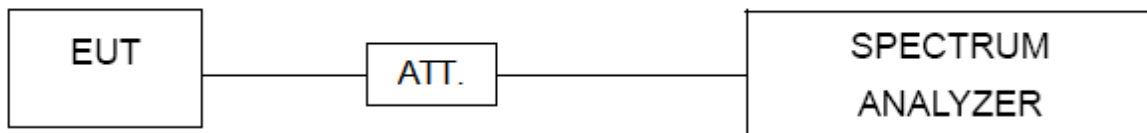

7.5 EUT OPERATION CONDITIONS

The EUT was programmed to be in continuously transmitting mode.

7.6 TEST RESULTS

Please refer to the APPENDIX G.

8. POWER SPECTRAL DENSITY

8.1 LIMIT

Section	Test Item	Limit
FCC 15.247(e)	Power Spectral Density	8 dBm (in any 3 kHz)

8.2 TEST PROCEDURE

- a. The EUT was directly connected to the spectrum analyzer and antenna output port as show in the block diagram below.
- b. The following table is the setting of the spectrum analyzer:

Spectrum Parameters	Setting
Span Frequency	25 MHz (20 MHz) / 60 MHz (40 MHz)
RBW	3 kHz
VBW	10 kHz
Detector	Peak
Trace	Max Hold
Sweep Time	Auto

8.3 DEVIATION FROM STANDARD

No deviation.

8.4 TEST SETUP



8.5 EUT OPERATION CONDITIONS

The EUT was programmed to be in continuously transmitting mode.

8.6 TEST RESULTS

Please refer to the APPENDIX H.

9. MEASUREMENT INSTRUMENTS LIST

AC Power Line Conducted Emissions					
Item	Kind of Equipment	Manufacturer	Type No.	Serial No.	Calibrated until
1	EMI Test Receiver	R&S	ESCI	100382	Feb. 28, 2022
2	LISN	EMCO	3816/2	52765	Feb. 27, 2022
3	TWO-LINE V-NETWORK	R&S	ENV216	101447	Feb. 27, 2022
4	50Ω Terminator	SHX	TF5-3	15041305	Feb. 27, 2022
5	Measurement Software	Farad	EZ-EMC Ver.NB-03A1-01	N/A	N/A
6	Cable	N/A	RG223	12m	Mar. 09, 2022
7	643 Shield Room	ETS	6*4*3m	N/A	N/A

Radiated Emissions - 9 kHz to 30 MHz					
Item	Kind of Equipment	Manufacturer	Type No.	Serial No.	Calibrated until
1	Loop Antenna	EM	EM-6876-1	230	Apr. 28, 2022
2	Cable	N/A	RG 213/U	N/A	May 29, 2022
3	EMI Test Receiver	R&S	ESCI	100895	Feb. 27, 2022
4	Measurement Software	Farad	EZ-EMC Ver.NB-03A1-01	N/A	N/A
5	966 Chambe Room	RM	9*6*6m	N/A	Jul. 25, 2021

Radiated Emissions - 30 MHz to 1 GHz					
Item	Kind of Equipment	Manufacturer	Type No.	Serial No.	Calibrated until
1	Antenna	Schwarzbeck	VULB9160	9160-3232	Mar. 15, 2022
2	Amplifier	HP	8447D	2944A08742	Feb. 28, 2022
3	Receiver	Agilent	N9038A	MY52130039	Jul. 25, 2021
4	Cable	emci	LMR-400(30MHz-1 GHz)(8m+5m)	N/A	May 20, 2022
5	Controller	CT	SC100	N/A	N/A
6	Controller	MF	MF-7802	MF780208416	N/A
7	Measurement Software	Farad	EZ-EMC Ver.NB-03A1-01	N/A	N/A
8	966 Chambe Room	RM	9*6*6m	N/A	Jul. 25, 2021

Radiated Emissions - Above 1 GHz					
Item	Kind of Equipment	Manufacturer	Type No.	Serial No.	Calibrated until
1	Double Ridged Guide Antenna	ETS	3115	75789	May 10, 2022
2	Broad-Band Horn Antenna	Schwarzbeck	BBHA 9170	9170319	Jul. 07, 2021
3	Amplifier	Agilent	8449B	3008A02584	Jul. 25, 2021
4	Microwave Preampifier With Adaptor	EMC INSTRUMENT	EMC2654045	980039 & HA01	Feb. 28, 2022
5	Receiver	Agilent	N9038A	MY52130039	Jul. 25, 2021
6	Controller	CT	SC100	N/A	N/A
7	Controller	MF	MF-7802	MF780208416	N/A
8	Cable	N/A	EMC104-SM-SM-6000	N/A	Oct. 16, 2021
9	Measurement Software	Farad	EZ-EMC Ver.NB-03A1-01	N/A	N/A
10	Filter	STI	STI15-9912	N/A	Jul. 25, 2021
11	966 Chambe Room	RM	9*6*6m	N/A	Jul. 25, 2021

Bandwidth & Conducted Spurious Emissions & Power Spectral Density					
Item	Kind of Equipment	Manufacturer	Type No.	Serial No.	Calibrated until
1	Spectrum Analyzer	R&S	FSP40	100185	Jul. 25, 2021
2	Attenuator	WOKEN	6SM3502	VAS1214NL	Feb. 07, 2022
3	RF Cable	Tongkaichuan	N/A	N/A	N/A
4	DC Block	Mini	N/A	N/A	N/A

Maximum Output Power					
Item	Kind of Equipment	Manufacturer	Type No.	Serial No.	Calibrated until
1	Peak Power Analyzer	Keysight	8990B	MY51000506	Aug. 07, 2021
2	Wideband power sensor	Keysight	N1923A	MY58310004	Jul. 25, 2021
3	Attenuator	WOKEN	6SM3502	VAS1214NL	Feb. 07, 2022
4	RF Cable	Tongkaichuan	N/A	N/A	N/A

Remark: "N/A" denotes no model name, serial no. or calibration specified.

All calibration period of equipment list is one year.

10. EUT TEST PHOTO

AC Power Line Conducted Emissions Test Photos

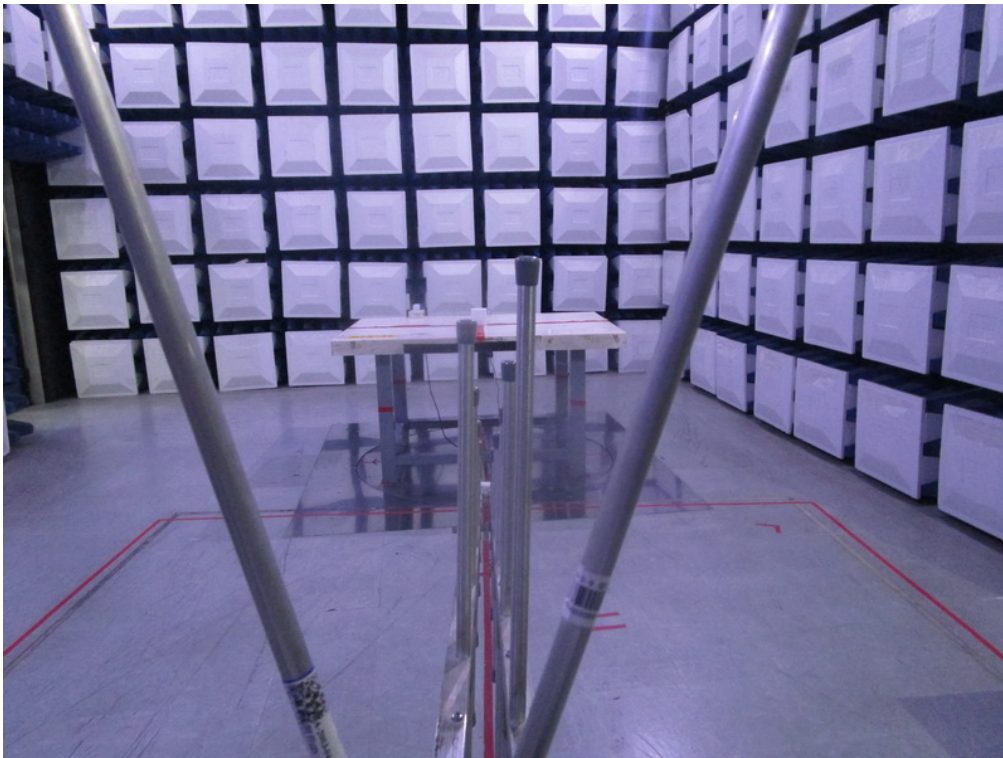

Radiated Emissions Test Photos**9 kHz to 30 MHz**

Radiated Emissions Test Photos**30 MHz to 1 GHz**

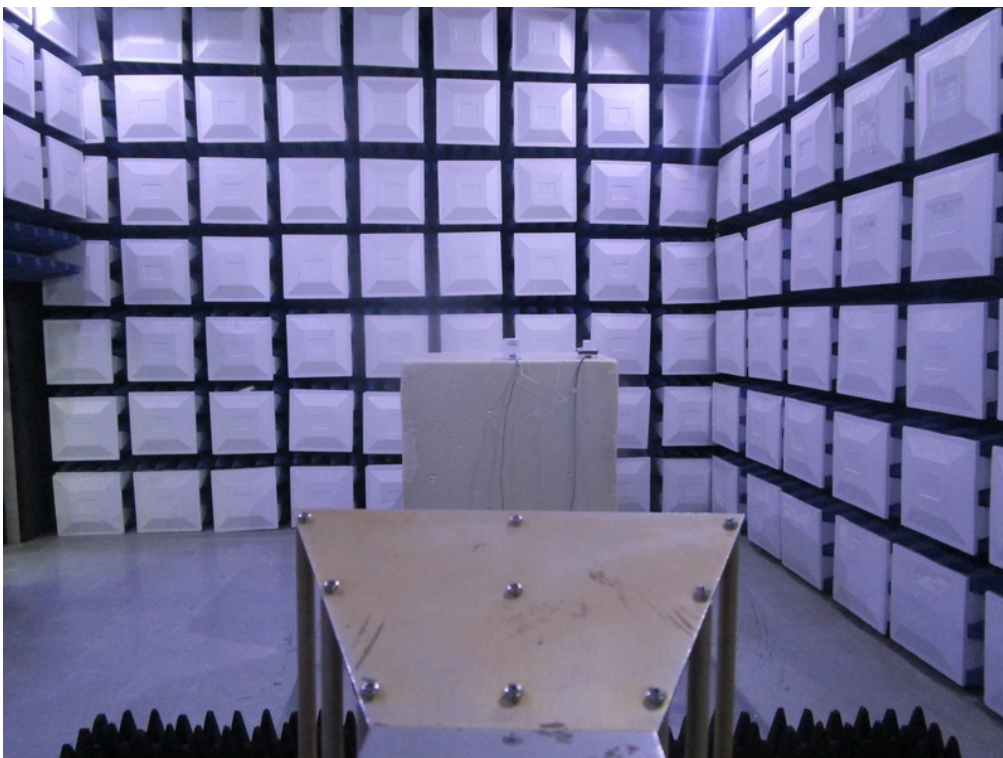
Radiated Emissions Test Photos**Above 1 GHz**

Conducted Test Photos

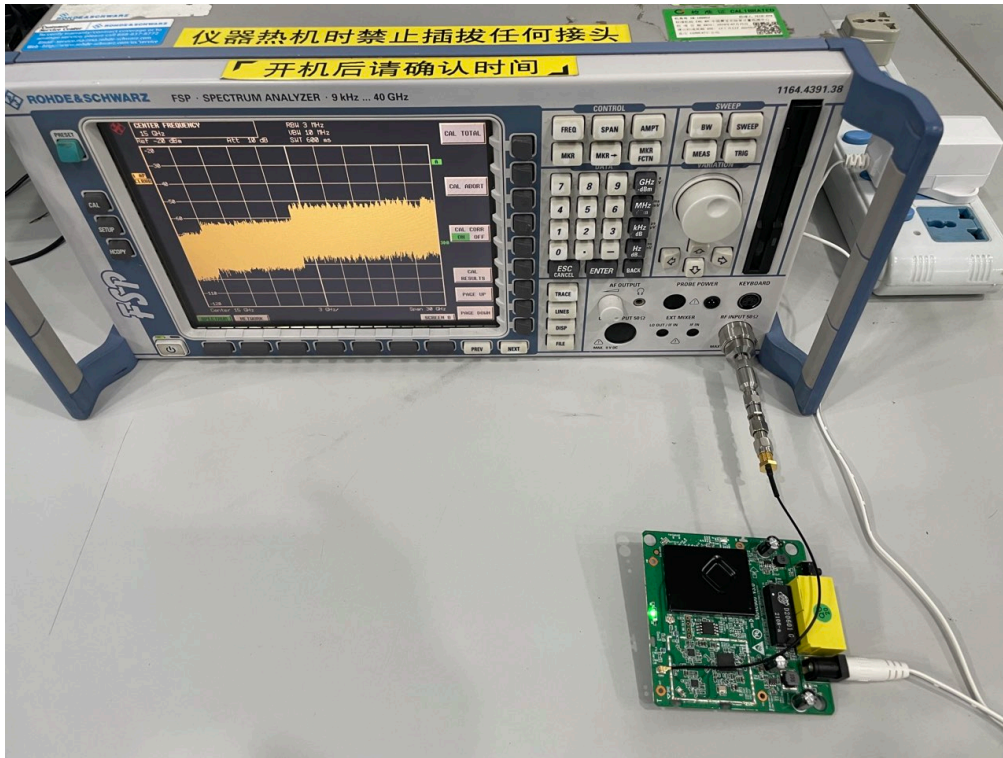

APPENDIX A - AC POWER LINE CONDUCTED EMISSIONS

Test Voltage	AC 120V/60Hz		
Test Mode	TX N(HT20) Mode Channel 06	Phase	Line

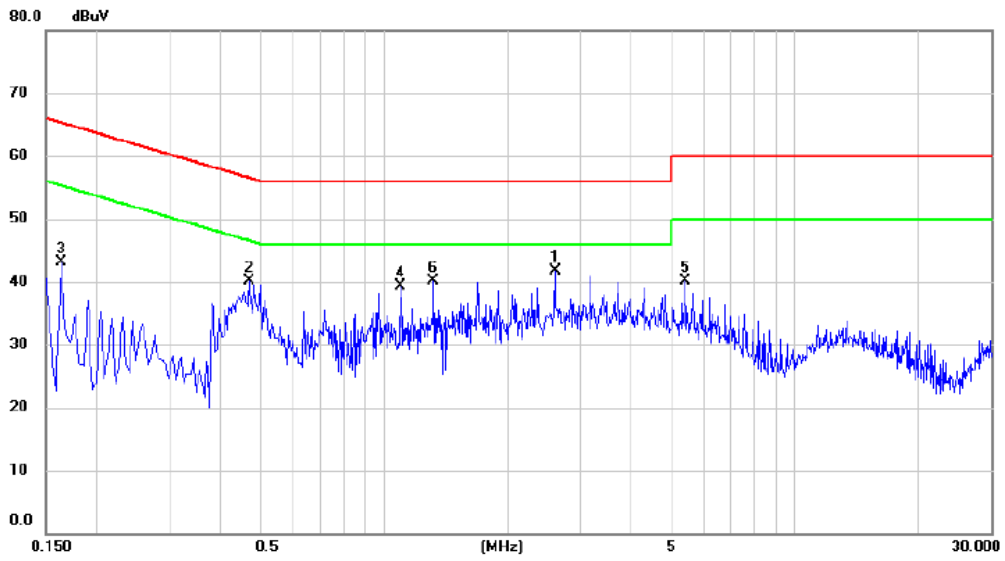

No.	Mk.	Freq. MHz	Reading Level dBuV	Correct Factor dB	Measure- ment dBuV	Limit dBuV	Margin dB	Detector	Comment
1	*	2.6070	31.67	10.10	41.77	56.00	-14.23	peak	
2		0.4695	30.18	9.92	40.10	56.52	-16.42	peak	
3		0.1635	33.27	9.77	43.04	65.28	-22.24	peak	
4		1.0994	29.28	9.99	39.27	56.00	-16.73	peak	
5		5.3925	29.88	10.31	40.19	60.00	-19.81	peak	
6		1.3200	30.03	10.00	40.03	56.00	-15.97	peak	

REMARKS:

- (1) Measurement Value = Reading Level + Correct Factor.
- (2) Margin Level = Measurement Value - Limit Value.

Test Voltage	AC 120V/60Hz		
Test Mode	TX N(HT20) Mode Channel 06	Phase	Neutral

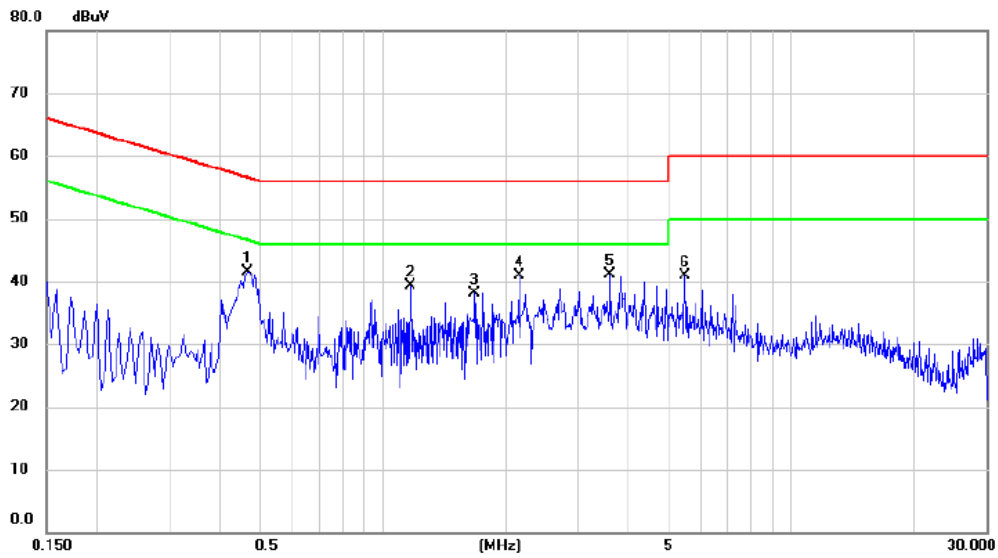

No. Mk.	Freq. MHz	Reading Level dBuV	Correct Factor dB	Measurement dBuV	Limit dBuV	Margin dB	Detector	Comment
1	0.4650	31.49	10.11	41.60	56.60	-15.00	peak	
2	1.1670	29.03	10.29	39.32	56.00	-16.68	peak	
3	1.6754	27.84	10.35	38.19	56.00	-17.81	peak	
4	2.1524	30.57	10.39	40.96	56.00	-15.04	peak	
5 *	3.5925	30.58	10.52	41.10	56.00	-14.90	peak	
6	5.4960	30.27	10.65	40.92	60.00	-19.08	peak	

REMARKS:

- (1) Measurement Value = Reading Level + Correct Factor.
- (2) Margin Level = Measurement Value - Limit Value.

Test Voltage	AC 240V/50Hz		
Test Mode	TX N(HT20) Mode Channel 06	Phase	Line

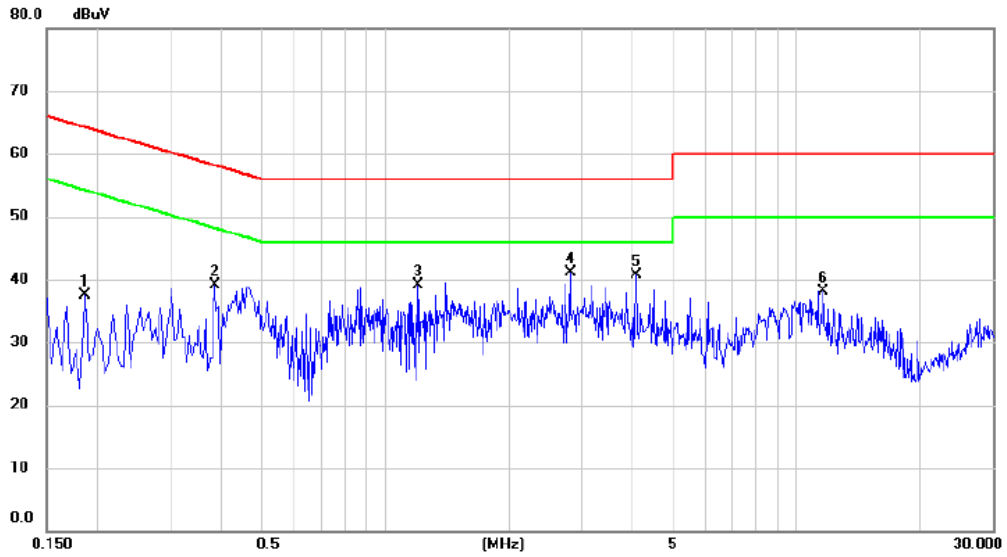

No. Mk.	Freq. MHz	Reading Level dBuV	Correct Factor dB	Measurement dBuV	Limit dBuV	Margin dB	Detector	Comment
1	0.1860	27.59	9.86	37.45	64.21	-26.76	peak	
2	0.3840	29.21	9.90	39.11	58.19	-19.08	peak	
3	1.1984	29.14	9.99	39.13	56.00	-16.87	peak	
4 *	2.8184	31.02	10.13	41.15	56.00	-14.85	peak	
5	4.0875	30.44	10.20	40.64	56.00	-15.36	peak	
6	11.5890	27.41	10.72	38.13	60.00	-21.87	peak	

REMARKS:

- (1) Measurement Value = Reading Level + Correct Factor.
- (2) Margin Level = Measurement Value - Limit Value.

Test Voltage	AC 240V/50Hz		
Test Mode	TX N(HT20) Mode Channel 06	Phase	Neutral

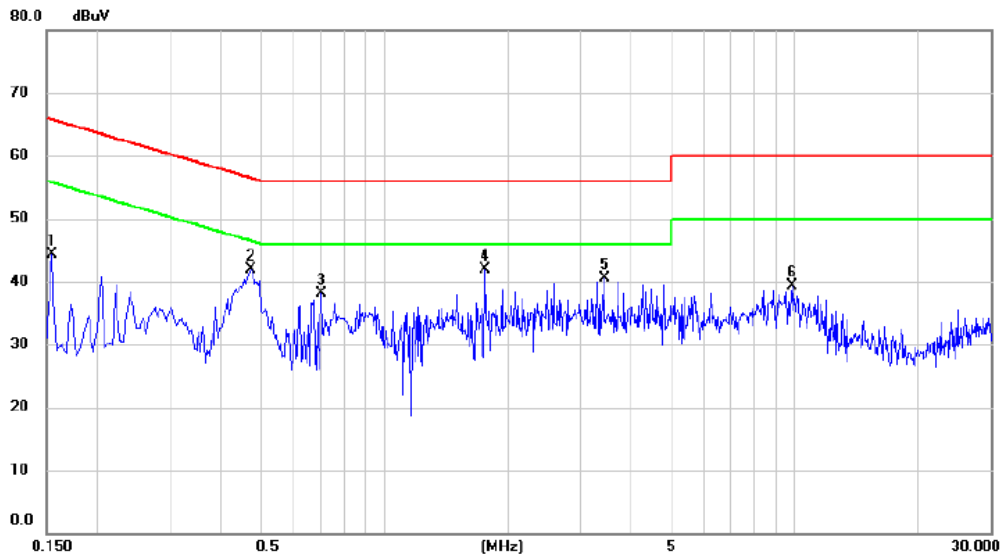

No.	Mk.	Freq. MHz	Reading Level dBuV	Correct Factor dB	Measure- ment dBuV	Limit dBuV	Margin dB	Detector	Comment
1		0.1544	34.56	9.77	44.33	65.76	-21.43	peak	
2		0.4740	31.77	10.11	41.88	56.44	-14.56	peak	
3		0.7034	27.92	10.09	38.01	56.00	-17.99	peak	
4	*	1.7564	31.49	10.36	41.85	56.00	-14.15	peak	
5		3.4350	29.98	10.50	40.48	56.00	-15.52	peak	
6		9.8745	28.37	11.01	39.38	60.00	-20.62	peak	

REMARKS:

- (1) Measurement Value = Reading Level + Correct Factor.
- (2) Margin Level = Measurement Value - Limit Value.

APPENDIX B - RADIATED EMISSION - 9 KHZ TO 30 MHZ

Test Mode	TX N(HT20) Mode Channel 06	Polarization	Ant 0°
-----------	----------------------------	--------------	--------

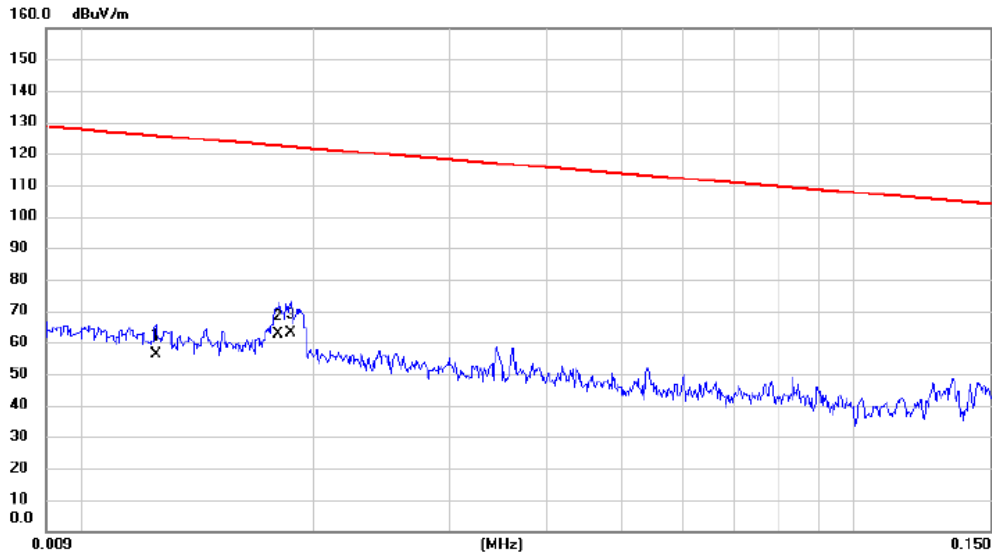

No.	Mk.	Freq.	Reading Level	Correct Factor	Measurement	Limit	Margin	Antenna Height	Table Degree	
		MHz	dBuV	dB	dBuV/m	dBuV/m	dB	cm	degree	Comment
1		0.0125	39.60	16.77	56.37	125.67	-69.30	AVG		
2		0.0180	47.40	15.04	62.44	122.50	-60.06	AVG		
3	*	0.0187	48.20	14.82	63.02	122.17	-59.15	AVG		

REMARKS:

- (1) Measurement Value = Reading Level + Correct Factor.
- (2) Margin Level = Measurement Value - Limit Value.

Test Mode	TX N(HT20) Mode Channel 06	Polarization	Ant 0°
-----------	----------------------------	--------------	--------

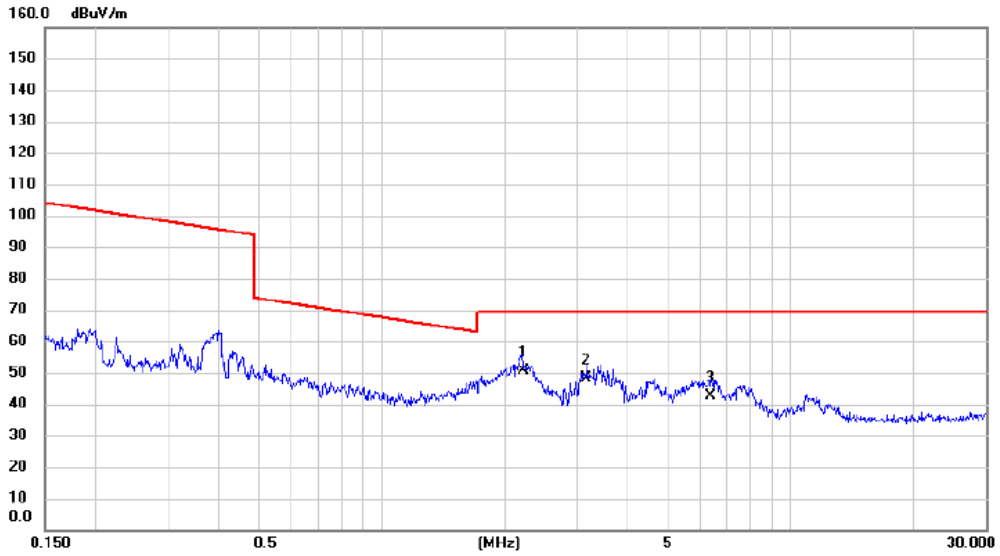

No. Mk.	Freq. MHz	Reading Level dBuV	Correct Factor dB	Measure- ment dBuV/m	Limit dBuV/m	Margin dB	Detector	Antenna Height cm	Table Degree	Comment
1 *	2.2132	38.50	12.18	50.68	69.54	-18.86	QP			
2	3.1731	36.40	11.97	48.37	69.54	-21.17	QP			
3	6.3520	30.50	12.13	42.63	69.54	-26.91	QP			

REMARKS:

- (1) Measurement Value = Reading Level + Correct Factor.
- (2) Margin Level = Measurement Value - Limit Value.

Test Mode	TX N(HT20) Mode Channel 06	Polarization	Ant 90°
-----------	----------------------------	--------------	---------

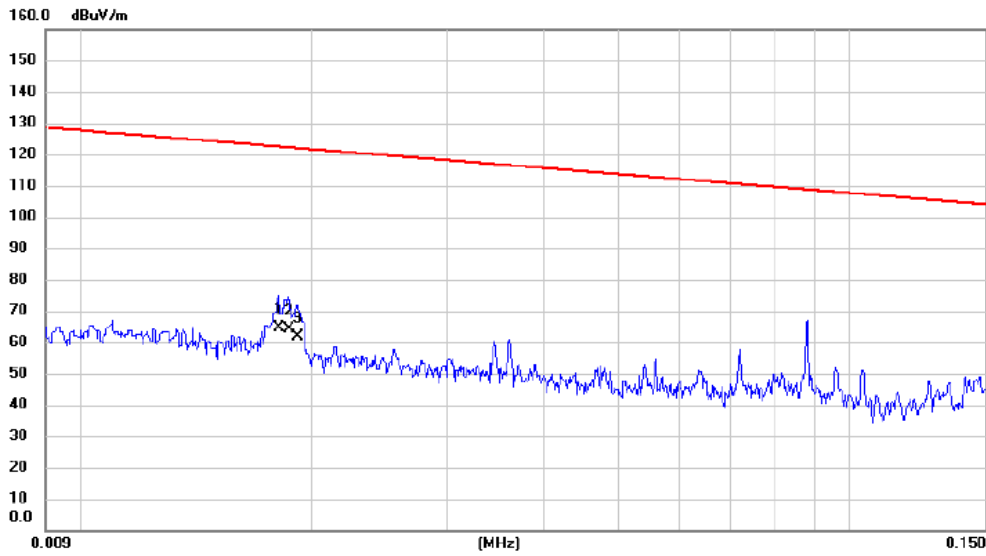

No.	Mk.	Freq.	Reading Level	Correct Factor	Measurement	Limit	Margin	Antenna Height	Table Degree	
		MHz	dBuV	dB	dBuV/m	dBuV/m	dB	cm	degree	Comment
1	*	0.0181	49.50	15.01	64.51	122.45	-57.94	AVG		
2		0.0187	49.30	14.82	64.12	122.17	-58.05	AVG		
3		0.0192	47.30	14.66	61.96	121.94	-59.98	AVG		

REMARKS:

- (1) Measurement Value = Reading Level + Correct Factor.
- (2) Margin Level = Measurement Value - Limit Value.

Test Mode	TX N(HT20) Mode Channel 06	Polarization	Ant 90°
-----------	----------------------------	--------------	---------

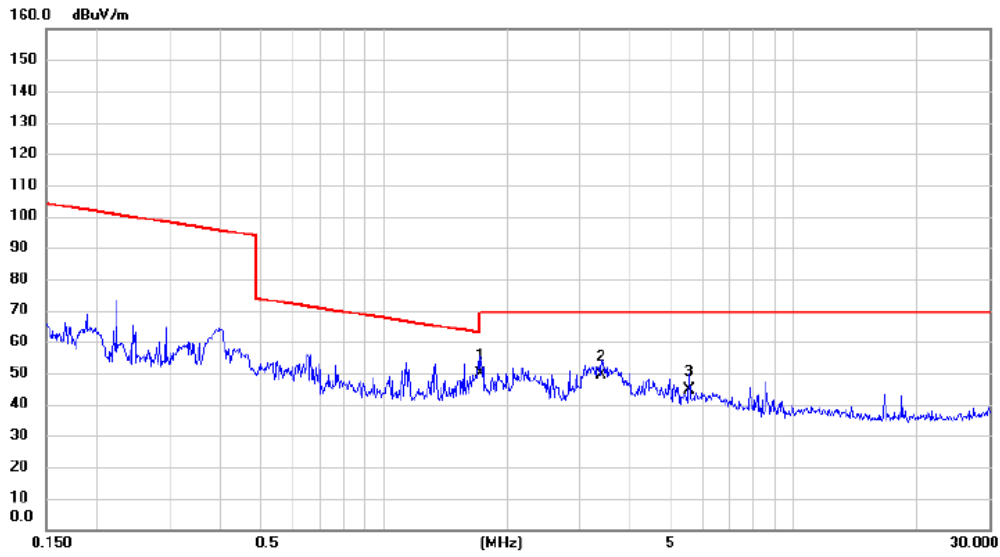

No.	Mk.	Freq.	Reading Level	Correct Factor	Measurement	Limit	Margin	Antenna Height	Table Degree	
		MHz	dBuV	dB	dBuV/m	dBuV/m	dB	cm	degree	Comment
1	*	1.7162	37.40	12.45	49.85	69.54	-19.69	QP		
2		3.3994	37.50	11.99	49.49	69.54	-20.05	QP		
3		5.5641	32.40	12.12	44.52	69.54	-25.02	QP		

REMARKS:

- (1) Measurement Value = Reading Level + Correct Factor.
- (2) Margin Level = Measurement Value - Limit Value.

APPENDIX C - RADIATED EMISSION - 30 MHZ TO 1000 MHZ

Test Mode	TX N(HT20) Mode Channel 06	Polarization	Vertical
-----------	----------------------------	--------------	----------

86.9 dBuV/m

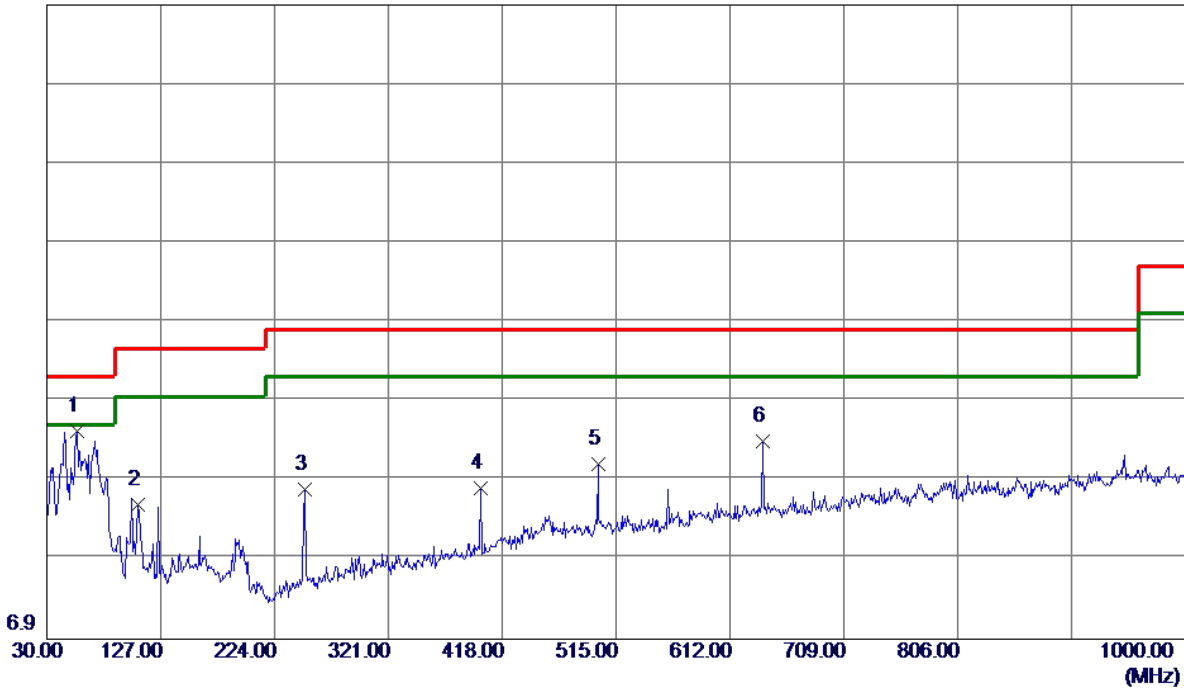

No.	Freq. MHz	Reading Level dBuV/m	Correct Factor dB	Measure ment dBuV/m	Limit dBuV/m	Margin dB	Detector	Comment
1 *	56.1900	46.90	-13.81	33.09	40.00	-6.91	Peak	
2	107.6000	38.20	-14.39	23.81	43.50	-19.69	Peak	
3	250.1900	39.01	-13.28	25.73	46.00	-20.27	Peak	
4	400.0550	34.89	-9.01	25.88	46.00	-20.12	Peak	
5	499.9650	36.17	-7.26	28.91	46.00	-17.09	Peak	
6	640.1300	36.39	-4.48	31.91	46.00	-14.09	Peak	

REMARKS:

- (1) Measurement Value = Reading Level + Correct Factor.
- (2) Margin Level = Measurement Value - Limit Value.

Test Mode	TX N(HT20) Mode Channel 06	Polarization	Horizontal
-----------	----------------------------	--------------	------------

86.9 dBuV/m

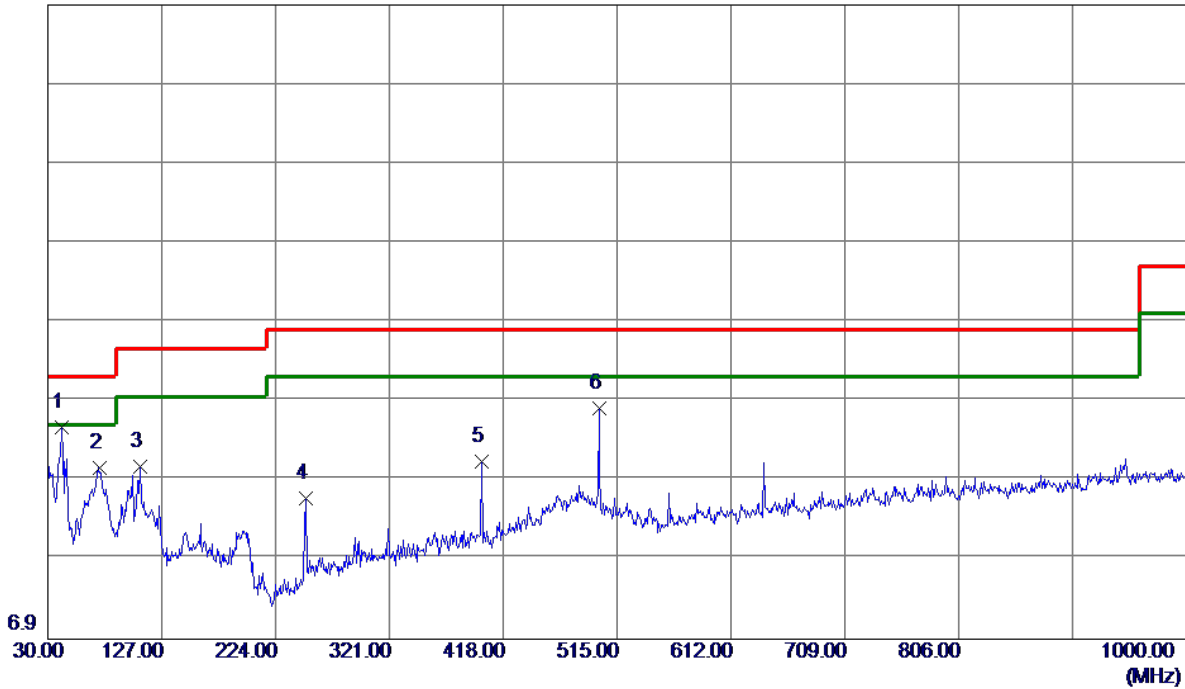

No.	Freq. MHz	Reading Level dBuV/m	Correct Factor dB	Measure ment dBuV/m	Limit dBuV/m	Margin dB	Detector	Comment
1 *	41.6400	47.63	-14.00	33.63	40.00	-6.37	Peak	
2	74.1350	45.15	-16.69	28.46	40.00	-11.54	Peak	
3	108.5700	43.01	-14.33	28.68	43.50	-14.82	Peak	
4	250.1900	37.92	-13.28	24.64	46.00	-21.36	Peak	
5	400.0550	38.28	-9.01	29.27	46.00	-16.73	Peak	
6	499.9650	43.21	-7.26	35.95	46.00	-10.05	Peak	

REMARKS:

- (1) Measurement Value = Reading Level + Correct Factor.
- (2) Margin Level = Measurement Value - Limit Value.

APPENDIX D - RADIATED EMISSION- ABOVE 1000 MHZ

Test Mode	TX B Mode 2412 MHz	Polarization	Vertical
-----------	--------------------	--------------	----------

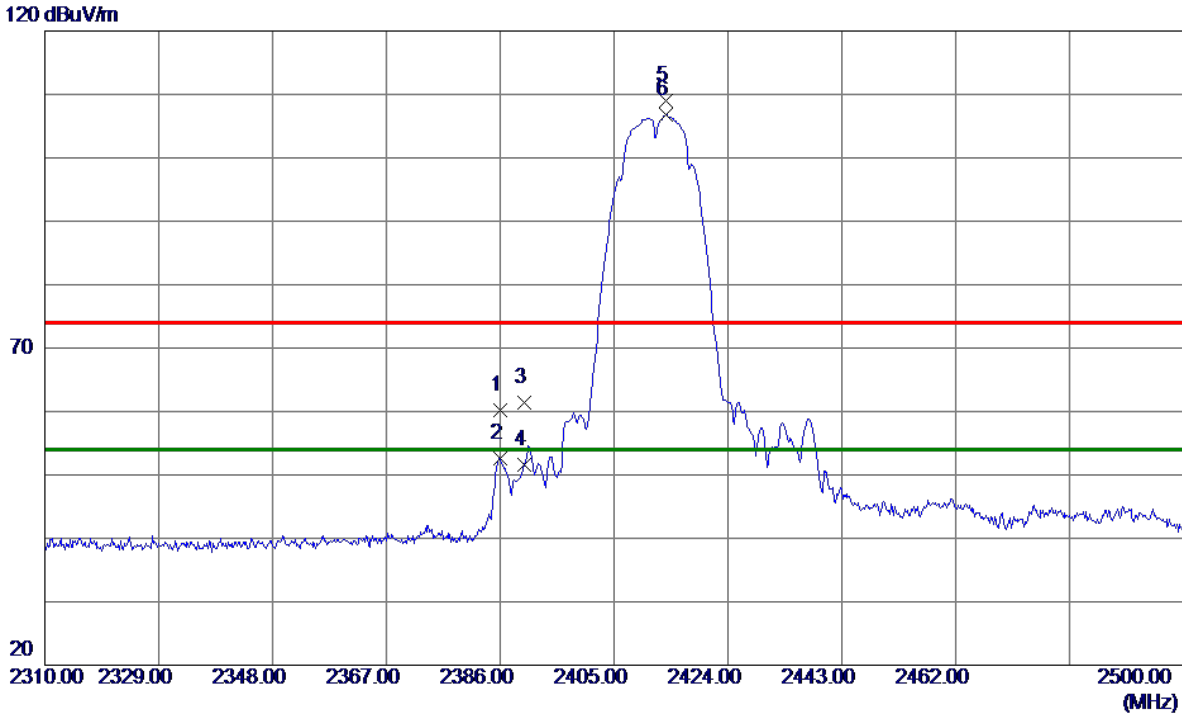

No.	Freq. MHz	Reading Level dBuV/m	Correct Factor dB	Measure ment dBuV/m	Limit dBuV/m	Margin dB	Detector	Comment
1	2385.9050	51.93	8.28	60.21	74.00	-13.79	Peak	
2	2385.9050	44.28	8.28	52.56	54.00	-1.44	AVG	
3	2390.0000	53.10	8.29	61.39	74.00	-12.61	Peak	
4	2390.0000	43.34	8.29	51.63	54.00	-2.37	AVG	
5	2413.7400	100.61	8.31	108.92	74.00	34.92	Peak	No limit
6 *	2413.7400	98.50	8.31	106.81	54.00	52.81	AVG	No limit

REMARKS:

- (1) Measurement Value = Reading Level + Correct Factor.
- (2) Margin Level = Measurement Value - Limit Value.

Test Mode	TX B Mode 2412 MHz	Polarization	Vertical
-----------	--------------------	--------------	----------

86.9 dBuV/m

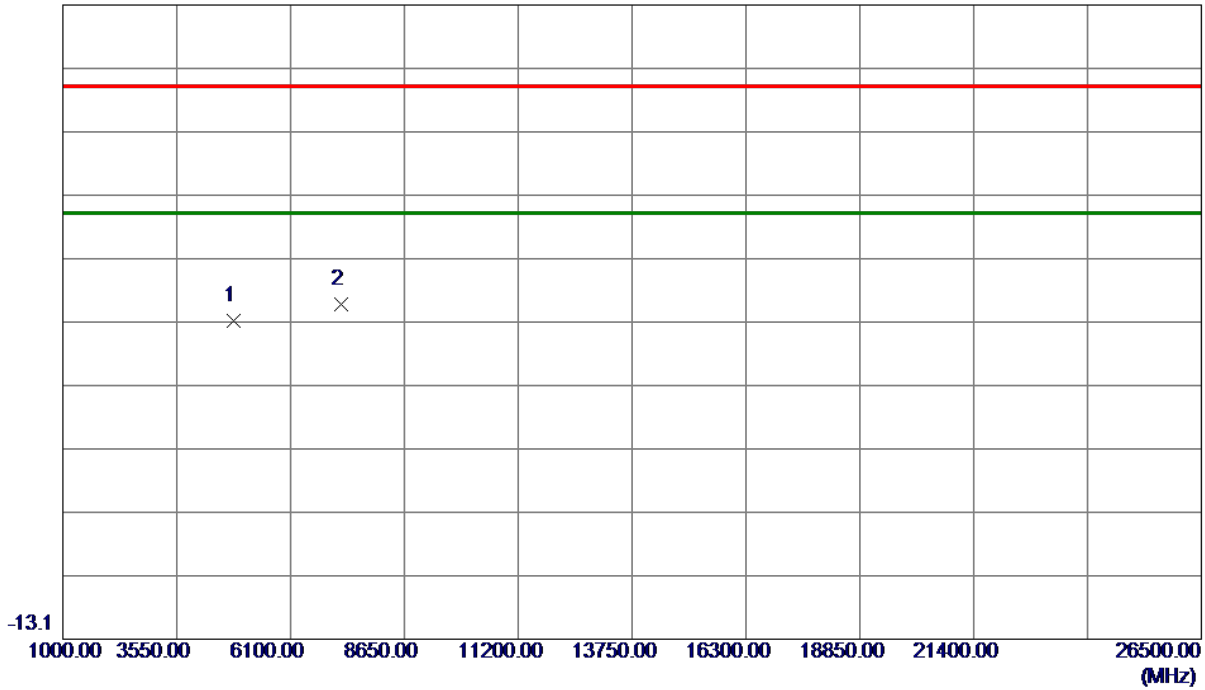

No.	Freq. MHz	Reading Level dBuV/m	Correct Factor dB	Measure ment dBuV/m	Limit dBuV/m	Margin dB	Detector	Comment
1	4823.7250	31.78	5.32	37.10	74.00	-36.90	Peak	
2 *	7233.4750	28.71	11.00	39.71	74.00	-34.29	Peak	

REMARKS:

- (1) Measurement Value = Reading Level + Correct Factor.
- (2) Margin Level = Measurement Value - Limit Value.

Test Mode	TX B Mode 2412 MHz	Polarization	Horizontal
-----------	--------------------	--------------	------------

120 dBuV/m

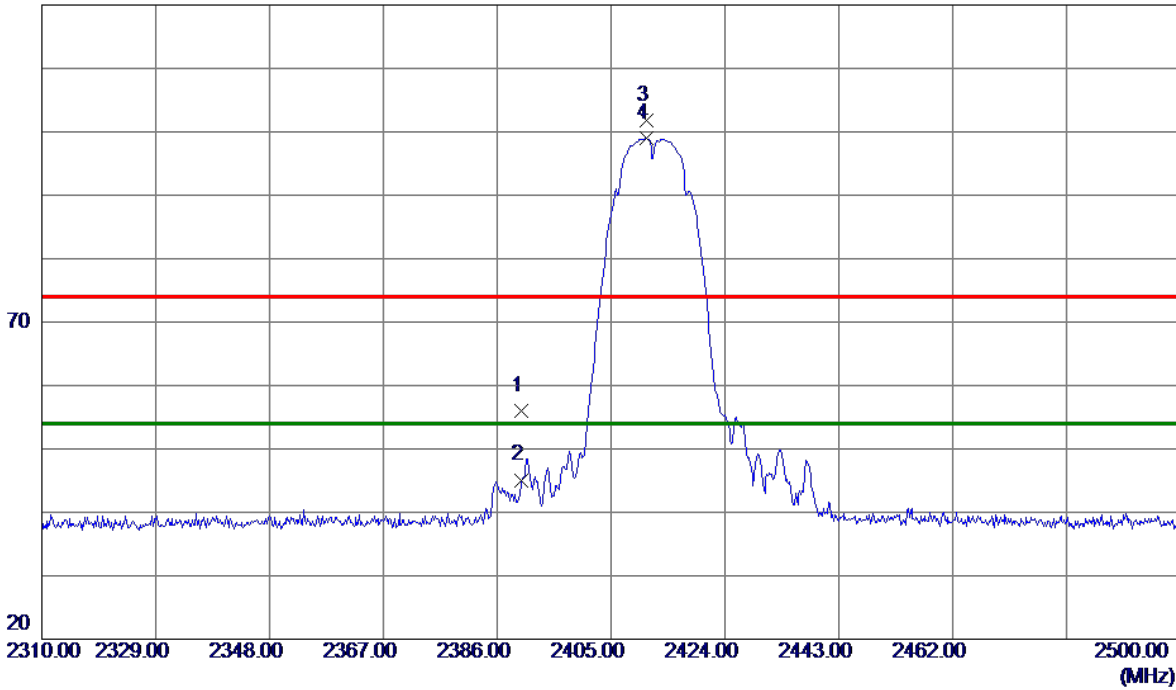

No.	Freq. MHz	Reading Level dBuV/m	Correct Factor dB	Measure ment dBuV/m	Limit dBuV/m	Margin dB	Detector	Comment
1	2390.0000	47.71	8.29	56.00	74.00	-18.00	Peak	
2	2390.0000	36.81	8.29	45.10	54.00	-8.90	AVG	
3	2410.8899	93.40	8.31	101.71	74.00	27.71	Peak	No limit
4 *	2410.8899	90.65	8.31	98.96	54.00	44.96	AVG	No limit

REMARKS:

- (1) Measurement Value = Reading Level + Correct Factor.
- (2) Margin Level = Measurement Value - Limit Value.

Test Mode	TX B Mode 2412 MHz	Polarization	Horizontal
-----------	--------------------	--------------	------------

86.9 dBuV/m

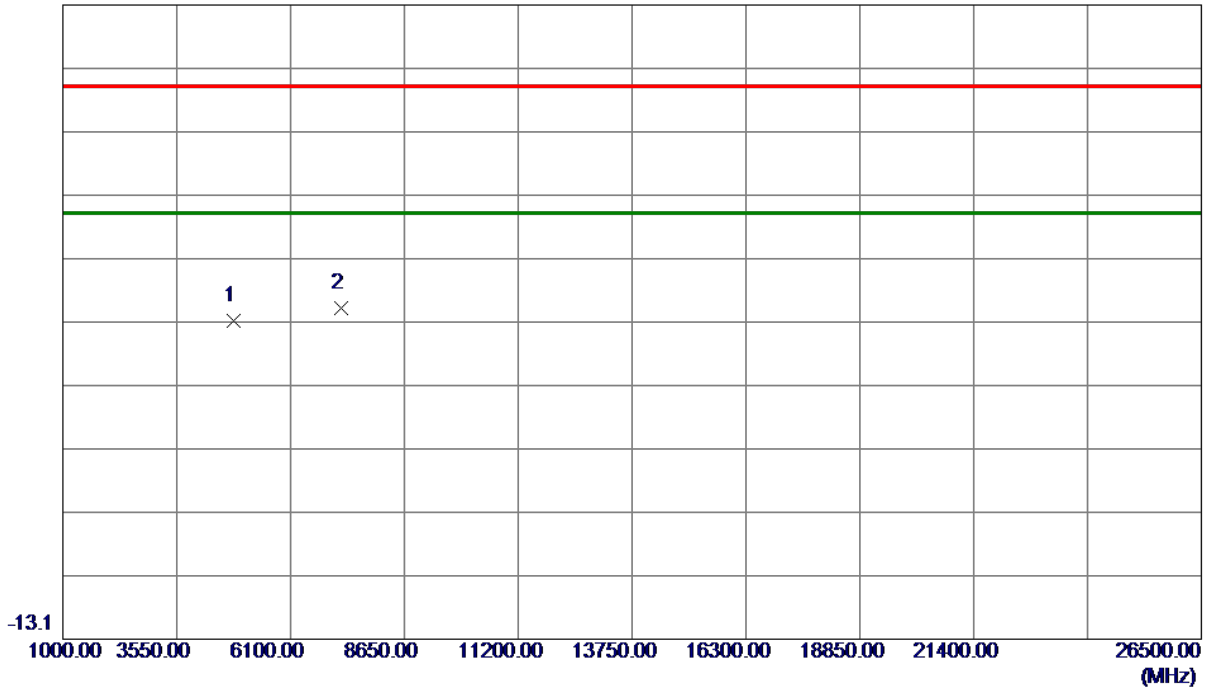

No.	Freq. MHz	Reading Level dBuV/m	Correct Factor dB	Measure ment dBuV/m	Limit dBuV/m	Margin dB	Detector	Comment
1	4823.7250	31.73	5.32	37.05	74.00	-36.95	Peak	
2 *	7233.4750	28.13	11.00	39.13	74.00	-34.87	Peak	

REMARKS:

- (1) Measurement Value = Reading Level + Correct Factor.
- (2) Margin Level = Measurement Value - Limit Value.

Test Mode	TX B Mode 2437 MHz	Polarization	Vertical
-----------	--------------------	--------------	----------

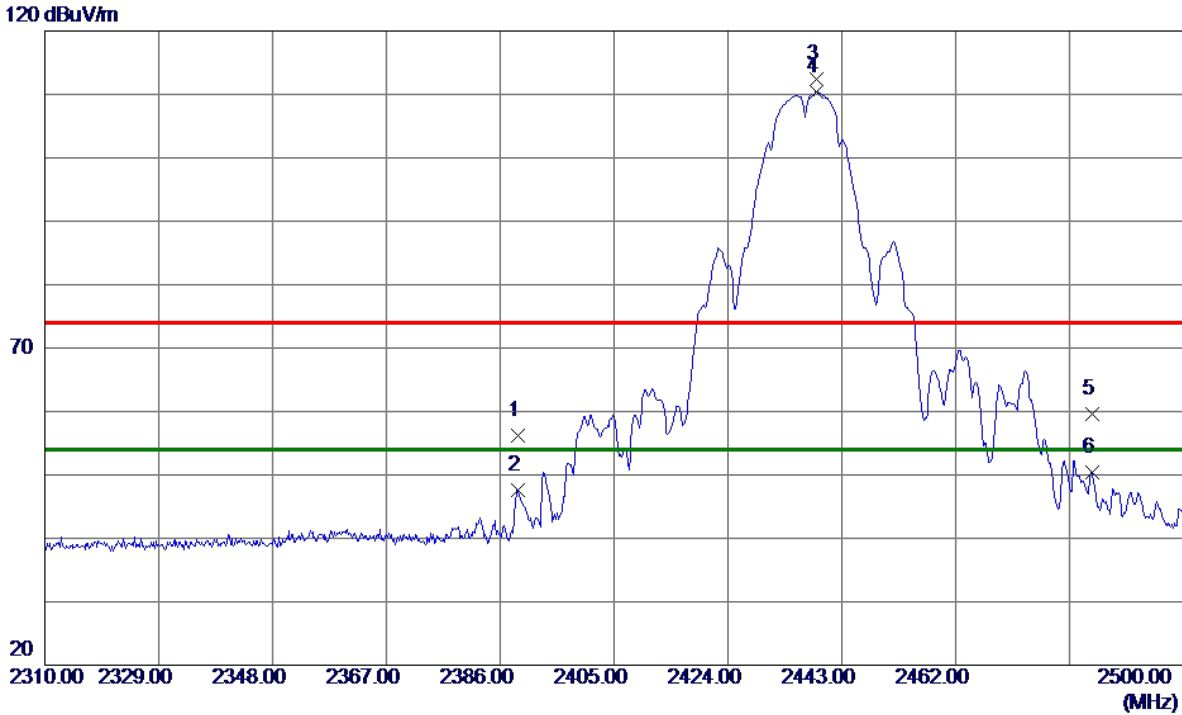

No.	Freq. MHz	Reading Level dBuV/m	Correct Factor dB	Measure ment dBuV/m	Limit dBuV/m	Margin dB	Detector	Comment
1	2388.9450	47.91	8.29	56.20	74.00	-17.80	Peak	
2	2388.9450	39.37	8.29	47.66	54.00	-6.34	AVG	
3	2438.8200	104.02	8.34	112.36	74.00	38.36	Peak	No limit
4 *	2438.8200	102.11	8.34	110.45	54.00	56.45	AVG	No limit
5	2484.7050	51.20	8.39	59.59	74.00	-14.41	Peak	
6	2484.7050	42.05	8.39	50.44	54.00	-3.56	AVG	

REMARKS:

- (1) Measurement Value = Reading Level + Correct Factor.
- (2) Margin Level = Measurement Value - Limit Value.

Test Mode	TX B Mode 2437 MHz	Polarization	Vertical
-----------	--------------------	--------------	----------

86.9 dBuV/m

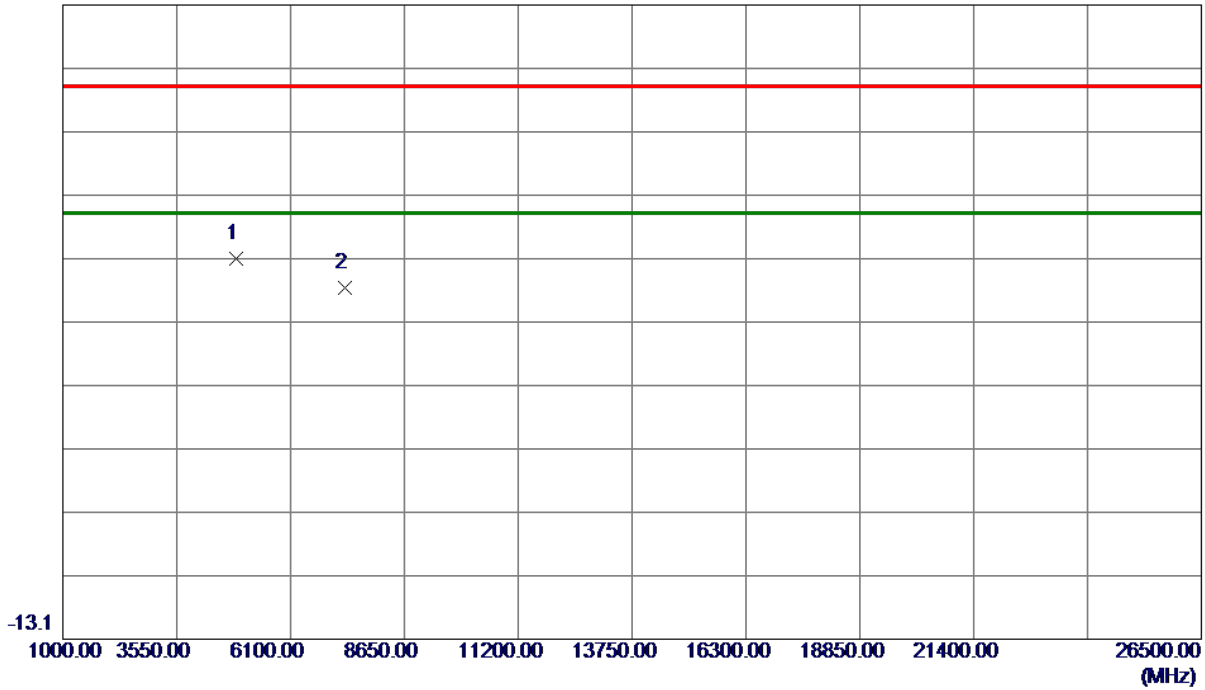

No.	Freq. MHz	Reading Level dBuV/m	Correct Factor dB	Measure ment dBuV/m	Limit dBuV/m	Margin dB	Detector	Comment
1 *	4874.7250	41.43	5.46	46.89	74.00	-27.11	Peak	
2	7312.5250	31.15	11.15	42.30	74.00	-31.70	Peak	

REMARKS:

- (1) Measurement Value = Reading Level + Correct Factor.
- (2) Margin Level = Measurement Value - Limit Value.

Test Mode	TX B Mode 2437 MHz	Polarization	Horizontal
-----------	--------------------	--------------	------------

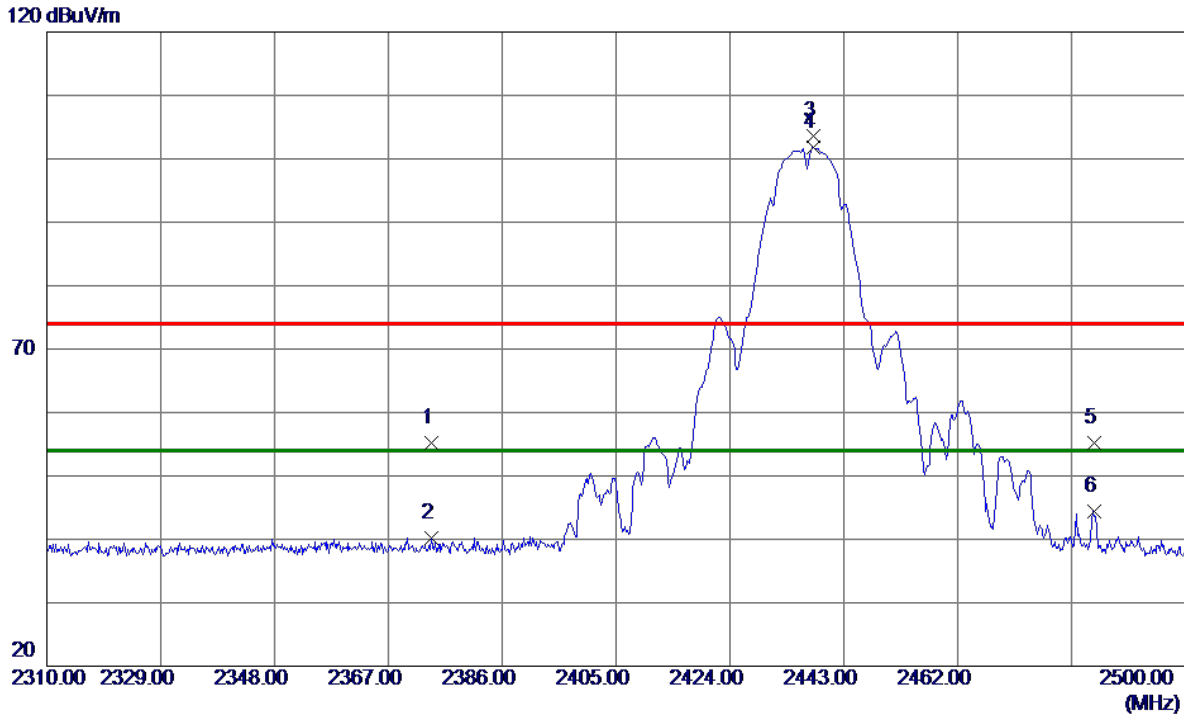

No.	Freq. MHz	Reading Level dBuV/m	Correct Factor dB	Measure ment dBuV/m	Limit dBuV/m	Margin dB	Detector	Comment
1	2374.2200	46.89	8.27	55.16	74.00	-18.84	Peak	
2	2374.2200	31.88	8.27	40.15	54.00	-13.85	AVG	
3	2437.8700	95.24	8.34	103.58	74.00	29.58	Peak	No limit
4 *	2437.8700	93.41	8.34	101.75	54.00	47.75	AVG	No limit
5	2484.7050	46.80	8.39	55.19	74.00	-18.81	Peak	
6	2484.7050	35.96	8.39	44.35	54.00	-9.65	AVG	

REMARKS:

- (1) Measurement Value = Reading Level + Correct Factor.
- (2) Margin Level = Measurement Value - Limit Value.

Test Mode	TX B Mode 2437 MHz	Polarization	Horizontal
-----------	--------------------	--------------	------------

86.9 dBuV/m

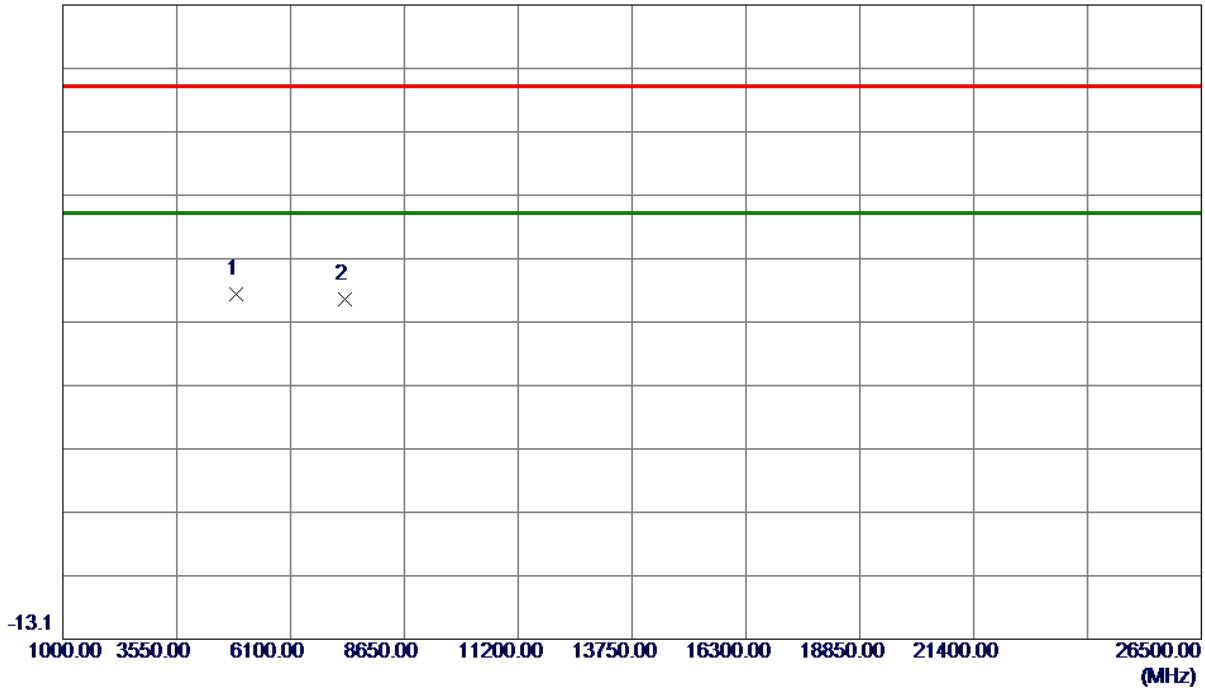

No.	Freq. MHz	Reading Level dBuV/m	Correct Factor dB	Measure ment dBuV/m	Limit dBuV/m	Margin dB	Detector	Comment
1 *	4873.4500	35.79	5.46	41.25	74.00	-32.75	Peak	
2	7312.5250	29.40	11.15	40.55	74.00	-33.45	Peak	

REMARKS:

- (1) Measurement Value = Reading Level + Correct Factor.
- (2) Margin Level = Measurement Value - Limit Value.

Test Mode	TX B Mode 2462 MHz	Polarization	Vertical
-----------	--------------------	--------------	----------

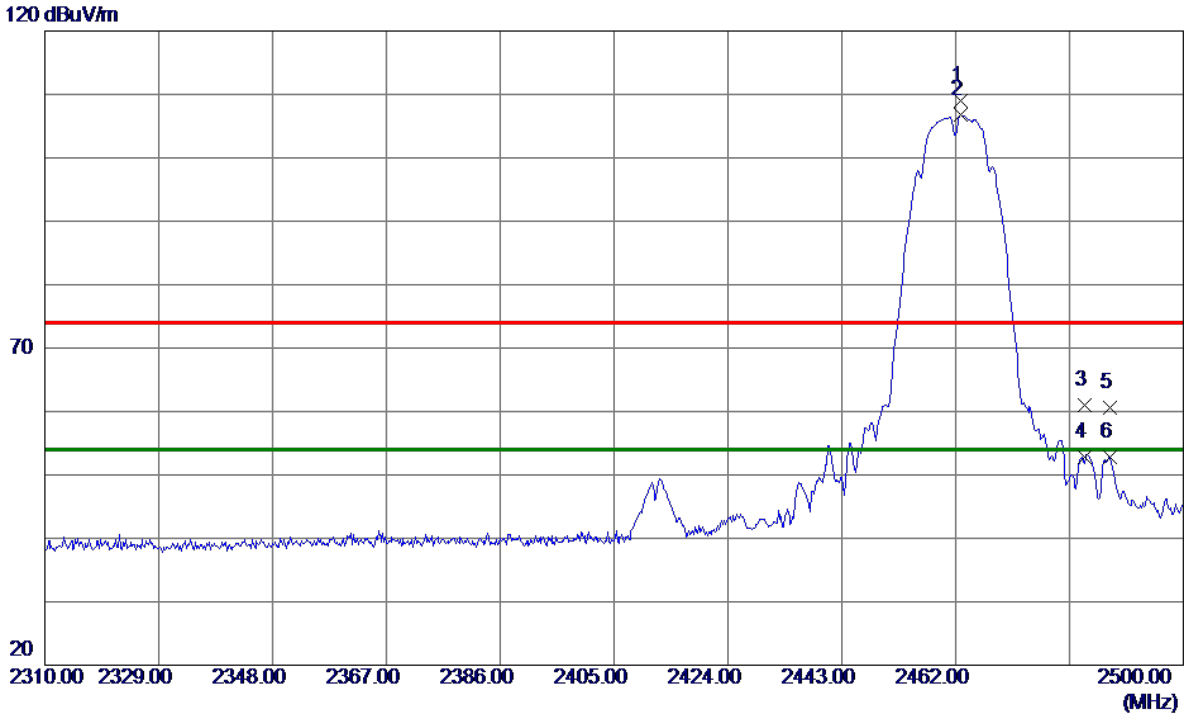

No.	Freq. MHz	Reading Level dBuV/m	Correct Factor dB	Measure ment dBuV/m	Limit dBuV/m	Margin dB	Detector	Comment
1	2462.7600	100.59	8.37	108.96	74.00	34.96	Peak	No limit
2 *	2462.7600	98.44	8.37	106.81	54.00	52.81	AVG	No limit
3	2483.5000	52.65	8.39	61.04	74.00	-12.96	Peak	
4	2483.5000	44.46	8.39	52.85	54.00	-1.15	AVG	
5	2487.6500	52.24	8.39	60.63	74.00	-13.37	Peak	
6	2487.6500	44.42	8.39	52.81	54.00	-1.19	AVG	

REMARKS:

- (1) Measurement Value = Reading Level + Correct Factor.
- (2) Margin Level = Measurement Value - Limit Value.

Test Mode	TX B Mode 2462 MHz	Polarization	Vertical
-----------	--------------------	--------------	----------

86.9 dBuV/m

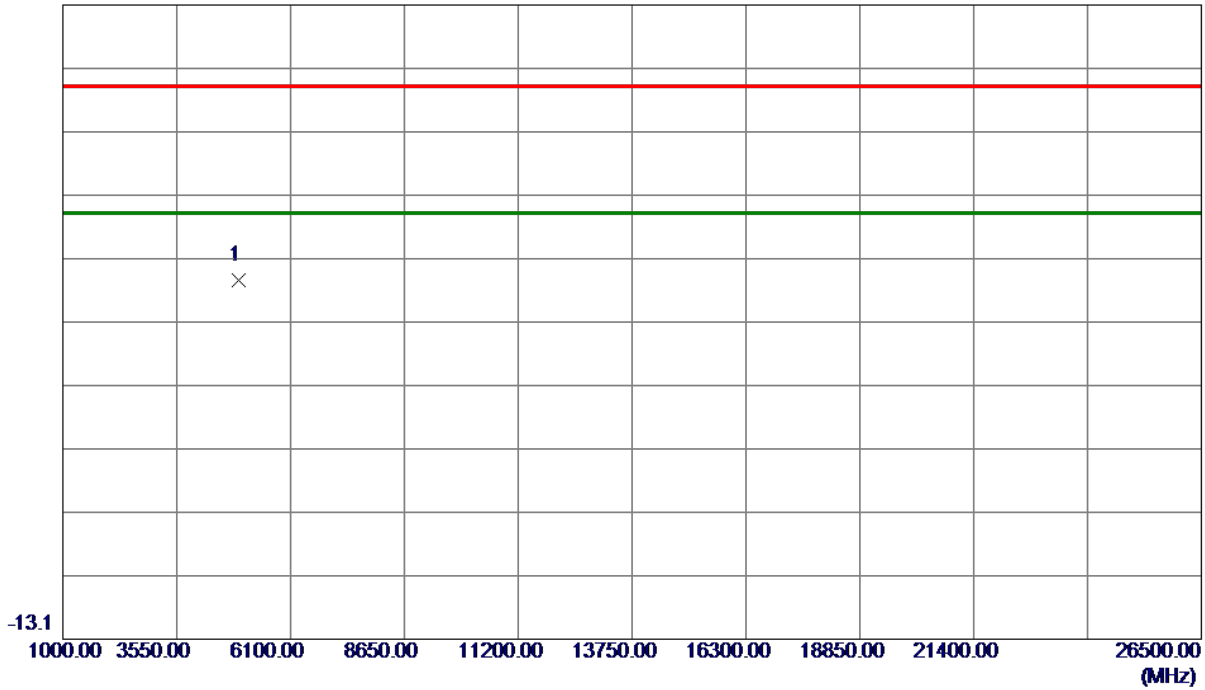

No.	Freq. MHz	Reading Level dBuV/m	Correct Factor dB	Measure ment dBuV/m	Limit dBuV/m	Margin dB	Detector	Comment
1 *	4924.4500	37.93	5.60	43.53	74.00	-30.47	Peak	

REMARKS:

- (1) Measurement Value = Reading Level + Correct Factor.
- (2) Margin Level = Measurement Value - Limit Value.

Test Mode	TX B Mode 2462 MHz	Polarization	Horizontal
-----------	--------------------	--------------	------------

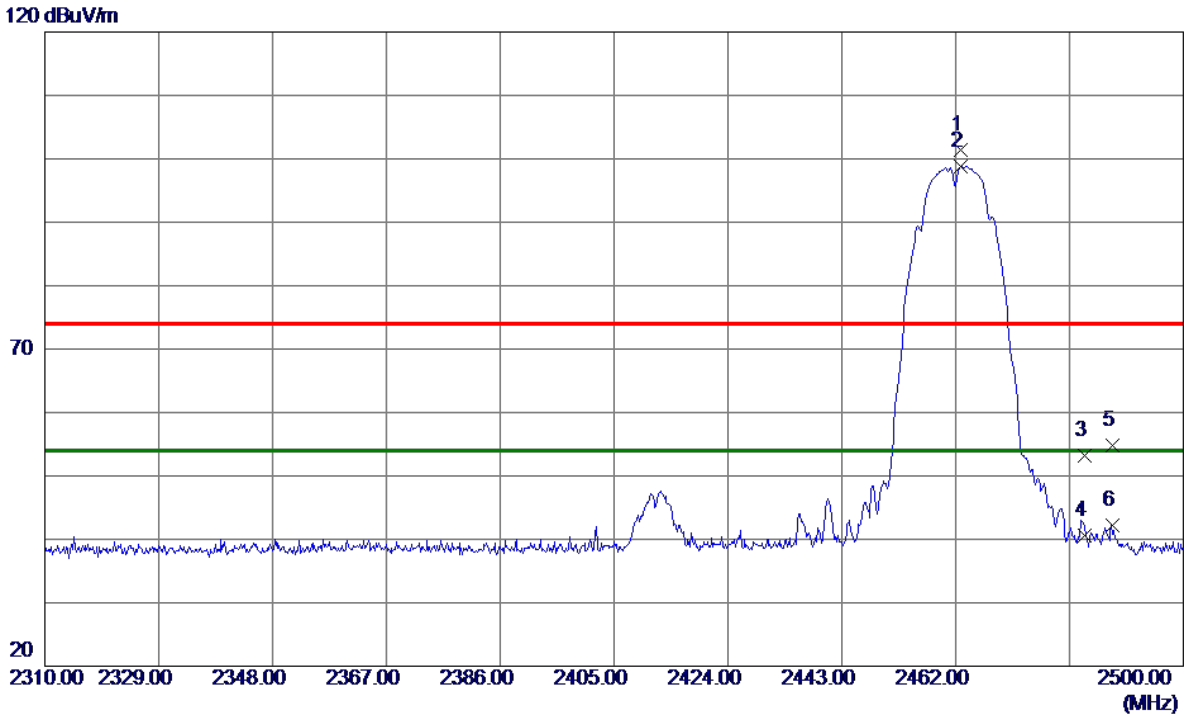

No.	Freq. MHz	Reading Level dBuV/m	Correct Factor dB	Measure ment dBuV/m	Limit dBuV/m	Margin dB	Detector	Comment
1	2462.9500	92.97	8.37	101.34	74.00	27.34	Peak	No limit
2 *	2462.9500	90.44	8.37	98.81	54.00	44.81	AVG	No limit
3	2483.5000	44.80	8.39	53.19	74.00	-20.81	Peak	
4	2483.5000	32.30	8.39	40.69	54.00	-13.31	AVG	
5	2488.1250	46.34	8.39	54.73	74.00	-19.27	Peak	
6	2488.1250	33.72	8.39	42.11	54.00	-11.89	AVG	

REMARKS:

- (1) Measurement Value = Reading Level + Correct Factor.
- (2) Margin Level = Measurement Value - Limit Value.

Test Mode	TX B Mode 2462 MHz	Polarization	Horizontal
-----------	--------------------	--------------	------------

86.9 dBuV/m

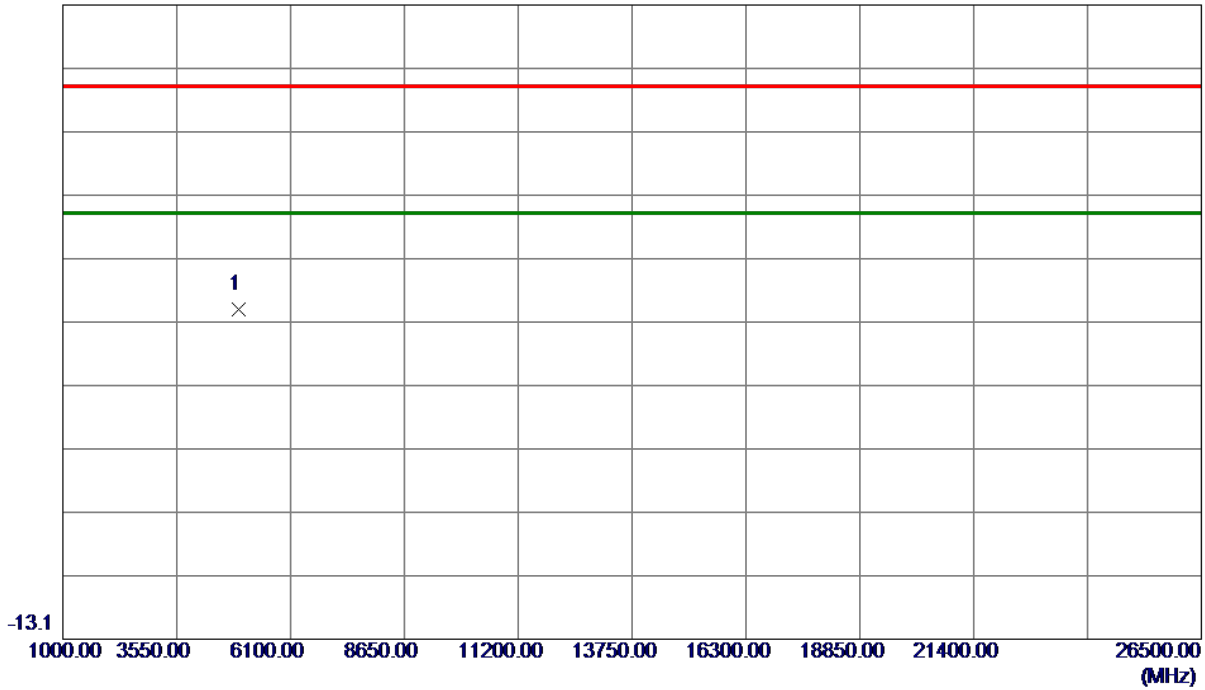

No.	Freq. MHz	Reading Level dBuV/m	Correct Factor dB	Measure ment dBuV/m	Limit dBuV/m	Margin dB	Detector	Comment
1 *	4924.4500	33.25	5.60	38.85	74.00	-35.15	Peak	

REMARKS:

- (1) Measurement Value = Reading Level + Correct Factor.
- (2) Margin Level = Measurement Value - Limit Value.

Test Mode	TX G Mode 2412 MHz	Polarization	Vertical
-----------	--------------------	--------------	----------

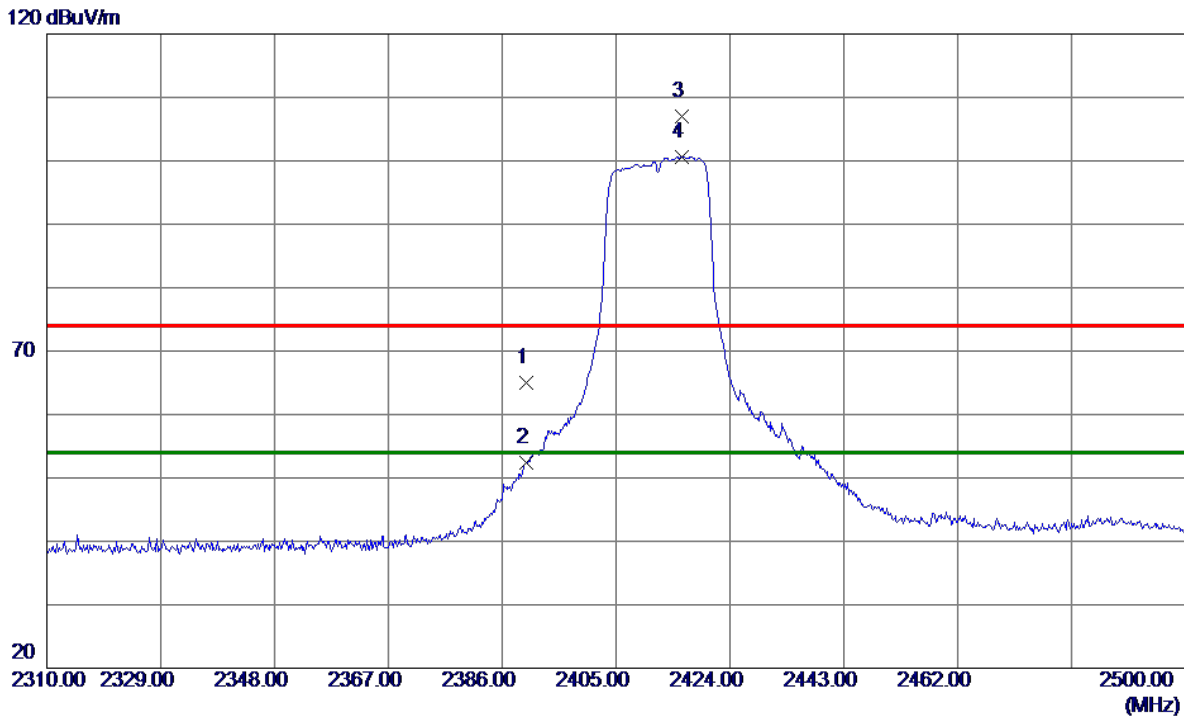

No.	Freq. MHz	Reading Level dBuV/m	Correct Factor dB	Measure ment dBuV/m	Limit dBuV/m	Margin dB	Detector	Comment
1	2390.0000	56.72	8.29	65.01	74.00	-8.99	Peak	
2	2390.0000	44.10	8.29	52.39	54.00	-1.61	AVG	
3	2416.0200	98.65	8.32	106.97	74.00	32.97	Peak	No limit
4 *	2416.0200	92.33	8.32	100.65	54.00	46.65	AVG	No limit

REMARKS:

- (1) Measurement Value = Reading Level + Correct Factor.
- (2) Margin Level = Measurement Value - Limit Value.

Test Mode	TX G Mode 2412 MHz	Polarization	Vertical
-----------	--------------------	--------------	----------

86.9 dBuV/m

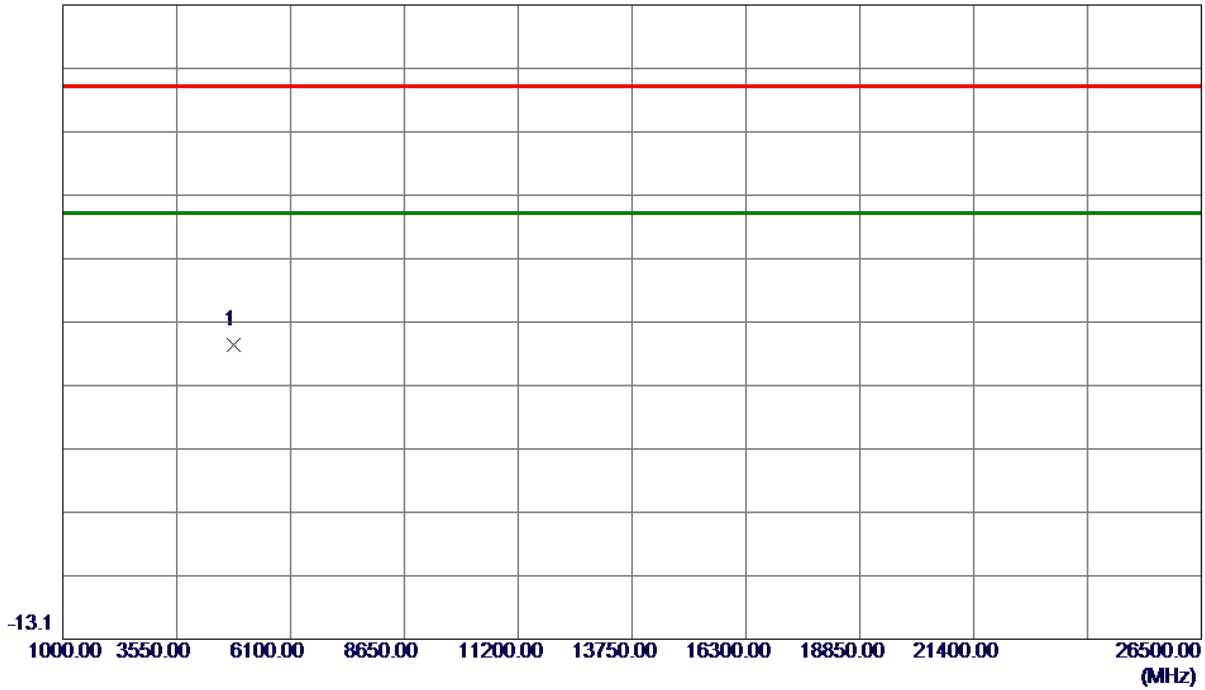

No.	Freq. MHz	Reading Level dBuV/m	Correct Factor dB	Measure ment dBuV/m	Limit dBuV/m	Margin dB	Detector	Comment
1 *	4824.0000	27.97	5.32	33.29	74.00	-40.71	Peak	

REMARKS:

- (1) Measurement Value = Reading Level + Correct Factor.
- (2) Margin Level = Measurement Value - Limit Value.

Test Mode	TX G Mode 2412 MHz	Polarization	Horizontal
-----------	--------------------	--------------	------------

120 dBuV/m

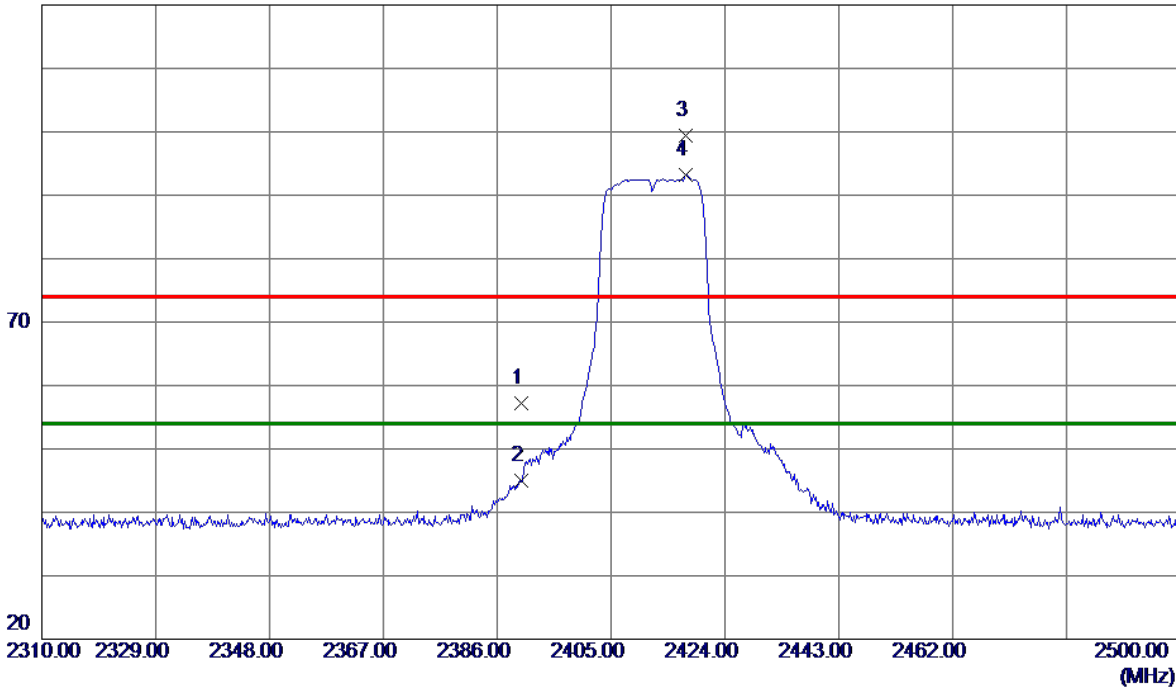

No.	Freq. MHz	Reading Level dBuV/m	Correct Factor dB	Measure ment dBuV/m	Limit dBuV/m	Margin dB	Detector	Comment
1	2390.0000	48.98	8.29	57.27	74.00	-16.73	Peak	
2	2390.0000	36.71	8.29	45.00	54.00	-9.00	AVG	
3	2417.5400	91.05	8.32	99.37	74.00	25.37	Peak	No limit
4 *	2417.5400	84.84	8.32	93.16	54.00	39.16	AVG	No limit

REMARKS:

- (1) Measurement Value = Reading Level + Correct Factor.
- (2) Margin Level = Measurement Value - Limit Value.

Test Mode	TX G Mode 2412 MHz	Polarization	Horizontal
-----------	--------------------	--------------	------------

86.9 dBuV/m

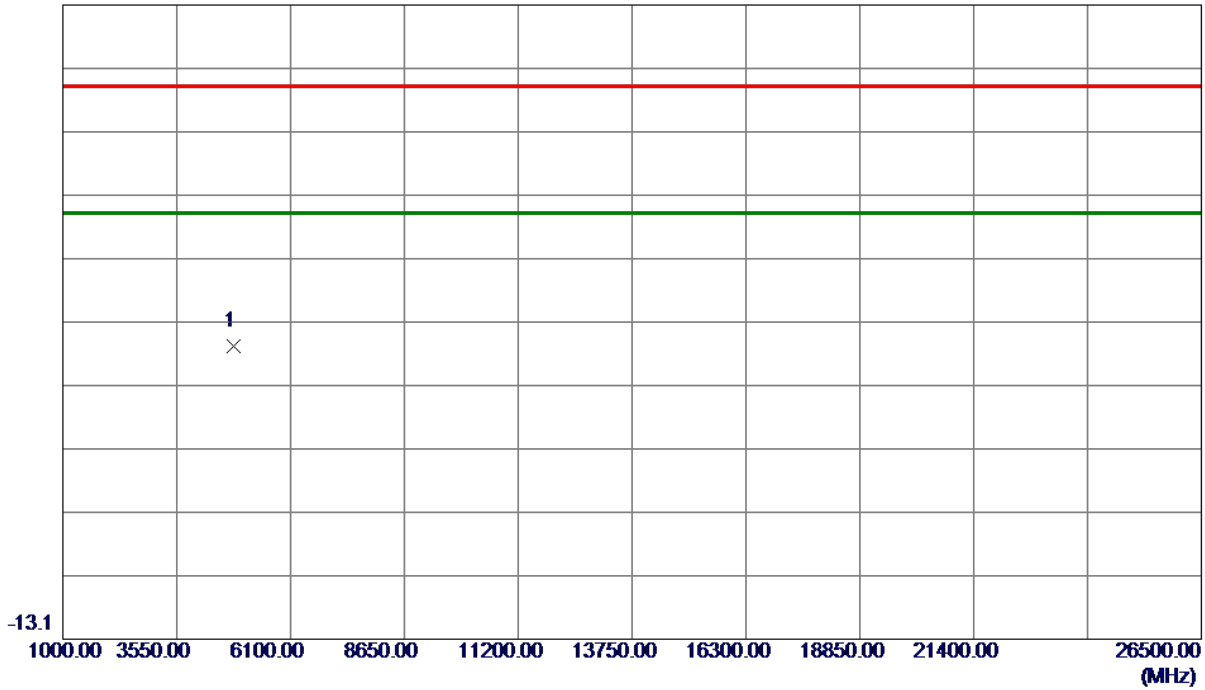

No.	Freq. MHz	Reading Level dBuV/m	Correct Factor dB	Measure ment dBuV/m	Limit dBuV/m	Margin dB	Detector	Comment
1 *	4824.0000	27.83	5.32	33.15	74.00	-40.85	Peak	

REMARKS:

- (1) Measurement Value = Reading Level + Correct Factor.
- (2) Margin Level = Measurement Value - Limit Value.

Test Mode	TX G Mode 2437 MHz	Polarization	Vertical
-----------	--------------------	--------------	----------

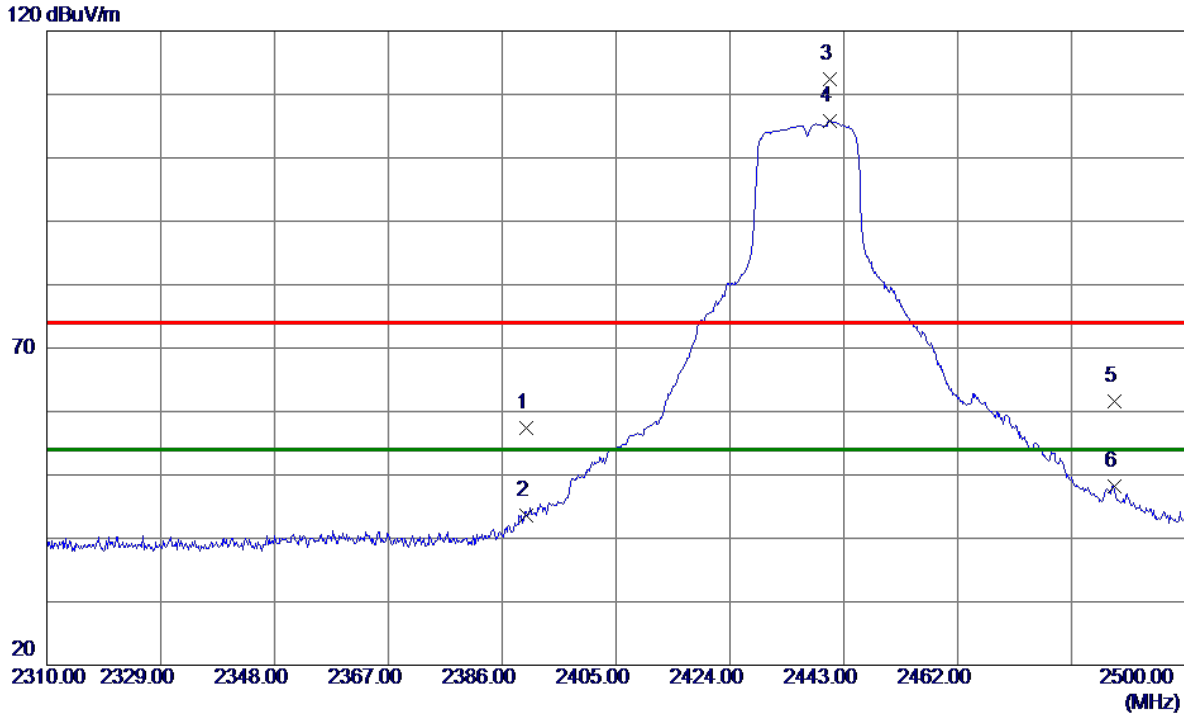

No.	Freq. MHz	Reading Level dBuV/m	Correct Factor dB	Measure ment dBuV/m	Limit dBuV/m	Margin dB	Detector	Comment
1	2390.0000	49.20	8.29	57.49	74.00	-16.51	Peak	
2	2390.0000	35.31	8.29	43.60	54.00	-10.40	AVG	
3	2440.7200	104.12	8.34	112.46	74.00	38.46	Peak	No limit
4 *	2440.7200	97.43	8.34	105.77	54.00	51.77	AVG	No limit
5	2488.1250	53.12	8.39	61.51	74.00	-12.49	Peak	
6	2488.1250	39.81	8.39	48.20	54.00	-5.80	AVG	

REMARKS:

- (1) Measurement Value = Reading Level + Correct Factor.
- (2) Margin Level = Measurement Value - Limit Value.

Test Mode	TX G Mode 2437 MHz	Polarization	Vertical
-----------	--------------------	--------------	----------

86.9 dBuV/m

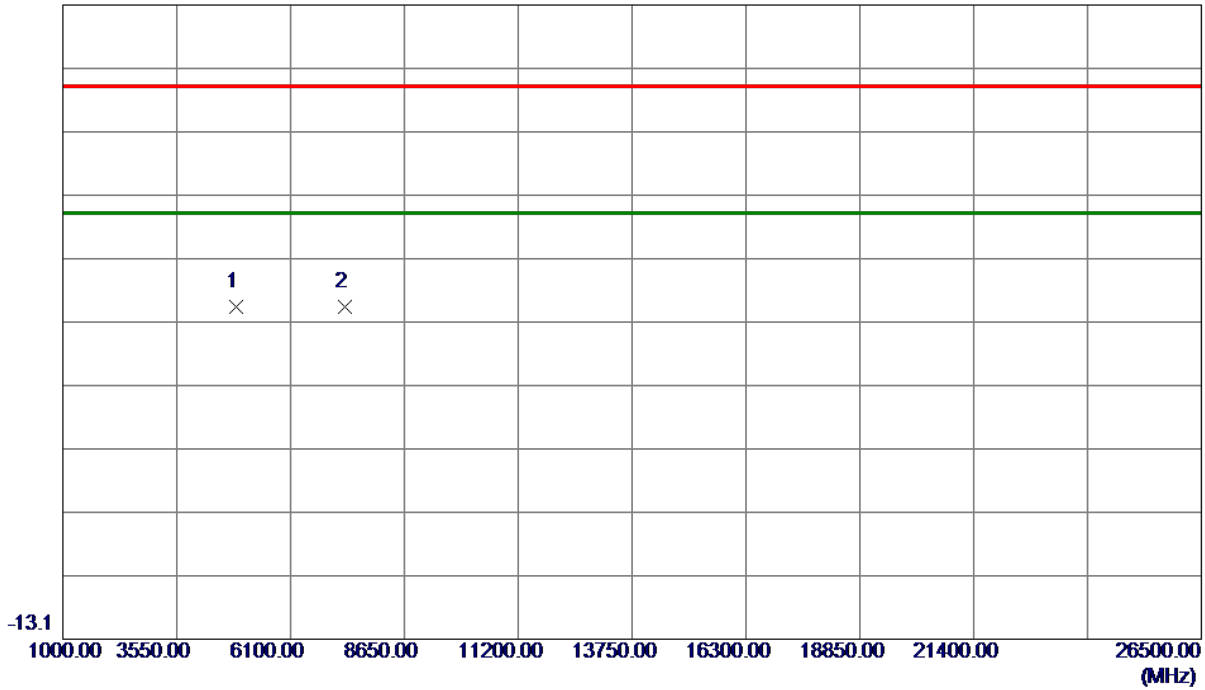

No.	Freq. MHz	Reading Level dBuV/m	Correct Factor dB	Measure ment dBuV/m	Limit dBuV/m	Margin dB	Detector	Comment
1 *	4877.2750	33.90	5.47	39.37	74.00	-34.63	Peak	
2	7306.1500	28.23	11.14	39.37	74.00	-34.63	Peak	

REMARKS:

- (1) Measurement Value = Reading Level + Correct Factor.
- (2) Margin Level = Measurement Value - Limit Value.

Test Mode	TX G Mode 2437 MHz	Polarization	Horizontal
-----------	--------------------	--------------	------------

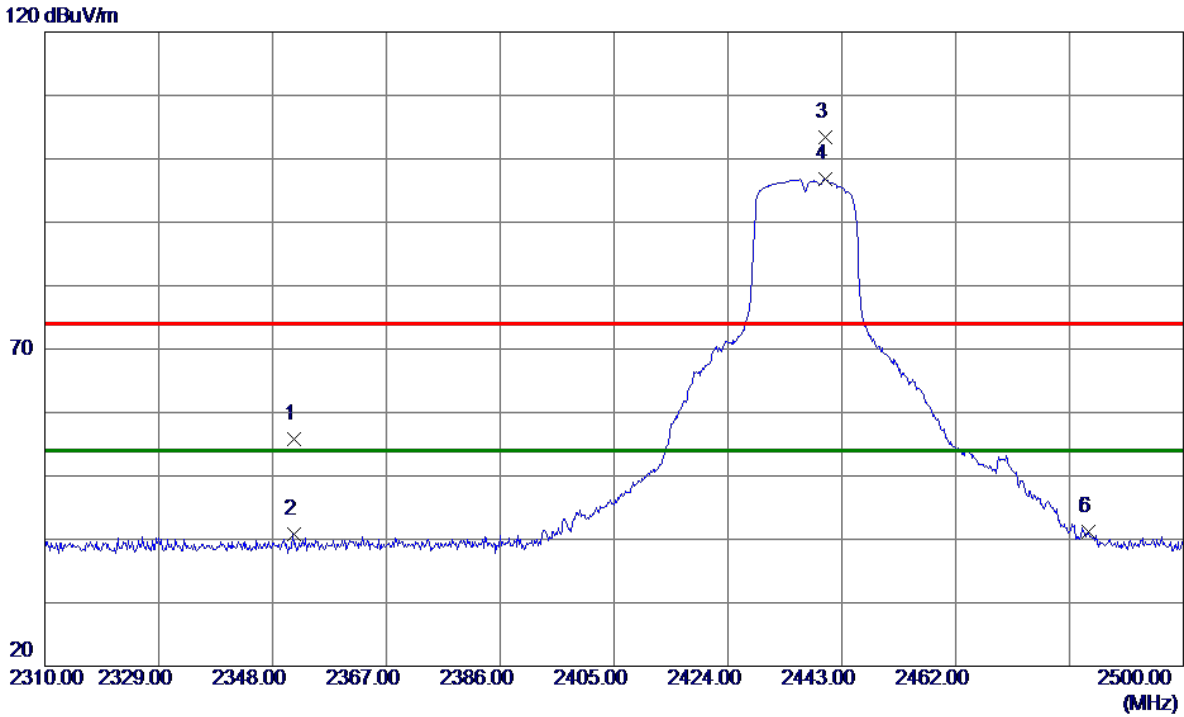

No.	Freq. MHz	Reading Level dBuV/m	Correct Factor dB	Measure ment dBuV/m	Limit dBuV/m	Margin dB	Detector	Comment
1	2351.5149	47.60	8.25	55.85	74.00	-18.15	Peak	
2	2351.5149	32.56	8.25	40.81	54.00	-13.19	AVG	
3	2440.2450	95.03	8.34	103.37	74.00	29.37	Peak	No limit
4 *	2440.2450	88.48	8.34	96.82	54.00	42.82	AVG	No limit
5	2484.2300	32.82	8.39	41.21	74.00	-32.79	Peak	
6	2484.2300	32.82	8.39	41.21	54.00	-12.79	AVG	

REMARKS:

- (1) Measurement Value = Reading Level + Correct Factor.
- (2) Margin Level = Measurement Value - Limit Value.

Test Mode	TX G Mode 2437 MHz	Polarization	Horizontal
-----------	--------------------	--------------	------------

86.9 dBuV/m

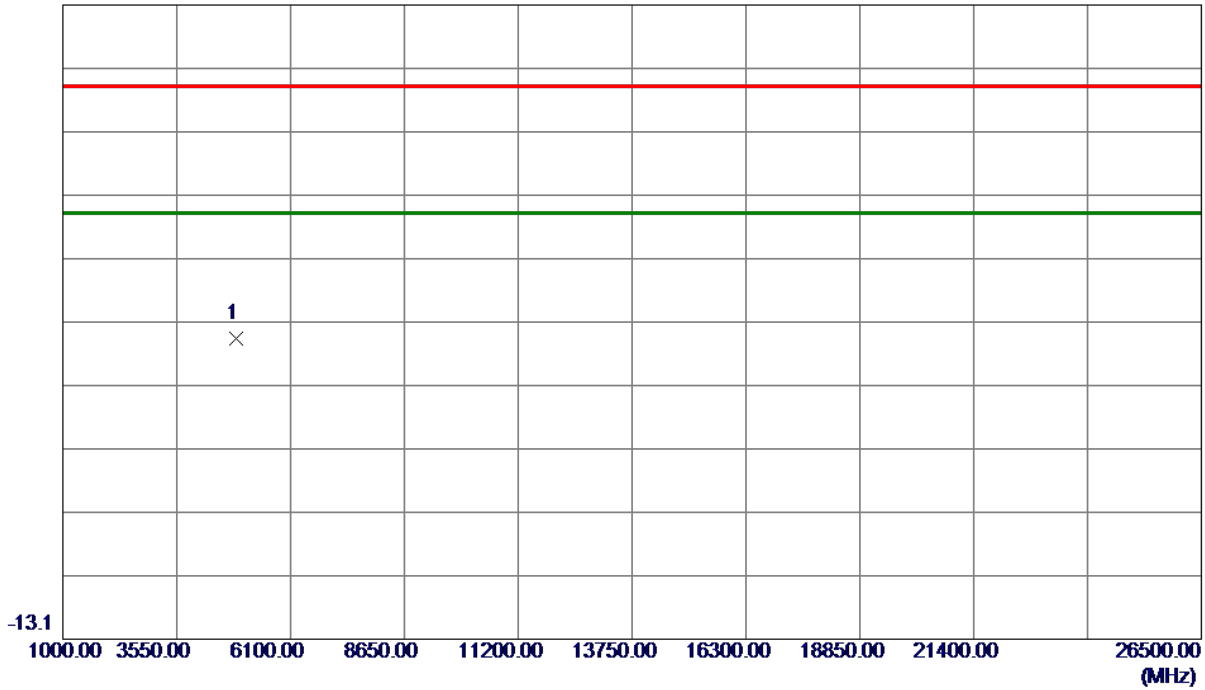

No.	Freq. MHz	Reading Level dBuV/m	Correct Factor dB	Measure ment dBuV/m	Limit dBuV/m	Margin dB	Detector	Comment
1 *	4874.0000	28.75	5.46	34.21	74.00	-39.79	Peak	

REMARKS:

- (1) Measurement Value = Reading Level + Correct Factor.
- (2) Margin Level = Measurement Value - Limit Value.

Test Mode	TX G Mode 2462 MHz	Polarization	Vertical
-----------	--------------------	--------------	----------

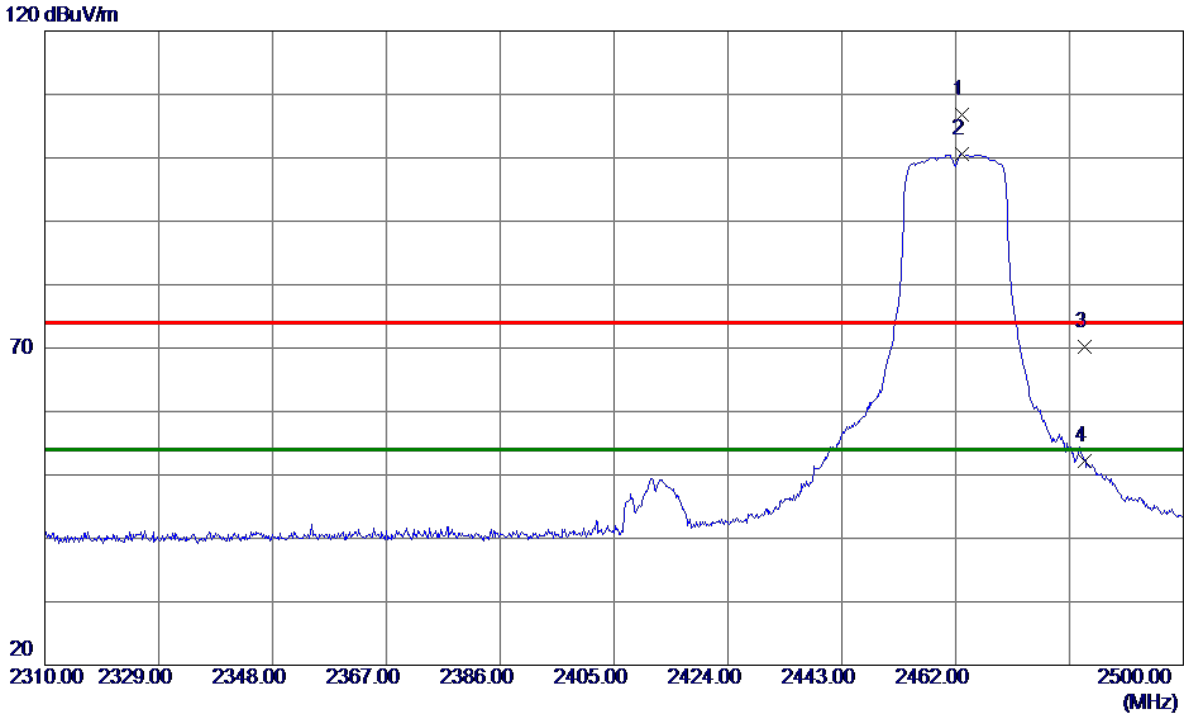

No.	Freq. MHz	Reading Level dBuV/m	Correct Factor dB	Measure ment dBuV/m	Limit dBuV/m	Margin dB	Detector	Comment
1	2463.1399	98.50	8.37	106.87	74.00	32.87	Peak	No limit
2 *	2463.1399	92.20	8.37	100.57	54.00	46.57	AVG	No limit
3	2483.5000	61.79	8.39	70.18	74.00	-3.82	Peak	
4	2483.5000	43.85	8.39	52.24	54.00	-1.76	AVG	

REMARKS:

- (1) Measurement Value = Reading Level + Correct Factor.
- (2) Margin Level = Measurement Value - Limit Value.

Test Mode	TX G Mode 2462 MHz	Polarization	Vertical
-----------	--------------------	--------------	----------

86.9 dBuV/m

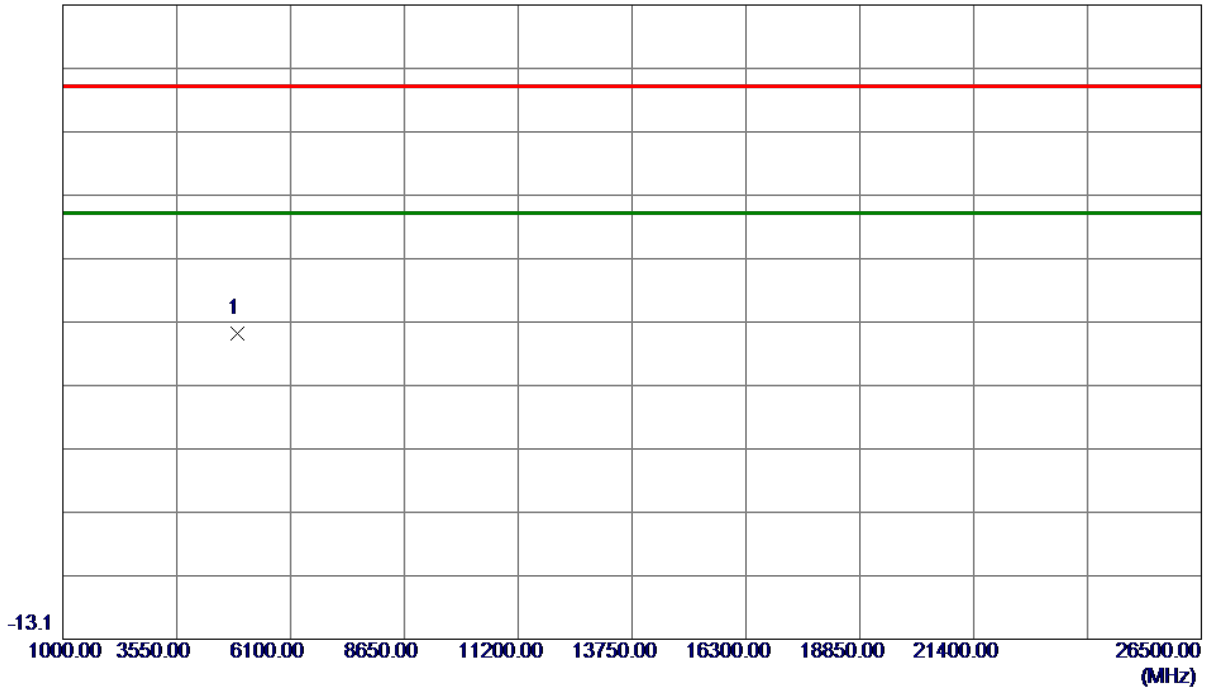

No.	Freq. MHz	Reading Level dBuV/m	Correct Factor dB	Measure ment dBuV/m	Limit dBuV/m	Margin dB	Detector	Comment
1 *	4921.9000	29.51	5.59	35.10	74.00	-38.90	Peak	

REMARKS:

- (1) Measurement Value = Reading Level + Correct Factor.
- (2) Margin Level = Measurement Value - Limit Value.

Test Mode	TX G Mode 2462 MHz	Polarization	Horizontal
-----------	--------------------	--------------	------------

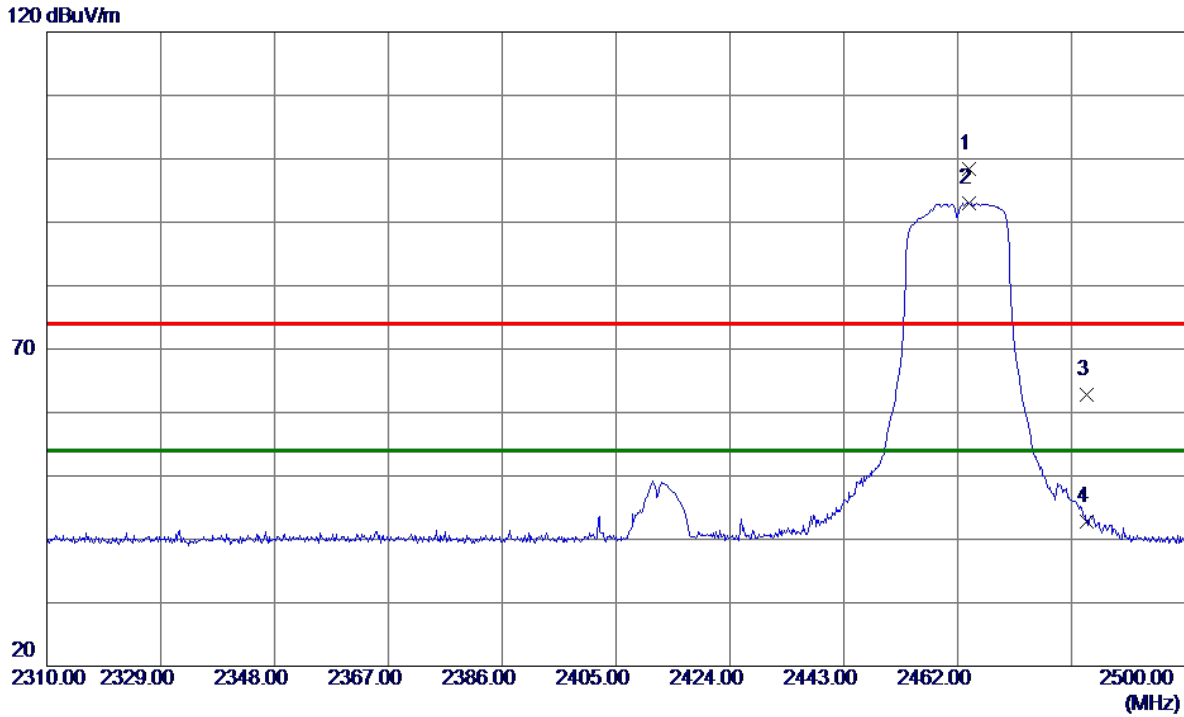

No.	Freq. MHz	Reading Level dBuV/m	Correct Factor dB	Measure ment dBuV/m	Limit dBuV/m	Margin dB	Detector	Comment
1	2463.9000	90.12	8.37	98.49	74.00	24.49	Peak	No limit
2 *	2463.9000	84.62	8.37	92.99	54.00	38.99	AVG	No limit
3	2483.5000	54.49	8.39	62.88	74.00	-11.12	Peak	
4	2483.5000	34.33	8.39	42.72	54.00	-11.28	AVG	

REMARKS:

- (1) Measurement Value = Reading Level + Correct Factor.
- (2) Margin Level = Measurement Value - Limit Value.

Test Mode	TX G Mode 2462 MHz	Polarization	Horizontal
-----------	--------------------	--------------	------------

86.9 dBuV/m

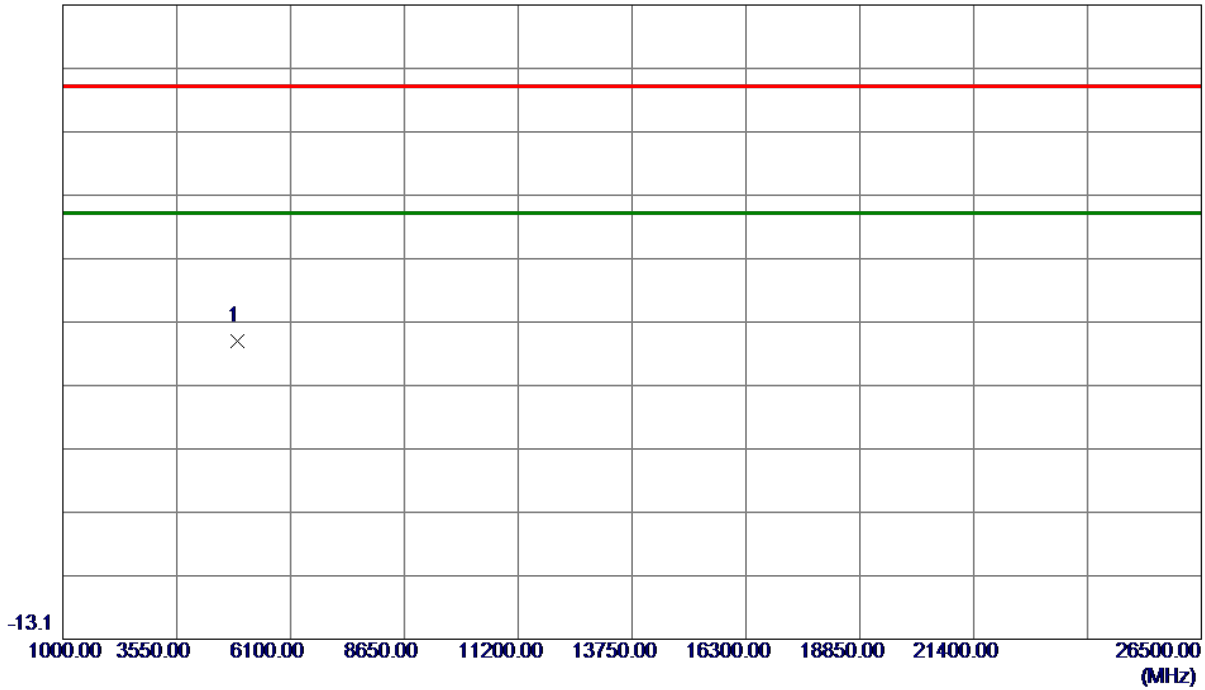

No.	Freq. MHz	Reading Level dBuV/m	Correct Factor dB	Measure ment dBuV/m	Limit dBuV/m	Margin dB	Detector	Comment
1 *	4924.0000	28.31	5.59	33.90	74.00	-40.10	Peak	

REMARKS:

- (1) Measurement Value = Reading Level + Correct Factor.
- (2) Margin Level = Measurement Value - Limit Value.

Test Mode	TX N(HT20) Mode 2412 MHz	Polarization	Vertical
-----------	--------------------------	--------------	----------

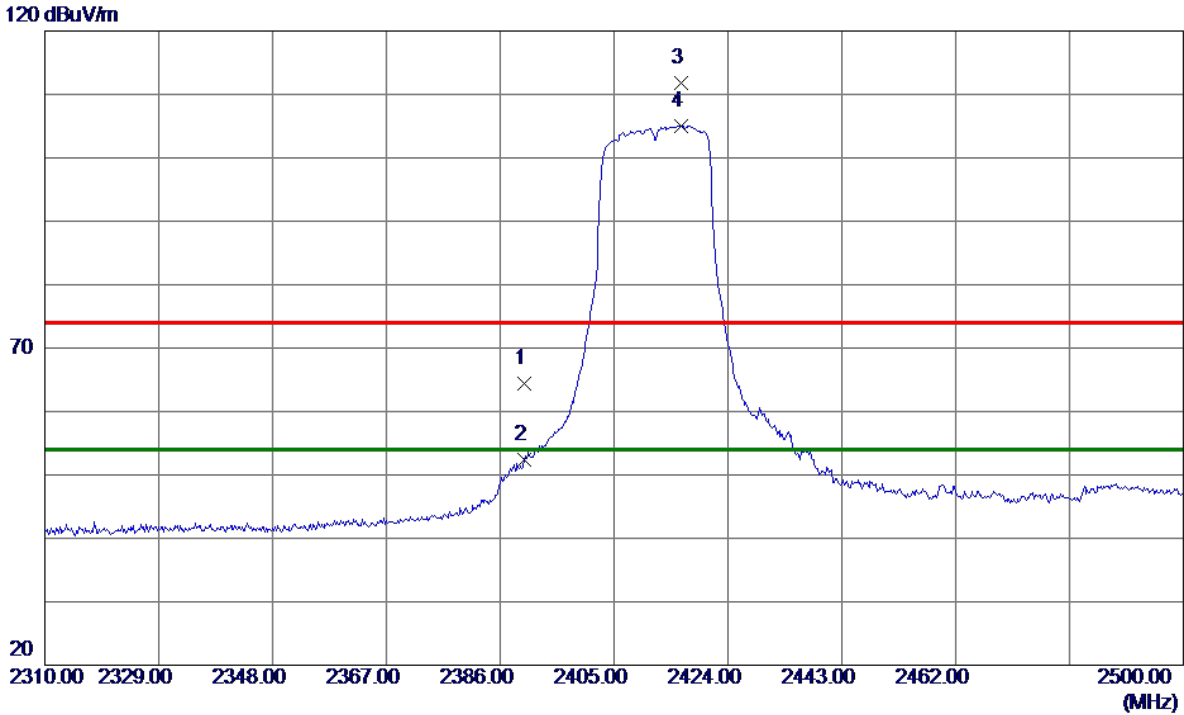

No.	Freq. MHz	Reading Level dBuV/m	Correct Factor dB	Measure ment dBuV/m	Limit dBuV/m	Margin dB	Detector	Comment
1	2390.0000	56.17	8.29	64.46	74.00	-9.54	Peak	
2	2390.0000	44.20	8.29	52.49	54.00	-1.51	AVG	
3	2416.2100	103.55	8.32	111.87	74.00	37.87	Peak	No limit
4 *	2416.2100	96.76	8.32	105.08	54.00	51.08	AVG	No limit

REMARKS:

- (1) Measurement Value = Reading Level + Correct Factor.
- (2) Margin Level = Measurement Value - Limit Value.

Test Mode	TX N(HT20) Mode 2412 MHz	Polarization	Vertical
-----------	--------------------------	--------------	----------

86.9 dBuV/m

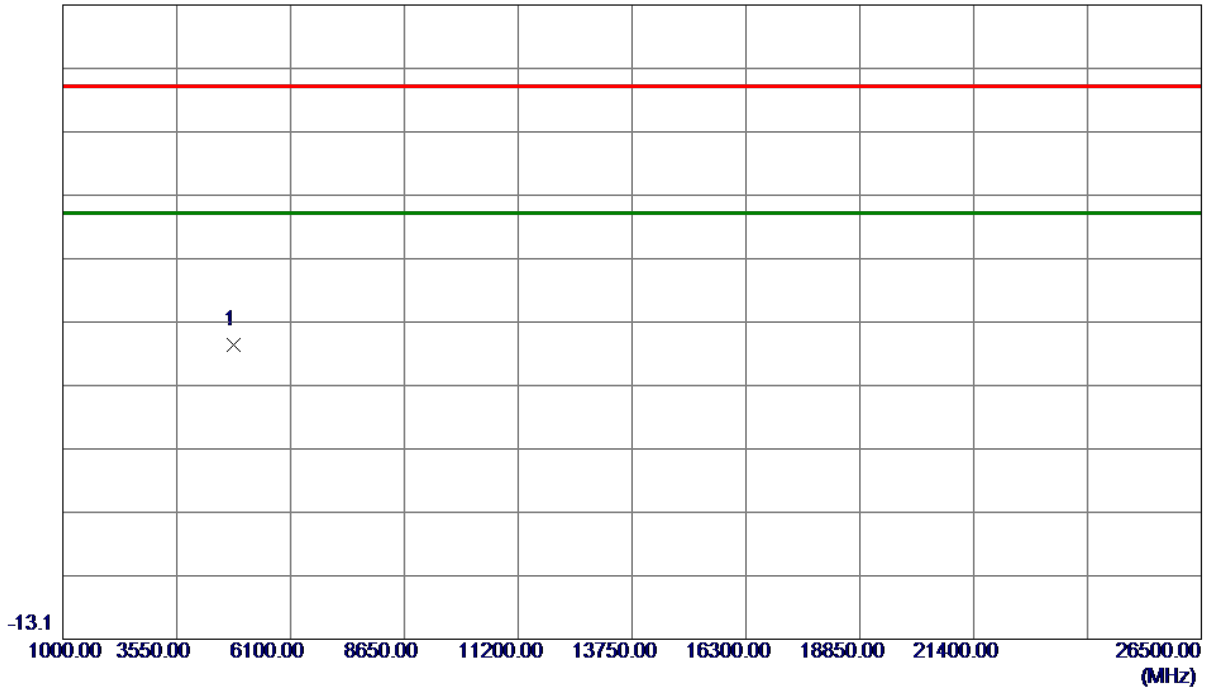

No.	Freq. MHz	Reading Level dBuV/m	Correct Factor dB	Measure ment dBuV/m	Limit dBuV/m	Margin dB	Detector	Comment
1 *	4824.0000	27.96	5.32	33.28	74.00	-40.72	Peak	

REMARKS:

- (1) Measurement Value = Reading Level + Correct Factor.
- (2) Margin Level = Measurement Value - Limit Value.

Test Mode	TX N(HT20) Mode 2412 MHz	Polarization	Horizontal
-----------	--------------------------	--------------	------------

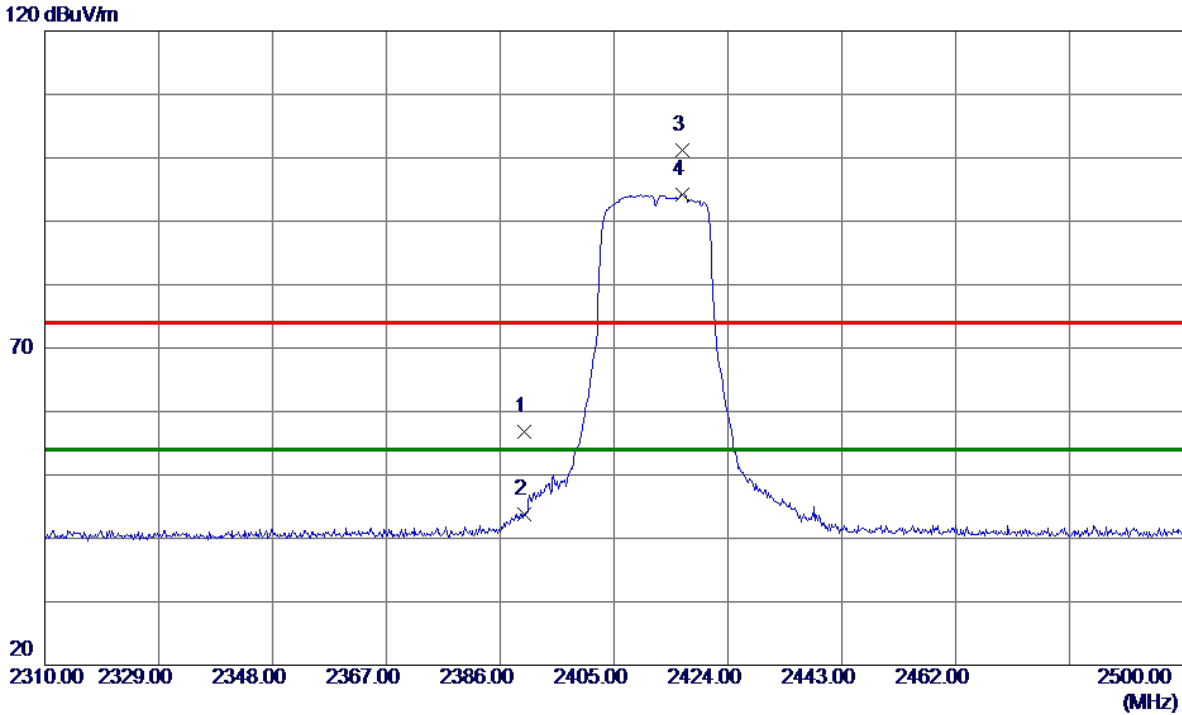

No.	Freq. MHz	Reading Level dBuV/m	Correct Factor dB	Measure ment dBuV/m	Limit dBuV/m	Margin dB	Detector	Comment
1	2390.0000	48.46	8.29	56.75	74.00	-17.25	Peak	
2	2390.0000	35.52	8.29	43.81	54.00	-10.19	AVG	
3	2416.3050	92.88	8.32	101.20	74.00	27.20	Peak	No limit
4 *	2416.3050	85.91	8.32	94.23	54.00	40.23	AVG	No limit

REMARKS:

- (1) Measurement Value = Reading Level + Correct Factor.
- (2) Margin Level = Measurement Value - Limit Value.

Test Mode	TX N(HT20) Mode 2412 MHz	Polarization	Horizontal
-----------	--------------------------	--------------	------------

86.9 dBuV/m

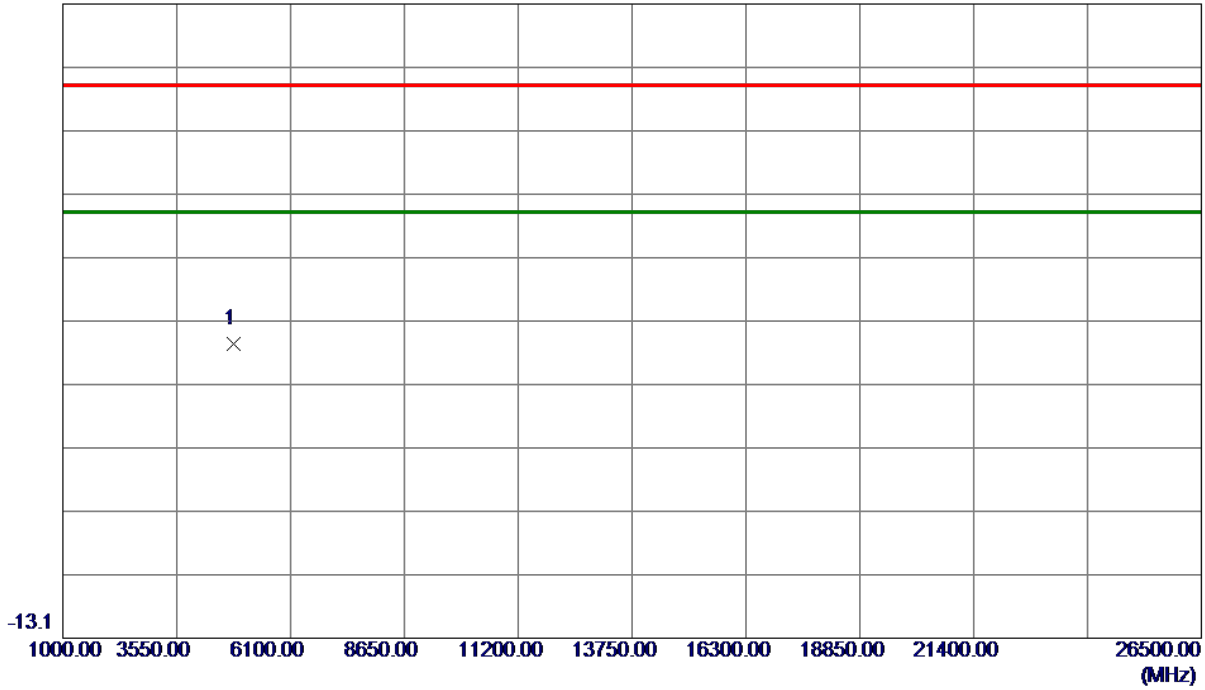

No.	Freq. MHz	Reading Level dBuV/m	Correct Factor dB	Measure ment dBuV/m	Limit dBuV/m	Margin dB	Detector	Comment
1 *	4824.0000	27.91	5.32	33.23	74.00	-40.77	Peak	

REMARKS:

- (1) Measurement Value = Reading Level + Correct Factor.
- (2) Margin Level = Measurement Value - Limit Value.

Test Mode	TX N(HT20) Mode 2437 MHz	Polarization	Vertical
-----------	--------------------------	--------------	----------

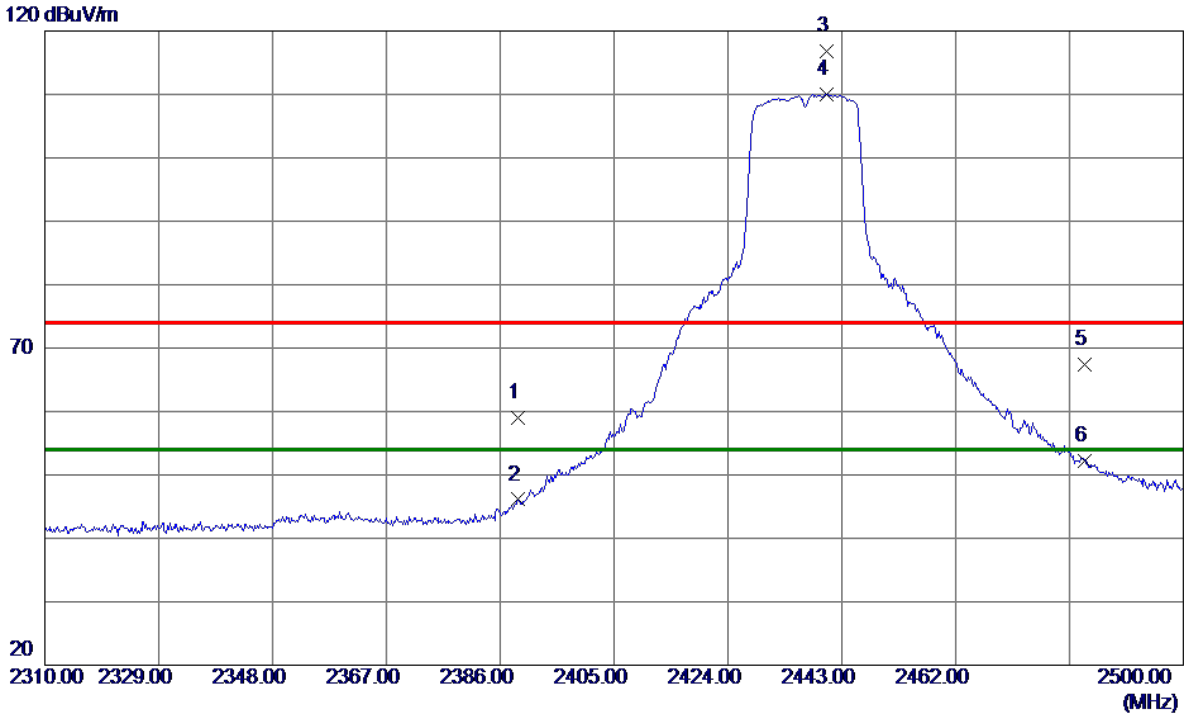

No.	Freq. MHz	Reading Level dBuV/m	Correct Factor dB	Measure ment dBuV/m	Limit dBuV/m	Margin dB	Detector	Comment
1	2388.9450	50.71	8.29	59.00	74.00	-15.00	Peak	
2	2388.9450	37.81	8.29	46.10	54.00	-7.90	AVG	
3	2440.4350	108.54	8.34	116.88	74.00	42.88	Peak	No limit
4 *	2440.4350	101.75	8.34	110.09	54.00	56.09	AVG	No limit
5	2483.5000	59.09	8.39	67.48	74.00	-6.52	Peak	
6	2483.5000	43.78	8.39	52.17	54.00	-1.83	AVG	

REMARKS:

- (1) Measurement Value = Reading Level + Correct Factor.
- (2) Margin Level = Measurement Value - Limit Value.

Test Mode	TX N(HT20) Mode 2437 MHz	Polarization	Vertical
-----------	--------------------------	--------------	----------

86.9 dBuV/m

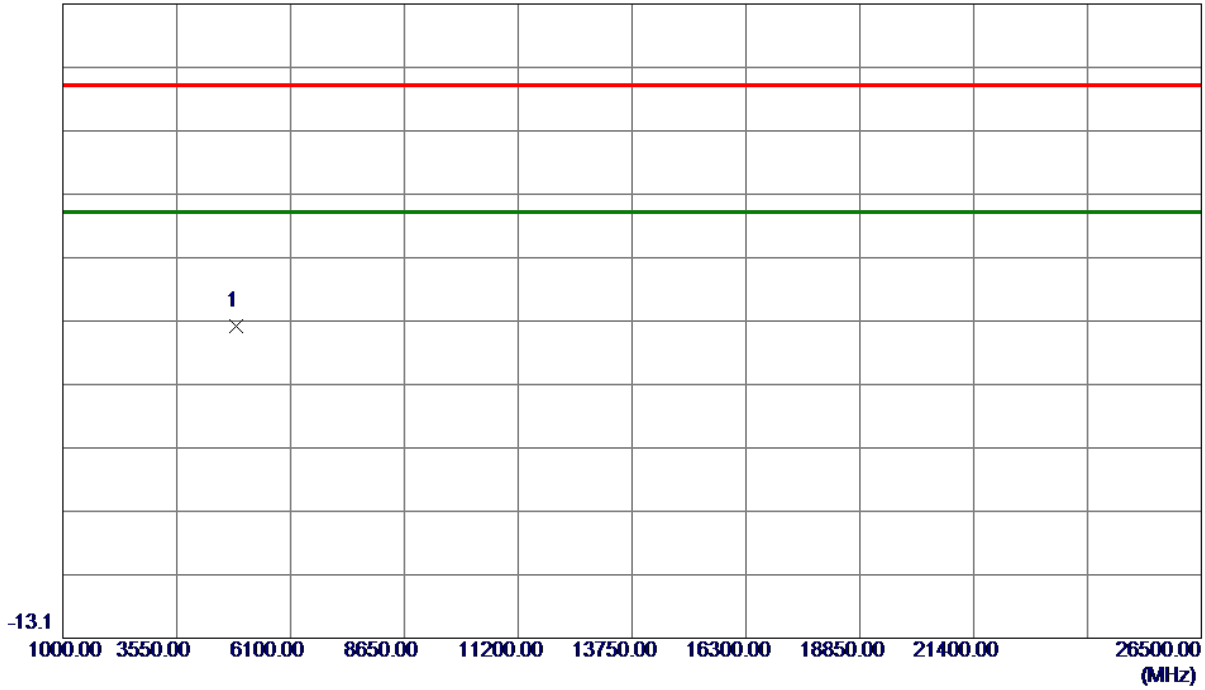

No.	Freq. MHz	Reading Level dBuV/m	Correct Factor dB	Measure ment dBuV/m	Limit dBuV/m	Margin dB	Detector	Comment
1 *	4870.9000	30.61	5.45	36.06	74.00	-37.94	Peak	

REMARKS:

- (1) Measurement Value = Reading Level + Correct Factor.
- (2) Margin Level = Measurement Value - Limit Value.

Test Mode	TX N(HT20) Mode 2437 MHz	Polarization	Horizontal
-----------	--------------------------	--------------	------------

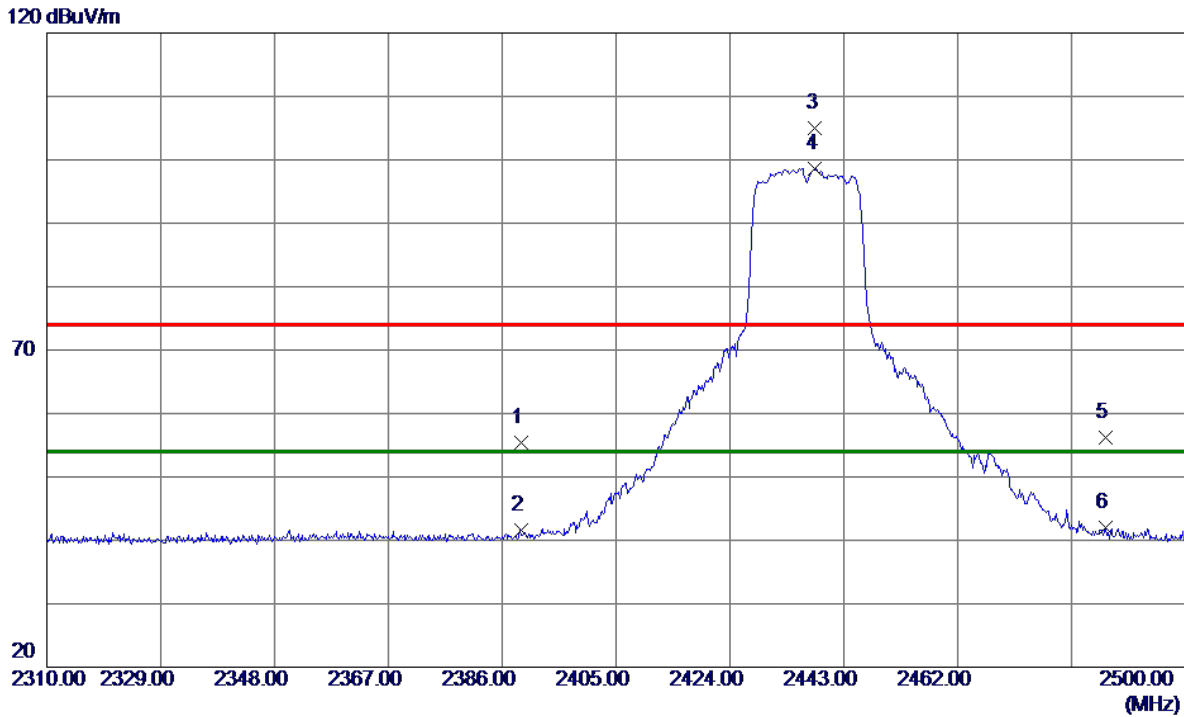

No.	Freq. MHz	Reading Level dBuV/m	Correct Factor dB	Measure ment dBuV/m	Limit dBuV/m	Margin dB	Detector	Comment
1	2389.1350	47.19	8.29	55.48	74.00	-18.52	Peak	
2	2389.1350	33.28	8.29	41.57	54.00	-12.43	AVG	
3	2438.2500	96.61	8.34	104.95	74.00	30.95	Peak	No limit
4 *	2438.2500	90.20	8.34	98.54	54.00	44.54	AVG	No limit
5	2486.7000	47.82	8.39	56.21	74.00	-17.79	Peak	
6	2486.7000	33.58	8.39	41.97	54.00	-12.03	AVG	

REMARKS:

- (1) Measurement Value = Reading Level + Correct Factor.
- (2) Margin Level = Measurement Value - Limit Value.

Test Mode	TX N(HT20) Mode 2437 MHz	Polarization	Horizontal
-----------	--------------------------	--------------	------------

86.9 dBuV/m

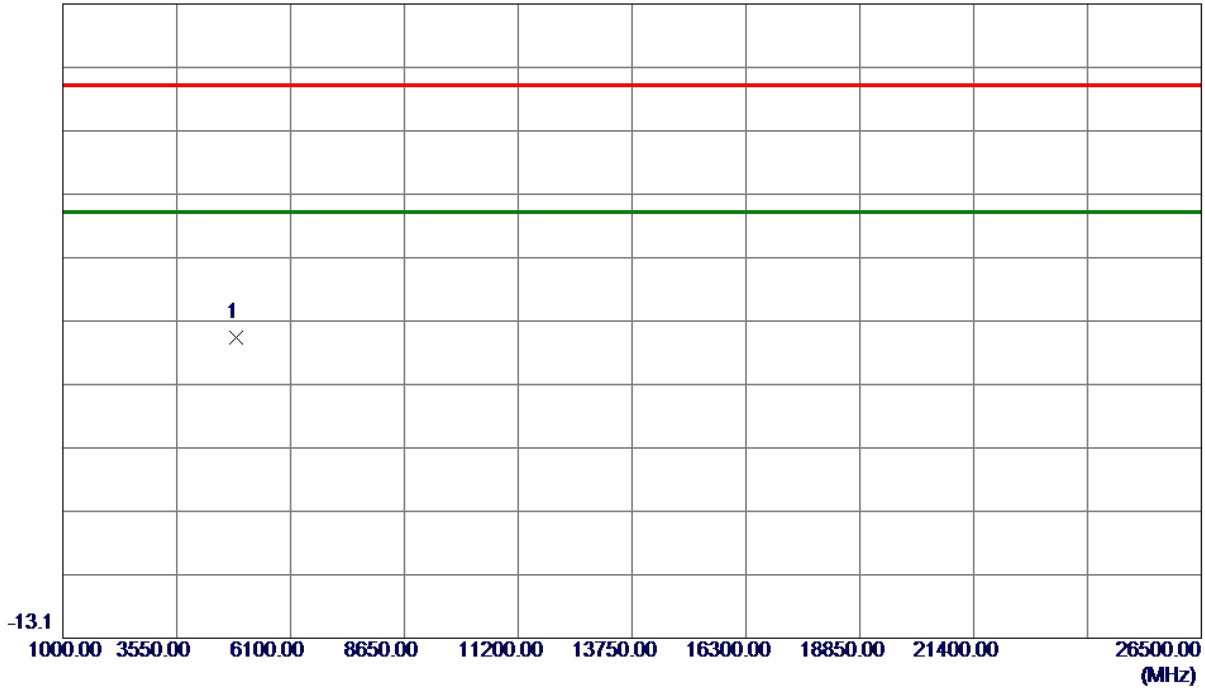

No.	Freq. MHz	Reading Level dBuV/m	Correct Factor dB	Measure ment dBuV/m	Limit dBuV/m	Margin dB	Detector	Comment
1 *	4874.0000	28.75	5.46	34.21	74.00	-39.79	Peak	

REMARKS:

- (1) Measurement Value = Reading Level + Correct Factor.
- (2) Margin Level = Measurement Value - Limit Value.

Test Mode	TX N(HT20) Mode 2462 MHz	Polarization	Vertical
-----------	--------------------------	--------------	----------

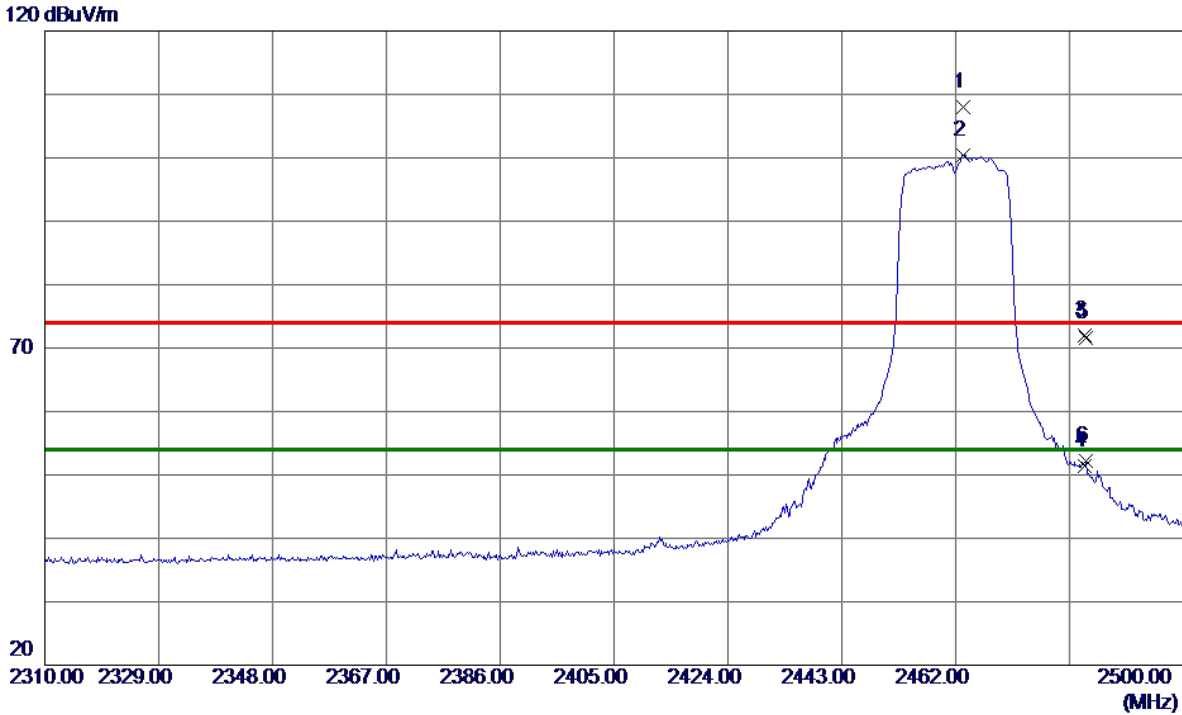

No.	Freq. MHz	Reading Level dBuV/m	Correct Factor dB	Measure ment dBuV/m	Limit dBuV/m	Margin dB	Detector	Comment
1	2463.3300	99.71	8.37	108.08	74.00	34.08	Peak	No limit
2 *	2463.3300	92.10	8.37	100.47	54.00	46.47	AVG	No limit
3	2483.5000	63.61	8.39	72.00	74.00	-2.00	Peak	
4	2483.5000	43.04	8.39	51.43	54.00	-2.57	AVG	
5	2483.8500	63.21	8.39	71.60	74.00	-2.40	Peak	
6	2483.8500	43.90	8.39	52.29	54.00	-1.71	AVG	

REMARKS:

- (1) Measurement Value = Reading Level + Correct Factor.
- (2) Margin Level = Measurement Value - Limit Value.

Test Mode	TX N(HT20) Mode 2462 MHz	Polarization	Vertical
-----------	--------------------------	--------------	----------

86.9 dBuV/m

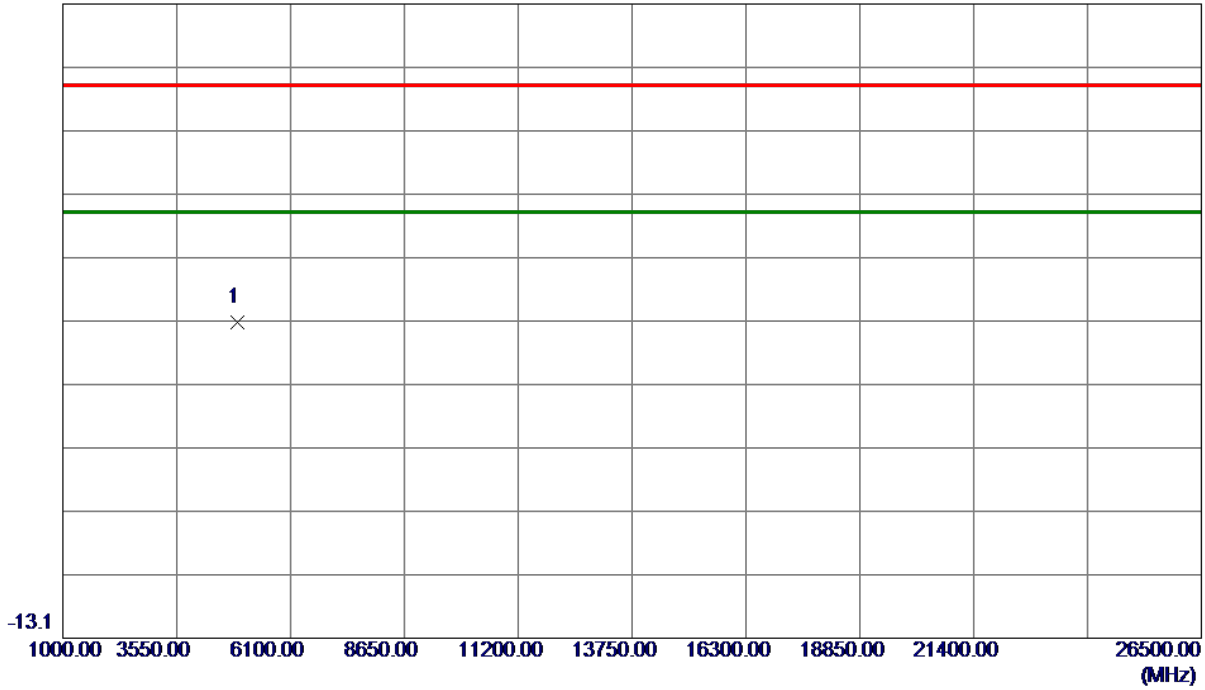

No.	Freq. MHz	Reading Level dBuV/m	Correct Factor dB	Measure ment dBuV/m	Limit dBuV/m	Margin dB	Detector	Comment
1 *	4923.1750	31.10	5.59	36.69	74.00	-37.31	Peak	

REMARKS:

- (1) Measurement Value = Reading Level + Correct Factor.
- (2) Margin Level = Measurement Value - Limit Value.

Test Mode	TX N(HT20) Mode 2462 MHz	Polarization	Horizontal
-----------	--------------------------	--------------	------------

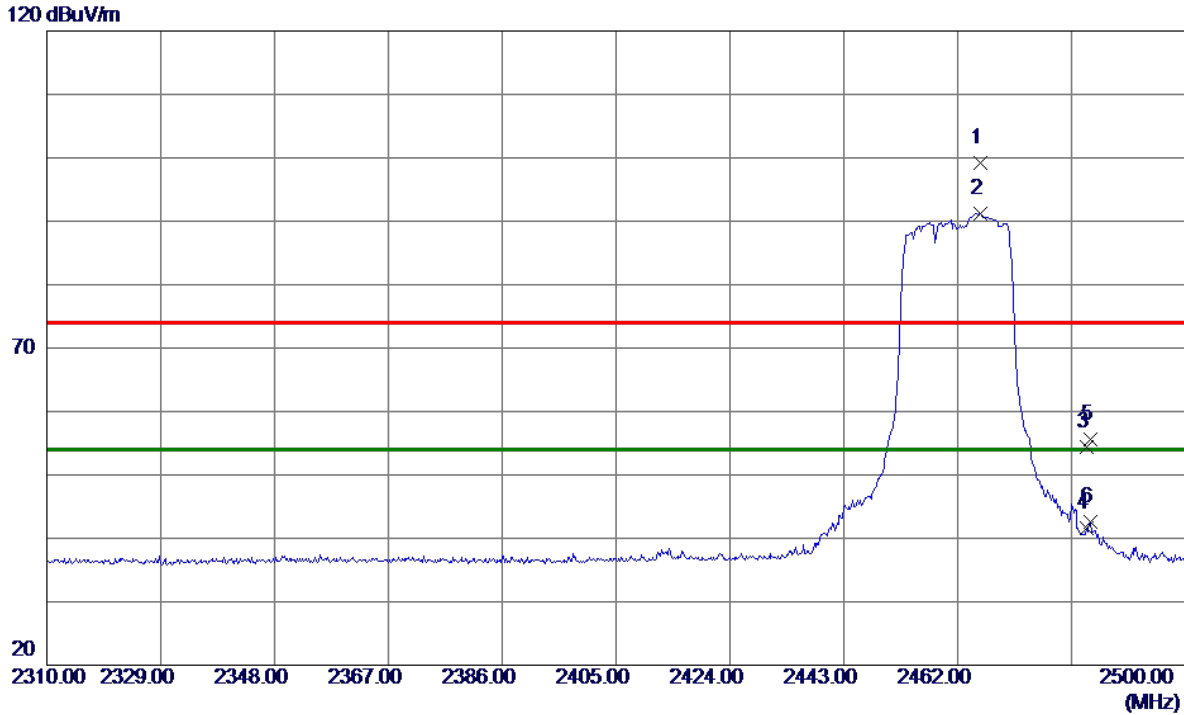

No.	Freq. MHz	Reading Level dBuV/m	Correct Factor dB	Measure ment dBuV/m	Limit dBuV/m	Margin dB	Detector	Comment
1	2465.7050	90.81	8.37	99.18	74.00	25.18	Peak	No limit
2 *	2465.7050	82.81	8.37	91.18	54.00	37.18	AVG	No limit
3	2483.5000	45.93	8.39	54.32	74.00	-19.68	Peak	
4	2483.5000	33.29	8.39	41.68	54.00	-12.32	AVG	
5	2484.2300	47.13	8.39	55.52	74.00	-18.48	Peak	
6	2484.2300	34.19	8.39	42.58	54.00	-11.42	AVG	

REMARKS:

- (1) Measurement Value = Reading Level + Correct Factor.
- (2) Margin Level = Measurement Value - Limit Value.

Test Mode	TX N(HT20) Mode 2462 MHz	Polarization	Horizontal
-----------	--------------------------	--------------	------------

86.9 dBuV/m

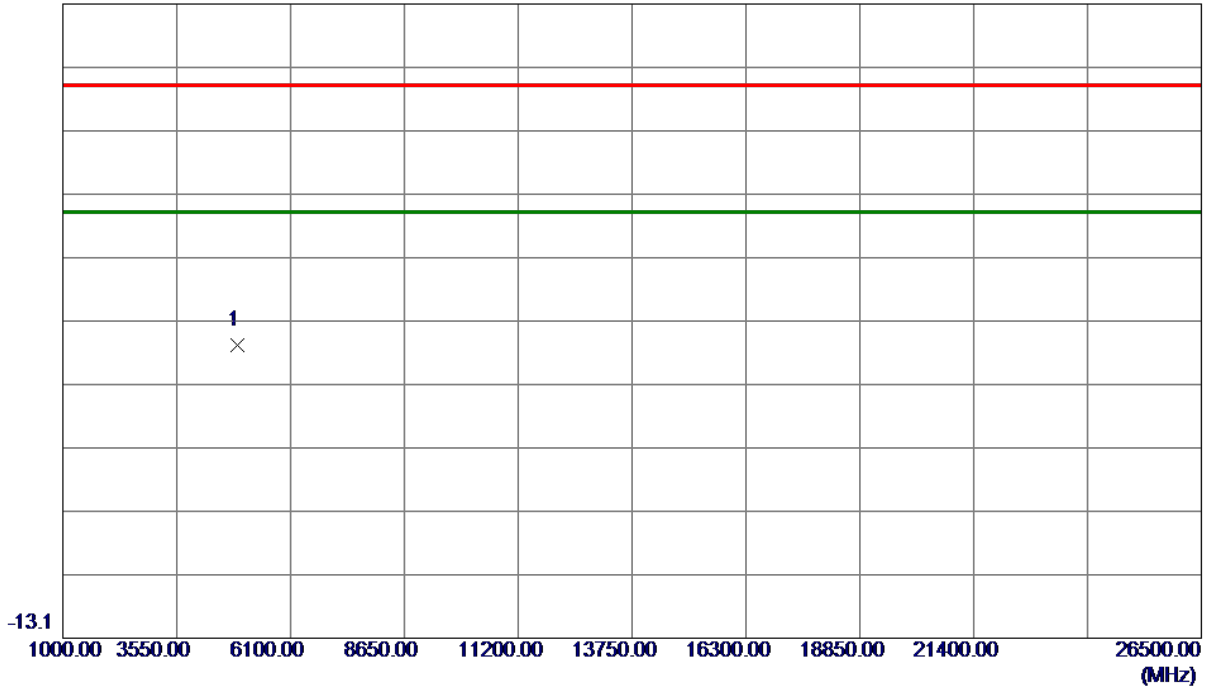

No.	Freq. MHz	Reading Level dBuV/m	Correct Factor dB	Measure ment dBuV/m	Limit dBuV/m	Margin dB	Detector	Comment
1 *	4924.0000	27.55	5.59	33.14	74.00	-40.86	Peak	

REMARKS:

- (1) Measurement Value = Reading Level + Correct Factor.
- (2) Margin Level = Measurement Value - Limit Value.

Test Mode	TX N(HT40) Mode 2422 MHz	Polarization	Vertical
-----------	--------------------------	--------------	----------

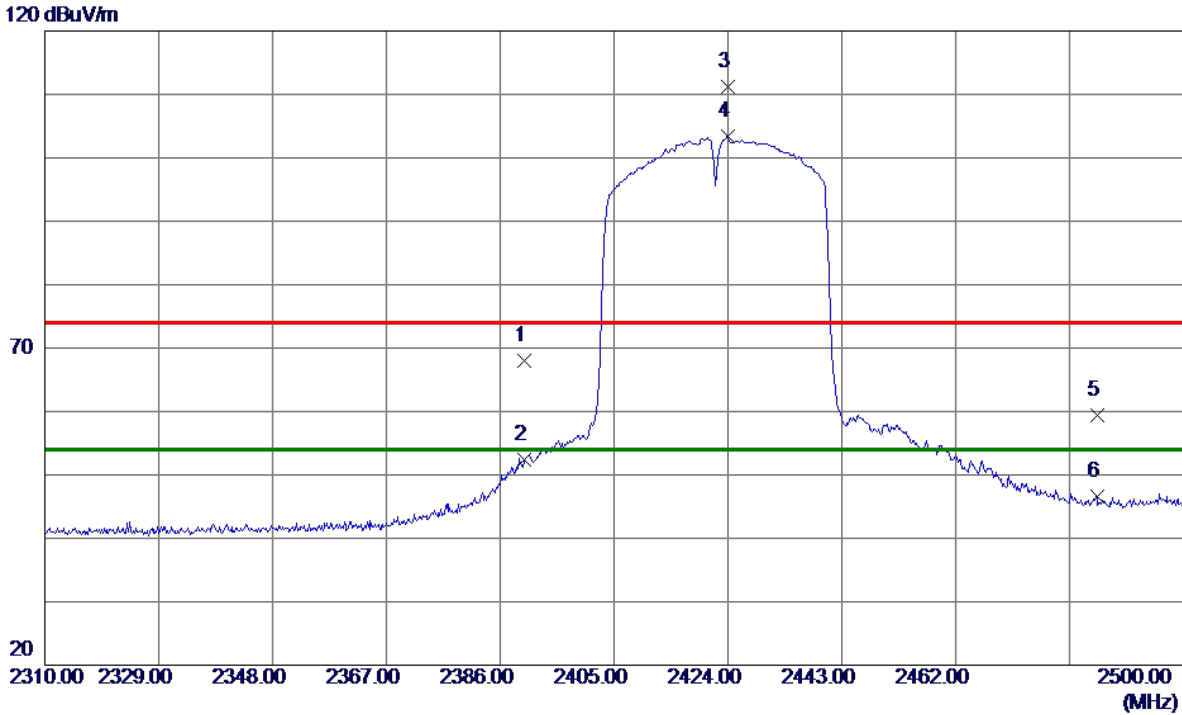

No.	Freq. MHz	Reading Level dBuV/m	Correct Factor dB	Measure ment dBuV/m	Limit dBuV/m	Margin dB	Detector	Comment
1	2390.0000	59.69	8.29	67.98	74.00	-6.02	Peak	
2	2390.0000	44.12	8.29	52.41	54.00	-1.59	AVG	
3	2423.9050	102.83	8.32	111.15	74.00	37.15	Peak	No limit
4 *	2423.9050	94.99	8.32	103.31	54.00	49.31	AVG	No limit
5	2485.5600	51.04	8.39	59.43	74.00	-14.57	Peak	
6	2485.5600	38.23	8.39	46.62	54.00	-7.38	AVG	

REMARKS:

- (1) Measurement Value = Reading Level + Correct Factor.
- (2) Margin Level = Measurement Value - Limit Value.

Test Mode	TX N(HT40) Mode 2422 MHz	Polarization	Vertical
-----------	--------------------------	--------------	----------

86.9 dBuV/m

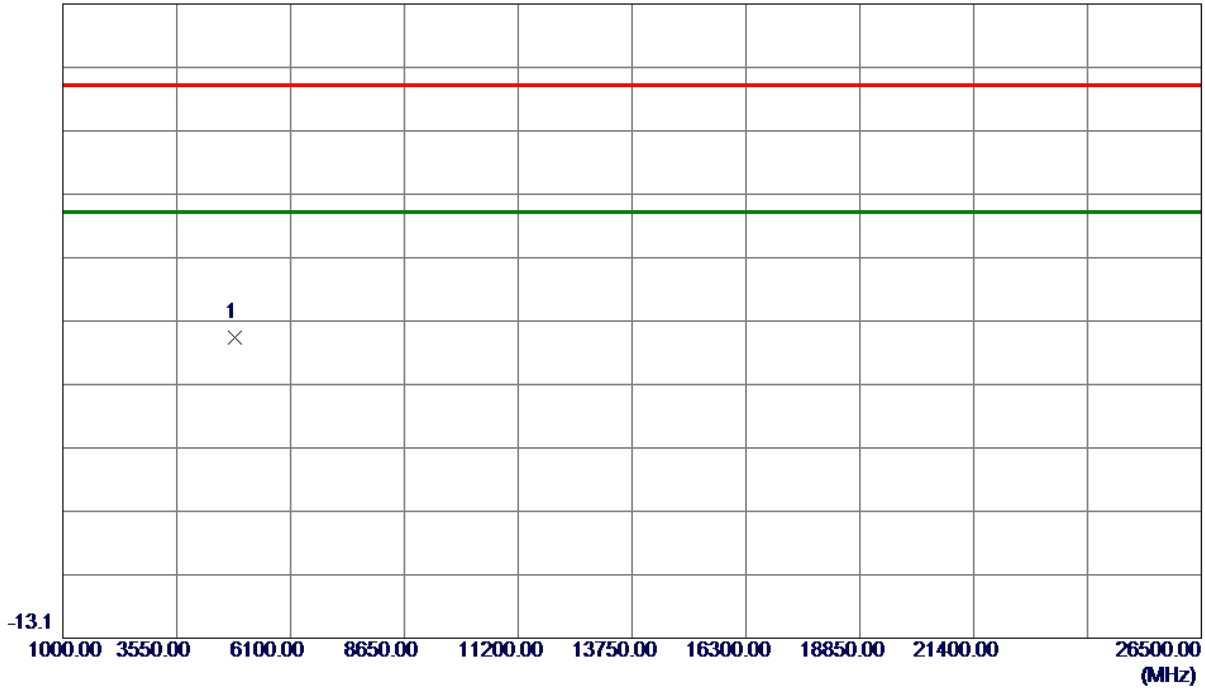

No.	Freq. MHz	Reading Level dBuV/m	Correct Factor dB	Measure ment dBuV/m	Limit dBuV/m	Margin dB	Detector	Comment
1 *	4841.5750	29.01	5.37	34.38	74.00	-39.62	Peak	

REMARKS:

- (1) Measurement Value = Reading Level + Correct Factor.
- (2) Margin Level = Measurement Value - Limit Value.

Test Mode	TX N(HT40) Mode 2422 MHz	Polarization	Horizontal
-----------	--------------------------	--------------	------------

120 dBuV/m

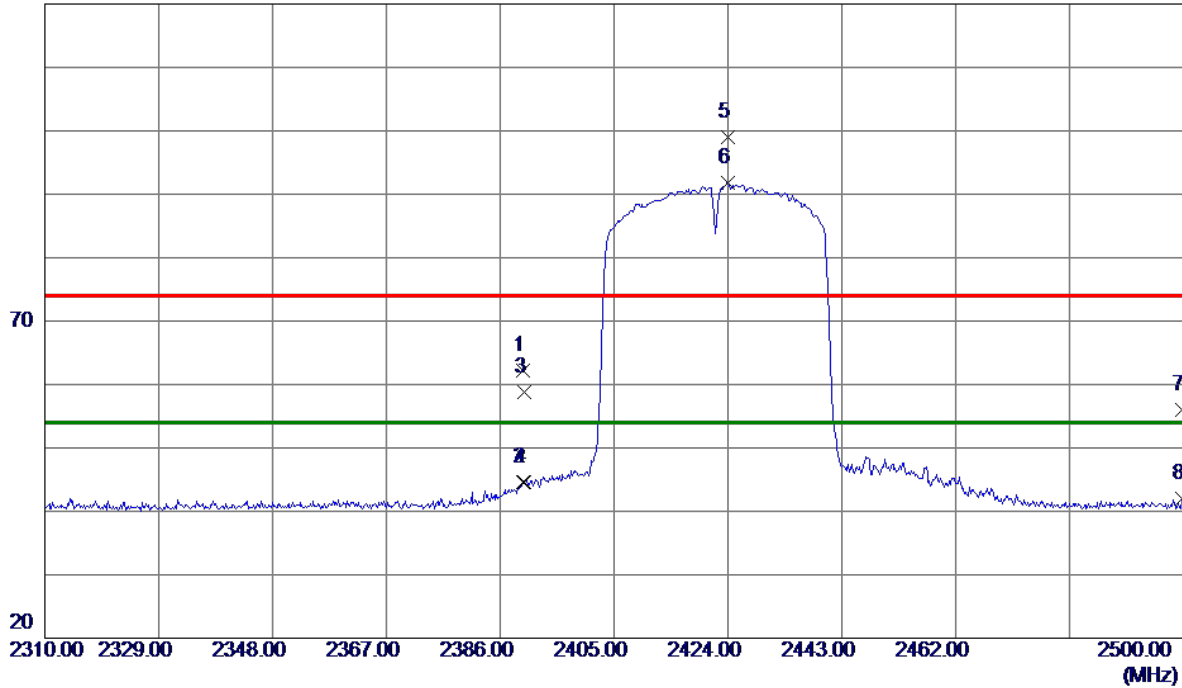

No.	Freq. MHz	Reading Level dBuV/m	Correct Factor dB	Measure ment dBuV/m	Limit dBuV/m	Margin dB	Detector	Comment
1	2389.8000	53.87	8.29	62.16	74.00	-11.84	Peak	
2	2389.8000	36.38	8.29	44.67	54.00	-9.33	AVG	
3	2390.0000	50.43	8.29	58.72	74.00	-15.28	Peak	
4	2390.0000	36.34	8.29	44.63	54.00	-9.37	AVG	
5	2423.9050	90.73	8.32	99.05	74.00	25.05	Peak	No limit
6 *	2423.9050	83.44	8.32	91.76	54.00	37.76	AVG	No limit
7	2499.8100	47.56	8.40	55.96	74.00	-18.04	Peak	
8	2499.8100	33.60	8.40	42.00	54.00	-12.00	AVG	

REMARKS:

- (1) Measurement Value = Reading Level + Correct Factor.
- (2) Margin Level = Measurement Value - Limit Value.

Test Mode	TX N(HT40) Mode 2422 MHz	Polarization	Horizontal
-----------	--------------------------	--------------	------------

86.9 dBuV/m

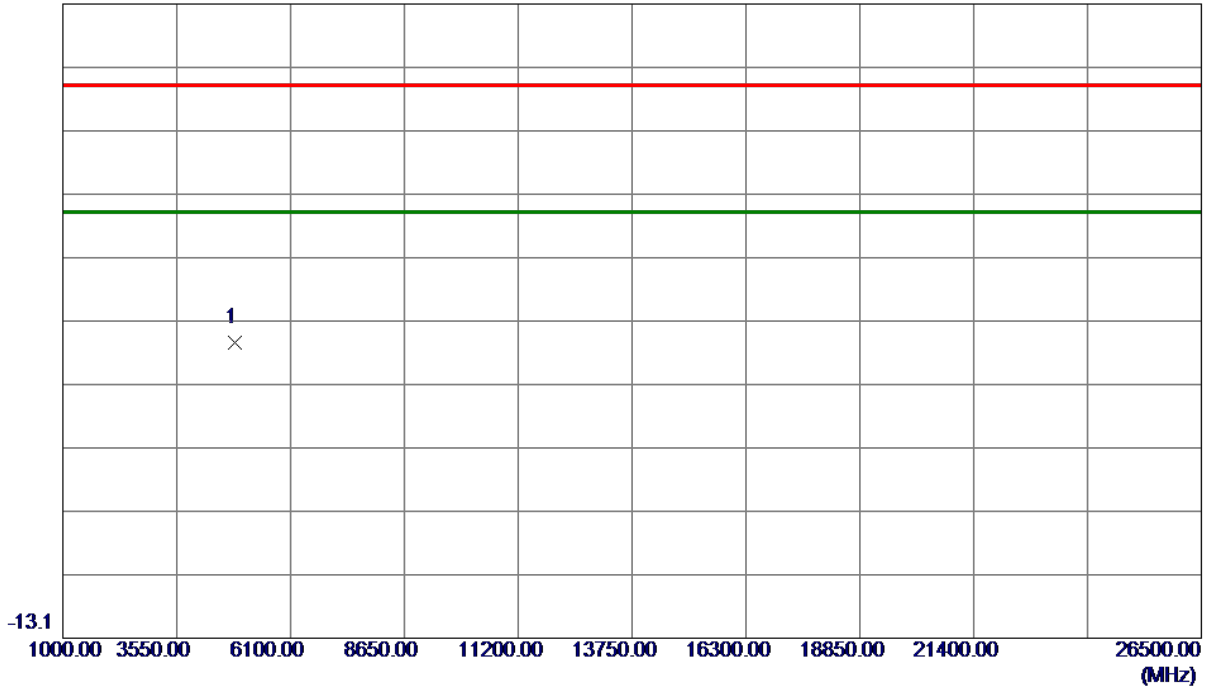

No.	Freq. MHz	Reading Level dBuV/m	Correct Factor dB	Measure ment dBuV/m	Limit dBuV/m	Margin dB	Detector	Comment
1 *	4844.0000	28.15	5.38	33.53	74.00	-40.47	Peak	

REMARKS:

- (1) Measurement Value = Reading Level + Correct Factor.
- (2) Margin Level = Measurement Value - Limit Value.

Test Mode	TX N(HT40) Mode 2437 MHz	Polarization	Vertical
-----------	--------------------------	--------------	----------

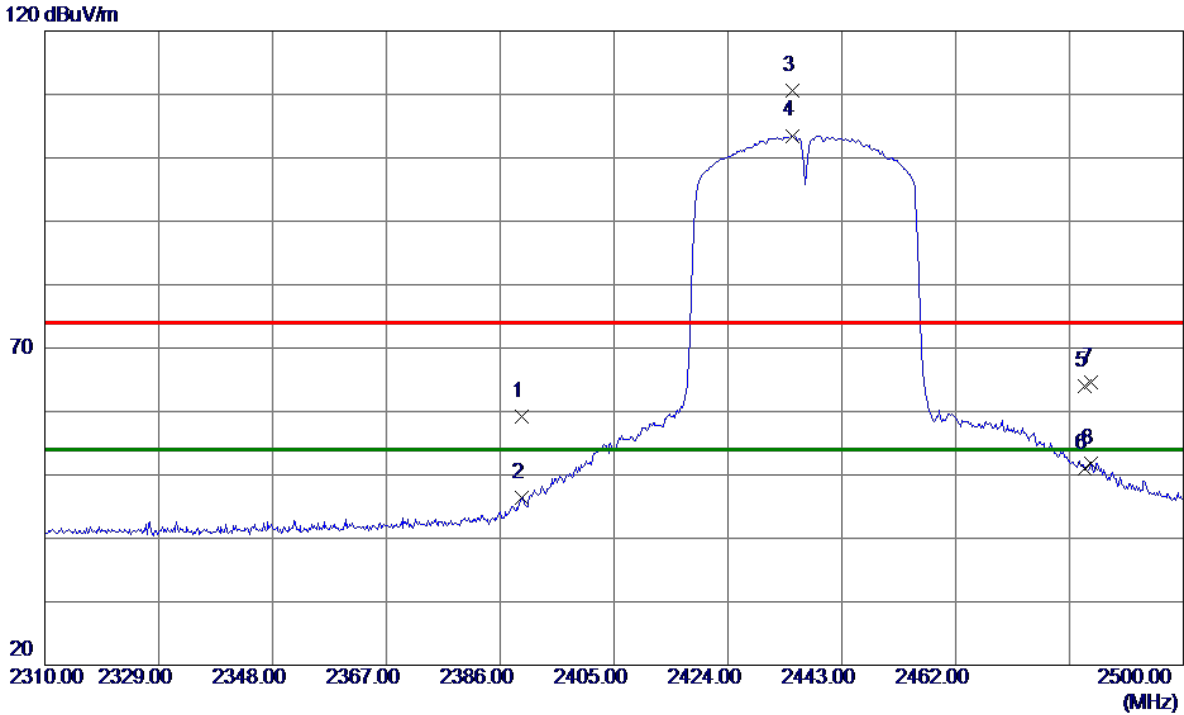

No.	Freq. MHz	Reading Level dBuV/m	Correct Factor dB	Measure ment dBuV/m	Limit dBuV/m	Margin dB	Detector	Comment
1	2389.6100	50.89	8.29	59.18	74.00	-14.82	Peak	
2	2389.6100	38.12	8.29	46.41	54.00	-7.59	AVG	
3	2434.8300	102.28	8.34	110.62	74.00	36.62	Peak	No limit
4 *	2434.8300	95.16	8.34	103.50	54.00	49.50	AVG	No limit
5	2483.5000	55.69	8.39	64.08	74.00	-9.92	Peak	
6	2483.5000	42.58	8.39	50.97	54.00	-3.03	AVG	
7	2484.6100	56.16	8.39	64.55	74.00	-9.45	Peak	
8	2484.6100	43.44	8.39	51.83	54.00	-2.17	AVG	

REMARKS:

- (1) Measurement Value = Reading Level + Correct Factor.
- (2) Margin Level = Measurement Value - Limit Value.

Test Mode	TX N(HT40) Mode 2437 MHz	Polarization	Vertical
-----------	--------------------------	--------------	----------

86.9 dBuV/m

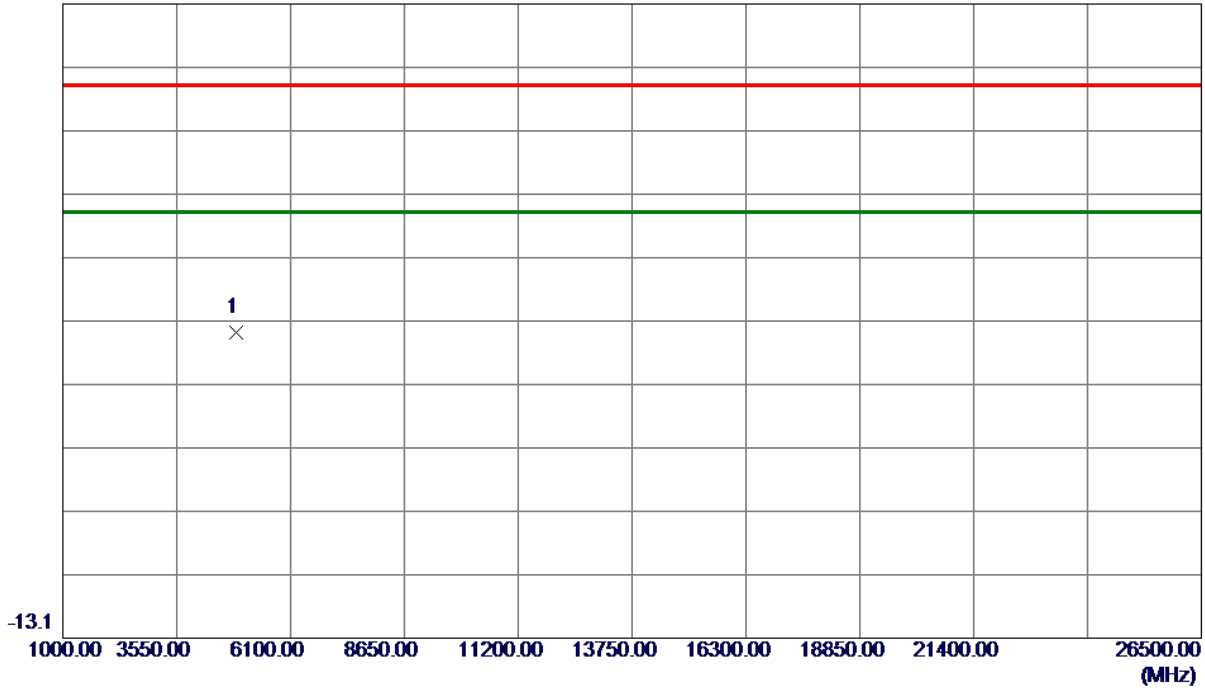

No.	Freq. MHz	Reading Level dBuV/m	Correct Factor dB	Measure ment dBuV/m	Limit dBuV/m	Margin dB	Detector	Comment
1 *	4873.4500	29.57	5.46	35.03	74.00	-38.97	Peak	

REMARKS:

- (1) Measurement Value = Reading Level + Correct Factor.
- (2) Margin Level = Measurement Value - Limit Value.

Test Mode	TX N(HT40) Mode 2437 MHz	Polarization	Horizontal
-----------	--------------------------	--------------	------------

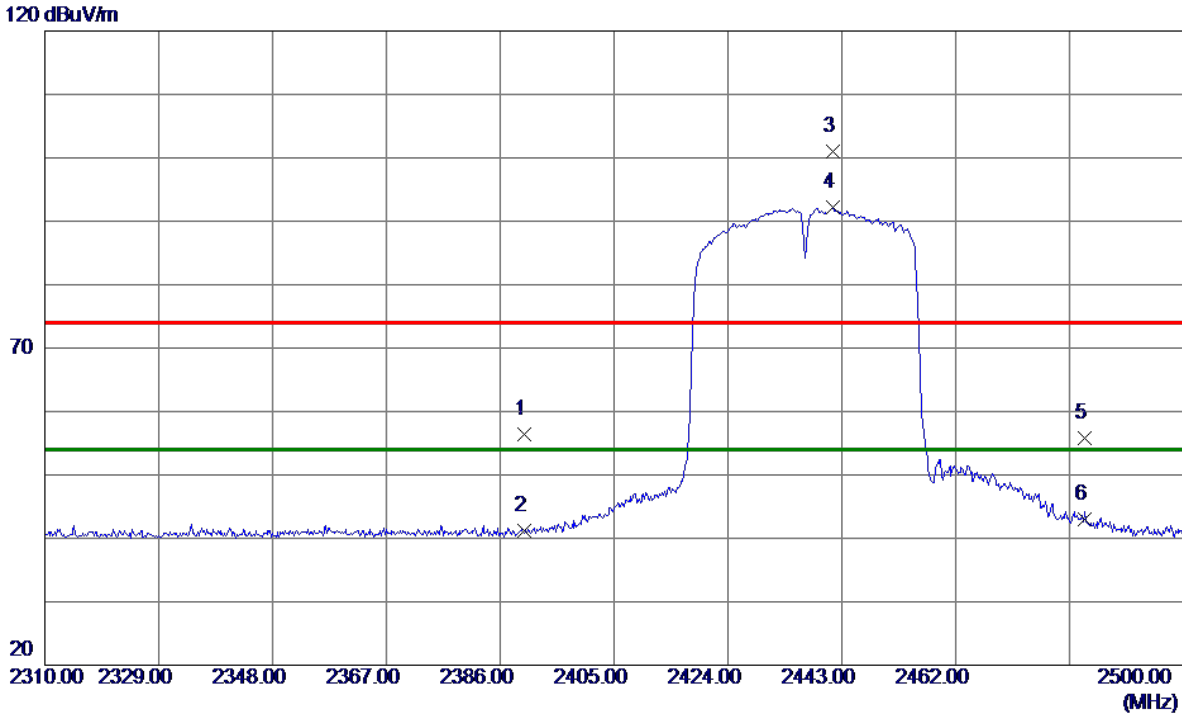

No.	Freq. MHz	Reading Level dBuV/m	Correct Factor dB	Measure ment dBuV/m	Limit dBuV/m	Margin dB	Detector	Comment
1	2390.0000	48.04	8.29	56.33	74.00	-17.67	Peak	
2	2390.0000	32.93	8.29	41.22	54.00	-12.78	AVG	
3	2441.5750	92.67	8.34	101.01	74.00	27.01	Peak	No limit
4 *	2441.5750	83.86	8.34	92.20	54.00	38.20	AVG	No limit
5	2483.5000	47.50	8.39	55.89	74.00	-18.11	Peak	
6	2483.5000	34.66	8.39	43.05	54.00	-10.95	AVG	

REMARKS:

- (1) Measurement Value = Reading Level + Correct Factor.
- (2) Margin Level = Measurement Value - Limit Value.

Test Mode	TX N(HT40) Mode 2437 MHz	Polarization	Horizontal
-----------	--------------------------	--------------	------------

86.9 dBuV/m

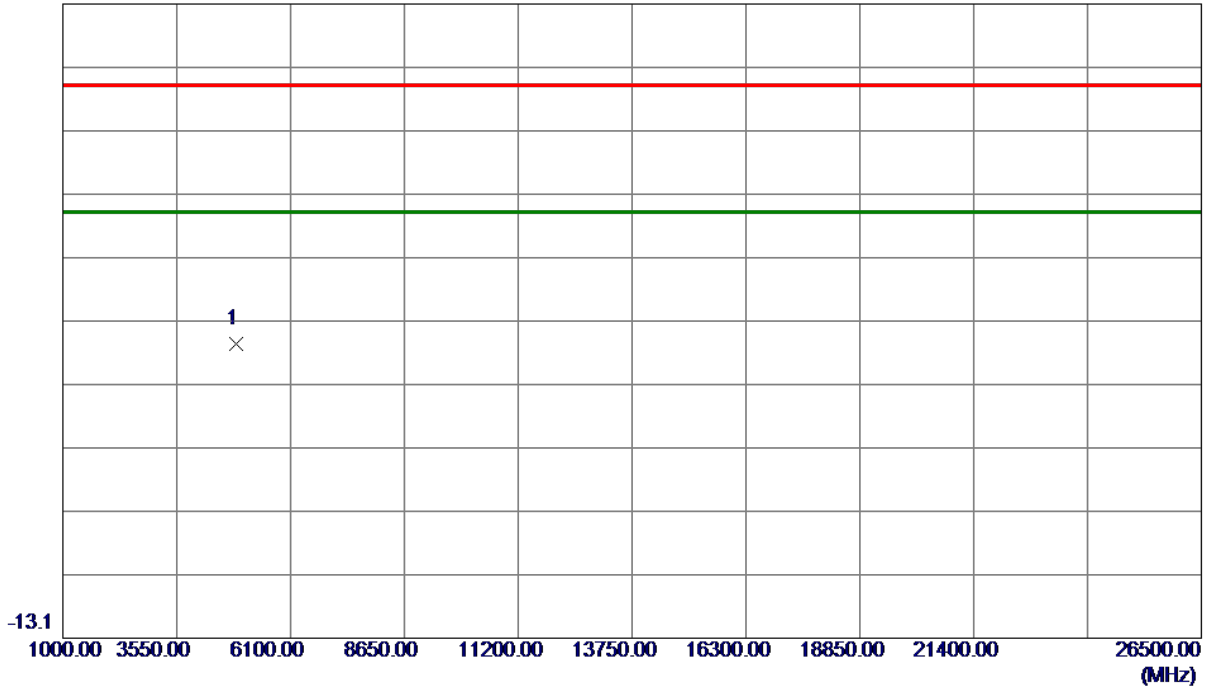

No.	Freq. MHz	Reading Level dBuV/m	Correct Factor dB	Measure ment dBuV/m	Limit dBuV/m	Margin dB	Detector	Comment
1 *	4874.0000	27.87	5.46	33.33	74.00	-40.67	Peak	

REMARKS:

- (1) Measurement Value = Reading Level + Correct Factor.
- (2) Margin Level = Measurement Value - Limit Value.

Test Mode	TX N(HT40) Mode 2452 MHz	Polarization	Vertical
-----------	--------------------------	--------------	----------

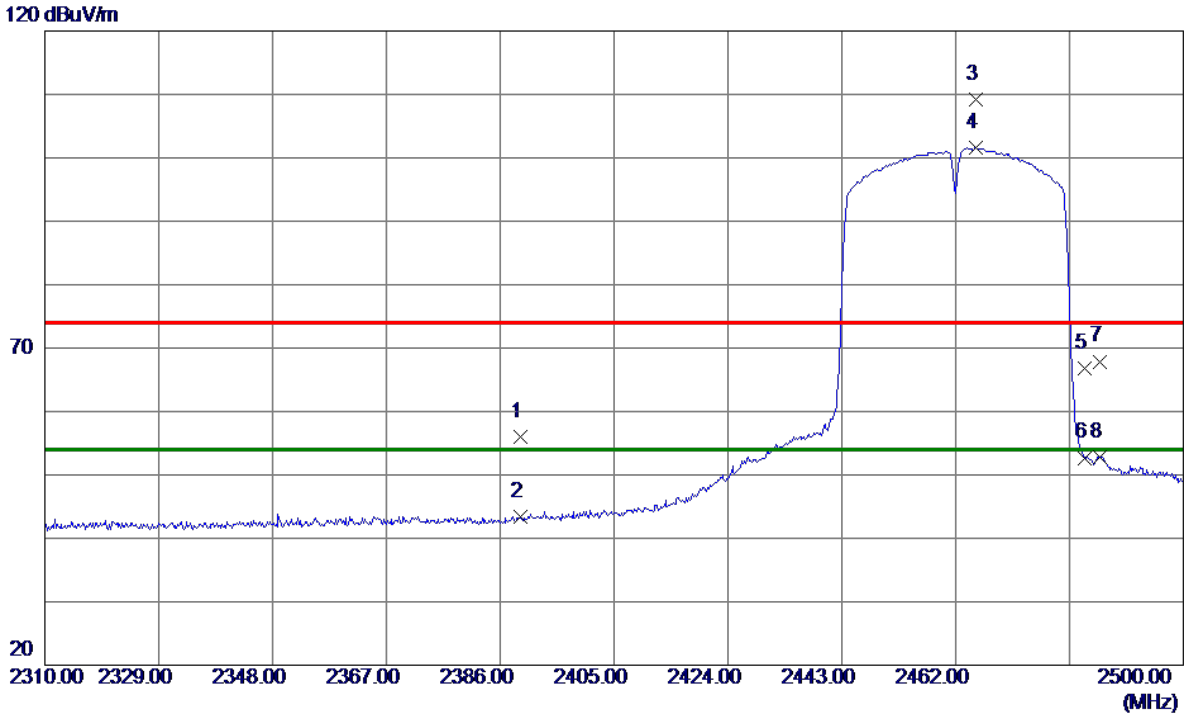

No.	Freq. MHz	Reading Level dBuV/m	Correct Factor dB	Measure ment dBuV/m	Limit dBuV/m	Margin dB	Detector	Comment
1	2389.4200	47.68	8.29	55.97	74.00	-18.03	Peak	
2	2389.4200	35.16	8.29	43.45	54.00	-10.55	AVG	
3	2465.3250	100.76	8.37	109.13	74.00	35.13	Peak	No limit
4 *	2465.3250	93.20	8.37	101.57	54.00	47.57	AVG	No limit
5	2483.5000	58.47	8.39	66.86	74.00	-7.14	Peak	
6	2483.5000	44.31	8.39	52.70	54.00	-1.30	AVG	
7	2486.0350	59.51	8.39	67.90	74.00	-6.10	Peak	
8	2486.0350	44.50	8.39	52.89	54.00	-1.11	AVG	

REMARKS:

- (1) Measurement Value = Reading Level + Correct Factor.
- (2) Margin Level = Measurement Value - Limit Value.

Test Mode	TX N(HT40) Mode 2452 MHz	Polarization	Vertical
-----------	--------------------------	--------------	----------

86.9 dBuV/m

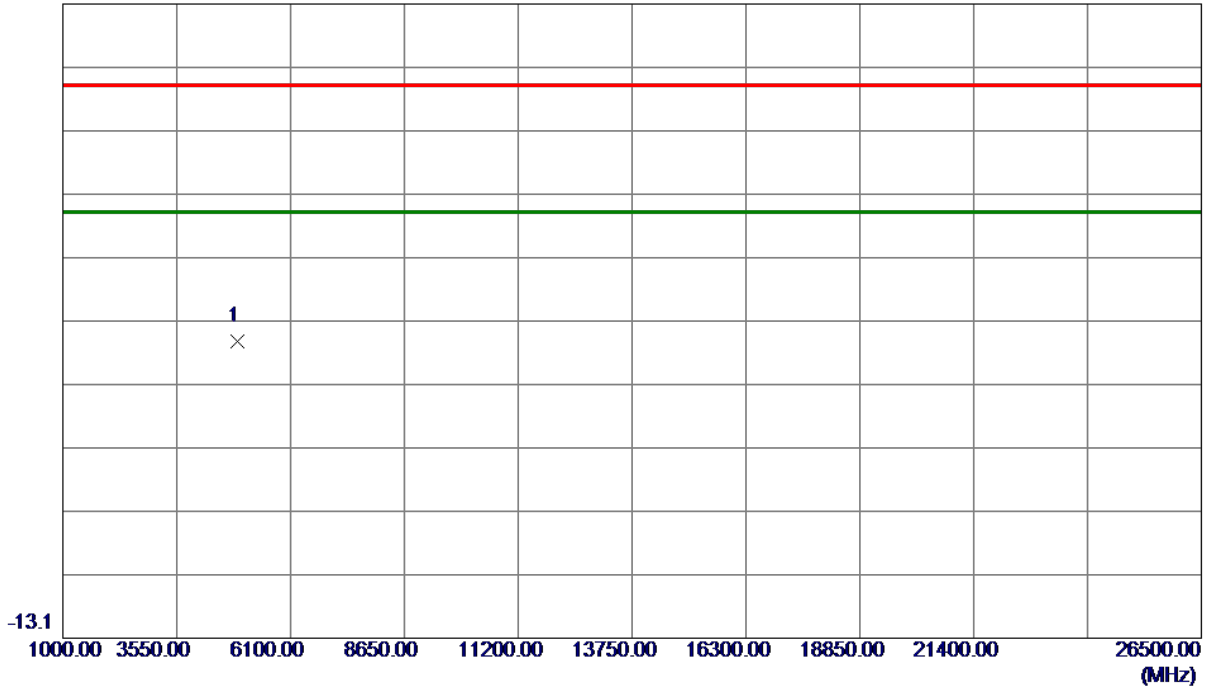

No.	Freq. MHz	Reading Level dBuV/m	Correct Factor dB	Measure ment dBuV/m	Limit dBuV/m	Margin dB	Detector	Comment
1 *	4904.0000	28.11	5.54	33.65	74.00	-40.35	Peak	

REMARKS:

- (1) Measurement Value = Reading Level + Correct Factor.
- (2) Margin Level = Measurement Value - Limit Value.

Test Mode	TX N(HT40) Mode 2452 MHz	Polarization	Horizontal
-----------	--------------------------	--------------	------------

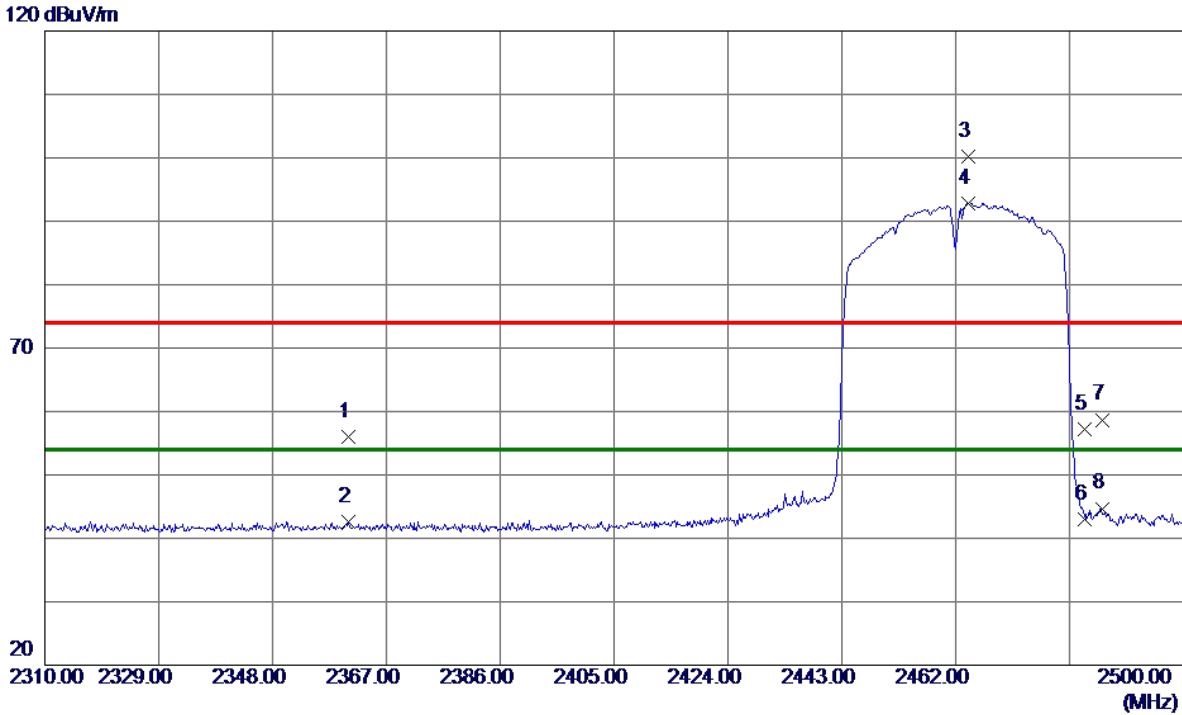

No.	Freq. MHz	Reading Level dBuV/m	Correct Factor dB	Measure ment dBuV/m	Limit dBuV/m	Margin dB	Detector	Comment
1	2360.7300	47.76	8.26	56.02	74.00	-17.98	Peak	
2	2360.7300	34.40	8.26	42.66	54.00	-11.34	AVG	
3	2464.0900	91.85	8.37	100.22	74.00	26.22	Peak	No limit
4 *	2464.0900	84.43	8.37	92.80	54.00	38.80	AVG	No limit
5	2483.5000	48.80	8.39	57.19	74.00	-16.81	Peak	
6	2483.5000	34.66	8.39	43.05	54.00	-10.95	AVG	
7	2486.4150	50.31	8.39	58.70	74.00	-15.30	Peak	
8	2486.4150	36.31	8.39	44.70	54.00	-9.30	AVG	

REMARKS:

- (1) Measurement Value = Reading Level + Correct Factor.
- (2) Margin Level = Measurement Value - Limit Value.

Test Mode	TX N(HT40) Mode 2452 MHz	Polarization	Horizontal
-----------	--------------------------	--------------	------------

86.9 dBuV/m

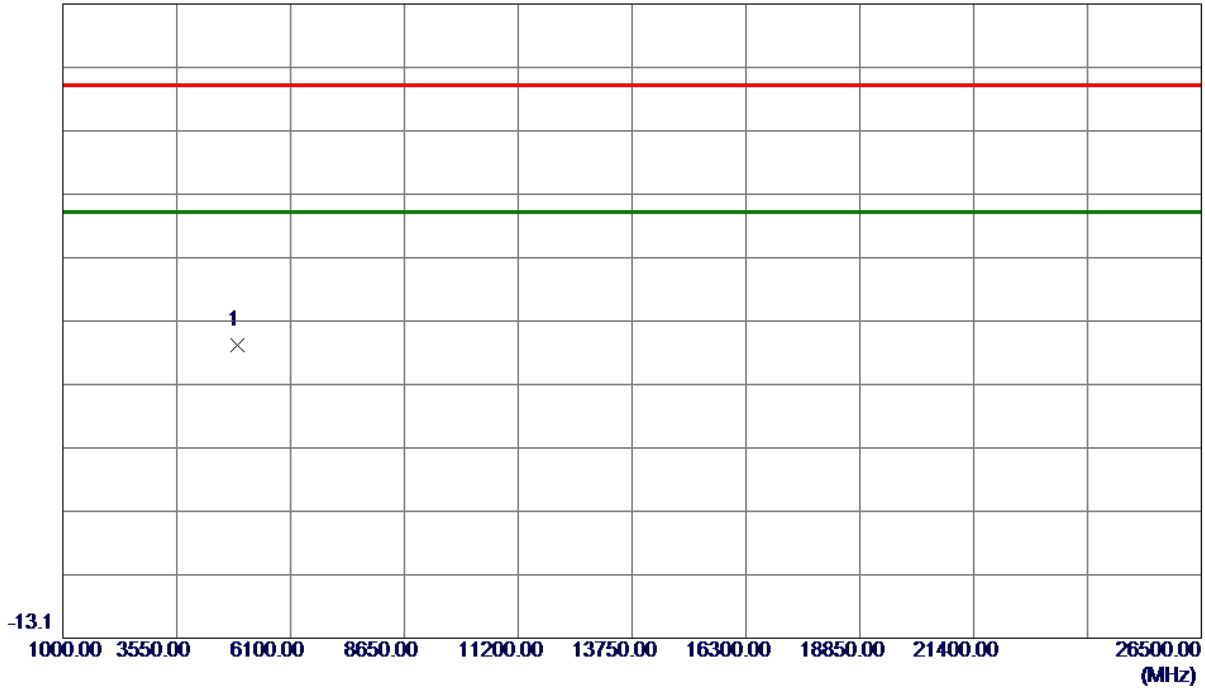

No.	Freq. MHz	Reading Level dBuV/m	Correct Factor dB	Measure ment dBuV/m	Limit dBuV/m	Margin dB	Detector	Comment
1 *	4904.0000	27.57	5.54	33.11	74.00	-40.89	Peak	

REMARKS:

- (1) Measurement Value = Reading Level + Correct Factor.
- (2) Margin Level = Measurement Value - Limit Value.

The worst case of simultaneous transmission:

Test Mode	TX WLAN 2.4G B Mode 2437MHz + WLAN 5G A Mode 5745MHz	Polarization	Vertical
-----------	---	--------------	----------

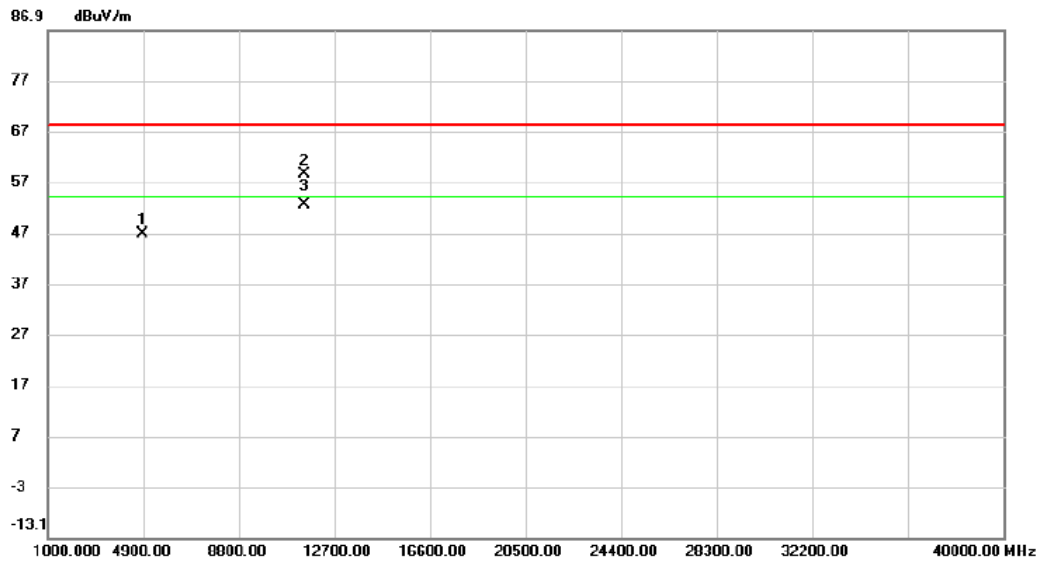

No. Mk.	Freq. MHz	Reading Level dBuV	Correct Factor dB	Measurement dBuV/m	Limit dBuV/m	Margin dB	Detector	Comment
1	4874.625	41.24	5.46	46.70	68.30	-21.60	peak	
2	11489.010	43.95	14.54	58.49	68.30	-9.81	peak	
3 *	11489.925	37.95	14.54	52.49	54.00	-1.51	AVG	

REMARKS:

- (1) Measurement Value = Reading Level + Correct Factor.
- (2) Margin Level = Measurement Value - Limit Value.

Test Mode	TX WLAN 2.4G B Mode 2437MHz + WLAN 5G A Mode 5745MHz	Polarization	Horizontal
-----------	---	--------------	------------

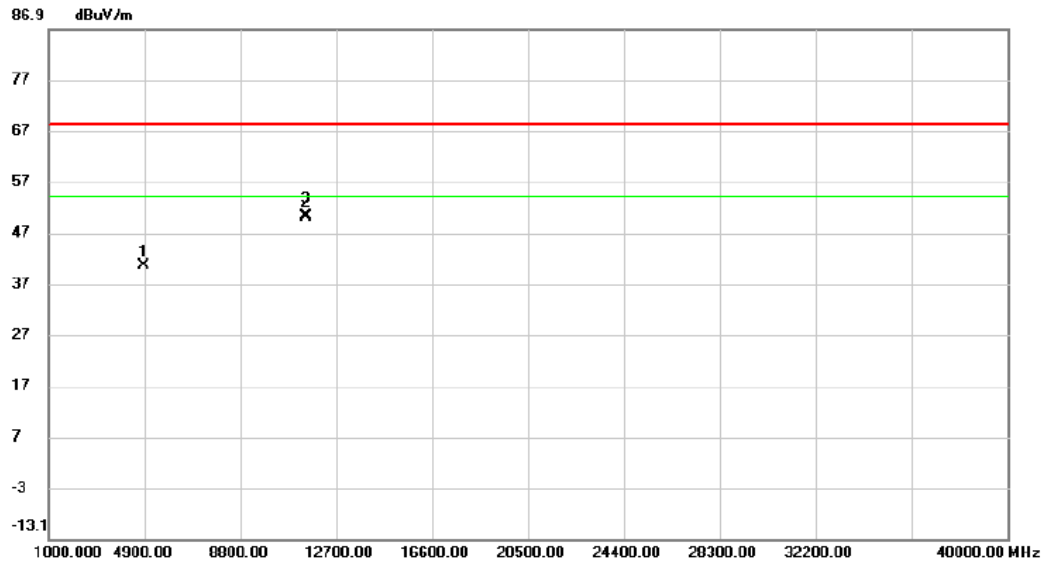

No.	Mk.	Freq. MHz	Reading Level dBuV	Correct Factor dB	Measure- ment dBuV/m	Limit dBuV/m	Margin dB	Detector	Comment
1		4873.441	35.01	5.46	40.47	68.30	-27.83	peak	
2		11480.100	35.82	14.54	50.36	68.30	-17.94	peak	
3	*	11489.926	35.58	14.54	50.12	54.00	-3.88	AVG	

REMARKS:

- (1) Measurement Value = Reading Level + Correct Factor.
- (2) Margin Level = Measurement Value - Limit Value.

APPENDIX E - BANDWIDTH

Test Mode	TX B Mode
-----------	-----------

Channel	Frequency (MHz)	6 dB Bandwidth (MHz)	99 % Occupied Bandwidth (MHz)	6 dB Bandwidth Min. Limit (MHz)	Result
01	2412	10.140	14.080	0.5	Complies
06	2437	10.100	14.080	0.5	Complies
11	2462	10.140	14.160	0.5	Complies

CH01

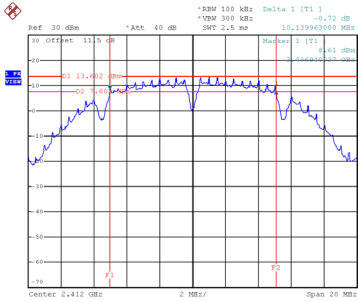

Date: 20_MAY.2021 14:36:43

CH06

6 dB Bandwidth

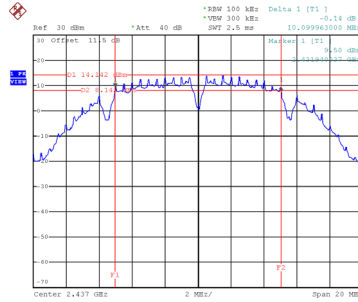

Date: 20_MAY.2021 14:38:10

CH11

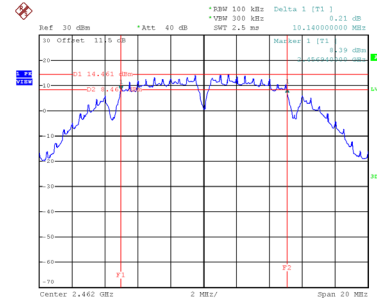

Date: 20_MAY.2021 14:39:52

99 % Occupied Bandwidth

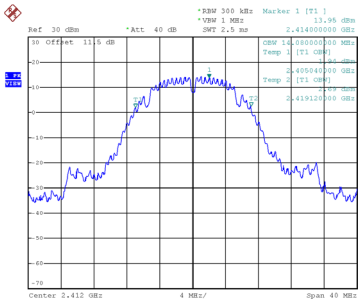

Date: 20_MAY.2021 14:36:50

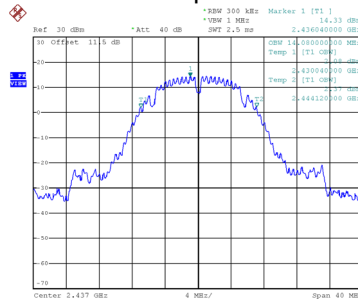

Date: 20_MAY.2021 14:38:16

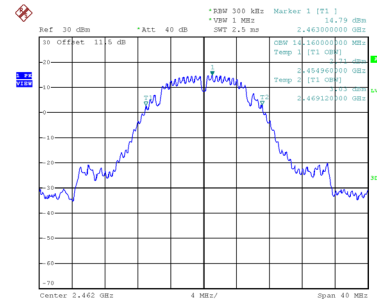

Date: 20_MAY.2021 14:39:59

Test Mode	TX G Mode
-----------	-----------

Channel	Frequency (MHz)	6 dB Bandwidth (MHz)	99 % Occupied Bandwidth (MHz)	6 dB Bandwidth Min. Limit (MHz)	Result
01	2412	16.310	17.280	0.5	Complies
06	2437	16.380	17.280	0.5	Complies
11	2462	16.380	17.120	0.5	Complies

CH01

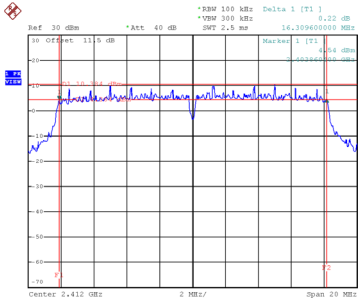

Date: 20_MAY,2021 14:41:36

CH06

6 dB Bandwidth

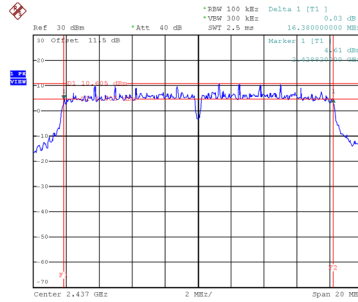

Date: 20_MAY,2021 14:42:55

CH11

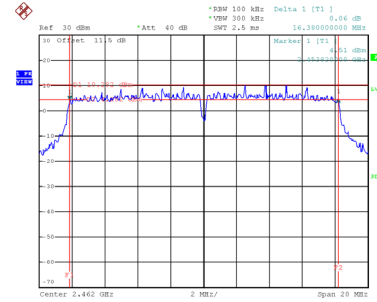

Date: 20_MAY,2021 14:44:24

99 % Occupied Bandwidth

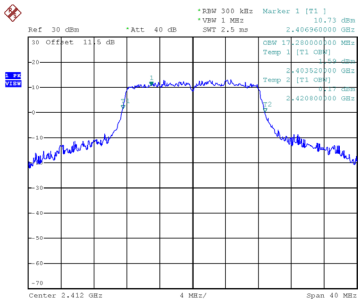

Date: 20_MAY,2021 14:41:42

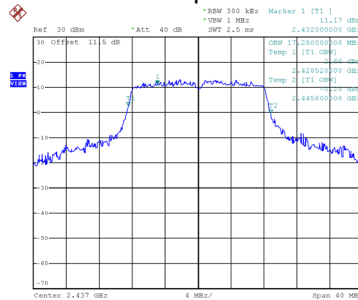

Date: 20_MAY,2021 14:43:01

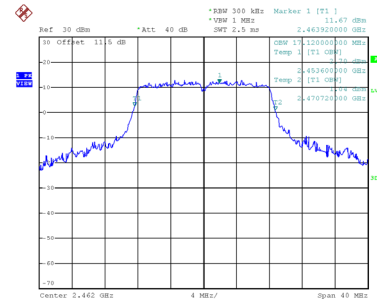

Date: 20_MAY,2021 14:44:31

Test Mode	TX N(HT20) Mode
-----------	-----------------

Channel	Frequency (MHz)	6 dB Bandwidth (MHz)	99 % Occupied Bandwidth (MHz)	6 dB Bandwidth Min. Limit (MHz)	Result
01	2412	17.340	18.160	0.5	Complies
06	2437	17.220	18.240	0.5	Complies
11	2462	16.719	18.160	0.5	Complies

CH01

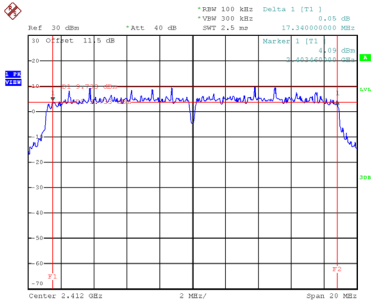

Date: 20_MAY.2021 14:46:09

CH06

6 dB Bandwidth

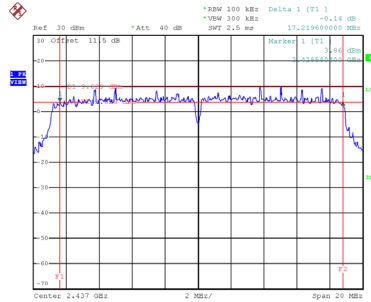

Date: 20_MAY.2021 14:47:30

CH11

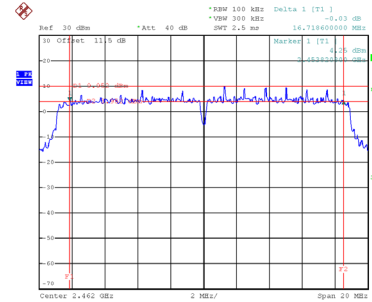

Date: 20_MAY.2021 14:48:59

99 % Occupied Bandwidth

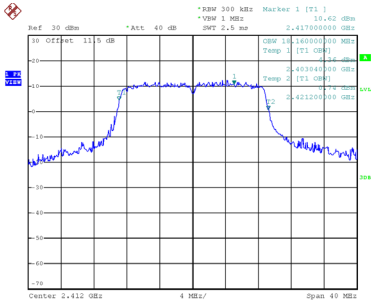

Date: 20_MAY.2021 14:46:15

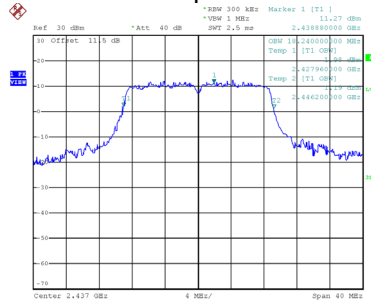

Date: 20_MAY.2021 14:47:37

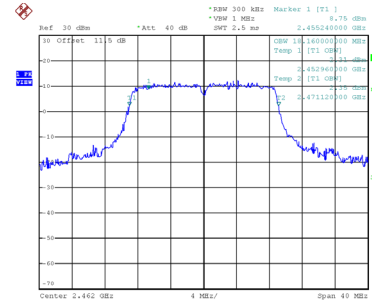

Date: 20_MAY.2021 14:49:05