

# FCC Radio Test Report

## FCC ID: V7TI21

This report concerns (check one): Original Grant Class I Change Class II Change

**Project No.** : 1709C145  
**Equipment** : Wireless Dual Band Ceiling Access Point  
**Test Model** : i21  
**Series Model** : N/A  
**Applicant** : SHENZHEN TENDA TECHNOLOGY CO.,LTD  
**Address** : 6-8 Floor, Tower E3, No. 1001, Zhongshanyuan Road, Nanshan District, Shenzhen, China. 518052

**Date of Receipt** : Sep. 16, 2017  
**Date of Test** : Sep. 16, 2017 ~ Nov. 26, 2017  
**Issued Date** : Nov. 27, 2017  
**Tested by** : BTL Inc.

**Testing Engineer** : Jivey Jiang  
(Jivey Jiang)

**Technical Manager** : shawn xiao  
(Shawn Xiao)

**Authorized Signatory** : David Mao  
(David Mao)

# **B T L I N C .**

No.3, Jinshagang 1st Road, Shixia, Dalang Town, Dongguan, Guangdong, China.

TEL: +86-769-8318-3000 FAX: +86-769-8319-6000



### **Declaration**

**BTL** represents to the client that testing is done in accordance with standard procedures as applicable and that test instruments used has been calibrated with standards traceable to international standard(s) and/or national standard(s).

**BTL's** reports apply only to the specific samples tested under conditions. It is manufacture's responsibility to ensure that additional production units of this model are manufactured with the identical electrical and mechanical components. **BTL** shall have no liability for any declarations, inferences or generalizations drawn by the client or others from **BTL** issued reports.

**BTL's** report must not be used by the client to claim product certification, approval, or endorsement by NVLAP, NIST, or any agency of the Federal Government.

This report is the confidential property of the client. As a mutual protection to the clients, the public and **BTL-self**, extracts from the test report shall not be reproduced except in full with **BTL's** authorized written approval.

**BTL's** laboratory quality assurance procedures are in compliance with the **ISO Guide 17025** requirements, and accredited by the conformity assessment authorities listed in this test report.

### **Limitation**

For the use of the authority's logo is limited unless the Test Standard(s)/Scope(s)/Item(s) mentioned in this test report is (are) included in the conformity assessment authorities acceptance respective.

Table of Contents	Page
<b>1 . CERTIFICATION</b>	<b>6</b>
<b>2 . SUMMARY OF TEST RESULTS</b>	<b>7</b>
2.1 TEST FACILITY	8
2.2 MEASUREMENT UNCERTAINTY	8
<b>3 . GENERAL INFORMATION</b>	<b>9</b>
3.1 GENERAL DESCRIPTION OF EUT	9
3.2 DESCRIPTION OF TEST MODES	11
3.3 TABLE OF PARAMETERS OF TEXT SOFTWARE SETTING	13
3.4 BLOCK DIAGRAM SHOWING THE CONFIGURATION OF SYSTEM TESTED	14
3.5 DESCRIPTION OF SUPPORT UNITS	14
<b>4 . EMC EMISSION TEST</b>	<b>15</b>
4.1 CONDUCTED EMISSION MEASUREMENT	15
4.1.1 POWER LINE CONDUCTED EMISSION LIMITS	15
4.1.2 TEST PROCEDURE	15
4.1.3 DEVIATION FROM TEST STANDARD	15
4.1.4 TEST SETUP	16
4.1.5 EUT OPERATING CONDITIONS	16
4.1.6 EUT TEST CONDITIONS	16
4.1.7 TEST RESULTS	16
4.2 RADIATED EMISSION MEASUREMENT	17
4.2.1 RADIATED EMISSION LIMITS	17
4.2.2 TEST PROCEDURE	18
4.2.3 DEVIATION FROM TEST STANDARD	18
4.2.4 TEST SETUP	19
4.2.5 EUT OPERATING CONDITIONS	20
4.2.6 EUT TEST CONDITIONS	20
4.2.7 TEST RESULTS (9KHZ TO 30MHZ)	20
4.2.8 TEST RESULTS (30MHZ TO 1000MHZ)	20
4.2.9 TEST RESULTS (ABOVE 1000MHZ)	20
<b>5 . BANDWIDTH TEST</b>	<b>21</b>
5.1 APPLIED PROCEDURES	21
5.1.1 TEST PROCEDURE	21
5.1.2 DEVIATION FROM STANDARD	21
5.1.3 TEST SETUP	21
5.1.4 EUT OPERATION CONDITIONS	21
5.1.5 EUT TEST CONDITIONS	21
5.1.6 TEST RESULTS	21
<b>6 . MAXIMUM PEAK CONDUCTED OUTPUT POWER TEST</b>	<b>22</b>

<b>Table of Contents</b>	<b>Page</b>
<b>6.1 APPLIED PROCEDURES / LIMIT</b>	<b>22</b>
6.1.1 TEST PROCEDURE	22
6.1.2 DEVIATION FROM STANDARD	22
6.1.3 TEST SETUP	22
6.1.4 EUT OPERATION CONDITIONS	22
6.1.5 EUT TEST CONDITIONS	22
6.1.6 TEST RESULTS	22
<b>7 . ANTENNA CONDUCTED SPURIOUS EMISSION</b>	<b>23</b>
7.1 APPLIED PROCEDURES / LIMIT	23
7.1.1 TEST PROCEDURE	23
7.1.2 DEVIATION FROM STANDARD	23
7.1.3 TEST SETUP	23
7.1.4 EUT OPERATION CONDITIONS	23
7.1.5 EUT TEST CONDITIONS	23
7.1.6 TEST RESULTS	23
<b>8 . POWER SPECTRAL DENSITY TEST</b>	<b>24</b>
8.1 APPLIED PROCEDURES / LIMIT	24
8.1.1 TEST PROCEDURE	24
8.1.2 DEVIATION FROM STANDARD	24
8.1.3 TEST SETUP	24
8.1.4 EUT OPERATION CONDITIONS	24
8.1.5 EUT TEST CONDITIONS	24
8.1.6 TEST RESULTS	24
<b>9 . MEASUREMENT INSTRUMENTS LIST</b>	<b>25</b>
<b>10 . EUT TEST PHOTO</b>	<b>27</b>
<b>APPENDIX A - CONDUCTED EMISSION</b>	<b>31</b>
<b>APPENDIX B - RADIATED EMISSION (9KHZ TO 30MHZ)</b>	<b>34</b>
<b>APPENDIX C - RADIATED EMISSION (30MHZ TO 1000MHZ)</b>	<b>39</b>
<b>APPENDIX D - RADIATED EMISSION (ABOVE 1000MHZ)</b>	<b>46</b>
<b>APPENDIX E - BANDWIDTH</b>	<b>95</b>
<b>APPENDIX F - MAXIMUM PEAK CONDUCTED OUTPUT POWER</b>	<b>104</b>
<b>APPENDIX G - ANTENNA CONDUCTED SPURIOUS EMISSION</b>	<b>108</b>
<b>APPENDIX H - POWER SPECTRAL DENSITY</b>	<b>145</b>

### REPORT ISSUED HISTORY

Issued No.	Description	Issued Date
BTL-FCCP-1-1709C145	Original Issue.	Nov. 27, 2017

## 1. CERTIFICATION

Equipment : Wireless Dual Band Ceiling Access Point  
Brand Name : Tenda  
Test Model : i21  
Series Model : N/A  
Applicant : SHENZHEN TENDA TECHNOLOGY CO.,LTD  
Manufacturer : SHENZHEN TENDA TECHNOLOGY CO.,LTD  
Address : 6-8 Floor, Tower E3, No. 1001, Zhongshanyuan Road, Nanshan District,  
Shenzhen, China. 518052  
Date of Test : Sep. 16, 2017 ~ Nov. 26, 2017  
Test Sample : Engineering Sample  
Standard(s) : FCC Part15, Subpart C:(15.247) / ANSI C63.10-2013

The above equipment has been tested and found compliance with the requirement of the relative standards by BTL Inc.

The test data, data evaluation, and equipment configuration contained in our test report (Ref No. BTL-FCCP-1-1709C145) were obtained utilizing the test procedures, test instruments, test sites that has been accredited by the Authority of NVLAP according to the ISO-17025 quality assessment standard and technical standard(s).

## 2. SUMMARY OF TEST RESULTS

Test procedures according to the technical standard(s):

Applied Standard(s): FCC Part15 (15.247) , Subpart C			
Standard(s) Section	Test Item	Judgment	Remark
15.207	Conducted Emission	PASS	
15.247(d)	Antenna conducted Spurious Emission	PASS	
15.247(a)(2)	6dB Bandwidth	PASS	
15.247(b)(3)	Peak Output Power	PASS	
15.247(e)	Power Spectral Density	PASS	
15.203	Antenna Requirement	PASS	
15.247(d)/ 15.205/ 15.209	Transmitter Radiated Emissions	PASS	

**NOTE:**

(1) "N/A" denotes test is not applicable in this test report.

## 2.1 TEST FACILITY

The test facilities used to collect the test data in this report is at the location of No.3,Jinshagang 1st Road, Shixia, Dalang Town, Dongguan, Guangdong, China.

BTL's test firm number for FCC: 854385

BTL's designation number for FCC: CN5020

## 2.2 MEASUREMENT UNCERTAINTY

Where relevant, the following measurement uncertainty levels have been estimated for tests performed on the EUT as specified in CISPR 16-4-2. The BTL measurement uncertainty is less than the CISPR 16-4-2  $U_{\text{CISPR}}$  requirement.

The reported uncertainty of measurement  $y \pm U$ , where expanded uncertainty  $U$  is based on a standard uncertainty multiplied by a coverage factor of  $k=2$ , providing a level of confidence of approximately 95 %.

### A. Conducted Measurement:

Test Site	Method	Measurement Frequency Range	U, (dB)
DG-C02	CISPR	150 KHz ~ 30MHz	2.32

### B. Radiated Measurement:

Test Site	Method	Measurement Frequency Range	Ant. H / V	U, (dB)
DG-CB03	CISPR	9KHz~30MHz	V	3.79
		9KHz~30MHz	H	3.57
		30MHz ~ 200MHz	V	3.82
		30MHz ~ 200MHz	H	3.78
		200MHz ~ 1,000MHz	V	4.10
		200MHz ~ 1,000MHz	H	4.06
		1GHz~18GHz	V	3.12
		1GHz~18GHz	H	3.68
		18GHz~40GHz	V	4.15
18GHz~40GHz	H	4.14		

Note: Unless specifically mentioned, the uncertainty of measurement has not been taken into account to declare the compliance or non-compliance to the specification.



### 3. GENERAL INFORMATION

#### 3.1 GENERAL DESCRIPTION OF EUT

Equipment	Wireless Dual Band Ceiling Access Point	
Brand Name	Tenda	
Test Model	i21	
Series Model	N/A	
Model Difference	N/A	
Product Description	Operation Frequency	2412~2462 MHz
	Modulation Technology	802.11b:DSSS 802.11g:OFDM 802.11n:OFDM
	Bit Rate of Transmitter	802.11b: 11/5.5/2/1 Mbps 802.11g: 54/48/36/24/18/12/9/6 Mbps 802.11n up to 300 Mbps
	Output Power (Max.)	802.11b: 23.4dBm 802.11g: 23.57dBm 802.11n(20MHz): 25.98dBm 802.11n(40MHz): 25.78dBm
Power Source	1# DC Voltage supplied from AC/DC adapter (support unit). 2# Supplied from PoE.	
Power Rating	1# I/P: 12V --- 1A 2# PoE 51V	

Note:

1. For a more detailed features description, please refer to the manufacturer's specifications or the user's manual.

2. Channel List:

CH01 - CH11 for 802.11b, 802.11g, 802.11n(20MHz) CH03 - CH09 for 802.11n(40MHz)							
Channel	Frequency (MHz)	Channel	Frequency (MHz)	Channel	Frequency (MHz)	Channel	Frequency (MHz)
01	2412	04	2427	07	2442	10	2457
02	2417	05	2432	08	2447	11	2462
03	2422	06	2437	09	2452		

3. Table for Filed Antenna

Ant.	Brand	Model Name	Antenna Type	Connector	Gain (dBi)	Note
1	N/A	N/A	Integral	N/A	4.5	N/A
2	N/A	N/A	Integral	N/A	4.5	N/A

Note: The EUT incorporates a MIMO function. Physically, the EUT provides two completed transmitters and receivers (2T2R).

4. The worst case for 1TX/ 2TX as follow:

Operating Mode / TX Mode	1TX	2TX
802.11b	V (ANT 1)	-
802.11g	V (ANT 1)	-
802.11n(20MHz)	-	V (ANT 1+ANT 2)
802.11n(40MHz)	-	V (ANT 1+ANT 2)

### 3.2 DESCRIPTION OF TEST MODES

To investigate the maximum EMI emission characteristics generated from EUT, the test system was pre-scanning tested based on the consideration of following EUT operation mode or test configuration mode which possibly have effect on EMI emission level. Each of these EUT operation mode(s) or test configuration mode(s) mentioned above was evaluated respectively.

Pretest Mode	Description
Mode 1	TX B MODE CHANNEL 01/06/11
Mode 2	TX G MODE CHANNEL 01/06/11
Mode 3	TX N-20MHZ MODE CHANNEL 01/06/11
Mode 4	TX N-40MHZ MODE CHANNEL 03/06/09
Mode 5	Normal Link

The EUT system operated these modes were found to be the worst case during the pre-scanning test as following:

For Conducted Test	
Final Test Mode	Description
Mode 5	Normal Link

For Radiated Test	
Final Test Mode	Description
Mode 1	TX B MODE CHANNEL 01/06/11
Mode 2	TX G MODE CHANNEL 01/06/11
Mode 3	TX N-20MHZ MODE CHANNEL 01/06/11
Mode 4	TX N-40MHZ MODE CHANNEL 03/06/09

For Band Edge Test	
Final Test Mode	Description
Mode 1	TX B MODE CHANNEL 01/06/11
Mode 2	TX G MODE CHANNEL 01/06/11
Mode 3	TX N-20MHZ MODE CHANNEL 01/06/11
Mode 4	TX N-40MHZ MODE CHANNEL 03/06/09

6dB Spectrum Bandwidth	
Final Test Mode	Description
Mode 1	TX B MODE CHANNEL 01/06/11
Mode 2	TX G MODE CHANNEL 01/06/11
Mode 3	TX N-20MHZ MODE CHANNEL 01/06/11
Mode 4	TX N-40MHZ MODE CHANNEL 03/06/09

Maximum Conducted Output Power	
Final Test Mode	Description
Mode 1	TX B MODE CHANNEL 01/06/11
Mode 2	TX G MODE CHANNEL 01/06/11
Mode 3	TX N-20MHZ MODE CHANNEL 01/06/11
Mode 4	TX N-40MHZ MODE CHANNEL 03/06/09

Power Spectral Density	
Final Test Mode	Description
Mode 1	TX B MODE CHANNEL 01/06/11
Mode 2	TX G MODE CHANNEL 01/06/11
Mode 3	TX N-20MHZ MODE CHANNEL 01/06/11
Mode 4	TX N-40MHZ MODE CHANNEL 03/06/09

**Note:**

- (1) The measurements are performed at the high, middle, low available channels.
- (2) 802.11b mode: DBPSK (1Mbps)  
 802.11g mode: OFDM (6Mbps)  
 802.11n HT20 mode : BPSK (13Mbps)  
 802.11n HT40 mode : BPSK (27Mbps)  
 For radiated emission tests, the highest output powers were set for final test.
- (3) For radiated below 1G test, the 802.11b is found to be the worst case and recorded.
- (4) The EUT was programmed to be in continuously transmitting mode and the transmit duty cycle is not less than 98%.

### 3.3 TABLE OF PARAMETERS OF TEXT SOFTWARE SETTING

During testing, channel & power controlling software provided by the customer was used to control the operating channel as well as the output power level. The RF output power selection is for the setting of RF output power expected by the customer and is going to be fixed on the firmware of the final end product power parameters of WLAN

Test software version	MP_TEST		
Frequency (MHz)	2412	2437	2462
802.11b	27	35	31
802.11g	29	37	35
802.11n (20MHz)	27	38	30
Frequency (MHz)	2422	2437	2452
802.11n (40MHz)	25	33	26

**3.4 BLOCK DIAGRAM SHOWING THE CONFIGURATION OF SYSTEM TESTED**

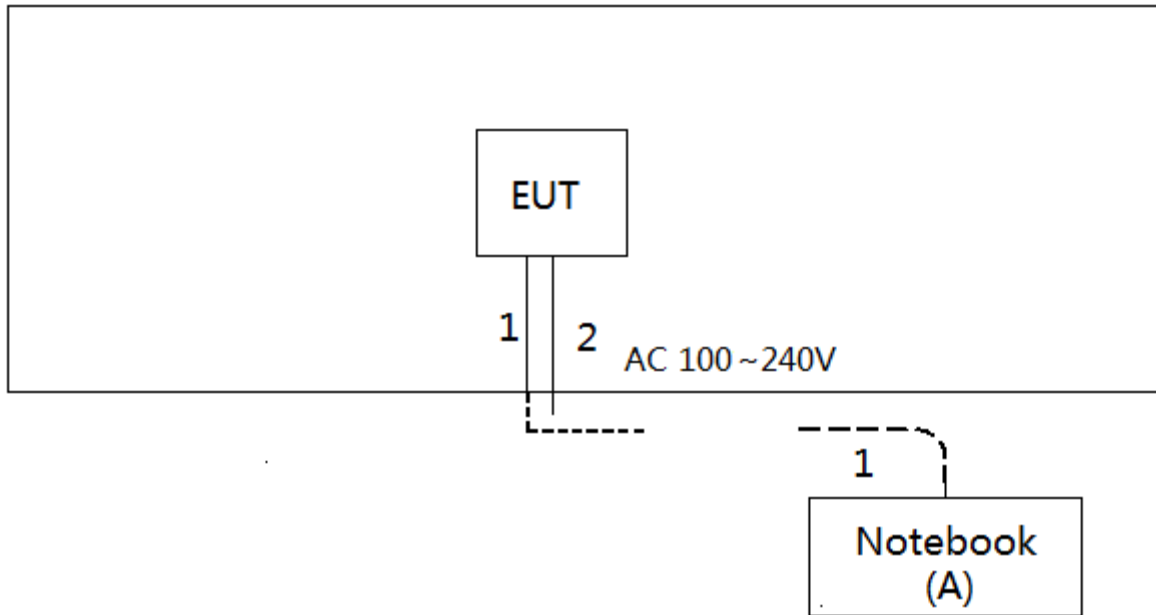

**3.5 DESCRIPTION OF SUPPORT UNITS**

The EUT has been tested as an independent unit together with other necessary accessories or support units. The following support units or accessories were used to form a representative test configuration during the tests.

Item	Equipment	Mfr/Brand	Model/Type No.	FCC ID	Series No.
A	Notebook	DELL	INSPIRON 1420	N/A	JX193A01SDC2

Item	Shielded Type	Ferrite Core	Length	Note
1	NO	NO	10m	RJ45 Cable
2	NO	NO	1.2m	DC Cable

## 4. EMC EMISSION TEST

### 4.1 CONDUCTED EMISSION MEASUREMENT

#### 4.1.1 POWER LINE CONDUCTED EMISSION LIMITS (Frequency Range 150KHz-30MHz)

Frequency of Emission (MHz)	Conducted Limit (dB $\mu$ V)	
	Quasi-peak	Average
0.15 -0.50	66 to 56*	56 to 46*
0.50 -5.0	56	46
5.0 -30.0	60	50

Note:

- (1) The limit of " \* " decreases with the logarithm of the frequency
- (2) The test result calculated as following:  
 Measurement Value = Reading Level + Correct Factor  
 Correct Factor = Insertion Loss + Cable Loss + Attenuator Factor(if use)  
 Margin Level = Measurement Value - Limit Value

The following table is the setting of the receiver

Receiver Parameters	Setting
Attenuation	10 dB
Start Frequency	0.15 MHz
Stop Frequency	30 MHz
IF Bandwidth	9 KHz

#### 4.1.2 TEST PROCEDURE

- a. The EUT was placed 0.8 meters from the horizontal ground plane with EUT being connected to the power mains through a line impedance stabilization network (LISN). All other support equipment powered from additional LISN(s). The LISN provide 50 Ohm/ 50uH of coupling impedance for the measuring instrument.
- b. Interconnecting cables that hang closer than 40 cm to the ground plane shall be folded back and forth in the center forming a bundle 30 to 40 cm long.
- c. I/O cables that are not connected to a peripheral shall be bundled in the center. The end of the cable may be terminated, if required, using the correct terminating impedance. The overall length shall not exceed 1 m.
- d. LISN at least 80 cm from nearest part of EUT chassis.
- e. For the actual test configuration, please refer to the related Item -EUT Test Photos.

#### 4.1.3 DEVIATION FROM TEST STANDARD

No deviation

#### 4.1.4 TEST SETUP

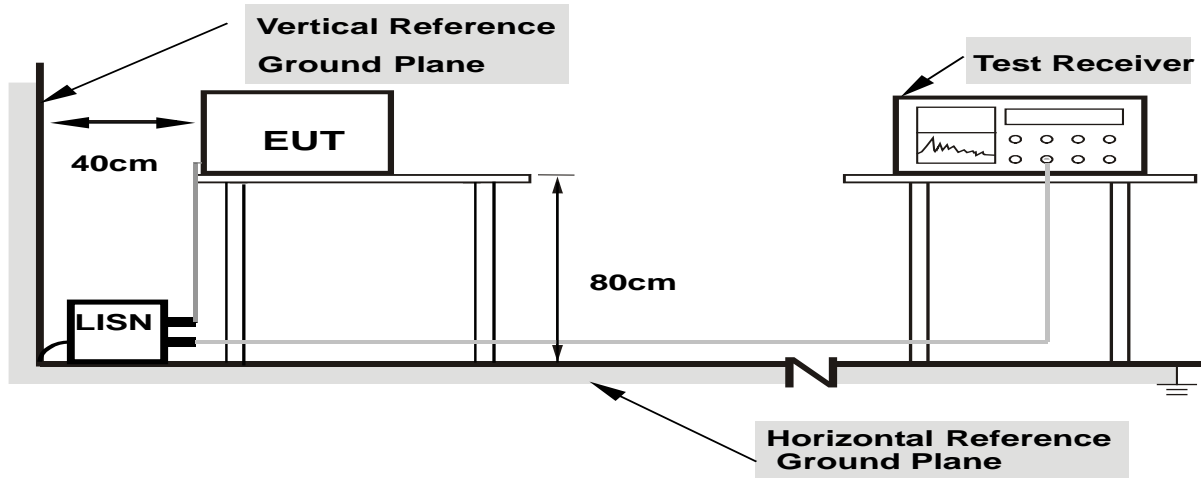

- Note:**
1. Support units were connected to second LISN.
  2. Both of LISNs (AMN) are 80 cm from EUT and at least 80 from other units and other metal planes

#### 4.1.5 EUT OPERATING CONDITIONS

The EUT was placed on the test table and programmed in normal function.

#### 4.1.6 EUT TEST CONDITIONS

Temperature: 25°C    Relative Humidity: 55%    Test Voltage: AC 120V/60Hz

#### 4.1.7 TEST RESULTS

Please refer to the Appendix A.



## 4.2 RADIATED EMISSION MEASUREMENT

### 4.2.1 RADIATED EMISSION LIMITS

In case the emission fall within the restricted band specified on 15.205(a), then the 15.209(a) limit in the table below has to be followed.

#### LIMITS OF RADIATED EMISSION MEASUREMENT (9KHz-1000MHz)

Frequency (MHz)	Field Strength (microvolts/meter)	Measurement Distance (meters)
0.009~0.490	2400/F(KHz)	300
0.490~1.705	24000/F(KHz)	30
1.705~30.0	30	30
30~88	100	3
88~216	150	3
216~960	200	3
960~1000	500	3

#### LIMITS OF RADIATED EMISSION MEASUREMENT (Above 1000MHz)

Frequency (MHz)	(dBuV/m) (at 3 meters)	
	PEAK	AVERAGE
Above 1000	74	54

**Notes:**

- (1) The limit for radiated test was performed according to FCC PART 15C.
- (2) The tighter limit applies at the band edges.
- (3) Emission level (dBuV/m)=20log Emission level (uV/m).
- (4) The test result calculated as following:  
 Measurement Value = Reading Level + Correct Factor  
 Correct Factor = Antenna Factor + Cable Loss - Amplifier Gain(if use)  
 Margin Level = Measurement Value - Limit Value

Spectrum Parameter	Setting
Attenuation	Auto
Start Frequency	1000 MHz
Stop Frequency	10th carrier harmonic
RBW / VBW (Emission in restricted band)	1MHz / 3MHz for Peak, 1MHz / 1/T for Average

Receiver Parameter	Setting
Attenuation	Auto
Start ~ Stop Frequency	9KHz~90KHz for PK/AVG detector
Start ~ Stop Frequency	90KHz~110KHz for QP detector
Start ~ Stop Frequency	110KHz~490KHz for PK/AVG detector
Start ~ Stop Frequency	490KHz~30MHz for QP detector
Start ~ Stop Frequency	30MHz~1000MHz for QP detector

#### 4.2.2 TEST PROCEDURE

- a. The measuring distance of 3 m shall be used for measurements. The EUT was placed on the top of a rotating table 0.8 meter above the ground at a 3 meter semi-anechoic chamber. The table was rotated 360 degrees to determine the position of the highest radiation.(below 1GHz)
- b. The measuring distance of 3 m shall be used for measurements. The EUT was placed on the top of a rotating table 1.5 meter above the ground at a 3 meter semi-anechoic chamber. The table was rotated 360 degrees to determine the position of the highest radiation.(above 1GHz)
- c. The height of the equipment or of the substitution antenna shall be 0.8m or 1.5m; the height of the test antenna shall vary between 1 m to 4 m. Both horizontal and vertical polarizations of the antenna are set to make the measurement.
- d. For each suspected emission, the EUT was arranged to its worst case and then the antenna was tuned to heights find the maximum reading (used Bore sight function).
- e. The receiver system was set to peak and average detect function and specified bandwidth with maximum hold mode when the test frequency is above 1GHz.
- f. The initial step in collecting radiated emission data is a receiver peak detector mode pre-scanning the measurement frequency range. Significant peaks are then marked and then Quasi Peak detector mode re-measured.
- g. All readings are Peak unless otherwise stated QP in column of Note. Peak denotes that the Peak reading compliance with the QP Limits and then QP Mode measurement didn't perform. (below 1GHz)
- h. All readings are Peak Mode value unless otherwise stated AVG in column of Note. If the Peak Mode Measured value compliance with the Peak Limits and lower than AVG Limits, the EUT shall be deemed to meet both Peak & AVG Limits and then only Peak Mode was measured, but AVG Mode didn't perform. (above 1GHz)
- i. For the actual test configuration, please refer to the related Item -EUT Test Photos.

#### 4.2.3 DEVIATION FROM TEST STANDARD

No deviation

#### 4.2.4 TEST SETUP

(A) Radiated Emission Test Set-Up Frequency Below 1 GHz

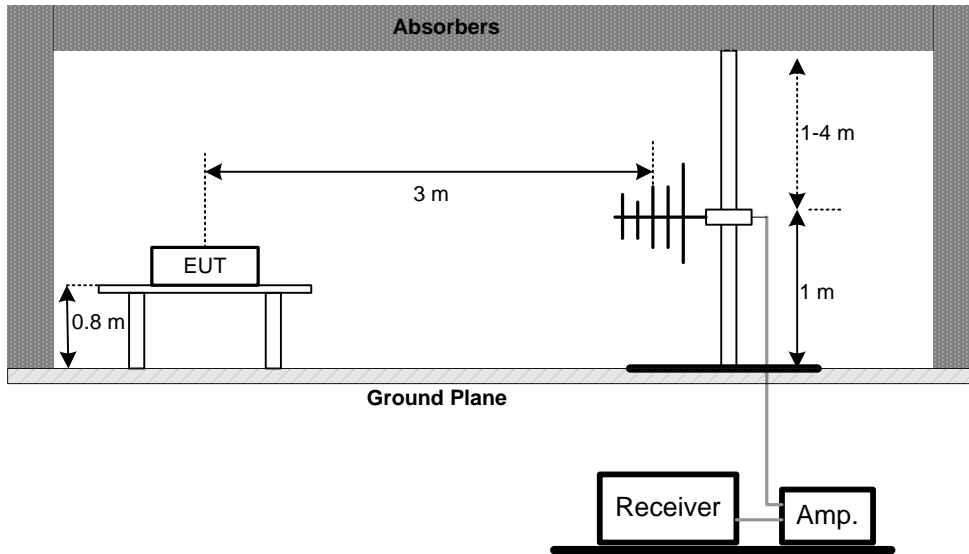

(B) Radiated Emission Test Set-Up Frequency Above 1 GHz

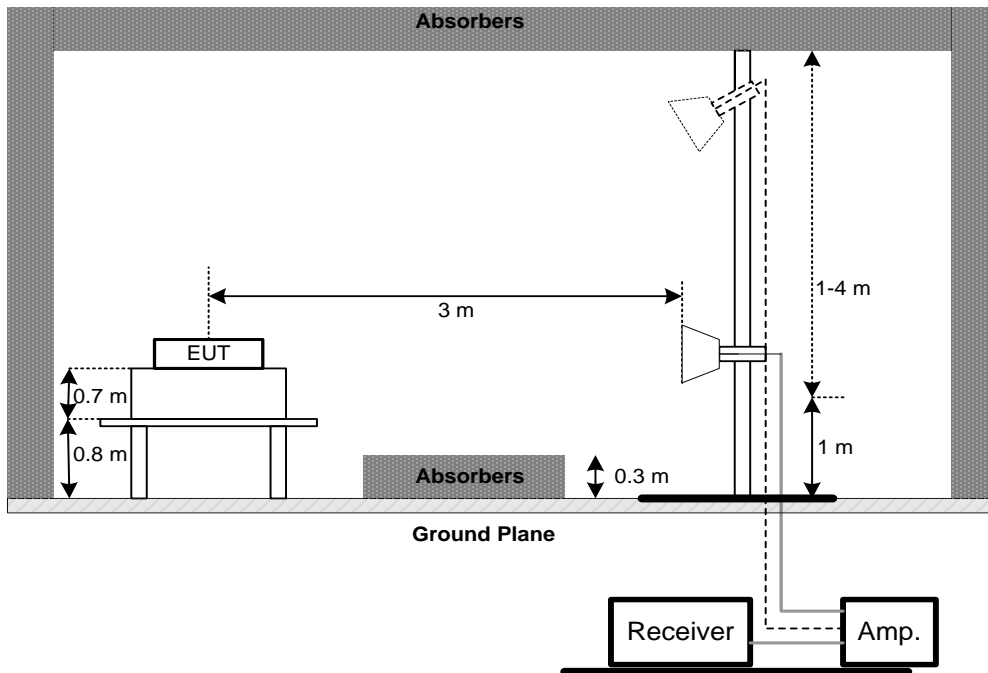

(C) For Radiated Emissions Below 30MHz

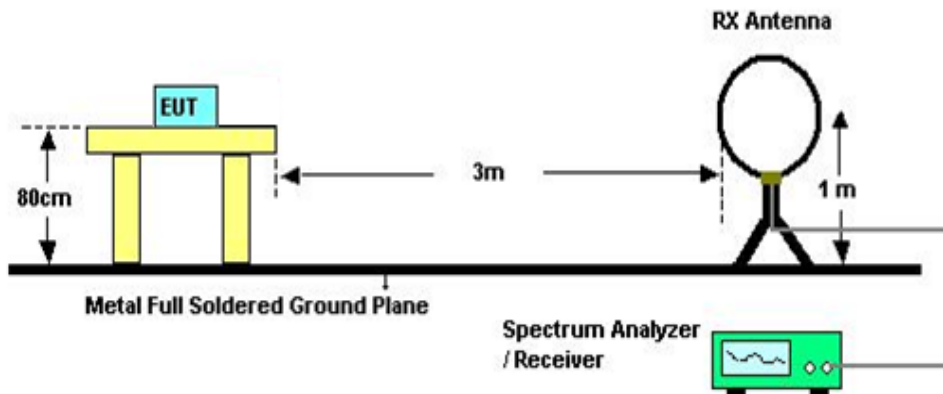

#### 4.2.5 EUT OPERATING CONDITIONS

The EUT was programmed to be in continuously transmitting mode.

#### 4.2.6 EUT TEST CONDITIONS

Temperature: 25°C    Relative Humidity: 55%    Test Voltage: AC 120V/60Hz

#### 4.2.7 TEST RESULTS (9KHZ TO 30MHZ)

Please refer to the Appendix B

Remark:

- (1) The amplitude of spurious emissions which are attenuated by more than 20 dB below the permissible value has no need to be reported.
- (2) Distance extrapolation factor =  $40 \log (\text{specific distance} / \text{test distance})$  (dB).
- (3) Limit line = specific limits (dBuV) + distance extrapolation factor.

#### 4.2.8 TEST RESULTS (30MHZ TO 1000MHZ)

Please refer to the Appendix C.

#### 4.2.9 TEST RESULTS (ABOVE 1000MHZ)

Please refer to the Appendix D.

Remark:

- (1) No limit: This is fundamental signal, the judgment is not applicable.  
For fundamental signal judgment was referred to Peak output test.

## 5. BANDWIDTH TEST

### 5.1 APPLIED PROCEDURES

FCC Part15 (15.247) , Subpart C			
Section	Test Item	Frequency Range (MHz)	Result
15.247(a)(2)	Bandwidth	2400-2483.5	PASS

#### 5.1.1 TEST PROCEDURE

- a. The EUT was directly connected to the spectrum analyzer and antenna output port as show in the block diagram below,
- b. Spectrum Setting: RBW= 100KHz, VBW=300KHz, Sweep time = 2.5 ms.

#### 5.1.2 DEVIATION FROM STANDARD

No deviation.

#### 5.1.3 TEST SETUP



#### 5.1.4 EUT OPERATION CONDITIONS

The EUT was programmed to be in continuously transmitting mode.

#### 5.1.5 EUT TEST CONDITIONS

Temperature: 25°C    Relative Humidity: 55%    Test Voltage: AC 120V/60Hz

#### 5.1.6 TEST RESULTS

Please refer to the Appendix E.

## 6. MAXIMUM PEAK CONDUCTED OUTPUT POWER TEST

### 6.1 APPLIED PROCEDURES / LIMIT

FCC Part15 (15.247) , Subpart C				
Section	Test Item	Limit	Frequency Range (MHz)	Result
15.247(b)(3)	Maximum Output Power	1 Watt or 30dBm	2400-2483.5	PASS

#### 6.1.1 TEST PROCEDURE

- a. The EUT was directly connected to the power meter and antenna output port as show in the block diagram below,
- b. The maximum peak conducted output power was performed in accordance with method 9.1.2 of FCC KDB 558074 D01 DTS Meas Guidance and FCC KDB 662911 D01 Multiple Transmitter Output.

#### 6.1.2 DEVIATION FROM STANDARD

No deviation.

#### 6.1.3 TEST SETUP

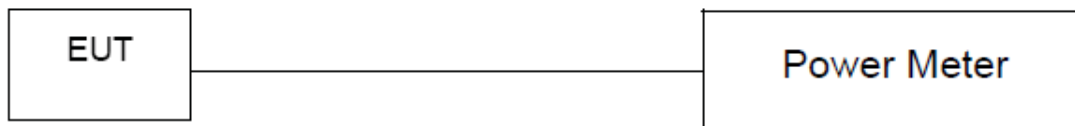

#### 6.1.4 EUT OPERATION CONDITIONS

The EUT was programmed to be in continuously transmitting mode.

#### 6.1.5 EUT TEST CONDITIONS

Temperature: 25°C    Relative Humidity: 55%    Test Voltage: AC 120V/60Hz

#### 6.1.6 TEST RESULTS

Please refer to the Appendix F.

## 7. ANTENNA CONDUCTED SPURIOUS EMISSION

### 7.1 APPLIED PROCEDURES / LIMIT

In any 100 kHz bandwidth outside the frequency band in which the spread spectrum or digitally modulated device is operating, the RF power that is produced shall be at least 20 dB below that in the 100 kHz bandwidth within the band that contains the highest level of the desired power, based on either an RF conducted or a radiated measurement, provided that the transmitter demonstrates compliance with the peak conducted power limits.

#### 7.1.1 TEST PROCEDURE

- The EUT was directly connected to the spectrum analyzer and antenna output port as show in the block diagram below,
- Spectrum Setting: RBW= 100KHz, VBW=300KHz, Sweep time = Auto.
- Offset=antenna gain+cable loss

#### 7.1.2 DEVIATION FROM STANDARD

No deviation.

#### 7.1.3 TEST SETUP

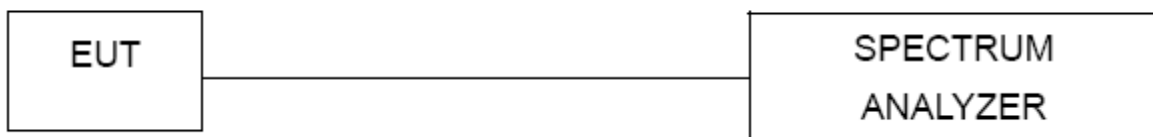

#### 7.1.4 EUT OPERATION CONDITIONS

The EUT was programmed to be in continuously transmitting mode.

#### 7.1.5 EUT TEST CONDITIONS

Temperature: 25°C    Relative Humidity: 55%    Test Voltage: AC 120V/60Hz

#### 7.1.6 TEST RESULTS

Please refer to the Appendix G.

## 8. POWER SPECTRAL DENSITY TEST

### 8.1 APPLIED PROCEDURES / LIMIT

FCC Part15 (15.247) , Subpart C				
Section	Test Item	Limit	Frequency Range (MHz)	Result
15.247(e)	Power Spectral Density	8 dBm (in any 3KHz)	2400-2483.5	PASS

#### 8.1.1 TEST PROCEDURE

- The EUT was directly connected to the spectrum analyzer and antenna output port as show in the block diagram below,
- Spectrum Setting: RBW=3KHz, VBW=10KHz, Sweep time = Auto.

#### 8.1.2 DEVIATION FROM STANDARD

No deviation.

#### 8.1.3 TEST SETUP



#### 8.1.4 EUT OPERATION CONDITIONS

The EUT was programmed to be in continuously transmitting mode.

#### 8.1.5 EUT TEST CONDITIONS

Temperature: 25°C    Relative Humidity: 55%    Test Voltage: AC 120V/60Hz

#### 8.1.6 TEST RESULTS

Please refer to the Appendix H.



## 9. MEASUREMENT INSTRUMENTS LIST

Conducted Emission					
Item	Kind of Equipment	Manufacturer	Type No.	Serial No.	Calibrated until
1	EMI Test Receiver	R&S	ESCI	100382	Mar. 26, 2018
2	LISN	EMCO	3816/2	52765	Mar. 26, 2018
3	50Ω Terminator	SHX	TF2-3G-A	8122901	Mar. 26, 2018
4	TWO-LINE V-NETWORK	R&S	ENV216	101447	Mar. 26, 2018
5	Measurement Software	Farad	EZ-EMC Ver.NB-03A1-01	N/A	N/A
6	Cable	N/A	RG223	12m	Oct. 19, 2018

Radiated Emission Below 1GHz					
Item	Kind of Equipment	Manufacturer	Type No.	Serial No.	Calibrated until
1	Antenna	Schwarbeck	VULB9160	9160-3232	Mar. 26, 2018
2	Amplifier	HP	8447D	2944A09673	Oct. 19, 2018
3	Receiver	Agilent	N9038A	MY52130039	Aug. 20, 2018
4	Cable	emci	LMR-400(30MHz-1 GHz)(8m+5m)	N/A	Jun. 26, 2018
5	Controller	CT	SC100	N/A	N/A
6	Controller	MF	MF-7802	MF780208416	N/A
7	Measurement Software	Farad	EZ-EMC Ver.NB-03A1-01	N/A	N/A
8	Active Loop Antenna	R&S	HFH2-Z2	830749/020	Aug. 20, 2018

Radiated Emission Above 1GHz					
Item	Kind of Equipment	Manufacturer	Type No.	Serial No.	Calibrated until
1	Double Ridged Guide Antenna	ETS	3115	75789	Mar. 26, 2018
2	Broad-Band Horn Antenna	Schwarzbeck	BBHA 9170	9170319	Jun. 08, 2018
3	Amplifier	Agilent	8449B	3008A02274	May. 16, 2018
4	Microwave Preamplifier With Adaptor	EMC INSTRUMENT	EMC2654045	980039 & HA01	Mar. 26, 2018
5	Receiver	Agilent	N9038A	MY52130039	Aug. 20, 2018
6	Antenna	EM	EM-6876-1	230	Mar. 06, 2018
7	Controller	CT	SC100	N/A	N/A
8	Controller	MF	MF-7802	MF780208416	N/A
9	Cable	emci	EMC104-SM-SM-1 2000(12m)	N/A	Jun. 26, 2018
10	Measurement Software	Farad	EZ-EMC Ver.NB-03A1-01	N/A	N/A

6dB Bandwidth					
Item	Kind of Equipment	Manufacturer	Type No.	Serial No.	Calibrated until
1	Spectrum Analyzer	R&S	FSP40	100185	Aug. 20, 2018

Peak Output Power					
Item	Kind of Equipment	Manufacturer	Type No.	Serial No.	Calibrated until
1	Power Meter	ANRITSU	ML2495A	1128009	Mar. 26, 2018
2	Pulse Power Sensor	ANRITSU	MA 2411B	1027500	Mar. 26, 2018

Antenna Conducted Spurious Emission					
Item	Kind of Equipment	Manufacturer	Type No.	Serial No.	Calibrated until
1	Spectrum Analyzer	R&S	FSP40	100185	Aug. 20, 2018

Power Spectral Density					
Item	Kind of Equipment	Manufacturer	Type No.	Serial No.	Calibrated until
1	Spectrum Analyzer	R&S	FSP40	100185	Aug. 20, 2018

Remark: "N/A" denotes no model name, serial no. or calibration specified.  
All calibration period of equipment list is one year.

**10. EUT TEST PHOTO**

**Conducted Measurement Photos**



**Radiated Measurement Photos**

**9KHz to 30MHz**



**Radiated Measurement Photos**

**30MHz to 1000MHz**

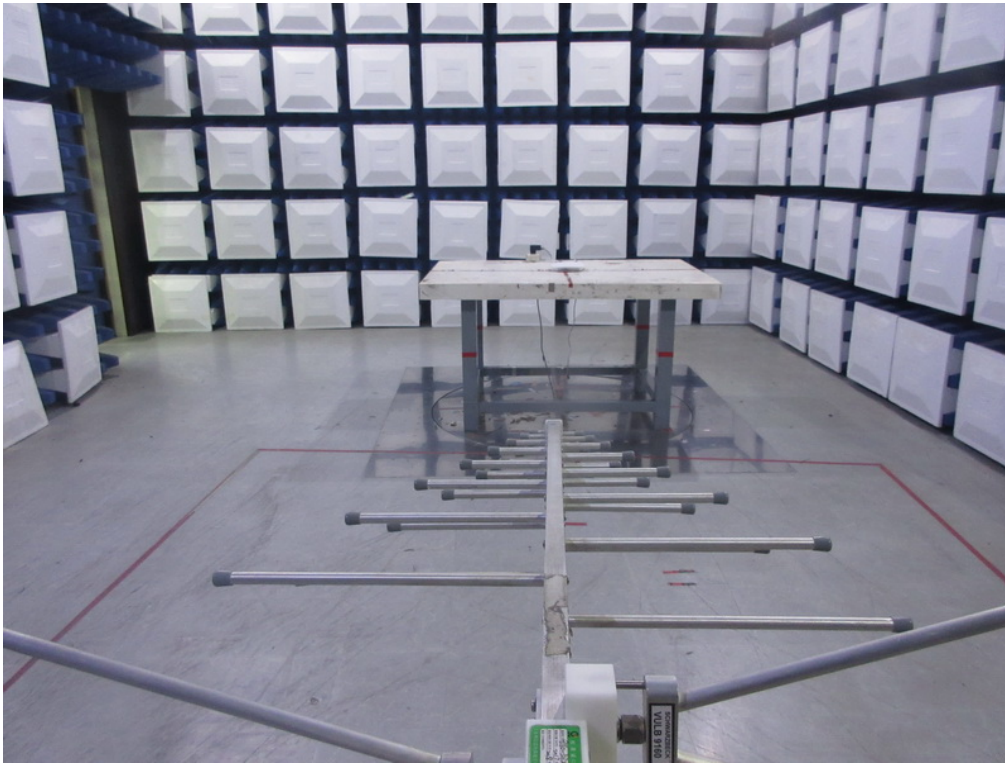

**Radiated Measurement Photos**

**Above 1000MHz**

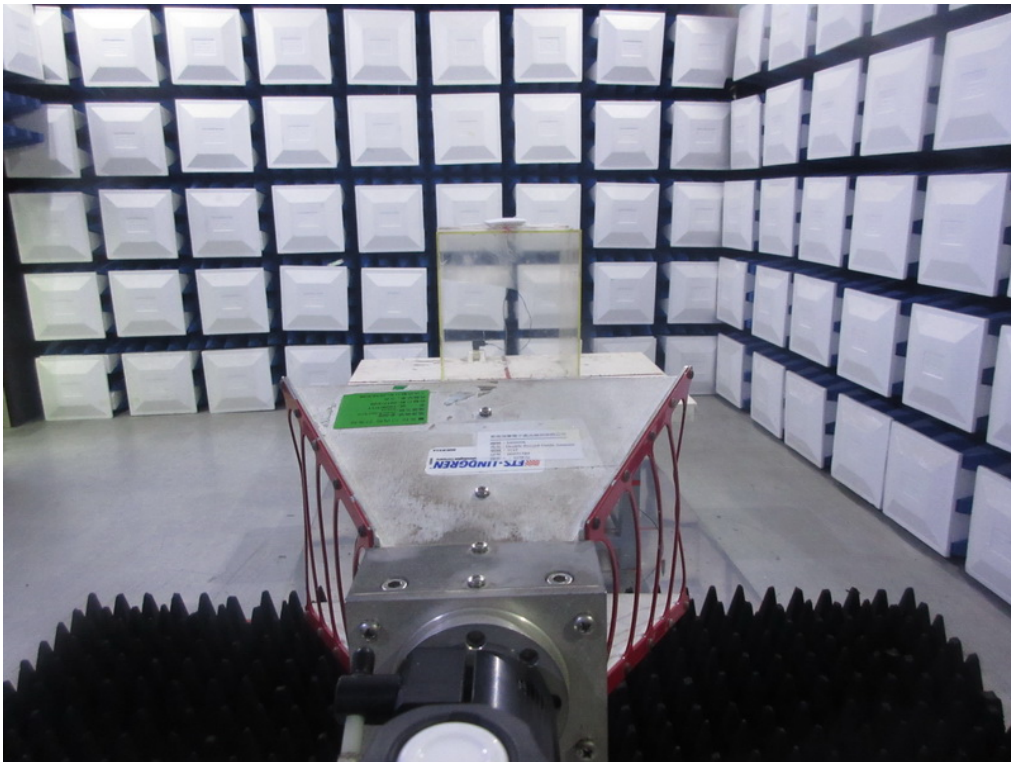

## APPENDIX A - CONDUCTED EMISSION

Test Mode : Normal Link

**Line**

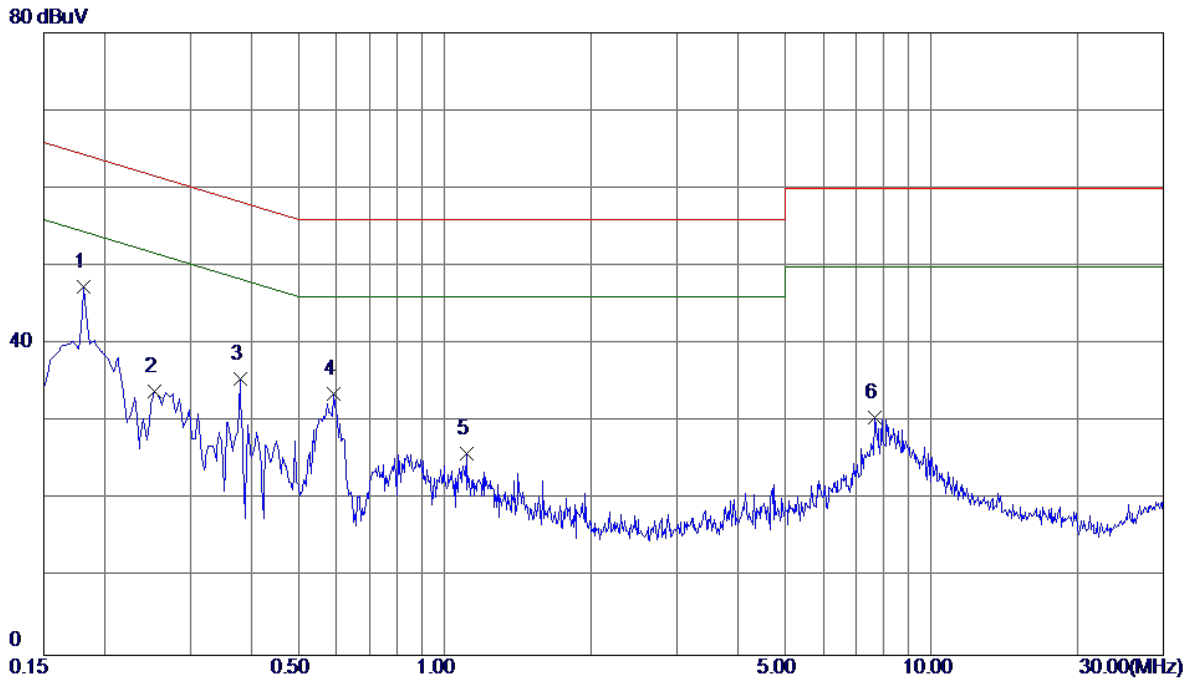

No.	Freq. MHz	Reading Level dBuV	Correct Factor dB	Measure ment dBuV	Limit dBuV	Margin dB	Detector	Comment
1 *	0.1815	37.57	9.73	47.30	64.42	-17.12	Peak	
2	0.2535	24.27	9.72	33.99	61.64	-27.65	Peak	
3	0.3795	25.70	9.75	35.45	58.29	-22.84	Peak	
4	0.5910	23.79	9.76	33.55	56.00	-22.45	Peak	
5	1.1085	16.10	9.78	25.88	56.00	-30.12	Peak	
6	7.6605	20.52	10.00	30.52	60.00	-29.48	Peak	



Test Mode : Normal Link

**Neutral**

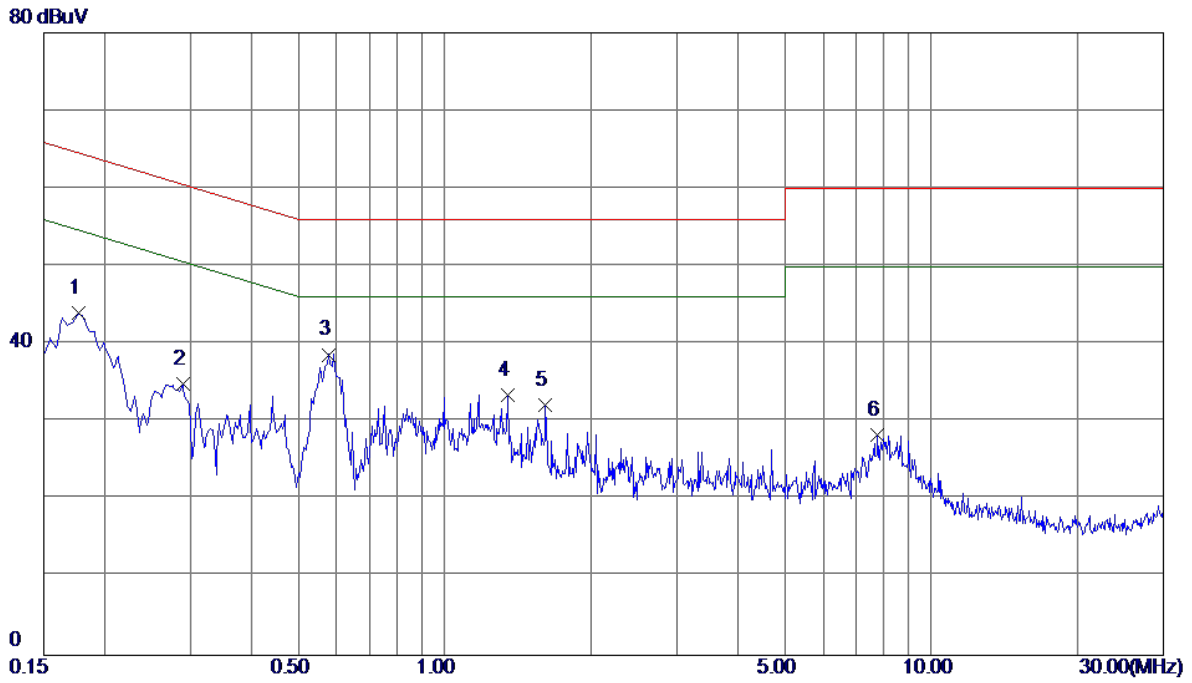

No.	Freq. MHz	Reading Level dBuV	Correct Factor dB	Measure ment dBuV	Limit dBuV	Margin dB	Detector	Comment
1	0.1770	34.35	9.64	43.99	64.63	-20.64	Peak	
2	0.2895	25.18	9.64	34.82	60.54	-25.72	Peak	
3 *	0.5775	28.98	9.66	38.64	56.00	-17.36	Peak	
4	1.3515	23.71	9.69	33.40	56.00	-22.60	Peak	
5	1.6125	22.52	9.71	32.23	56.00	-23.77	Peak	
6	7.7640	18.45	9.93	28.38	60.00	-31.62	Peak	

## APPENDIX B - RADIATED EMISSION (9KHZ TO 30MHZ)

Test Mode: TX B MODE CHANNEL 01

Ant 0°

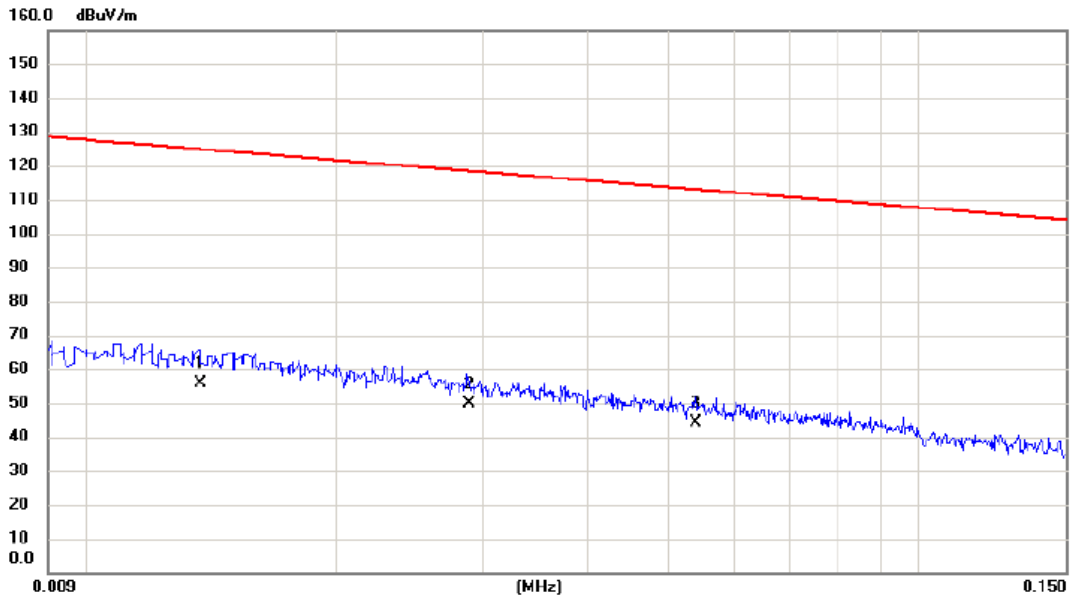

No.	Mk.	Freq. MHz	Reading Level dBuV	Correct Factor dB	Measure- ment dBuV/m	Limit dBuV/m	Margin dB	Detector	Comment
1		0.0137	35.22	20.44	55.66	124.87	-69.21	AVG	
2	*	0.0288	30.48	19.36	49.84	118.42	-68.58	AVG	
3		0.0540	25.49	18.64	44.13	112.96	-68.83	AVG	

Test Mode: TX B MODE CHANNEL 01

Ant 0°

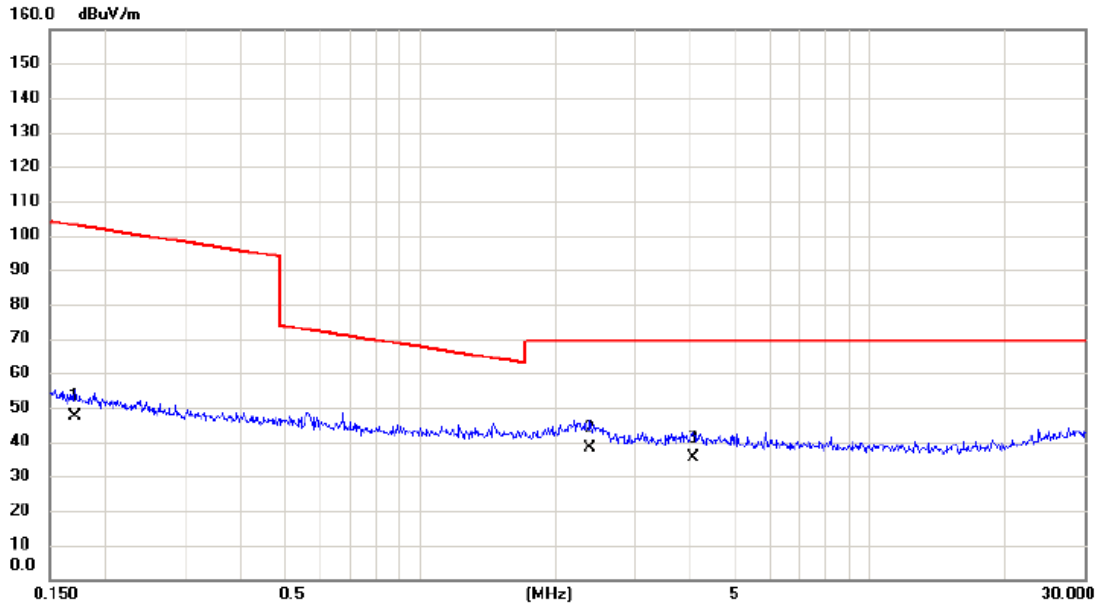

No.	Mk.	Freq. MHz	Reading Level dBuV	Correct Factor dB	Measure- ment dBuV/m	Limit dBuV/m	Margin dB	Detector	Comment
1		0.1712	30.41	16.89	47.30	102.94	-55.64	AVG	
2	*	2.3836	22.69	15.40	38.09	69.54	-31.45	QP	
3		4.0490	20.47	14.92	35.39	69.54	-34.15	QP	

Test Mode: TX B MODE CHANNEL 01

Ant 90°

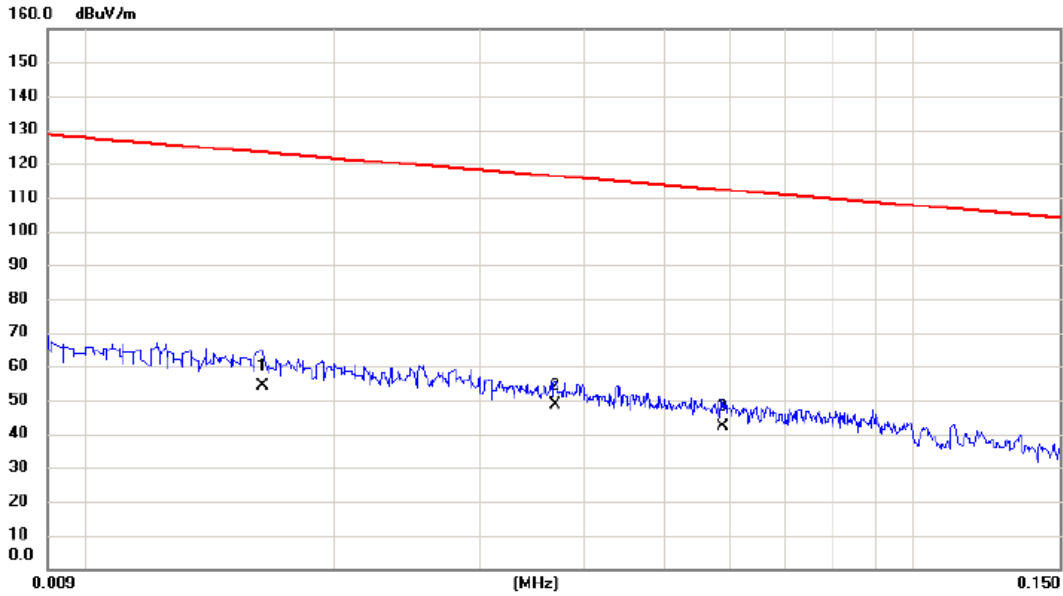

No.	Mk.	Freq. MHz	Reading Level dBuV	Correct Factor dB	Measure- ment dBuV/m	Limit dBuV/m	Margin dB	Detector	Comment
1		0.0164	34.26	20.09	54.35	123.31	-68.96	AVG	
2	*	0.0370	29.48	19.11	48.59	116.24	-67.65	AVG	
3		0.0588	23.57	18.55	42.12	112.22	-70.10	AVG	

Test Mode: TX B MODE CHANNEL 01

Ant 90°

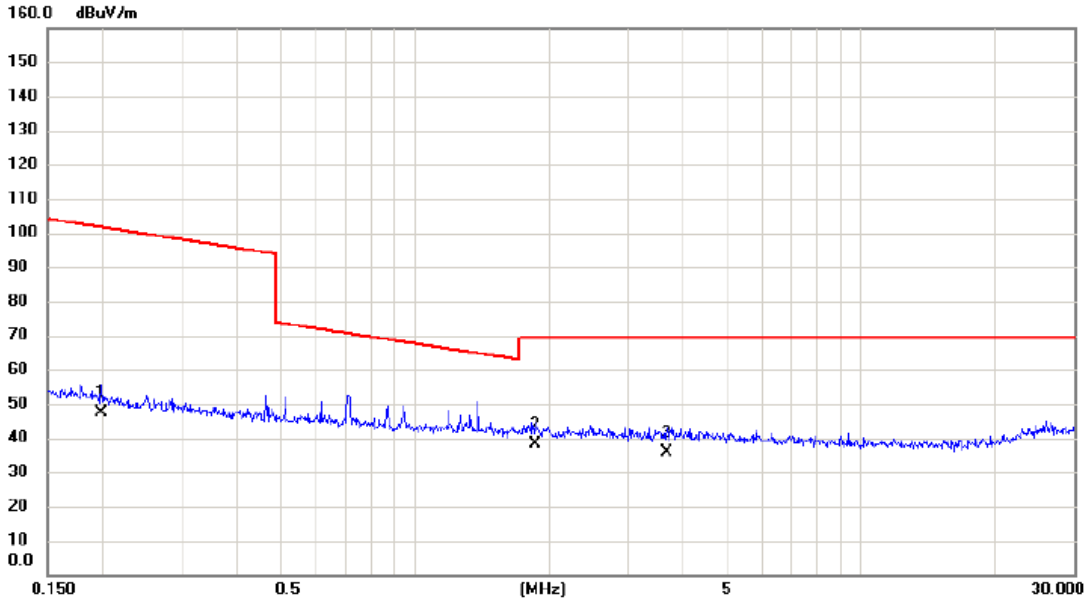

No.	Mk.	Freq. MHz	Reading Level dBuV	Correct Factor dB	Measure- ment dBuV/m	Limit dBuV/m	Margin dB	Detector	Comment
1		0.1986	30.48	16.80	47.28	101.65	-54.37	AVG	
2	*	1.8581	22.76	15.57	38.33	69.54	-31.21	QP	
3		3.6611	20.61	15.04	35.65	69.54	-33.89	QP	

## APPENDIX C - RADIATED EMISSION (30MHZ TO 1000MHZ)

Test Mode: TX B MODE CHANNEL 01

**Vertical**

80 dBuV/m

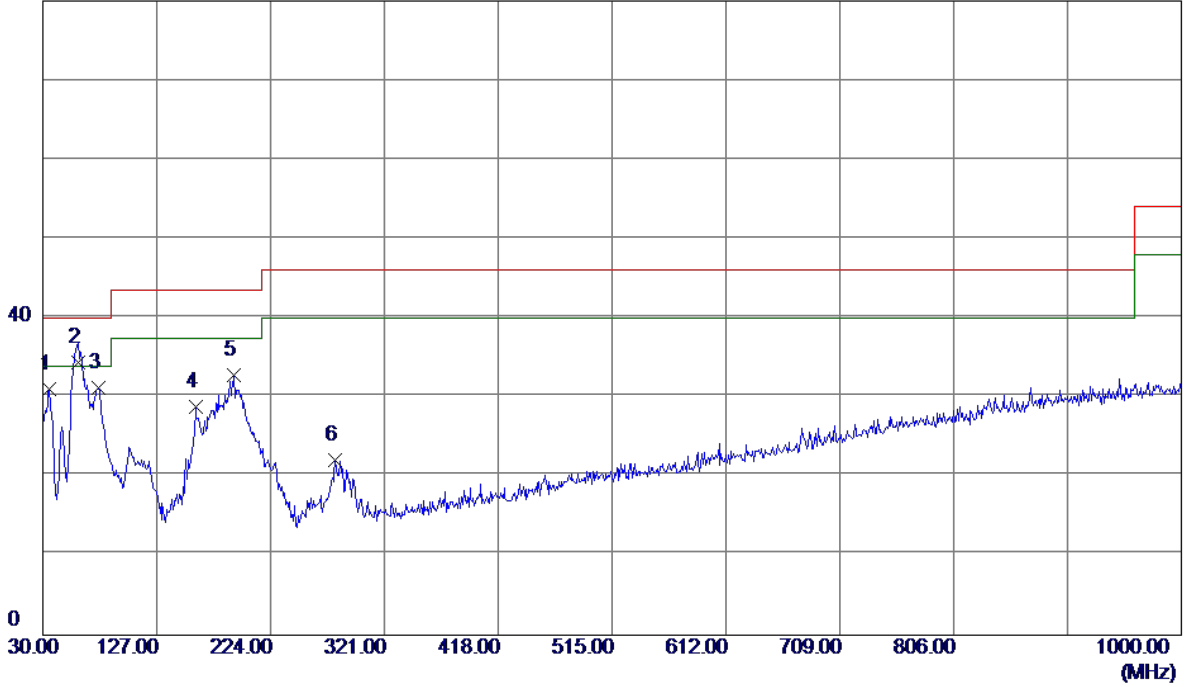

No.	Freq. MHz	Reading Level dBuV/m	Correct Factor dB	Measure ment dBuV/m	Limit dBuV/m	Margin dB	Detector	Comment
1	35.8200	45.60	-14.51	31.09	40.00	-8.91	Peak	
2 *	60.0700	48.76	-14.32	34.44	40.00	-5.56	QP	
3	77.5300	48.85	-17.67	31.18	40.00	-8.82	Peak	
4	159.9800	41.67	-12.93	28.74	43.50	-14.76	Peak	
5	192.9600	45.87	-13.11	32.76	43.50	-10.74	Peak	
6	279.2900	36.89	-14.85	22.04	46.00	-23.96	Peak	



Test Mode: TX B MODE CHANNEL 01

**Horizontal**

80 dBuV/m

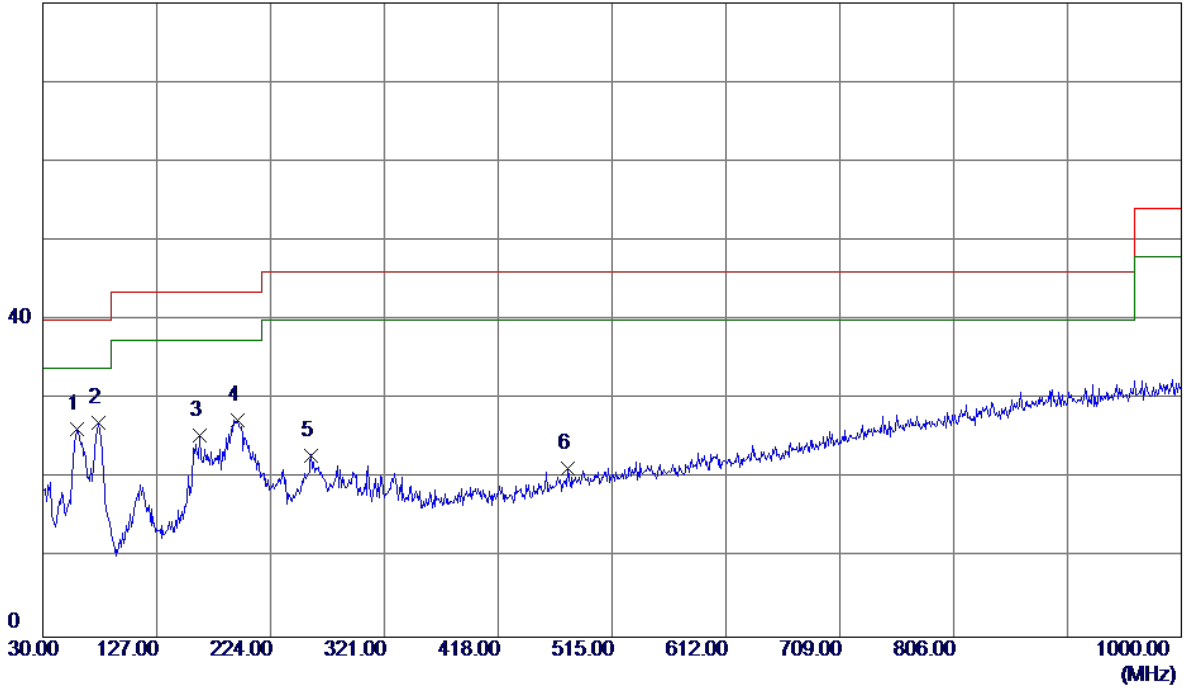

No.	Freq. MHz	Reading Level dBuV/m	Correct Factor dB	Measure ment dBuV/m	Limit dBuV/m	Margin dB	Detector	Comment
1	59.1000	40.52	-14.22	26.30	40.00	-13.70	Peak	
2 *	77.5300	44.70	-17.67	27.03	40.00	-12.97	Peak	
3	163.8600	38.18	-12.70	25.48	43.50	-18.02	Peak	
4	195.8700	40.78	-13.38	27.40	43.50	-16.10	Peak	
5	258.9200	38.58	-15.62	22.96	46.00	-23.04	Peak	
6	477.1700	30.49	-9.28	21.21	46.00	-24.79	Peak	

Test Mode: TX B MODE CHANNEL 06

**Vertical**

80 dBuV/m

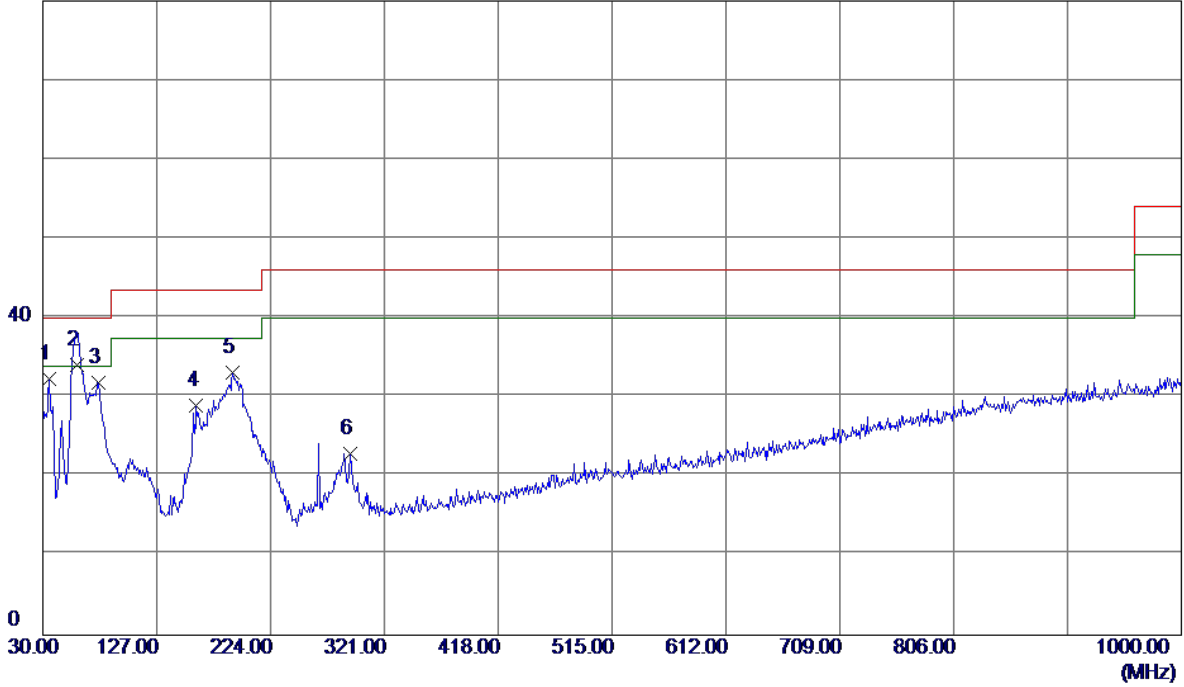

No.	Freq. MHz	Reading Level dBuV/m	Correct Factor dB	Measure ment dBuV/m	Limit dBuV/m	Margin dB	Detector	Comment
1	35.8200	46.77	-14.51	32.26	40.00	-7.74	Peak	
2 *	59.1000	48.29	-14.22	34.07	40.00	-5.93	QP	
3	77.5300	49.48	-17.67	31.81	40.00	-8.19	Peak	
4	160.9500	41.84	-12.87	28.97	43.50	-14.53	Peak	
5	191.9900	46.11	-13.03	33.08	43.50	-10.42	Peak	
6	291.9000	36.78	-13.94	22.84	46.00	-23.16	Peak	

Test Mode: TX B MODE CHANNEL 06

**Horizontal**

80 dBuV/m

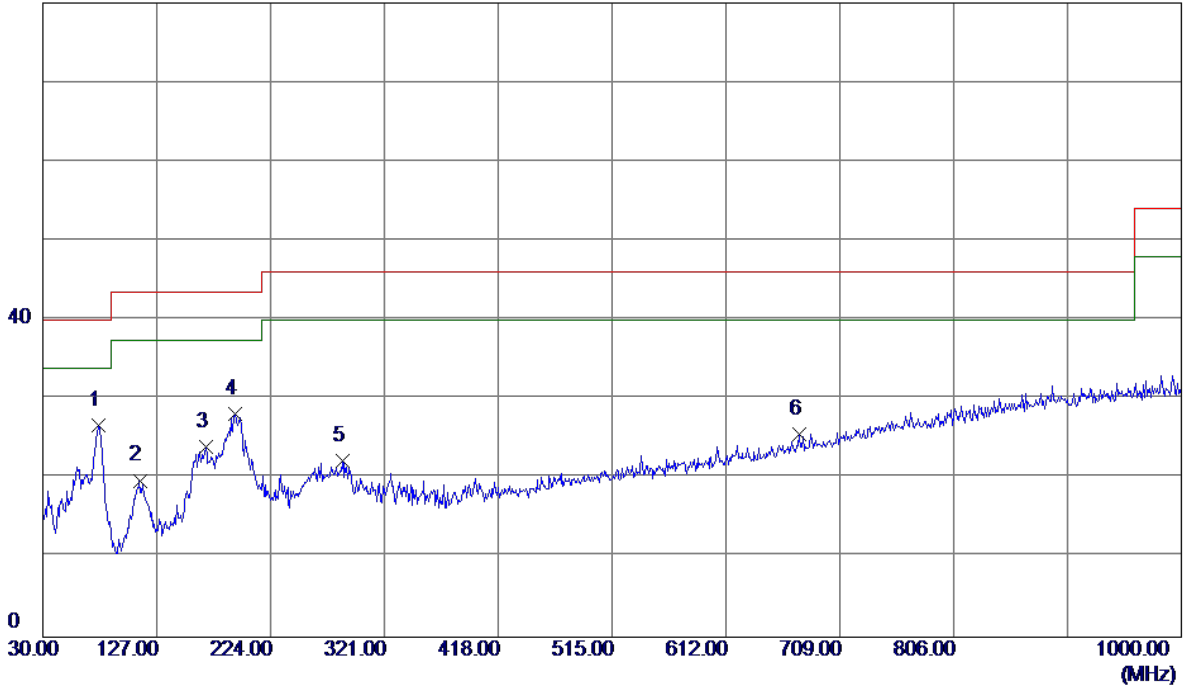

No.	Freq. MHz	Reading Level dBuV/m	Correct Factor dB	Measure ment dBuV/m	Limit dBuV/m	Margin dB	Detector	Comment
1 *	77.5300	44.33	-17.67	26.66	40.00	-13.34	Peak	
2	112.4500	35.76	-16.00	19.76	43.50	-23.74	Peak	
3	168.7100	36.37	-12.41	23.96	43.50	-19.54	Peak	
4	193.9299	41.37	-13.20	28.17	43.50	-15.33	Peak	
5	285.1099	36.69	-14.48	22.21	46.00	-23.79	Peak	
6	674.0800	30.37	-4.74	25.63	46.00	-20.37	Peak	

Test Mode: TX B MODE CHANNEL 11

**Vertical**

80 dBuV/m

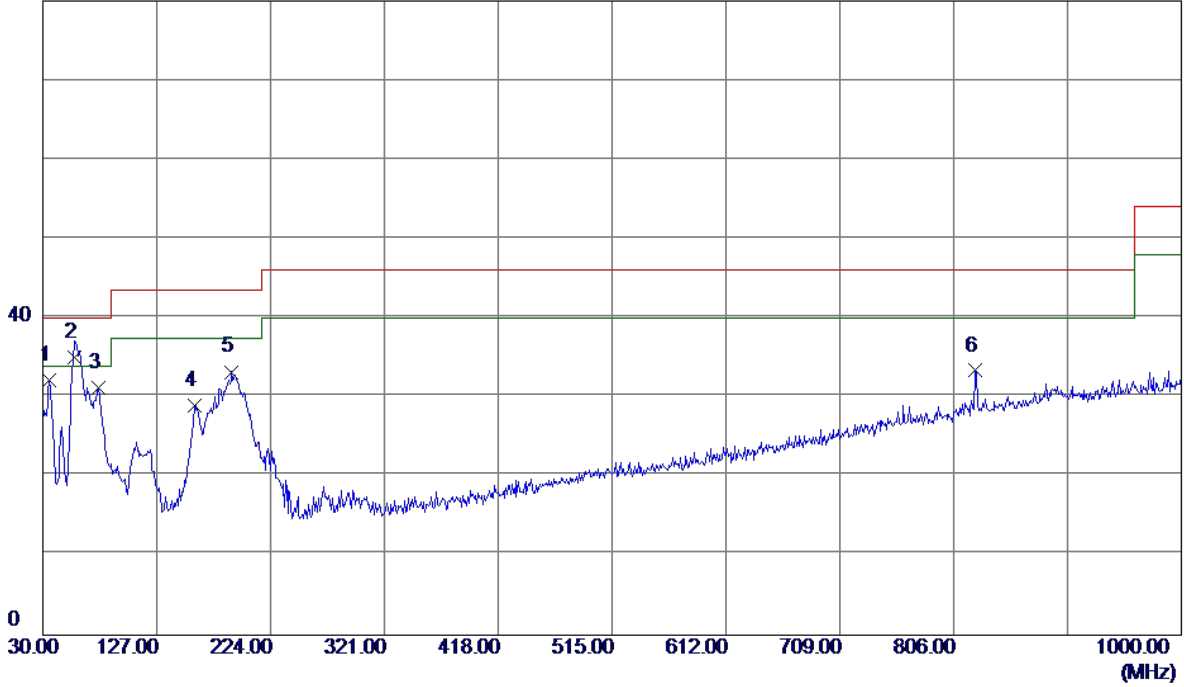

No.	Freq. MHz	Reading Level dBuV/m	Correct Factor dB	Measure ment dBuV/m	Limit dBuV/m	Margin dB	Detector	Comment
1	35.8200	46.68	-14.51	32.17	40.00	-7.83	Peak	
2 *	57.1600	49.03	-14.04	34.99	40.00	-5.01	QP	
3	77.5300	48.93	-17.67	31.26	40.00	-8.74	Peak	
4	159.0100	42.01	-12.99	29.02	43.50	-14.48	Peak	
5	191.0200	46.14	-12.94	33.20	43.50	-10.30	Peak	
6	824.4300	34.06	-0.70	33.36	46.00	-12.64	Peak	

Test Mode: TX B MODE CHANNEL 11

**Horizontal**

80 dBuV/m

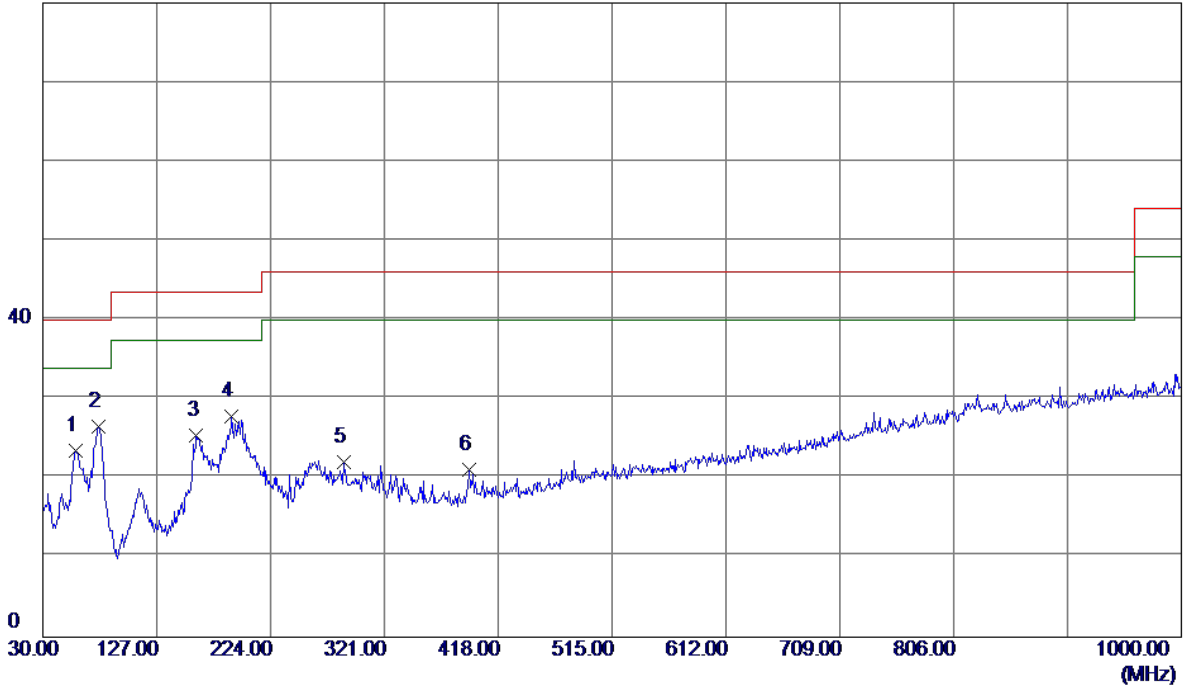

No.	Freq. MHz	Reading Level dBuV/m	Correct Factor dB	Measure ment dBuV/m	Limit dBuV/m	Margin dB	Detector	Comment
1	58.1300	37.65	-14.13	23.52	40.00	-16.48	Peak	
2 *	77.5300	44.22	-17.67	26.55	40.00	-13.45	Peak	
3	160.9500	38.24	-12.87	25.37	43.50	-18.13	Peak	
4	191.0200	40.81	-12.94	27.87	43.50	-15.63	Peak	
5	286.0799	36.49	-14.42	22.07	46.00	-23.93	Peak	
6	392.7800	32.58	-11.45	21.13	46.00	-24.87	Peak	

## APPENDIX D - RADIATED EMISSION (ABOVE 1000MHZ)

Orthogonal Axis :	X
Test Mode :	TX B MODE 2412MHz

**Vertical**

120 dBuV/m

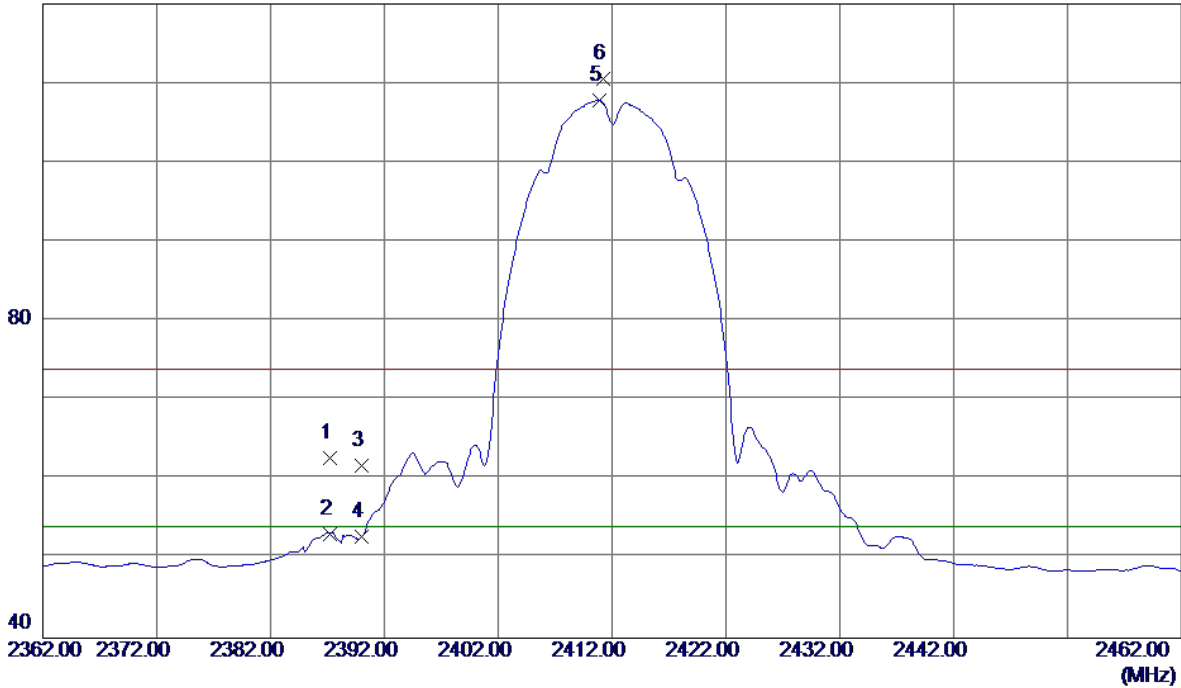

No.	Freq. MHz	Reading Level dBuV/m	Correct Factor dB	Measure ment dBuV/m	Limit dBuV/m	Margin dB	Detector	Comment
1	2387.2000	29.65	33.05	62.70	74.00	-11.30	Peak	
2	2387.2000	20.10	33.05	53.15	54.00	-0.85	AVG	
3	2390.0000	28.75	33.06	61.81	74.00	-12.19	Peak	
4	2390.0000	19.75	33.06	52.81	54.00	-1.19	AVG	
5 *	2410.9000	74.72	33.13	107.85	54.00	53.85	AVG	No Limit
6	2411.2000	77.44	33.14	110.58	74.00	36.58	Peak	No Limit

Orthogonal Axis :	X
Test Mode :	TX B MODE 2412MHz

**Vertical**

80 dBuV/m

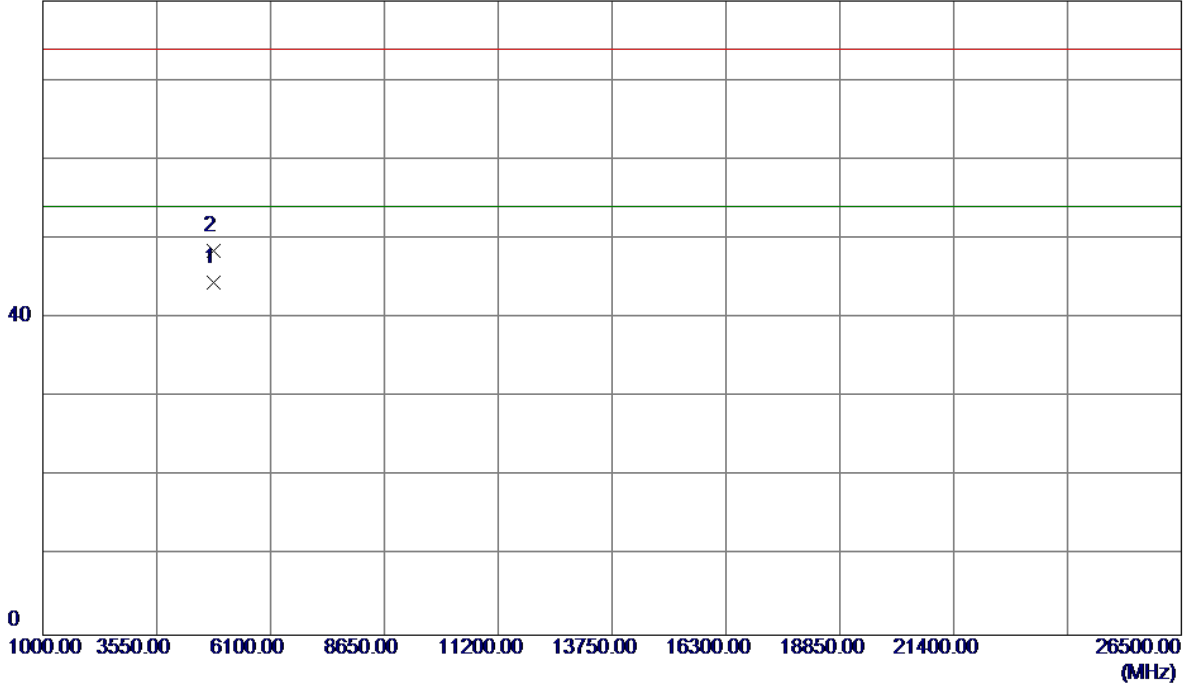

No.	Freq. MHz	Reading Level dBuV/m	Correct Factor dB	Measure ment dBuV/m	Limit dBuV/m	Margin dB	Detector	Comment
1 *	4823.9620	37.83	6.66	44.49	54.00	-9.51	AVG	
2	4824.0280	41.83	6.66	48.49	74.00	-25.51	Peak	



Orthogonal Axis :	X
Test Mode :	TX B MODE 2412MHz

### Horizontal

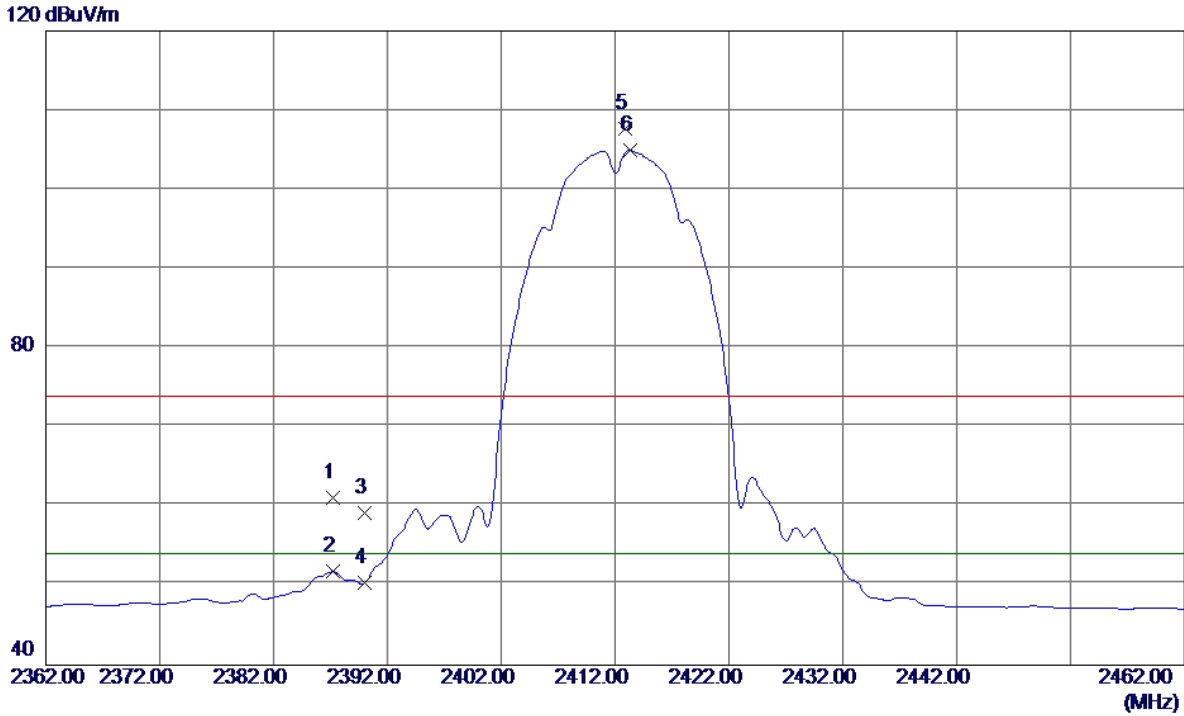

No.	Freq. MHz	Reading Level dBuV/m	Correct Factor dB	Measure ment dBuV/m	Limit dBuV/m	Margin dB	Detector	Comment
1	2387.2000	28.04	33.05	61.09	74.00	-12.91	Peak	
2	2387.2000	18.73	33.05	51.78	54.00	-2.22	AVG	
3	2390.0000	26.08	33.06	59.14	74.00	-14.86	Peak	
4	2390.0000	17.32	33.06	50.38	54.00	-3.62	AVG	
5	2412.9000	74.55	33.14	107.69	74.00	33.69	Peak	No Limit
6 *	2413.3000	71.79	33.14	104.93	54.00	50.93	AVG	No Limit

Orthogonal Axis :	X
Test Mode :	TX B MODE 2412MHz

**Horizontal**

80 dBuV/m

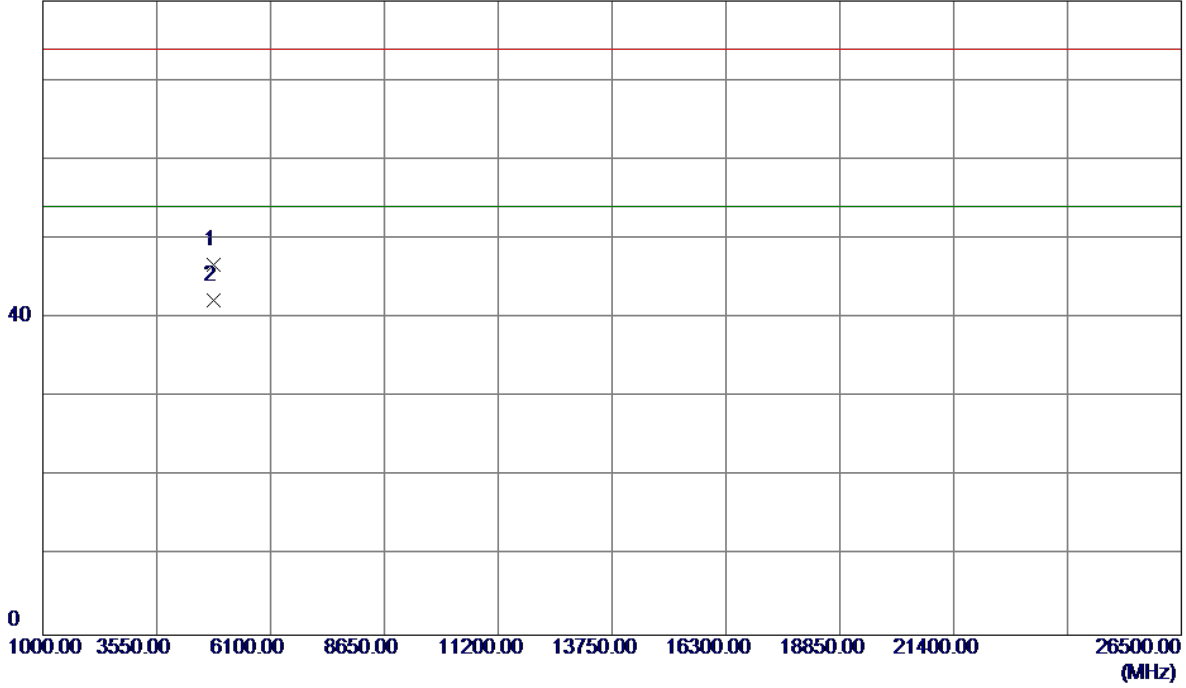

No.	Freq. MHz	Reading Level dBuV/m	Correct Factor dB	Measure ment dBuV/m	Limit dBuV/m	Margin dB	Detector	Comment
1	4823.9230	40.05	6.66	46.71	74.00	-27.29	Peak	
2 *	4823.9650	35.56	6.66	42.22	54.00	-11.78	AVG	

Orthogonal Axis :	X
Test Mode :	TX B MODE 2437MHz

**Vertical**

120 dBuV/m

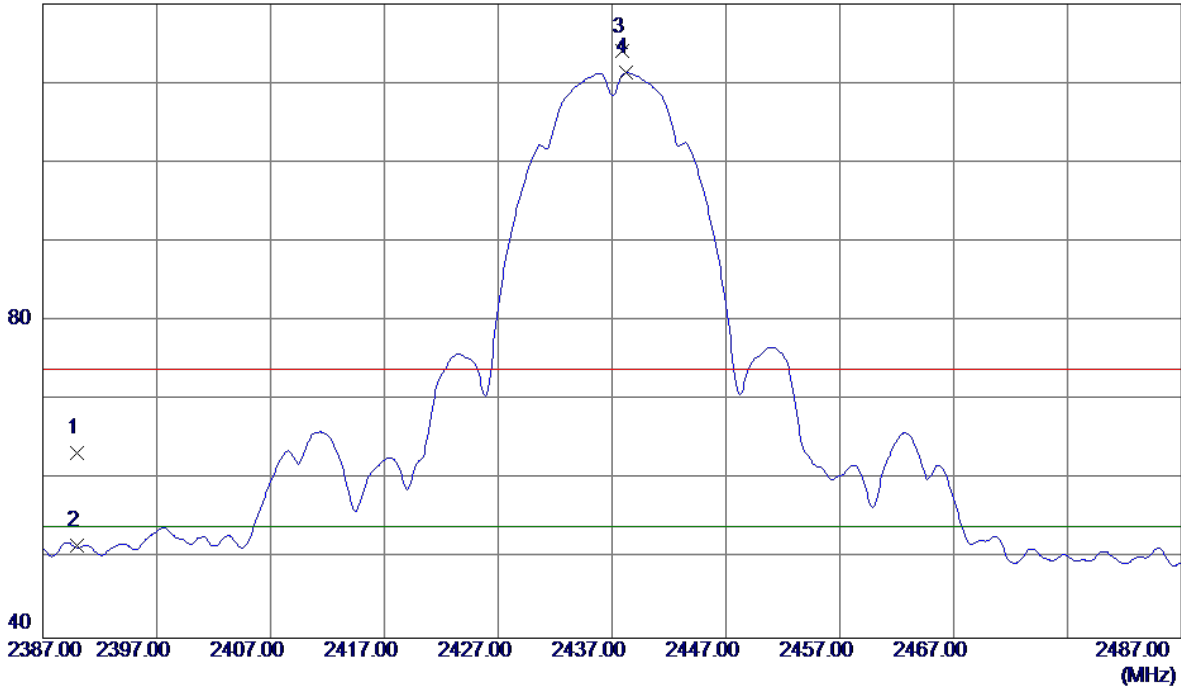

No.	Freq. MHz	Reading Level dBuV/m	Correct Factor dB	Measure ment dBuV/m	Limit dBuV/m	Margin dB	Detector	Comment
1	2390.0000	30.23	33.06	63.29	74.00	-10.71	Peak	
2	2390.0000	18.63	33.06	51.69	54.00	-2.31	AVG	
3	2437.9000	80.76	33.24	114.00	74.00	40.00	Peak	No Limit
4 *	2438.2000	78.08	33.24	111.32	54.00	57.32	AVG	No Limit

Orthogonal Axis :	X
Test Mode :	TX B MODE 2437MHz

**Vertical**

80 dBuV/m

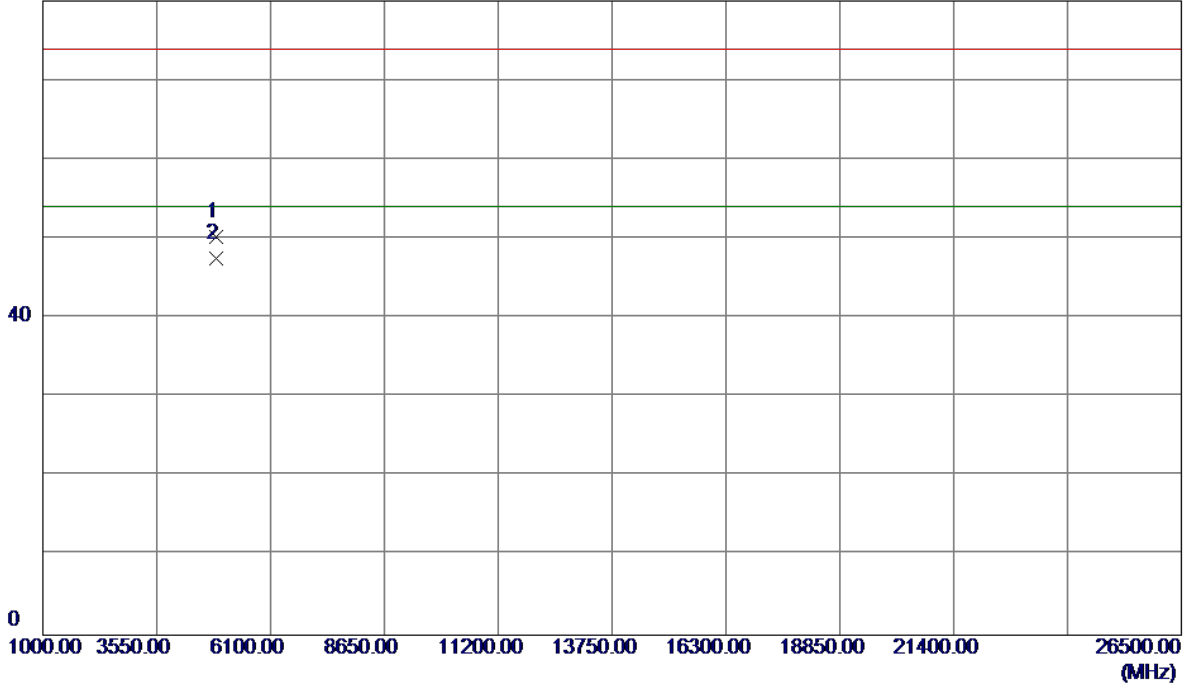

No.	Freq. MHz	Reading Level dBuV/m	Correct Factor dB	Measure ment dBuV/m	Limit dBuV/m	Margin dB	Detector	Comment
1	4873.9380	43.39	6.84	50.23	74.00	-23.77	Peak	
2 *	4874.0139	40.75	6.84	47.59	54.00	-6.41	AVG	

Orthogonal Axis :	X
Test Mode :	TX B MODE 2437MHz

### Horizontal

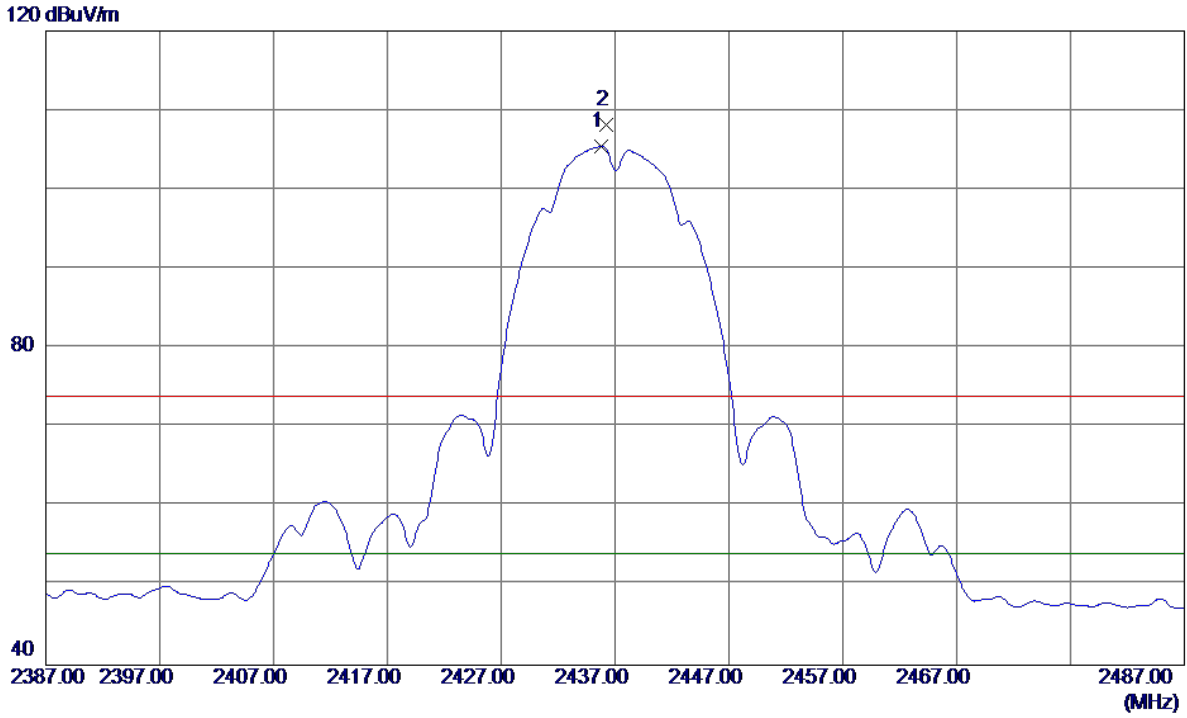

No.	Freq. MHz	Reading Level dBuV/m	Correct Factor dB	Measure ment dBuV/m	Limit dBuV/m	Margin dB	Detector	Comment
1 *	2435.8000	72.21	33.23	105.44	54.00	51.44	AVG	No Limit
2	2436.2000	74.88	33.23	108.11	74.00	34.11	Peak	No Limit

Orthogonal Axis :	X
Test Mode :	TX B MODE 2437MHz

**Horizontal**

80 dBuV/m

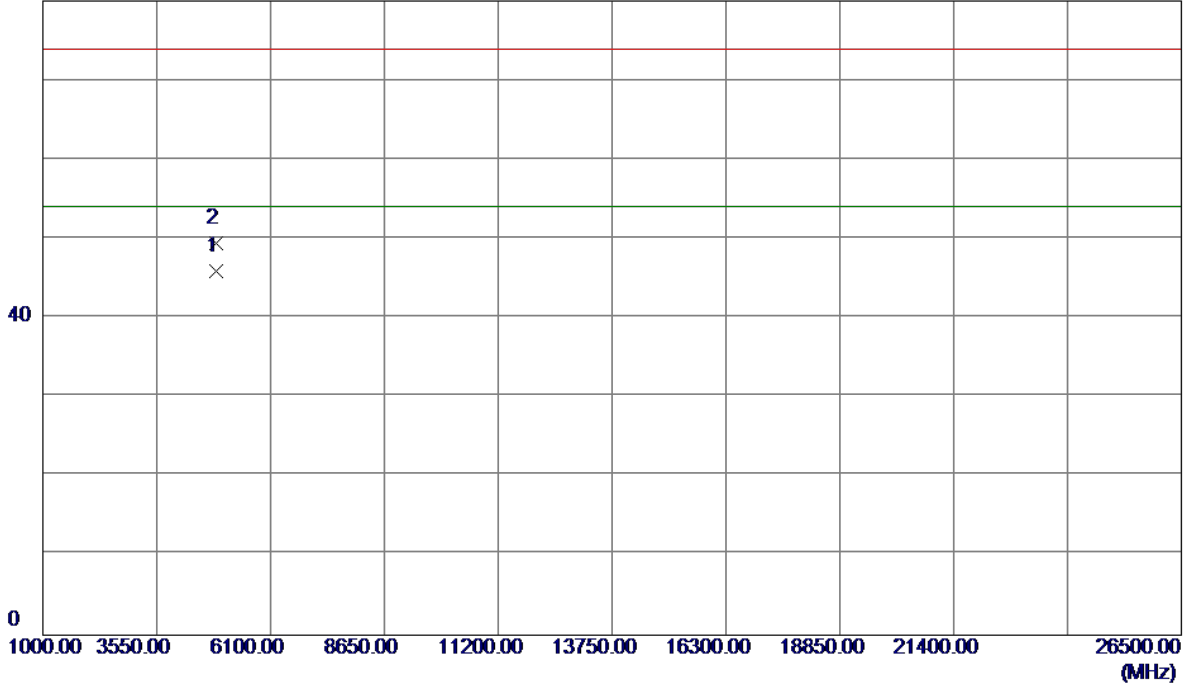

No.	Freq. MHz	Reading Level dBuV/m	Correct Factor dB	Measure ment dBuV/m	Limit dBuV/m	Margin dB	Detector	Comment
1 *	4873.9950	39.15	6.84	45.99	54.00	-8.01	AVG	
2	4874.0870	42.59	6.84	49.43	74.00	-24.57	Peak	

Orthogonal Axis :	X
Test Mode :	TX B MODE 2462MHz

**Vertical**

120 dBuV/m

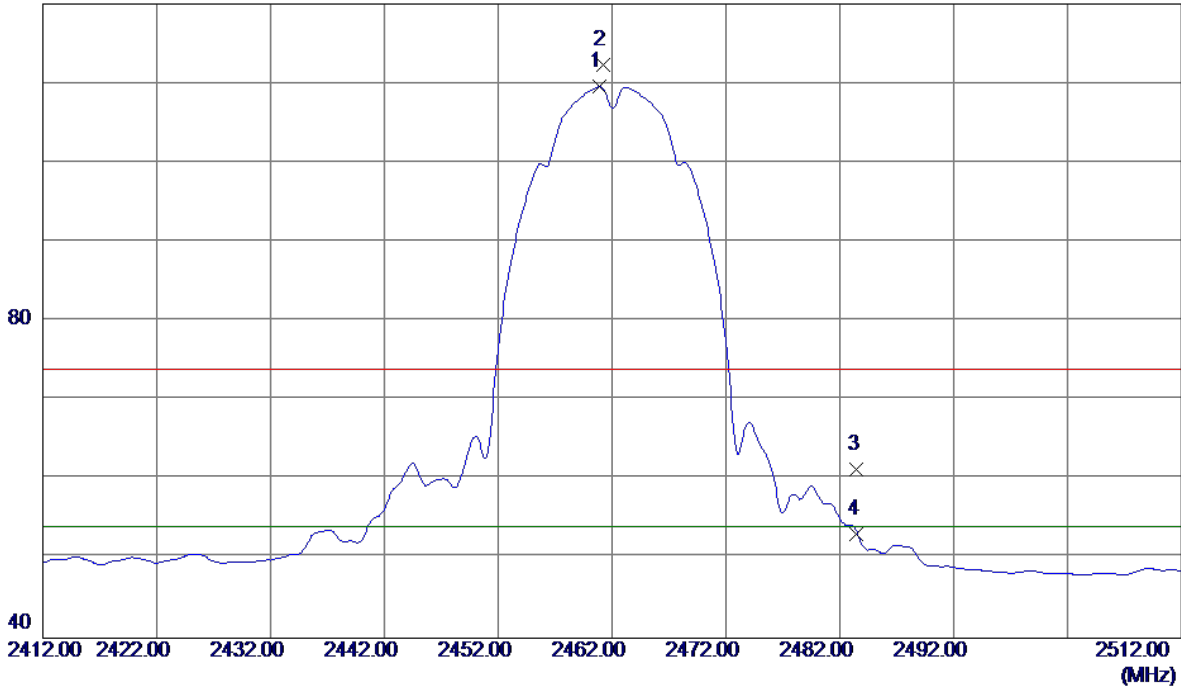

No.	Freq. MHz	Reading Level dBuV/m	Correct Factor dB	Measure ment dBuV/m	Limit dBuV/m	Margin dB	Detector	Comment
1 *	2460.9000	76.24	33.32	109.56	54.00	55.56	AVG	No Limit
2	2461.2000	79.04	33.32	112.36	74.00	38.36	Peak	No Limit
3	2483.5000	27.92	33.41	61.33	74.00	-12.67	Peak	
4	2483.5000	19.77	33.41	53.18	54.00	-0.82	AVG	

Orthogonal Axis :	X
Test Mode :	TX B MODE 2462MHz

**Vertical**

80 dBuV/m

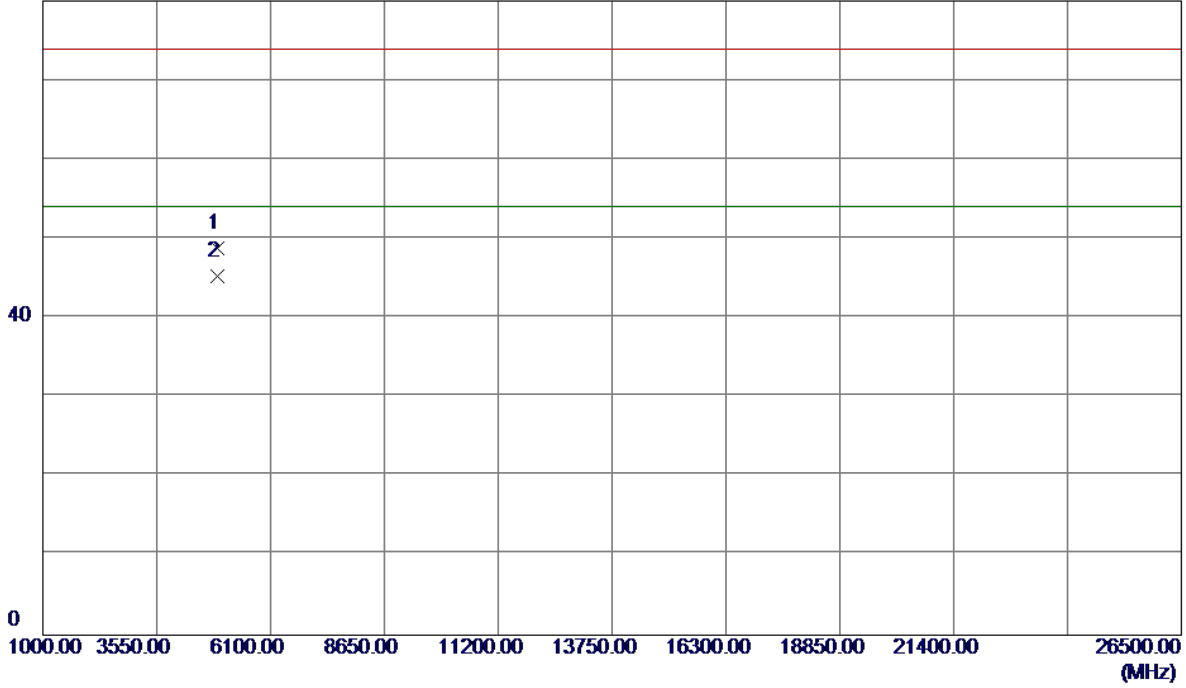

No.	Freq. MHz	Reading Level dBuV/m	Correct Factor dB	Measure ment dBuV/m	Limit dBuV/m	Margin dB	Detector	Comment
1	4923.9100	41.84	7.02	48.86	74.00	-25.14	Peak	
2 *	4923.9760	38.25	7.02	45.27	54.00	-8.73	AVG	



Orthogonal Axis :	X
Test Mode :	TX B MODE 2462MHz

**Horizontal**

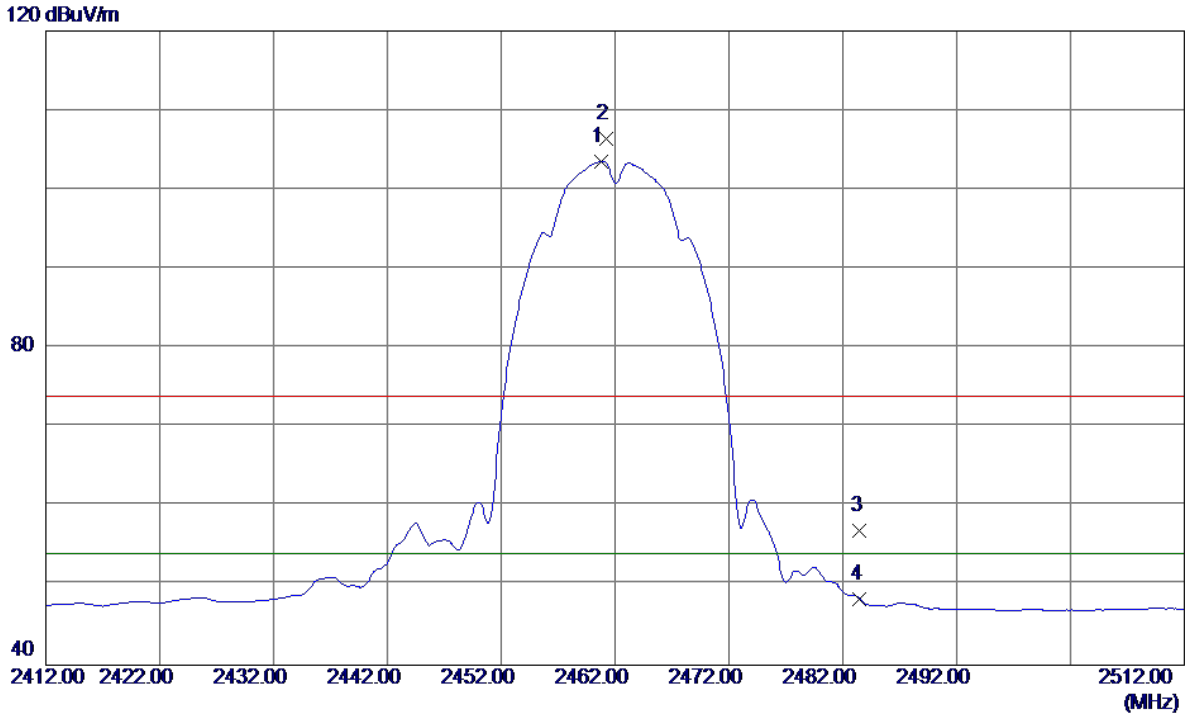

No.	Freq. MHz	Reading Level dBuV/m	Correct Factor dB	Measure ment dBuV/m	Limit dBuV/m	Margin dB	Detector	Comment
1 *	2460.8000	70.26	33.32	103.58	54.00	49.58	AVG	No Limit
2	2461.2000	73.07	33.32	106.39	74.00	32.39	Peak	No Limit
3	2483.5000	23.54	33.41	56.95	74.00	-17.05	Peak	
4	2483.5000	14.98	33.41	48.39	54.00	-5.61	AVG	

Orthogonal Axis :	X
Test Mode :	TX B MODE 2462MHz

**Horizontal**

80 dBuV/m

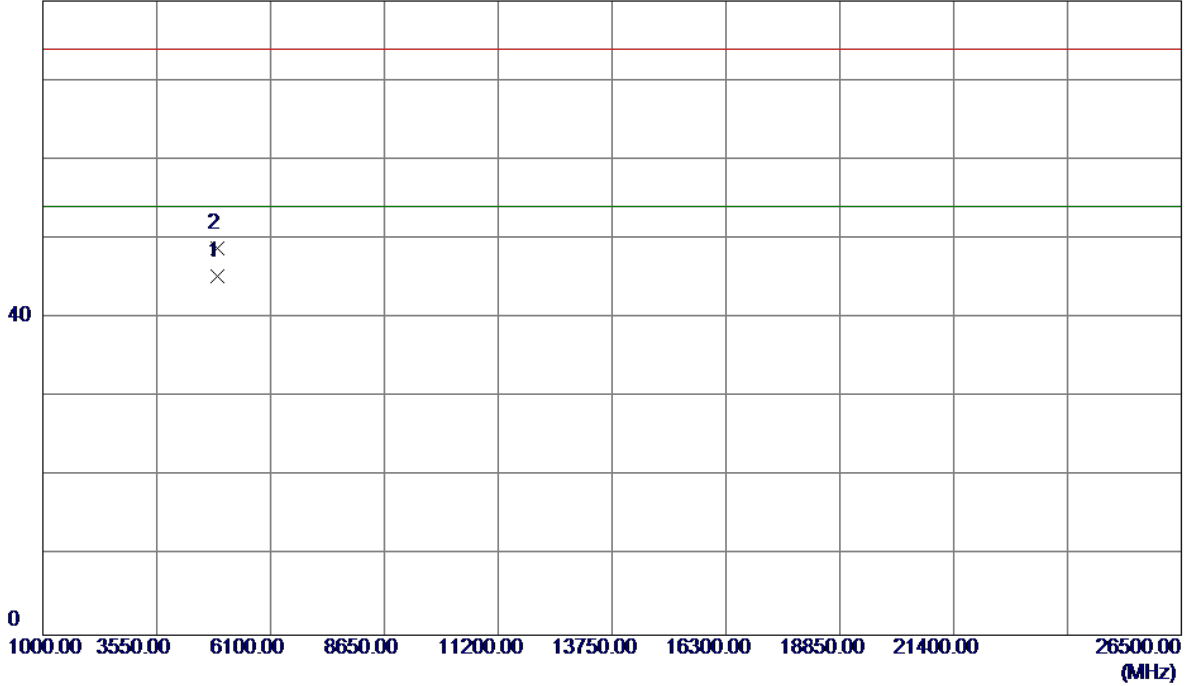

No.	Freq. MHz	Reading Level dBuV/m	Correct Factor dB	Measure ment dBuV/m	Limit dBuV/m	Margin dB	Detector	Comment
1 *	4923.9850	38.22	7.02	45.24	54.00	-8.76	AVG	
2	4923.9990	41.78	7.02	48.80	74.00	-25.20	Peak	

Orthogonal Axis :	X
Test Mode :	TX G MODE 2412MHz

**Vertical**

120 dBuV/m

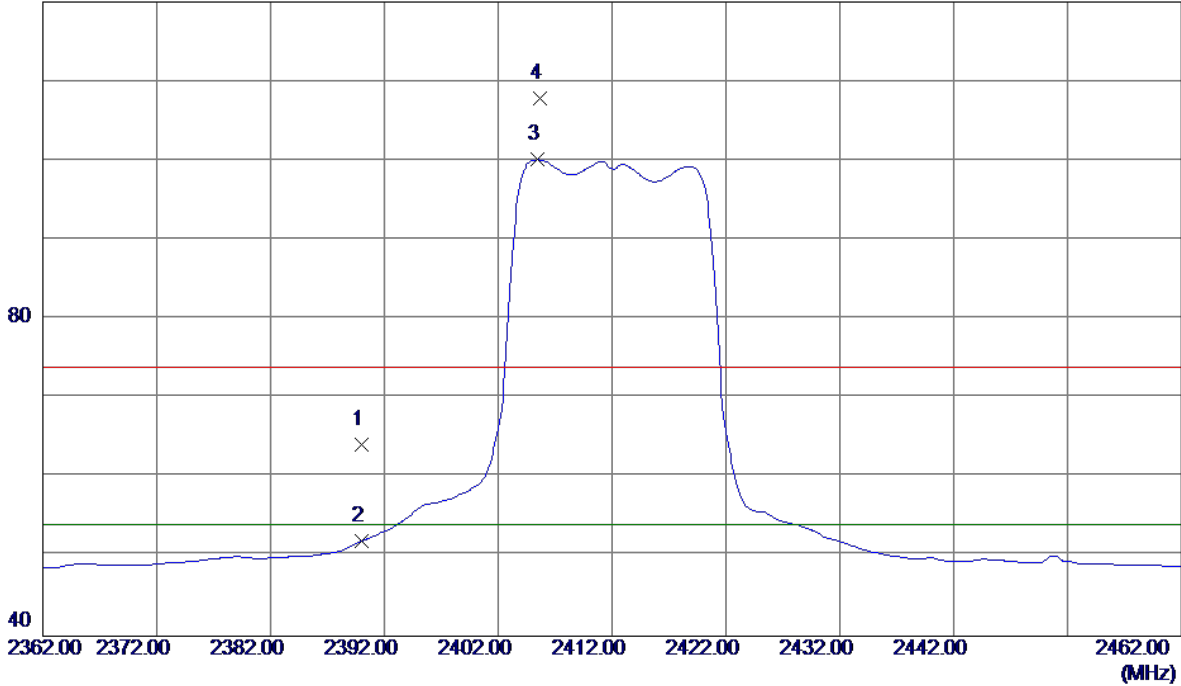

No.	Freq. MHz	Reading Level dBuV/m	Correct Factor dB	Measure ment dBuV/m	Limit dBuV/m	Margin dB	Detector	Comment
1	2390.0000	31.17	33.06	64.23	74.00	-9.77	Peak	
2	2390.0000	18.94	33.06	52.00	54.00	-2.00	AVG	
3 *	2405.4000	66.98	33.11	100.09	54.00	46.09	AVG	No Limit
4	2405.7000	74.64	33.12	107.76	74.00	33.76	Peak	No Limit

Orthogonal Axis :	X
Test Mode :	TX G MODE 2412MHz

**Vertical**

80 dBuV/m

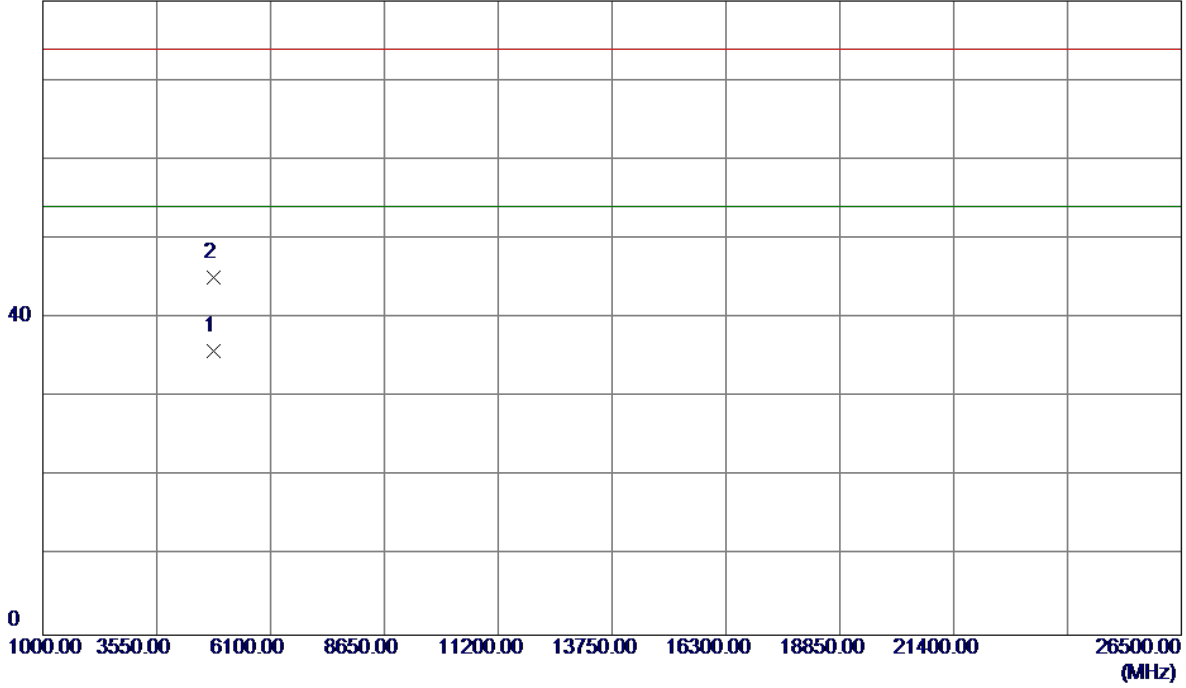

No.	Freq. MHz	Reading Level dBuV/m	Correct Factor dB	Measure ment dBuV/m	Limit dBuV/m	Margin dB	Detector	Comment
1 *	4824.1549	29.11	6.66	35.77	54.00	-18.23	AVG	
2	4824.8900	38.43	6.66	45.09	74.00	-28.91	Peak	

Orthogonal Axis :	X
Test Mode :	TX G MODE 2412MHz

**Horizontal**

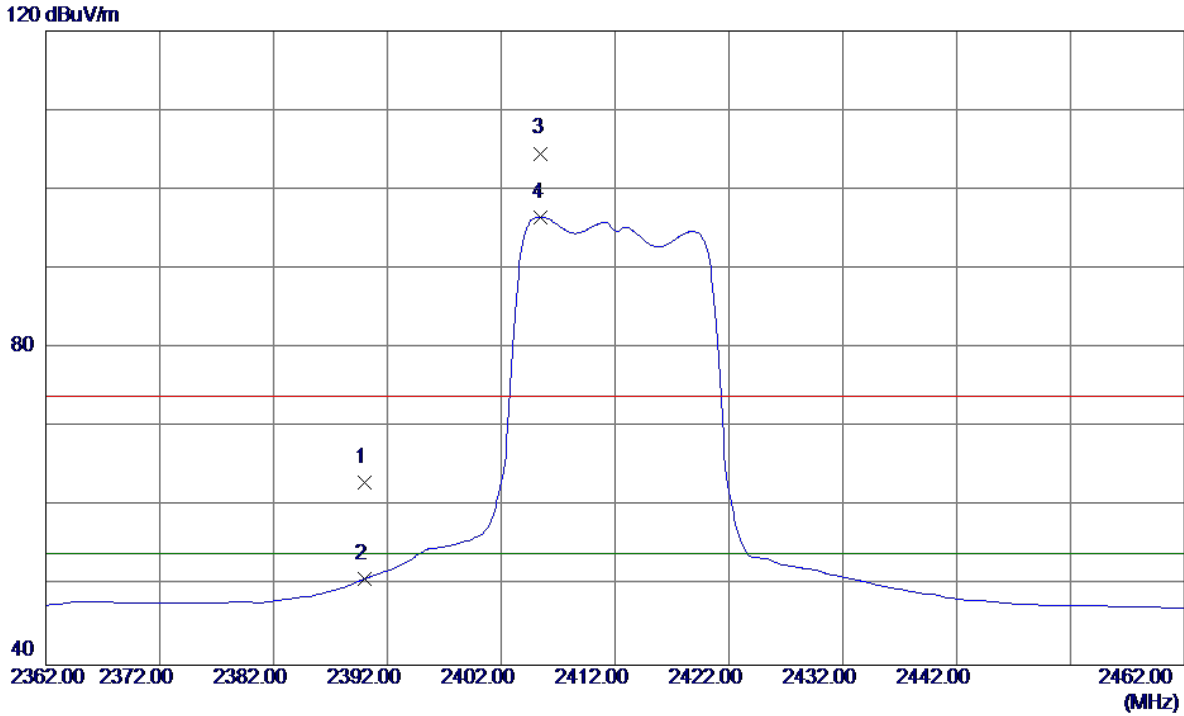

No.	Freq. MHz	Reading Level dBuV/m	Correct Factor dB	Measure ment dBuV/m	Limit dBuV/m	Margin dB	Detector	Comment
1	2390.0000	29.92	33.06	62.98	74.00	-11.02	Peak	
2	2390.0000	17.83	33.06	50.89	54.00	-3.11	AVG	
3	2405.5000	71.45	33.11	104.56	74.00	30.56	Peak	No Limit
4 *	2405.5000	63.42	33.11	96.53	54.00	42.53	AVG	No Limit

Orthogonal Axis :	X
Test Mode :	TX G MODE 2412MHz

**Horizontal**

80 dBuV/m

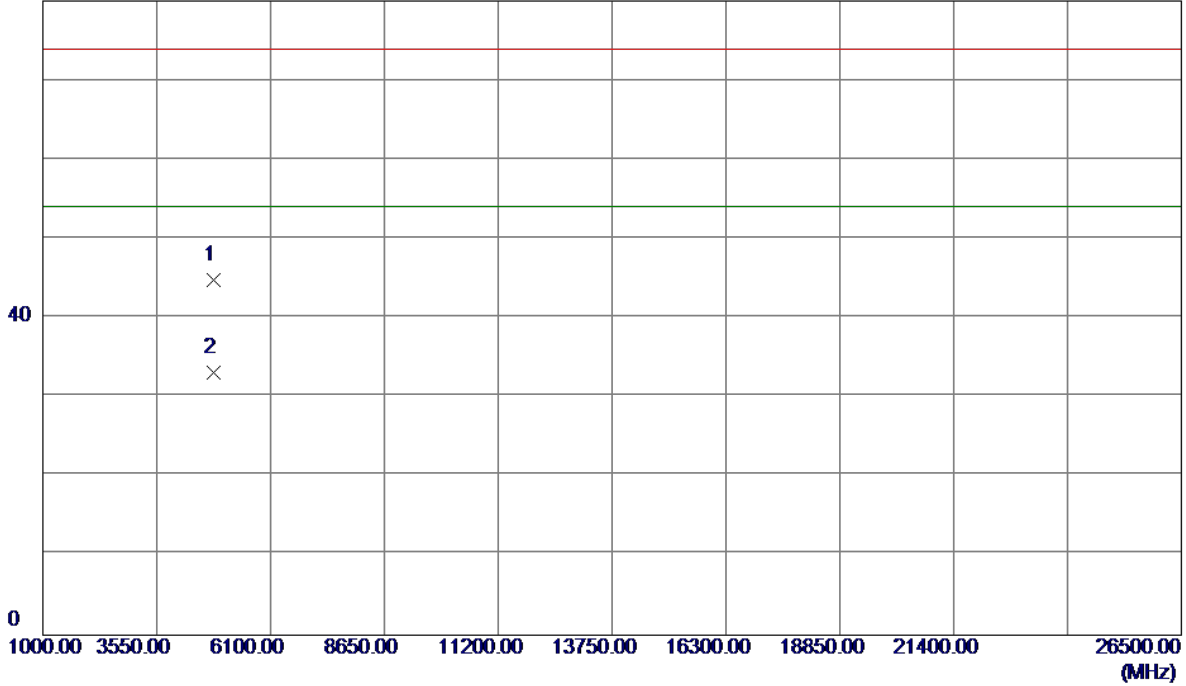

No.	Freq. MHz	Reading Level dBuV/m	Correct Factor dB	Measure ment dBuV/m	Limit dBuV/m	Margin dB	Detector	Comment
1	4824.1250	38.10	6.66	44.76	74.00	-29.24	Peak	
2 *	4824.2120	26.44	6.66	33.10	54.00	-20.90	AVG	

Orthogonal Axis :	X
Test Mode :	TX G MODE 2437MHz

**Vertical**

120 dBuV/m

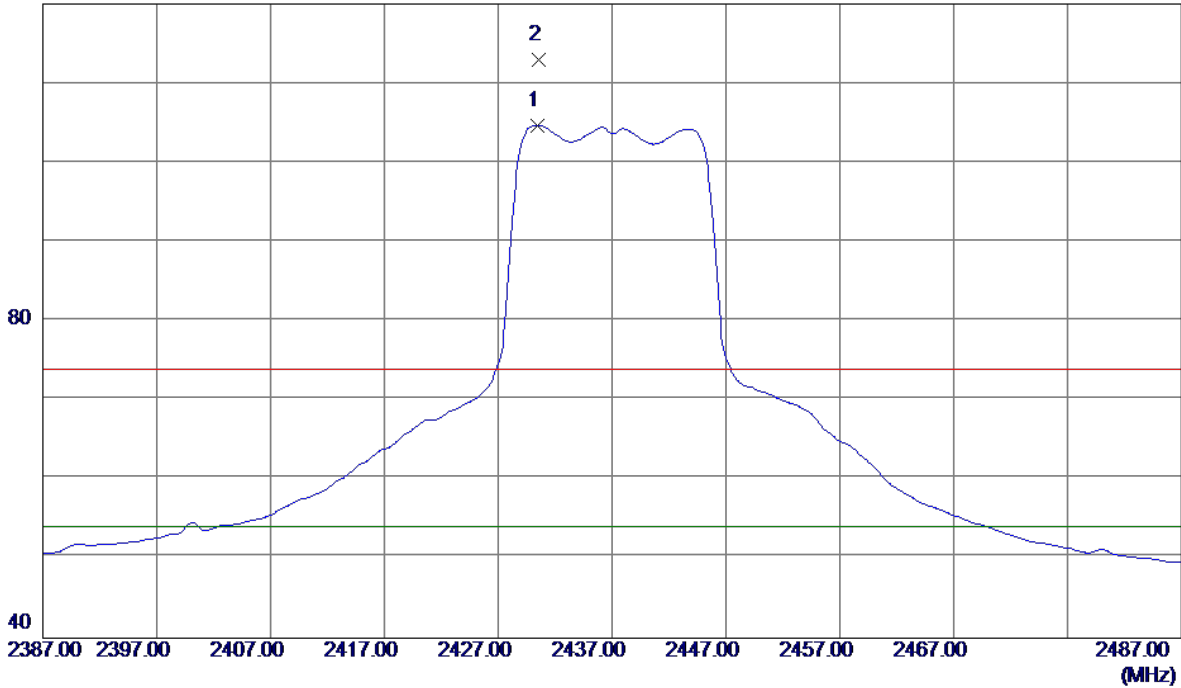

No.	Freq. MHz	Reading Level dBuV/m	Correct Factor dB	Measure ment dBuV/m	Limit dBuV/m	Margin dB	Detector	Comment
1 *	2430.4000	71.48	33.21	104.69	54.00	50.69	AVG	No Limit
2	2430.6000	79.79	33.21	113.00	74.00	39.00	Peak	No Limit

Orthogonal Axis :	X
Test Mode :	TX G MODE 2437MHz

**Vertical**

80 dBuV/m

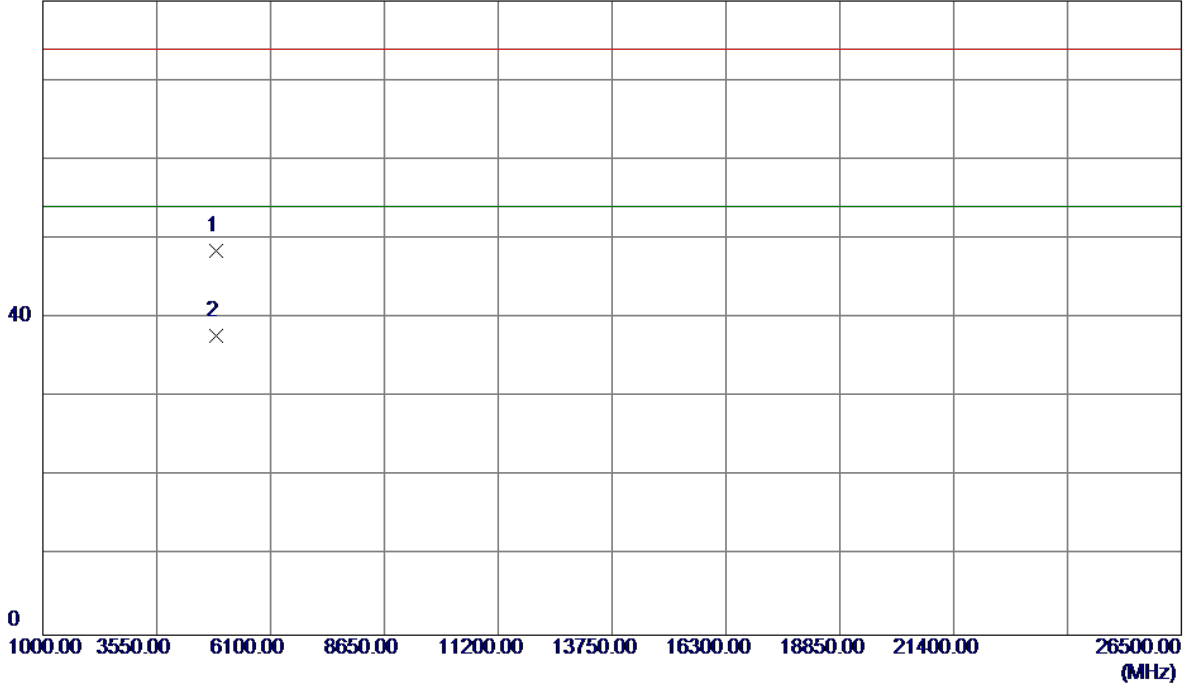

No.	Freq. MHz	Reading Level dBuV/m	Correct Factor dB	Measure ment dBuV/m	Limit dBuV/m	Margin dB	Detector	Comment
1	4874.1349	41.61	6.84	48.45	74.00	-25.55	Peak	
2 *	4874.2200	30.95	6.84	37.79	54.00	-16.21	AVG	



Orthogonal Axis :	X
Test Mode :	TX G MODE 2437MHz

**Horizontal**

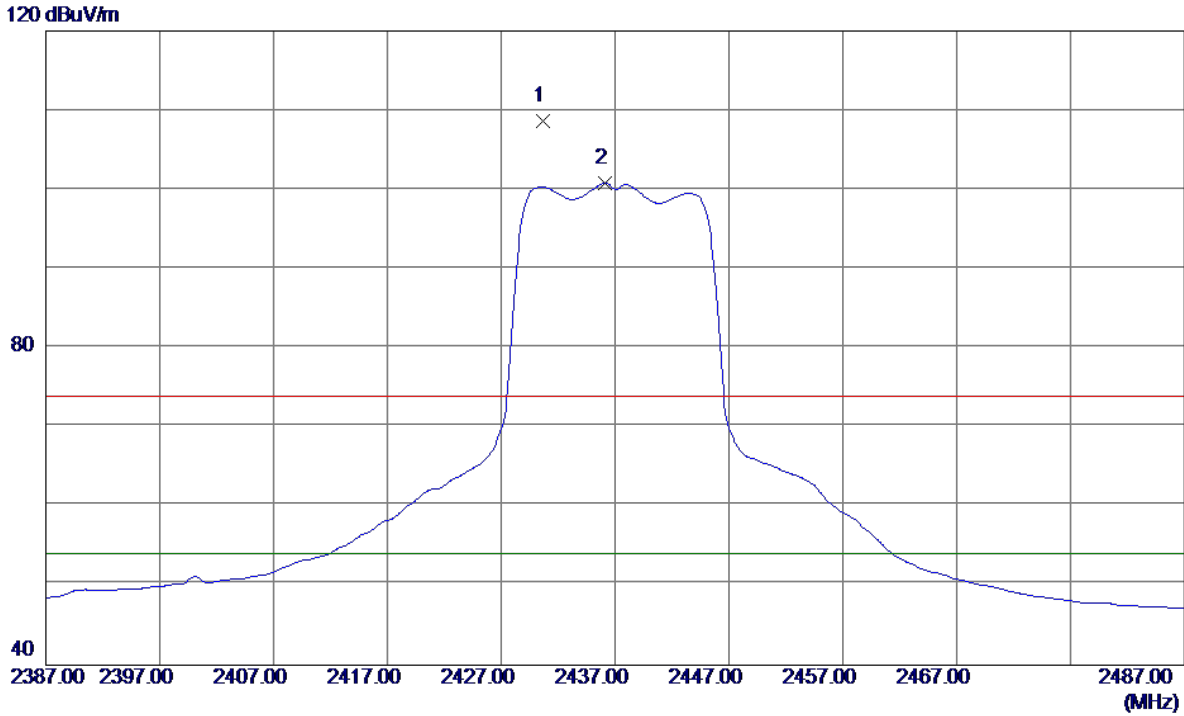

No.	Freq. MHz	Reading Level dBuV/m	Correct Factor dB	Measure ment dBuV/m	Limit dBuV/m	Margin dB	Detector	Comment
1	2430.7000	75.48	33.21	108.69	74.00	34.69	Peak	No Limit
2 *	2436.1000	67.61	33.23	100.84	54.00	46.84	AVG	No Limit

Orthogonal Axis :	X
Test Mode :	TX G MODE 2437MHz

**Horizontal**

80 dBuV/m

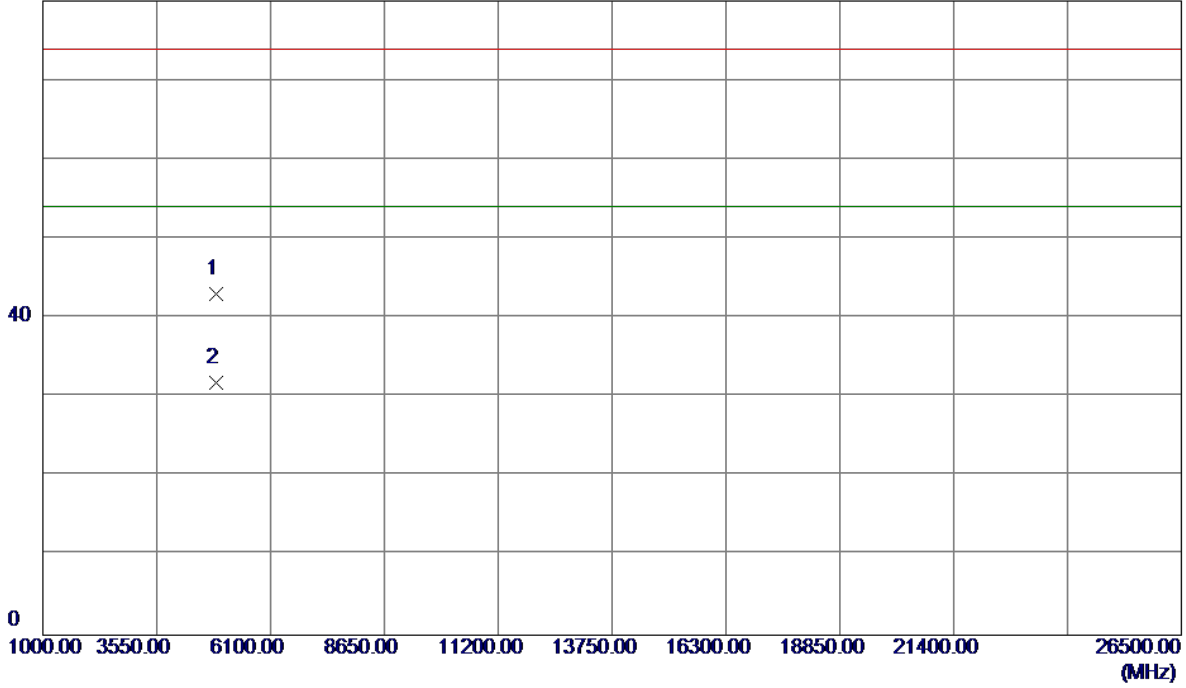

No.	Freq. MHz	Reading Level dBuV/m	Correct Factor dB	Measure ment dBuV/m	Limit dBuV/m	Margin dB	Detector	Comment
1	4873.9540	36.23	6.84	43.07	74.00	-30.93	Peak	
2 *	4874.1850	24.94	6.84	31.78	54.00	-22.22	AVG	

Orthogonal Axis :	X
Test Mode :	TX G MODE 2462MHz

**Vertical**

120 dBuV/m

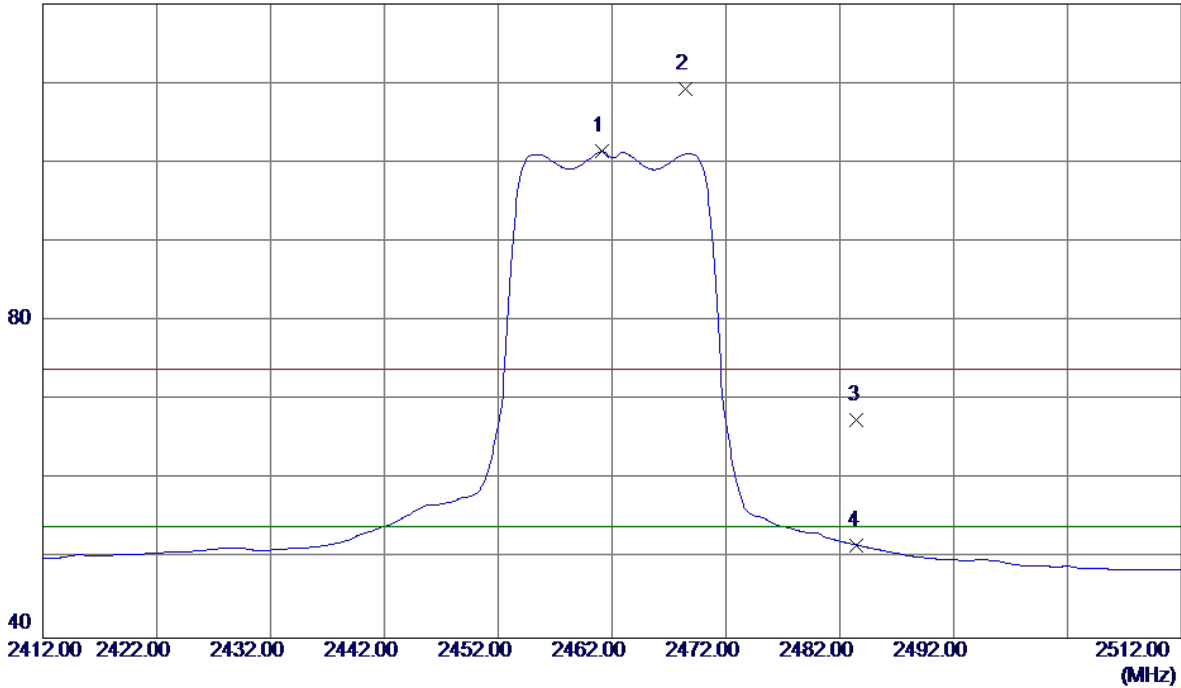

No.	Freq. MHz	Reading Level dBuV/m	Correct Factor dB	Measure ment dBuV/m	Limit dBuV/m	Margin dB	Detector	Comment
1 *	2461.1000	68.05	33.32	101.37	54.00	47.37	AVG	No Limit
2	2468.4000	75.91	33.35	109.26	74.00	35.26	Peak	No Limit
3	2483.5000	34.05	33.41	67.46	74.00	-6.54	Peak	
4	2483.5000	18.34	33.41	51.75	54.00	-2.25	AVG	

Orthogonal Axis :	X
Test Mode :	TX G MODE 2462MHz

**Vertical**

80 dBuV/m

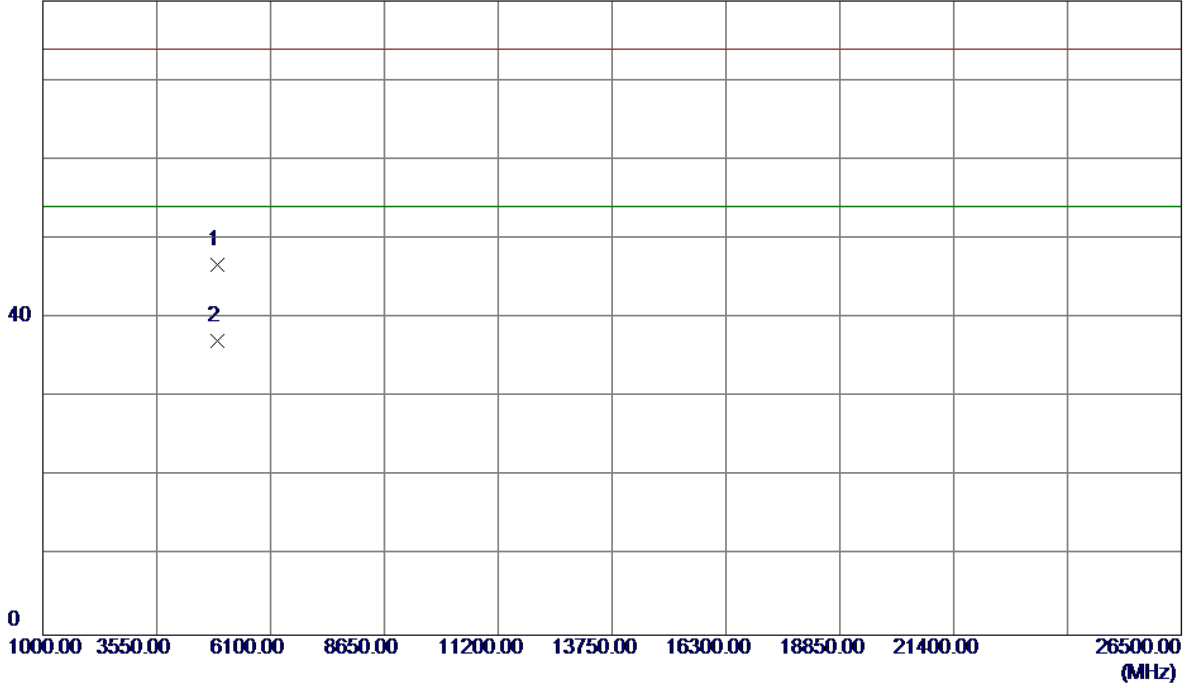

No.	Freq. MHz	Reading Level dBuV/m	Correct Factor dB	Measure ment dBuV/m	Limit dBuV/m	Margin dB	Detector	Comment
1	4920.9200	39.66	7.01	46.67	74.00	-27.33	Peak	
2 *	4924.0400	30.16	7.02	37.18	54.00	-16.82	AVG	

Orthogonal Axis :	X
Test Mode :	TX G MODE 2462MHz

### Horizontal

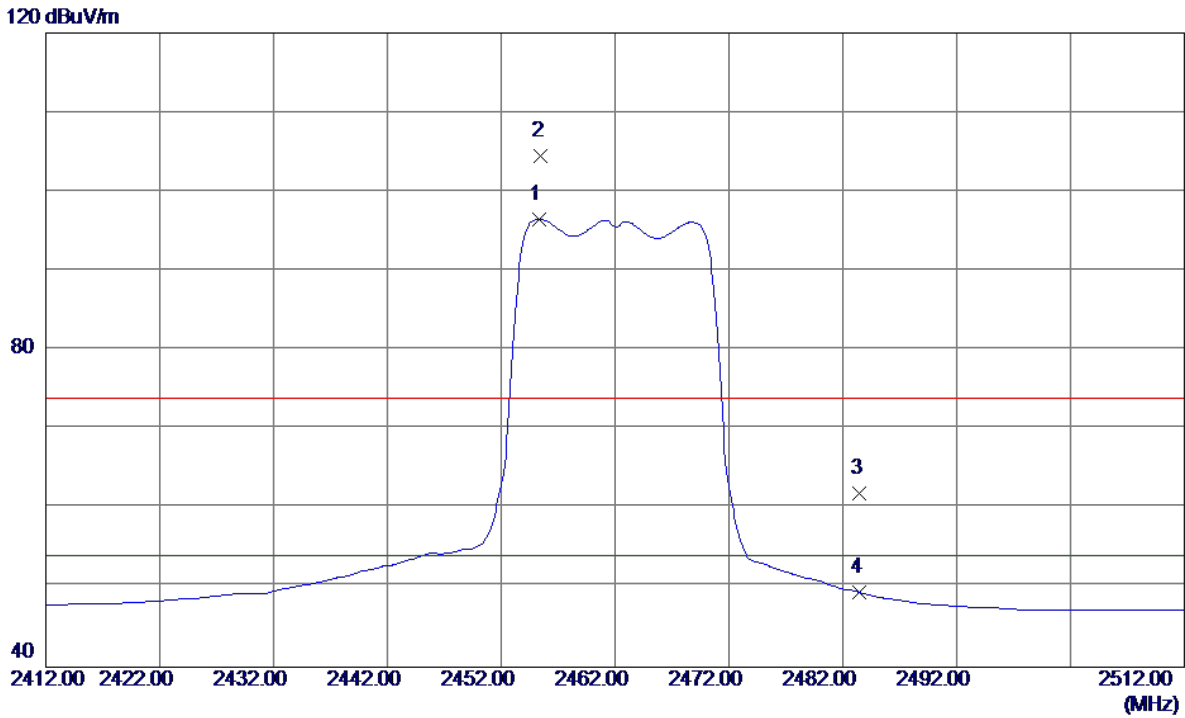

No.	Freq. MHz	Reading Level dBuV/m	Correct Factor dB	Measure ment dBuV/m	Limit dBuV/m	Margin dB	Detector	Comment
1 *	2455.3000	63.20	33.30	96.50	54.00	42.50	AVG	No Limit
2	2455.5000	71.22	33.30	104.52	74.00	30.52	Peak	No Limit
3	2483.5000	28.57	33.41	61.98	74.00	-12.02	Peak	
4	2483.5000	16.01	33.41	49.42	54.00	-4.58	AVG	

Orthogonal Axis :	X
Test Mode :	TX G MODE 2462MHz

**Horizontal**

80 dBuV/m

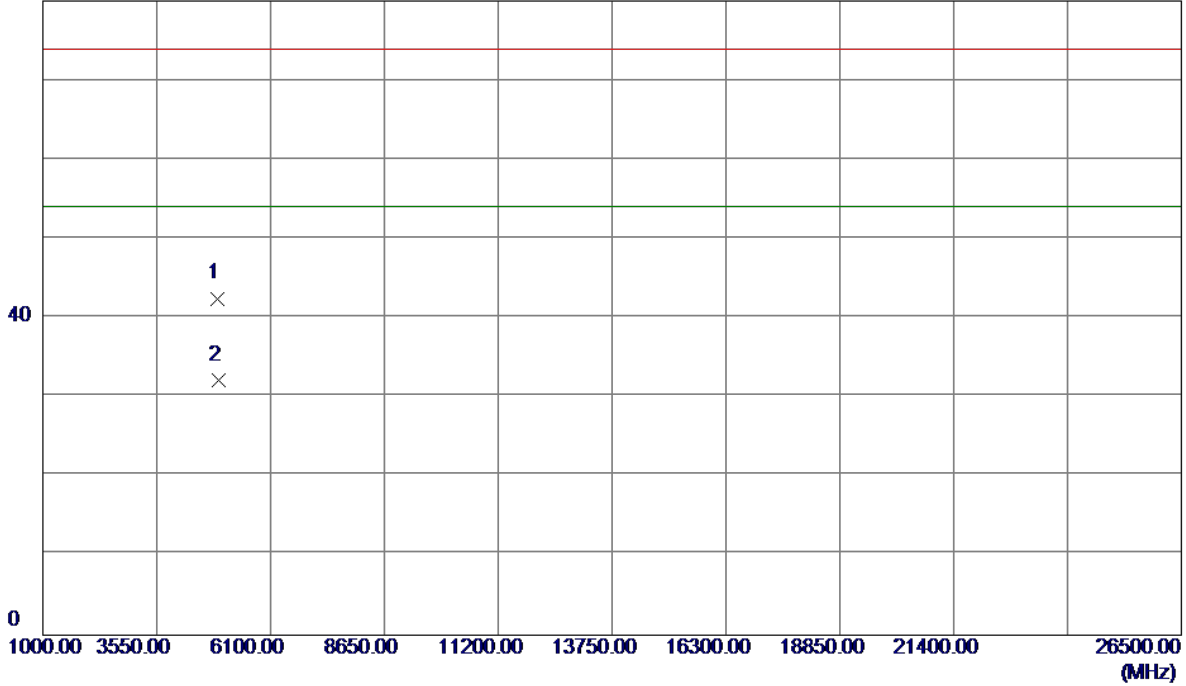

No.	Freq. MHz	Reading Level dBuV/m	Correct Factor dB	Measure ment dBuV/m	Limit dBuV/m	Margin dB	Detector	Comment
1	4923.7980	35.46	7.02	42.48	74.00	-31.52	Peak	
2 *	4924.3480	25.18	7.02	32.20	54.00	-21.80	AVG	

Orthogonal Axis :	X
Test Mode :	TX N-20M MODE 2412MHz

**Vertical**

120 dBuV/m

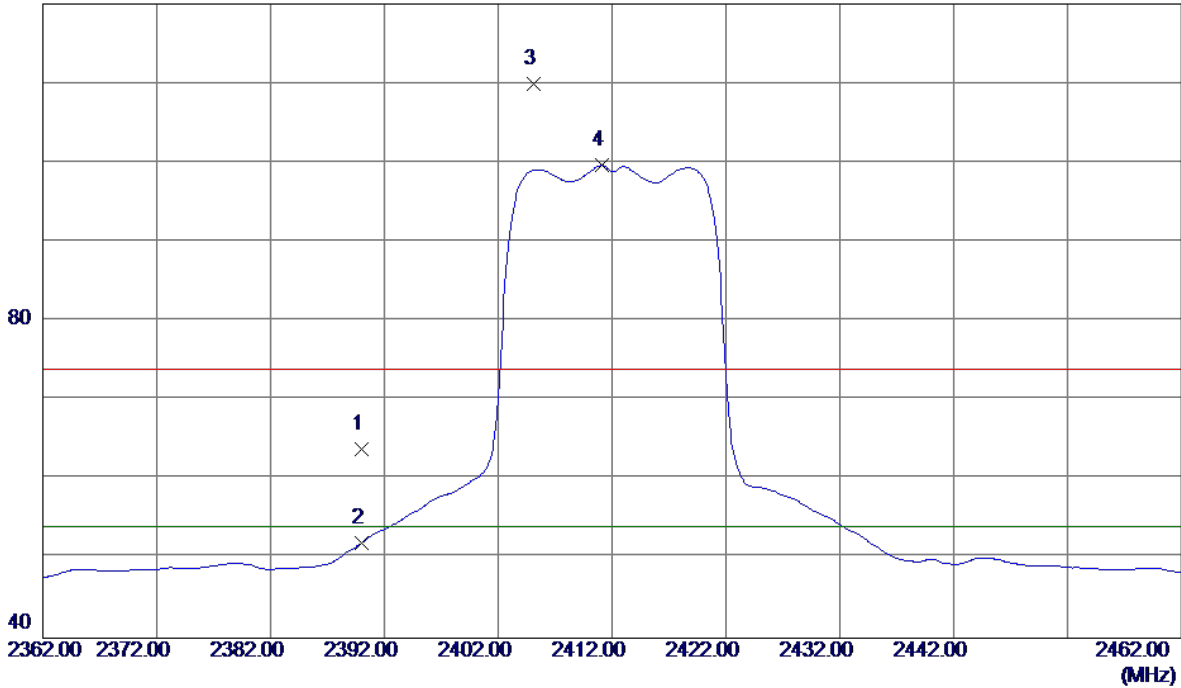

No.	Freq. MHz	Reading Level dBuV/m	Correct Factor dB	Measure ment dBuV/m	Limit dBuV/m	Margin dB	Detector	Comment
1	2390.0000	30.74	33.06	63.80	74.00	-10.20	Peak	
2	2390.0000	18.97	33.06	52.03	54.00	-1.97	AVG	
3	2405.1000	76.78	33.11	109.89	74.00	35.89	Peak	No Limit
4 *	2411.1000	66.49	33.14	99.63	54.00	45.63	AVG	No Limit

Orthogonal Axis :	X
Test Mode :	TX N-20M MODE 2412MHz

**Vertical**

80 dBuV/m

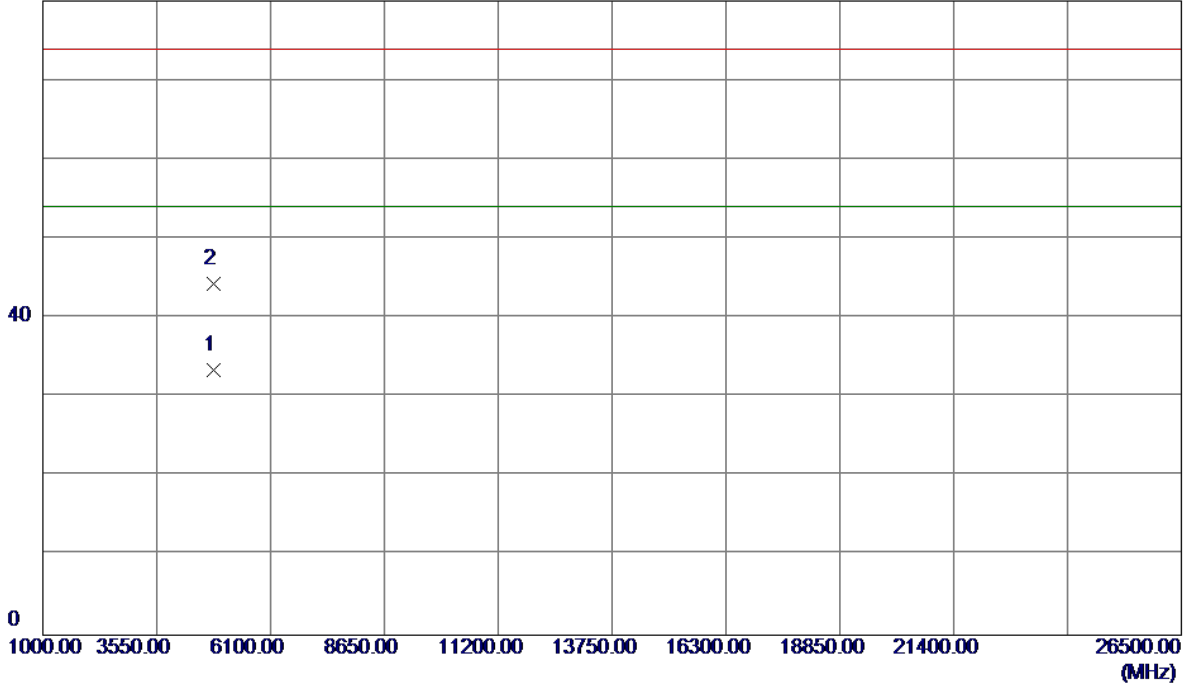

No.	Freq. MHz	Reading Level dBuV/m	Correct Factor dB	Measure ment dBuV/m	Limit dBuV/m	Margin dB	Detector	Comment
1 *	4824.6900	26.76	6.66	33.42	54.00	-20.58	AVG	
2	4829.1800	37.66	6.68	44.34	74.00	-29.66	Peak	



Orthogonal Axis :	X
Test Mode :	TX N-20M MODE 2412MHz

### Horizontal

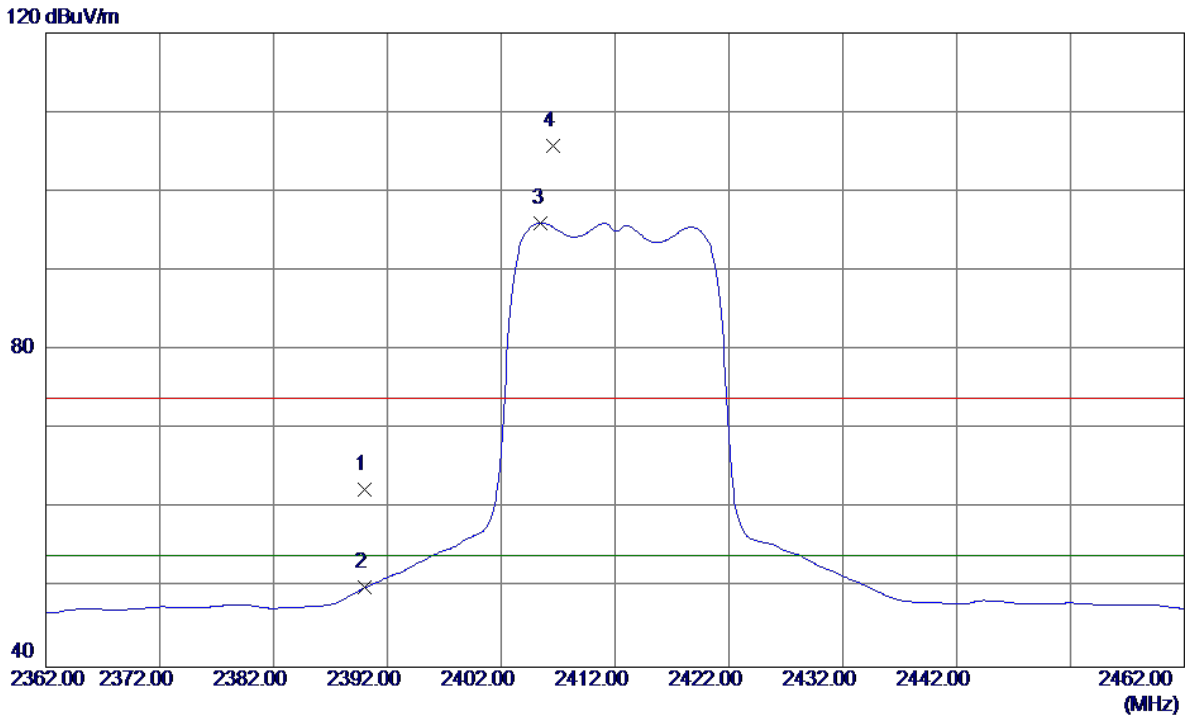

No.	Freq. MHz	Reading Level dBuV/m	Correct Factor dB	Measure ment dBuV/m	Limit dBuV/m	Margin dB	Detector	Comment
1	2390.0000	29.29	33.06	62.35	74.00	-11.65	Peak	
2	2390.0000	16.95	33.06	50.01	54.00	-3.99	AVG	
3 *	2405.5000	62.91	33.11	96.02	54.00	42.02	AVG	No Limit
4	2406.6000	72.58	33.12	105.70	74.00	31.70	Peak	No Limit

Orthogonal Axis :	X
Test Mode :	TX N-20M MODE 2412MHz

**Horizontal**

80 dBuV/m

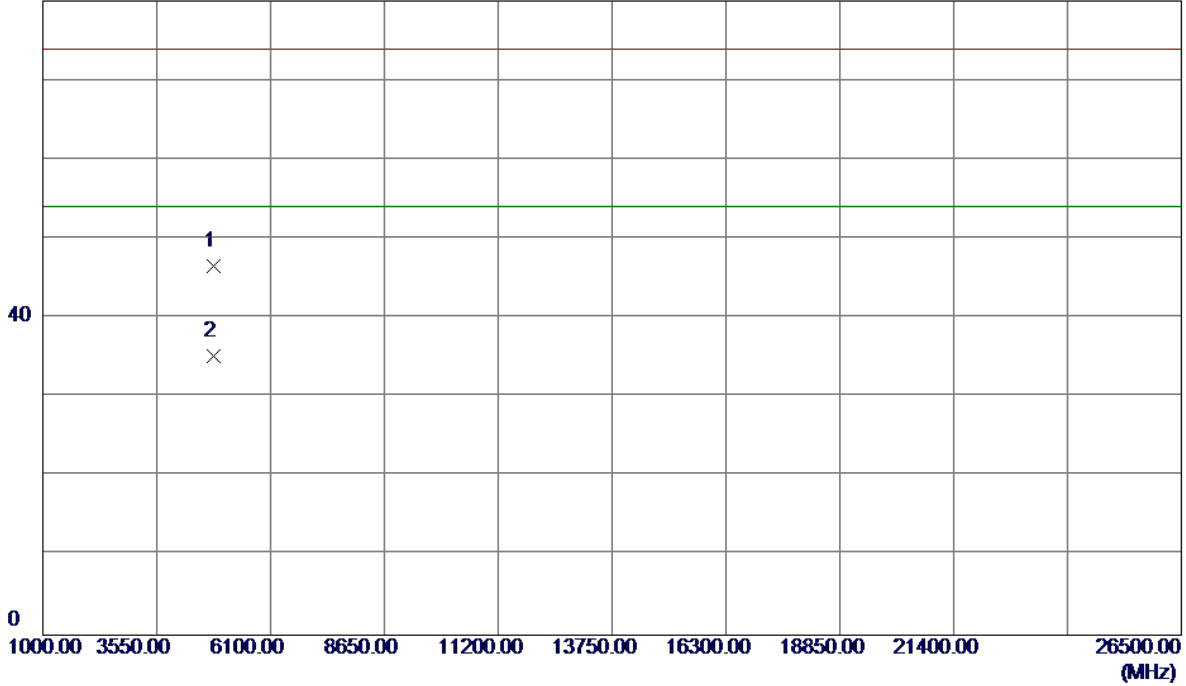

No.	Freq. MHz	Reading Level dBuV/m	Correct Factor dB	Measure ment dBuV/m	Limit dBuV/m	Margin dB	Detector	Comment
1	4823.9580	39.97	6.66	46.63	74.00	-27.37	Peak	
2 *	4824.4570	28.61	6.66	35.27	54.00	-18.73	AVG	

Orthogonal Axis :	X
Test Mode :	TX N-20M MODE 2437MHz

**Vertical**

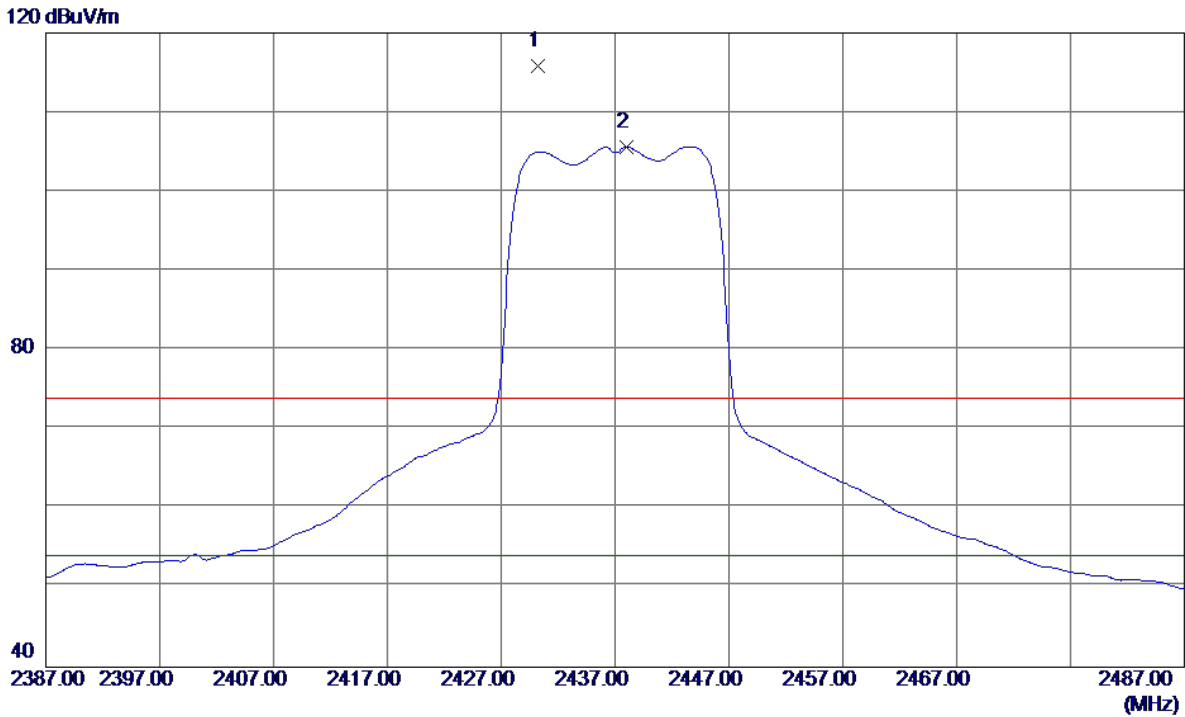

No.	Freq. MHz	Reading Level dBuV/m	Correct Factor dB	Measure ment dBuV/m	Limit dBuV/m	Margin dB	Detector	Comment
1	2430.2000	82.57	33.21	115.78	74.00	41.78	Peak	No Limit
2 *	2438.0000	72.43	33.24	105.67	54.00	51.67	AVG	No Limit

Orthogonal Axis :	X
Test Mode :	TX N-20M MODE 2437MHz

**Vertical**

80 dBuV/m

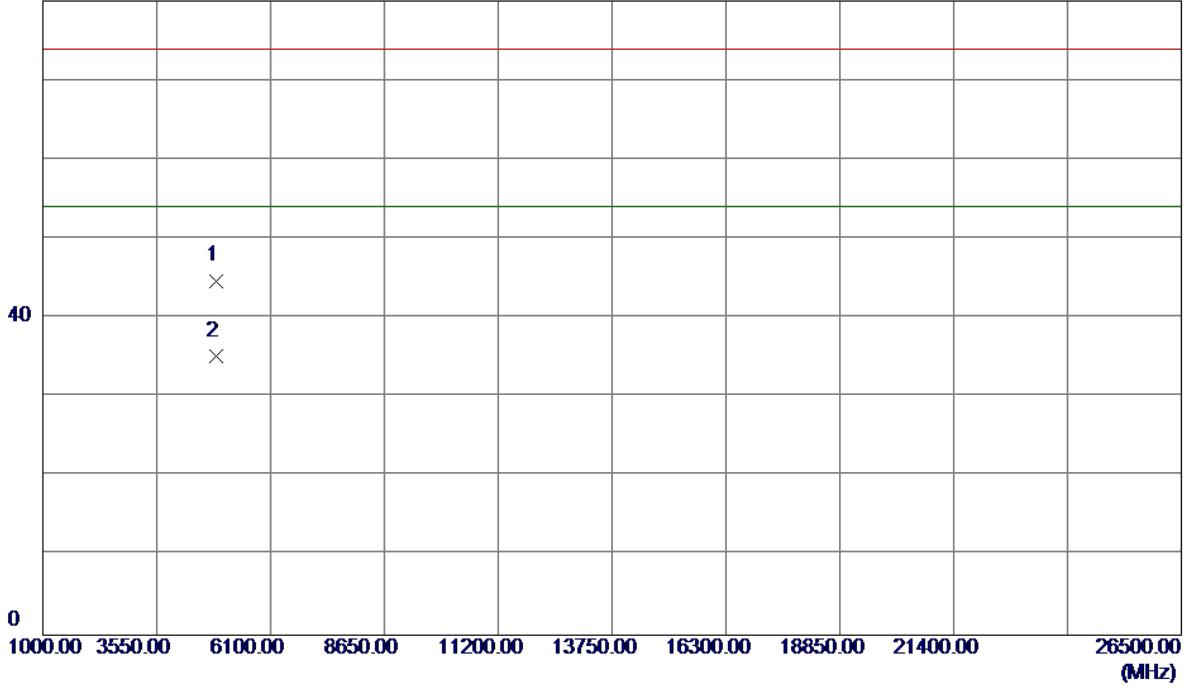

No.	Freq. MHz	Reading Level dBuV/m	Correct Factor dB	Measure ment dBuV/m	Limit dBuV/m	Margin dB	Detector	Comment
1	4873.9000	37.88	6.84	44.72	74.00	-29.28	Peak	
2 *	4874.5600	28.38	6.84	35.22	54.00	-18.78	AVG	

Orthogonal Axis :	X
Test Mode :	TX N-20M MODE 2437MHz

### Horizontal

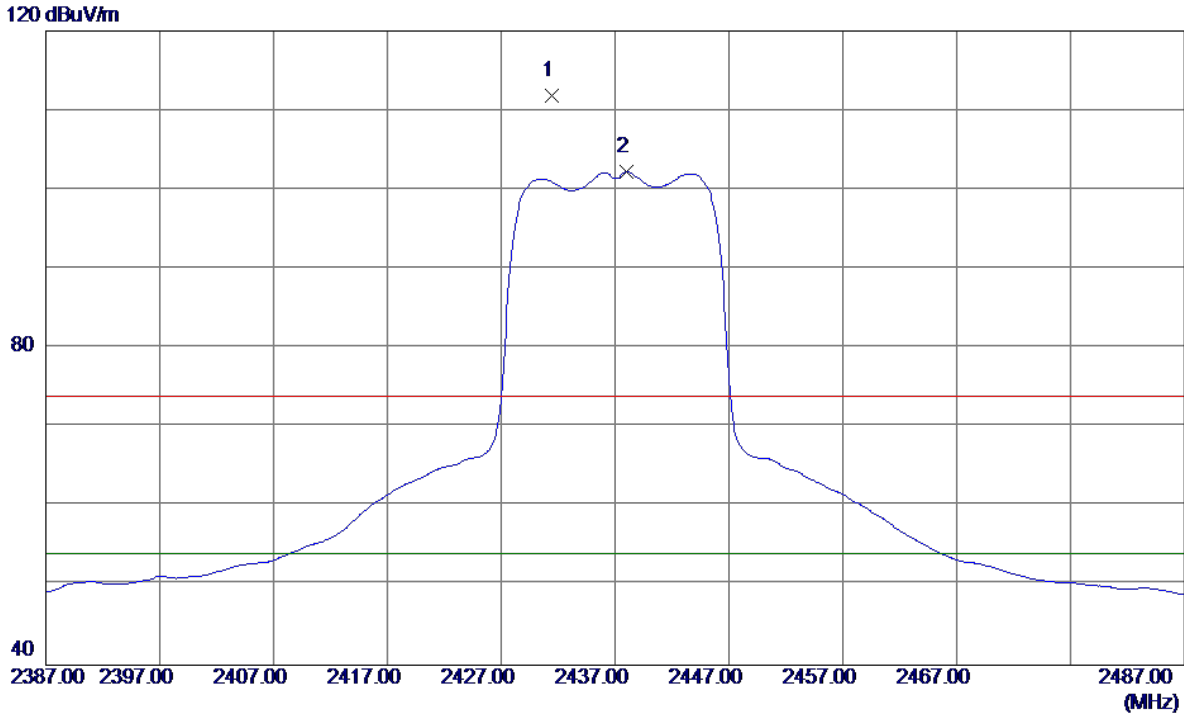

No.	Freq. MHz	Reading Level dBuV/m	Correct Factor dB	Measure ment dBuV/m	Limit dBuV/m	Margin dB	Detector	Comment
1	2431.4000	78.69	33.21	111.90	74.00	37.90	Peak	No Limit
2 *	2438.0000	68.96	33.24	102.20	54.00	48.20	AVG	No Limit

Orthogonal Axis :	X
Test Mode :	TX N-20M MODE 2437MHz

**Horizontal**

80 dBuV/m

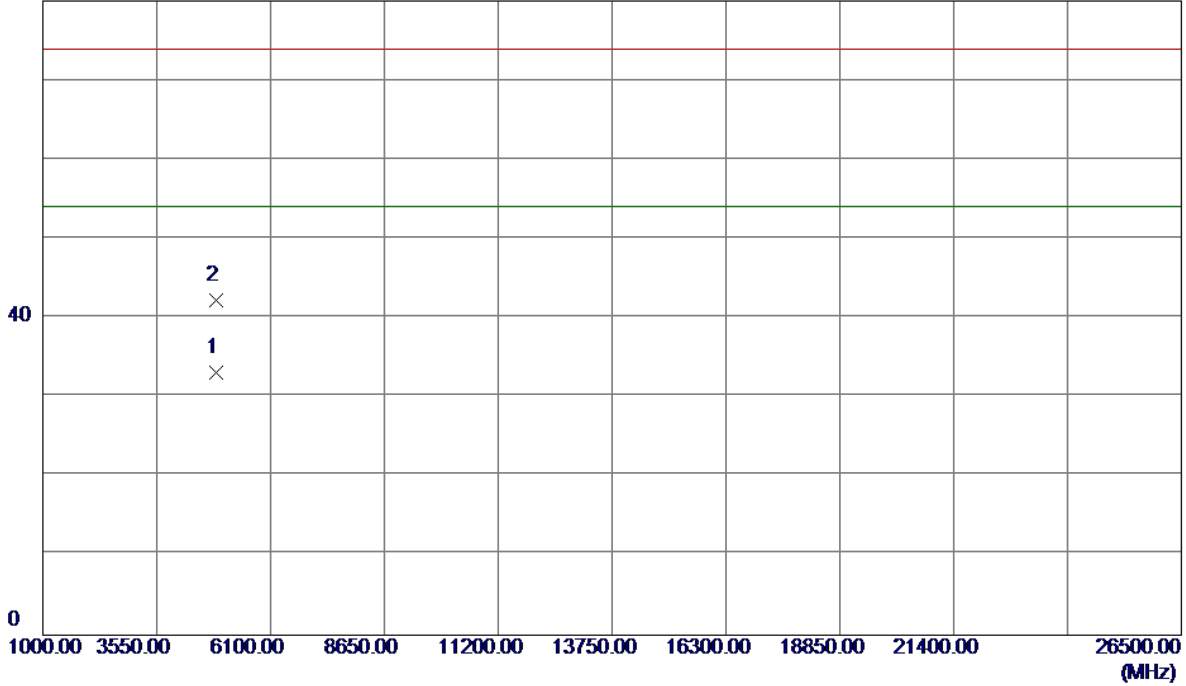

No.	Freq. MHz	Reading Level dBuV/m	Correct Factor dB	Measure ment dBuV/m	Limit dBuV/m	Margin dB	Detector	Comment
1 *	4874.4000	26.33	6.84	33.17	54.00	-20.83	AVG	
2	4877.2500	35.46	6.85	42.31	74.00	-31.69	Peak	

Orthogonal Axis :	X
Test Mode :	TX N-20M MODE 2462MHz

**Vertical**

120 dBuV/m

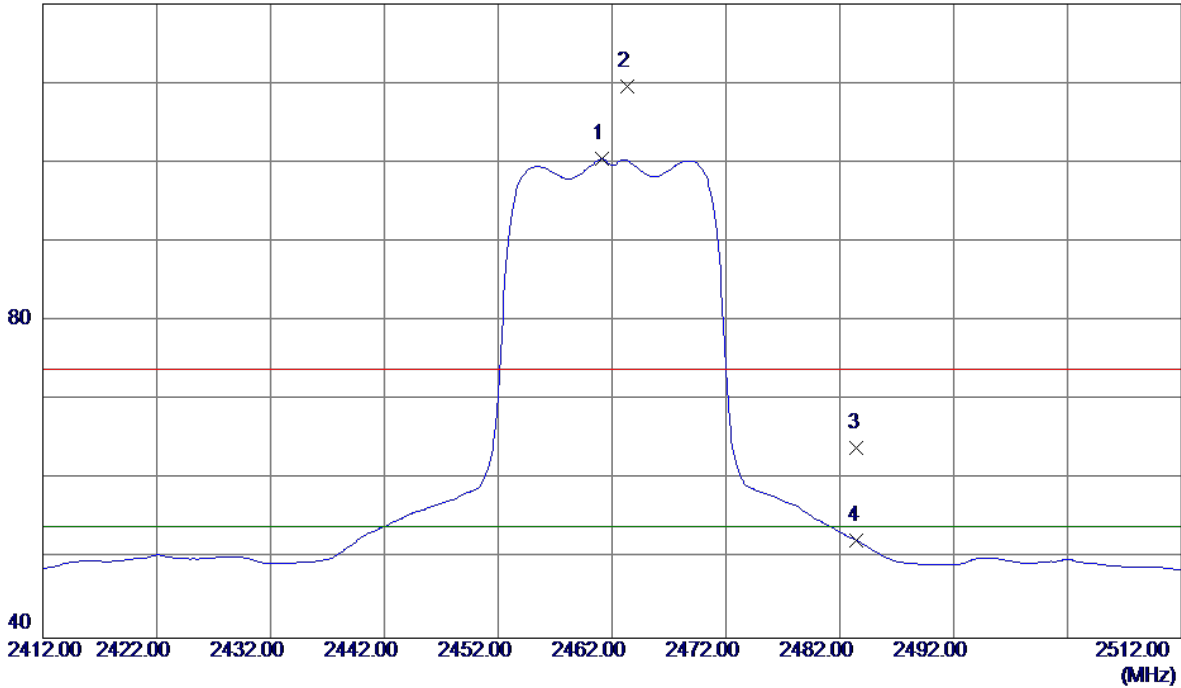

No.	Freq. MHz	Reading Level dBuV/m	Correct Factor dB	Measure ment dBuV/m	Limit dBuV/m	Margin dB	Detector	Comment
1 *	2461.1000	67.09	33.32	100.41	54.00	46.41	AVG	No Limit
2	2463.3000	76.28	33.33	109.61	74.00	35.61	Peak	No Limit
3	2483.5000	30.55	33.41	63.96	74.00	-10.04	Peak	
4	2483.5000	18.91	33.41	52.32	54.00	-1.68	AVG	

Orthogonal Axis :	X
Test Mode :	TX N-20M MODE 2462MHz

**Vertical**

80 dBuV/m

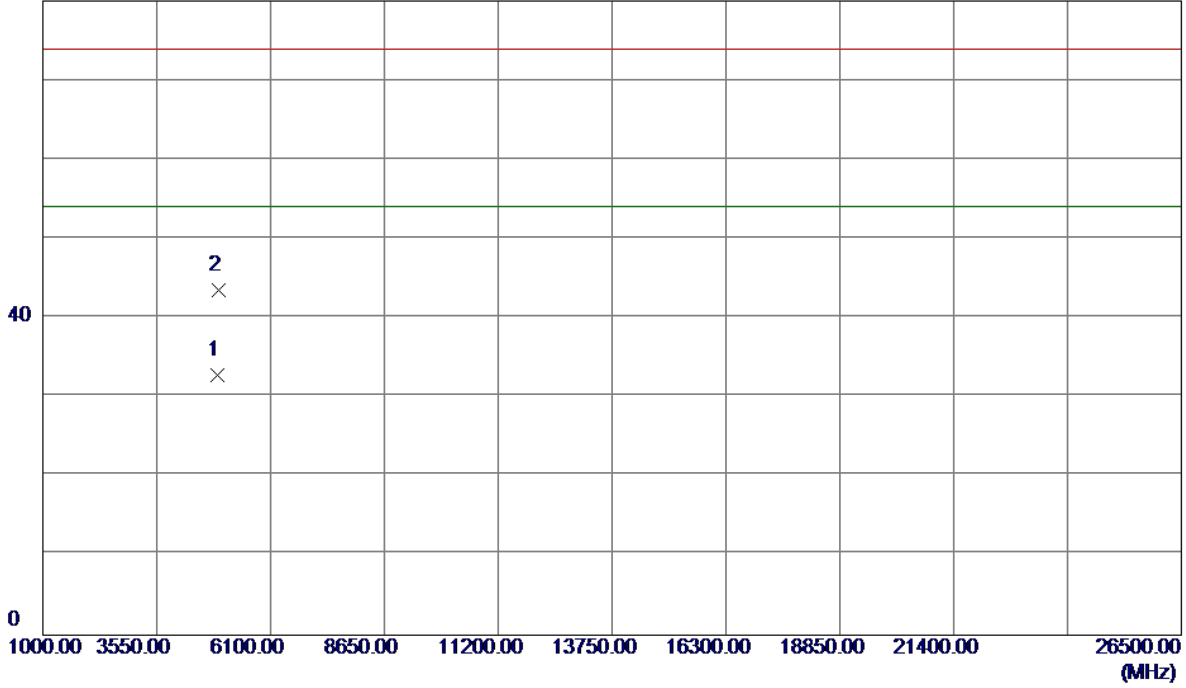

No.	Freq. MHz	Reading Level dBuV/m	Correct Factor dB	Measure ment dBuV/m	Limit dBuV/m	Margin dB	Detector	Comment
1 *	4922.8600	25.76	7.01	32.77	54.00	-21.23	AVG	
2	4928.8800	36.53	7.03	43.56	74.00	-30.44	Peak	



Orthogonal Axis :	X
Test Mode :	TX N-20M MODE 2462MHz

### Horizontal

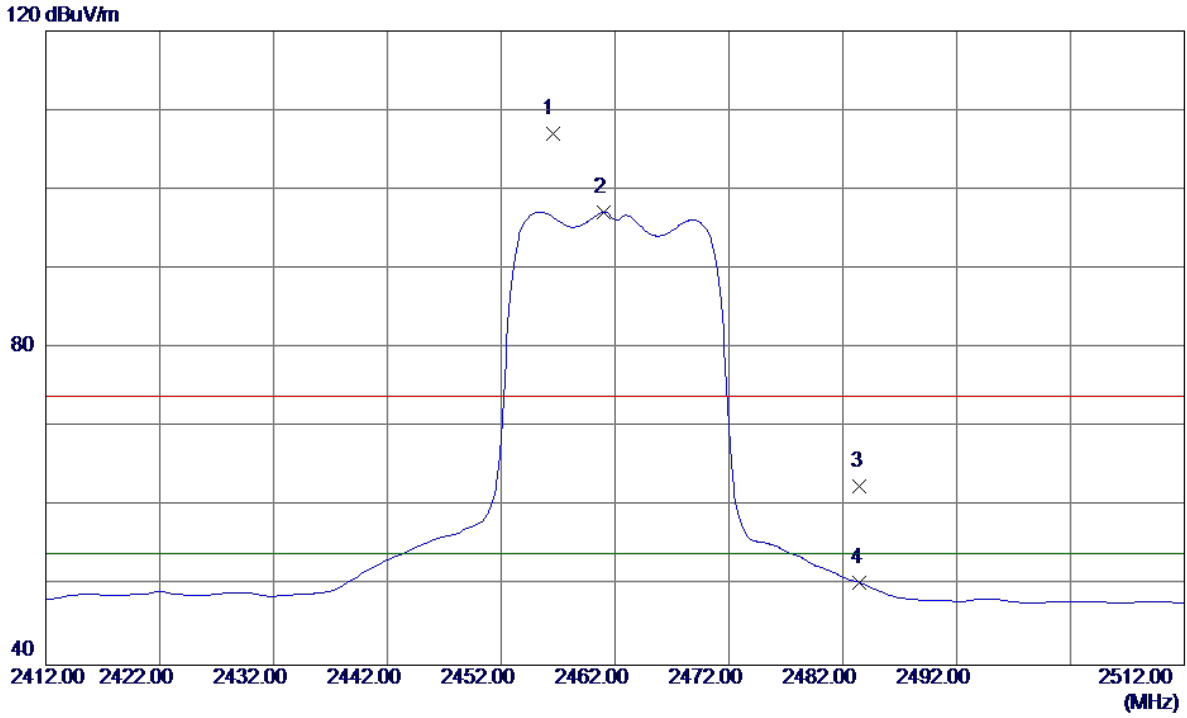

No.	Freq. MHz	Reading Level dBuV/m	Correct Factor dB	Measure ment dBuV/m	Limit dBuV/m	Margin dB	Detector	Comment
1	2456.5000	73.67	33.31	106.98	74.00	32.98	Peak	No Limit
2 *	2461.0000	63.84	33.32	97.16	54.00	43.16	AVG	No Limit
3	2483.5000	29.12	33.41	62.53	74.00	-11.47	Peak	
4	2483.5000	16.97	33.41	50.38	54.00	-3.62	AVG	

Orthogonal Axis :	X
Test Mode :	TX N-20M MODE 2462MHz

**Horizontal**

80 dBuV/m

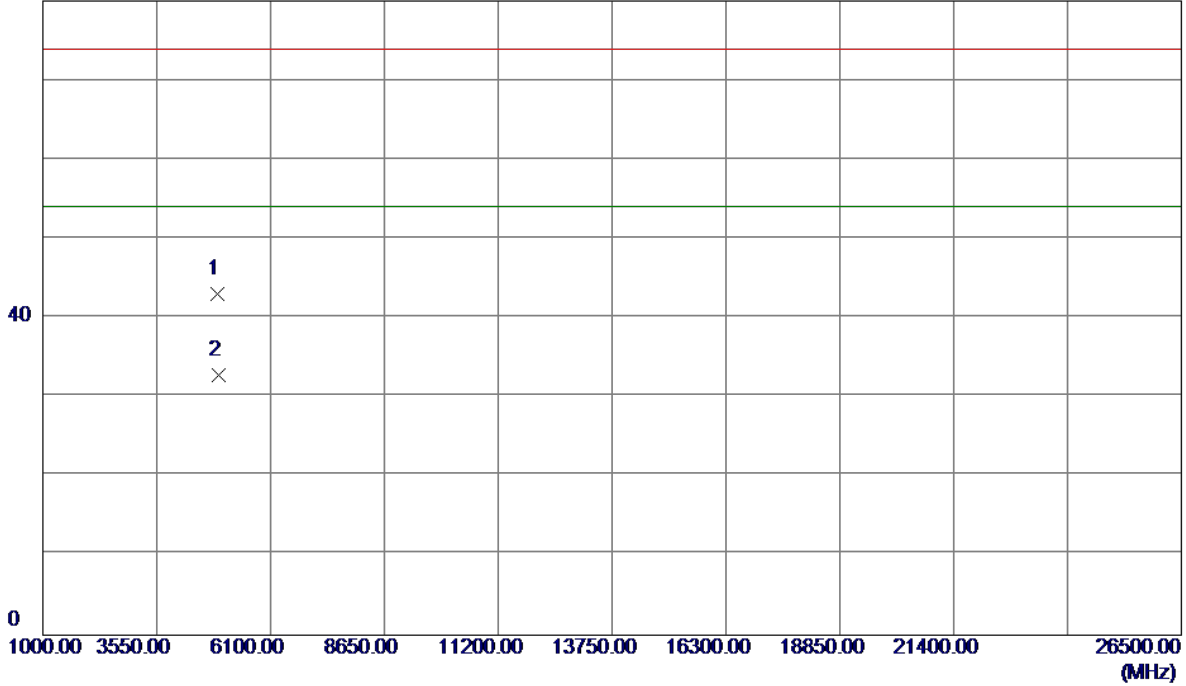

No.	Freq. MHz	Reading Level dBuV/m	Correct Factor dB	Measure ment dBuV/m	Limit dBuV/m	Margin dB	Detector	Comment
1	4916.8500	36.08	6.99	43.07	74.00	-30.93	Peak	
2 *	4925.4000	25.82	7.02	32.84	54.00	-21.16	AVG	

Orthogonal Axis :	X
Test Mode :	TX N-40M MODE 2422MHz

**Vertical**

120 dBuV/m

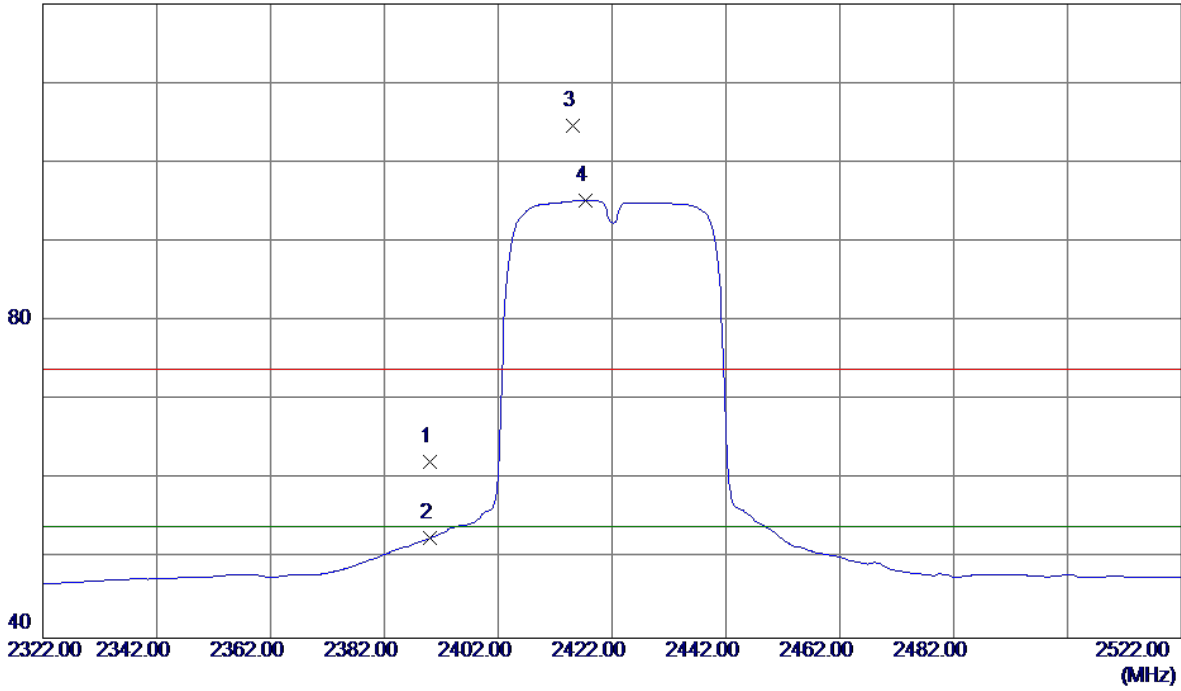

No.	Freq. MHz	Reading Level dBuV/m	Correct Factor dB	Measure ment dBuV/m	Limit dBuV/m	Margin dB	Detector	Comment
1	2390.0000	29.11	33.06	62.17	74.00	-11.83	Peak	
2	2390.0000	19.53	33.06	52.59	54.00	-1.41	AVG	
3	2415.2000	71.50	33.15	104.65	74.00	30.65	Peak	No Limit
4 *	2417.4000	62.10	33.16	95.26	54.00	41.26	AVG	No Limit

Orthogonal Axis :	X
Test Mode :	TX N-40M MODE 2422MHz

**Vertical**

80 dBuV/m

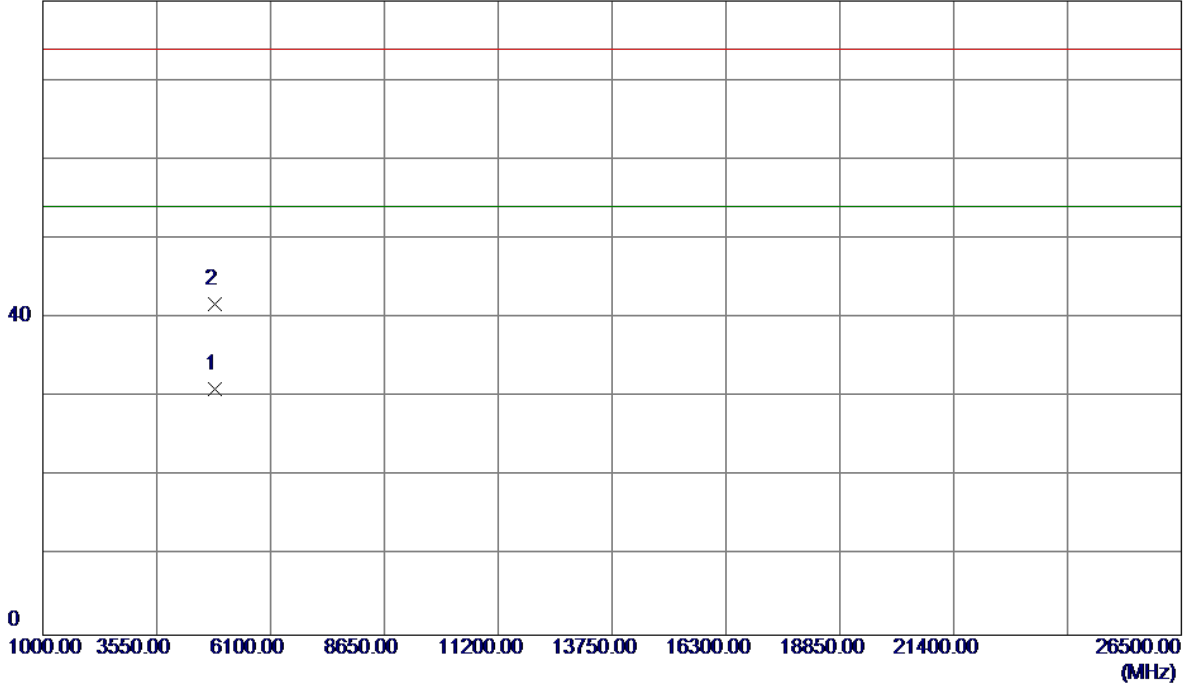

No.	Freq. MHz	Reading Level dBuV/m	Correct Factor dB	Measure ment dBuV/m	Limit dBuV/m	Margin dB	Detector	Comment
1 *	4843.1000	24.29	6.73	31.02	54.00	-22.98	AVG	
2	4843.6000	35.09	6.73	41.82	74.00	-32.18	Peak	

Orthogonal Axis :	X
Test Mode :	TX N-40M MODE 2422MHz

### Horizontal

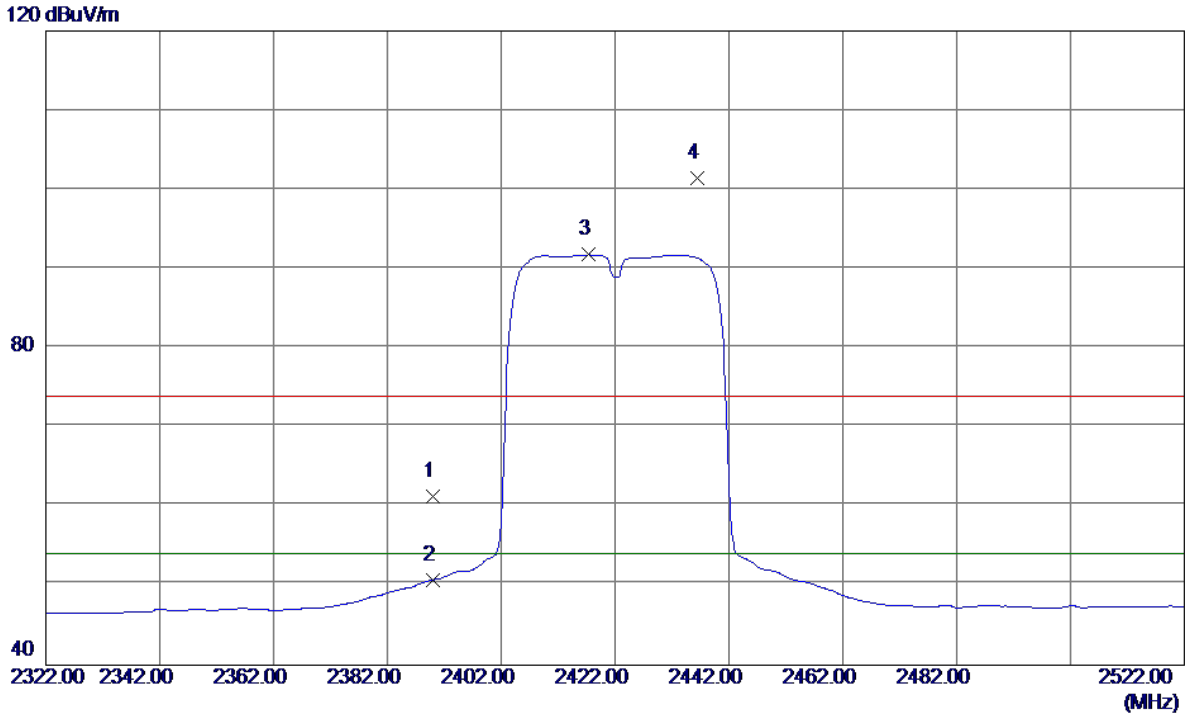

No.	Freq. MHz	Reading Level dBuV/m	Correct Factor dB	Measure ment dBuV/m	Limit dBuV/m	Margin dB	Detector	Comment
1	2390.0000	28.25	33.06	61.31	74.00	-12.69	Peak	
2	2390.0000	17.68	33.06	50.74	54.00	-3.26	AVG	
3 *	2417.4000	58.61	33.16	91.77	54.00	37.77	AVG	No Limit
4	2436.4000	68.17	33.23	101.40	74.00	27.40	Peak	No Limit

Orthogonal Axis :	X
Test Mode :	TX N-40M MODE 2422MHz

**Horizontal**

80 dBuV/m

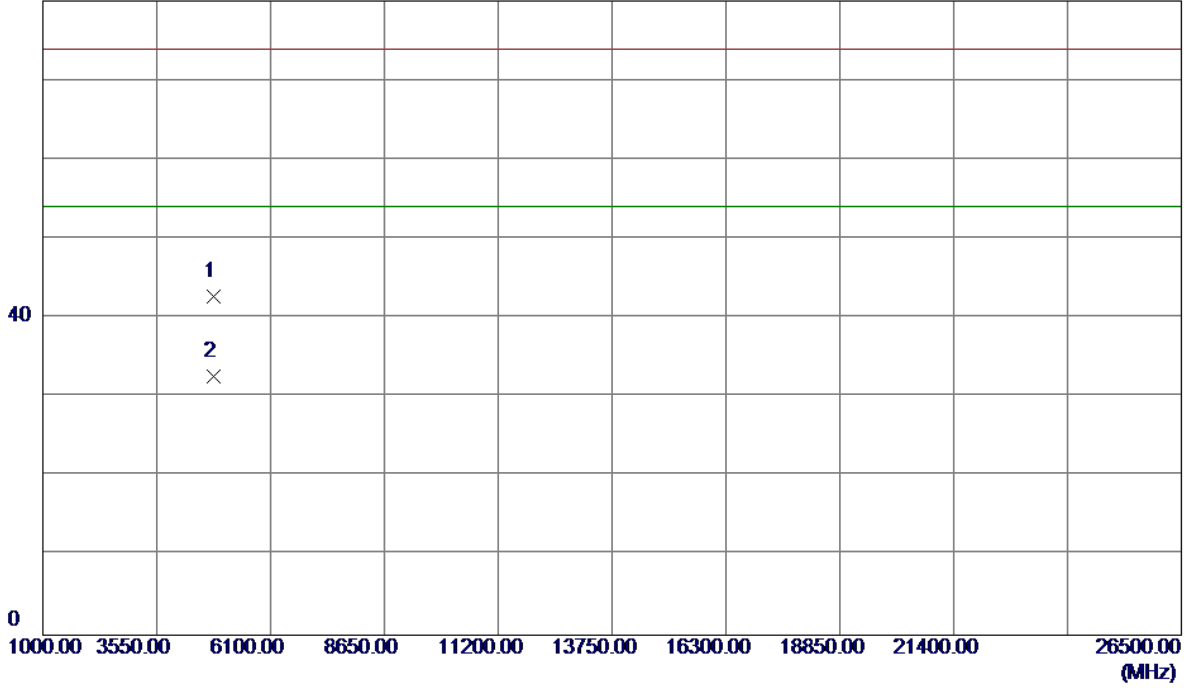

No.	Freq. MHz	Reading Level dBuV/m	Correct Factor dB	Measure ment dBuV/m	Limit dBuV/m	Margin dB	Detector	Comment
1	4834.5000	36.06	6.70	42.76	74.00	-31.24	Peak	
2 *	4838.5500	25.87	6.71	32.58	54.00	-21.42	AVG	

Orthogonal Axis :	X
Test Mode :	TX N-40M MODE 2437MHz

**Vertical**

120 dBuV/m

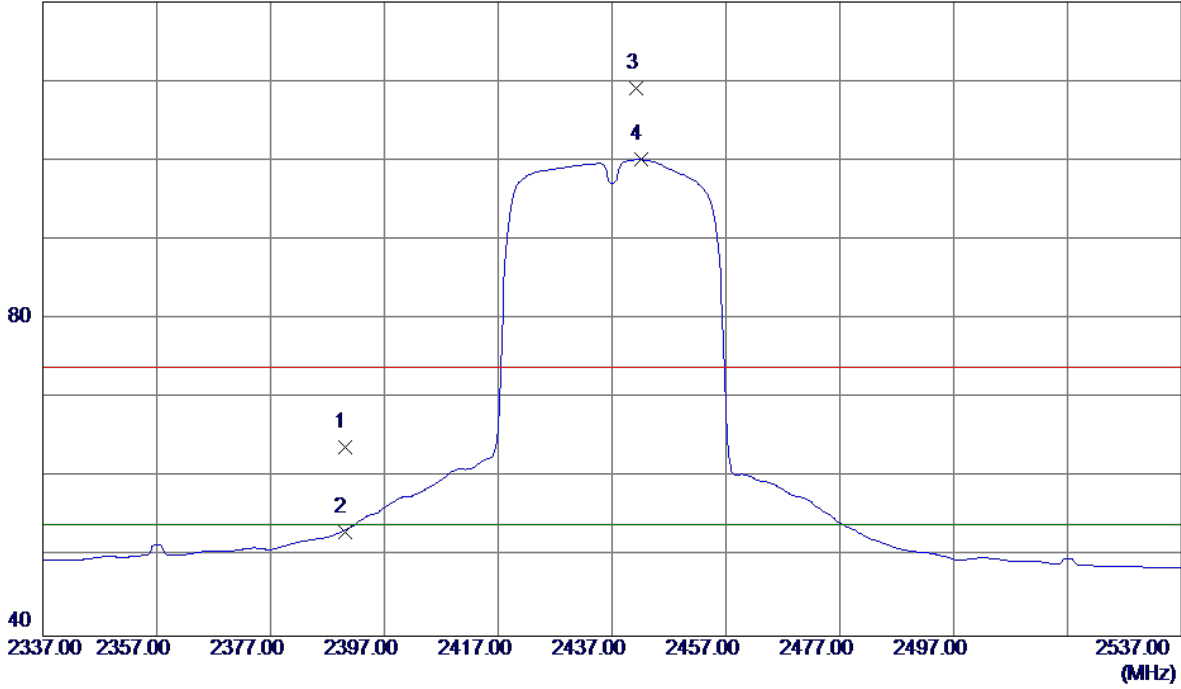

No.	Freq. MHz	Reading Level dBuV/m	Correct Factor dB	Measure ment dBuV/m	Limit dBuV/m	Margin dB	Detector	Comment
1	2390.0000	30.80	33.06	63.86	74.00	-10.14	Peak	
2	2390.0000	20.08	33.06	53.14	54.00	-0.86	AVG	
3	2441.2000	75.80	33.25	109.05	74.00	35.05	Peak	No Limit
4 *	2442.0000	66.85	33.25	100.10	54.00	46.10	AVG	No Limit

Orthogonal Axis :	X
Test Mode :	TX N-40M MODE 2437MHz

**Vertical**

80 dBuV/m

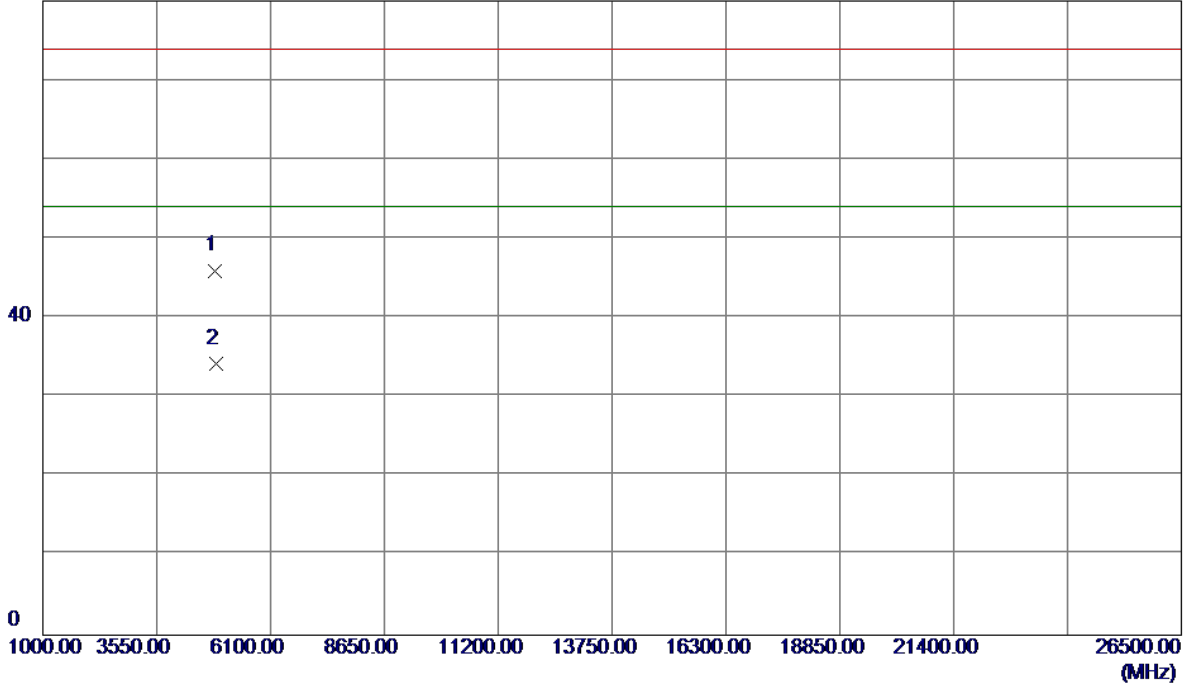

No.	Freq. MHz	Reading Level dBuV/m	Correct Factor dB	Measure ment dBuV/m	Limit dBuV/m	Margin dB	Detector	Comment
1	4866.0600	39.19	6.81	46.00	74.00	-28.00	Peak	
2 *	4871.1000	27.45	6.83	34.28	54.00	-19.72	AVG	



Orthogonal Axis :	X
Test Mode :	TX N-40M MODE 2437MHz

### Horizontal

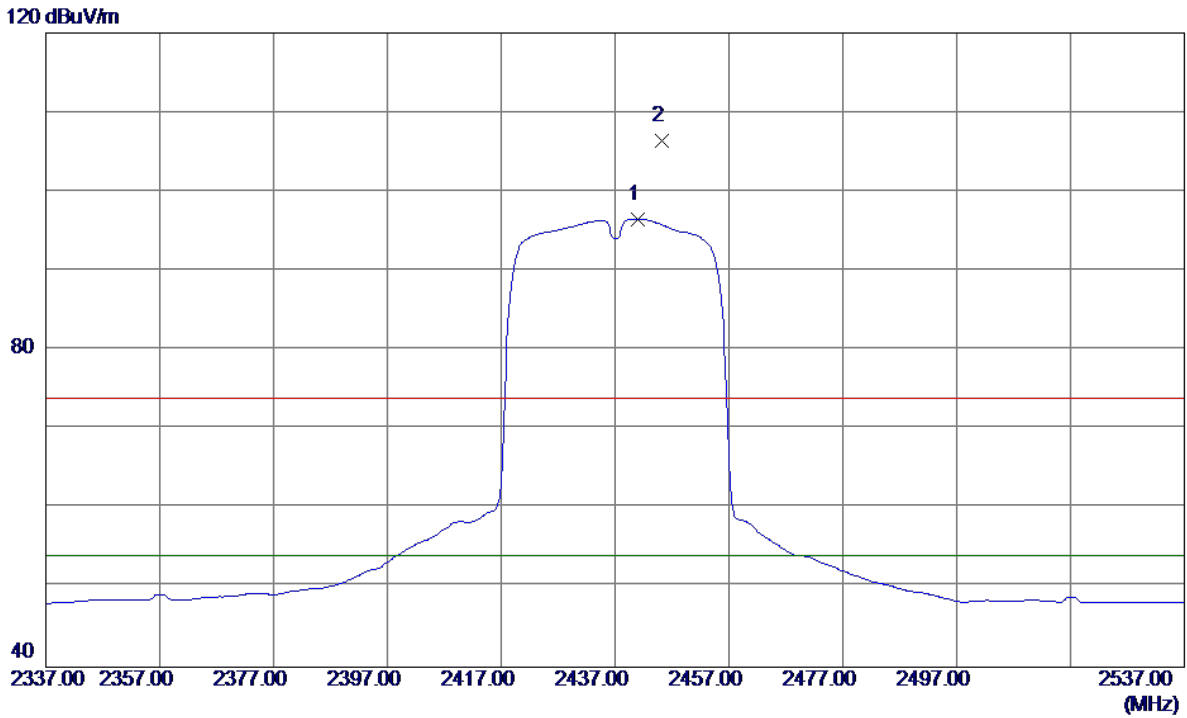

No.	Freq. MHz	Reading Level dBuV/m	Correct Factor dB	Measure ment dBuV/m	Limit dBuV/m	Margin dB	Detector	Comment
1 *	2441.0000	63.24	33.25	96.49	54.00	42.49	AVG	No Limit
2	2445.2000	73.08	33.26	106.34	74.00	32.34	Peak	No Limit

Orthogonal Axis :	X
Test Mode :	TX N-40M MODE 2437MHz

**Horizontal**

80 dBuV/m

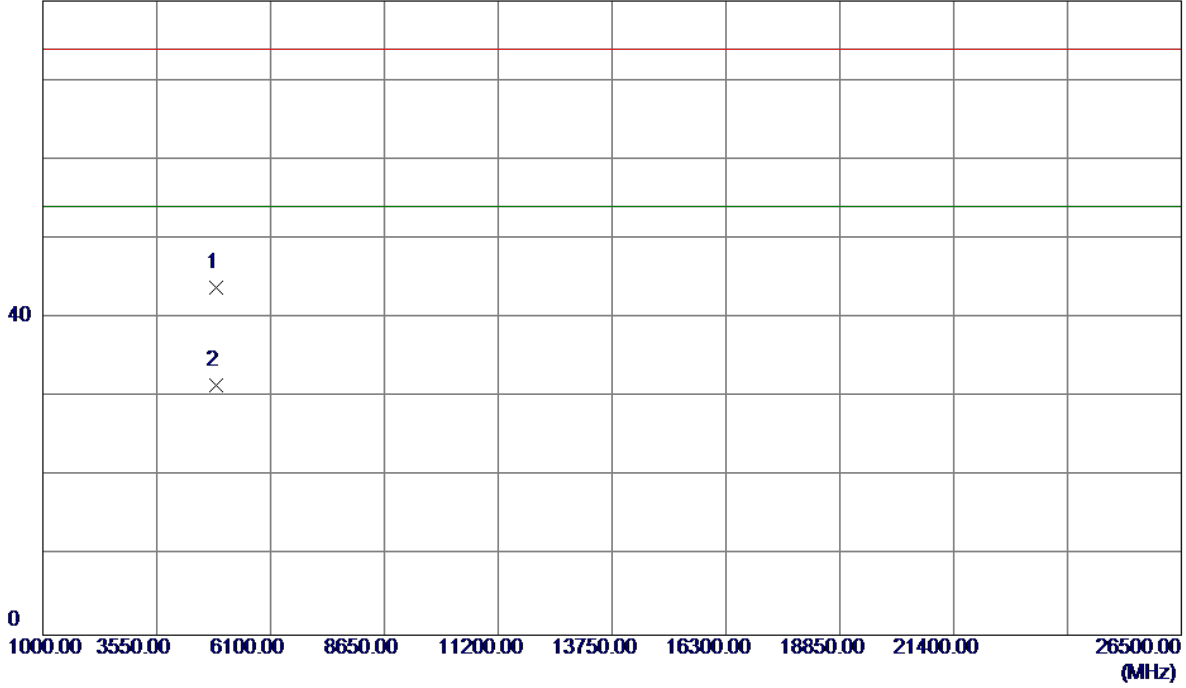

No.	Freq. MHz	Reading Level dBuV/m	Correct Factor dB	Measure ment dBuV/m	Limit dBuV/m	Margin dB	Detector	Comment
1	4875.8500	36.95	6.84	43.79	74.00	-30.21	Peak	
2 *	4879.3500	24.70	6.86	31.56	54.00	-22.44	AVG	

Orthogonal Axis :	X
Test Mode :	TX N-40M MODE 2452MHz

**Vertical**

120 dBuV/m

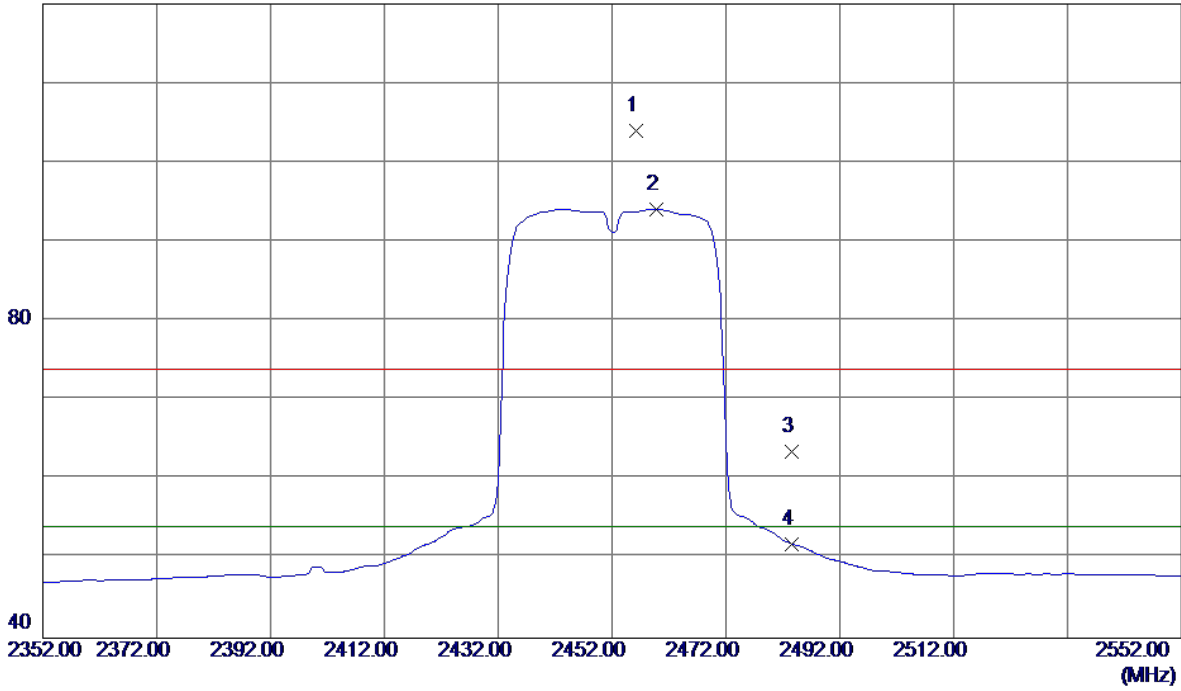

No.	Freq. MHz	Reading Level dBuV/m	Correct Factor dB	Measure ment dBuV/m	Limit dBuV/m	Margin dB	Detector	Comment
1	2456.2000	70.76	33.31	104.07	74.00	30.07	Peak	No Limit
2 *	2459.8000	60.80	33.32	94.12	54.00	40.12	AVG	No Limit
3	2483.5000	30.18	33.41	63.59	74.00	-10.41	Peak	
4	2483.5000	18.48	33.41	51.89	54.00	-2.11	AVG	

Orthogonal Axis :	X
Test Mode :	TX N-40M MODE 2452MHz

**Vertical**

80 dBuV/m

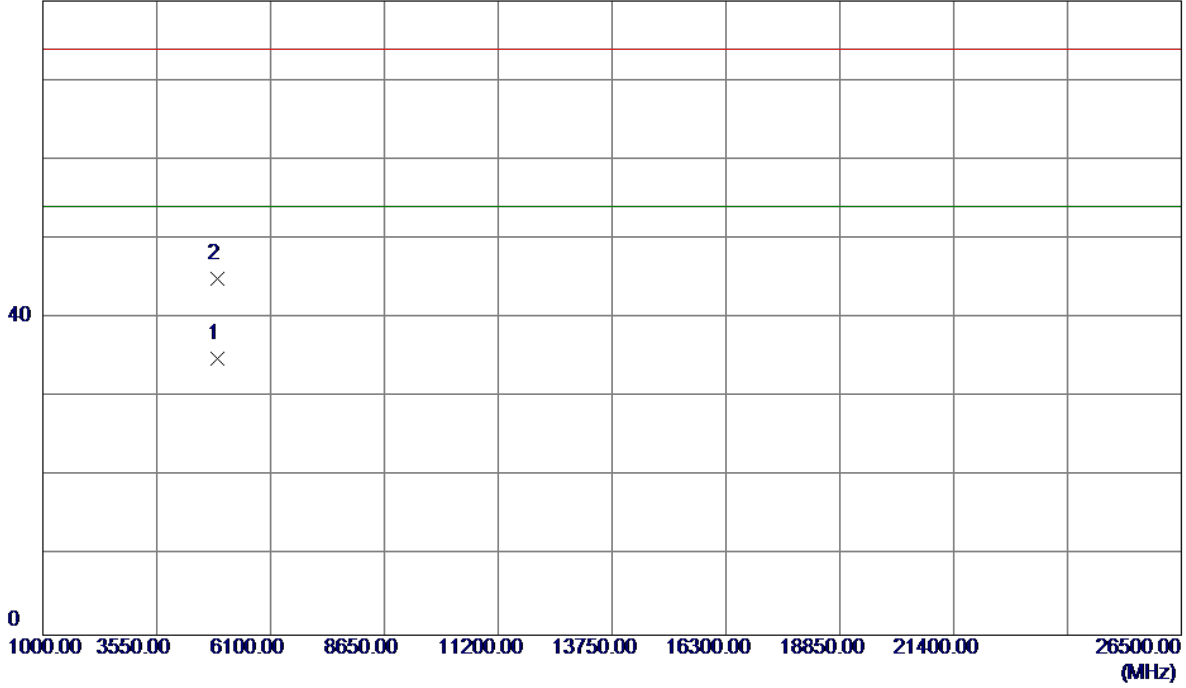

No.	Freq. MHz	Reading Level dBuV/m	Correct Factor dB	Measure ment dBuV/m	Limit dBuV/m	Margin dB	Detector	Comment
1 *	4904.4400	27.90	6.95	34.85	54.00	-19.15	AVG	
2	4906.0200	37.97	6.95	44.92	74.00	-29.08	Peak	

Orthogonal Axis :	X
Test Mode :	TX N-40M MODE 2452MHz

**Horizontal**

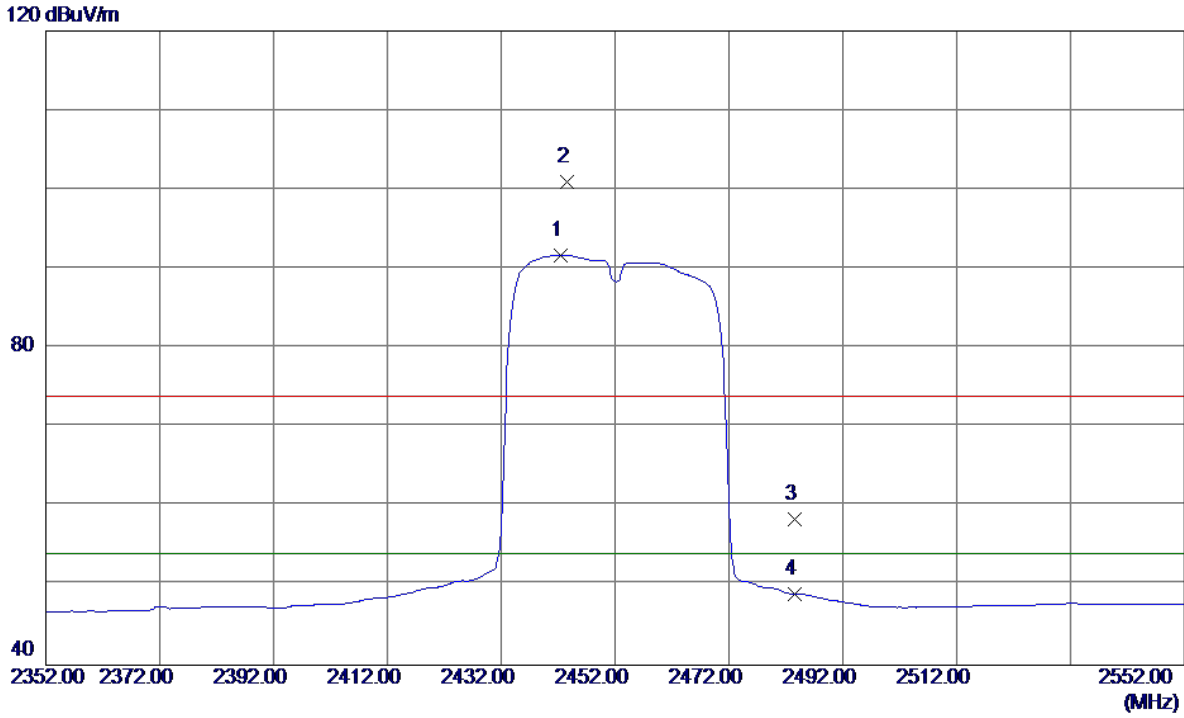

No.	Freq. MHz	Reading Level dBuV/m	Correct Factor dB	Measure ment dBuV/m	Limit dBuV/m	Margin dB	Detector	Comment
1 *	2442.4000	58.48	33.25	91.73	54.00	37.73	AVG	No Limit
2	2443.6000	67.75	33.26	101.01	74.00	27.01	Peak	No Limit
3	2483.5000	25.00	33.41	58.41	74.00	-15.59	Peak	
4	2483.5000	15.59	33.41	49.00	54.00	-5.00	AVG	

Orthogonal Axis :	X
Test Mode :	TX N-40M MODE 2452MHz

### Horizontal

80 dBuV/m

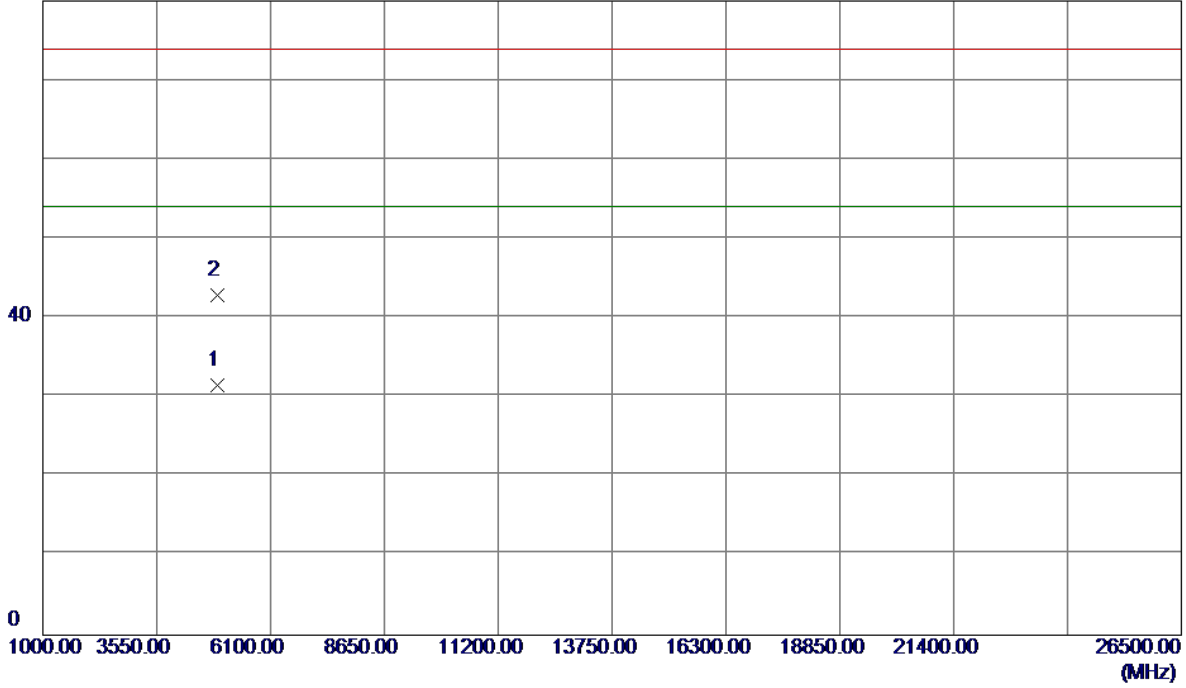

No.	Freq. MHz	Reading Level dBuV/m	Correct Factor dB	Measure ment dBuV/m	Limit dBuV/m	Margin dB	Detector	Comment
1 *	4904.4500	24.60	6.95	31.55	54.00	-22.45	AVG	
2	4905.0500	35.91	6.95	42.86	74.00	-31.14	Peak	

## APPENDIX E - BANDWIDTH

**Test Mode : TX B Mode\_CH01/06/11**

Frequency (MHz)	6dB Bandwidth (MHz)	99% Occupied BW (MHz)	Min. Limit (kHz)	Test Result
2412	10.10	14.56	500	Complies
2437	10.10	15.04	500	Complies
2462	10.10	14.60	500	Complies

**TX CH01**

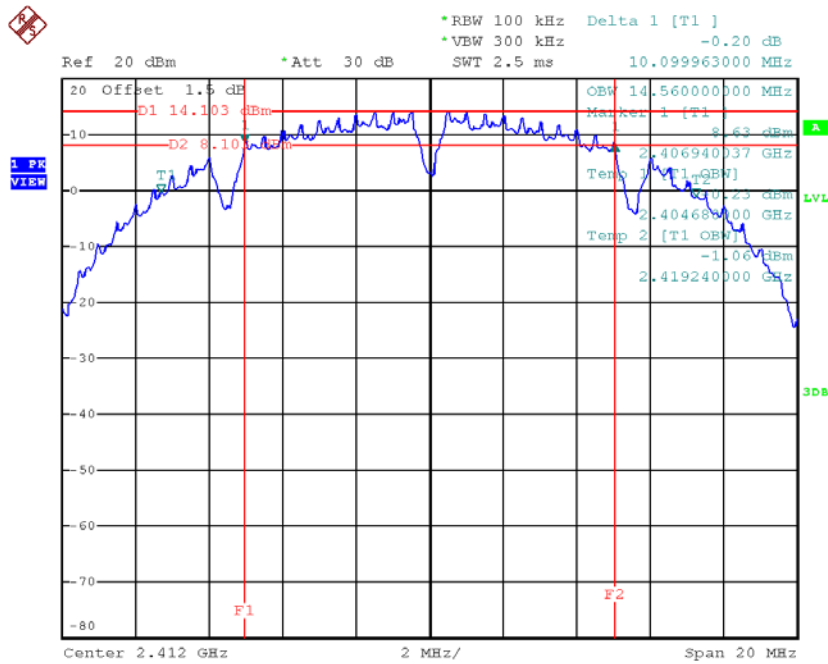

Date: 15.NOV.2017 11:55:05



**TX CH06**

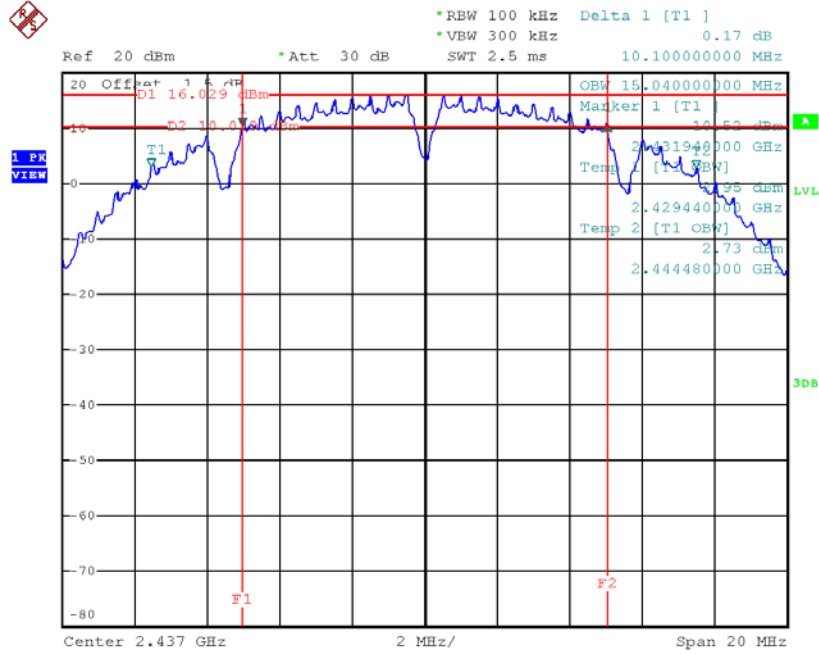

Date: 15.NOV.2017 11:56:53

**TX CH11**

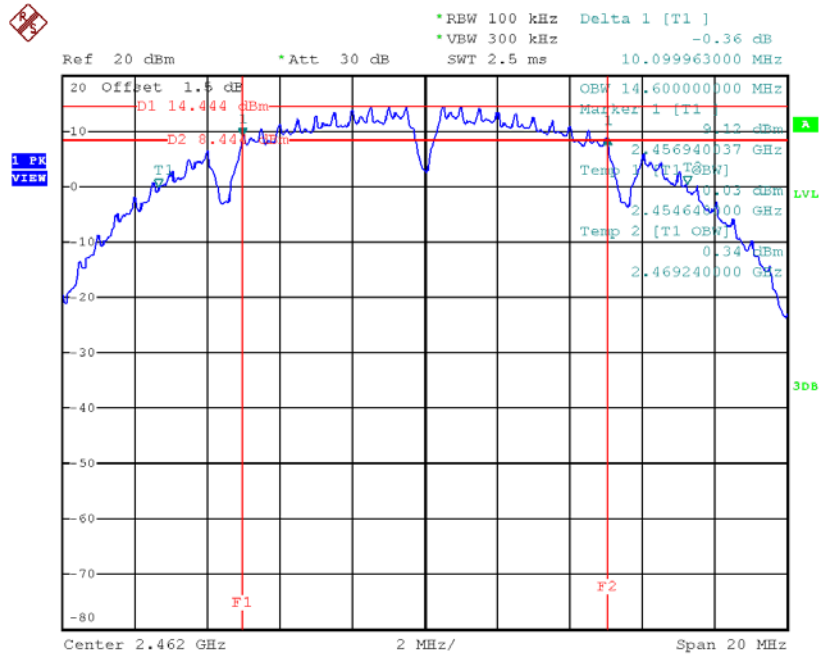

Date: 15.NOV.2017 11:58:25

**Test Mode: TX G Mode\_CH01/06/11**

Frequency (MHz)	6dB Bandwidth (MHz)	99% Occupied BW (MHz)	Min. Limit (kHz)	Test Result
2412	16.54	16.40	500	Complies
2437	16.53	16.40	500	Complies
2462	16.48	16.40	500	Complies

**TX CH01**

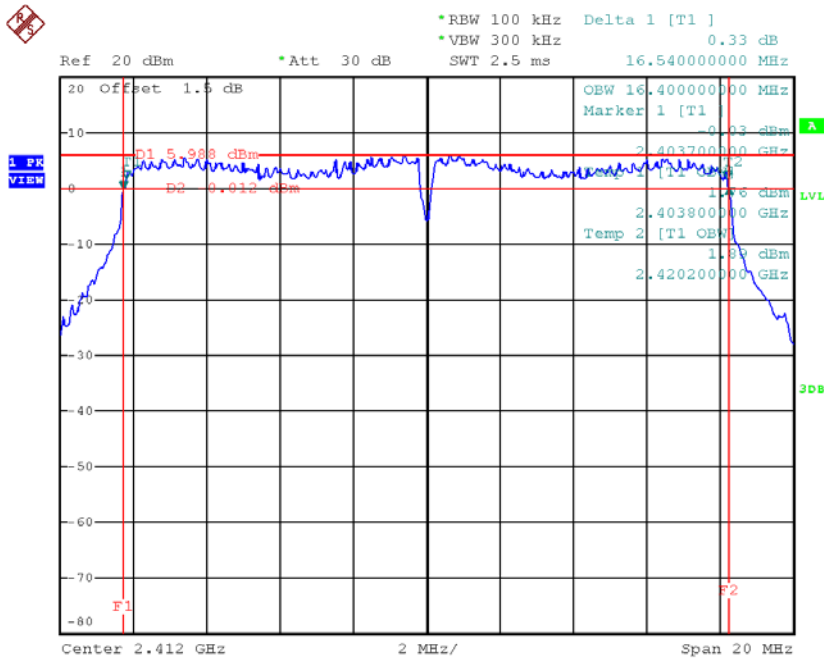

Date: 15.NOV.2017 11:59:56

**TX CH06**

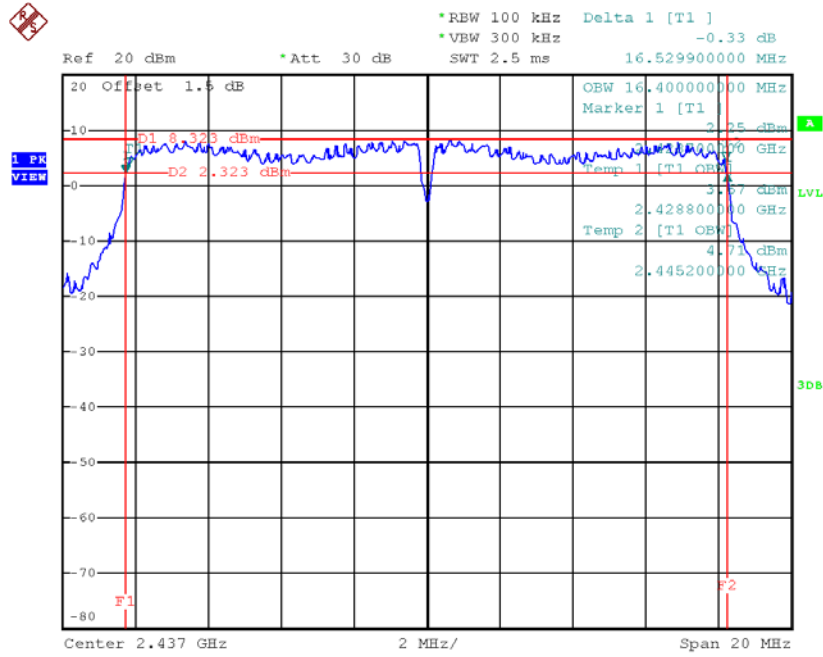

Date: 15.NOV.2017 12:01:54

**TX CH11**

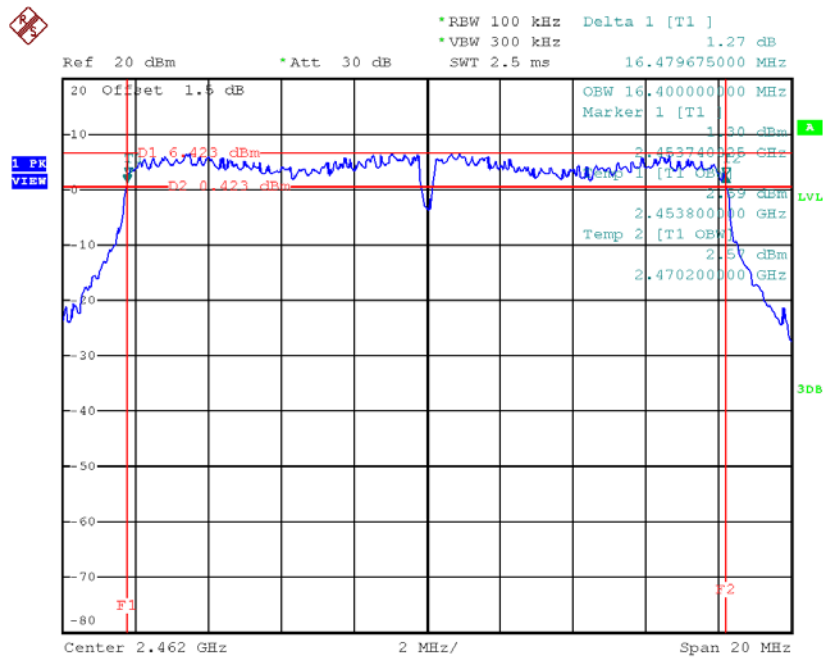

Date: 15.NOV.2017 12:03:18

**Test Mode : TX N-20MHz Mode\_CH01/06/11**

Frequency (MHz)	6dB Bandwidth (MHz)	99% Occupied BW (MHz)	Min. Limit (kHz)	Test Result
2412	17.62	17.52	500	Complies
2437	17.62	17.48	500	Complies
2462	17.62	17.52	500	Complies

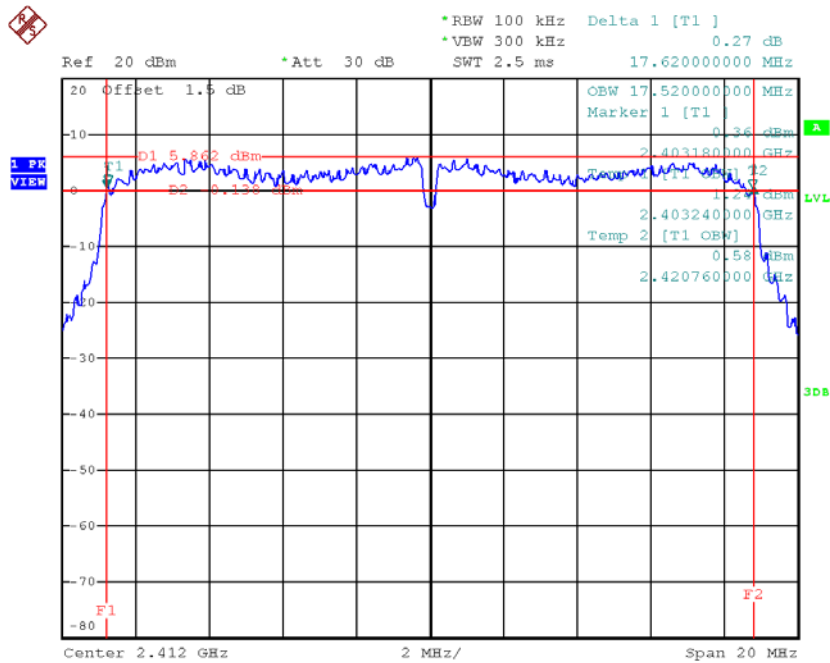
**TX CH01**

Date: 15.NOV.2017 12:05:05

**TX CH06**

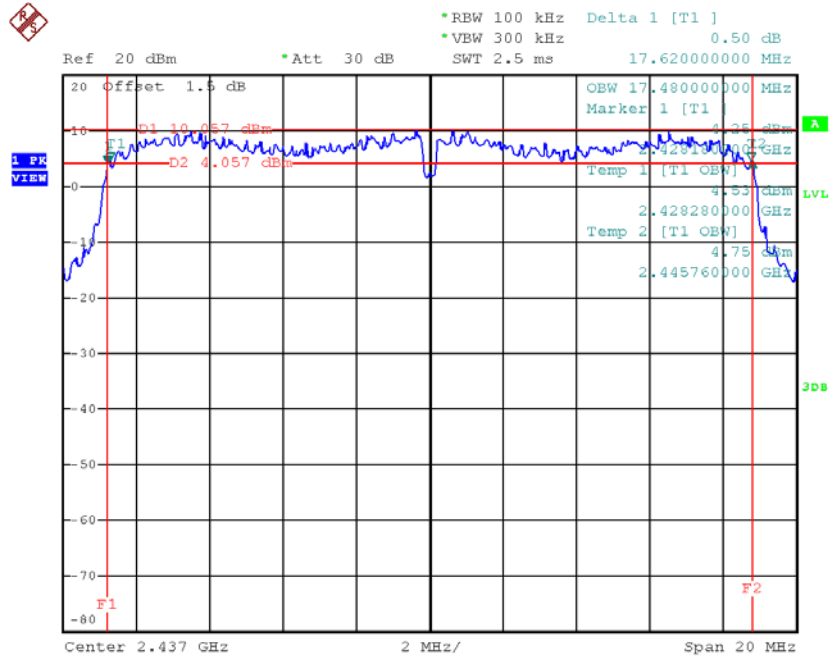

Date: 15.NOV.2017 13:38:56

**TX CH11**

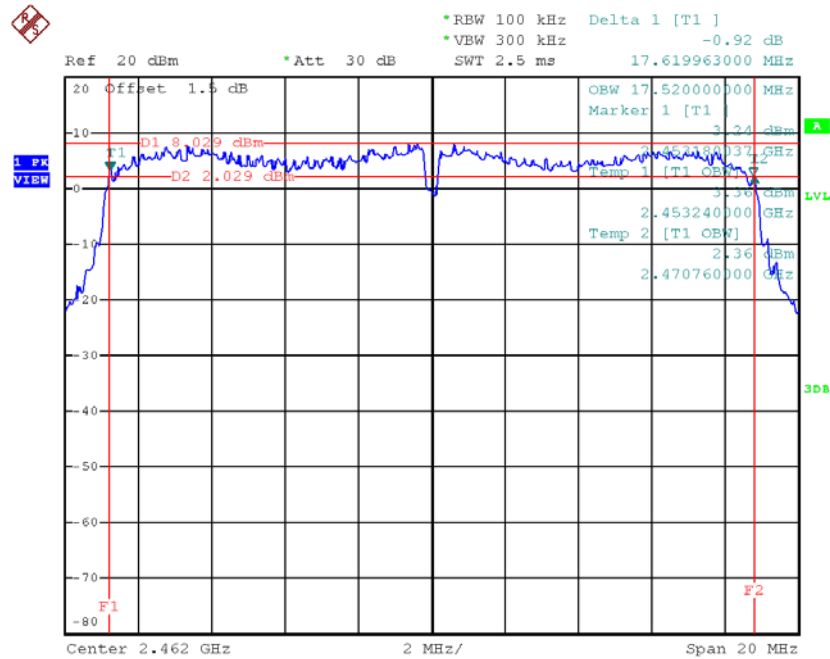

Date: 15.NOV.2017 13:40:28

**Test Mode : TX N-40MHz Mode\_CH03/06/09**

Frequency (MHz)	6dB Bandwidth (MHz)	99% Occupied BW (MHz)	Min. Limit (kHz)	Test Result
2422	36.07	35.76	500	Complies
2437	36.08	35.76	500	Complies
2452	35.91	35.76	500	Complies

**TX CH03**

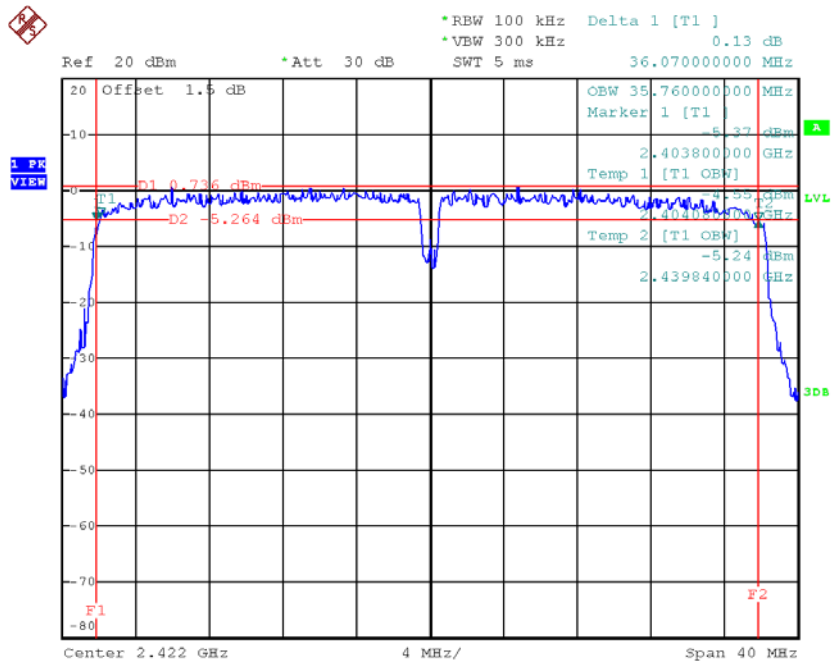

Date: 15.NOV.2017 13:42:02

**TX CH06**

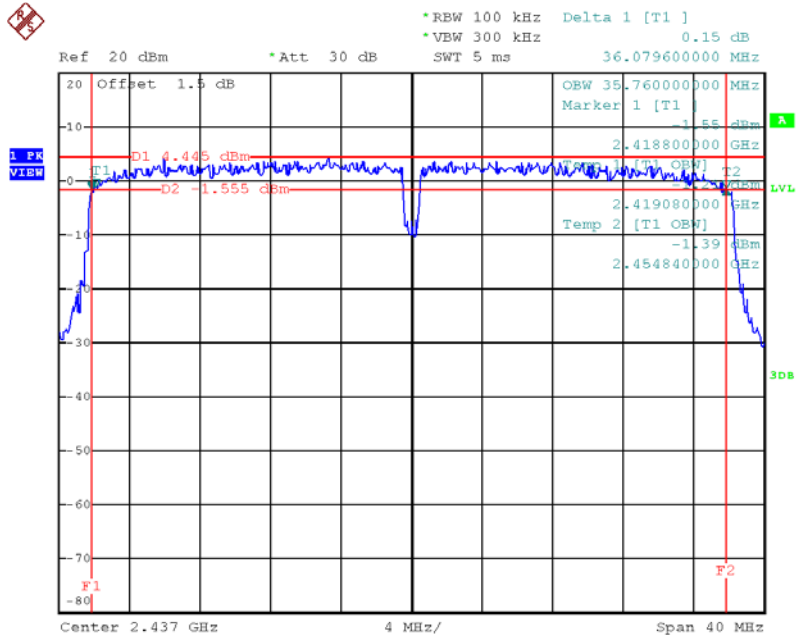

Date: 15.NOV.2017 13:43:24

**TX CH09**

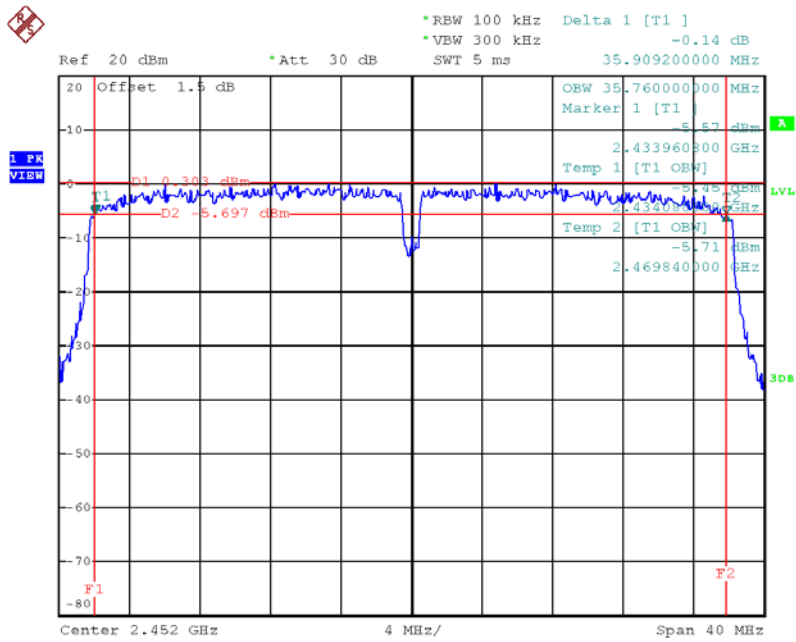

Date: 15.NOV.2017 13:44:53

# APPENDIX F - MAXIMUM PEAK CONDUCTED OUTPUT POWER



Test Mode :TX B Mode_CH01/06/11_ANT 1					
Frequency (MHz)	Conducted Power (dBm)	Conducted Power (W)	Max. Limit (dBm)	Max. Limit (W)	Result
2412	21.60	0.14	30.00	1.00	Complies
2437	23.40	0.22	30.00	1.00	Complies
2462	22.34	0.17	30.00	1.00	Complies

Test Mode :TX G Mode_CH01/06/11_ANT 1					
Frequency (MHz)	Conducted Power (dBm)	Conducted Power (W)	Max. Limit (dBm)	Max. Limit (W)	Result
2412	22.21	0.17	30.00	1.00	Complies
2437	23.52	0.22	30.00	1.00	Complies
2462	23.57	0.23	30.00	1.00	Complies

Test Mode :TX N20 Mode_CH01/06/11_ANT 1					
Frequency (MHz)	Conducted Power (dBm)	Conducted Power (W)	Max. Limit (dBm)	Max. Limit (W)	Result
2412	21.33	0.14	30.00	1.00	Complies
2437	22.82	0.19	30.00	1.00	Complies
2462	21.57	0.14	30.00	1.00	Complies

Test Mode :TX N20 Mode_CH01/06/11_ANT 2					
Frequency (MHz)	Conducted Power (dBm)	Conducted Power (W)	Max. Limit (dBm)	Max. Limit (W)	Result
2412	20.84	0.12	30.00	1.00	Complies
2437	23.12	0.21	30.00	1.00	Complies
2462	21.69	0.15	30.00	1.00	Complies

Test Mode :TX N20 Mode_CH01/06/11_Total					
Frequency (MHz)	Conducted Power (dBm)	Conducted Power (W)	Max. Limit (dBm)	Max. Limit (W)	Result
2412	24.10	0.26	30.00	1.00	Complies
2437	25.98	0.40	30.00	1.00	Complies
2462	24.64	0.29	30.00	1.00	Complies

Test Mode :TX N40 Mode_CH03/06/09_ANT 1					
Frequency (MHz)	Conducted Power (dBm)	Conducted Power (W)	Max. Limit (dBm)	Max. Limit (W)	Result
2422	19.73	0.09	30.00	1.00	Complies
2437	22.62	0.18	30.00	1.00	Complies
2452	19.86	0.10	30.00	1.00	Complies

Test Mode :TX N40 Mode_CH03/06/09_ANT 2					
Frequency (MHz)	Conducted Power (dBm)	Conducted Power (W)	Max. Limit (dBm)	Max. Limit (W)	Result
2422	20.08	0.10	30.00	1.00	Complies
2437	22.92	0.20	30.00	1.00	Complies
2452	19.30	0.09	30.00	1.00	Complies

Test Mode :TX N40 Mode_CH03/06/09_Total					
Frequency (MHz)	Conducted Power (dBm)	Conducted Power (W)	Max. Limit (dBm)	Max. Limit (W)	Result
2422	22.92	0.20	30.00	1.00	Complies
2437	25.78	0.38	30.00	1.00	Complies
2452	22.60	0.18	30.00	1.00	Complies

## APPENDIX G - ANTENNA CONDUCTED SPURIOUS EMISSION

Test Mode : TX B Mode

**TX B mode CH01**

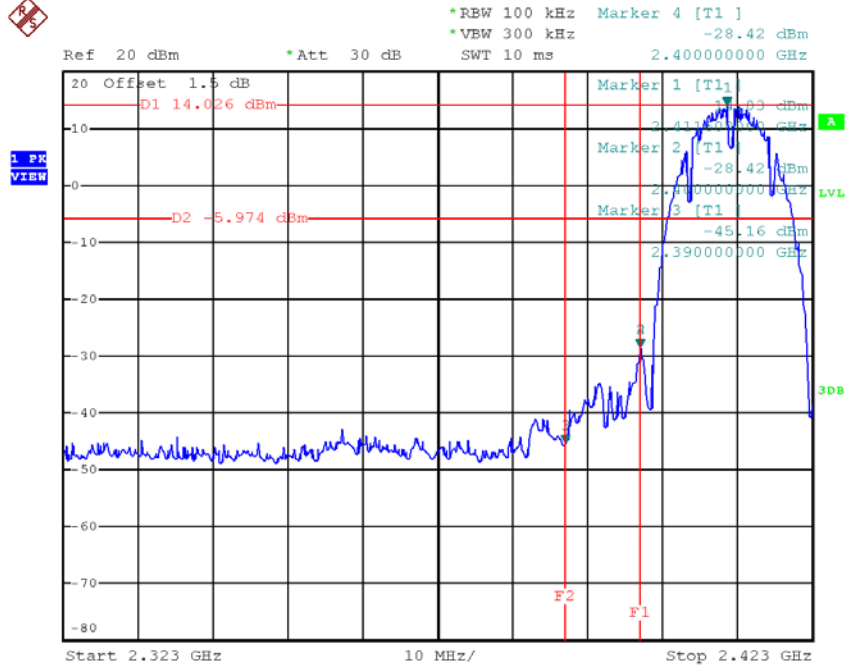

Date: 15.NOV.2017 11:55:13

**TX B mode CH11**

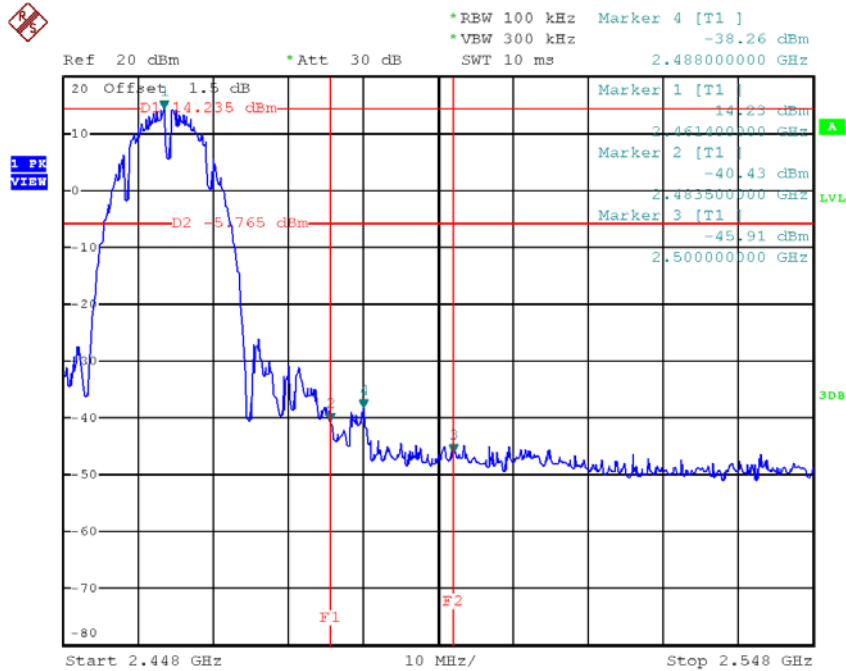

Date: 15.NOV.2017 11:58:33

### TX B mode CH01 (10 Harmonic of the frequency)

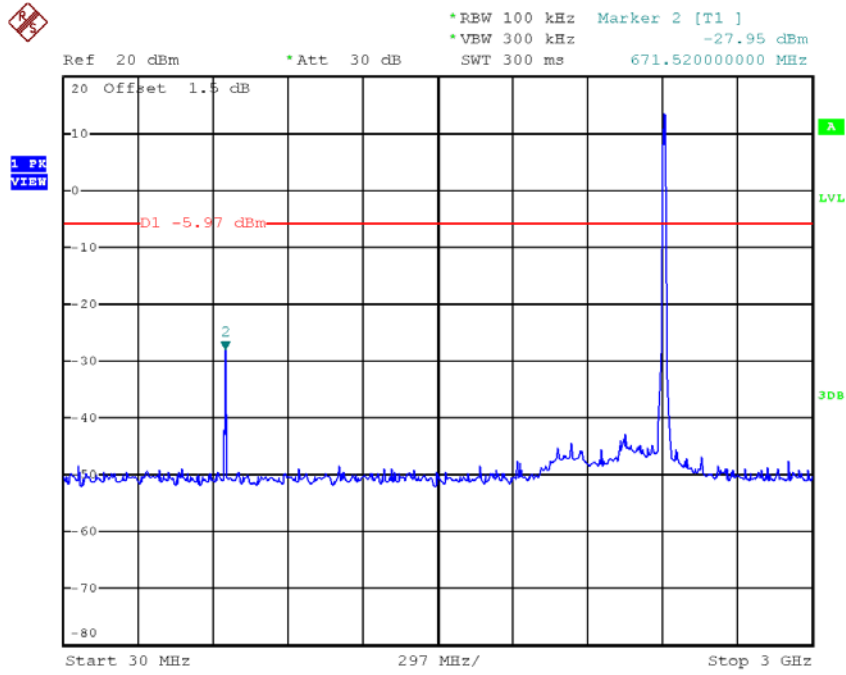

Date: 15.NOV.2017 11:55:27

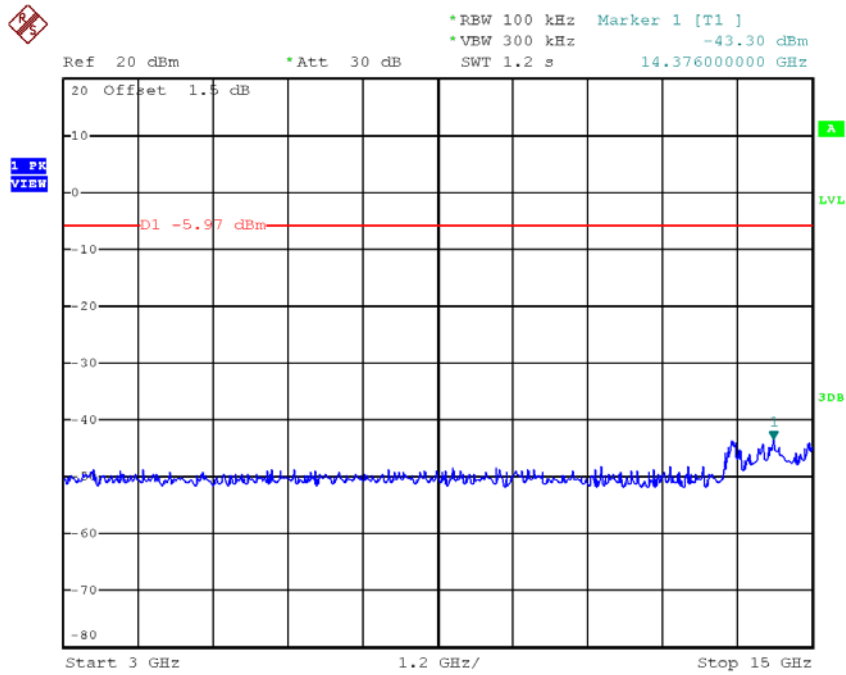

Date: 15.NOV.2017 11:55:35

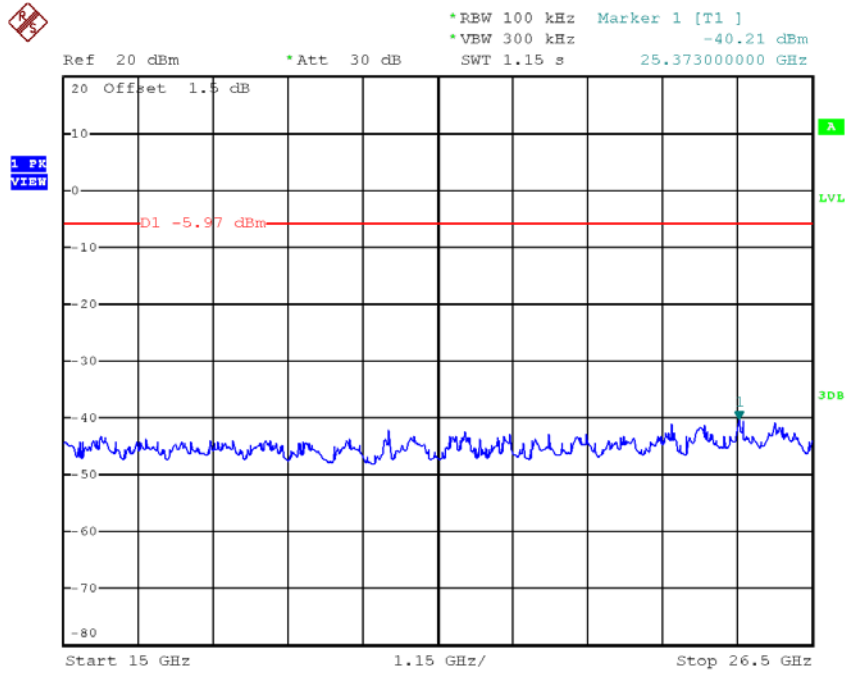

Date: 15.NOV.2017 11:55:43

### TX B mode CH06 (10 Harmonic of the frequency)

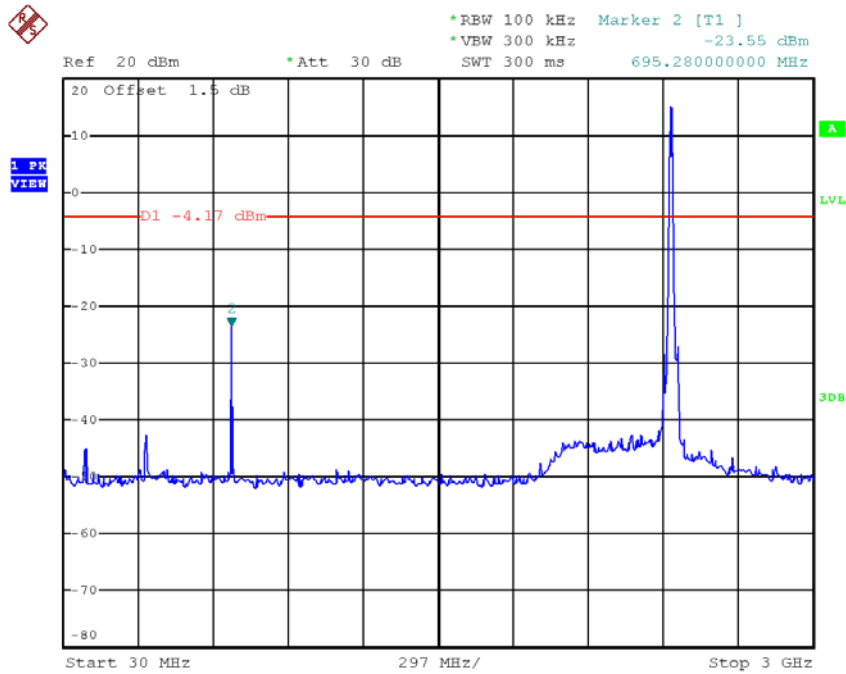

Date: 15.NOV.2017 11:57:15

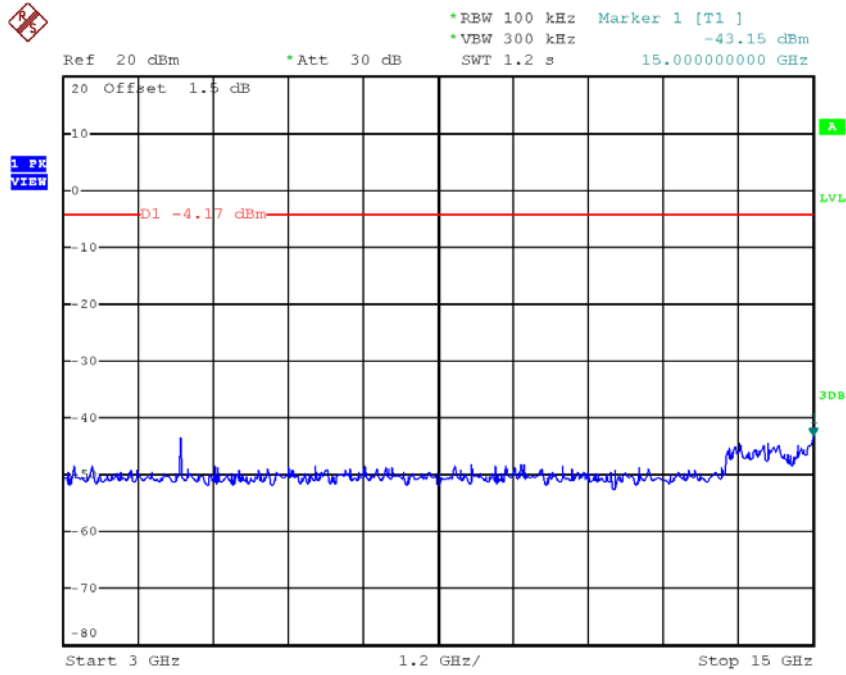

Date: 15.NOV.2017 11:57:23

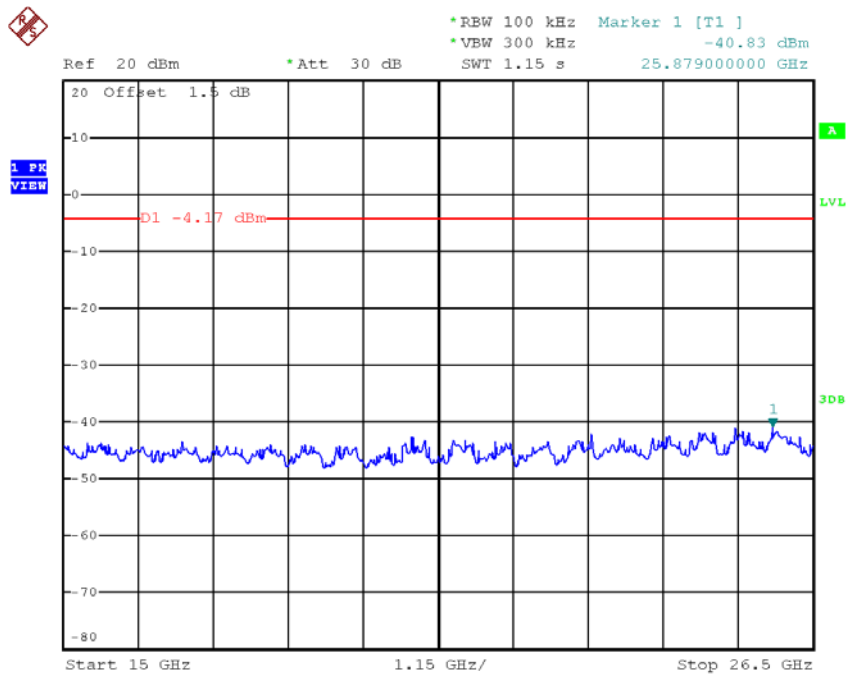

Date: 15.NOV.2017 11:57:31



### TX B mode CH11 (10 Harmonic of the frequency)

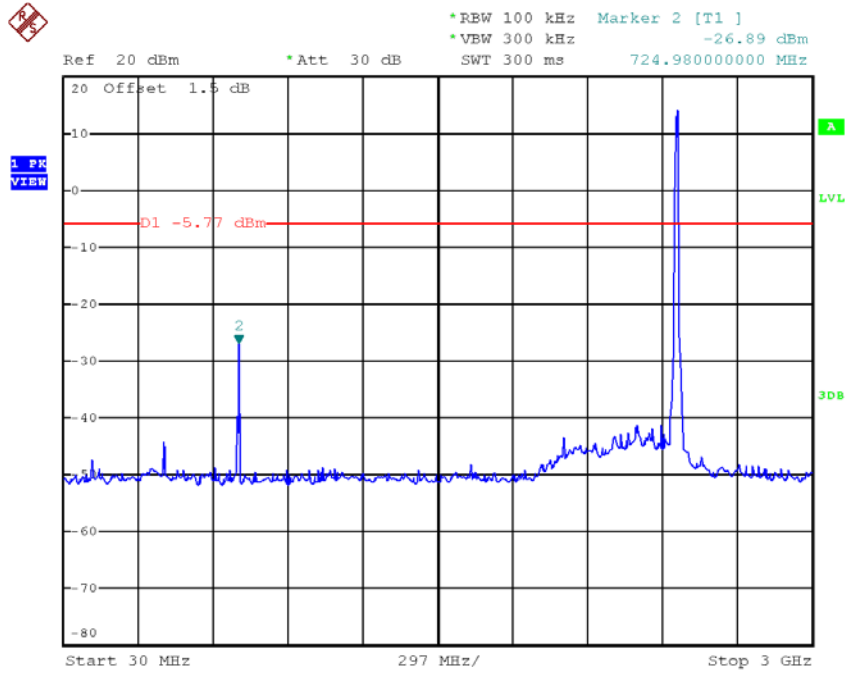

Date: 15.NOV.2017 11:58:47

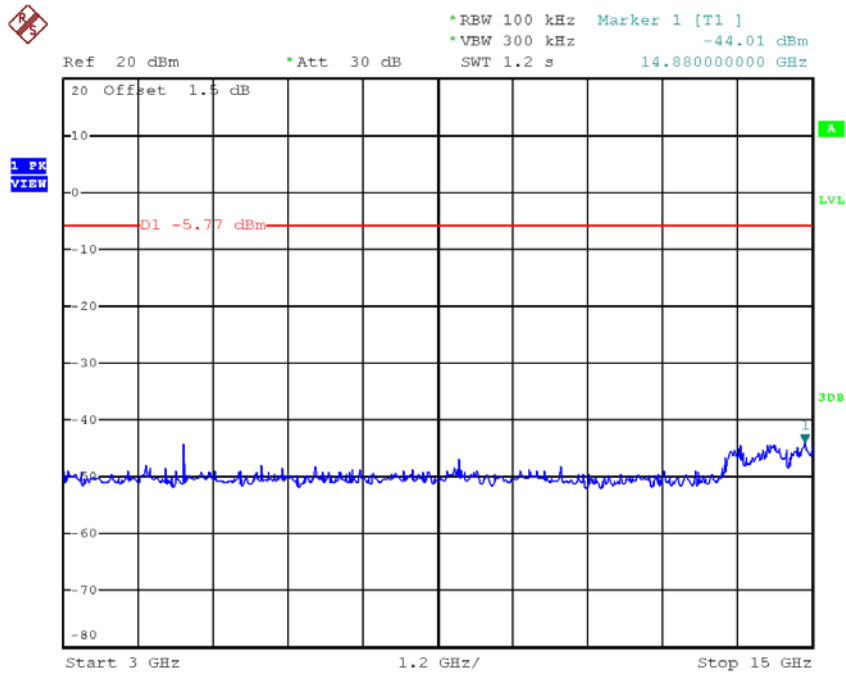

Date: 15.NOV.2017 11:58:55

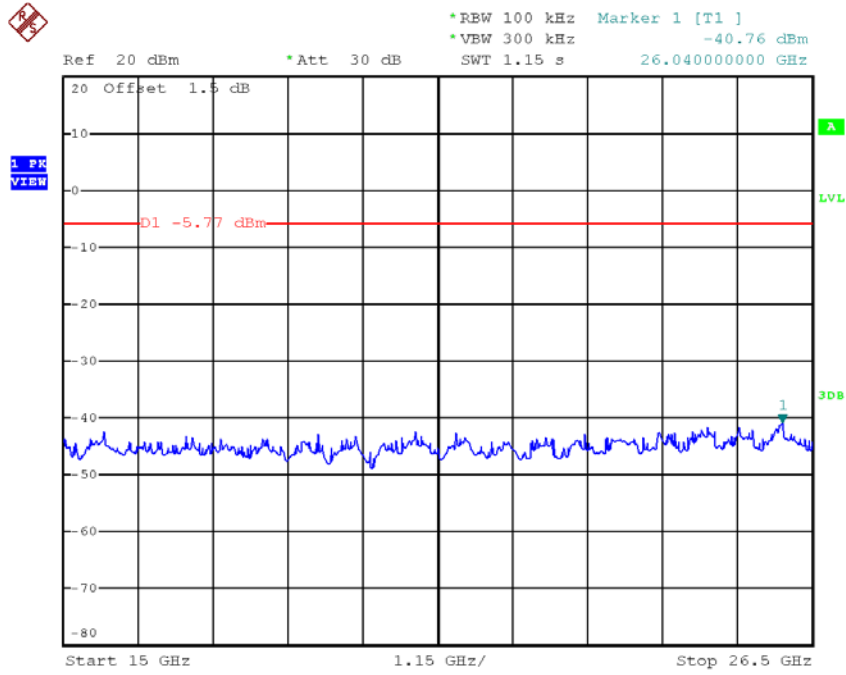

Date: 15.NOV.2017 11:59:03

Test Mode : TX G Mode

**TX G mode CH01**

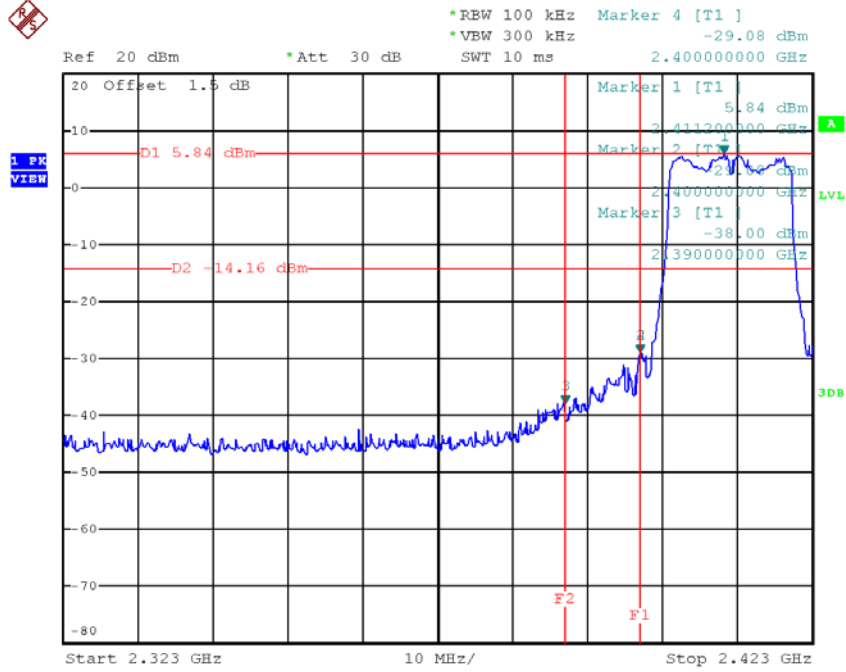

Date: 15.NOV.2017 12:00:03

**TX G mode CH11**

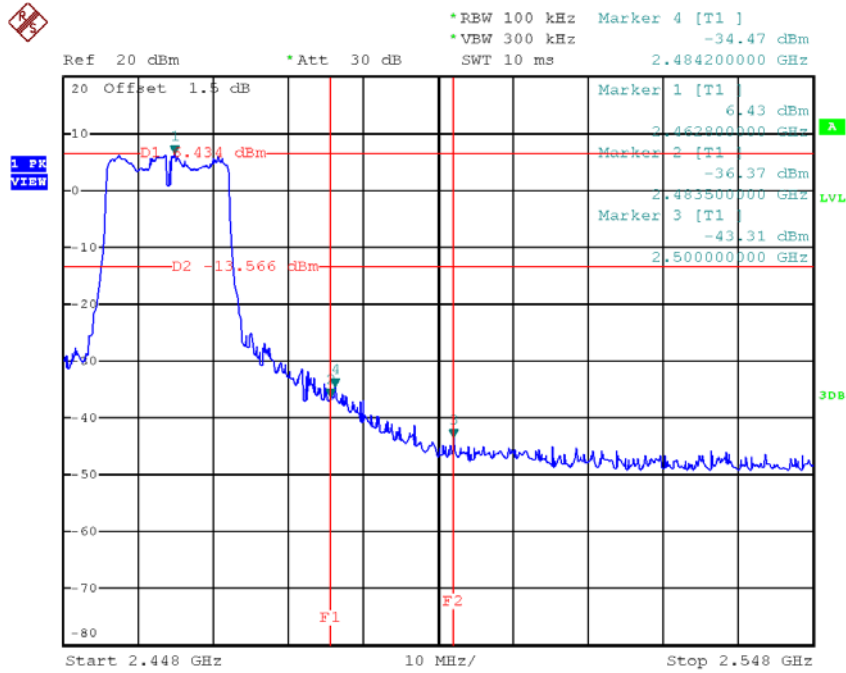

Date: 15.NOV.2017 12:03:26

### TX G mode CH01 (10 Harmonic of the frequency)

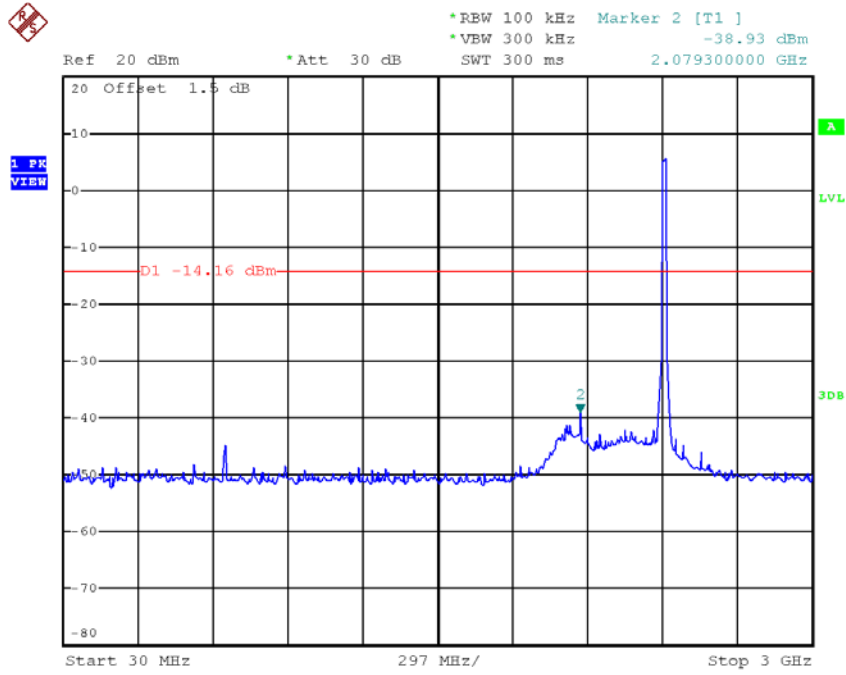

Date: 15.NOV.2017 12:00:17

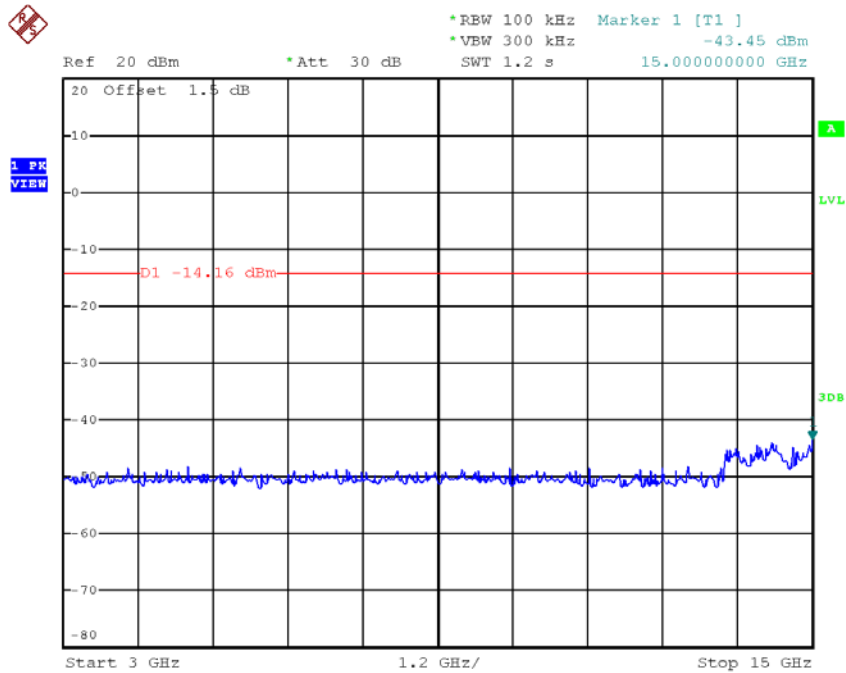

Date: 15.NOV.2017 12:00:25

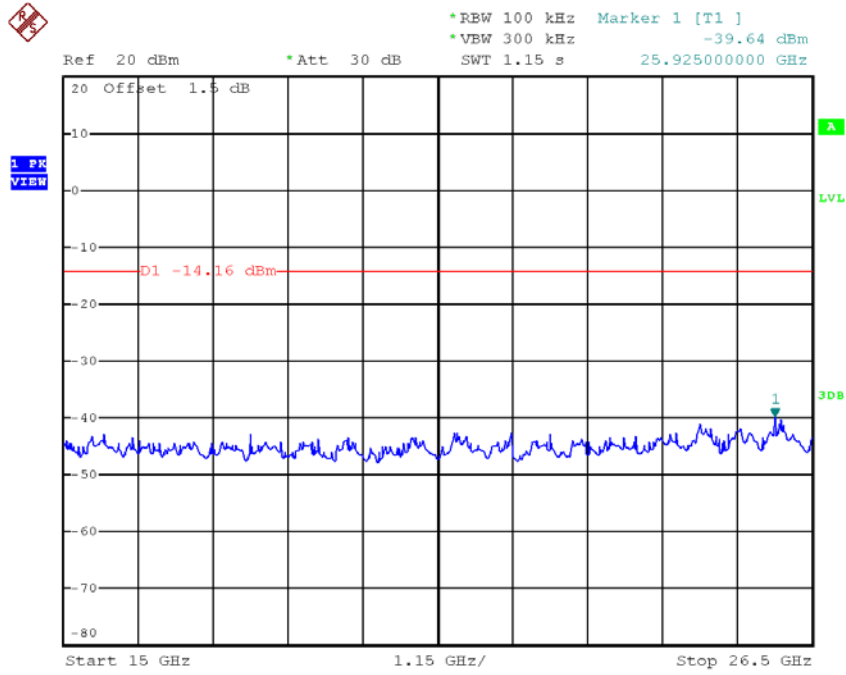

Date: 15.NOV.2017 12:00:33

**TX G mode CH06 (10 Harmonic of the frequency)**

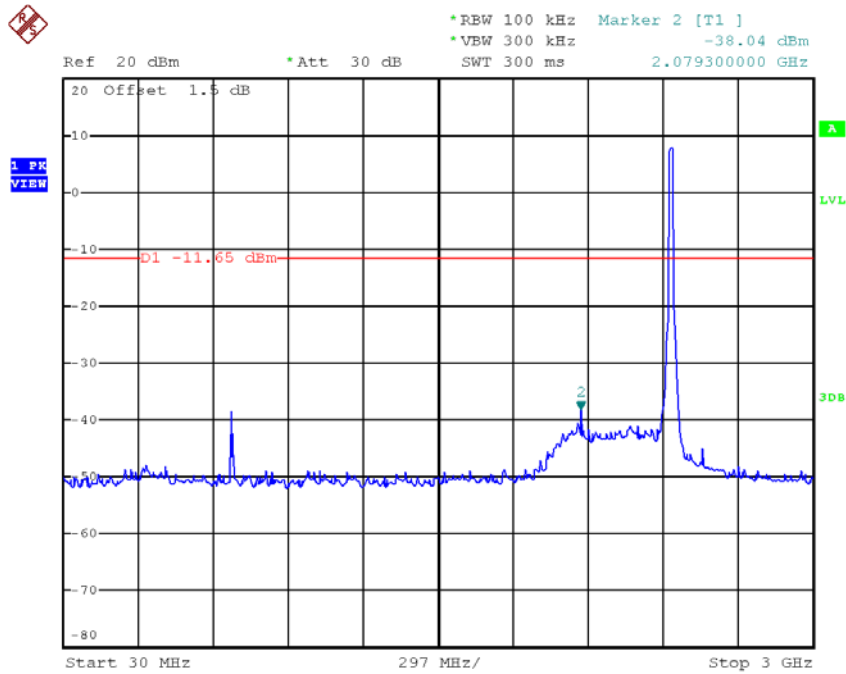

Date: 15.NOV.2017 12:02:16

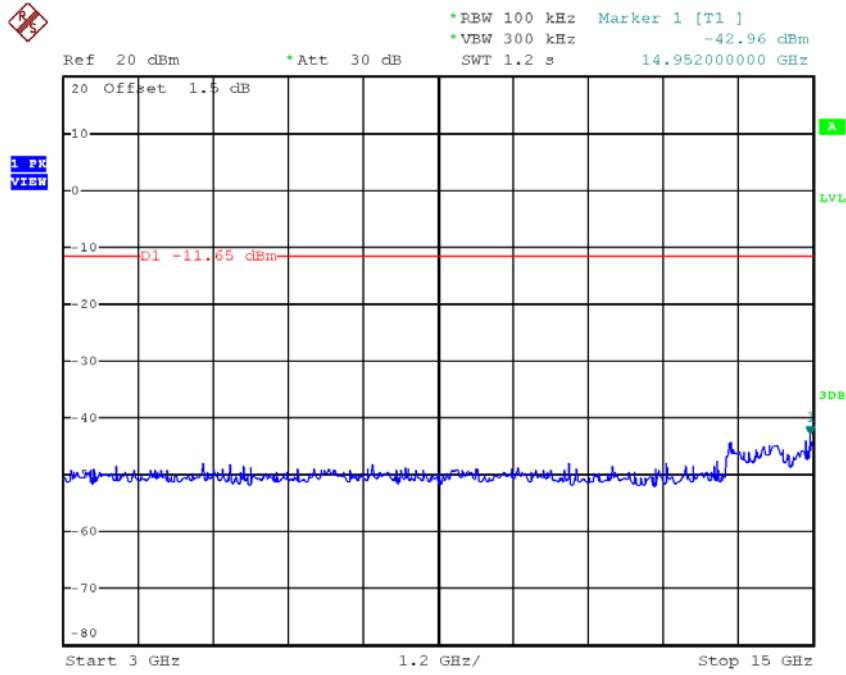

Date: 15.NOV.2017 12:02:24

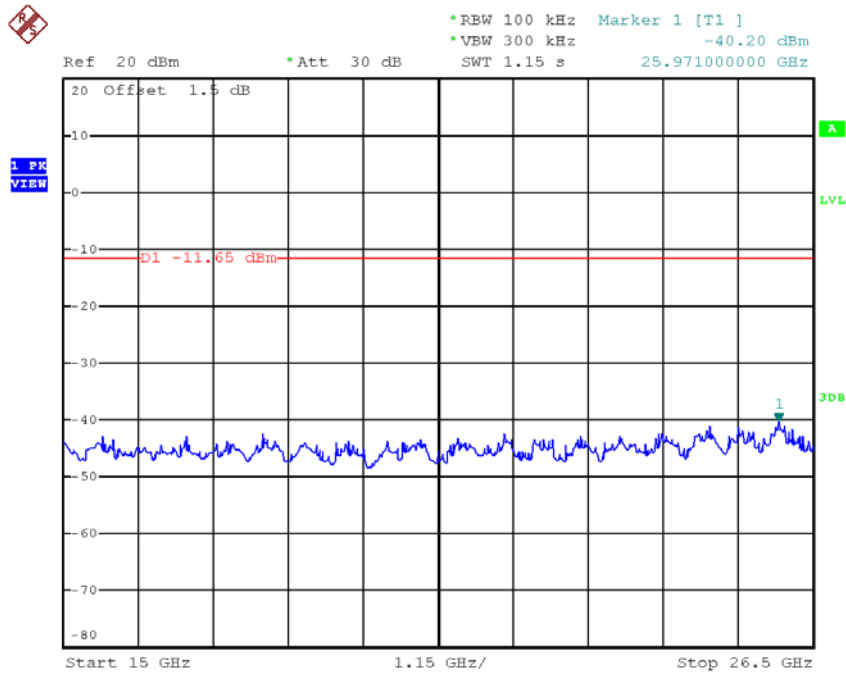

Date: 15.NOV.2017 12:02:32

### TX G mode CH11 (10 Harmonic of the frequency)

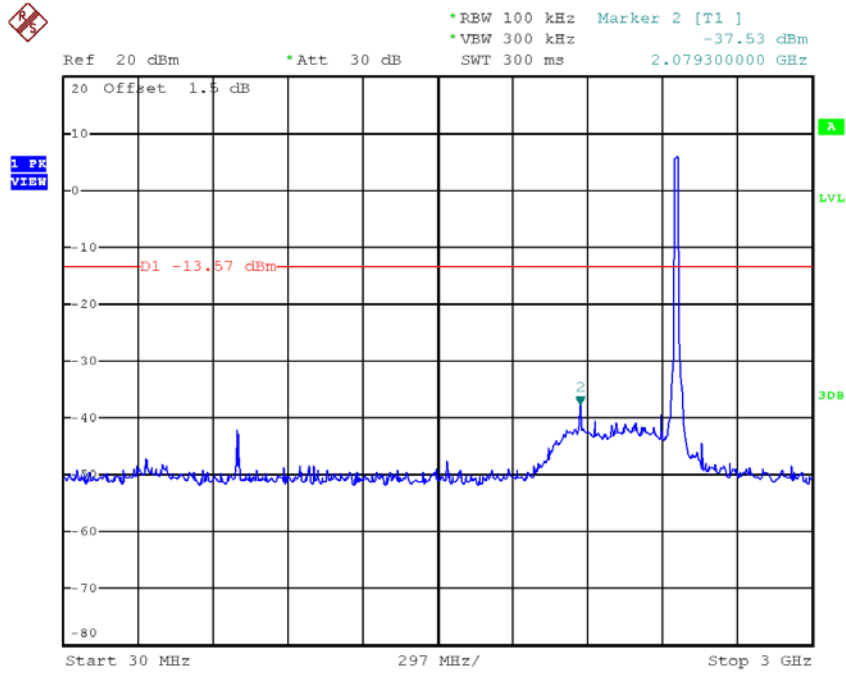

Date: 15.NOV.2017 12:03:40

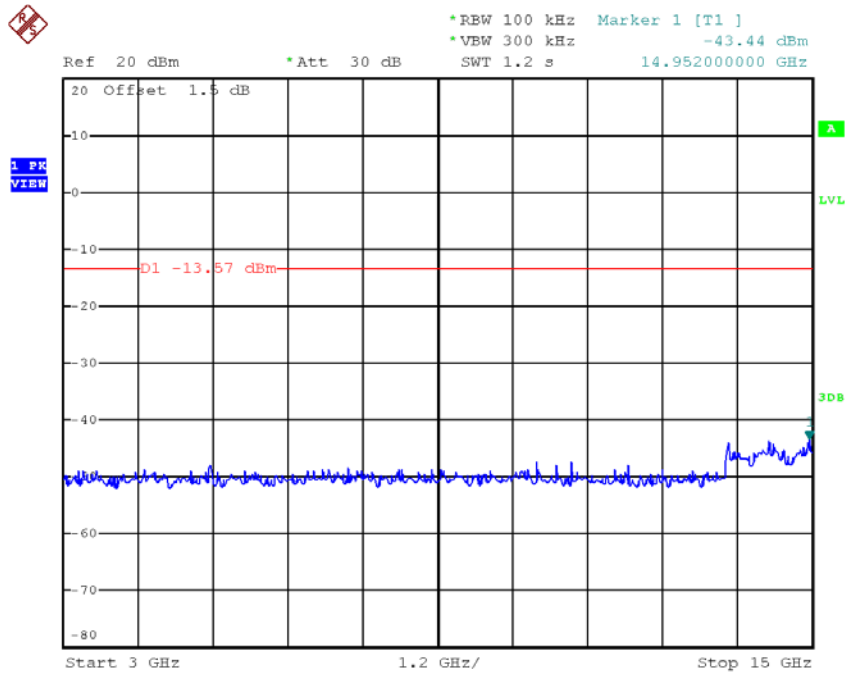

Date: 15.NOV.2017 12:03:47

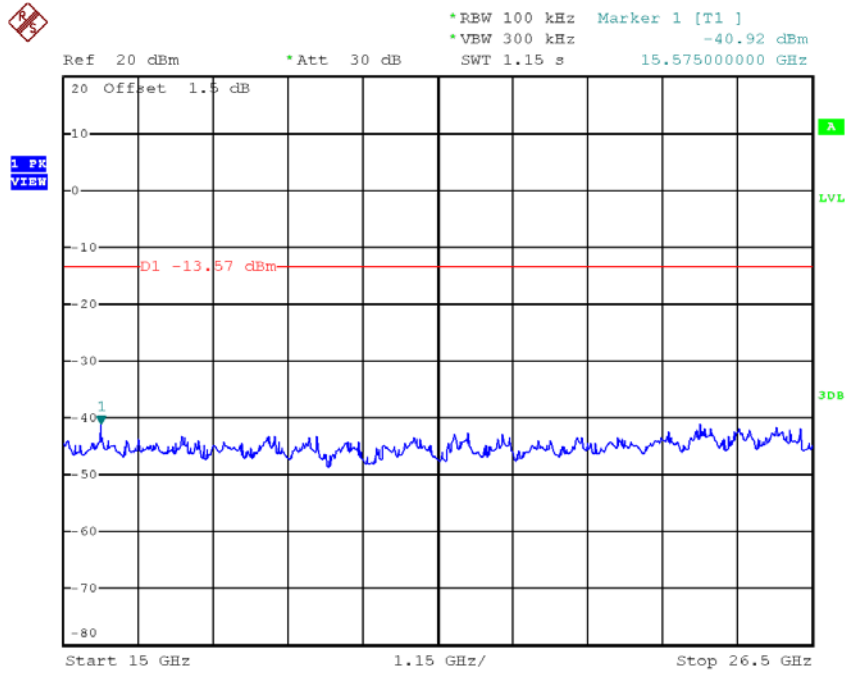

Date: 15.NOV.2017 12:03:55



**Test Mode : TX N-20M Mode\_ANT 1**

**TX HT20 mode CH01**

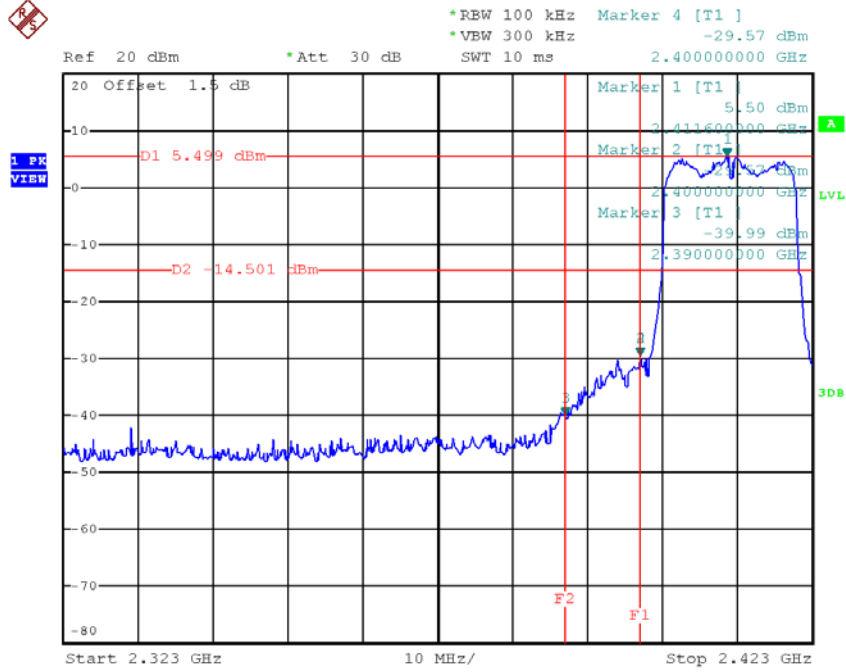

Date: 15.NOV.2017 12:05:13

**TX HT20 mode CH11**

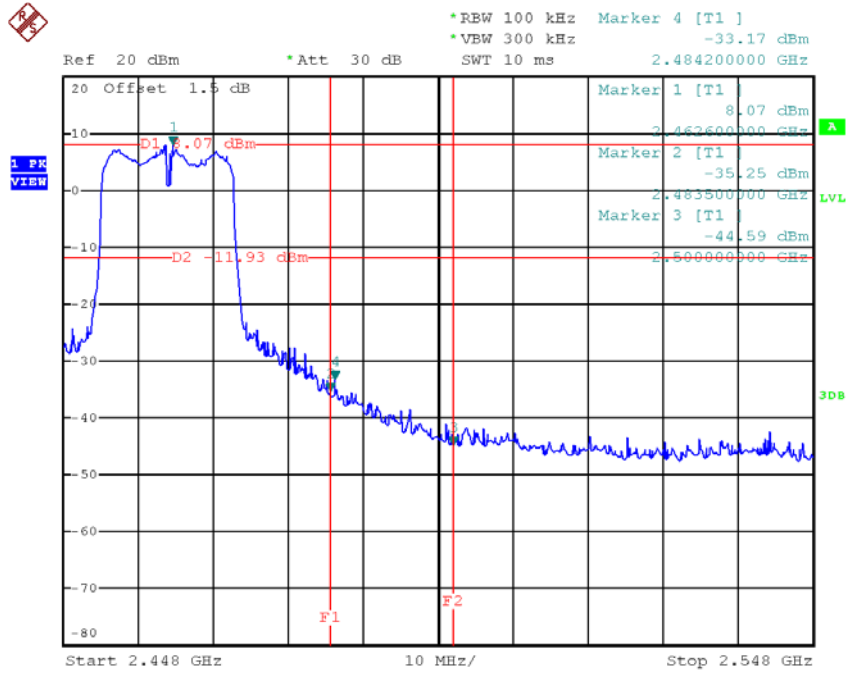

Date: 15.NOV.2017 13:40:35

### TX HT20 mode CH01 (10 Harmonic of the frequency)

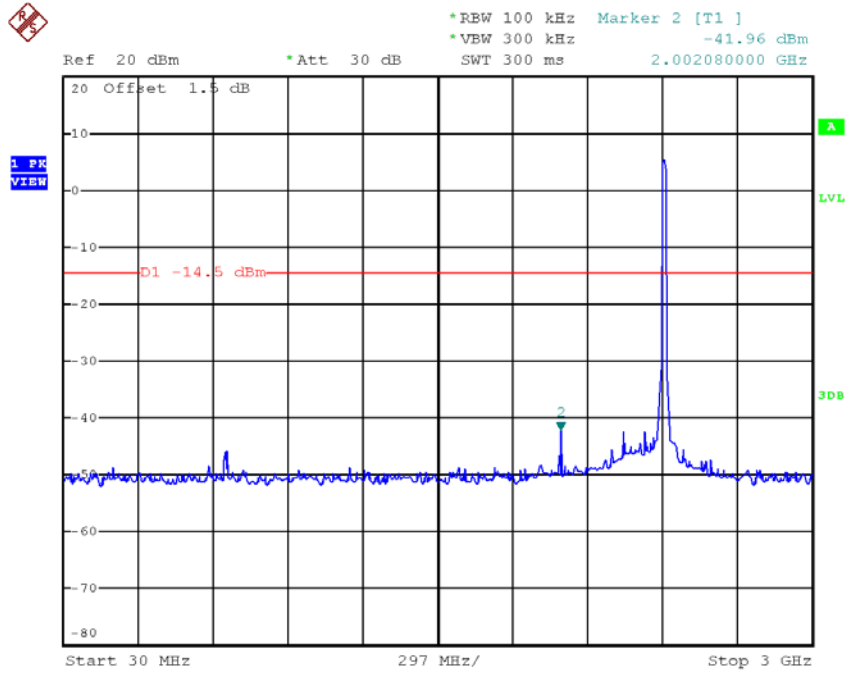

Date: 15.NOV.2017 12:05:26

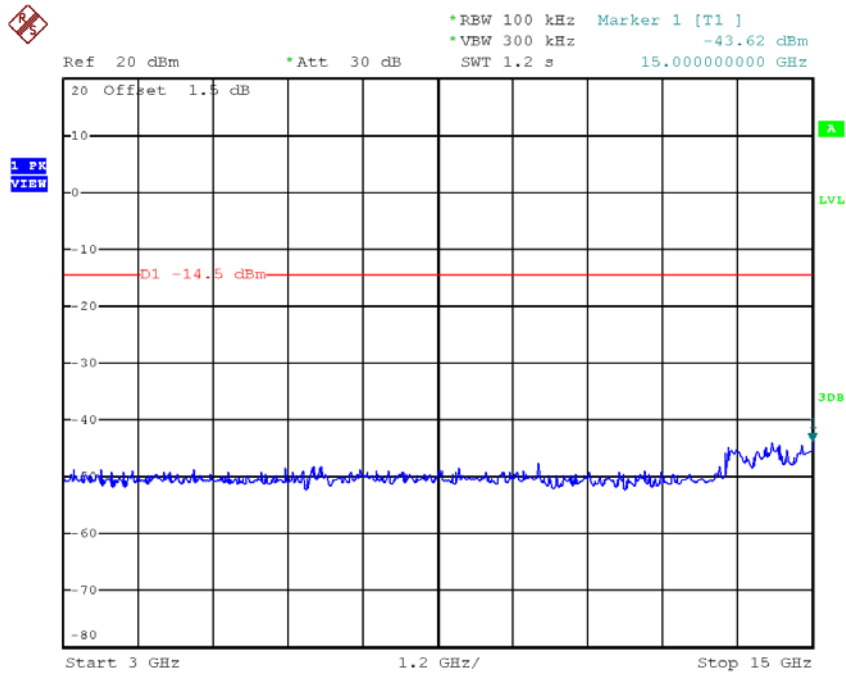

Date: 15.NOV.2017 12:05:34

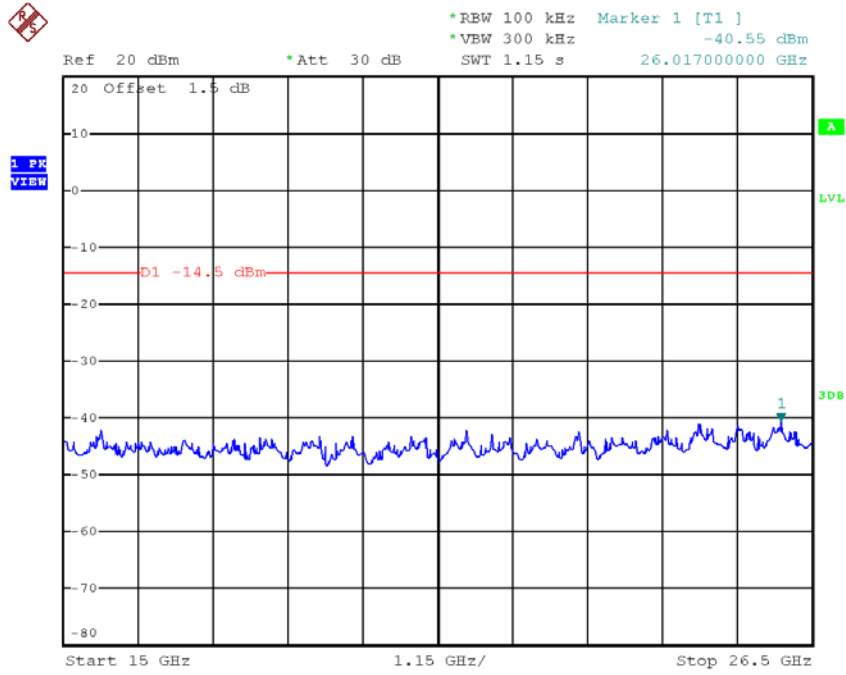

Date: 15.NOV.2017 12:05:42

**TX HT20 mode CH06 (10 Harmonic of the frequency)**

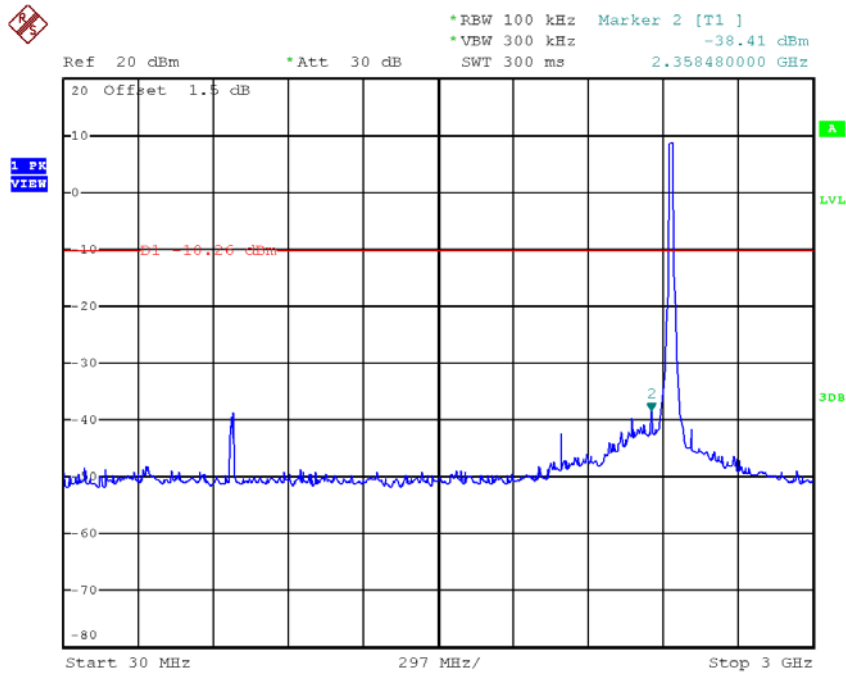

Date: 15.NOV.2017 13:39:18