

# FCC Radio Test Report

## FCC ID: V7TF9-17

This report concerns (check one): Original Grant Class I Change Class II Change

**Project No.** : 1706C276A  
**Equipment** : 600Mbps Wireless N Router  
**Model Name** : F9  
**Applicant** : SHENZHEN TENDA TECHNOLOGY CO.,LTD  
**Address** : 6-8 Floor, Tower E3, No. 1001, Zhongshanyuan Road, Nanshan District, Shenzhen, China. 518052

**Date of Receipt** : Aug. 07, 2017  
**Date of Test** : Aug. 07, 2017 ~ Aug. 18, 2017  
**Issued Date** : Aug. 21, 2017  
**Tested by** : BTL Inc.

**Testing Engineer** : Shawn Xiao  
(Shawn Xiao)

**Technical Manager** : David Mao  
(David Mao)

**Authorized Signatory** : Steven Lu  
(Steven Lu)

# **B T L I N C .**

No.3, Jinshagang 1st Road, Shixia, Dalang Town, Dongguan, Guangdong, China.

TEL: +86-769-8318-3000 FAX: +86-769-8319-6000

### **Declaration**

**BTL** represents to the client that testing is done in accordance with standard procedures as applicable and that test instruments used has been calibrated with standards traceable to international standard(s) and/or national standard(s).

**BTL's** reports apply only to the specific samples tested under conditions. It is manufacture's responsibility to ensure that additional production units of this model are manufactured with the identical electrical and mechanical components. **BTL** shall have no liability for any declarations, inferences or generalizations drawn by the client or others from **BTL** issued reports.

**BTL's** report must not be used by the client to claim product certification, approval, or endorsement by NVLAP, NIST, or any agency of the Federal Government.

This report is the confidential property of the client. As a mutual protection to the clients, the public and **BTL-self**, extracts from the test report shall not be reproduced except in full with **BTL's** authorized written approval.

**BTL's** laboratory quality assurance procedures are in compliance with the **ISO Guide 17025** requirements, and accredited by the conformity assessment authorities listed in this test report.

### **Limitation**

For the use of the authority's logo is limited unless the Test Standard(s)/Scope(s)/Item(s) mentioned in this test report is (are) included in the conformity assessment authorities acceptance respective.

**Table of Contents****Page**

<b>1 . CERTIFICATION</b>	<b>6</b>
<b>2 . SUMMARY OF TEST RESULTS</b>	<b>7</b>
2.1 TEST FACILITY	8
2.2 MEASUREMENT UNCERTAINTY	8
<b>3 . GENERAL INFORMATION</b>	<b>9</b>
3.1 GENERAL DESCRIPTION OF EUT	9
3.2 DESCRIPTION OF TEST MODES	11
3.3 TABLE OF PARAMETERS OF TEXT SOFTWARE SETTING	13
3.4 BLOCK DIAGRAM SHOWING THE CONFIGURATION OF SYSTEM TESTED	14
3.5 DESCRIPTION OF SUPPORT UNITS	14
<b>4 . EMC EMISSION TEST</b>	<b>15</b>
4.1 CONDUCTED EMISSION MEASUREMENT	15
4.1.1 POWER LINE CONDUCTED EMISSION LIMITS	15
4.1.2 TEST PROCEDURE	15
4.1.3 DEVIATION FROM TEST STANDARD	15
4.1.4 TEST SETUP	16
4.1.5 EUT OPERATING CONDITIONS	16
4.1.6 EUT TEST CONDITIONS	16
4.1.7 TEST RESULTS	16
4.2 RADIATED EMISSION MEASUREMENT	17
4.2.1 RADIATED EMISSION LIMITS	17
4.2.2 TEST PROCEDURE	18
4.2.3 DEVIATION FROM TEST STANDARD	18
4.2.4 TEST SETUP	19
4.2.5 EUT OPERATING CONDITIONS	20
4.2.6 EUT TEST CONDITIONS	20
4.2.7 TEST RESULTS (9KHZ TO 30MHZ)	20
4.2.8 TEST RESULTS (30MHZ TO 1000MHZ)	20
4.2.9 TEST RESULTS (ABOVE 1000MHZ)	20
<b>5 . BANDWIDTH TEST</b>	<b>21</b>
5.1 APPLIED PROCEDURES	21
5.1.1 TEST PROCEDURE	21
5.1.2 DEVIATION FROM STANDARD	21
5.1.3 TEST SETUP	21
5.1.4 EUT OPERATION CONDITIONS	21
5.1.5 EUT TEST CONDITIONS	21
5.1.6 TEST RESULTS	21
<b>6 . MAXIMUM PEAK CONDUCTED OUTPUT POWER TEST</b>	<b>22</b>

<b>Table of Contents</b>	<b>Page</b>
<b>6.1 APPLIED PROCEDURES / LIMIT</b>	<b>22</b>
6.1.1 TEST PROCEDURE	22
6.1.2 DEVIATION FROM STANDARD	22
6.1.3 TEST SETUP	22
6.1.4 EUT OPERATION CONDITIONS	22
6.1.5 EUT TEST CONDITIONS	22
6.1.6 TEST RESULTS	22
<b>7 . ANTENNA CONDUCTED SPURIOUS EMISSION</b>	<b>23</b>
7.1 APPLIED PROCEDURES / LIMIT	23
7.1.1 TEST PROCEDURE	23
7.1.2 DEVIATION FROM STANDARD	23
7.1.3 TEST SETUP	23
7.1.4 EUT OPERATION CONDITIONS	23
7.1.5 EUT TEST CONDITIONS	23
7.1.6 TEST RESULTS	23
<b>8 . POWER SPECTRAL DENSITY TEST</b>	<b>24</b>
8.1 APPLIED PROCEDURES / LIMIT	24
8.1.1 TEST PROCEDURE	24
8.1.2 DEVIATION FROM STANDARD	24
8.1.3 TEST SETUP	24
8.1.4 EUT OPERATION CONDITIONS	24
8.1.5 EUT TEST CONDITIONS	24
8.1.6 TEST RESULTS	24
<b>9 . MEASUREMENT INSTRUMENTS LIST</b>	<b>25</b>
<b>10 . EUT TEST PHOTO</b>	<b>27</b>
<b>APPENDIX A - CONDUCTED EMISSION</b>	<b>31</b>
<b>APPENDIX B - RADIATED EMISSION (9KHZ TO 30MHZ)</b>	<b>34</b>
<b>APPENDIX C - RADIATED EMISSION (30MHZ TO 1000MHZ)</b>	<b>39</b>
<b>APPENDIX D - RADIATED EMISSION (ABOVE 1000MHZ)</b>	<b>46</b>
<b>APPENDIX E - BANDWIDTH</b>	<b>95</b>
<b>APPENDIX F - MAXIMUM PEAK CONDUCTED OUTPUT POWER</b>	<b>104</b>
<b>APPENDIX G - ANTENNA CONDUCTED SPURIOUS EMISSION</b>	<b>108</b>
<b>APPENDIX H - POWER SPECTRAL DENSITY</b>	<b>157</b>

### REPORT ISSUED HISTORY

Issued No.	Description	Issued Date
BTL-FCCP-1-1706C276A	Original Issue.	Aug. 21, 2017

## 1. CERTIFICATION

Equipment : 600Mbps Wireless N Router  
Brand Name : Tenda  
Model Name : F9  
Applicant : SHENZHEN TENDA TECHNOLOGY CO.,LTD  
Manufacturer : SHENZHEN TENDA TECHNOLOGY CO.,LTD  
Address : 6-8 Floor, Tower E3, No. 1001, Zhongshanyuan Road, Nanshan District,  
Shenzhen, China. 518052  
Date of Test : Aug. 07, 2017 ~ Aug. 14, 2017  
Test Sample : Engineering Sample  
Standard(s) : FCC Part15, Subpart C:(15.247) / ANSI C63.10-2013

The above equipment has been tested and found compliance with the requirement of the relative standards by BTL Inc.

The test data, data evaluation, and equipment configuration contained in our test report (Ref No. BTL-FCCP-1-1706C276A) were obtained utilizing the test procedures, test instruments, test sites that has been accredited by the Authority of TAF according to the ISO-17025 quality assessment standard and technical standard(s).

## 2. SUMMARY OF TEST RESULTS

Test procedures according to the technical standard(s):

Applied Standard(s): FCC Part15 (15.247) , Subpart C			
Standard(s) Section	Test Item	Judgment	Remark
15.207	Conducted Emission	PASS	
15.247(d)	Antenna conducted Spurious Emission	PASS	
15.247(a)(2)	6dB Bandwidth	PASS	
15.247(b)(3)	Peak Output Power	PASS	
15.247(e)	Power Spectral Density	PASS	
15.203	Antenna Requirement	PASS	
15.247(d)/ 15.205/ 15.209	Transmitter Radiated Emissions	PASS	

**NOTE:**

(1) "N/A" denotes test is not applicable in this test report.

## 2.1 TEST FACILITY

The test facilities used to collect the test data in this report is at the location of No.3,Jinshagang 1st Road, Shixia, Dalang Town, Dongguan, Guangdong, China.

BTL's test firm number for FCC: 319330

## 2.2 MEASUREMENT UNCERTAINTY

Where relevant, the following measurement uncertainty levels have been estimated for tests performed on the EUT as specified in CISPR 16-4-2. The BTL measurement uncertainty is less than the CISPR 16-4-2  $U_{\text{CISPR}}$  requirement.

The reported uncertainty of measurement  $y \pm U$ , where expanded uncertainty  $U$  is based on a standard uncertainty multiplied by a coverage factor of  $k=2$ , providing a level of confidence of approximately 95 %.

### A. Conducted Measurement:

Test Site	Method	Measurement Frequency Range	U, (dB)
DG-C02	CISPR	150 KHz ~ 30MHz	2.32

### B. Radiated Measurement:

Test Site	Method	Measurement Frequency Range	Ant. H / V	U, (dB)
DG-CB03	CISPR	9KHz~30MHz	V	3.79
		9KHz~30MHz	H	3.57
		30MHz ~ 200MHz	V	3.82
		30MHz ~ 200MHz	H	3.78
		200MHz ~ 1,000MHz	V	4.10
		200MHz ~ 1,000MHz	H	4.06
		1GHz~18GHz	V	3.12
		1GHz~18GHz	H	3.68
		18GHz~40GHz	V	4.15
		18GHz~40GHz	H	4.14

Note: Unless specifically mentioned, the uncertainty of measurement has not been taken into account to declare the compliance or non-compliance to the specification.



### 3. GENERAL INFORMATION

#### 3.1 GENERAL DESCRIPTION OF EUT

Equipment	600Mbps Wireless N Router		
Brand Name	Tenda		
Model Name	F9		
Model Difference	N/A		
Product Description	Operation Frequency	2412~2462 MHz	
	Modulation Technology	802.11b:DSSS 802.11g:OFDM 802.11n:OFDM	
	Bit Rate of Transmitter	802.11b: 11/5.5/2/1 Mbps 802.11g: 54/48/36/24/18/12/9/6 Mbps 802.11n up to 300 Mbps	
	Output Power (Max.)	802.11b: 25.19dBm 802.11g: 25.96dBm 802.11n(20MHz): 29.39dBm 802.11n(40MHz): 29.20dBm	
Power Source	DC voltage supplied from AC/DC adapter. Model: BN049-A05009U		
Power Rating	I/P: 100-240V~ 50/60Hz 0.3A O/P: 9V  600mA		

Note:

1. For a more detailed features description, please refer to the manufacturer's specifications or the user's manual.
2. Channel List:

CH01 - CH11 for 802.11b, 802.11g, 802.11n(20MHz) CH03 - CH09 for 802.11n(40MHz)							
Channel	Frequency (MHz)	Channel	Frequency (MHz)	Channel	Frequency (MHz)	Channel	Frequency (MHz)
01	2412	04	2427	07	2442	10	2457
02	2417	05	2432	08	2447	11	2462
03	2422	06	2437	09	2452		

### 3. Table for Filed Antenna

Ant.	Brand	Model Name	Antenna Type	Connector	Gain (dBi)	Note
1	N/A	N/A	Dipole	N/A	5	TX
2	N/A	N/A	Dipole	N/A	5	TX
3	N/A	N/A	Dipole	N/A	5	TX
4	N/A	N/A	Dipole	N/A	5	RX

Note:

(1) The EUT incorporates a MIMO function. Physically, the EUT provides three completed transmitters and four receivers (3T4R).

(2) ANT 1 is the worst case for 1TX

4.

The worst case for 1TX/ 3TX/ as follow:

Operating Mode	1TX	3TX
TX Mode		
802.11b	V (ANT 1)	
802.11g	V (ANT 1)	
802.11n(20MHz)	-	V (ANT 1+ANT 2+ANT 3)
802.11n(40MHz)	-	V (ANT 1+ANT 2+ANT 3)

### 3.2 DESCRIPTION OF TEST MODES

To investigate the maximum EMI emission characteristics generates from EUT, the test system was pre-scanning tested base on the consideration of following EUT operation mode or test configuration mode which possible have effect on EMI emission level. Each of these EUT operation mode(s) or test configuration mode(s) mentioned above was evaluated respectively.

Pretest Mode	Description
Mode 1	TX B MODE CHANNEL 01/06/11
Mode 2	TX G MODE CHANNEL 01/06/11
Mode 3	TX N-20MHZ MODE CHANNEL 01/06/11
Mode 4	TX N-40MHZ MODE CHANNEL 03/06/09
Mode 5	TX MODE

The EUT system operated these modes were found to be the worst case during the pre-scanning test as following:

For Conducted Test	
Final Test Mode	Description
Mode 5	TX MODE

For Radiated Test	
Final Test Mode	Description
Mode 1	TX B MODE CHANNEL 01/06/11
Mode 2	TX G MODE CHANNEL 01/06/11
Mode 3	TX N-20MHZ MODE CHANNEL 01/06/11
Mode 4	TX N-40MHZ MODE CHANNEL 03/06/09

For Band Edge Test	
Final Test Mode	Description
Mode 1	TX B MODE CHANNEL 01/06/11
Mode 2	TX G MODE CHANNEL 01/06/11
Mode 3	TX N-20MHZ MODE CHANNEL 01/06/11
Mode 4	TX N-40MHZ MODE CHANNEL 03/06/09

6dB Spectrum Bandwidth	
Final Test Mode	Description
Mode 1	TX B MODE CHANNEL 01/06/11
Mode 2	TX G MODE CHANNEL 01/06/11
Mode 3	TX N-20MHZ MODE CHANNEL 01/06/11
Mode 4	TX N-40MHZ MODE CHANNEL 03/06/09

Maximum Conducted Output Power	
Final Test Mode	Description
Mode 1	TX B MODE CHANNEL 01/06/11
Mode 2	TX G MODE CHANNEL 01/06/11
Mode 3	TX N-20MHZ MODE CHANNEL 01/06/11
Mode 4	TX N-40MHZ MODE CHANNEL 03/06/09

Power Spectral Density	
Final Test Mode	Description
Mode 1	TX B MODE CHANNEL 01/06/11
Mode 2	TX G MODE CHANNEL 01/06/11
Mode 3	TX N-20MHZ MODE CHANNEL 01/06/11
Mode 4	TX N-40MHZ MODE CHANNEL 03/06/09

**Note:**

- (1) The measurements are performed at the high, middle, low available channels.
- (2) 802.11b mode: DBPSK (1Mbps)  
 802.11g mode: OFDM (6Mbps)  
 802.11n HT20 mode : BPSK (13Mbps)  
 802.11n HT40 mode : BPSK (27Mbps)  
 For radiated emission tests, the highest output powers were set for final test.
- (3) For radiated below 1G test, the 802.11b is found to be the worst case and recorded.
- (4) The EUT was programmed to be in continuously transmitting mode and the transmit duty cycle is not less than 98%.

### 3.3 TABLE OF PARAMETERS OF TEXT SOFTWARE SETTING

During testing, channel & power controlling software provided by the customer was used to control the operating channel as well as the output power level. The RF output power selection is for the setting of RF output power expected by the customer and is going to be fixed on the firmware of the final end product power parameters of WLAN

Test software version	MP_TEST		
Frequency (MHz)	2412	2437	2462
802.11b	49	57	55
802.11g	51	63	50
802.11n (20MHz)	45/48/48	45/48/48	45/48/48
Frequency (MHz)	2422	2437	2452
802.11n (40MHz)	45/49/49	45/49/49	45/49/49

### 3.4 BLOCK DIAGRAM SHOWING THE CONFIGURATION OF SYSTEM TESTED

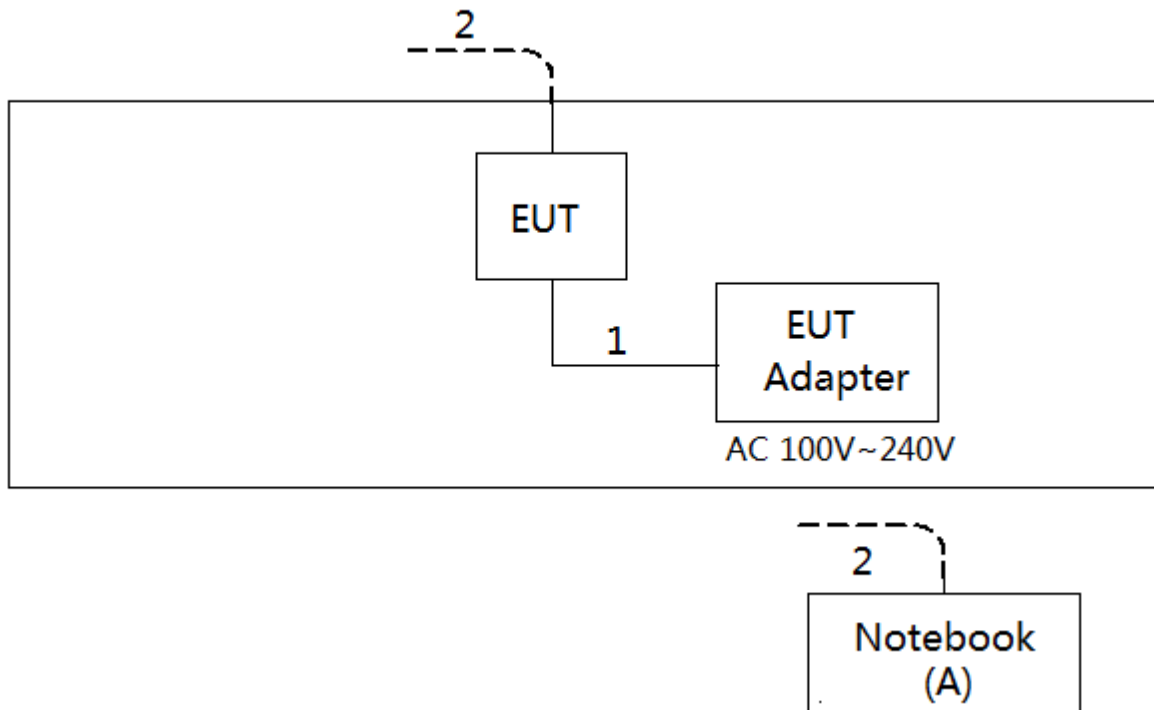

### 3.5 DESCRIPTION OF SUPPORT UNITS

The EUT has been tested as an independent unit together with other necessary accessories or support units. The following support units or accessories were used to form a representative test configuration during the tests.

Item	Equipment	Mfr/Brand	Model/Type No.	FCC ID	Series No.
A	Notebook	Lenovo	INSPIRON 1420	DOC	JX193A01SDC2

Item	Shielded Type	Ferrite Core	Length	Note
1	NO	NO	1.2m	AC Cable
2	NO	NO	10m	RJ-45 Cable

## 4. EMC EMISSION TEST

### 4.1 CONDUCTED EMISSION MEASUREMENT

#### 4.1.1 POWER LINE CONDUCTED EMISSION LIMITS (Frequency Range 150KHz-30MHz)

Frequency of Emission (MHz)	Conducted Limit (dB $\mu$ V)	
	Quasi-peak	Average
0.15 -0.50	66 to 56*	56 to 46*
0.50 -5.0	56	46
5.0 -30.0	60	50

Note:

- (1) The limit of " \* " decreases with the logarithm of the frequency
- (2) The test result calculated as following:  
 Measurement Value = Reading Level + Correct Factor  
 Correct Factor = Insertion Loss + Cable Loss + Attenuator Factor(if use)  
 Margin Level = Measurement Value - Limit Value

The following table is the setting of the receiver

Receiver Parameters	Setting
Attenuation	10 dB
Start Frequency	0.15 MHz
Stop Frequency	30 MHz
IF Bandwidth	9 KHz

#### 4.1.2 TEST PROCEDURE

- a. The EUT was placed 0.8 meters from the horizontal ground plane with EUT being connected to the power mains through a line impedance stabilization network (LISN). All other support equipment powered from additional LISN(s). The LISN provide 50 Ohm/ 50uH of coupling impedance for the measuring instrument.
- b. Interconnecting cables that hang closer than 40 cm to the ground plane shall be folded back and forth in the center forming a bundle 30 to 40 cm long.
- c. I/O cables that are not connected to a peripheral shall be bundled in the center. The end of the cable may be terminated, if required, using the correct terminating impedance. The overall length shall not exceed 1 m.
- d. LISN at least 80 cm from nearest part of EUT chassis.
- e. For the actual test configuration, please refer to the related Item -EUT Test Photos.

#### 4.1.3 DEVIATION FROM TEST STANDARD

No deviation

#### 4.1.4 TEST SETUP

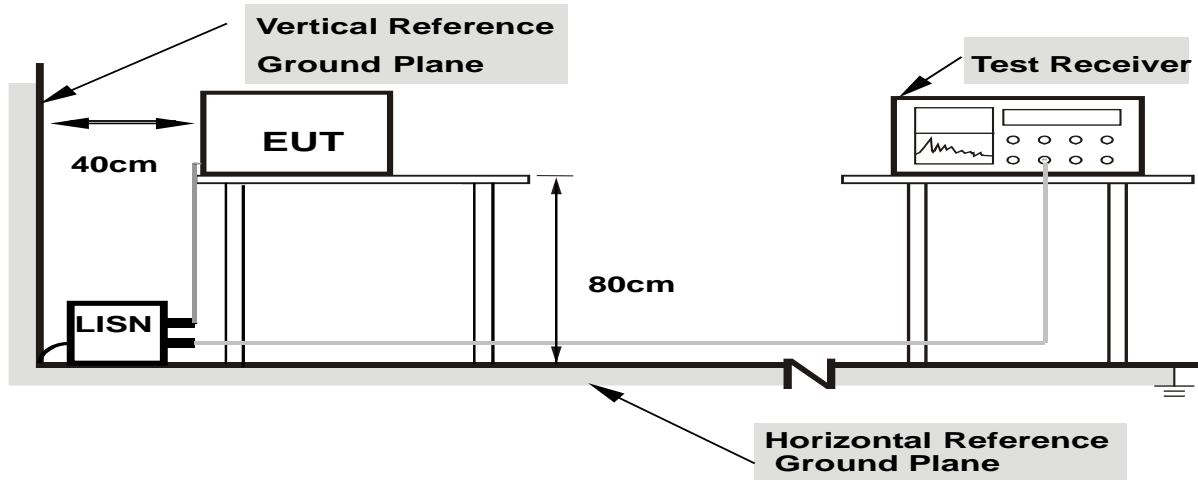

- Note:**
- 1.Support units were connected to second LISN.
  - 2.Both of LISNs (AMN) are 80 cm from EUT and at least 80 from other units and other metal planes

#### 4.1.5 EUT OPERATING CONDITIONS

The EUT was placed on the test table and programmed in normal function.

#### 4.1.6 EUT TEST CONDITIONS

Temperature: 25°C    Relative Humidity: 55%    Test Voltage: AC 120V/60Hz

#### 4.1.7 TEST RESULTS

Please refer to the Appendix A.



## 4.2 RADIATED EMISSION MEASUREMENT

### 4.2.1 RADIATED EMISSION LIMITS

In case the emission fall within the restricted band specified on 15.205(a), then the 15.209(a) limit in the table below has to be followed.

#### LIMITS OF RADIATED EMISSION MEASUREMENT (9KHz-1000MHz)

Frequency (MHz)	Field Strength (microvolts/meter)	Measurement Distance (meters)
0.009~0.490	2400/F(KHz)	300
0.490~1.705	24000/F(KHz)	30
1.705~30.0	30	30
30~88	100	3
88~216	150	3
216~960	200	3
960~1000	500	3

#### LIMITS OF RADIATED EMISSION MEASUREMENT (Above 1000MHz)

Frequency (MHz)	(dBuV/m) (at 3 meters)	
	PEAK	AVERAGE
Above 1000	74	54

**Notes:**

- (1) The limit for radiated test was performed according to FCC PART 15C.
- (2) The tighter limit applies at the band edges.
- (3) Emission level (dBuV/m)=20log Emission level (uV/m).
- (4) The test result calculated as following:  
 Measurement Value = Reading Level + Correct Factor  
 Correct Factor = Antenna Factor + Cable Loss - Amplifier Gain(if use)  
 Margin Level = Measurement Value - Limit Value

Spectrum Parameter	Setting
Attenuation	Auto
Start Frequency	1000 MHz
Stop Frequency	10th carrier harmonic
RBW / VBW (Emission in restricted band)	1MHz / 3MHz for Peak, 1MHz / 1/T for Average

Receiver Parameter	Setting
Attenuation	Auto
Start ~ Stop Frequency	9KHz~90KHz for PK/AVG detector
Start ~ Stop Frequency	90KHz~110KHz for QP detector
Start ~ Stop Frequency	110KHz~490KHz for PK/AVG detector
Start ~ Stop Frequency	490KHz~30MHz for QP detector
Start ~ Stop Frequency	30MHz~1000MHz for QP detector

#### 4.2.2 TEST PROCEDURE

- a. The measuring distance of 3 m shall be used for measurements. The EUT was placed on the top of a rotating table 0.8 meter above the ground at a 3 meter semi-anechoic chamber. The table was rotated 360 degrees to determine the position of the highest radiation.(below 1GHz)
- b. The measuring distance of 3 m shall be used for measurements. The EUT was placed on the top of a rotating table 1.5 meter above the ground at a 3 meter semi-anechoic chamber. The table was rotated 360 degrees to determine the position of the highest radiation.(above 1GHz)
- c. The height of the equipment or of the substitution antenna shall be 0.8m or 1.5m; the height of the test antenna shall vary between 1 m to 4 m. Both horizontal and vertical polarizations of the antenna are set to make the measurement.
- d. For each suspected emission, the EUT was arranged to its worst case and then the antenna was tuned to heights find the maximum reading (used Bore sight function).
- e. The receiver system was set to peak and average detect function and specified bandwidth with maximum hold mode when the test frequency is above 1GHz.
- f. The initial step in collecting radiated emission data is a receiver peak detector mode pre-scanning the measurement frequency range. Significant peaks are then marked and then Quasi Peak detector mode re-measured.
- g. All readings are Peak unless otherwise stated QP in column of Note. Peak denotes that the Peak reading compliance with the QP Limits and then QP Mode measurement didn't perform. (below 1GHz)
- h. All readings are Peak Mode value unless otherwise stated AVG in column of Note. If the Peak Mode Measured value compliance with the Peak Limits and lower than AVG Limits, the EUT shall be deemed to meet both Peak & AVG Limits and then only Peak Mode was measured, but AVG Mode didn't perform. (above 1GHz)
- i. For the actual test configuration, please refer to the related Item -EUT Test Photos.

#### 4.2.3 DEVIATION FROM TEST STANDARD

No deviation

**4.2.4 TEST SETUP**

(A) Radiated Emission Test Set-Up Frequency Below 1 GHz

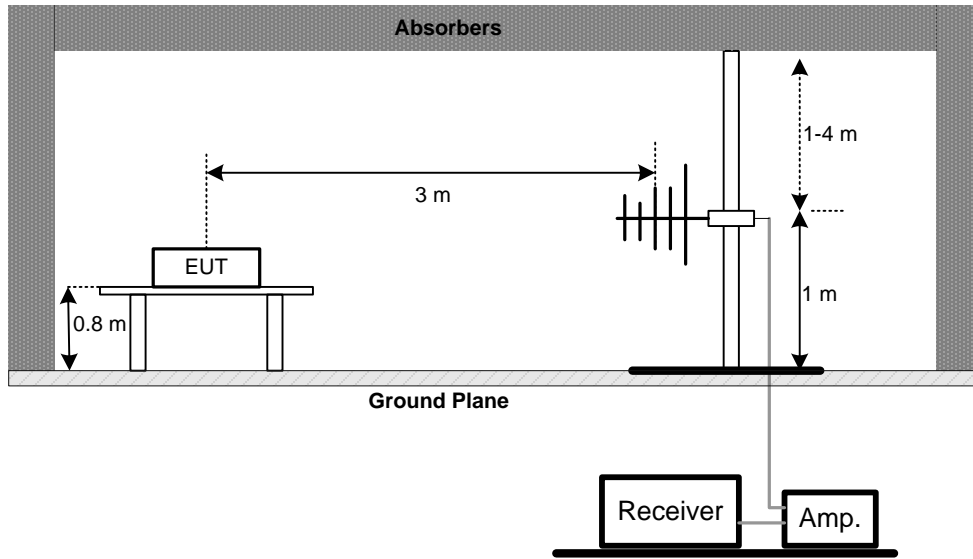

(B) Radiated Emission Test Set-Up Frequency Above 1 GHz

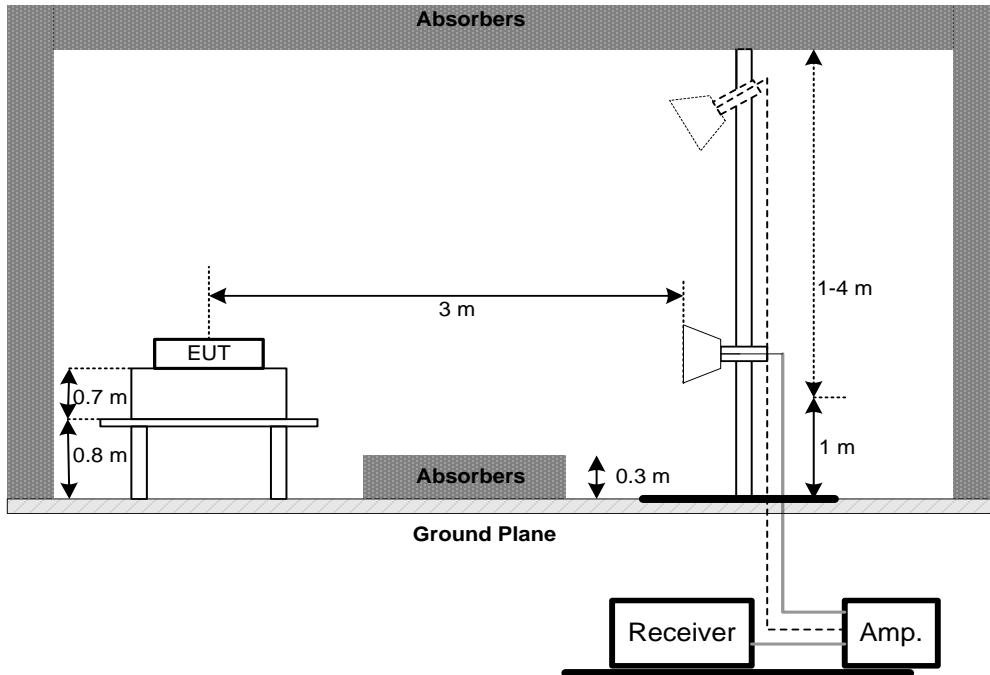

(C) For Radiated Emissions Below 30MHz

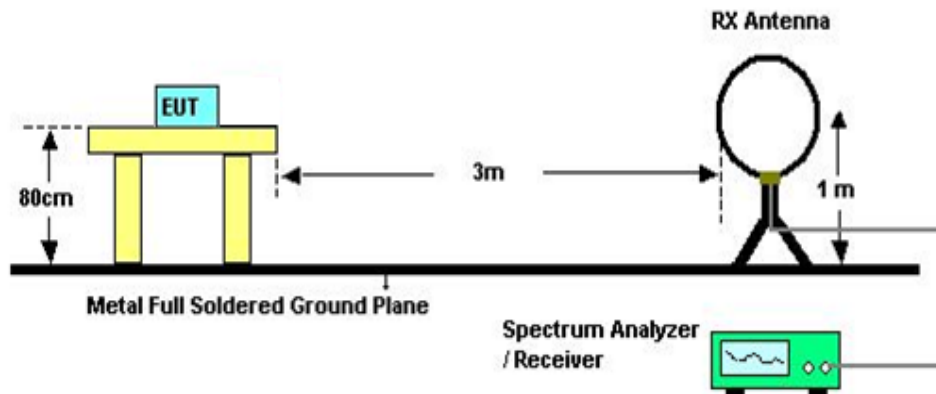

#### 4.2.5 EUT OPERATING CONDITIONS

The EUT was programmed to be in continuously transmitting mode.

#### 4.2.6 EUT TEST CONDITIONS

Temperature: 25°C    Relative Humidity: 55%    Test Voltage: AC 120V/60Hz

#### 4.2.7 TEST RESULTS (9KHZ TO 30MHZ)

Please refer to the Appendix B

Remark:

- (1) The amplitude of spurious emissions which are attenuated by more than 20 dB below the permissible value has no need to be reported.
- (2) Distance extrapolation factor =  $40 \log (\text{specific distance} / \text{test distance})$  (dB).
- (3) Limit line = specific limits (dBuV) + distance extrapolation factor.

#### 4.2.8 TEST RESULTS (30MHZ TO 1000MHZ)

Please refer to the Appendix C.

#### 4.2.9 TEST RESULTS (ABOVE 1000MHZ)

Please refer to the Appendix D.

Remark:

- (1) No limit: This is fundamental signal, the judgment is not applicable.  
For fundamental signal judgment was referred to Peak output test.

## 5. BANDWIDTH TEST

### 5.1 APPLIED PROCEDURES

FCC Part15 (15.247) , Subpart C			
Section	Test Item	Frequency Range (MHz)	Result
15.247(a)(2)	Bandwidth	2400-2483.5	PASS

#### 5.1.1 TEST PROCEDURE

- a. The EUT was directly connected to the spectrum analyzer and antenna output port as show in the block diagram below,
- b. Spectrum Setting: RBW= 100KHz, VBW=300KHz, Sweep time = 2.5 ms.

#### 5.1.2 DEVIATION FROM STANDARD

No deviation.

#### 5.1.3 TEST SETUP



#### 5.1.4 EUT OPERATION CONDITIONS

The EUT was programmed to be in continuously transmitting mode.

#### 5.1.5 EUT TEST CONDITIONS

Temperature: 25°C    Relative Humidity: 55%    Test Voltage: AC 120V/60Hz

#### 5.1.6 TEST RESULTS

Please refer to the Appendix E.

## 6. MAXIMUM PEAK CONDUCTED OUTPUT POWER TEST

### 6.1 APPLIED PROCEDURES / LIMIT

FCC Part15 (15.247) , Subpart C				
Section	Test Item	Limit	Frequency Range (MHz)	Result
15.247(b)(3)	Maximum Output Power	1 Watt or 30dBm	2400-2483.5	PASS

#### 6.1.1 TEST PROCEDURE

- a. The EUT was directly connected to the power meter and antenna output port as show in the block diagram below,
- b. The maximum peak conducted output power was performed in accordance with method 9.1.2 of FCC KDB 558074 D01 DTS Meas Guidance and FCC KDB 662911 D01 Multiple Transmitter Output.

#### 6.1.2 DEVIATION FROM STANDARD

No deviation.

#### 6.1.3 TEST SETUP



#### 6.1.4 EUT OPERATION CONDITIONS

The EUT was programmed to be in continuously transmitting mode.

#### 6.1.5 EUT TEST CONDITIONS

Temperature: 25°C    Relative Humidity: 55%    Test Voltage: AC 120V/60Hz

#### 6.1.6 TEST RESULTS

Please refer to the Appendix F.

## 7. ANTENNA CONDUCTED SPURIOUS EMISSION

### 7.1 APPLIED PROCEDURES / LIMIT

In any 100 kHz bandwidth outside the frequency band in which the spread spectrum or digitally modulated device is operating, the RF power that is produced shall be at least 20 dB below that in the 100 kHz bandwidth within the band that contains the highest level of the desired power, based on either an RF conducted or a radiated measurement, provided that the transmitter demonstrates compliance with the peak conducted power limits.

#### 7.1.1 TEST PROCEDURE

- a. The EUT was directly connected to the spectrum analyzer and antenna output port as show in the block diagram below,
- b. Spectrum Setting: RBW= 100KHz, VBW=300KHz, Sweep time = Auto.
- c. Offset=antenna gain+cable loss

#### 7.1.2 DEVIATION FROM STANDARD

No deviation.

#### 7.1.3 TEST SETUP



#### 7.1.4 EUT OPERATION CONDITIONS

The EUT was programmed to be in continuously transmitting mode.

#### 7.1.5 EUT TEST CONDITIONS

Temperature: 25°C    Relative Humidity: 55%    Test Voltage: AC 120V/60Hz

#### 7.1.6 TEST RESULTS

Please refer to the Appendix G.

## 8. POWER SPECTRAL DENSITY TEST

### 8.1 APPLIED PROCEDURES / LIMIT

FCC Part15 (15.247) , Subpart C				
Section	Test Item	Limit	Frequency Range (MHz)	Result
15.247(e)	Power Spectral Density	8 dBm (in any 3KHz)	2400-2483.5	PASS

#### 8.1.1 TEST PROCEDURE

- a. The EUT was directly connected to the spectrum analyzer and antenna output port as show in the block diagram below,
- b. Spectrum Setting: RBW=3KHz, VBW=10KHz, Sweep time = Auto.

#### 8.1.2 DEVIATION FROM STANDARD

No deviation.

#### 8.1.3 TEST SETUP



#### 8.1.4 EUT OPERATION CONDITIONS

The EUT was programmed to be in continuously transmitting mode.

#### 8.1.5 EUT TEST CONDITIONS

Temperature: 25°C    Relative Humidity: 55%    Test Voltage: AC 120V/60Hz

#### 8.1.6 TEST RESULTS

Please refer to the Appendix H.



## 9. MEASUREMENT INSTRUMENTS LIST

Conducted Emission					
Item	Kind of Equipment	Manufacturer	Type No.	Serial No.	Calibrated until
1	EMI Test Receiver	R&S	ESCI	100382	Mar. 26, 2018
2	LISN	EMCO	3816/2	52765	Mar. 26, 2018
3	50Ω Terminator	SHX	TF2-3G-A	8122901	Mar. 26, 2018
4	TWO-LINE V-NETWORK	R&S	ENV216	101447	Mar. 26, 2018
5	Cable	N/A	RG223	12m	Oct. 20, 2017
6	Measurement Software	Farad	EZ-EMC Ver.NB-03A1-01	N/A	N/A

Radiated Emission Below 1GHz					
Item	Kind of Equipment	Manufacturer	Type No.	Serial No.	Calibrated until
1	Antenna	Schwarzbeck	VULB9160	9160-3232	Mar. 26, 2018
2	Amplifier	HP	8447D	2944A09673	Oct. 20, 2017
3	Receiver	Agilent	N9038A	MY52130039	Sep. 04, 2017
4	Cable	emci	LMR-400(30MHz-1 GHz)(8m+5m)	N/A	Jun. 26, 2018
5	Controller	CT	SC100	N/A	N/A
6	Controller	MF	MF-7802	MF780208416	N/A
7	Measurement Software	Farad	EZ-EMC Ver.NB-03A1-01	N/A	N/A

Radiated Emission Above 1GHz					
Item	Kind of Equipment	Manufacturer	Type No.	Serial No.	Calibrated until
1	Double Ridged Guide Antenna	ETS	3115	75789	Mar. 26, 2018
2	Broad-Band Horn Antenna	Schwarzbeck	BBHA 9170	9170319	Jun. 08, 2018
3	Amplifier	Agilent	8449B	3008A02274	May. 16, 2018
4	Microwave Preamplifier With Adaptor	EMC INSTRUMENT	EMC2654045	980039 & HA01	Mar. 26, 2018
5	Receiver	Agilent	N9038A	MY52130039	Sep. 04, 2017
6	Antenna	EM	EM-6876-1	230	Jul. 07, 2018
7	Controller	CT	SC100	N/A	N/A
8	Controller	MF	MF-7802	MF780208416	N/A
9	Cable	emci	EMC104-SM-SM-1 2000(12m)	N/A	Jun. 26, 2018
10	Measurement Software	Farad	EZ-EMC Ver.NB-03A1-01	N/A	N/A

6dB Bandwidth					
Item	Kind of Equipment	Manufacturer	Type No.	Serial No.	Calibrated until
1	Spectrum Analyzer	R&S	FSP40	100185	Sep. 04, 2017

Peak Output Power					
Item	Kind of Equipment	Manufacturer	Type No.	Serial No.	Calibrated until
1	Power Meter	ANRITSU	ML2495A	1128009	Mar. 26, 2018
2	Pulse Power Sensor	ANRITSU	MA 2411B	1027500	Mar. 26, 2018

Antenna Conducted Spurious Emission					
Item	Kind of Equipment	Manufacturer	Type No.	Serial No.	Calibrated until
1	Spectrum Analyzer	R&S	FSP40	100185	Sep. 04, 2017

Power Spectral Density					
Item	Kind of Equipment	Manufacturer	Type No.	Serial No.	Calibrated until
1	Spectrum Analyzer	R&S	FSP40	100185	Sep. 04, 2017

Remark: "N/A" denotes no model name, serial no. or calibration specified.  
 All calibration period of equipment list is one year.

**10. EUT TEST PHOTO**

**Conducted Measurement Photos**



**Radiated Measurement Photos**

**9KHz to 30MHz**

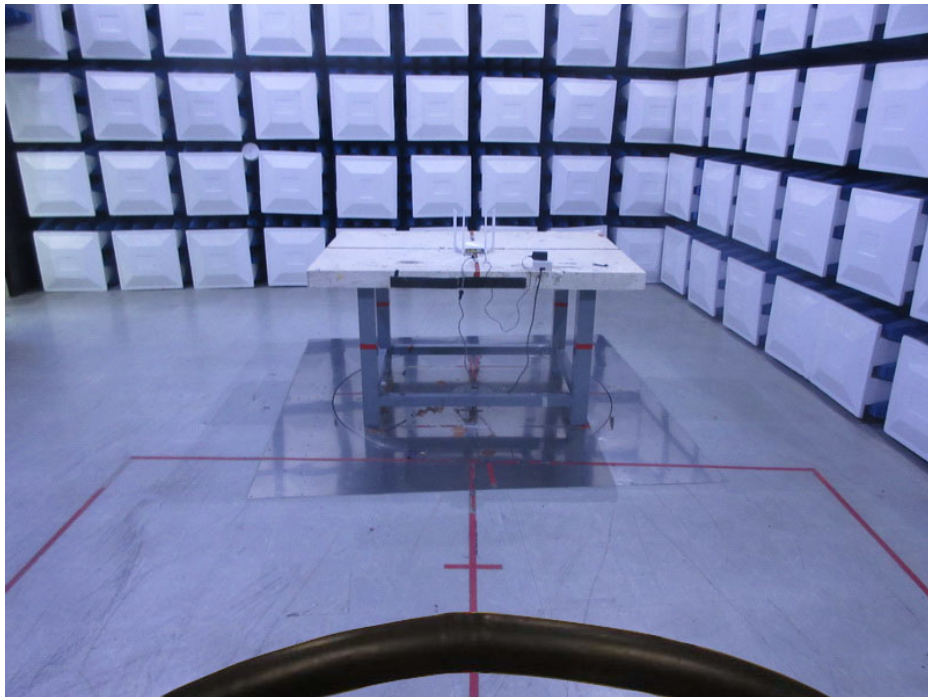
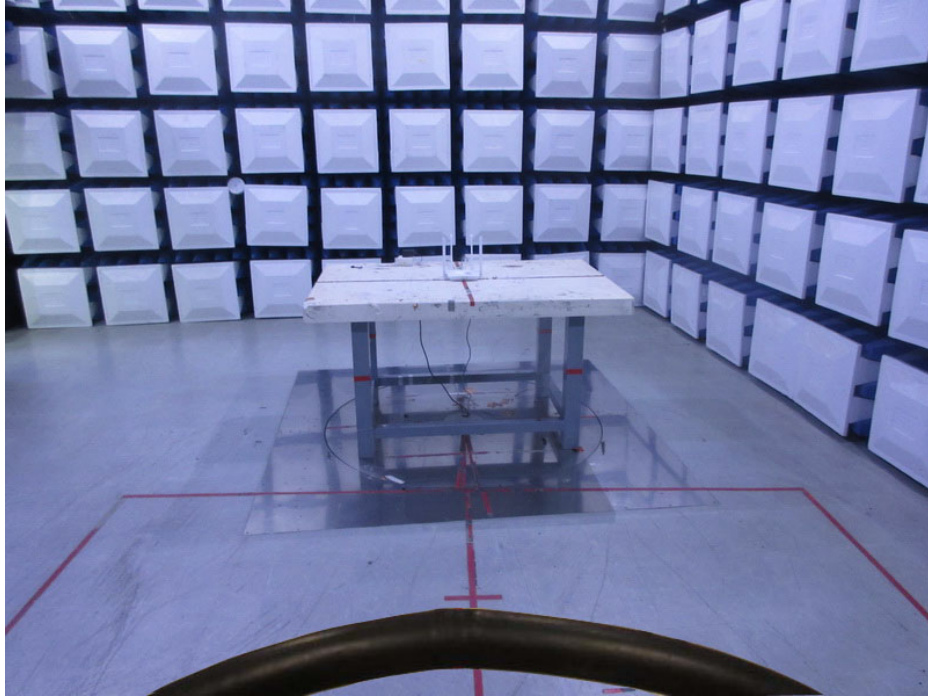

**Radiated Measurement Photos**

**30MHz to 1000MHz**

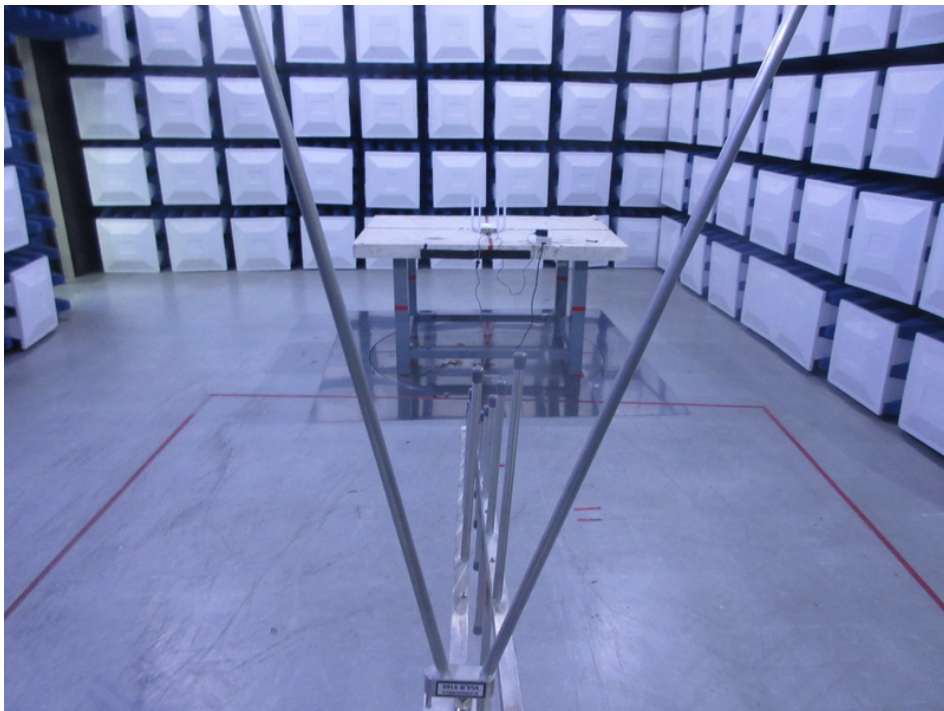

**Radiated Measurement Photos**

**Above 1000MHz**

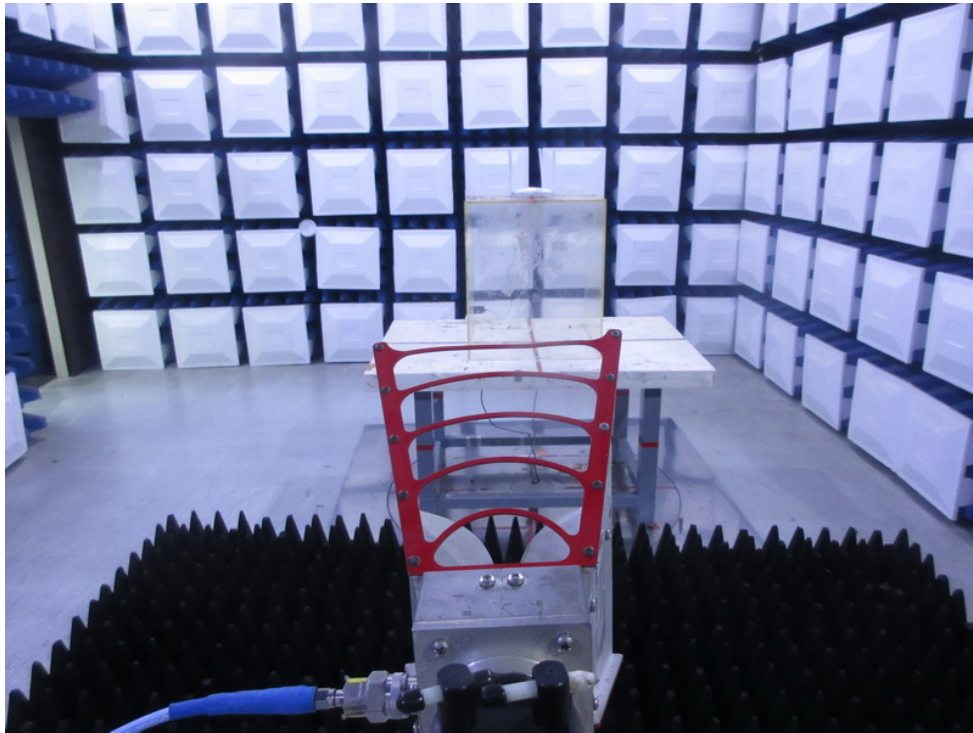

## APPENDIX A - CONDUCTED EMISSION

Test Mode : TX MODE

**Line**

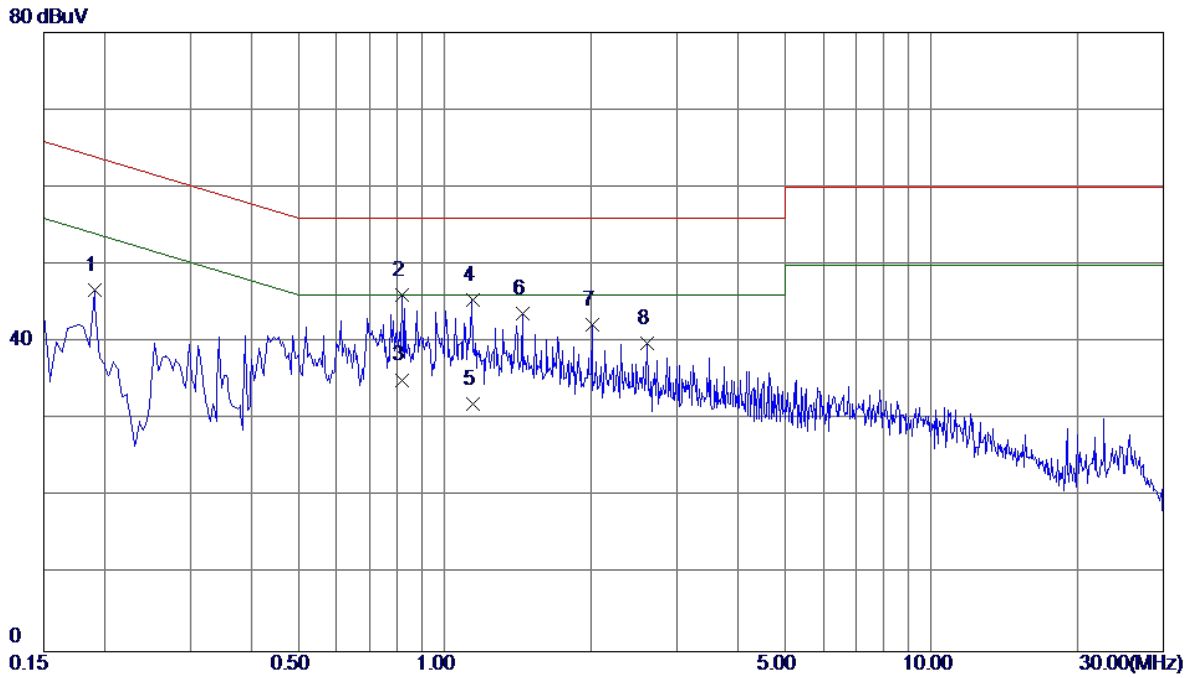

No.	Freq. MHz	Reading Level dBuV	Correct Factor dB	Measure ment dBuV	Limit dBuV	Margin dB	Detector	Comment
1	0.1905	36.96	9.77	46.73	64.01	-17.28	Peak	
2 *	0.8160	36.28	9.82	46.10	56.00	-9.90	Peak	
3	0.8160	25.30	9.82	35.12	46.00	-10.88	AVG	
4	1.1400	35.58	9.86	45.44	56.00	-10.56	Peak	
5	1.1400	22.10	9.86	31.96	46.00	-14.04	AVG	
6	1.4460	33.84	9.90	43.74	56.00	-12.26	Peak	
7	2.0085	32.36	9.92	42.28	56.00	-13.72	Peak	
8	2.6070	29.86	9.97	39.83	56.00	-16.17	Peak	



Test Mode : TX MODE

**Neutral**

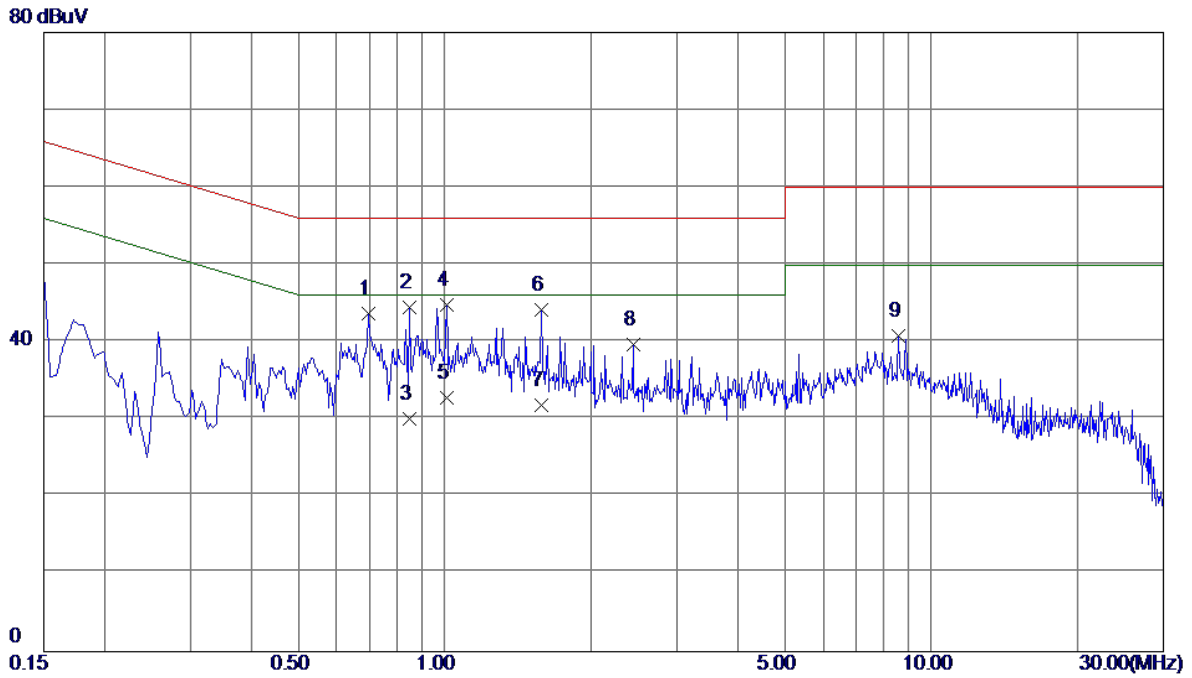

No.	Freq. MHz	Reading Level dBuV	Correct Factor dB	Measure ment dBuV	Limit dBuV	Margin dB	Detector	Comment
1	0.6990	33.98	9.72	43.70	56.00	-12.30	Peak	
2	0.8475	34.82	9.73	44.55	56.00	-11.45	Peak	
3	0.8475	20.29	9.73	30.02	46.00	-15.98	AVG	
4 *	1.0095	35.08	9.75	44.83	56.00	-11.17	Peak	
5	1.0095	23.10	9.75	32.85	46.00	-13.15	AVG	
6	1.5809	34.32	9.80	44.12	56.00	-11.88	Peak	
7	1.5809	22.09	9.80	31.89	46.00	-14.11	AVG	
8	2.4405	29.85	9.86	39.71	56.00	-16.29	Peak	
9	8.5470	30.55	10.19	40.74	60.00	-19.26	Peak	

## APPENDIX B - RADIATED EMISSION (9KHZ TO 30MHZ)

Test Mode: TX B MODE CHANNEL 01

Ant 0°

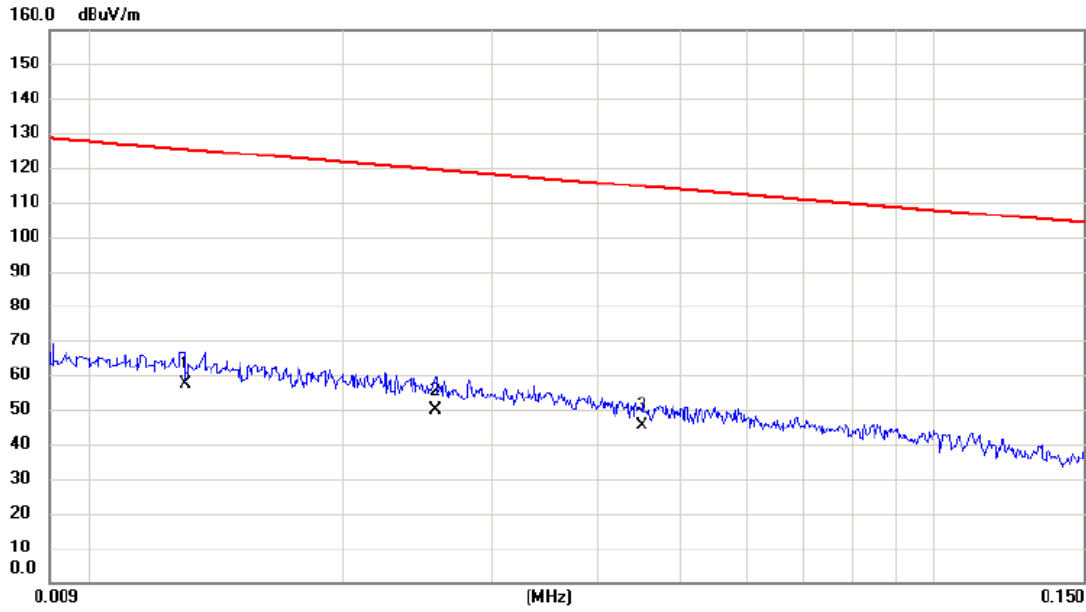

No.	Mk.	Freq. MHz	Reading Level dBuV	Correct Factor dB	Measure- ment dBuV/m	Limit dBuV/m	Margin dB	Detector	Comment
1	*	0.0130	36.80	20.53	57.33	125.33	-68.00	AVG	
2		0.0257	30.45	19.45	49.90	119.41	-69.51	AVG	
3		0.0450	26.47	18.87	45.34	114.54	-69.20	AVG	

Test Mode: TX B MODE CHANNEL 01

Ant 0°

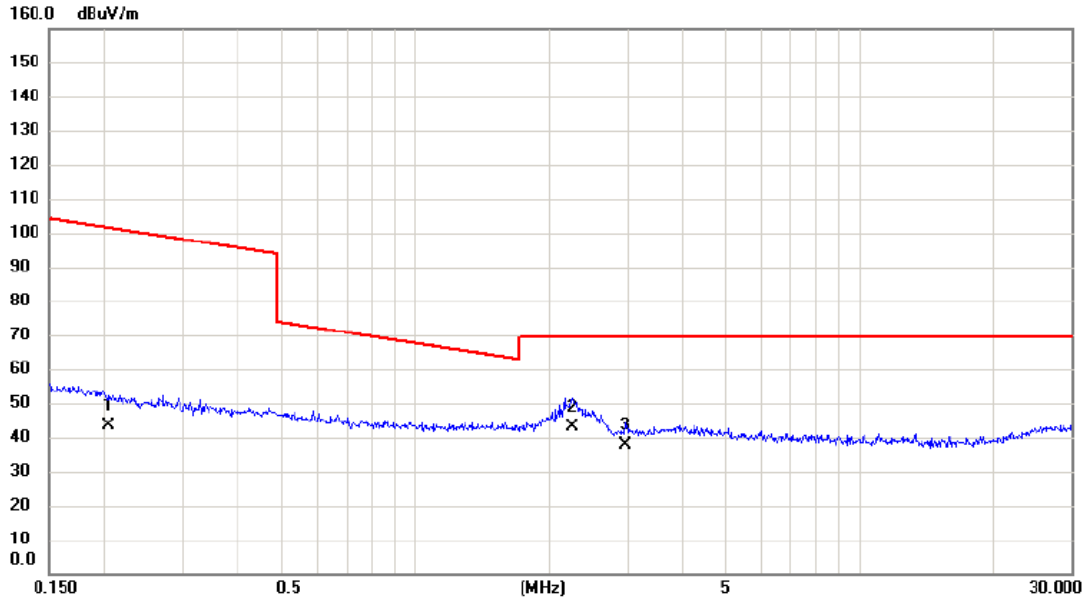

No.	Mk.	Freq. MHz	Reading Level dBuV	Correct Factor dB	Measure- ment dBuV/m	Limit dBuV/m	Margin dB	Detector	Comment
1		0.2040	26.49	16.79	43.28	101.41	-58.13	AVG	
2	*	2.2486	27.63	15.44	43.07	69.54	-26.47	QP	
3		2.9776	22.46	15.24	37.70	69.54	-31.84	QP	

Test Mode: TX B MODE CHANNEL 01

Ant 90°

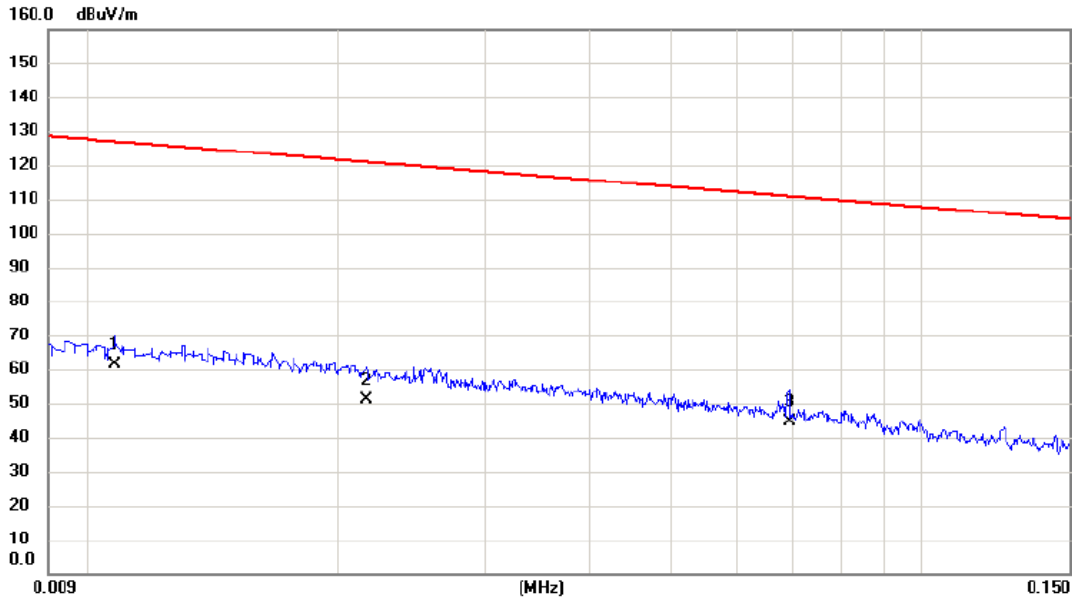

No.	Mk.	Freq. MHz	Reading Level dBuV	Correct Factor dB	Measure- ment dBuV/m	Limit dBuV/m	Margin dB	Detector	Comment
1	*	0.0108	40.45	20.82	61.27	126.94	-65.67	AVG	
2		0.0216	31.59	19.57	51.16	120.92	-69.76	AVG	
3		0.0694	26.38	18.34	44.72	110.78	-66.06	AVG	

Test Mode: TX B MODE CHANNEL 01

Ant 90°

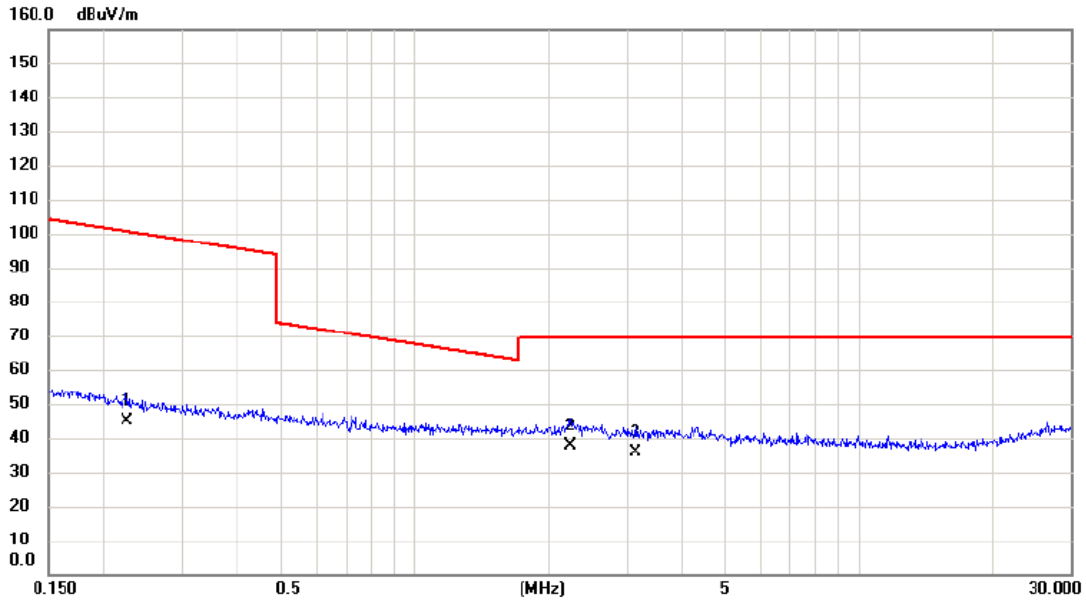

No.	Mk.	Freq. MHz	Reading Level dBuV	Correct Factor dB	Measure- ment dBuV/m	Limit dBuV/m	Margin dB	Detector	Comment
1		0.2244	28.46	16.73	45.19	100.59	-55.40	AVG	
2	*	2.2367	22.32	15.44	37.76	69.54	-31.78	QP	
3		3.1397	20.59	15.19	35.78	69.54	-33.76	QP	

## APPENDIX C - RADIATED EMISSION (30MHZ TO 1000MHZ)

Test Mode: TX B MODE CHANNEL 01

**Vertical**

80 dBuV/m

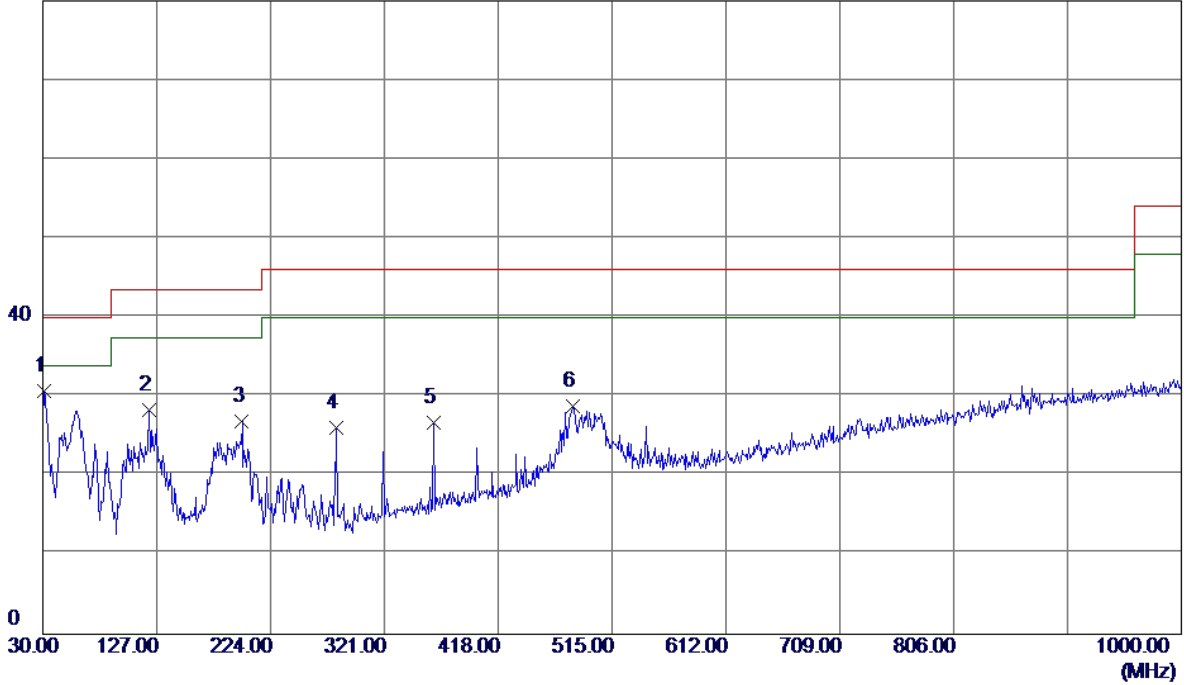

No.	Freq. MHz	Reading Level dBuV/m	Correct Factor dB	Measure ment dBuV/m	Limit dBuV/m	Margin dB	Detector	Comment
1 *	30.9700	45.86	-15.14	30.72	40.00	-9.28	Peak	
2	120.2100	43.76	-15.38	28.38	43.50	-15.12	Peak	
3	199.7500	40.56	-13.73	26.83	43.50	-16.67	Peak	
4	280.2600	40.91	-14.76	26.15	46.00	-19.85	Peak	
5	362.7100	38.55	-11.80	26.75	46.00	-19.25	Peak	
6	482.0200	38.03	-9.16	28.87	46.00	-17.13	Peak	



Test Mode: TX B MODE CHANNEL 01

**Horizontal**

80 dBuV/m

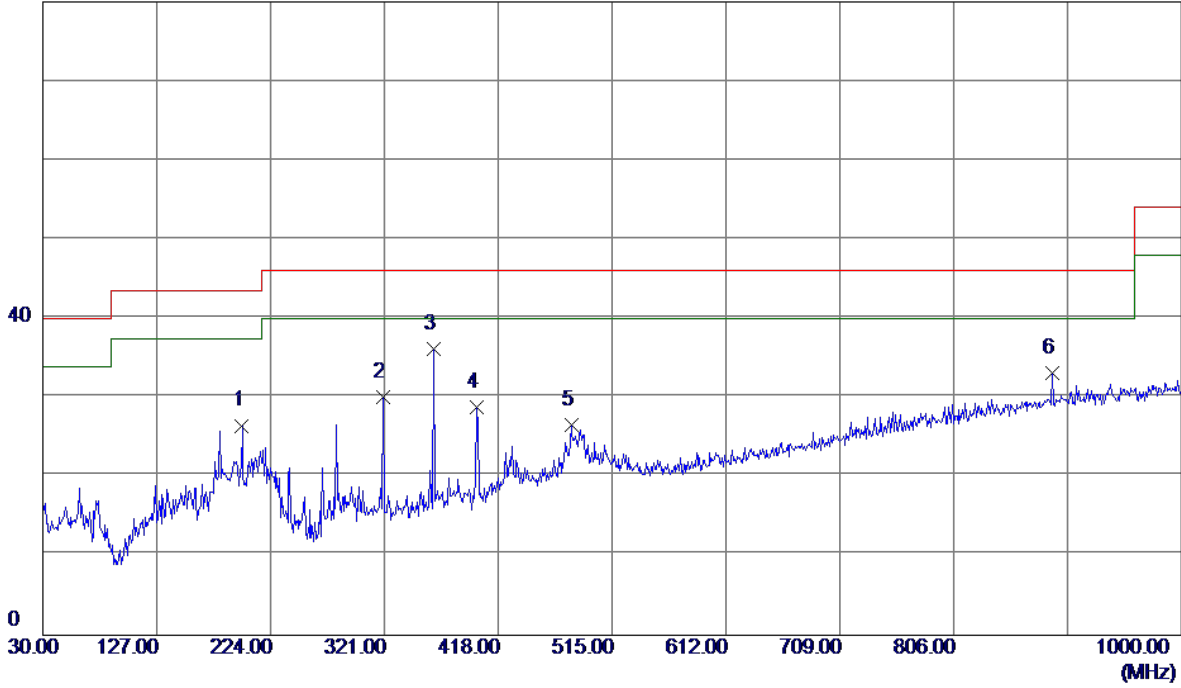

No.	Freq. MHz	Reading Level dBuV/m	Correct Factor dB	Measure ment dBuV/m	Limit dBuV/m	Margin dB	Detector	Comment
1	199.7500	40.21	-13.73	26.48	43.50	-17.02	Peak	
2	320.0300	42.51	-12.48	30.03	46.00	-15.97	Peak	
3 *	362.7100	47.91	-11.80	36.11	46.00	-9.89	Peak	
4	399.5700	40.19	-11.37	28.82	46.00	-17.18	Peak	
5	480.0800	35.73	-9.21	26.52	46.00	-19.48	Peak	
6	890.3900	32.24	0.83	33.07	46.00	-12.93	Peak	

Test Mode: TX B MODE CHANNEL 06

**Vertical**

80 dBuV/m

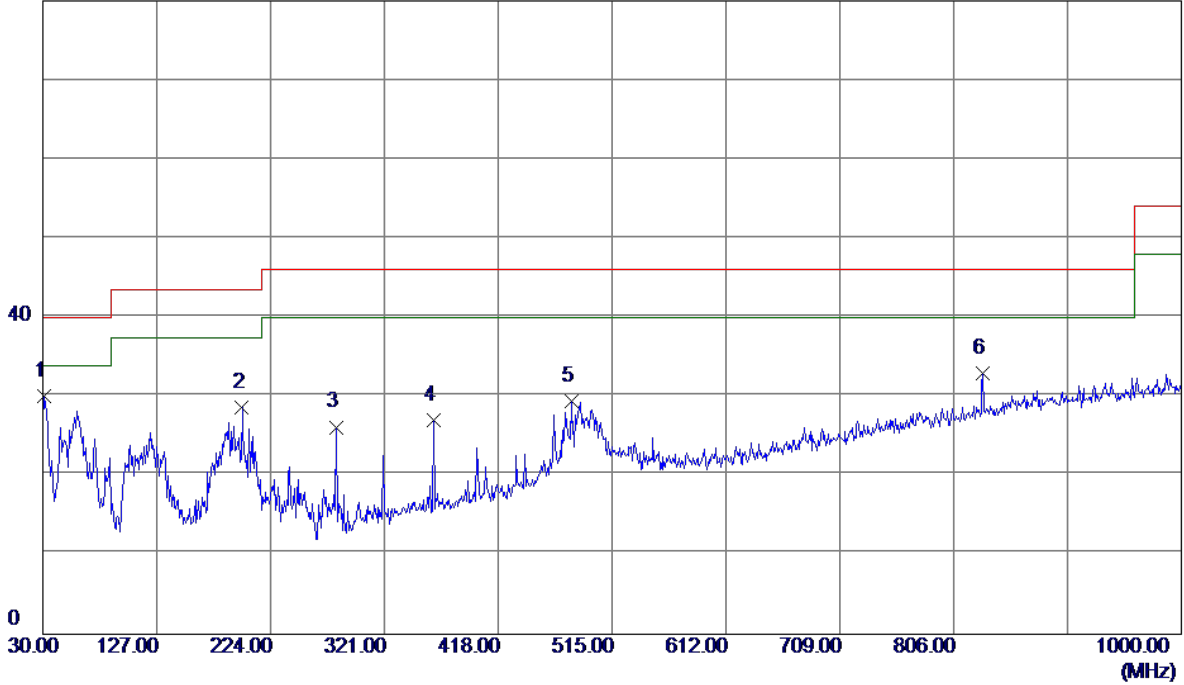

No.	Freq. MHz	Reading Level dBuV/m	Correct Factor dB	Measure ment dBuV/m	Limit dBuV/m	Margin dB	Detector	Comment
1 *	30.9700	45.17	-15.14	30.03	40.00	-9.97	Peak	
2	199.7500	42.41	-13.73	28.68	43.50	-14.82	Peak	
3	280.2600	40.92	-14.76	26.16	46.00	-19.84	Peak	
4	362.7100	38.77	-11.80	26.97	46.00	-19.03	Peak	
5	480.0800	38.58	-9.21	29.37	46.00	-16.63	Peak	
6	831.2199	33.47	-0.51	32.96	46.00	-13.04	Peak	

Test Mode: TX B MODE CHANNEL 06

**Horizontal**

80 dBuV/m

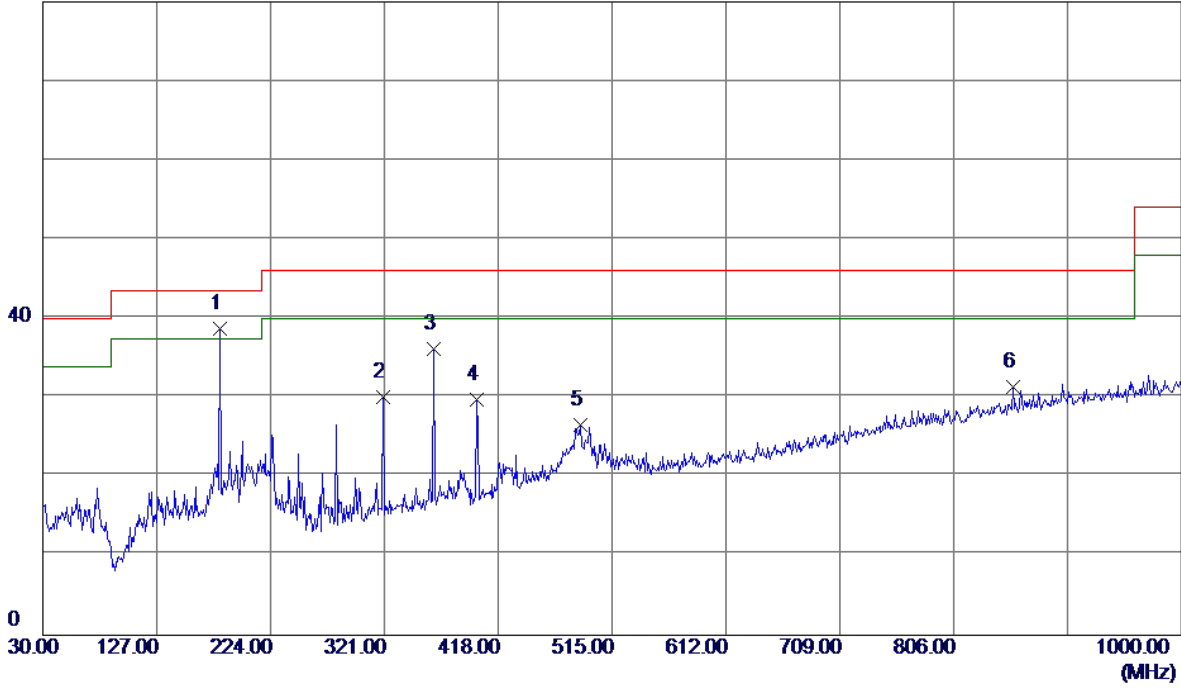

No.	Freq. MHz	Reading Level dBuV/m	Correct Factor dB	Measure ment dBuV/m	Limit dBuV/m	Margin dB	Detector	Comment
1 *	181.3200	50.80	-12.15	38.65	43.50	-4.85	Peak	
2	320.0300	42.61	-12.48	30.13	46.00	-15.87	Peak	
3	362.7100	48.02	-11.80	36.22	46.00	-9.78	Peak	
4	399.5700	41.10	-11.37	29.73	46.00	-16.27	Peak	
5	487.8400	35.60	-9.02	26.58	46.00	-19.42	Peak	
6	856.4400	31.25	0.13	31.38	46.00	-14.62	Peak	

Test Mode: TX B MODE CHANNEL 11

**Vertical**

80 dBuV/m

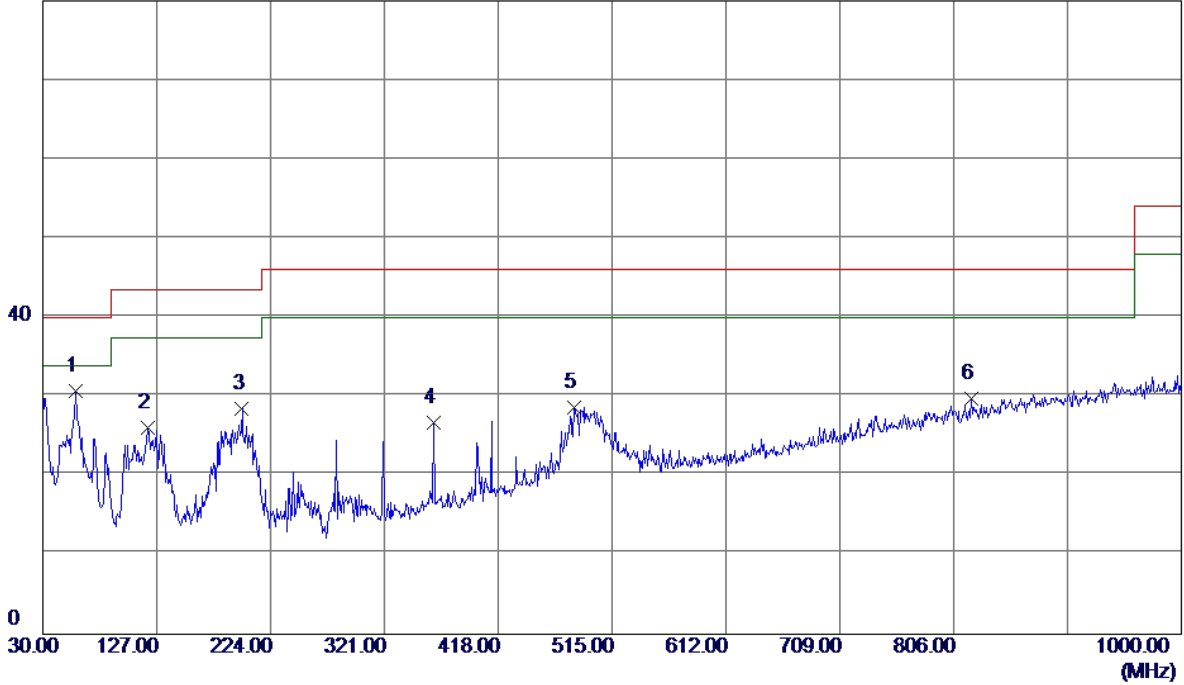

No.	Freq. MHz	Reading Level dBuV/m	Correct Factor dB	Measure ment dBuV/m	Limit dBuV/m	Margin dB	Detector	Comment
1 *	58.1300	44.88	-14.13	30.75	40.00	-9.25	Peak	
2	119.2400	41.57	-15.46	26.11	43.50	-17.39	Peak	
3	199.7500	42.23	-13.73	28.50	43.50	-15.00	Peak	
4	362.7100	38.52	-11.80	26.72	46.00	-19.28	Peak	
5	482.9900	37.84	-9.14	28.70	46.00	-17.30	Peak	
6	821.5200	30.53	-0.77	29.76	46.00	-16.24	Peak	

Test Mode: TX B MODE CHANNEL 11

**Horizontal**

80 dBuV/m

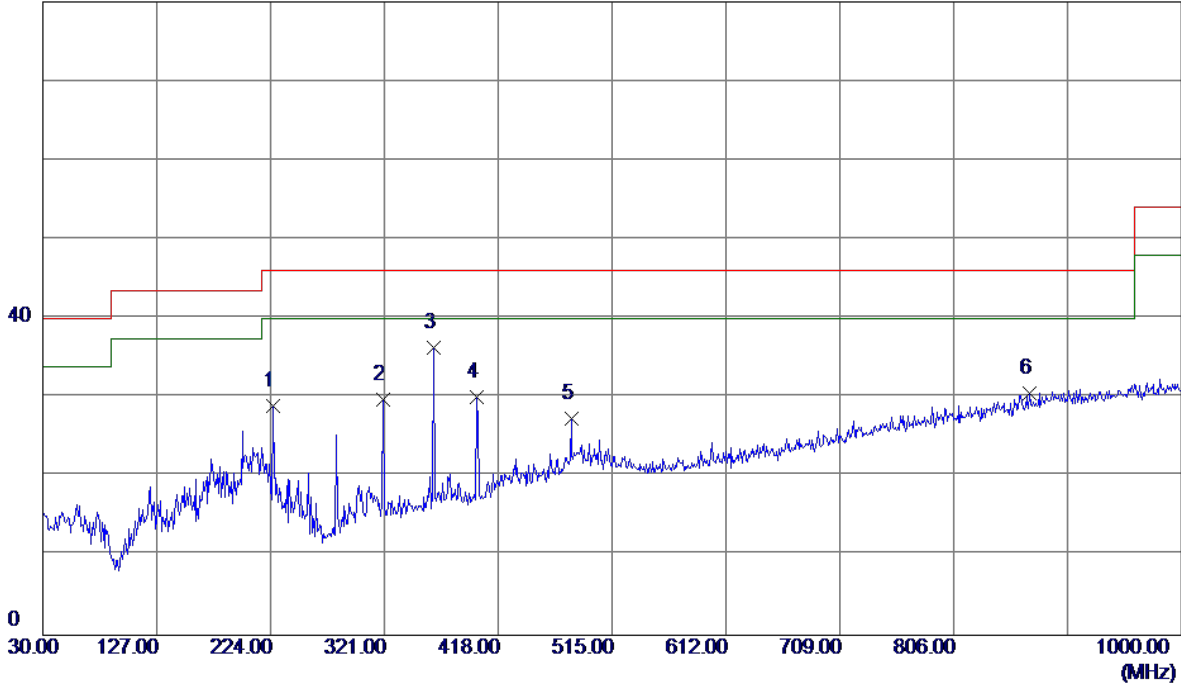

No.	Freq. MHz	Reading Level dBuV/m	Correct Factor dB	Measure ment dBuV/m	Limit dBuV/m	Margin dB	Detector	Comment
1	225.9400	43.05	-14.04	29.01	46.00	-16.99	Peak	
2	320.0300	42.24	-12.48	29.76	46.00	-16.24	Peak	
3 *	362.7100	48.13	-11.80	36.33	46.00	-9.67	Peak	
4	399.5700	41.42	-11.37	30.05	46.00	-15.95	Peak	
5	480.0800	36.57	-9.21	27.36	46.00	-18.64	Peak	
6	870.9900	30.18	0.43	30.61	46.00	-15.39	Peak	

## APPENDIX D - RADIATED EMISSION (ABOVE 1000MHZ)

Orthogonal Axis :	X
Test Mode :	TX B MODE 2412MHz

**Vertical**

120 dBuV/m

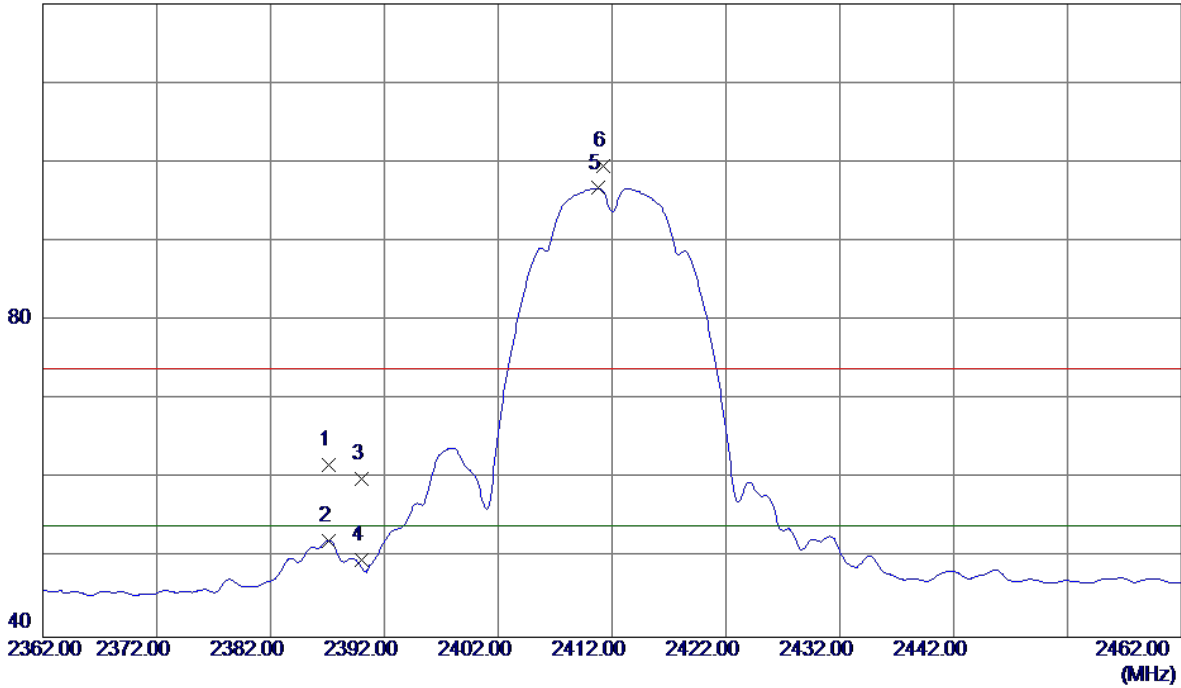

No.	Freq. MHz	Reading Level dBuV/m	Correct Factor dB	Measure ment dBuV/m	Limit dBuV/m	Margin dB	Detector	Comment
1	2387.1000	28.68	33.05	61.73	74.00	-12.27	Peak	
2	2387.1000	19.17	33.05	52.22	54.00	-1.78	AVG	
3	2390.0000	26.94	33.06	60.00	74.00	-14.00	Peak	
4	2390.0000	16.73	33.06	49.79	54.00	-4.21	AVG	
5 *	2410.8000	63.59	33.13	96.72	54.00	42.72	AVG	No Limit
6	2411.2000	66.31	33.14	99.45	74.00	25.45	Peak	No Limit

Orthogonal Axis :	X
Test Mode :	TX B MODE 2412MHz

**Vertical**

80 dBuV/m

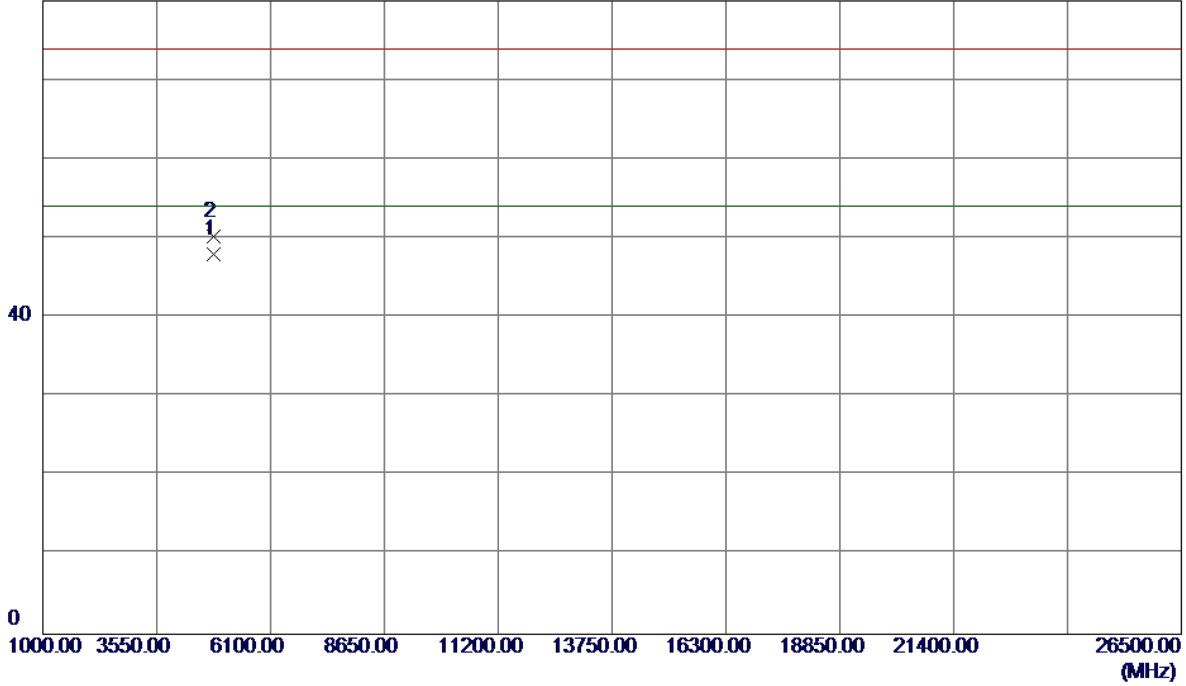

No.	Freq. MHz	Reading Level dBuV/m	Correct Factor dB	Measure ment dBuV/m	Limit dBuV/m	Margin dB	Detector	Comment
1 *	4823.9300	41.65	6.32	47.97	54.00	-6.03	AVG	
2	4824.1050	43.95	6.32	50.27	74.00	-23.73	Peak	



Orthogonal Axis :	X
Test Mode :	TX B MODE 2412MHz

**Horizontal**

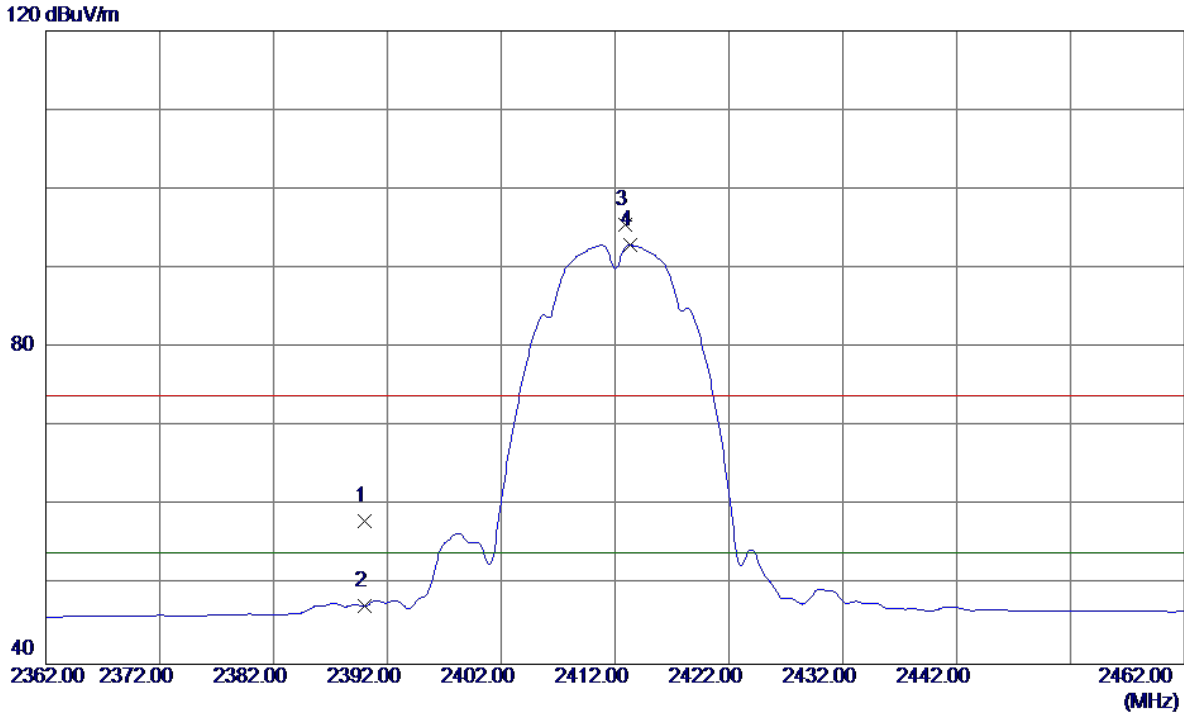

No.	Freq. MHz	Reading Level dBuV/m	Correct Factor dB	Measure ment dBuV/m	Limit dBuV/m	Margin dB	Detector	Comment
1	2390.0000	25.04	33.06	58.10	74.00	-15.90	Peak	
2	2390.0000	14.27	33.06	47.33	54.00	-6.67	AVG	
3	2412.9000	62.44	33.14	95.58	74.00	21.58	Peak	No Limit
4 *	2413.3000	59.81	33.14	92.95	54.00	38.95	AVG	No Limit

Orthogonal Axis :	X
Test Mode :	TX B MODE 2412MHz

**Horizontal**

80 dBuV/m

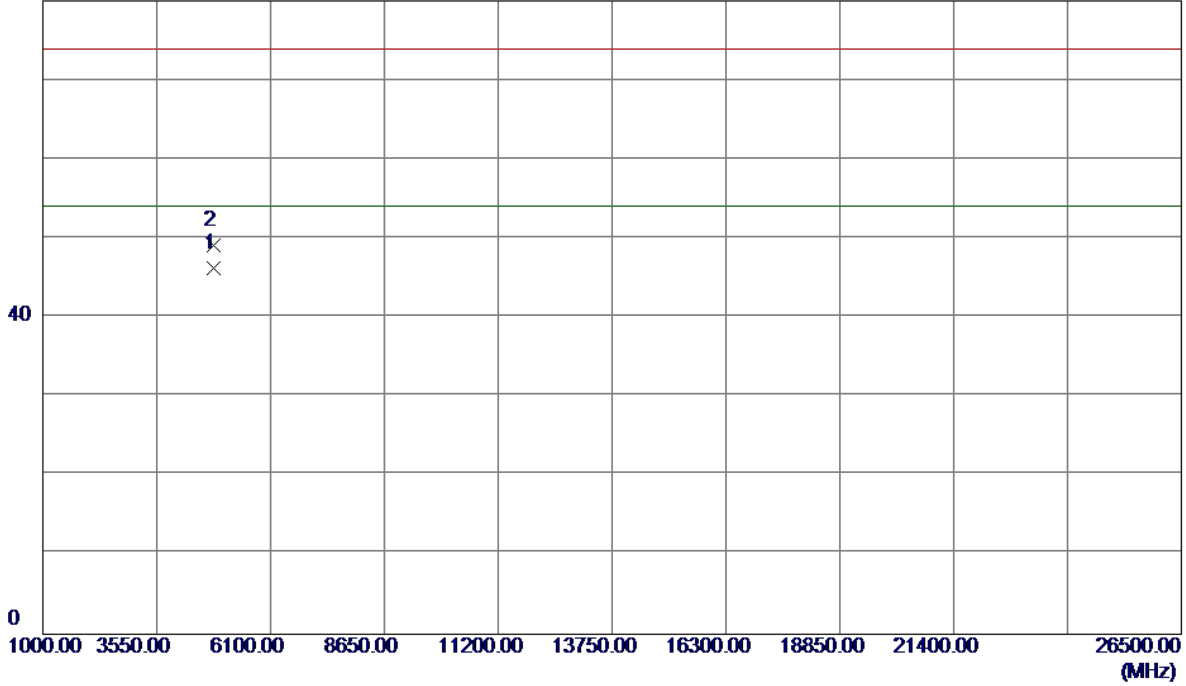

No.	Freq. MHz	Reading Level dBuV/m	Correct Factor dB	Measure ment dBuV/m	Limit dBuV/m	Margin dB	Detector	Comment
1 *	4823.9350	39.94	6.32	46.26	54.00	-7.74	AVG	
2	4823.9700	42.73	6.32	49.05	74.00	-24.95	Peak	

Orthogonal Axis :	X
Test Mode :	TX B MODE 2437MHz

**Vertical**

120 dBuV/m

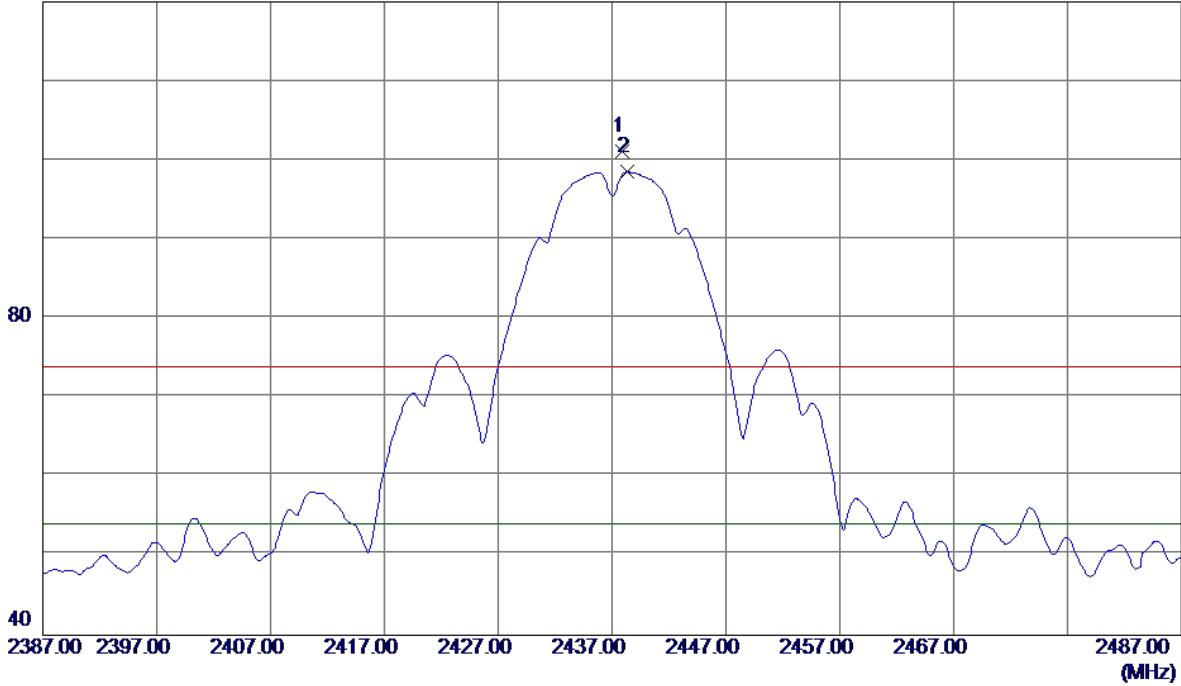

No.	Freq. MHz	Reading Level dBuV/m	Correct Factor dB	Measure ment dBuV/m	Limit dBuV/m	Margin dB	Detector	Comment
1	2437.9000	67.93	33.24	101.17	74.00	27.17	Peak	No Limit
2 *	2438.3000	65.28	33.24	98.52	54.00	44.52	AVG	No Limit

Orthogonal Axis :	X
Test Mode :	TX B MODE 2437MHz

**Vertical**

80 dBuV/m

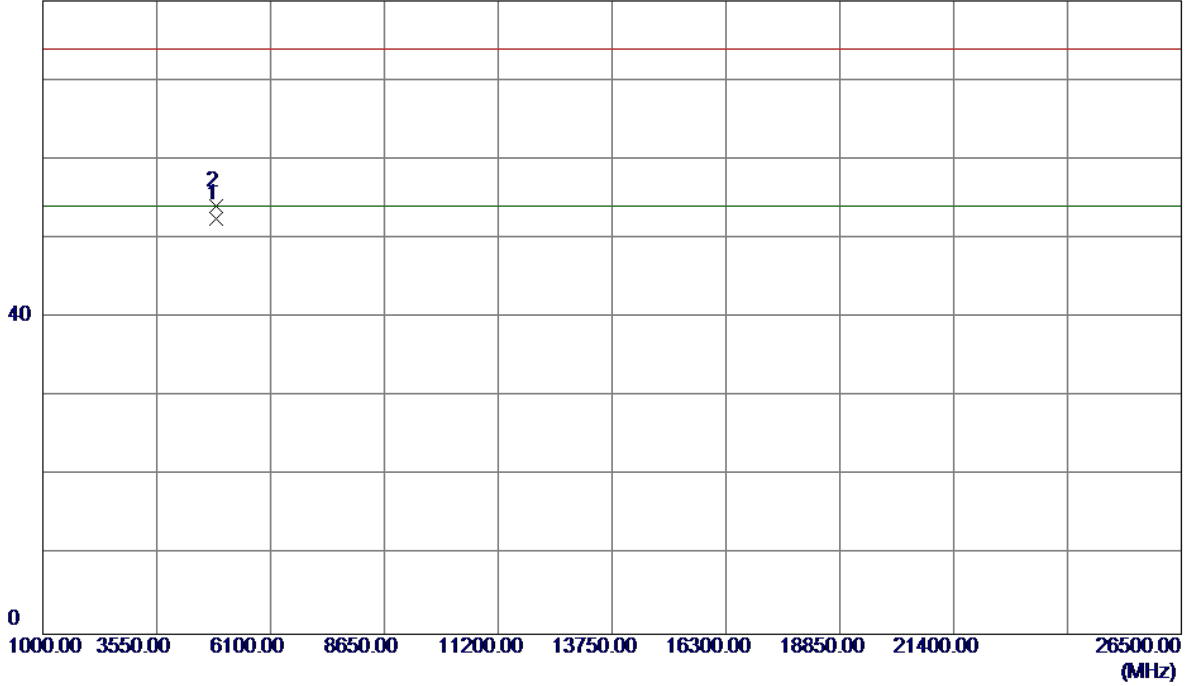

No.	Freq. MHz	Reading Level dBuV/m	Correct Factor dB	Measure ment dBuV/m	Limit dBuV/m	Margin dB	Detector	Comment
1 *	4873.9450	46.10	6.44	52.54	54.00	-1.46	AVG	
2	4874.0400	47.66	6.44	54.10	74.00	-19.90	Peak	

Orthogonal Axis :	X
Test Mode :	TX B MODE 2437MHz

### Horizontal

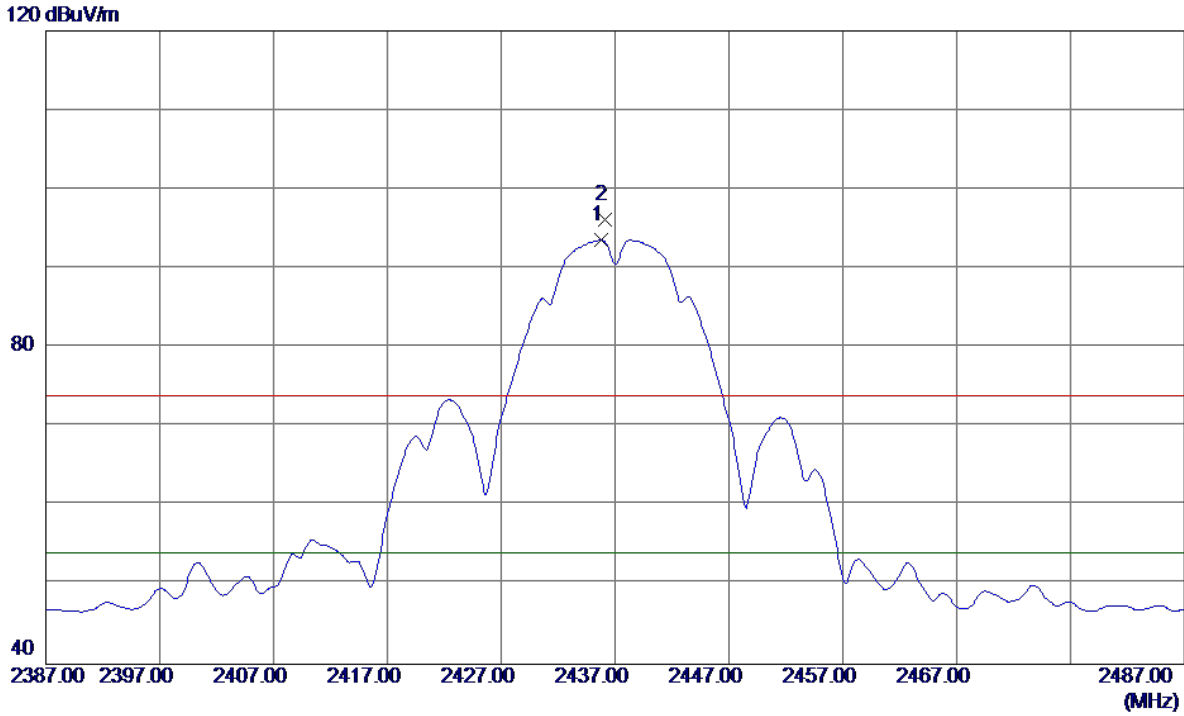

No.	Freq. MHz	Reading Level dBuV/m	Correct Factor dB	Measure ment dBuV/m	Limit dBuV/m	Margin dB	Detector	Comment
1 *	2435.8000	60.34	33.23	93.57	54.00	39.57	AVG	No Limit
2	2436.1000	62.98	33.23	96.21	74.00	22.21	Peak	No Limit

Orthogonal Axis :	X
Test Mode :	TX B MODE 2437MHz

### Horizontal

80 dBuV/m

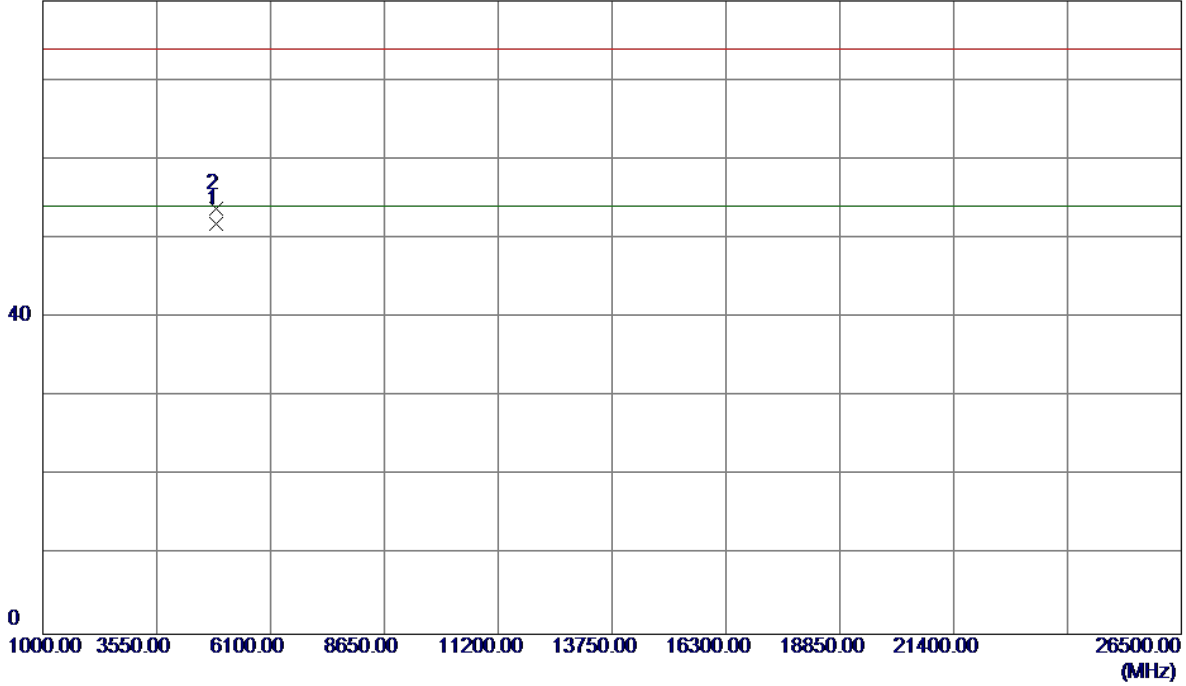

No.	Freq. MHz	Reading Level dBuV/m	Correct Factor dB	Measure ment dBuV/m	Limit dBuV/m	Margin dB	Detector	Comment
1 *	4873.9350	45.34	6.44	51.78	54.00	-2.22	AVG	
2	4873.9750	47.28	6.44	53.72	74.00	-20.28	Peak	

Orthogonal Axis :	X
Test Mode :	TX B MODE 2462MHz

**Vertical**

120 dBuV/m

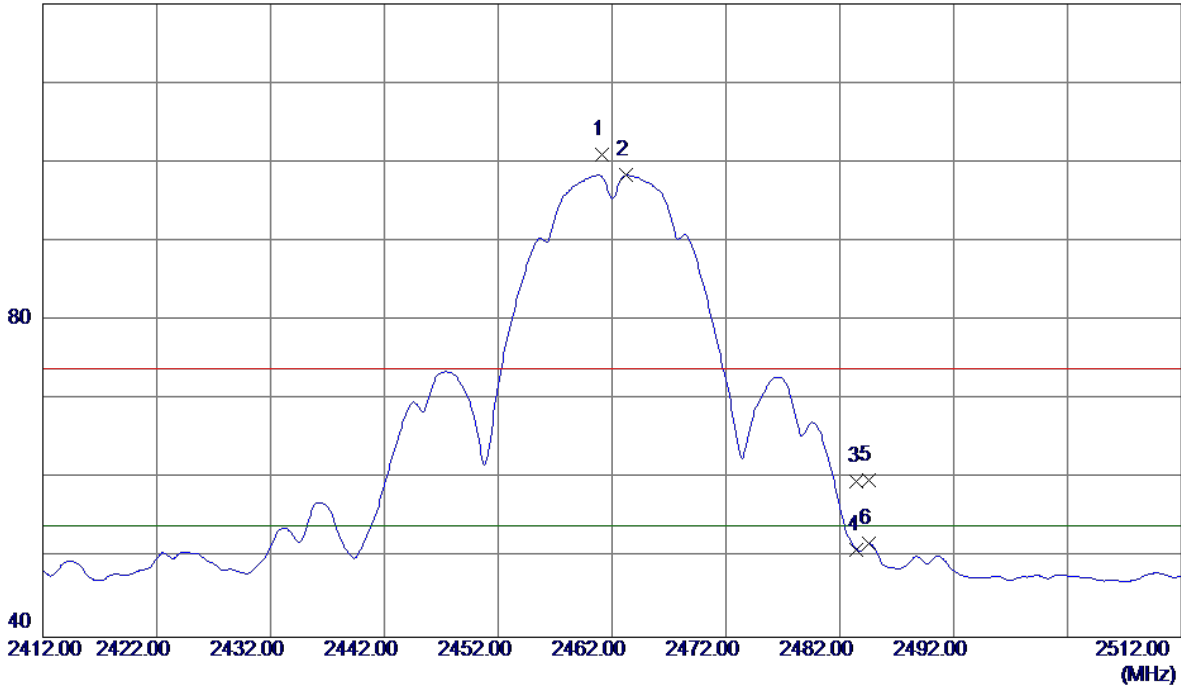

No.	Freq. MHz	Reading Level dBuV/m	Correct Factor dB	Measure ment dBuV/m	Limit dBuV/m	Margin dB	Detector	Comment
1	2461.1000	67.69	33.32	101.01	74.00	27.01	Peak	No Limit
2 *	2463.2000	65.02	33.33	98.35	54.00	44.35	AVG	No Limit
3	2483.5000	26.20	33.41	59.61	74.00	-14.39	Peak	
4	2483.5000	17.65	33.41	51.06	54.00	-2.94	AVG	
5	2484.6000	26.39	33.41	59.80	74.00	-14.20	Peak	
6	2484.6000	18.36	33.41	51.77	54.00	-2.23	AVG	

Orthogonal Axis :	X
Test Mode :	TX B MODE 2462MHz

**Vertical**

80 dBuV/m

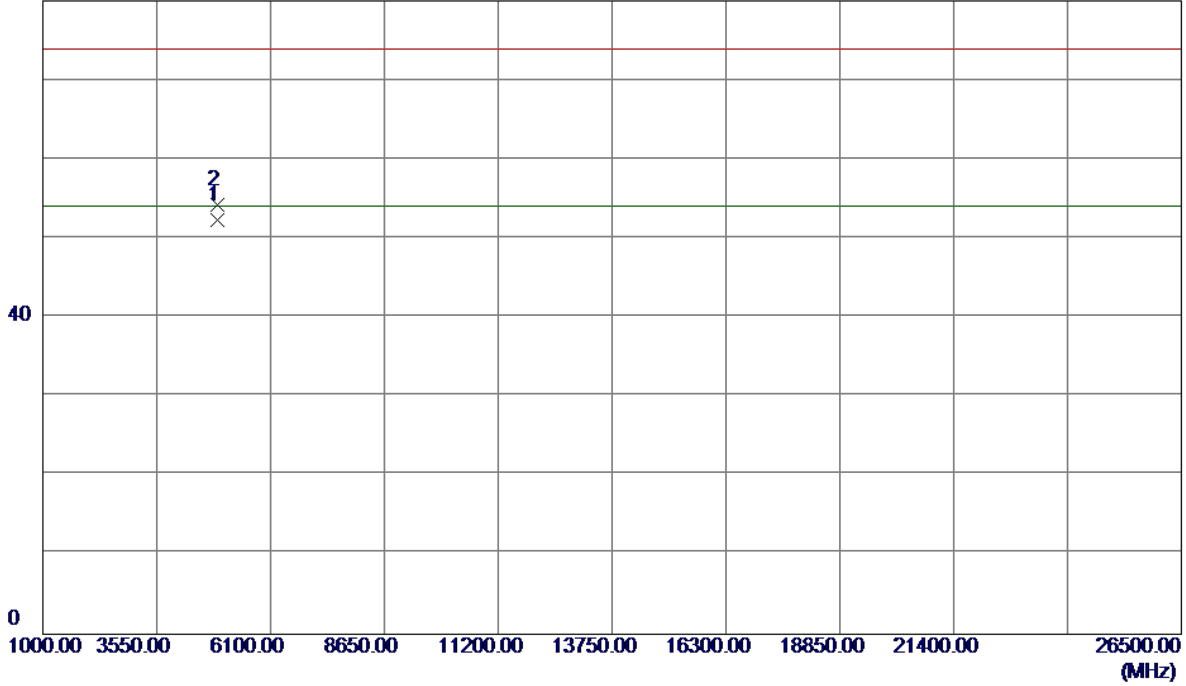

No.	Freq. MHz	Reading Level dBuV/m	Correct Factor dB	Measure ment dBuV/m	Limit dBuV/m	Margin dB	Detector	Comment
1 *	4923.9400	45.81	6.57	52.38	54.00	-1.62	AVG	
2	4923.9500	47.74	6.57	54.31	74.00	-19.69	Peak	



Orthogonal Axis :	X
Test Mode :	TX B MODE 2462MHz

**Horizontal**

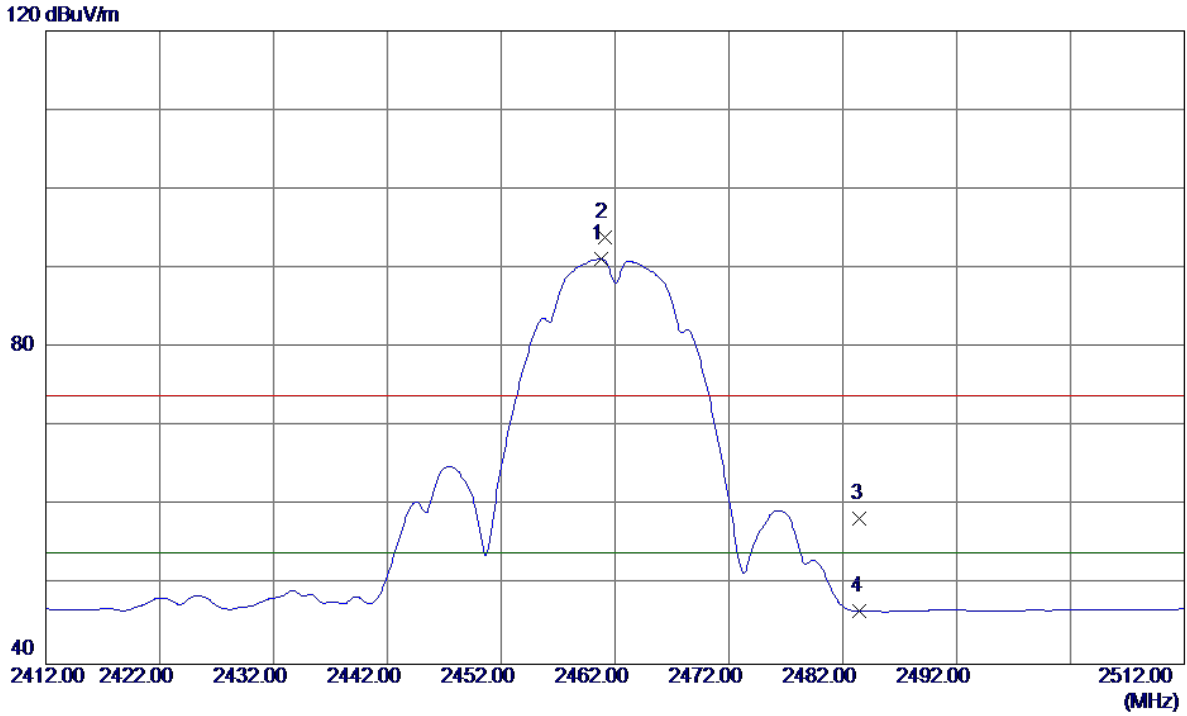

No.	Freq. MHz	Reading Level dBuV/m	Correct Factor dB	Measure ment dBuV/m	Limit dBuV/m	Margin dB	Detector	Comment
1 *	2460.8000	57.88	33.32	91.20	54.00	37.20	AVG	No Limit
2	2461.1000	60.57	33.32	93.89	74.00	19.89	Peak	No Limit
3	2483.5000	25.01	33.41	58.42	74.00	-15.58	Peak	
4	2483.5000	13.25	33.41	46.66	54.00	-7.34	AVG	

Orthogonal Axis :	X
Test Mode :	TX B MODE 2462MHz

**Horizontal**

80 dBuV/m

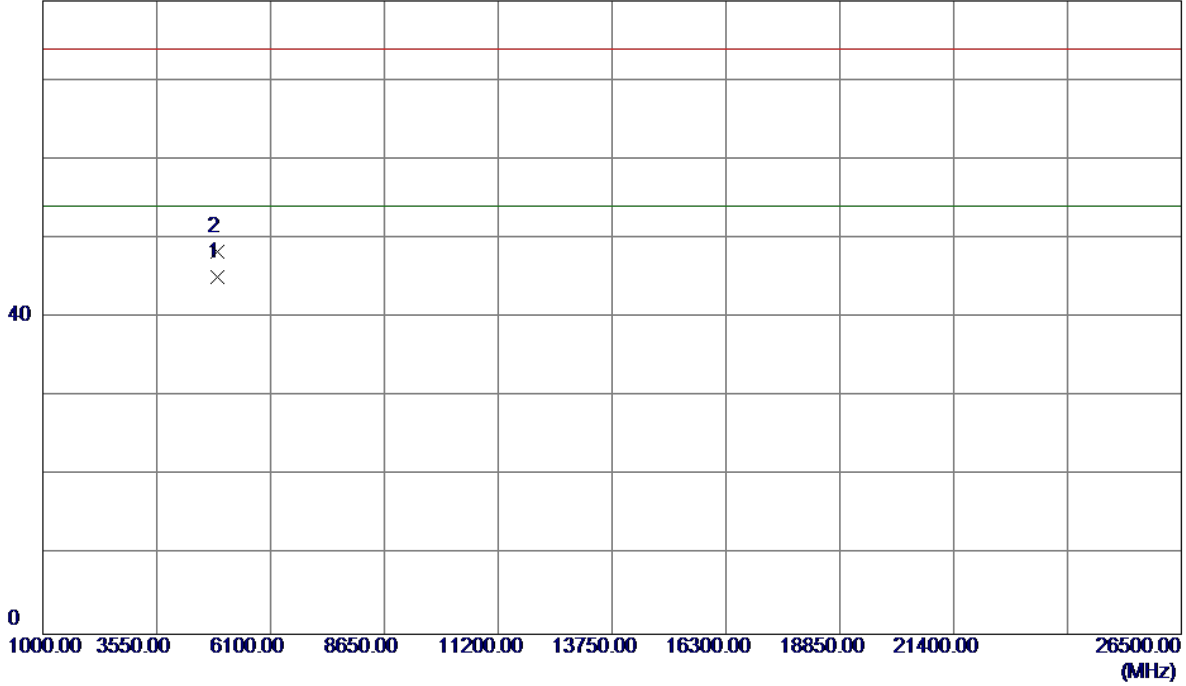

No.	Freq. MHz	Reading Level dBuV/m	Correct Factor dB	Measure ment dBuV/m	Limit dBuV/m	Margin dB	Detector	Comment
1 *	4923.9700	38.51	6.57	45.08	54.00	-8.92	AVG	
2	4923.9900	41.68	6.57	48.25	74.00	-25.75	Peak	

Orthogonal Axis :	X
Test Mode :	TX G MODE 2412MHz

**Vertical**

120 dBuV/m

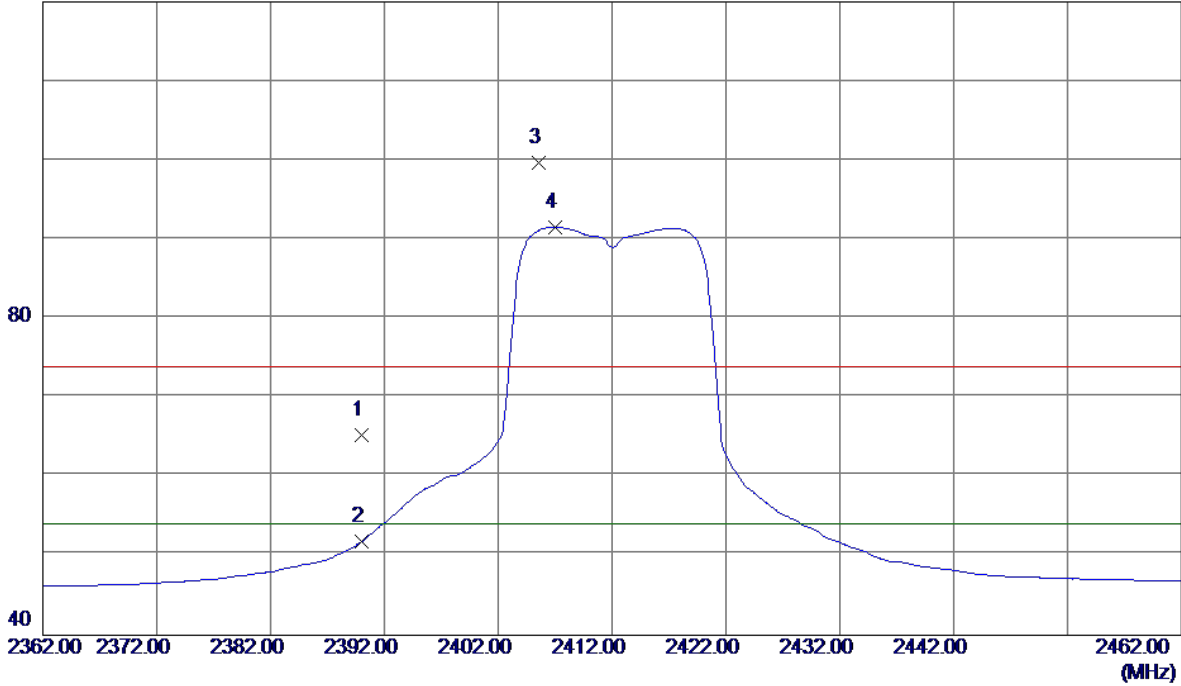

No.	Freq. MHz	Reading Level dBuV/m	Correct Factor dB	Measure ment dBuV/m	Limit dBuV/m	Margin dB	Detector	Comment
1	2390.0000	32.26	33.06	65.32	74.00	-8.68	Peak	
2	2390.0000	18.77	33.06	51.83	54.00	-2.17	AVG	
3	2405.6000	66.56	33.11	99.67	74.00	25.67	Peak	No Limit
4 *	2407.0000	58.46	33.12	91.58	54.00	37.58	AVG	No Limit

Orthogonal Axis :	X
Test Mode :	TX G MODE 2412MHz

**Vertical**

80 dBuV/m

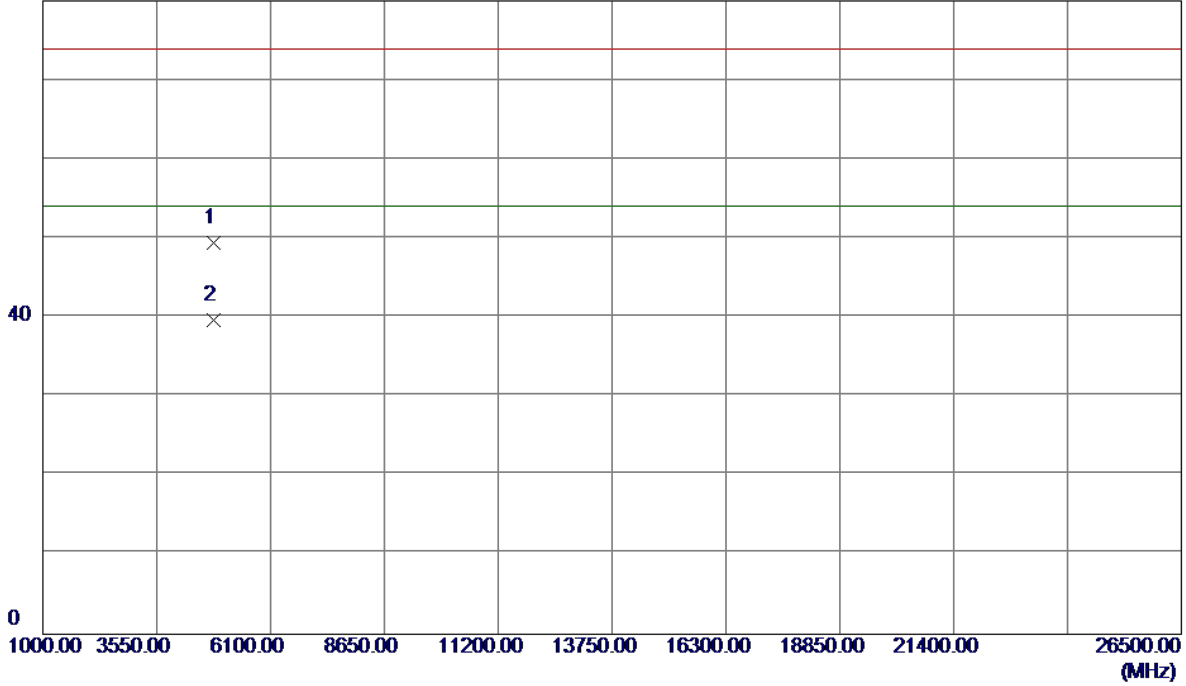

No.	Freq. MHz	Reading Level dBuV/m	Correct Factor dB	Measure ment dBuV/m	Limit dBuV/m	Margin dB	Detector	Comment
1	4825.6500	43.09	6.32	49.41	74.00	-24.59	Peak	
2 *	4825.7500	33.29	6.32	39.61	54.00	-14.39	AVG	

Orthogonal Axis :	X
Test Mode :	TX G MODE 2412MHz

### Horizontal

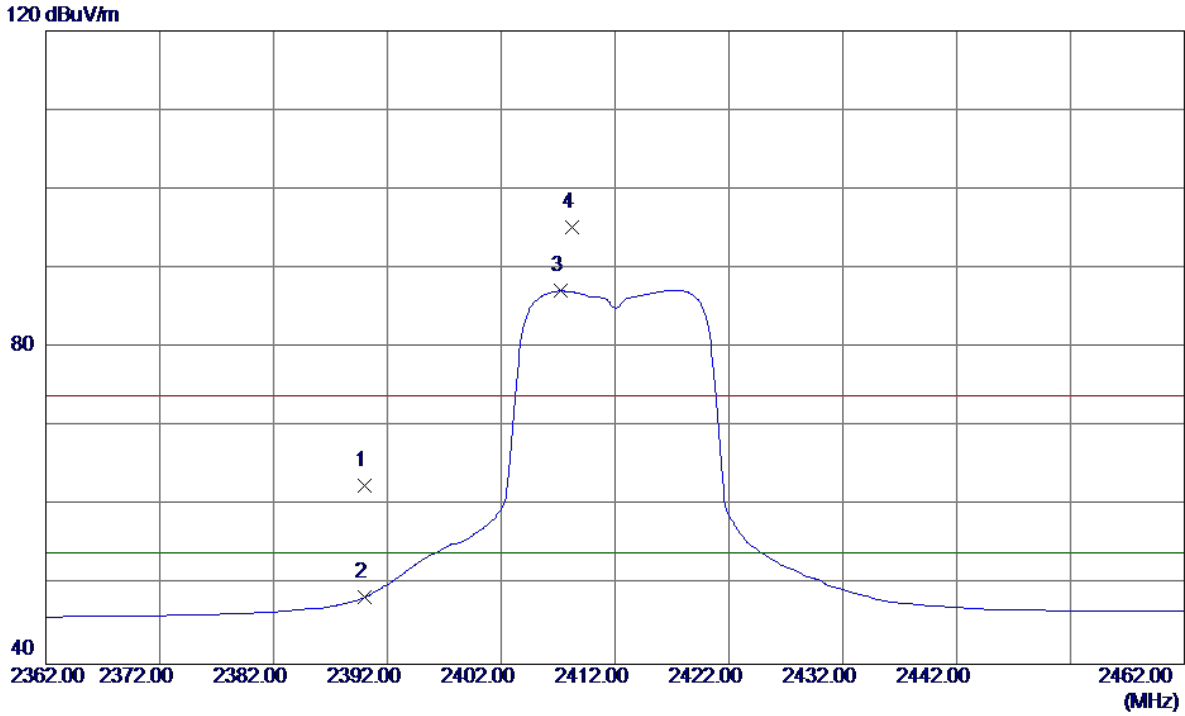

No.	Freq. MHz	Reading Level dBuV/m	Correct Factor dB	Measure ment dBuV/m	Limit dBuV/m	Margin dB	Detector	Comment
1	2390.0000	29.55	33.06	62.61	74.00	-11.39	Peak	
2	2390.0000	15.39	33.06	48.45	54.00	-5.55	AVG	
3 *	2407.2000	54.01	33.12	87.13	54.00	33.13	AVG	No Limit
4	2408.2000	62.01	33.12	95.13	74.00	21.13	Peak	No Limit

Orthogonal Axis :	X
Test Mode :	TX G MODE 2412MHz

**Horizontal**

80 dBuV/m

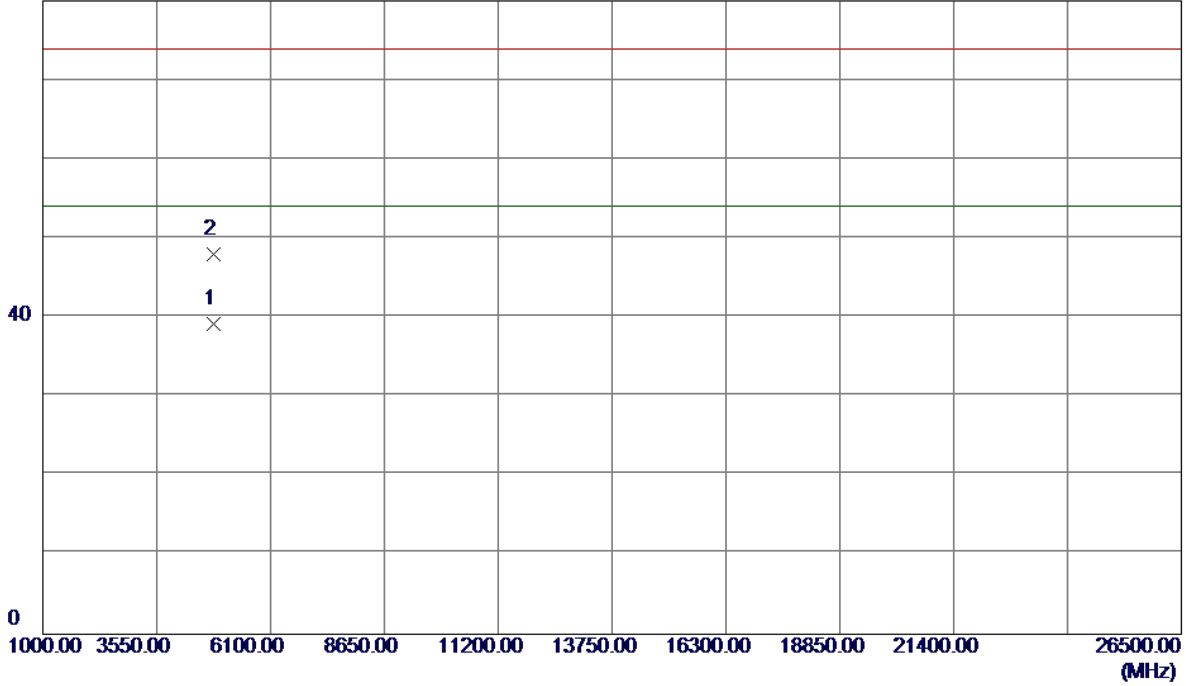

No.	Freq. MHz	Reading Level dBuV/m	Correct Factor dB	Measure ment dBuV/m	Limit dBuV/m	Margin dB	Detector	Comment
1 *	4823.9850	32.86	6.32	39.18	54.00	-14.82	AVG	
2	4823.9900	41.61	6.32	47.93	74.00	-26.07	Peak	

Orthogonal Axis :	X
Test Mode :	TX G MODE 2437MHz

**Vertical**

120 dBuV/m

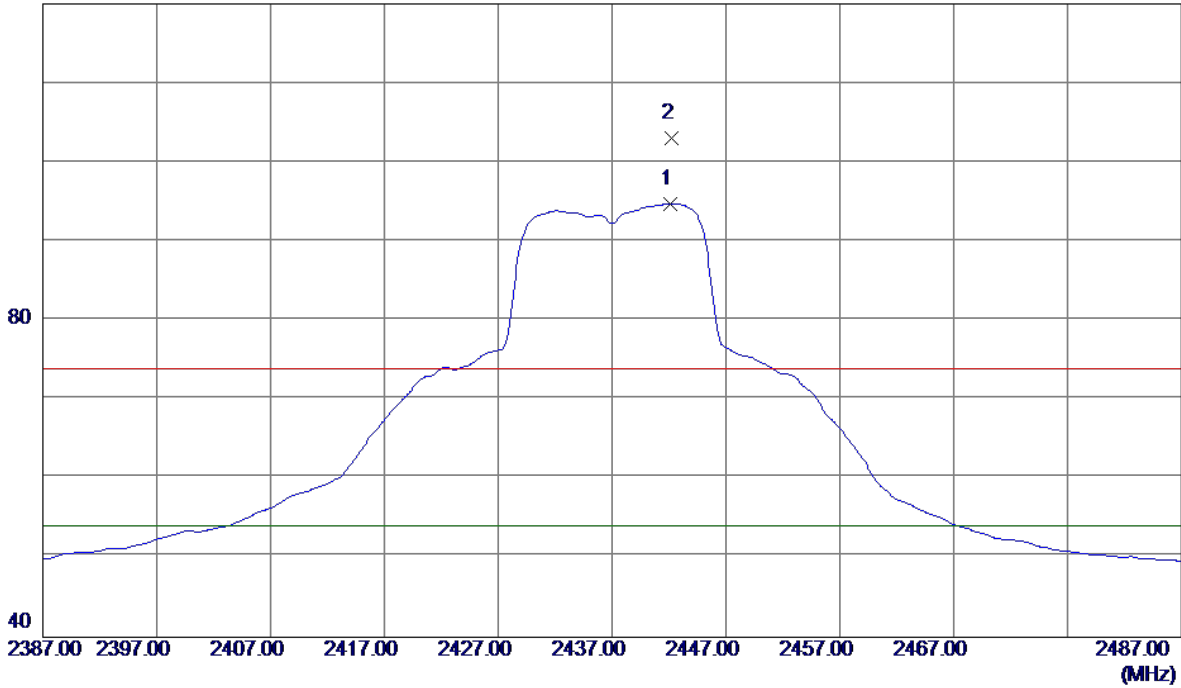

No.	Freq. MHz	Reading Level dBuV/m	Correct Factor dB	Measure ment dBuV/m	Limit dBuV/m	Margin dB	Detector	Comment
1 *	2442.1000	61.54	33.25	94.79	54.00	40.79	AVG	No Limit
2	2442.2000	69.74	33.25	102.99	74.00	28.99	Peak	No Limit

Orthogonal Axis :	X
Test Mode :	TX G MODE 2437MHz

**Vertical**

80 dBuV/m

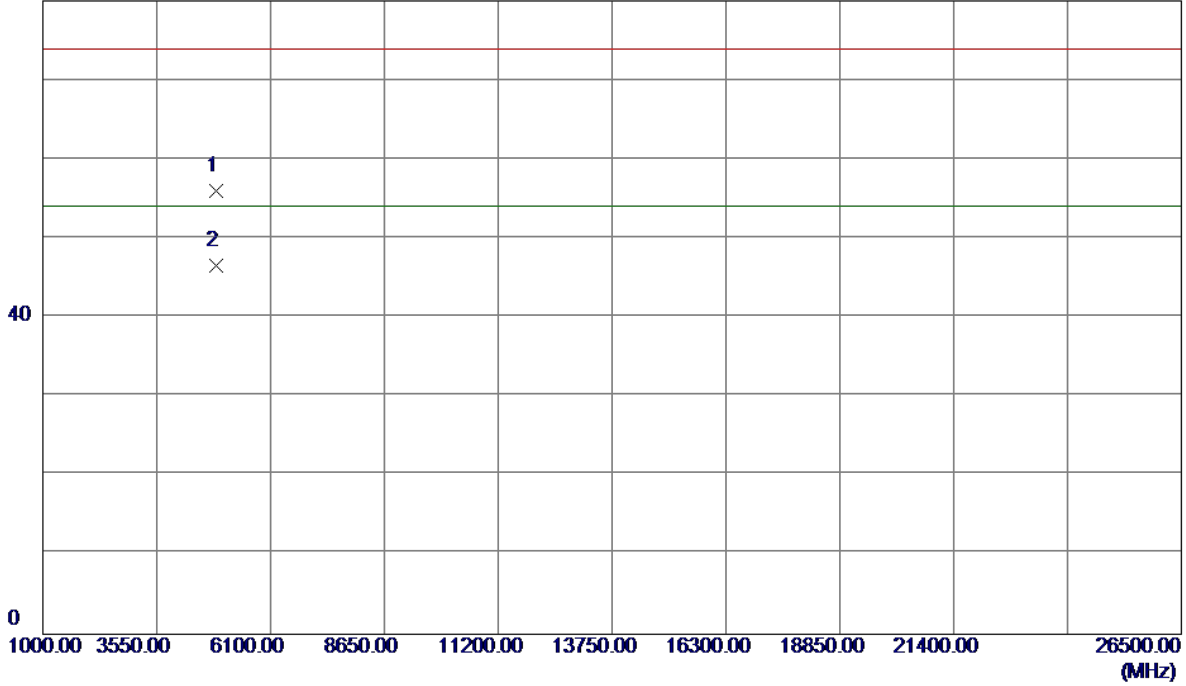

No.	Freq. MHz	Reading Level dBuV/m	Correct Factor dB	Measure ment dBuV/m	Limit dBuV/m	Margin dB	Detector	Comment
1	4871.4500	49.63	6.44	56.07	74.00	-17.93	Peak	
2 *	4873.9500	40.14	6.44	46.58	54.00	-7.42	AVG	



Orthogonal Axis :	X
Test Mode :	TX G MODE 2437MHz

### Horizontal

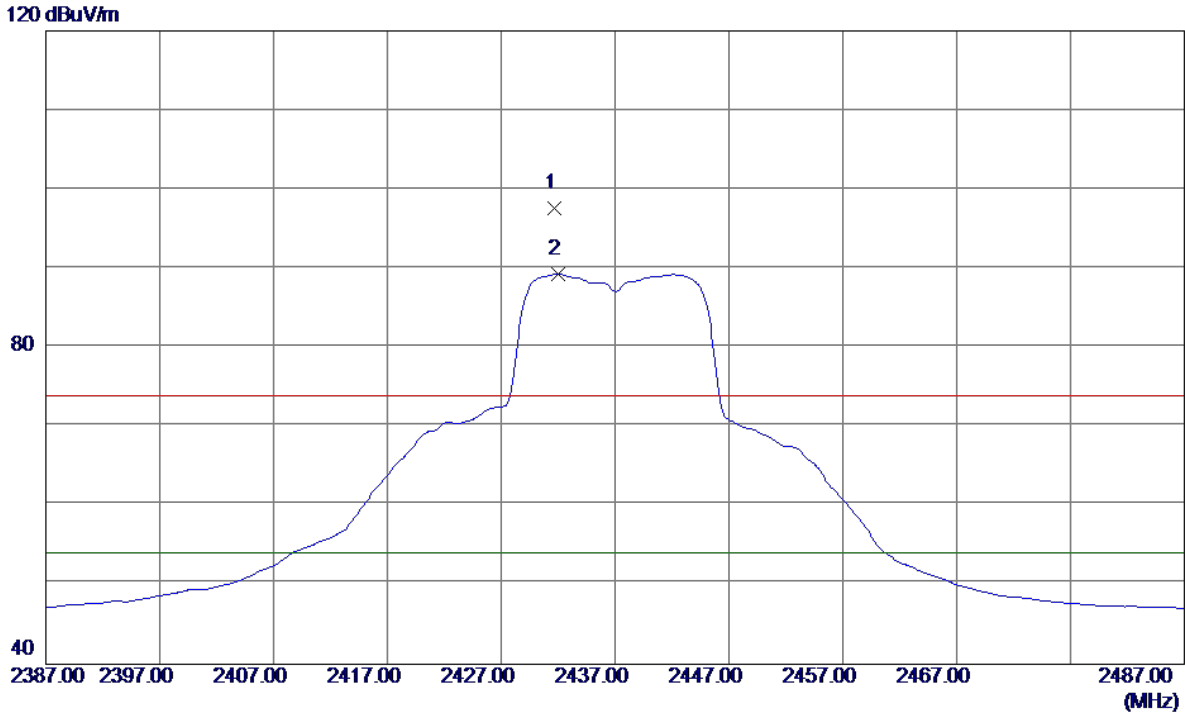

No.	Freq. MHz	Reading Level dBuV/m	Correct Factor dB	Measure ment dBuV/m	Limit dBuV/m	Margin dB	Detector	Comment
1	2431.7000	64.35	33.21	97.56	74.00	23.56	Peak	No Limit
2 *	2432.0000	56.05	33.21	89.26	54.00	35.26	AVG	No Limit

Orthogonal Axis :	X
Test Mode :	TX G MODE 2437MHz

**Horizontal**

80 dBuV/m

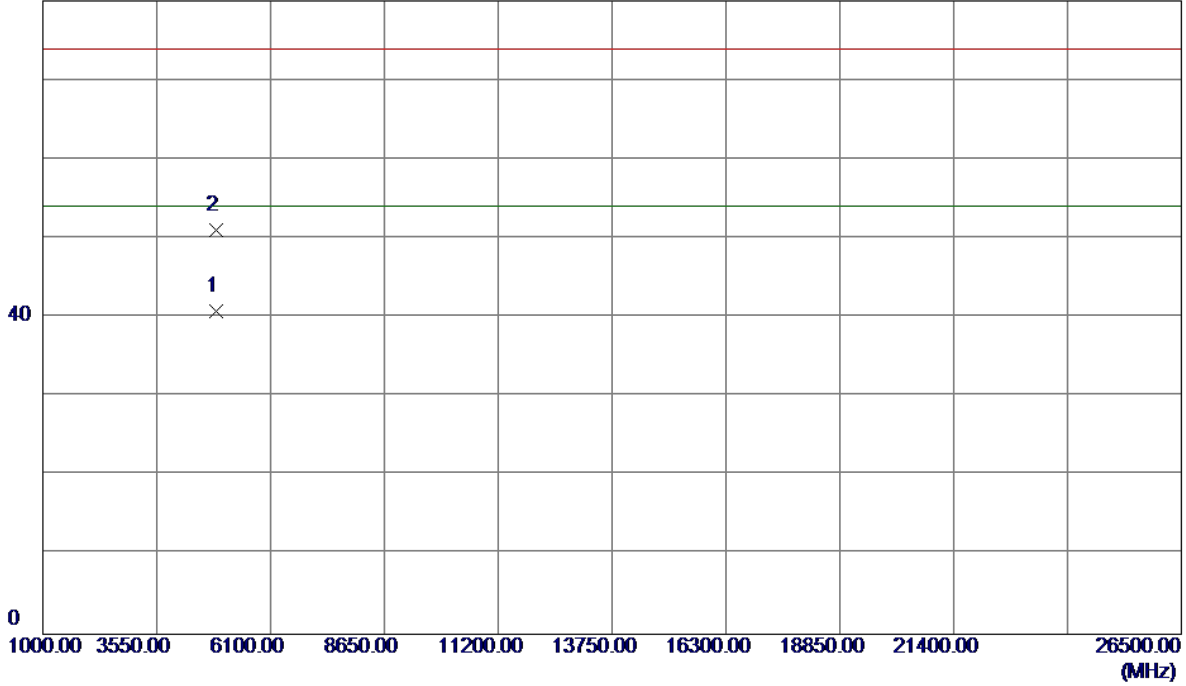

No.	Freq. MHz	Reading Level dBuV/m	Correct Factor dB	Measure ment dBuV/m	Limit dBuV/m	Margin dB	Detector	Comment
1 *	4874.0000	34.43	6.44	40.87	54.00	-13.13	AVG	
2	4875.5500	44.67	6.45	51.12	74.00	-22.88	Peak	

Orthogonal Axis :	X
Test Mode :	TX G MODE 2462MHz

**Vertical**

120 dBuV/m

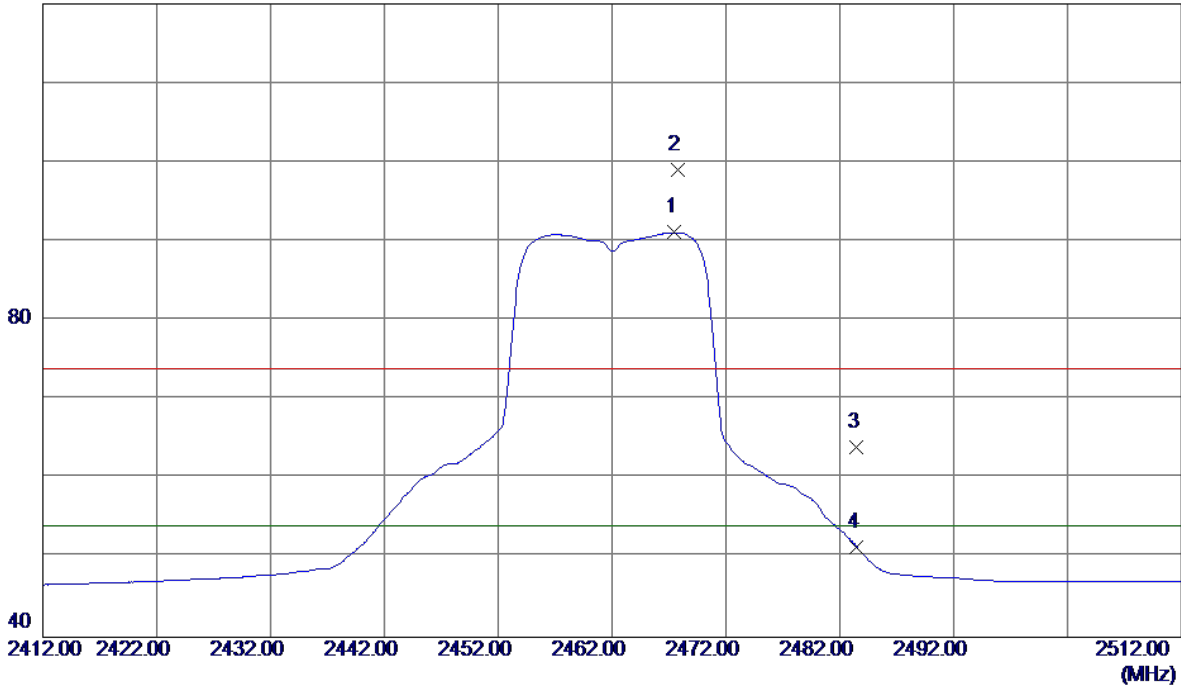

No.	Freq. MHz	Reading Level dBuV/m	Correct Factor dB	Measure ment dBuV/m	Limit dBuV/m	Margin dB	Detector	Comment
1 *	2467.5000	57.77	33.35	91.12	54.00	37.12	AVG	No Limit
2	2467.8000	65.72	33.35	99.07	74.00	25.07	Peak	No Limit
3	2483.5000	30.59	33.41	64.00	74.00	-10.00	Peak	
4	2483.5000	18.02	33.41	51.43	54.00	-2.57	AVG	

Orthogonal Axis :	X
Test Mode :	TX G MODE 2462MHz

**Vertical**

80 dBuV/m

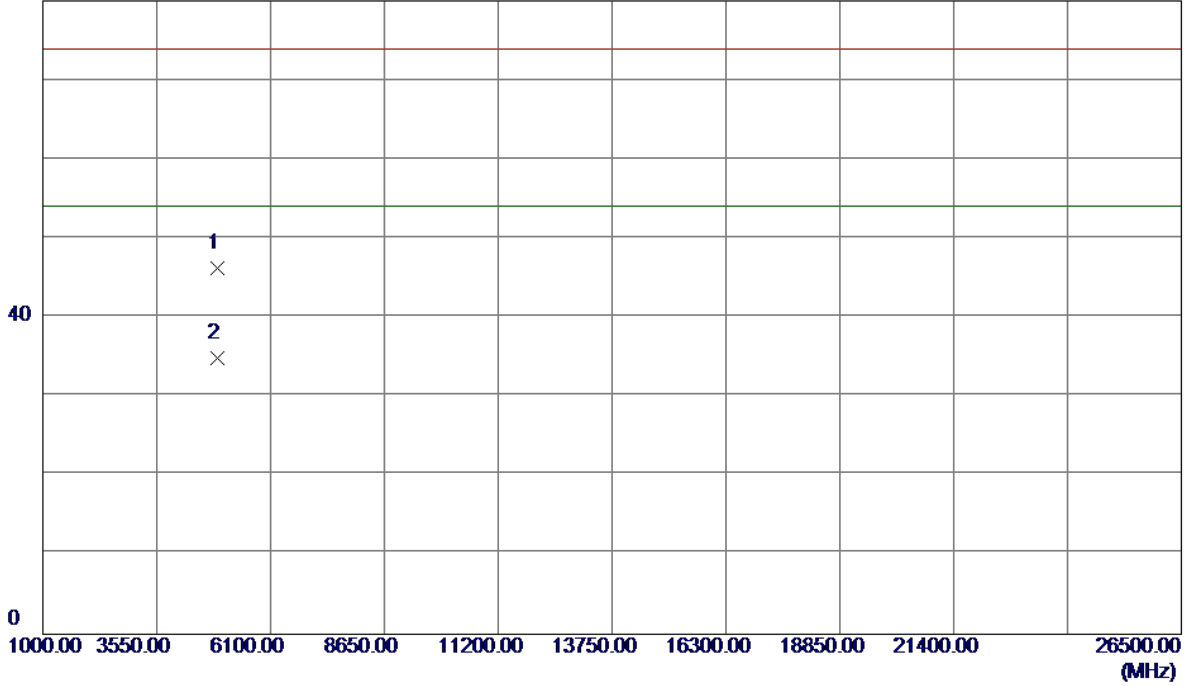

No.	Freq. MHz	Reading Level dBuV/m	Correct Factor dB	Measure ment dBuV/m	Limit dBuV/m	Margin dB	Detector	Comment
1	4919.3500	39.63	6.56	46.19	74.00	-27.81	Peak	
2 *	4924.0500	28.33	6.57	34.90	54.00	-19.10	AVG	

Orthogonal Axis :	X
Test Mode :	TX G MODE 2462MHz

**Horizontal**

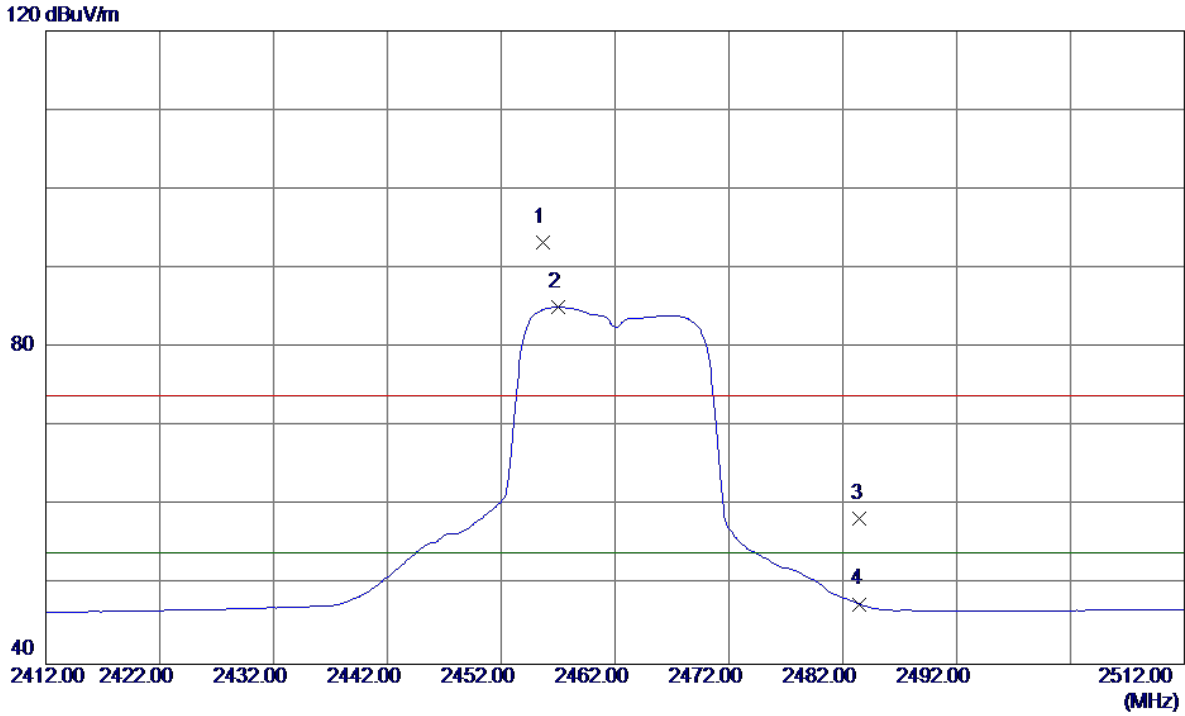

No.	Freq. MHz	Reading Level dBuV/m	Correct Factor dB	Measure ment dBuV/m	Limit dBuV/m	Margin dB	Detector	Comment
1	2455.7000	59.96	33.30	93.26	74.00	19.26	Peak	No Limit
2 *	2457.0000	51.82	33.31	85.13	54.00	31.13	AVG	No Limit
3	2483.5000	25.05	33.41	58.46	74.00	-15.54	Peak	
4	2483.5000	14.19	33.41	47.60	54.00	-6.40	AVG	

Orthogonal Axis :	X
Test Mode :	TX G MODE 2462MHz

**Horizontal**

80 dBuV/m

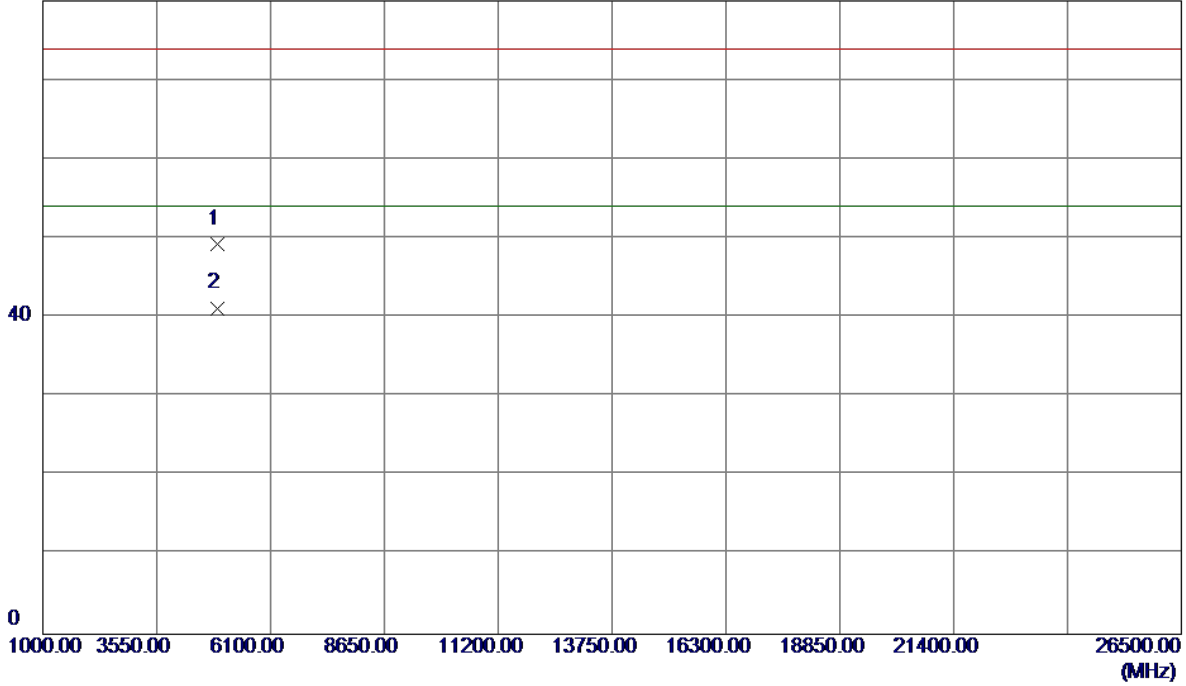

No.	Freq. MHz	Reading Level dBuV/m	Correct Factor dB	Measure ment dBuV/m	Limit dBuV/m	Margin dB	Detector	Comment
1	4923.1500	42.74	6.57	49.31	74.00	-24.69	Peak	
2 *	4924.0200	34.63	6.57	41.20	54.00	-12.80	AVG	

Orthogonal Axis :	X
Test Mode :	TX N-20M MODE 2412MHz

**Vertical**

120 dBuV/m

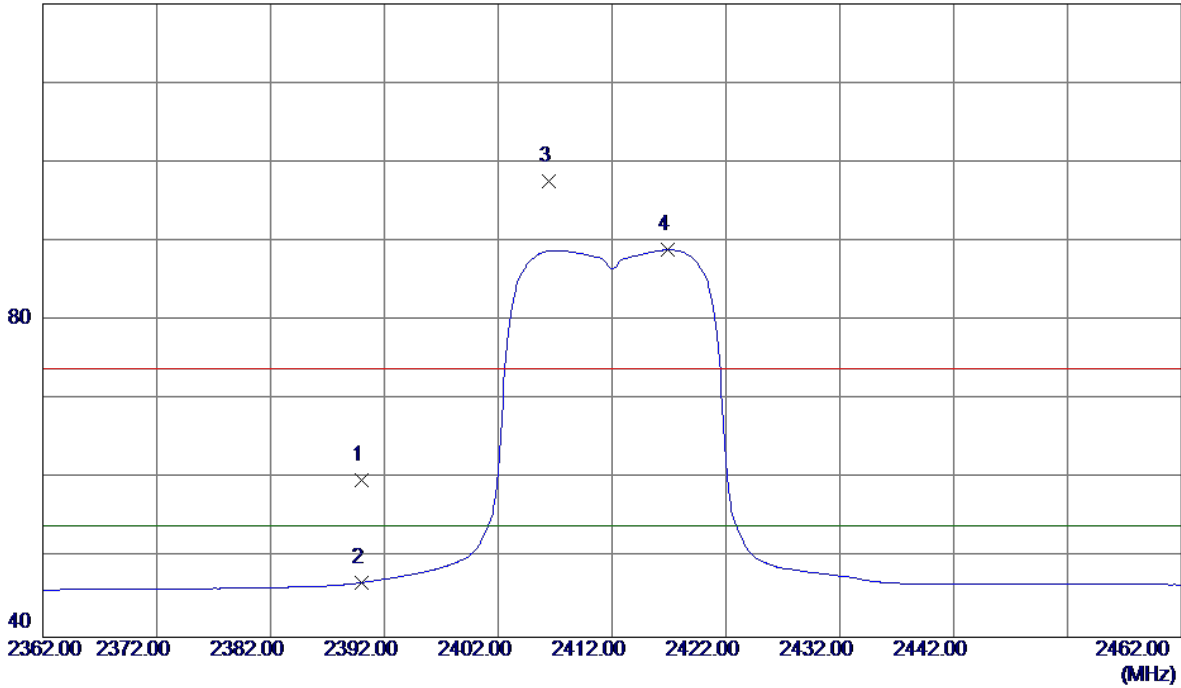

No.	Freq. MHz	Reading Level dBuV/m	Correct Factor dB	Measure ment dBuV/m	Limit dBuV/m	Margin dB	Detector	Comment
1	2390.0000	26.84	33.06	59.90	74.00	-14.10	Peak	
2	2390.0000	13.85	33.06	46.91	54.00	-7.09	AVG	
3	2406.4000	64.54	33.12	97.66	74.00	23.66	Peak	No Limit
4 *	2416.9000	55.76	33.16	88.92	54.00	34.92	AVG	No Limit

Orthogonal Axis :	X
Test Mode :	TX N-20M MODE 2412MHz

**Vertical**

80 dBuV/m

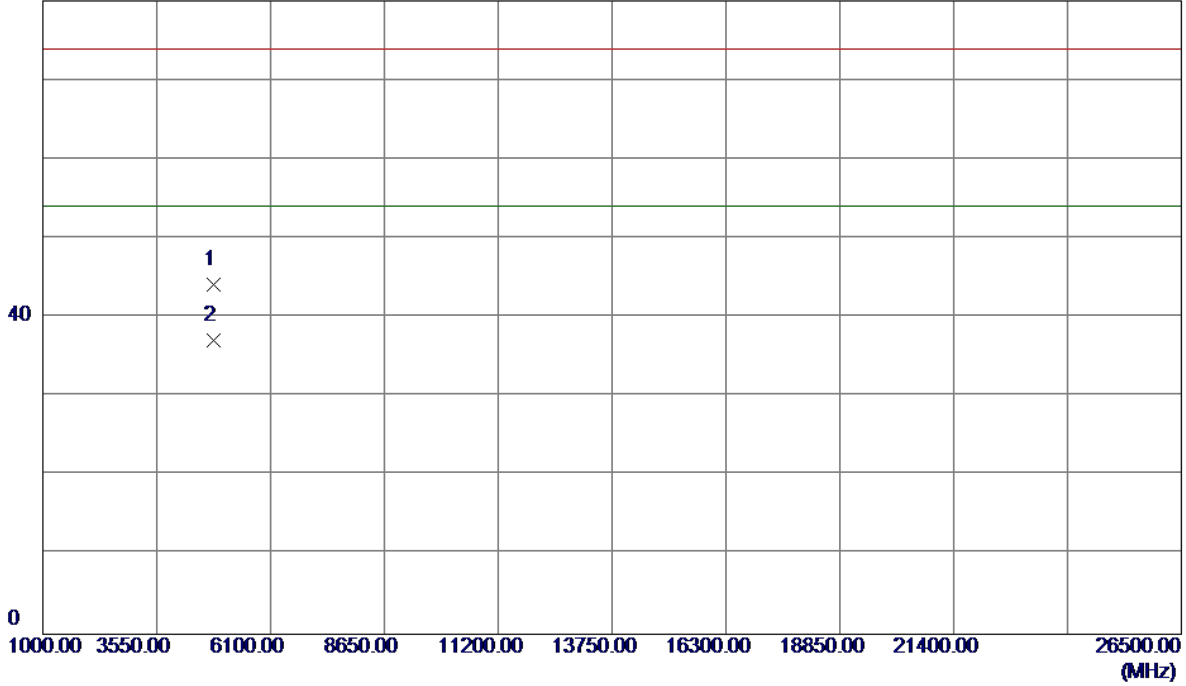

No.	Freq. MHz	Reading Level dBuV/m	Correct Factor dB	Measure ment dBuV/m	Limit dBuV/m	Margin dB	Detector	Comment
1	4823.9200	37.82	6.32	44.14	74.00	-29.86	Peak	
2 *	4823.9700	30.74	6.32	37.06	54.00	-16.94	AVG	



Orthogonal Axis :	X
Test Mode :	TX N-20M MODE 2412MHz

**Horizontal**

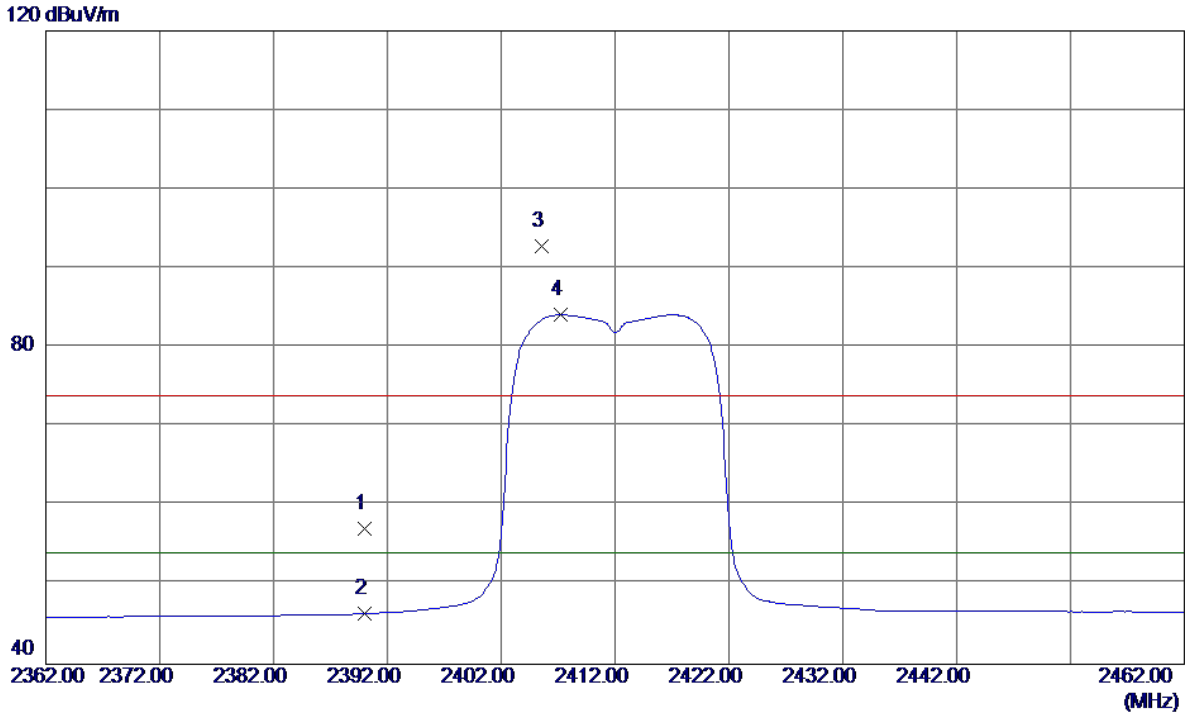

No.	Freq. MHz	Reading Level dBuV/m	Correct Factor dB	Measure ment dBuV/m	Limit dBuV/m	Margin dB	Detector	Comment
1	2390.0000	23.99	33.06	57.05	74.00	-16.95	Peak	
2	2390.0000	13.32	33.06	46.38	54.00	-7.62	AVG	
3	2405.6000	59.70	33.11	92.81	74.00	18.81	Peak	No Limit
4 *	2407.2000	51.00	33.12	84.12	54.00	30.12	AVG	No Limit

Orthogonal Axis :	X
Test Mode :	TX N-20M MODE 2412MHz

### Horizontal

80 dBuV/m

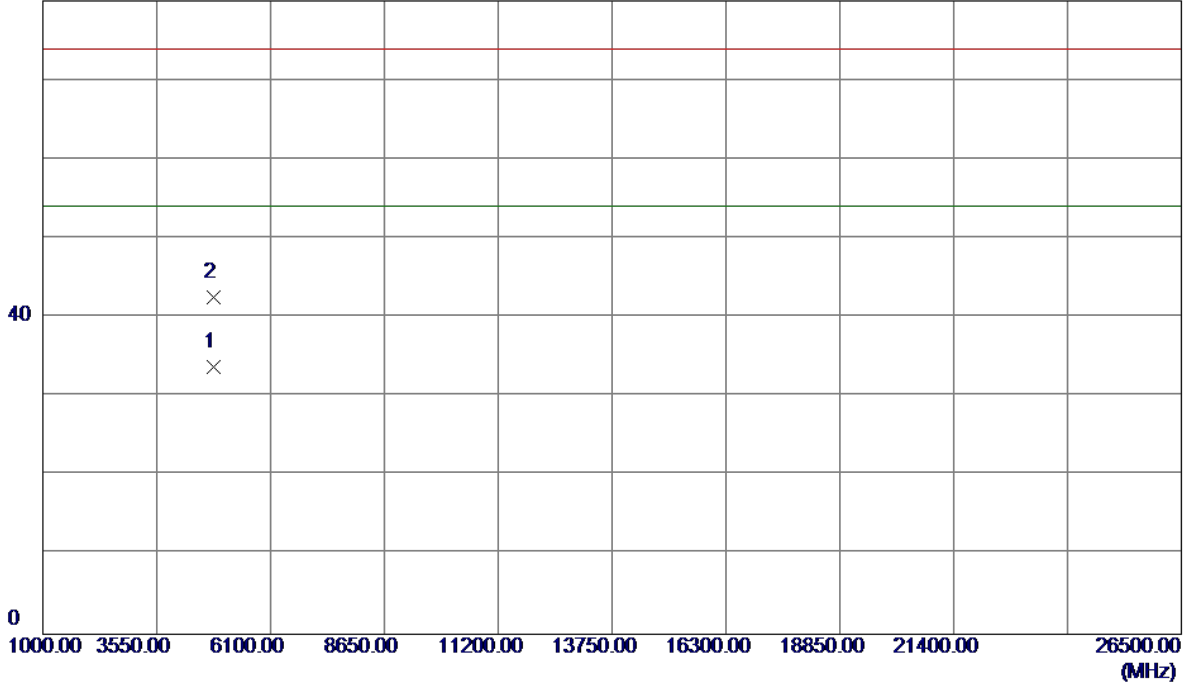

No.	Freq. MHz	Reading Level dBuV/m	Correct Factor dB	Measure ment dBuV/m	Limit dBuV/m	Margin dB	Detector	Comment
1 *	4823.9300	27.46	6.32	33.78	54.00	-20.22	AVG	
2	4824.1800	36.28	6.32	42.60	74.00	-31.40	Peak	

Orthogonal Axis :	X
Test Mode :	TX N-20M MODE 2437MHz

**Vertical**

120 dBuV/m

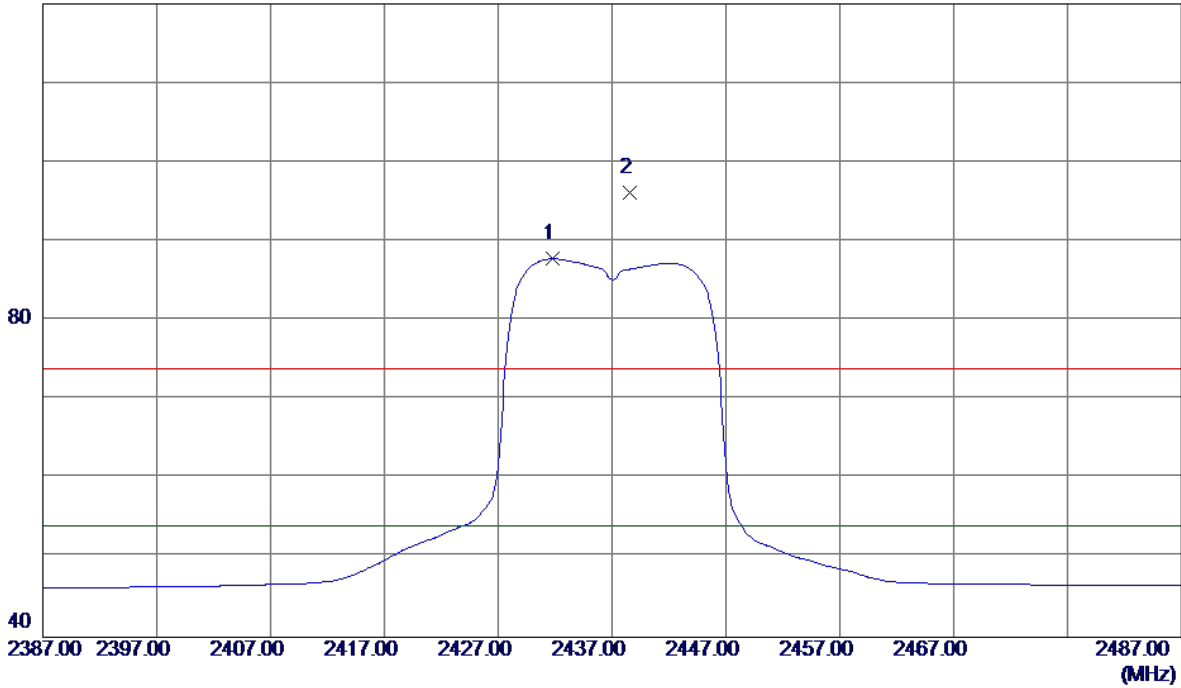

No.	Freq. MHz	Reading Level dBuV/m	Correct Factor dB	Measure ment dBuV/m	Limit dBuV/m	Margin dB	Detector	Comment
1 *	2431.8000	54.58	33.21	87.79	54.00	33.79	AVG	No Limit
2	2438.6000	62.91	33.24	96.15	74.00	22.15	Peak	No Limit

Orthogonal Axis :	X
Test Mode :	TX N-20M MODE 2437MHz

**Vertical**

80 dBuV/m

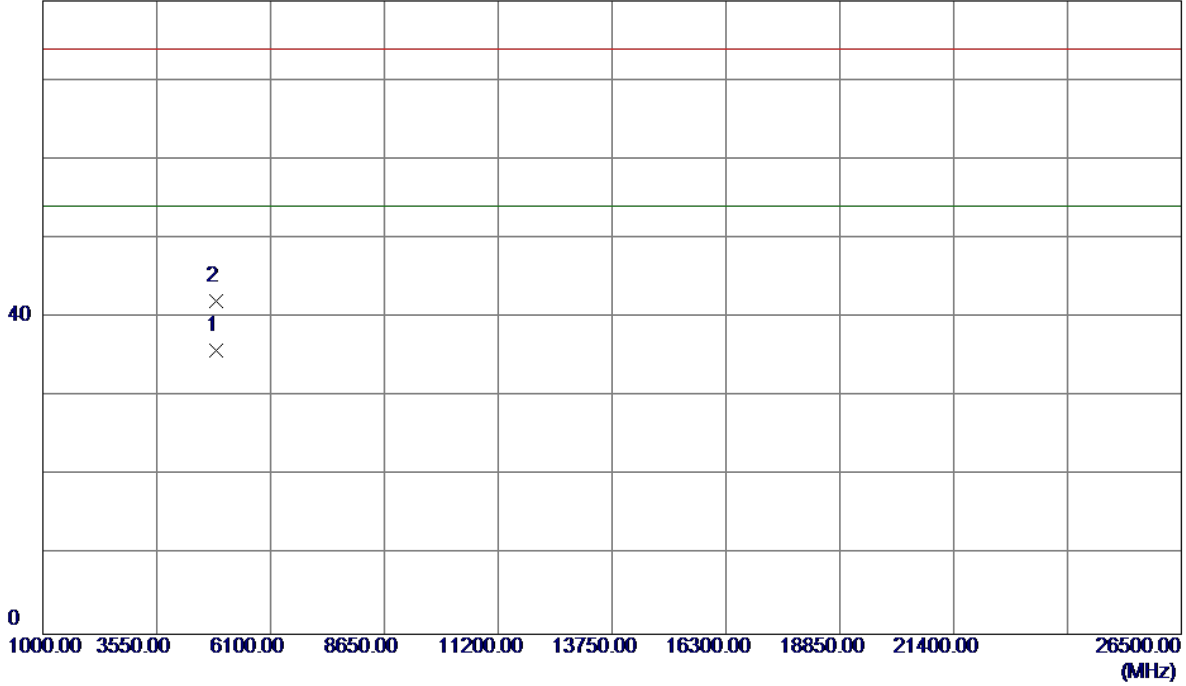

No.	Freq. MHz	Reading Level dBuV/m	Correct Factor dB	Measure ment dBuV/m	Limit dBuV/m	Margin dB	Detector	Comment
1 *	4873.9400	29.42	6.44	35.86	54.00	-18.14	AVG	
2	4874.1500	35.57	6.44	42.01	74.00	-31.99	Peak	

Orthogonal Axis :	X
Test Mode :	TX N-20M MODE 2437MHz

**Horizontal**

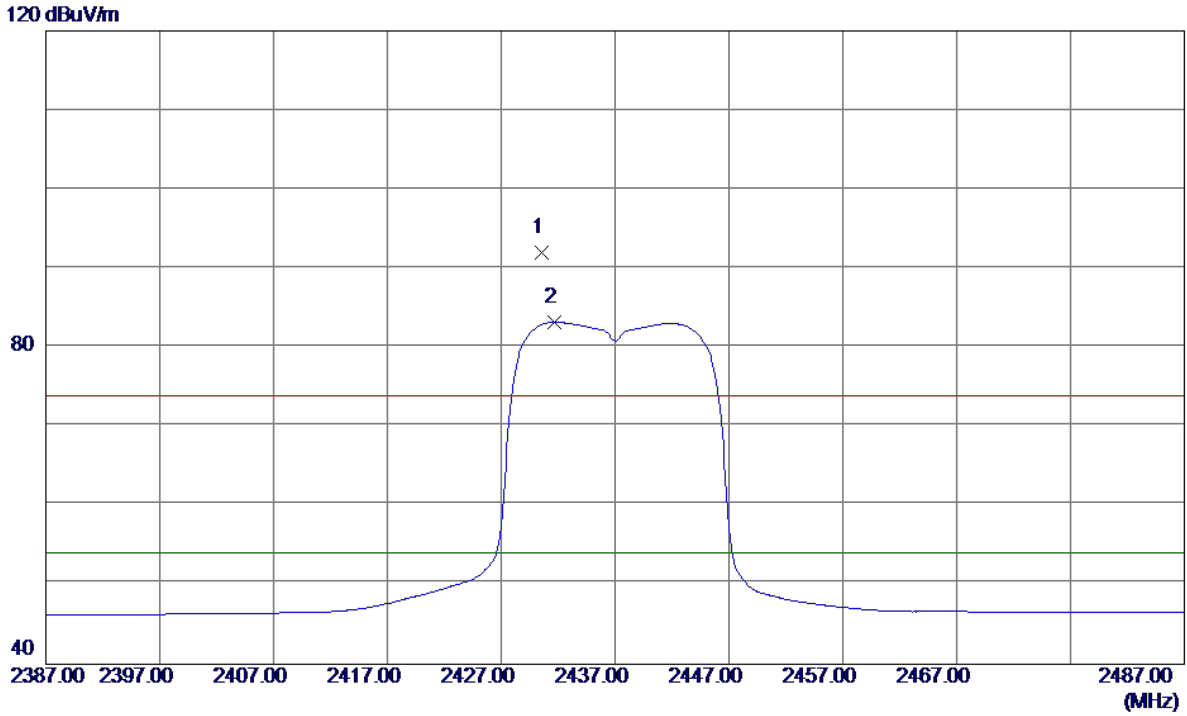

No.	Freq. MHz	Reading Level dBuV/m	Correct Factor dB	Measure ment dBuV/m	Limit dBuV/m	Margin dB	Detector	Comment
1	2430.6000	58.85	33.21	92.06	74.00	18.06	Peak	No Limit
2 *	2431.7000	50.00	33.21	83.21	54.00	29.21	AVG	No Limit

Orthogonal Axis :	X
Test Mode :	TX N-20M MODE 2437MHz

**Horizontal**

80 dBuV/m

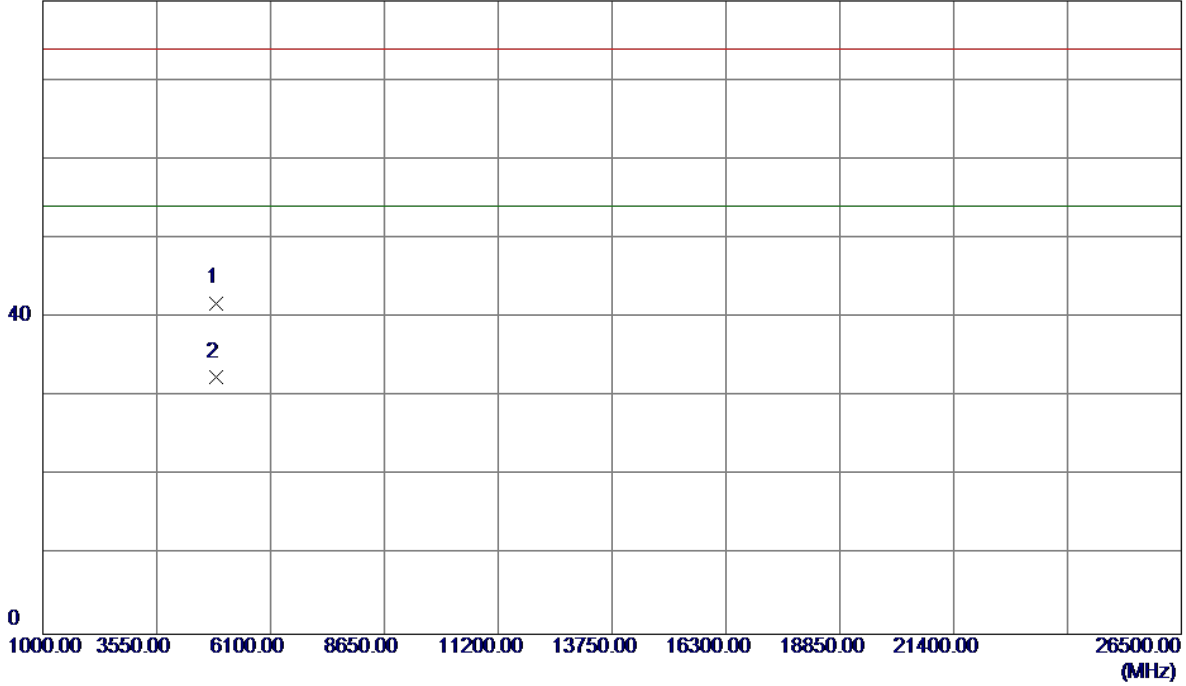

No.	Freq. MHz	Reading Level dBuV/m	Correct Factor dB	Measure ment dBuV/m	Limit dBuV/m	Margin dB	Detector	Comment
1	4873.8300	35.40	6.44	41.84	74.00	-32.16	Peak	
2 *	4873.9700	26.10	6.44	32.54	54.00	-21.46	AVG	

Orthogonal Axis :	X
Test Mode :	TX N-20M MODE 2462MHz

**Vertical**

120 dBuV/m

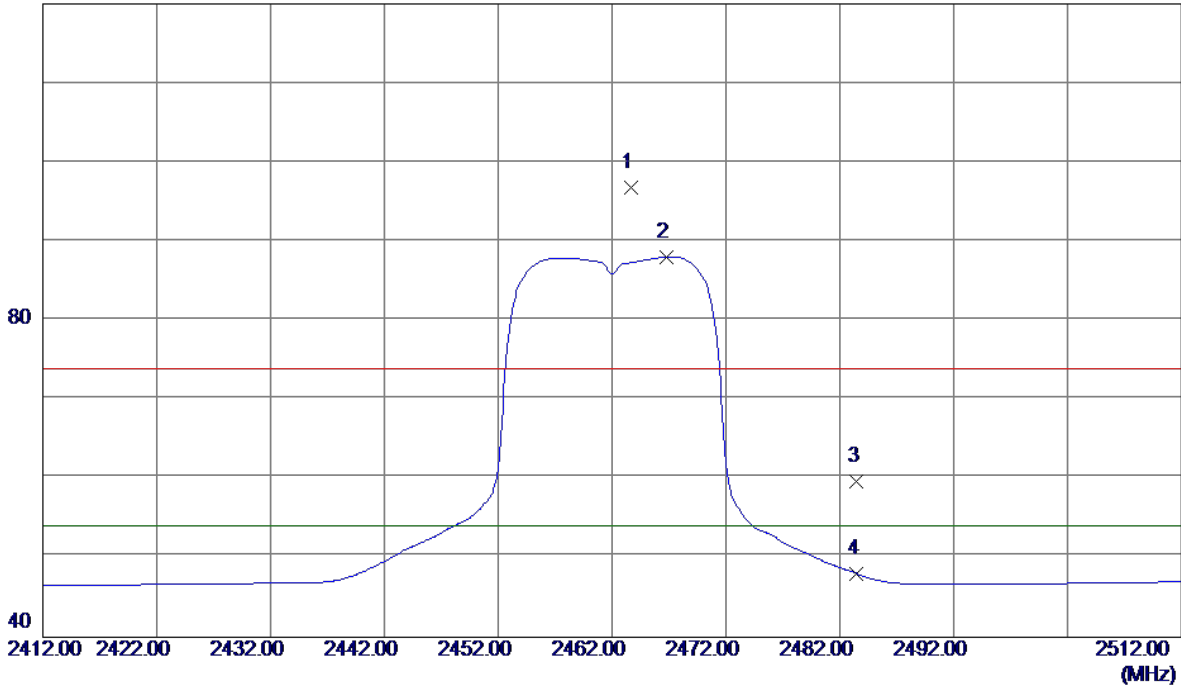

No.	Freq. MHz	Reading Level dBuV/m	Correct Factor dB	Measure ment dBuV/m	Limit dBuV/m	Margin dB	Detector	Comment
1	2463.7000	63.50	33.33	96.83	74.00	22.83	Peak	No Limit
2 *	2466.8000	54.70	33.35	88.05	54.00	34.05	AVG	No Limit
3	2483.5000	26.34	33.41	59.75	74.00	-14.25	Peak	
4	2483.5000	14.60	33.41	48.01	54.00	-5.99	AVG	

Orthogonal Axis :	X
Test Mode :	TX N-20M MODE 2462MHz

**Vertical**

80 dBuV/m

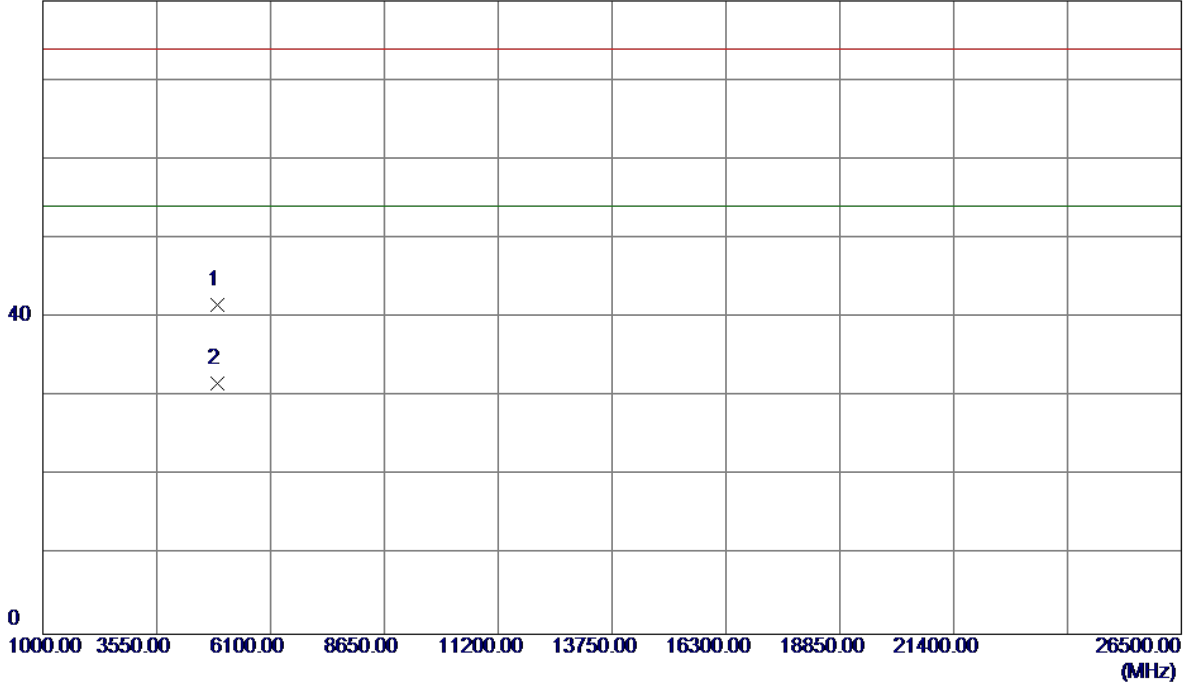

No.	Freq. MHz	Reading Level dBuV/m	Correct Factor dB	Measure ment dBuV/m	Limit dBuV/m	Margin dB	Detector	Comment
1	4923.7500	34.97	6.57	41.54	74.00	-32.46	Peak	
2 *	4923.9800	25.10	6.57	31.67	54.00	-22.33	AVG	



Orthogonal Axis :	X
Test Mode :	TX N-20M MODE 2462MHz

**Horizontal**

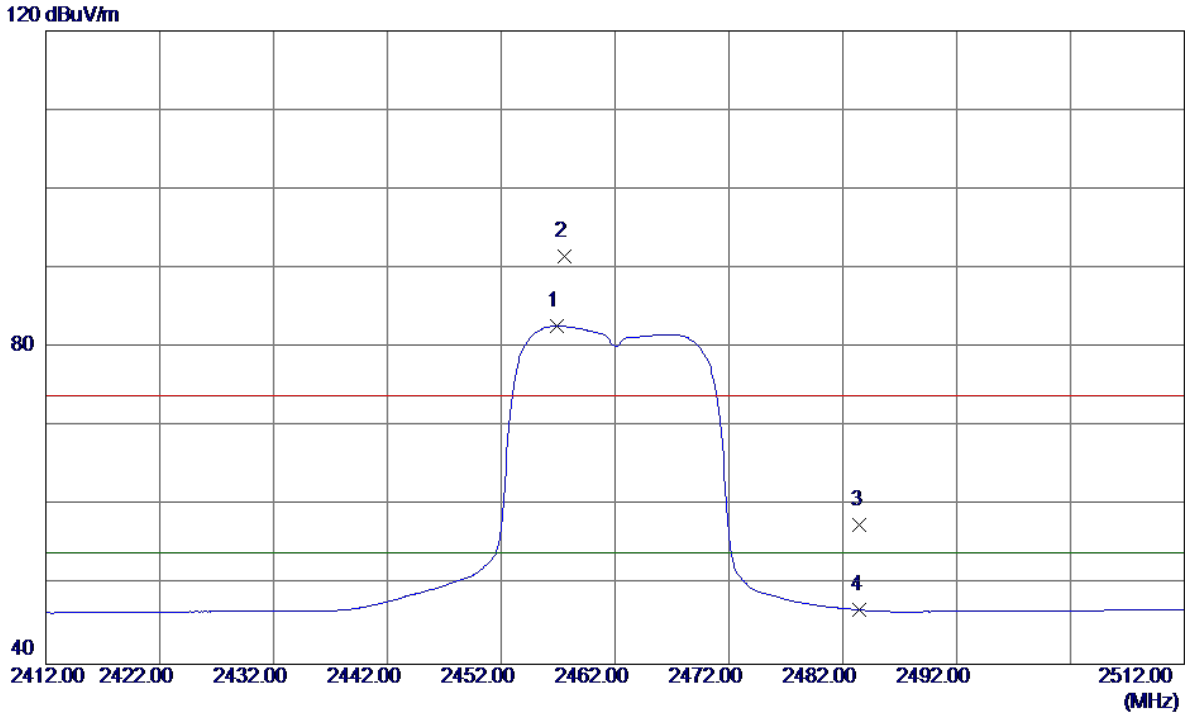

No.	Freq. MHz	Reading Level dBuV/m	Correct Factor dB	Measure ment dBuV/m	Limit dBuV/m	Margin dB	Detector	Comment
1 *	2456.9000	49.41	33.31	82.72	54.00	28.72	AVG	No Limit
2	2457.6000	58.15	33.31	91.46	74.00	17.46	Peak	No Limit
3	2483.5000	24.26	33.41	57.67	74.00	-16.33	Peak	
4	2483.5000	13.45	33.41	46.86	54.00	-7.14	AVG	

Orthogonal Axis :	X
Test Mode :	TX N-20M MODE 2462MHz

**Horizontal**

80 dBuV/m

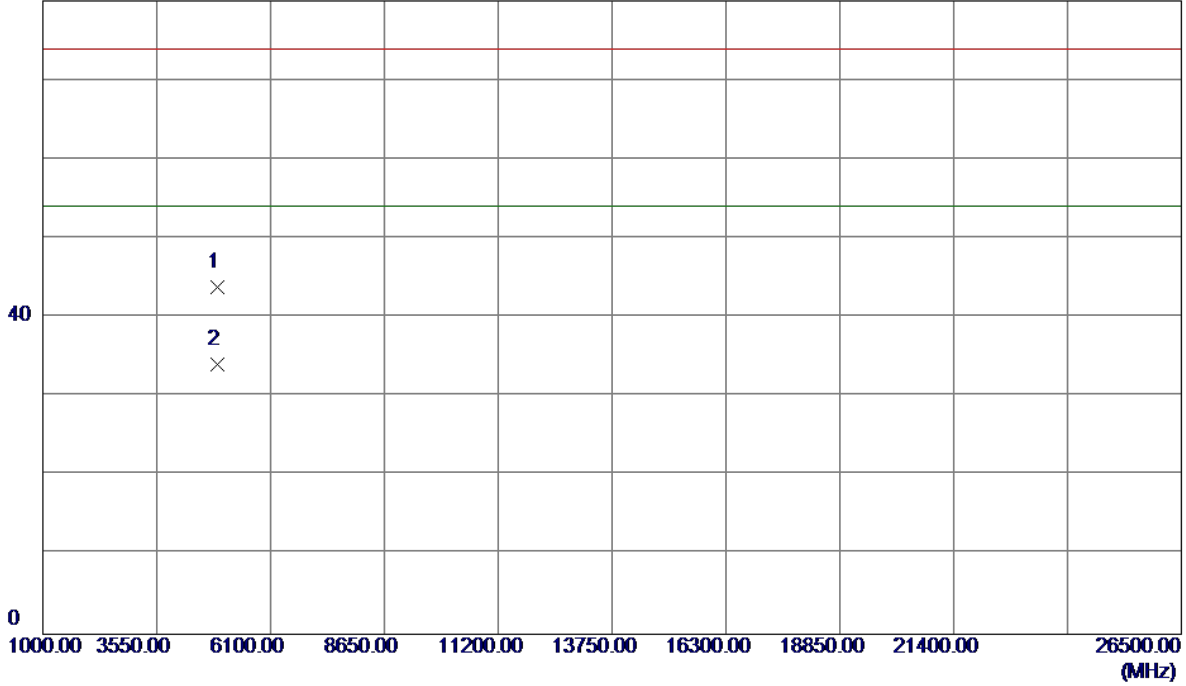

No.	Freq. MHz	Reading Level dBuV/m	Correct Factor dB	Measure ment dBuV/m	Limit dBuV/m	Margin dB	Detector	Comment
1	4923.6800	37.28	6.57	43.85	74.00	-30.15	Peak	
2 *	4923.9100	27.56	6.57	34.13	54.00	-19.87	AVG	

Orthogonal Axis :	X
Test Mode :	TX N-40M MODE 2422MHz

**Vertical**

120 dBuV/m

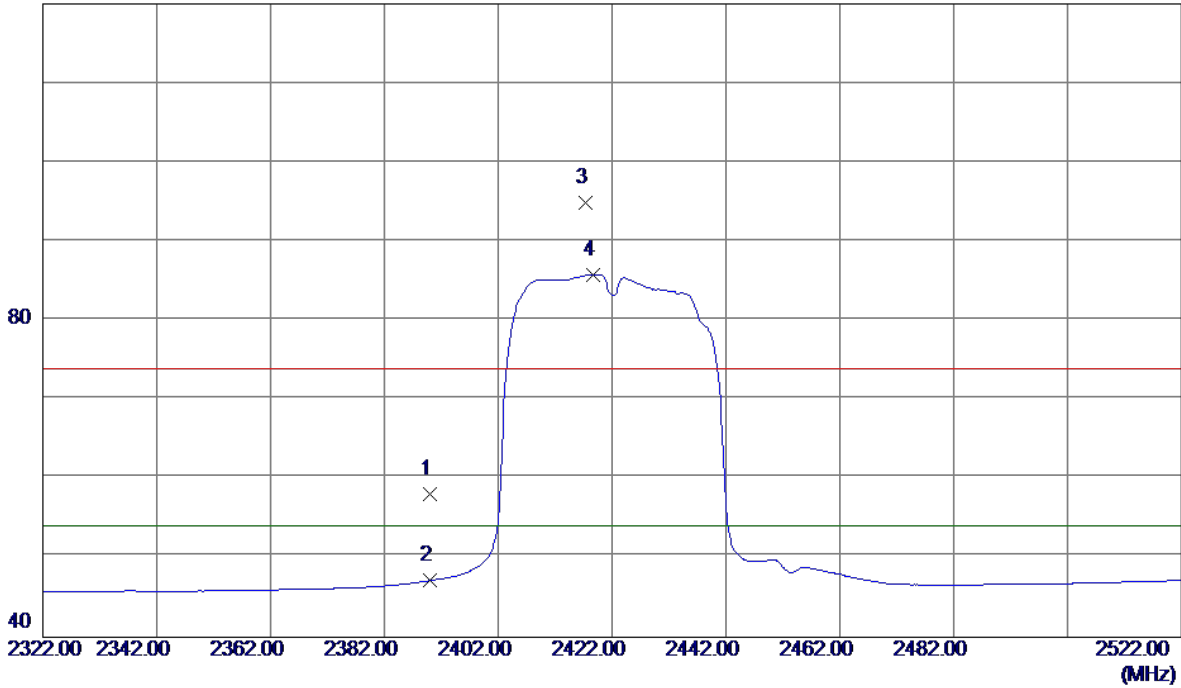

No.	Freq. MHz	Reading Level dBuV/m	Correct Factor dB	Measure ment dBuV/m	Limit dBuV/m	Margin dB	Detector	Comment
1	2390.0000	24.98	33.06	58.04	74.00	-15.96	Peak	
2	2390.0000	14.10	33.06	47.16	54.00	-6.84	AVG	
3	2417.4000	61.79	33.16	94.95	74.00	20.95	Peak	No Limit
4 *	2418.6000	52.65	33.16	85.81	54.00	31.81	AVG	No Limit

Orthogonal Axis :	X
Test Mode :	TX N-40M MODE 2422MHz

**Vertical**

80 dBuV/m

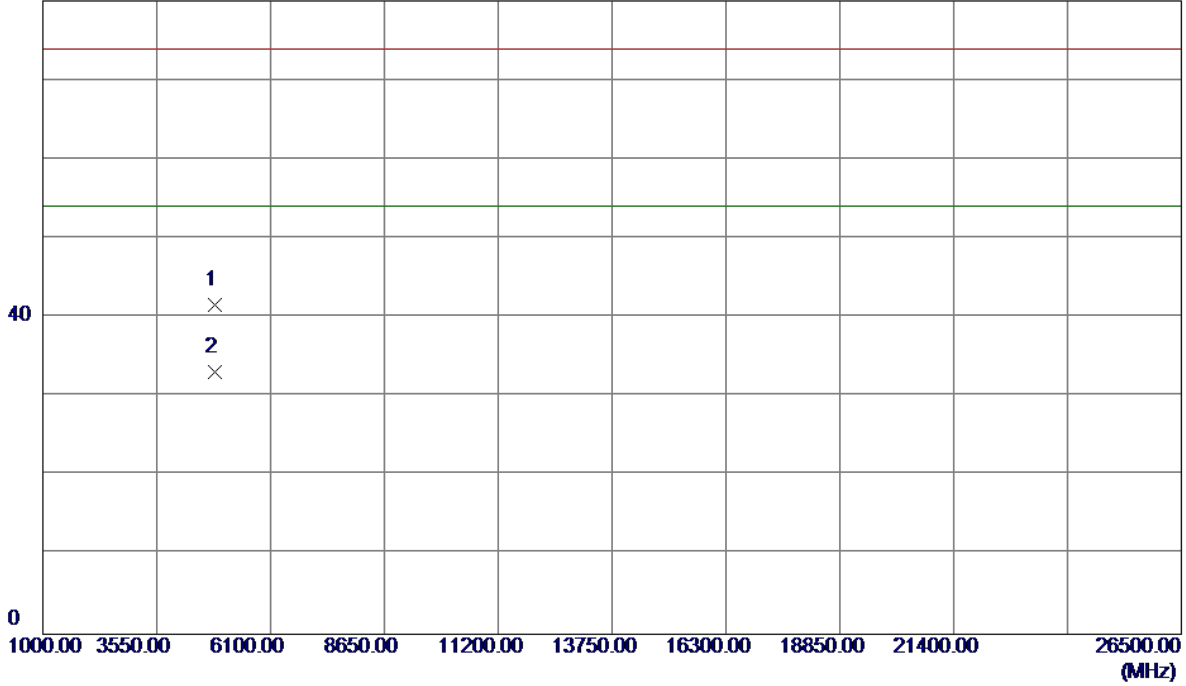

No.	Freq. MHz	Reading Level dBuV/m	Correct Factor dB	Measure ment dBuV/m	Limit dBuV/m	Margin dB	Detector	Comment
1	4843.8100	35.24	6.37	41.61	74.00	-32.39	Peak	
2 *	4843.8900	26.81	6.37	33.18	54.00	-20.82	AVG	

Orthogonal Axis :	X
Test Mode :	TX N-40M MODE 2422MHz

**Horizontal**

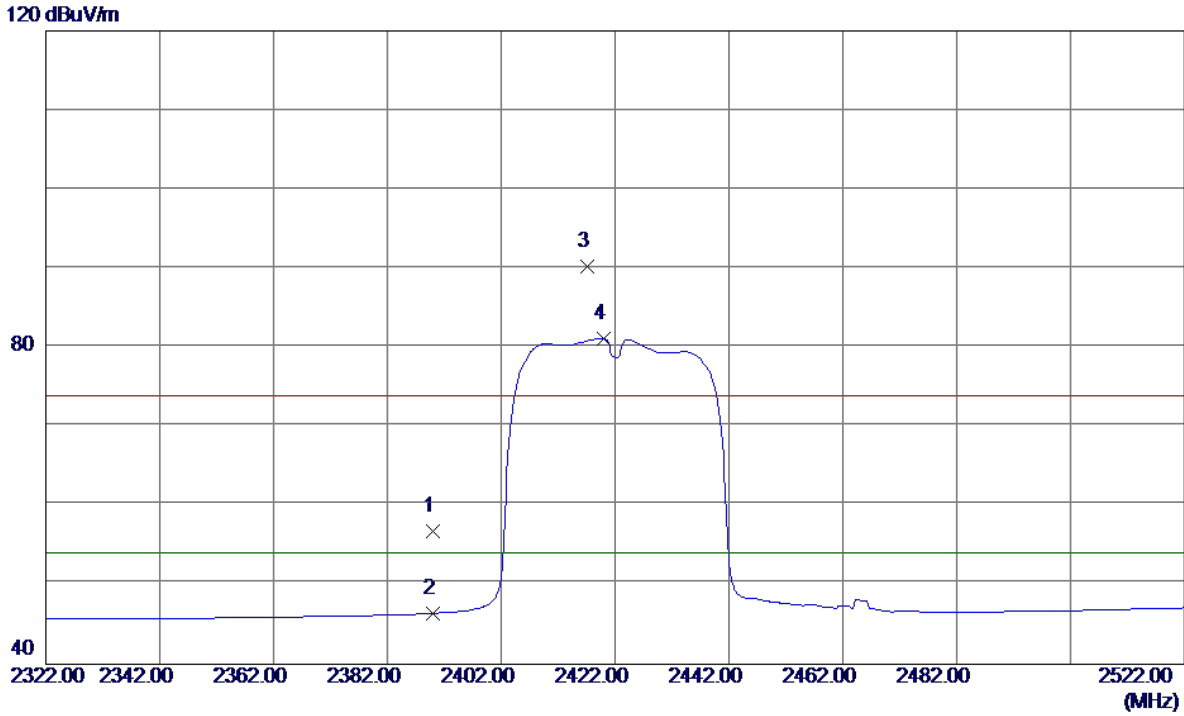

No.	Freq. MHz	Reading Level dBuV/m	Correct Factor dB	Measure ment dBuV/m	Limit dBuV/m	Margin dB	Detector	Comment
1	2390.0000	23.73	33.06	56.79	74.00	-17.21	Peak	
2	2390.0000	13.37	33.06	46.43	54.00	-7.57	AVG	
3	2417.2000	57.16	33.16	90.32	74.00	16.32	Peak	No Limit
4 *	2420.0000	47.94	33.17	81.11	54.00	27.11	AVG	No Limit

Orthogonal Axis :	X
Test Mode :	TX N-40M MODE 2422MHz

### Horizontal

80 dBuV/m

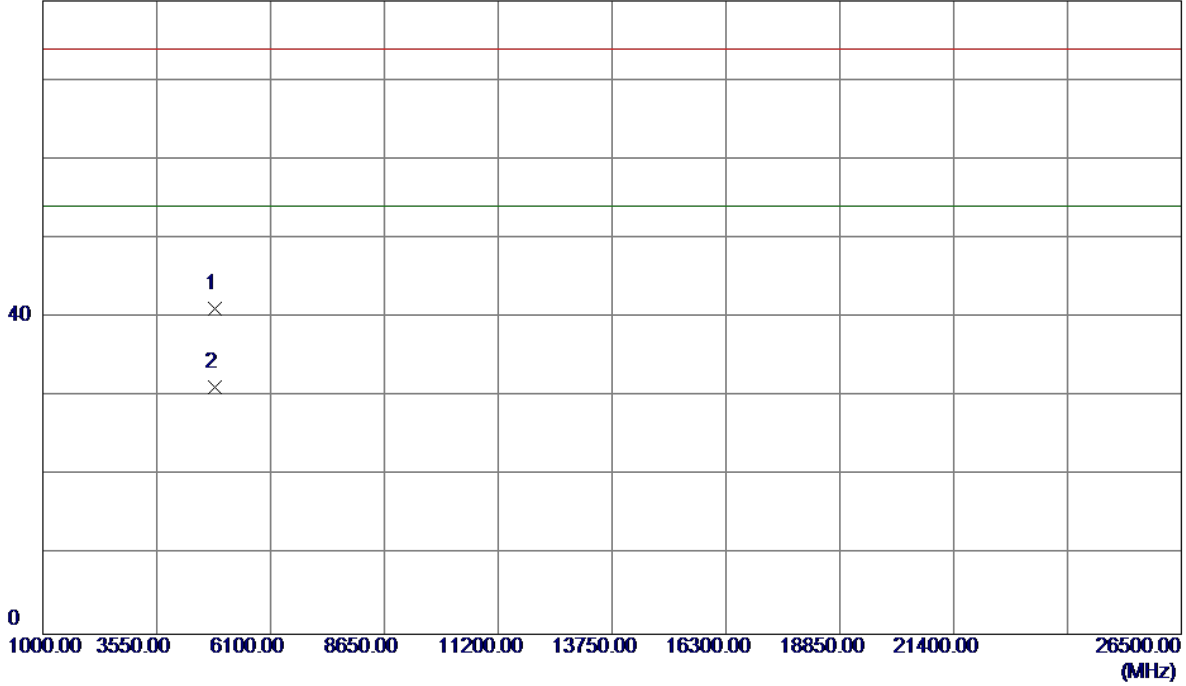

No.	Freq. MHz	Reading Level dBuV/m	Correct Factor dB	Measure ment dBuV/m	Limit dBuV/m	Margin dB	Detector	Comment
1	4843.4700	34.70	6.37	41.07	74.00	-32.93	Peak	
2 *	4843.8800	24.80	6.37	31.17	54.00	-22.83	AVG	