

# FCC Radio Test Report

## FCC ID: V7TAC8

This report concerns: **Original Grant**

**Project No.** : 1906C044A  
**Equipment** : AC1200 Dual-band Gigabit Wireless Router  
**Brand Name** : Tenda  
**Test Model** : AC8  
**Series Model** : N/A  
**Applicant** : SHENZHEN TENDA TECHNOLOGY CO.,LTD  
**Address** : 6-8 Floor, Tower E3, No. 1001, Zhongshanyuan Road, Nanshan District, Shenzhen, China. 518052  
**Manufacturer** : SHENZHEN TENDA TECHNOLOGY CO.,LTD  
**Address** : 6-8 Floor, Tower E3, No. 1001, Zhongshanyuan Road, Nanshan District, Shenzhen, China. 518052  
**Date of Receipt** : Aug. 26, 2019  
**Date of Test** : Aug. 26, 2019~Sep. 25, 2019  
**Issued Date** : Oct. 12, 2019  
**Report Version** : R00  
**Test Sample** : Engineering Sample No.: DG19082228  
**Standard(s)** : FCC Part15, Subpart C (15.247)  
ANSI C63.10-2013  
KDB 558074 D01 15.247 Meas Guidance v05r02

The above equipment has been tested and found compliance with the requirement of the relative standards by BTL Inc.

*Kai Xu*

Prepared by : Kai Xu

*Ethan Ma*

Approved by : Ethan Ma



Certificate #5123.02

Add: No.3, Jinshagang 1st Road, Shixia, Dalang Town,Dongguan, Guangdong, China.

Tel: +86-769-8318-3000

Web: [www.newbtl.com](http://www.newbtl.com)

**Declaration**

**BTL** represents to the client that testing is done in accordance with standard procedures as applicable and that test instruments used has been calibrated with standards traceable to international standard(s) and/or national standard(s).

**BTL's** reports apply only to the specific samples tested under conditions. It is manufacture's responsibility to ensure that additional production units of this model are manufactured with the identical electrical and mechanical components. **BTL** shall have no liability for any declarations, inferences or generalizations drawn by the client or others from **BTL** issued reports.

The report must not be used by the client to claim product certification, approval, or endorsement by NVLAP, NIST, A2LA, or any agency of the U.S. Government.

This report is the confidential property of the client. As a mutual protection to the clients, the public and ourselves, the test report shall not be reproduced, except in full, without our written approval.

**BTL's** laboratory quality assurance procedures are in compliance with the **ISO/IEC 17025** requirements, and accredited by the conformity assessment authorities listed in this test report.

**BTL** is not responsible for the sampling stage, so the results only apply to the sample as received.

The information, data and test plan are provided by manufacturer which may affect the validity of results, so it is manufacturer's responsibility to ensure that the apparatus meets the essential requirements of applied standards and in all the possible configurations as representative of its intended use.

**Limitation**

For the use of the authority's logo is limited unless the Test Standard(s)/Scope(s)/Item(s) mentioned in this test report is (are) included in the conformity assessment authorities acceptance respective.

Please note that the measurement uncertainty is provided for informational purpose only and are not use in determining the Pass/Fail results.

<b>Table of Contents</b>	<b>Page</b>
<b>REPORT ISSUED HISTORY</b>	<b>6</b>
<b>1 . SUMMARY OF TEST RESULTS</b>	<b>7</b>
1.1 TEST FACILITY	8
1.2 MEASUREMENT UNCERTAINTY	8
1.3 TEST ENVIRONMENT CONDITIONS	8
<b>2 . GENERAL INFORMATION</b>	<b>9</b>
2.1 GENERAL DESCRIPTION OF EUT	9
2.2 DESCRIPTION OF TEST MODES	11
2.3 PARAMETERS OF TEST SOFTWARE	13
2.4 DUTY CYCLE	14
2.5 BLOCK DIAGRAM SHOWING THE CONFIGURATION OF SYSTEM TESTED	15
2.6 SUPPORT UNITS	15
<b>3 . AC POWER LINE CONDUCTED EMISSIONS TEST</b>	<b>16</b>
3.1 LIMIT	16
3.2 TEST PROCEDURE	16
3.3 DEVIATION FROM TEST STANDARD	16
3.4 TEST SETUP	17
3.5 EUT OPERATION CONDITIONS	17
3.6 TEST RESULTS	17
<b>4 . RADIATED EMISSIONS TEST</b>	<b>18</b>
4.1 LIMIT	18
4.2 TEST PROCEDURE	19
4.3 DEVIATION FROM TEST STANDARD	19
4.4 TEST SETUP	20
4.5 EUT OPERATION CONDITIONS	21
4.6 TEST RESULTS - 9 KHZ TO 30 MHZ	21
4.7 TEST RESULTS - 30 MHZ TO 1000 MHZ	21
4.8 TEST RESULTS - ABOVE 1000 MHZ	21
<b>5 . BANDWIDTH TEST</b>	<b>22</b>
5.1 LIMIT	22
5.2 TEST PROCEDURE	22
5.3 DEVIATION FROM STANDARD	22

<b>Table of Contents</b>	<b>Page</b>
5.4 TEST SETUP	22
5.5 EUT OPERATION CONDITIONS	22
5.6 TEST RESULTS	22
<b>6 . MAXIMUM AVERAGE OUTPUT POWER TEST</b>	<b>23</b>
6.1 LIMIT	23
6.2 TEST PROCEDURE	23
6.3 DEVIATION FROM STANDARD	23
6.4 TEST SETUP	23
6.5 EUT OPERATION CONDITIONS	23
6.6 TEST RESULTS	23
<b>7 . CONDUCTED SPURIOUS EMISSIONS</b>	<b>24</b>
7.1 LIMIT	24
7.2 TEST PROCEDURE	24
7.3 DEVIATION FROM STANDARD	24
7.4 TEST SETUP	24
7.5 EUT OPERATION CONDITIONS	24
7.6 TEST RESULTS	24
<b>8 . POWER SPECTRAL DENSITY TEST</b>	<b>25</b>
8.1 LIMIT	25
8.2 TEST PROCEDURE	25
8.3 DEVIATION FROM STANDARD	25
8.4 TEST SETUP	25
8.5 EUT OPERATION CONDITIONS	25
8.6 TEST RESULTS	25
<b>9 . MEASUREMENT INSTRUMENTS LIST</b>	<b>26</b>
<b>10 . EUT TEST PHOTO</b>	<b>28</b>
<b>APPENDIX A - AC POWER LINE CONDUCTED EMISSIONS</b>	<b>32</b>
<b>APPENDIX B - RADIATED EMISSION - 9 KHZ TO 30 MHZ</b>	<b>35</b>
<b>APPENDIX C - RADIATED EMISSION - 30 MHZ TO 1000 MHZ</b>	<b>40</b>
<b>APPENDIX D - RADIATED EMISSION- ABOVE 1000 MHZ</b>	<b>43</b>
<b>APPENDIX E - BANDWIDTH</b>	<b>92</b>
<b>APPENDIX F - MAXIMUM AVERAGE OUTPUT POWER</b>	<b>97</b>

**Table of Contents****Page****APPENDIX G - CONDUCTED SPURIOUS EMISSIONS****102****APPENDIX H - POWER SPECTRAL DENSITY****109**

**REPORT ISSUED HISTORY**

Report Version	Description	Issued Date
R00	Original Issue.	Oct. 12, 2019

## 1. SUMMARY OF TEST RESULTS

Test procedures according to the technical standard(s):

FCC Part15, Subpart C (15.247)				
Standard(s) Section	Test Item	Test Result	Judgment	Remark
15.207	AC Power Line Conducted Emissions	APPENDIX A	PASS	-----
15.247(d) 15.205(a) 15.209(a)	Radiated Emissions	APPENDIX B APPENDIX C APPENDIX D	PASS	-----
15.247(a)(2)	Bandwidth	APPENDIX E	PASS	-----
15.247(b)(3)	Maximum Average Output Power	APPENDIX F	PASS	-----
15.247(d)	Conducted Spurious Emissions	APPENDIX G	PASS	-----
15.247(e)	Power Spectral Density	APPENDIX H	PASS	-----
15.203	Antenna Requirement	-----	PASS	Note(2)

Note:

- (1) "N/A" denotes test is not applicable in this test report.
- (2) The device what use a permanently attached antenna were considered sufficient to comply with the provisions of 15.203.

### 1.1 TEST FACILITY

The test facilities used to collect the test data in this report is at the location of No.3,Jinshagang 1st Road, Shixia, Dalang Town, Dongguan, Guangdong, China.

BTL's Test Firm Registration Number for FCC: 357015

BTL's Designation Number for FCC: CN1240

### 1.2 MEASUREMENT UNCERTAINTY

ISO/IEC 17025 requires that an estimate of the measurement uncertainties associated with the emissions test results be included in the report. The measurement uncertainties given below are based on a 95% confidence level (based on a coverage factor (k=2))

The BTL measurement uncertainty as below table:

#### A. AC power line conducted emissions test:

Test Site	Method	Measurement Frequency Range	U, (dB)
DG-C02	CISPR	150 kHz ~ 30 MHz	2.32

#### B. Radiated emissions test:

Test Site	Method	Measurement Frequency Range	Ant. H / V	U, (dB)
DG-CB03	CISPR	9kHz ~ 30MHz	V	3.79
		9kHz ~ 30MHz	H	3.57
		30MHz ~ 200MHz	V	4.88
		30MHz ~ 200MHz	H	4.14
		200MHz ~ 1,000MHz	V	4.62
		200MHz ~ 1,000MHz	H	4.80
		1GHz ~ 6GHz	-	4.58
		6GHz ~ 18GHz	-	5.18
		18GHz ~ 26.5GHz	-	3.80
26.5GHz ~ 40GHz	-	4.30		

Note: Unless specifically mentioned, the uncertainty of measurement has not been taken into account to declare the compliance or non-compliance to the specification.

### 1.3 TEST ENVIRONMENT CONDITIONS

Test Item	Temperature	Humidity	Test Voltage	Tested By
AC Power Line Conducted Emissions	25°C	53%	AC 120V/60Hz	Damon Deng
Radiated Emissions-9K-30MHz	25°C	60%	AC 120V/60Hz	Hand Huang
Radiated Emissions-30 MHz to 1GHz	24°C	68%	AC 120V/60Hz	Sheldon Ou
Radiated Emissions-Above 1000 MHz	24°C	68%	AC 120V/60Hz	Sheldon Ou
Bandwidth	26°C	52%	AC 120V/60Hz	Jonas Chen
Maximum Average Output Power	26°C	52%	AC 120V/60Hz	Jonas Chen
Conducted Spurious Emissions	26°C	52%	AC 120V/60Hz	Jonas Chen
Power Spectral Density	26°C	52%	AC 120V/60Hz	Jonas Chen



## 2. GENERAL INFORMATION

### 2.1 GENERAL DESCRIPTION OF EUT

Equipment	AC1200 Dual-band Gigabit Wireless Router
Brand Name	Tenda
Test Model	AC8
Series Model	N/A
Model Difference(s)	N/A
Power Source	DC Voltage supplied from AC/DC adapter. Model: BN052-A09009U
Power Rating	I/P:100-240V~, 50/60Hz 0.3A O/P: 9V --- 1.0A
Operation Frequency	2412 MHz ~ 2462 MHz
Modulation Type	IEEE 802.11b: DSSS IEEE 802.11g: OFDM IEEE 802.11n: OFDM
Bit Rate of Transmitter	IEEE 802.11b: 11/5.5/2/1 Mbps IEEE 802.11g: 54/48/36/24/18/12/9/6 Mbps IEEE 802.11n: up to 300 Mbps
Maximum Average Output Power-Non-Beamforming	IEEE 802.11b: 20.04 dBm (0.1009 W) IEEE 802.11g: 20.53 dBm (0.1130 W) IEEE 802.11n (HT20): 22.06 dBm (0.1607 W) IEEE 802.11n (HT40): 21.39 dBm (0.1376 W)
Maximum Average Output Power-Beamforming	IEEE 802.11n (HT20): 21.46 dBm (0.1399 W) IEEE 802.11n (HT40): 20.81 dBm (0.1204 W)

Note:

- For a more detailed features description, please refer to the manufacturer's specifications or the user's manual.
- Channel List:

CH01 - CH11 for IEEE 802.11b, IEEE 802.11g, IEEE 802.11n (HT20) CH03 - CH09 for IEEE 802.11n (HT40)							
Channel	Frequency (MHz)	Channel	Frequency (MHz)	Channel	Frequency (MHz)	Channel	Frequency (MHz)
01	2412	04	2427	07	2442	10	2457
02	2417	05	2432	08	2447	11	2462
03	2422	06	2437	09	2452		

**3. Antenna Specification:**

Ant.	Brand	Model Name	Antenna Type	Connector	Gain (dBi)
1	N/A	N/A	Dipole	N/A	5
2	N/A	N/A	Dipole	N/A	5

Note:

(1) The EUT incorporates a MIMO function. Physically, the EUT provides two completed transmitters and receivers (2T2R), all transmit signals are completely correlated, then, Direction gain =  $G_{ANT} + 10\log(N)dBi = 5 + 10\log(2)$ , that is Directional gain = 8.01.

So, the out power limit is  $30 - 8.01 + 6 = 27.99$ , the power density limit is  $8 - 8.01 + 6 = 5.99$

(2) Beamforming Gain: 3 dB.

So, Direction gain =  $3 + 5 = 8$ , the out power limit is  $30 - 8 + 6 = 28$ , the power density limit is  $8 - 8 + 6 = 6$ .

**4. The worst case 1TX / 2TX as follow:**
**Non-Beamforming**

Operating Mode	TX Mode	Non-Beamforming	
		1TX	2TX
802.11b		V (ANT 1)	-
802.11g		V (ANT 1)	-
802.11n(20MHz)		-	V (Ant 1 + Ant 2)
802.11n(40MHz)		-	V (Ant 1 + Ant 2)

**Beamforming**

Operating Mode	TX Mode	Beamforming
		2TX
802.11n(20MHz)		V (Ant 1 + Ant 2)
802.11n(40MHz)		V (Ant 1 + Ant 2)

## 2.2 DESCRIPTION OF TEST MODES

The test system was pre-tested based on the consideration of all possible combinations of EUT operation mode.

Pretest Mode	Description
Mode 1	TX B Mode Channel 01/06/11
Mode 2	TX G Mode Channel 01/06/11
Mode 3	TX N-20 MHz Mode Channel 01/06/11
Mode 4	TX N-40 MHz Mode Channel 03/06/09
Mode 5	TX N-20 MHz Mode Channel 01

Following mode(s) as (were) found to be the worst case(s) and selected for the final test.

<b>AC power line conducted emissions test</b>	
Final Test Mode:	Description
Mode 5	TX N-20 MHz Mode Channel 01

<b>Radiated emissions test - Below 1GHz</b>	
Final Test Mode:	Description
Mode 5	TX N-20 MHz Mode Channel 01

<b>Radiated emissions test- Above 1GHz</b>	
Final Test Mode:	Description
Mode 1	TX B Mode Channel 01/06/11
Mode 2	TX G Mode Channel 01/06/11
Mode 3	TX N-20 MHz Mode Channel 01/06/11
Mode 4	TX N-40 MHz Mode Channel 03/06/09

<b>Conducted test</b>	
Final Test Mode:	Description
Mode 1	TX B Mode Channel 01/06/11
Mode 2	TX G Mode Channel 01/06/11
Mode 3	TX N-20 MHz Mode Channel 01/06/11
Mode 4	TX N-40 MHz Mode Channel 03/06/09

**NOTE:**

- (1) The measurements are performed at the high, middle, low available channels.
- (2) 802.11b mode: CCK (1 Mbps)  
802.11g mode: OFDM (6 Mbps)  
802.11n HT20 mode : BPSK (6.5 Mbps)  
802.11n HT40 mode : BPSK (13.5 Mbps)  
For radiated emission tests, the highest output powers were set for final test.
- (3) For radiated emission below 1 GHz test, the IEEE 802.11n20 Channel 01 is found to be the worst case and recorded.
- (4) For radiated emission above 1 GHz test, 1GHz~26.5GHz have been pre-tested and in this report only recorded the worst case. The remaining spurious points are all below the limit value of 20dB.
- (5) The measurements for Power were tested, the worst case is the Non Beamforming, only the worst case documented for other test items.

### 2.3 PARAMETERS OF TEST SOFTWARE

#### Non-Beamforming

Test Software	MPTOOL		
Frequency (MHz)	2412	2437	2462
IEEE 802.11b	85	82	80
IEEE 802.11g	100	100	100
IEEE 802.11n (HT20)	90/100	90/100	95/100
Frequency (MHz)	2422	2437	2452
IEEE 802.11n (HT40)	95/100	95/100	91/96

#### Beamforming

Test Software	MPTOOL		
Frequency (MHz)	2412	2437	2462
IEEE 802.11n (HT20)	87/97	87/97	92/97
Frequency (MHz)	2422	2437	2452
IEEE 802.11n (HT40)	92/97	92/97	88/93

## 2.4 DUTY CYCLE

If duty cycle is  $\geq 98\%$ , duty factor is not required.  
 If duty cycle is  $< 98\%$ , duty factor shall be considered.  
 The output power = measured power + duty factor.

### IEEE 802.11b

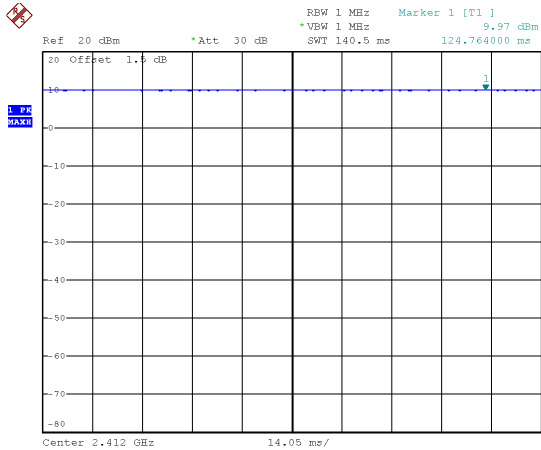

Date: 27.AUG.2019 16:20:14

Duty cycle = 0.000 ms / 0.000 ms = 0.00%  
 Duty Factor =  $10 \log(1/\text{Duty cycle}) = 0.00$   
**IEEE 802.11n (HT20)**

### IEEE 802.11g

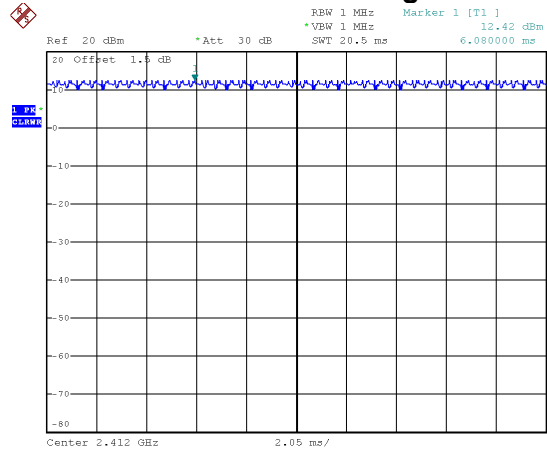

Date: 27.AUG.2019 16:22:27

Duty cycle = 0.000 ms / 0.000 ms = 0.00%  
 Duty Factor =  $10 \log(1/\text{Duty cycle}) = 0.00$   
**IEEE 802.11n (HT40)**

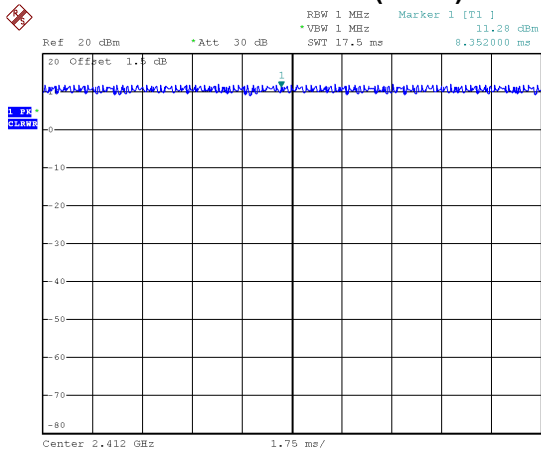

Date: 27.AUG.2019 16:23:01

Duty cycle = 0.000 ms / 0.000 ms = 0.00%  
 Duty Factor =  $10 \log(1/\text{Duty cycle}) = 0.00$ ,

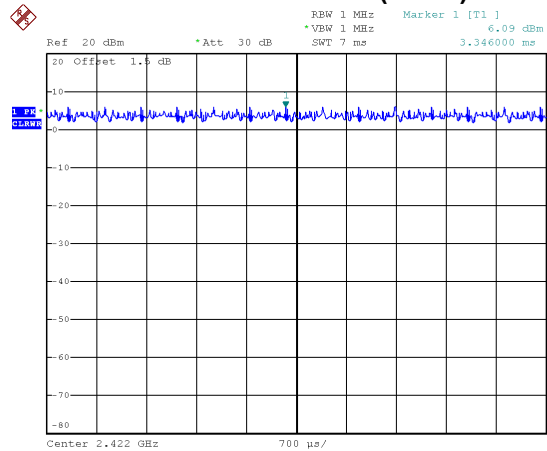

Date: 27.AUG.2019 16:23:38

Duty cycle = 0.000 ms / 0.000 ms = 0.00%  
 Duty Factor =  $10 \log(1/\text{Duty cycle}) = 0.00$

**NOTE:**

For IEEE 802.11g and IEEE 802.11n (HT20):  
 For radiated emissions frequency above 1 GHz, the resolution bandwidth of test receiver/spectrum analyzer is 1 MHz and the video bandwidth is 1 kHz (Duty cycle  $< 98\%$ ).

For IEEE 802.11n (HT40):  
 For radiated emissions frequency above 1 GHz, the resolution bandwidth of test receiver/spectrum analyzer is 1 MHz and the video bandwidth is 2 kHz (Duty cycle  $< 98\%$ ).

## 2.5 BLOCK DIAGRAM SHOWING THE CONFIGURATION OF SYSTEM TESTED

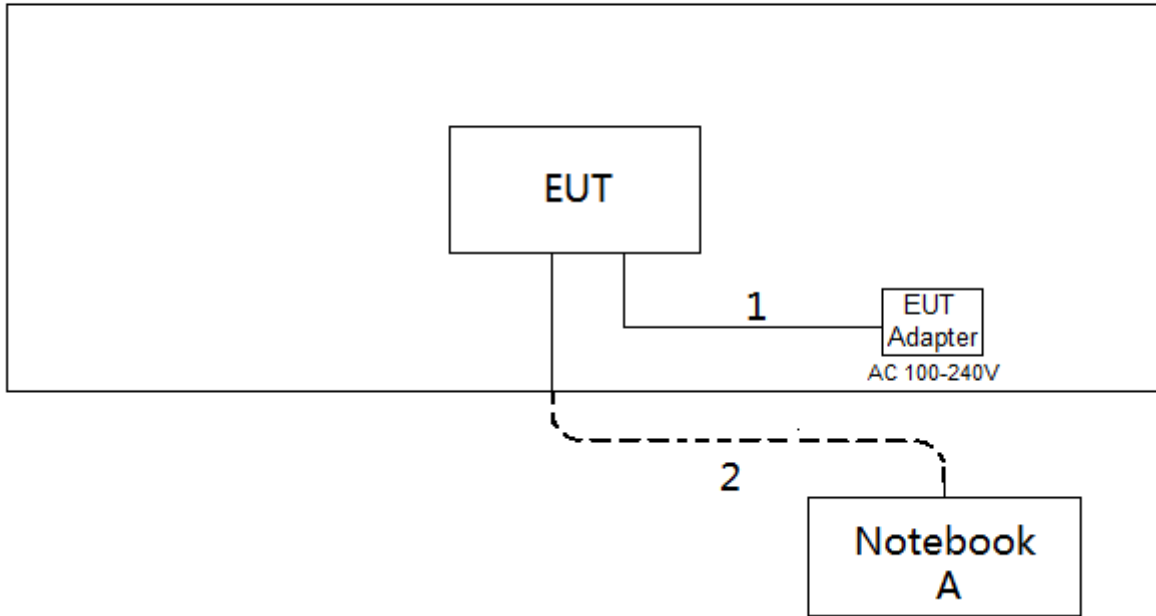

## 2.6 SUPPORT UNITS

Item	Equipment	Brand	Model No.	Series No.
A	Notebook	Dell	Inspiron 15-7559	N/A

Item	Cable Type	Shielded Type	Ferrite Core	Length
1	DC Cable	NO	NO	1.2m
2	RJ45 Cable	NO	NO	10m

### 3. AC POWER LINE CONDUCTED EMISSIONS TEST

#### 3.1 LIMIT

Frequency of Emission (MHz)	Limit (dB $\mu$ V)	
	Quasi-peak	Average
0.15 - 0.50	66 to 56*	56 to 46*
0.50 - 5.0	56	46
5.0 - 30.0	60	50

**NOTE:**

- (1) The tighter limit applies at the band edges.
- (2) The limit of " \* " marked band means the limitation decreases linearly with the logarithm of the frequency in the range.

The following table is the setting of the receiver

Receiver Parameters	Setting
Attenuation	10 dB
Start Frequency	0.15 MHz
Stop Frequency	30 MHz
IF Bandwidth	9 kHz

#### 3.2 TEST PROCEDURE

- a. The EUT was placed 0.8 meters from the horizontal ground plane with EUT being connected to the power mains through a line impedance stabilization network (LISN). All other support equipment powered from additional LISN(s). The LISN provide 50 Ohm/ 50uH of coupling impedance for the measuring instrument.
- b. Interconnecting cables that hang closer than 40 cm to the ground plane shall be folded back and forth in the center forming a bundle 30 to 40 cm long.
- c. I/O cables that are not connected to a peripheral shall be bundled in the center. The end of the cable may be terminated, if required, using the correct terminating impedance. The overall length shall not exceed 1 m.
- d. LISN at least 80 cm from nearest part of EUT chassis.
- e. For the actual test configuration, please refer to the related Item -EUT Test Photos.

#### 3.3 DEVIATION FROM TEST STANDARD

No deviation



### 3.4 TEST SETUP

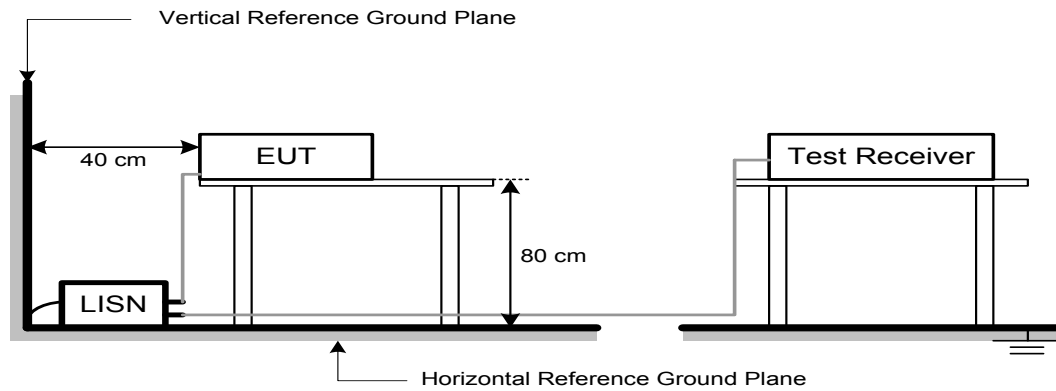

### 3.5 EUT OPERATION CONDITIONS

EUT was programmed to be in continuously transmitting mode.

### 3.6 TEST RESULTS

Please refer to the APPENDIX A.

#### 4. RADIATED EMISSIONS TEST

##### 4.1 LIMIT

In case the emission fall within the restricted band specified on 15.205(a), then the 15.209(a) limit in the table below has to be followed.

##### LIMITS OF RADIATED EMISSION MEASUREMENT (9 kHz-1000 MHz)

Frequency (MHz)	Field Strength (microvolts/meter)	Measurement Distance (meters)
0.009-0.490	2400/F(kHz)	300
0.490-1.705	24000/F(kHz)	30
1.705-30.0	30	30
30-88	100	3
88-216	150	3
216-960	200	3
Above 960	500	3

##### LIMITS OF RADIATED EMISSION MEASUREMENT (Above 1000 MHz)

Frequency (MHz)	(dBuV/m at 3 m)	
	Peak	Average
Above 1000	74	54

##### NOTE:

- (1) The limit for radiated test was performed according to FCC PART 15C.
- (2) The tighter limit applies at the band edges.
- (3) Emission level (dBuV/m)=20log Emission level (uV/m).
- (4) The test result calculated as following:  
 Measurement Value = Reading Level + Correct Factor  
 Correct Factor = Antenna Factor + Cable Loss - Amplifier Gain(if use)  
 Margin Level = Measurement Value - Limit Value

Spectrum Parameter	Setting
Attenuation	Auto
Start Frequency	1000 MHz
Stop Frequency	10th carrier harmonic
RBW / VBW (Emission in restricted band)	1 MHz / 3 MHz for Peak, 1 MHz / 1/T for Average

Receiver Parameter	Setting
Attenuation	Auto
Start ~ Stop Frequency	9 kHz~90 kHz for PK/AVG detector
Start ~ Stop Frequency	90 kHz~110 kHz for QP detector
Start ~ Stop Frequency	110 kHz~490 kHz for PK/AVG detector
Start ~ Stop Frequency	490 kHz~30 MHz for QP detector
Start ~ Stop Frequency	30 MHz~1000 MHz for QP detector

#### 4.2 TEST PROCEDURE

- a. The measuring distance of 3 m shall be used for measurements. The EUT was placed on the top of a rotating table 0.8 meter above the ground at a 3 meter semi-anechoic chamber. The table was rotated 360 degrees to determine the position of the highest radiation.(below 1 GHz)
- b. The measuring distance of 3 m shall be used for measurements. The EUT was placed on the top of a rotating table 1.5 meter above the ground at a 3 meter semi-anechoic chamber. The table was rotated 360 degrees to determine the position of the highest radiation.(above 1 GHz)
- c. The height of the equipment or of the substitution antenna shall be 0.8m or 1.5m; the height of the test antenna shall vary between 1 m to 4 m. Both horizontal and vertical polarizations of the antenna are set to make the measurement.
- d. For each suspected emission, the EUT was arranged to its worst case and then the antenna was tuned to heights find the maximum reading (used Bore sight function).
- e. The receiver system was set to peak and average detect function and specified bandwidth with maximum hold mode when the test frequency is above 1 GHz.
- f. The initial step in collecting radiated emission data is a receiver peak detector mode pre-scanning the measurement frequency range. Significant peaks are then marked and then Quasi Peak detector mode re-measured.
- g. All readings are Peak unless otherwise stated QP in column of Note. Peak denotes that the Peak reading compliance with the QP Limits and then QP Mode measurement didn't perform. (below 1 GHz)
- h. All readings are Peak Mode value unless otherwise stated AVG in column of Note. If the Peak Mode Measured value compliance with the Peak Limits and lower than AVG Limits, the EUT shall be deemed to meet both Peak & AVG Limits and then only Peak Mode was measured, but AVG Mode didn't perform. (above 1 GHz)
- i. For the actual test configuration, please refer to the related Item -EUT Test Photos.

#### 4.3 DEVIATION FROM TEST STANDARD

No deviation

## 4.4 TEST SETUP

9 kHz-30 MHz

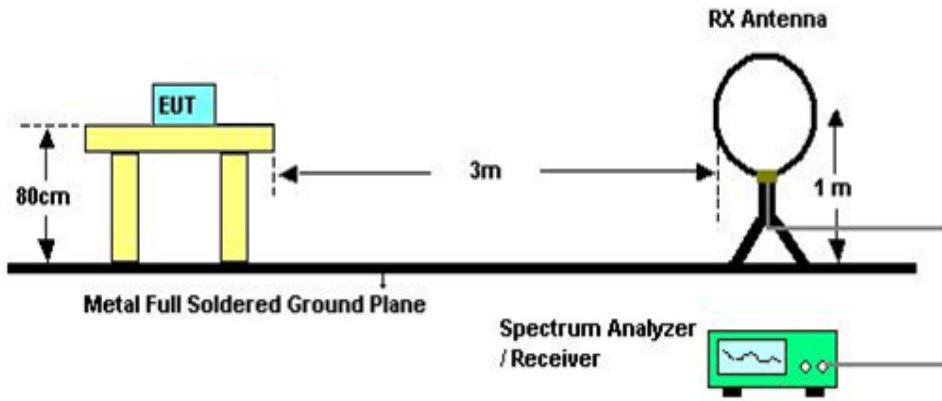

30 MHz to 1 GHz

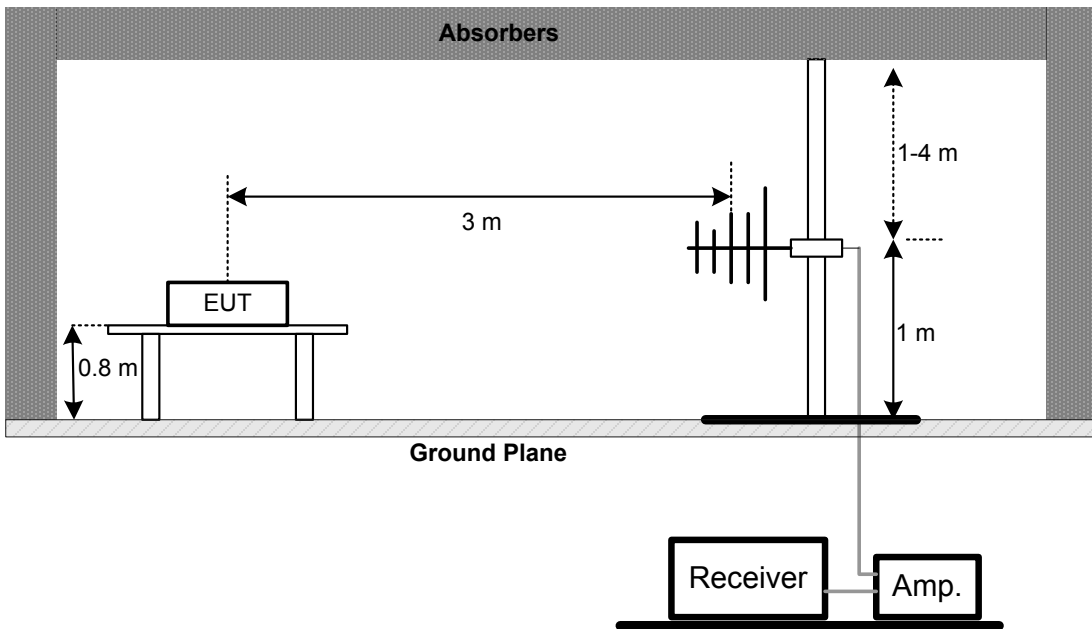

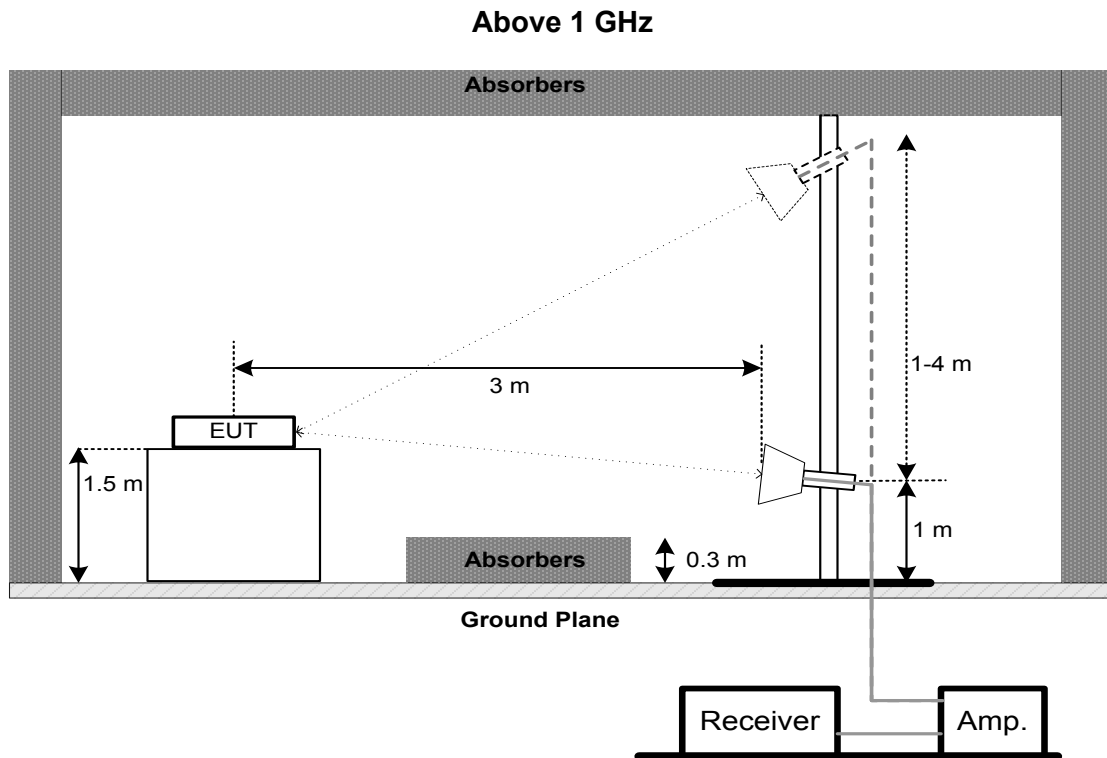

#### 4.5 EUT OPERATION CONDITIONS

The EUT was programmed to be in continuously transmitting mode.

#### 4.6 TEST RESULTS - 9 KHZ TO 30 MHZ

Please refer to the APPENDIX B

Remark:

- (1) Distance extrapolation factor =  $40 \log(\text{specific distance} / \text{test distance})$  (dB).
- (2) Limit line = specific limits (dBuV) + distance extrapolation factor.

#### 4.7 TEST RESULTS - 30 MHZ TO 1000 MHZ

Please refer to the APPENDIX C.

#### 4.8 TEST RESULTS - ABOVE 1000 MHZ

Please refer to the APPENDIX D.

Remark:

- (1) No limit: This is fundamental signal, the judgment is not applicable.  
For fundamental signal judgment was referred to Peak output test.

**5. BANDWIDTH TEST**

**5.1 LIMIT**

FCC Part15, Subpart C (15.247)		
Section	Test Item	Limit
15.247(a)(2)	6 dB Bandwidth	Minimum 500 kHz
	99% Emission Bandwidth	-

**5.2 TEST PROCEDURE**

- a. The EUT was directly connected to the spectrum analyzer and antenna output port as show in the block diagram below.
- b. For 6dB Bandwidth Spectrum setting: RBW= 100KHz, VBW=300KHz, Sweep time = 2.5 ms.  
For 99% OBW Spectrum Setting: For B,G,N20 mode: RBW= 300KHz, VBW=1MHz, For N40 mode: RBW= 1MHz, VBW=3MHz, Sweep time = 2.5 ms.
- c. The bandwidth was performed in accordance with method 11.8.1 of ANSI C63.10-2013.

**5.3 DEVIATION FROM STANDARD**

No deviation.

**5.4 TEST SETUP**



**5.5 EUT OPERATION CONDITIONS**

The EUT was programmed to be in continuously transmitting mode.

**5.6 TEST RESULTS**

Please refer to the APPENDIX E.

## 6. MAXIMUM AVERAGE OUTPUT POWER TEST

### 6.1 LIMIT

FCC Part15, Subpart C (15.247)		
Section	Test Item	Limit
15.247(b)(3)	Maximum Average Output Power	1 Watt or 30dBm

### 6.2 TEST PROCEDURE

- The EUT was directly connected to the power meter and antenna output port as show in the block diagram below.
- The maximum conducted output power was performed in accordance with method 11.9.2.3.1 of ANSI C63.10-2013 and FCC KDB 662911 D01 v02r01 Multiple Transmitter Output.

### 6.3 DEVIATION FROM STANDARD

No deviation.

### 6.4 TEST SETUP

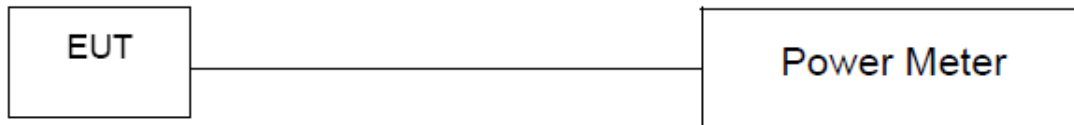

### 6.5 EUT OPERATION CONDITIONS

The EUT was programmed to be in continuously transmitting mode.

### 6.6 TEST RESULTS

Please refer to the APPENDIX F.

## 7. CONDUCTED SPURIOUS EMISSIONS

### 7.1 LIMIT

In any 100 kHz bandwidth outside the frequency band in which the spread spectrum or digitally modulated intentional radiator is operating, the radio frequency power that is produced by the intentional radiator shall be at least 20 dB below that in the 100 kHz bandwidth within the band that contains the highest level of the desired power, based on either an RF conducted or a radiated measurement, provided the transmitter demonstrates compliance with the peak Output Power limits. If the transmitter complies with the Output Power limits based on the use of RMS averaging over a time interval, as permitted under paragraph (b)(3) of this section, the attenuation required under this paragraph shall be 30 dB instead of 20 dB. Attenuation below the general limits specified in Section 15.209(a) is not required.

### 7.2 TEST PROCEDURE

- a. The EUT was directly connected to the spectrum analyzer and antenna output port as show in the block diagram below.
- b. Spectrum Setting: RBW= 100 kHz, VBW=300 kHz, Sweep time = Auto.

### 7.3 DEVIATION FROM STANDARD

No deviation.

### 7.4 TEST SETUP

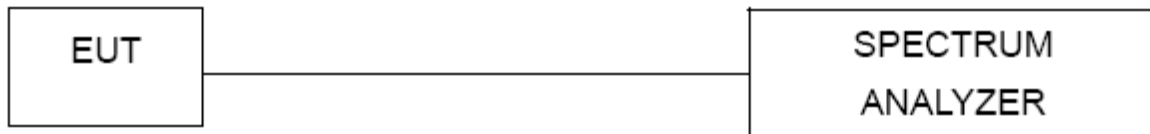

### 7.5 EUT OPERATION CONDITIONS

The EUT was programmed to be in continuously transmitting mode.

### 7.6 TEST RESULTS

Please refer to the APPENDIX G.



## 8. POWER SPECTRAL DENSITY TEST

### 8.1 LIMIT

FCC Part15, Subpart C (15.247)		
Section	Test Item	Limit
15.247(e)	Power Spectral Density	8 dBm (in any 3 kHz)

### 8.2 TEST PROCEDURE

- The EUT was directly connected to the spectrum analyzer and antenna output port as show in the block diagram below.
- Spectrum Setting: RBW=3 kHz, VBW=10 kHz, Sweep time = Auto.
- The Power Spectral Density was performed in accordance with method 11.10.2 of ANSI C63.10-2013.

### 8.3 DEVIATION FROM STANDARD

No deviation.

### 8.4 TEST SETUP



### 8.5 EUT OPERATION CONDITIONS

The EUT was programmed to be in continuously transmitting mode.

### 8.6 TEST RESULTS

Please refer to the APPENDIX H.

**9. MEASUREMENT INSTRUMENTS LIST**

AC Power Line Conducted Emissions					
Item	Kind of Equipment	Manufacturer	Type No.	Serial No.	Calibrated until
1	EMI Test Receiver	R&S	ESCI	100382	Mar. 10, 2020
2	LISN	EMCO	3816/2	52765	Mar. 10, 2020
3	TWO-LINE V-NETWORK	R&S	ENV216	101447	May. 19, 2020
4	50Ω Terminator	SHX	TF5-3	15041305	Mar. 10, 2020
5	Measurement Software	Farad	EZ-EMC Ver.NB-03A1-01	N/A	N/A
6	Cable	N/A	RG223	12m	Mar. 12, 2020

Radiated Emissions - 9 kHz to 30 MHz					
Item	Kind of Equipment	Manufacturer	Type No.	Serial No.	Calibrated until
1	Loop Antenna	EM	EM-6876-1	230	Jan. 15, 2020
2	Cable	N/A	RG 213/U	C-102	May 31, 2020
3	EMI Test Receiver	R&S	ESCI	100895	Mar. 10, 2020
4	Measurement Software	Farad	EZ-EMC Ver.NB-03A1-01	N/A	N/A

Radiated Emissions - 30 MHz to 1 GHz					
Item	Kind of Equipment	Manufacturer	Type No.	Serial No.	Calibrated until
1	Antenna	Schwarzbeck	VULB9160	9160-3232	Mar. 09, 2020
2*	Amplifier*	HP	8447D	2944A09673	Aug. 11, 2021
3	Receiver	Agilent	N9038A	MY52130039	Aug. 03, 2020
4	Cable	emci	LMR-400(30MHz- 1GHz)(8m+5m)	N/A	May 24, 2020
5	Controller	CT	SC100	N/A	N/A
6	Controller	MF	MF-7802	MF780208416	N/A
7	Measurement Software	Farad	EZ-EMC Ver.NB-03A1-01	N/A	N/A

Radiated Emissions - Above 1 GHz					
Item	Kind of Equipment	Manufacturer	Type No.	Serial No.	Calibrated until
1	Double Ridged Guide Antenna	ETS	3115	75789	Mar. 09, 2020
2	Broad-Band Horn Antenna	Schwarzbeck	BBHA 9170	9170319	Jun. 23, 2020
3	Amplifier	Agilent	8449B	3008A02333	Mar. 10, 2020
4	Microwave Preamplifier With Adaptor	EMC INSTRUMENT	EMC2654045	980039 & HA01	Mar. 10, 2020
5	Receiver	Agilent	N9038A	MY52130039	Aug. 03, 2020
6	Controller	CT	SC100	N/A	N/A
7	Controller	MF	MF-7802	MF780208416	N/A
8	Cable	mitron	B10-01-01-12M	18072744	Jun. 29, 2020
9	Measurement Software	Farad	EZ-EMC Ver.NB-03A1-01	N/A	N/A

**Bandwidth &  
Antenna Conducted Spurious Emissions &  
Power Spectral Density**

Item	Kind of Equipment	Manufacturer	Type No.	Serial No.	Calibrated until
1	Spectrum Analyzer	R&S	FSP40	100185	Aug. 03, 2020

**Maximum Output Power**

Item	Kind of Equipment	Manufacturer	Type No.	Serial No.	Calibrated until
1	Peak Power Analyzer	Keysight	8990B	MY51000506	Aug. 03, 2020
2	Wideband power sensor	Keysight	N1923A	MY58310004	Aug. 03, 2020

Remark: "N/A" denotes no model name, serial no. or calibration specified.  
 "\*" calibration period of equipment list is three year.  
 Except \* item, all calibration period of equipment list is one year.

**10. EUT TEST PHOTO****Conducted Measurement Photos**

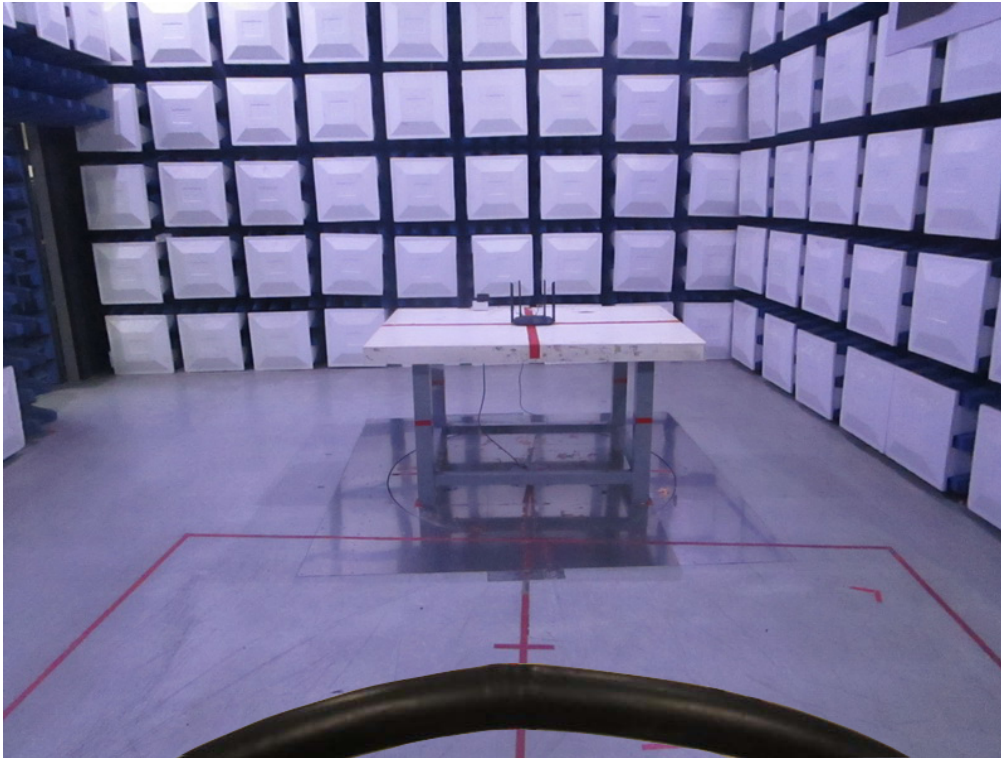
**Radiated Emissions Test Photos****9 kHz to 30 MHz**



**Radiated Emissions Test Photos**

**30 MHz to 1 GHz**

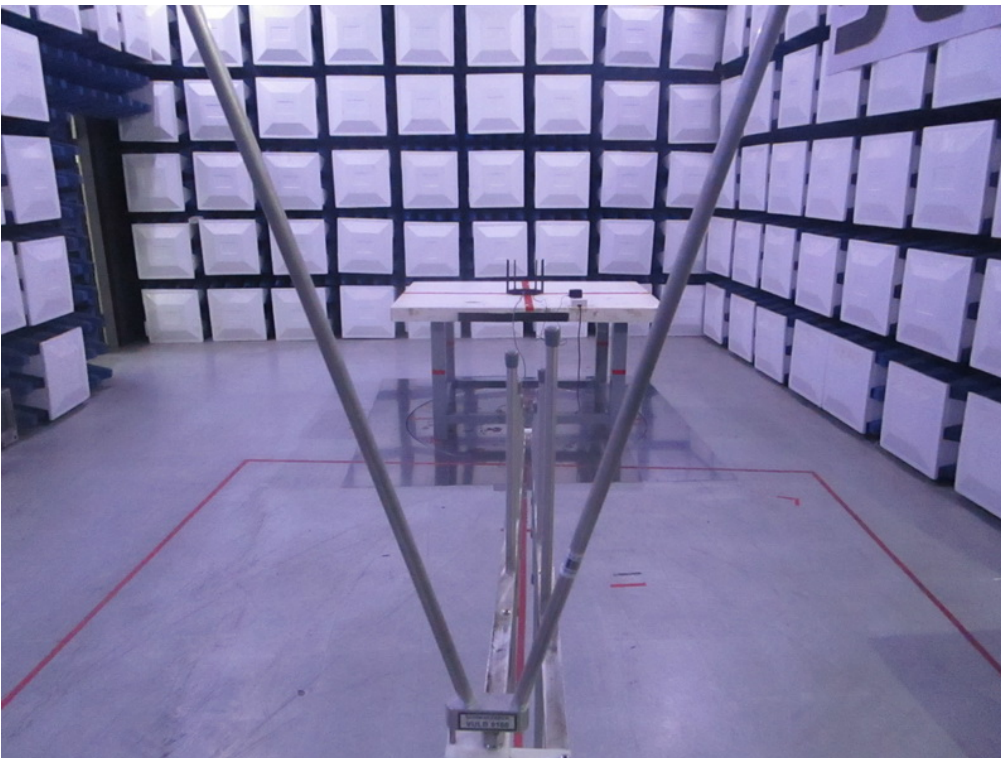
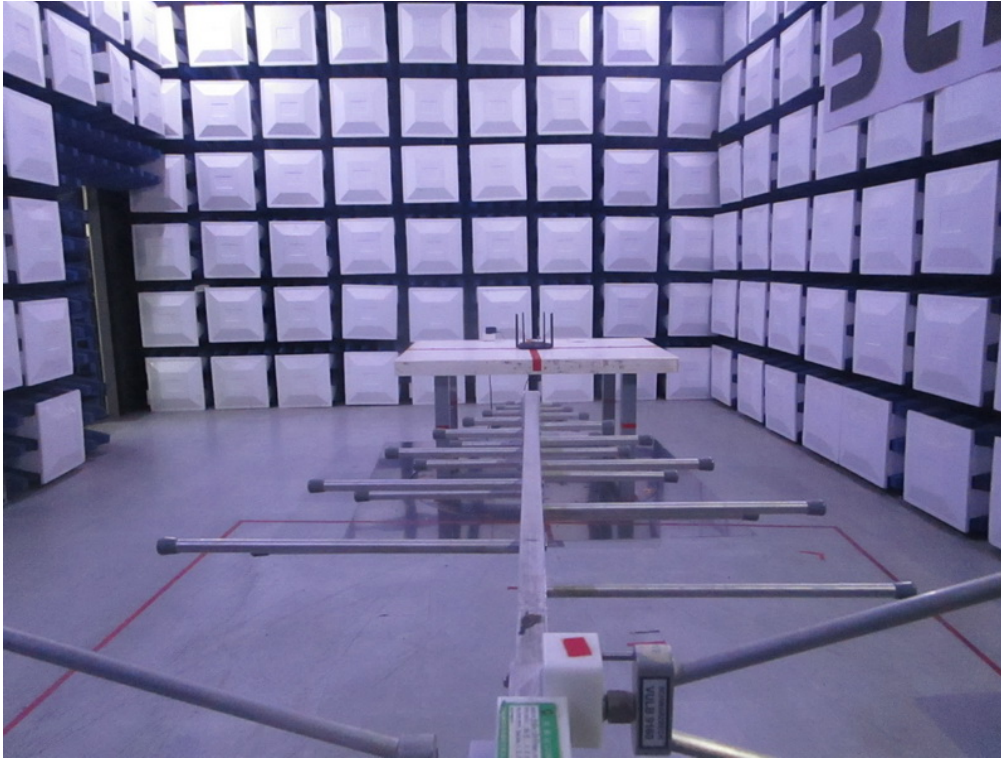

**Radiated Emissions Test Photos**

**Above 1 GHz**

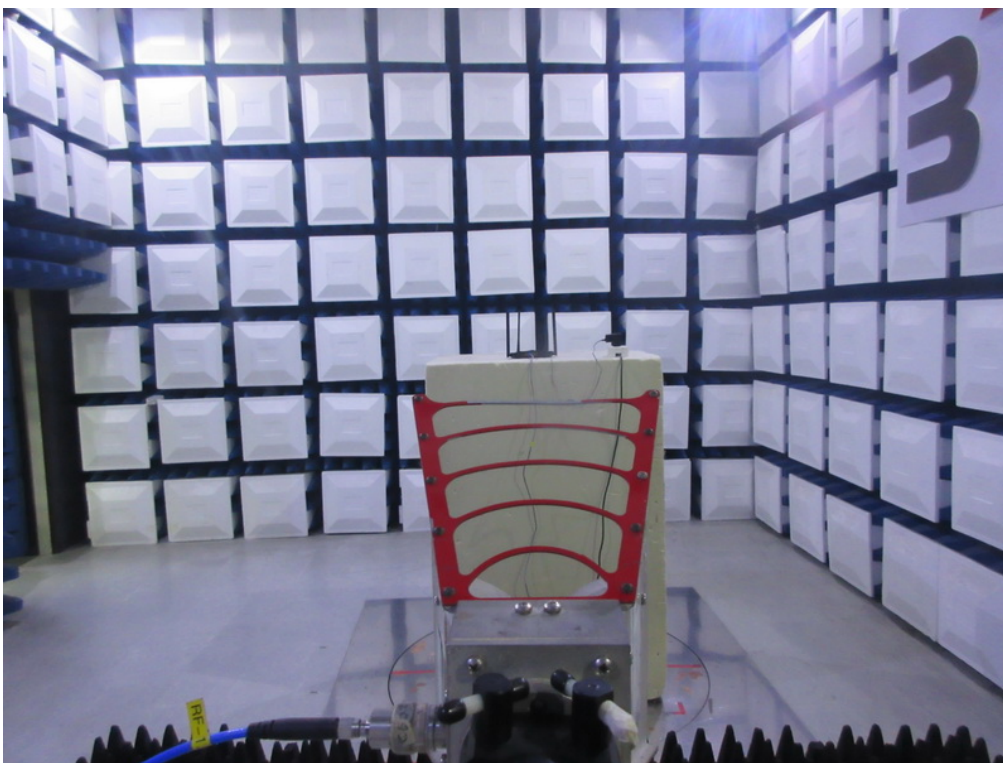
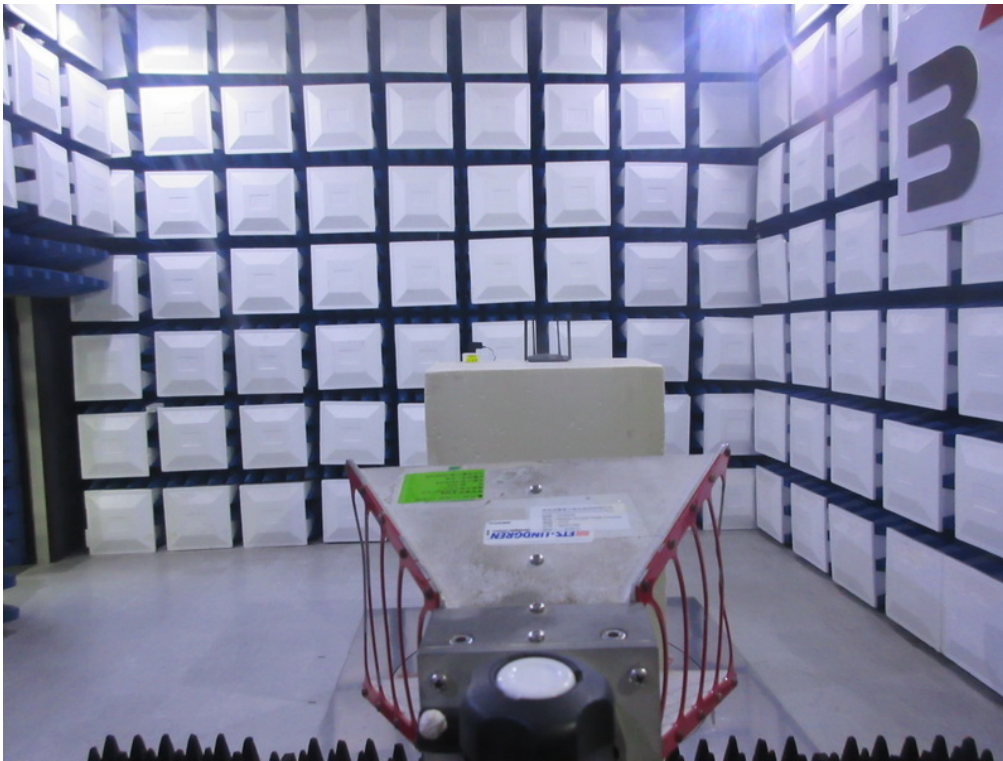

## **APPENDIX A - AC POWER LINE CONDUCTED EMISSIONS**



Test Mode : TX N-20 MHz Mode Channel 01

### Line

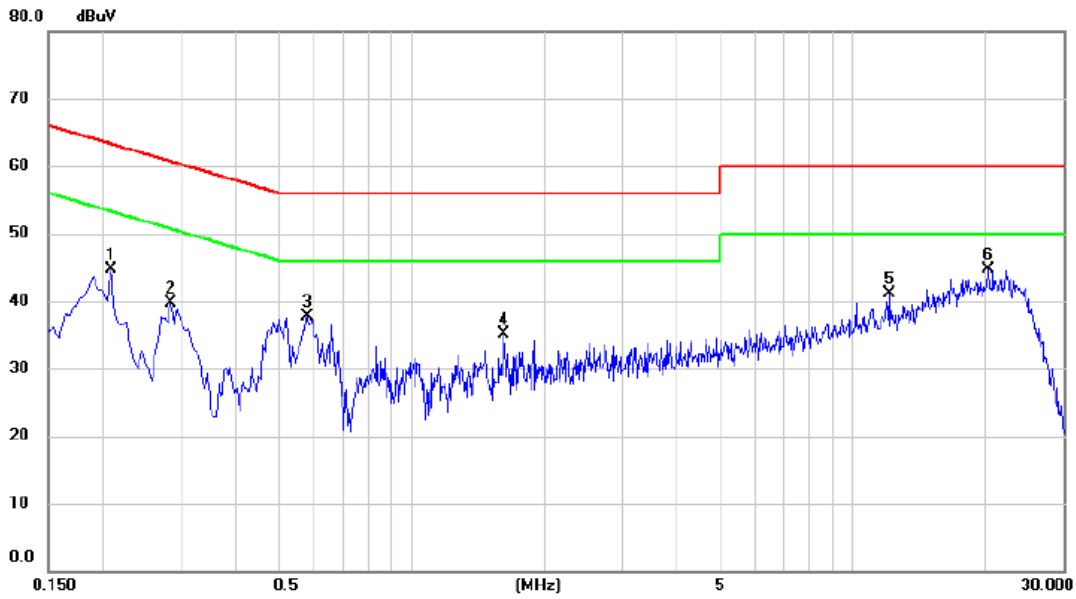

No.	Mk.	Freq. MHz	Reading Level dBuV	Correct Factor dB	Measure- ment dBuV	Limit dBuV	Margin dB	Detector	Comment
1		0.2085	34.95	9.81	44.76	63.26	-18.50	peak	
2		0.2850	29.82	9.84	39.66	60.67	-21.01	peak	
3		0.5820	27.73	9.89	37.62	56.00	-18.38	peak	
4		1.6215	25.14	9.96	35.10	56.00	-20.90	peak	
5		12.0615	30.49	10.60	41.09	60.00	-18.91	peak	
6	*	20.2110	33.58	11.18	44.76	60.00	-15.24	peak	

Test Mode : TX N-20 MHz Mode Channel 01

### Neutral

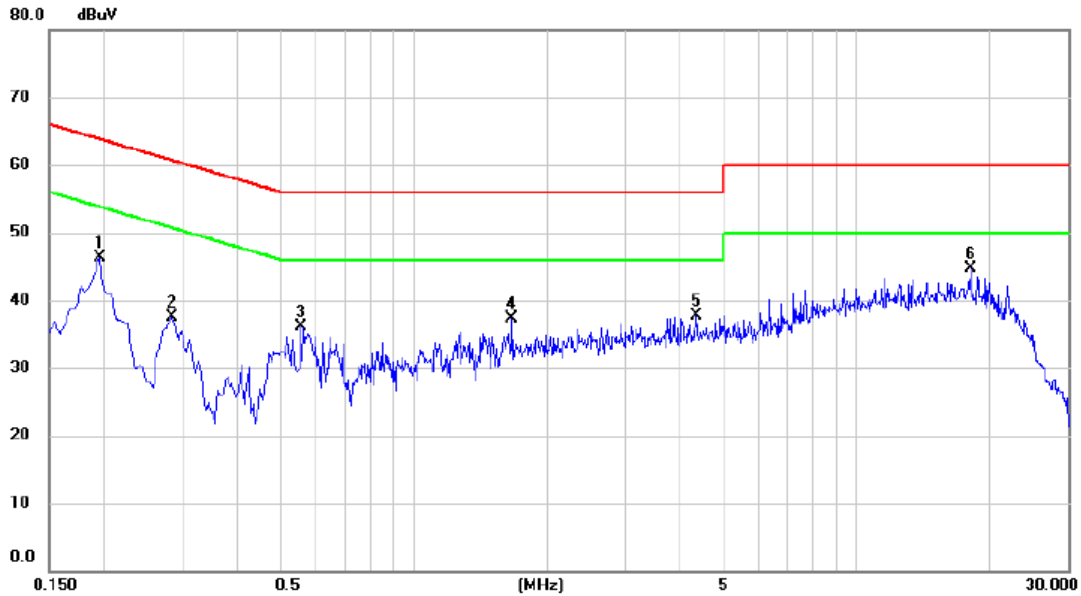

No.	Mk.	Freq. MHz	Reading Level dBuV	Correct Factor dB	Measure- ment dBuV	Limit dBuV	Margin dB	Detector	Comment
1		0.1950	36.31	9.90	46.21	63.82	-17.61	peak	
2		0.2850	27.49	9.94	37.43	60.67	-23.24	peak	
3		0.5550	26.04	10.04	36.08	56.00	-19.92	peak	
4		1.6665	27.05	10.17	37.22	56.00	-18.78	peak	
5		4.3395	27.36	10.34	37.70	56.00	-18.30	peak	
6	*	18.0600	33.31	11.33	44.64	60.00	-15.36	peak	

## **APPENDIX B - RADIATED EMISSION - 9 KHZ TO 30 MHZ**

Test Mode: TX N-20 MHz Mode Channel 01

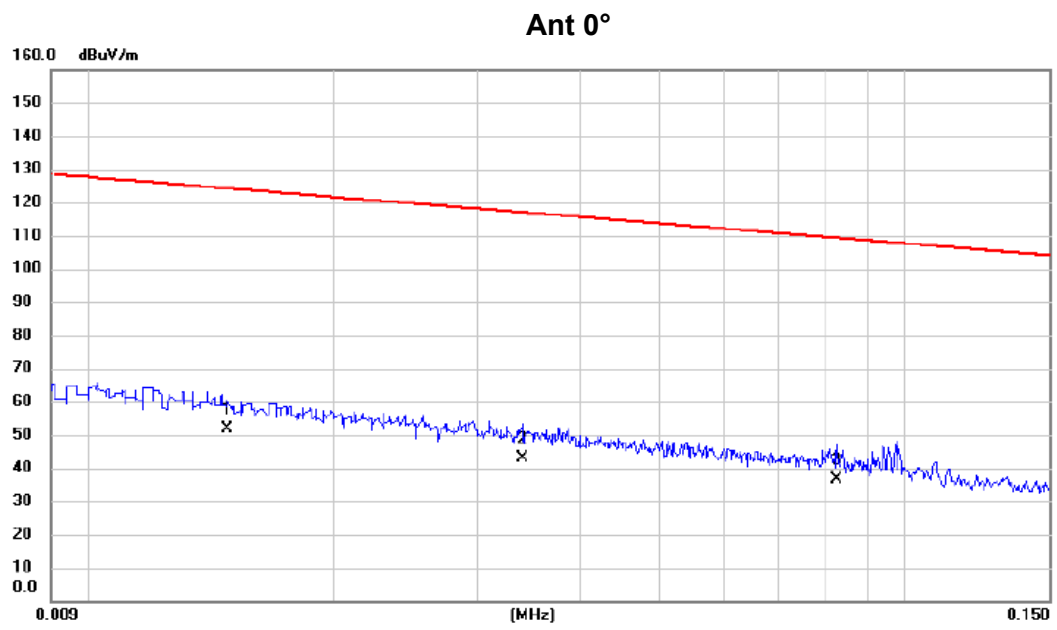

No.	Mk.	Freq. MHz	Reading Level dBuV	Correct Factor dB	Measure- ment dBuV/m	Limit dBuV/m	Margin dB	Detector	Comment
1	*	0.0148	36.30	15.38	51.68	124.20	-72.52	AVG	
2		0.0340	29.31	13.88	43.19	116.98	-73.79	AVG	
3		0.0826	22.97	13.54	36.51	109.27	-72.76	AVG	

REMARKS:  
 (1) Measurement Value = Reading Level + Correct Factor.  
 (2) Margin Level = Measurement Value - Limit Value.

Test Mode: TX N-20 MHz Mode Channel 01

Ant 0°

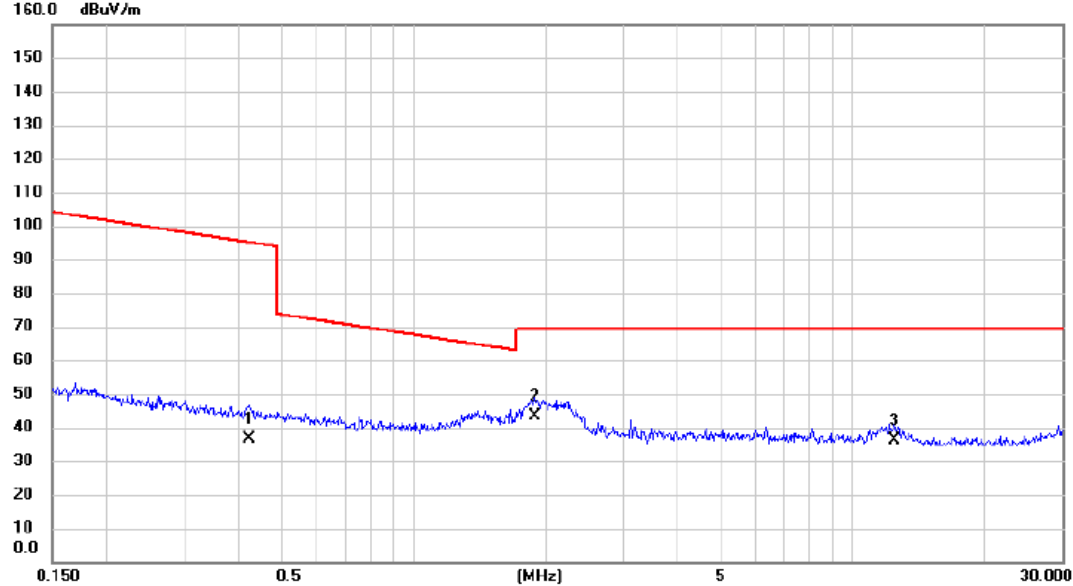

No.	Mk.	Freq. MHz	Reading Level dBuV	Correct Factor dB	Measure- ment dBuV/m	Limit dBuV/m	Margin dB	Detector	Comment
1		0.4237	23.34	13.24	36.58	95.06	-58.48	AVG	
2	*	1.8880	31.67	11.89	43.56	69.54	-25.98	QP	
3		12.4494	24.68	11.60	36.28	69.54	-33.26	QP	

REMARKS:

- (1) Measurement Value = Reading Level + Correct Factor.
- (2) Margin Level = Measurement Value - Limit Value.

Test Mode: TX N-20 MHz Mode Channel 01

**Ant 90°**

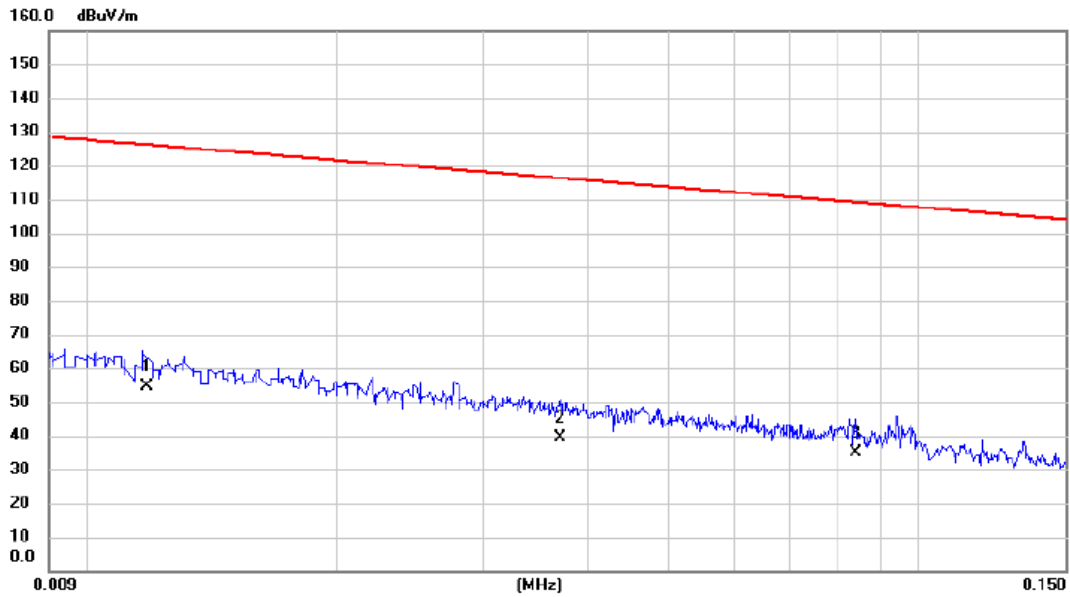

No.	Mk.	Freq. MHz	Reading Level dBuV	Correct Factor dB	Measure- ment dBuV/m	Limit dBuV/m	Margin dB	Detector	Comment
1	*	0.0118	38.36	16.28	54.64	126.17	-71.53	AVG	
2		0.0371	25.61	13.89	39.50	116.22	-76.72	AVG	
3		0.0840	21.53	13.54	35.07	109.12	-74.05	AVG	

**REMARKS:**

- (1) Measurement Value = Reading Level + Correct Factor.
- (2) Margin Level = Measurement Value - Limit Value.

Test Mode: TX N-20 MHz Mode Channel 01

**Ant 90°**

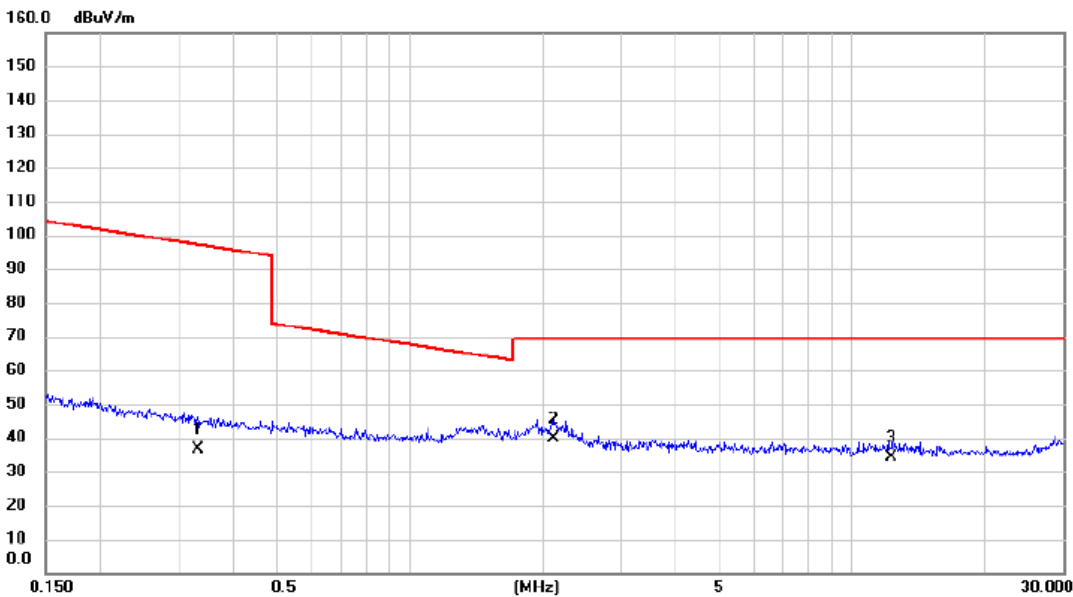

No.	Mk.	Freq. MHz	Reading Level dBuV	Correct Factor dB	Measure- ment dBuV/m	Limit dBuV/m	Margin dB	Detector	Comment
1		0.3320	23.13	13.46	36.59	97.18	-60.59	AVG	
2	*	2.1101	27.94	11.75	39.69	69.54	-29.85	QP	
3		12.3182	22.43	11.60	34.03	69.54	-35.51	QP	

REMARKS:  
 (1) Measurement Value = Reading Level + Correct Factor.  
 (2) Margin Level = Measurement Value - Limit Value.

## **APPENDIX C - RADIATED EMISSION - 30 MHZ TO 1000 MHZ**



Test Mode: TX N-20 MHz Mode Channel 01

### Vertical

80 dBuV/m

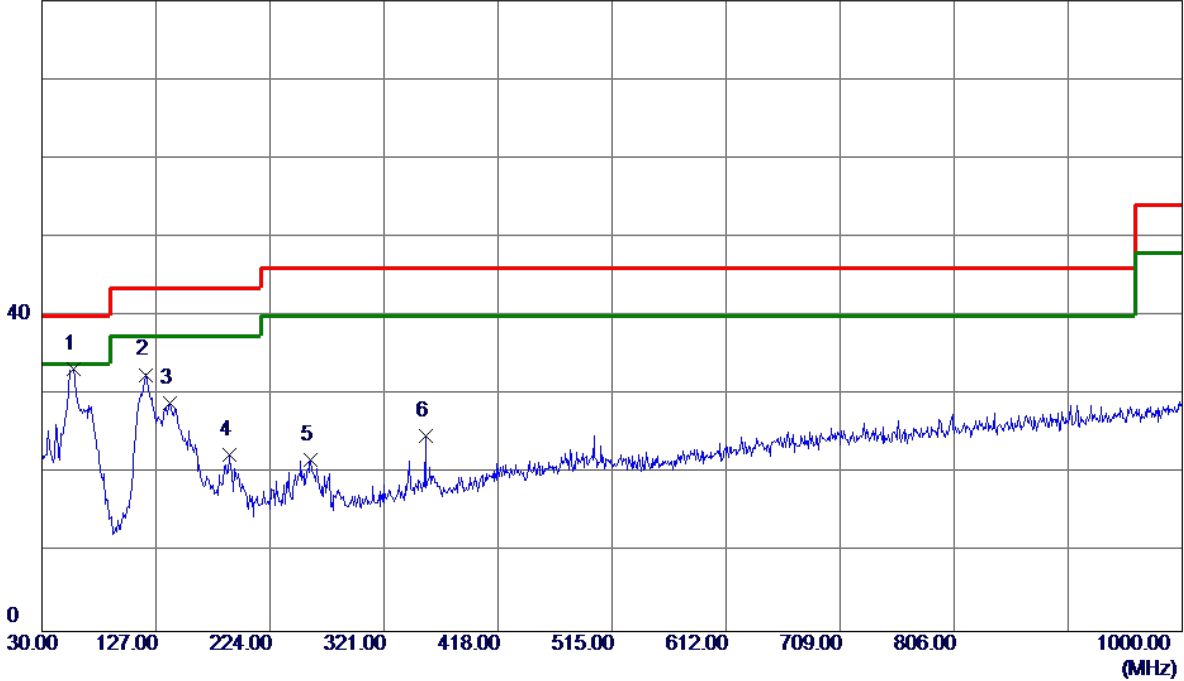

No.	Freq. MHz	Reading Level dBuV/m	Correct Factor dB	Measure ment dBuV/m	Limit dBuV/m	Margin dB	Detector	Comment
1 *	56.6750	47.53	-14.27	33.26	40.00	-6.74	Peak	
2	118.2700	45.85	-13.29	32.56	43.50	-10.94	Peak	
3	139.1250	41.78	-12.89	28.89	43.50	-14.61	Peak	
4	189.0800	36.73	-14.34	22.39	43.50	-21.11	Peak	
5	258.9200	34.48	-12.77	21.71	46.00	-24.29	Peak	
6	356.4050	35.26	-10.51	24.75	46.00	-21.25	Peak	

**REMARKS:**

- (1) Measurement Value = Reading Level + Correct Factor.
- (2) Margin Level = Measurement Value - Limit Value.

Test Mode: TX N-20 MHz Mode Channel 01

### Horizontal

80 dBuV/m

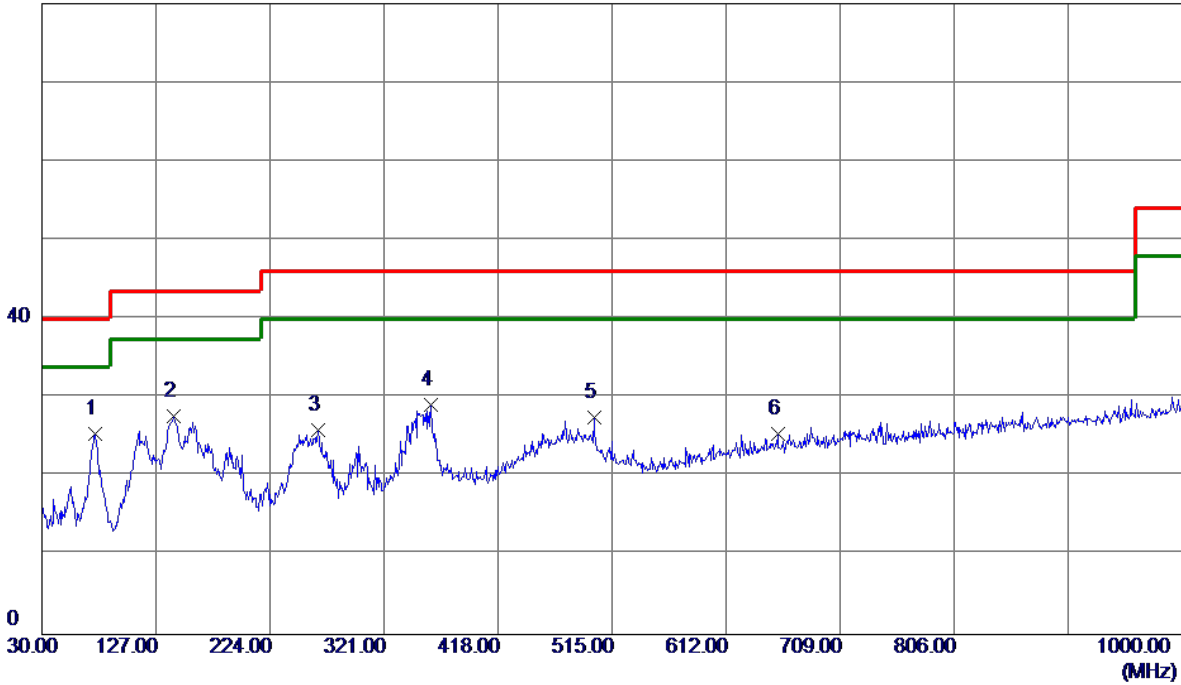

No.	Freq. MHz	Reading Level dBuV/m	Correct Factor dB	Measure ment dBuV/m	Limit dBuV/m	Margin dB	Detector	Comment
1 *	75.1050	42.68	-17.19	25.49	40.00	-14.51	Peak	
2	142.5200	40.40	-12.72	27.68	43.50	-15.82	Peak	
3	264.7400	38.71	-12.85	25.86	46.00	-20.14	Peak	
4	360.7700	39.53	-10.40	29.13	46.00	-16.87	Peak	
5	499.9650	35.25	-7.68	27.57	46.00	-18.43	Peak	
6	656.1350	29.98	-4.59	25.39	46.00	-20.61	Peak	

**REMARKS:**

- (1) Measurement Value = Reading Level + Correct Factor.
- (2) Margin Level = Measurement Value - Limit Value.

## **APPENDIX D - RADIATED EMISSION- ABOVE 1000 MHZ**

Test Mode: TX B Mode 2412 MHz

### Vertical

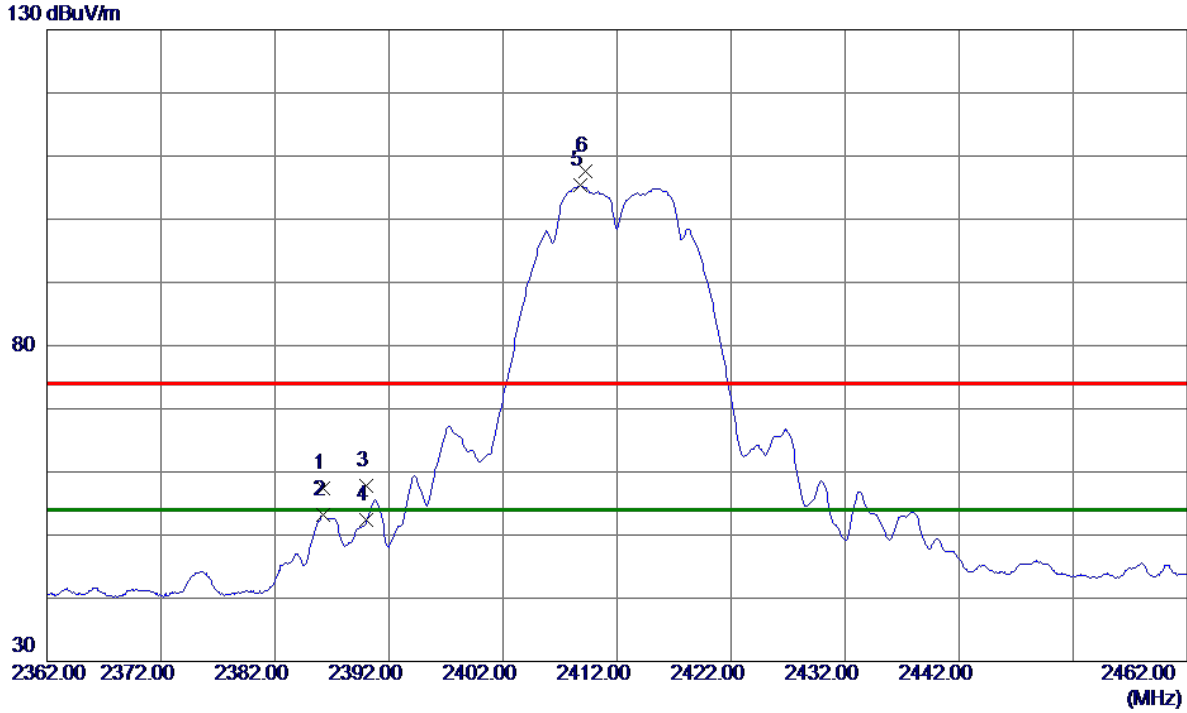

No.	Freq. MHz	Reading Level dBuV/m	Correct Factor dB	Measure ment dBuV/m	Limit dBuV/m	Margin dB	Detector	Comment
1	2386.2500	51.16	6.24	57.40	74.00	-16.60	Peak	
2	2386.2500	46.89	6.24	53.13	54.00	-0.87	AVG	
3	2390.0000	51.58	6.24	57.82	74.00	-16.18	Peak	
4	2390.0000	46.10	6.24	52.34	54.00	-1.66	AVG	
5 *	2408.8000	99.17	6.21	105.38	54.00	51.38	AVG	No Limit
6	2409.2000	101.32	6.20	107.52	74.00	33.52	Peak	No Limit

**REMARKS:**

(1) Measurement Value = Reading Level + Correct Factor.

(2) Margin Level = Measurement Value - Limit Value.

Test Mode: TX B Mode 2412 MHz

### Vertical

80 dBuV/m

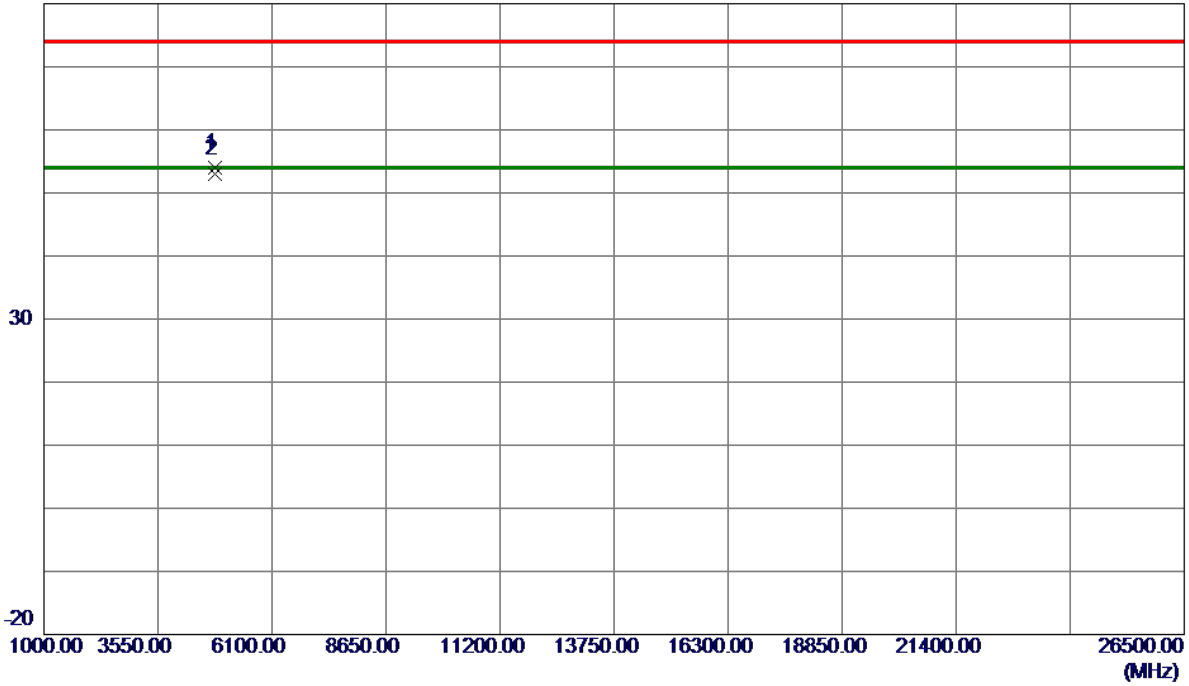

No.	Freq. MHz	Reading Level dBuV/m	Correct Factor dB	Measure ment dBuV/m	Limit dBuV/m	Margin dB	Detector	Comment
1	4824.0400	51.56	2.50	54.06	74.00	-19.94	Peak	
2 *	4824.0500	50.50	2.50	53.00	54.00	-1.00	AVG	

**REMARKS:**

- (1) Measurement Value = Reading Level + Correct Factor.
- (2) Margin Level = Measurement Value - Limit Value.

Test Mode: TX B Mode 2412 MHz

### Horizontal

130 dBuV/m

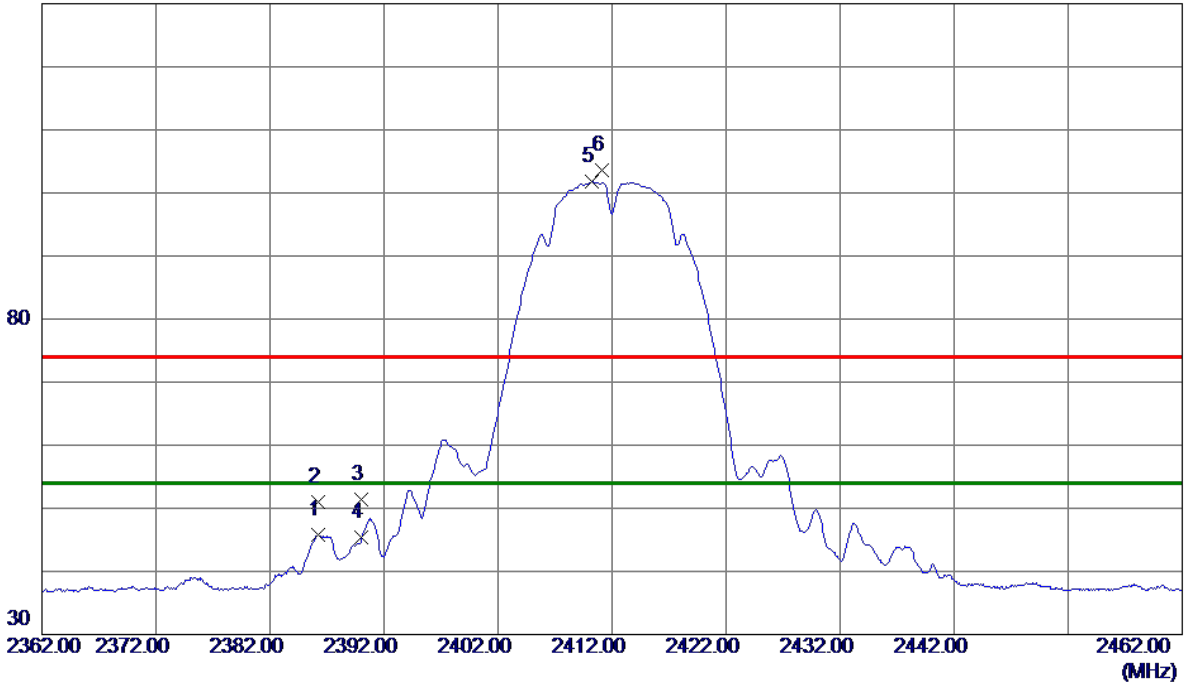

No.	Freq. MHz	Reading Level dBuV/m	Correct Factor dB	Measure ment dBuV/m	Limit dBuV/m	Margin dB	Detector	Comment
1	2386.2000	39.47	6.24	45.71	54.00	-8.29	AVG	
2	2386.2500	44.74	6.24	50.98	74.00	-23.02	Peak	
3	2390.0000	45.22	6.24	51.46	74.00	-22.54	Peak	
4	2390.0000	39.10	6.24	45.34	54.00	-8.66	AVG	
5 *	2410.2500	95.56	6.20	101.76	54.00	47.76	AVG	No Limit
6	2411.1500	97.44	6.20	103.64	74.00	29.64	Peak	No Limit

**REMARKS:**

- (1) Measurement Value = Reading Level + Correct Factor.
- (2) Margin Level = Measurement Value - Limit Value.

Test Mode: TX B Mode 2412 MHz

### Horizontal

80 dBuV/m

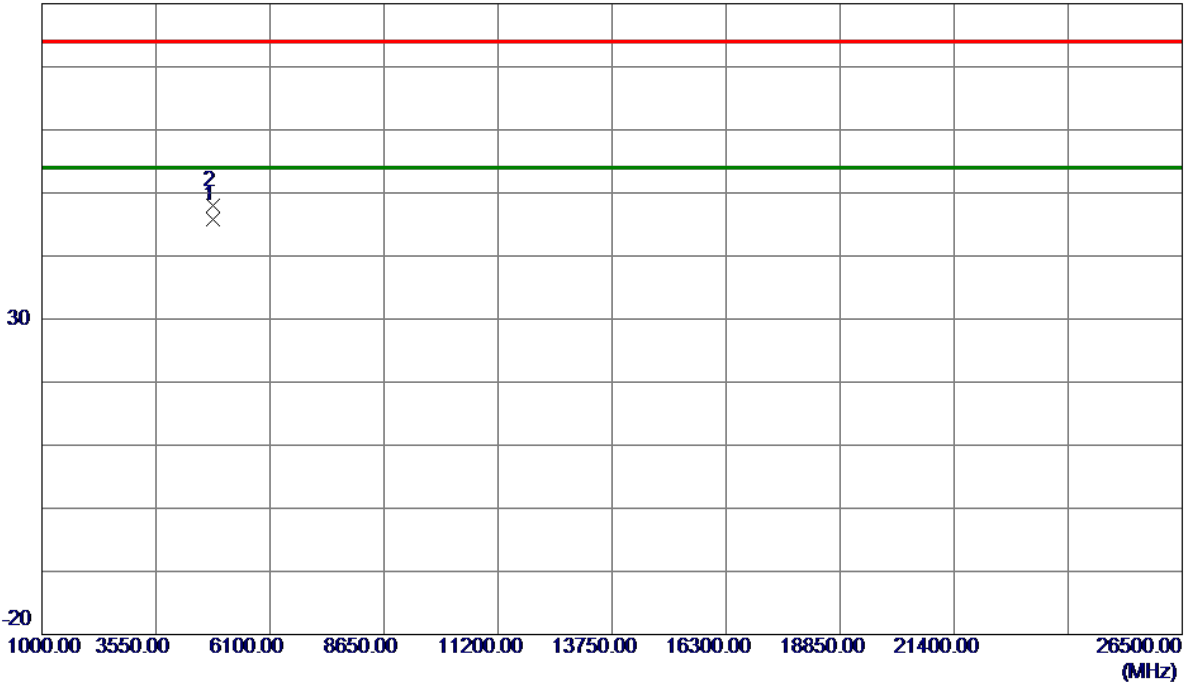

No.	Freq. MHz	Reading Level dBuV/m	Correct Factor dB	Measure ment dBuV/m	Limit dBuV/m	Margin dB	Detector	Comment
1 *	4824.0299	43.28	2.50	45.78	54.00	-8.22	AVG	
2	4824.0700	45.59	2.50	48.09	74.00	-25.91	Peak	

**REMARKS:**

- (1) Measurement Value = Reading Level + Correct Factor.
- (2) Margin Level = Measurement Value - Limit Value.

Test Mode: TX B Mode 2437 MHz

### Vertical

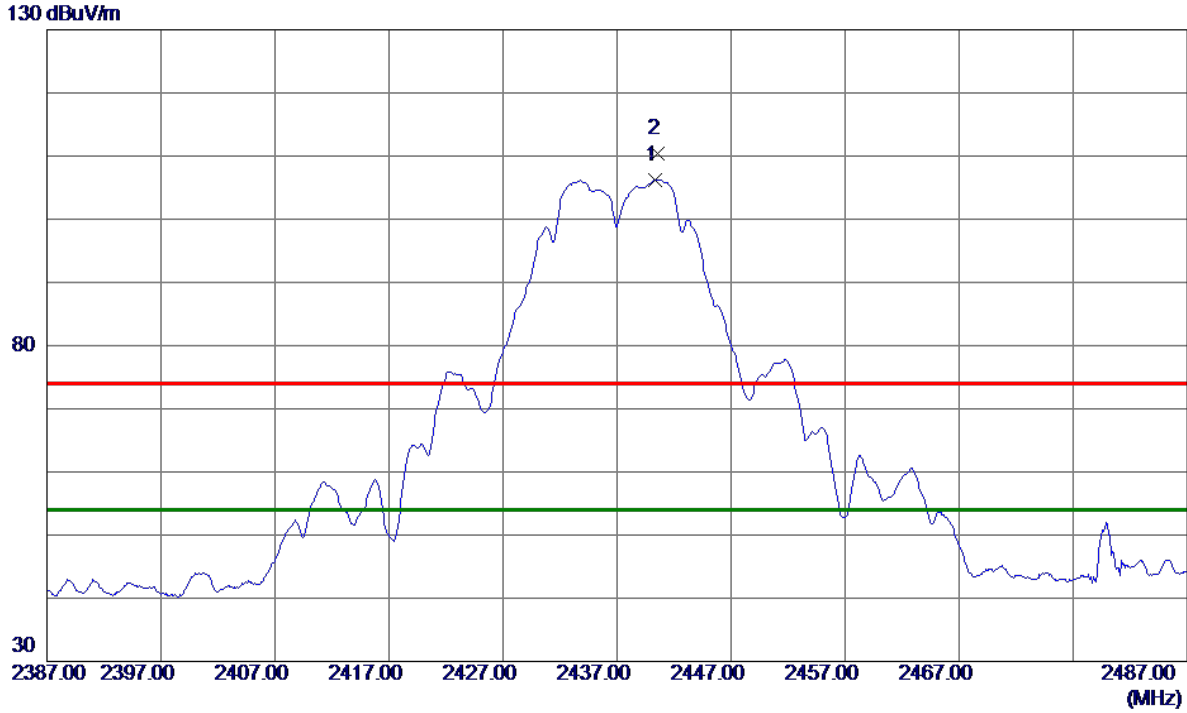

No.	Freq. MHz	Reading Level dBuV/m	Correct Factor dB	Measure ment dBuV/m	Limit dBuV/m	Margin dB	Detector	Comment
1 *	2440.3500	100.14	6.15	106.29	54.00	52.29	AVG	No Limit
2	2440.5500	104.28	6.15	110.43	74.00	36.43	Peak	No Limit

**REMARKS:**

(1) Measurement Value = Reading Level + Correct Factor.

(2) Margin Level = Measurement Value - Limit Value.



Test Mode: TX B Mode 2437 MHz

### Vertical



No.	Freq. MHz	Reading Level dBuV/m	Correct Factor dB	Measure ment dBuV/m	Limit dBuV/m	Margin dB	Detector	Comment
1	4873.9700	51.29	2.66	53.95	74.00	-20.05	Peak	
2 *	4874.0299	50.60	2.66	53.26	54.00	-0.74	AVG	

**REMARKS:**

- (1) Measurement Value = Reading Level + Correct Factor.
- (2) Margin Level = Measurement Value - Limit Value.

Test Mode: TX B Mode 2437 MHz

### Horizontal

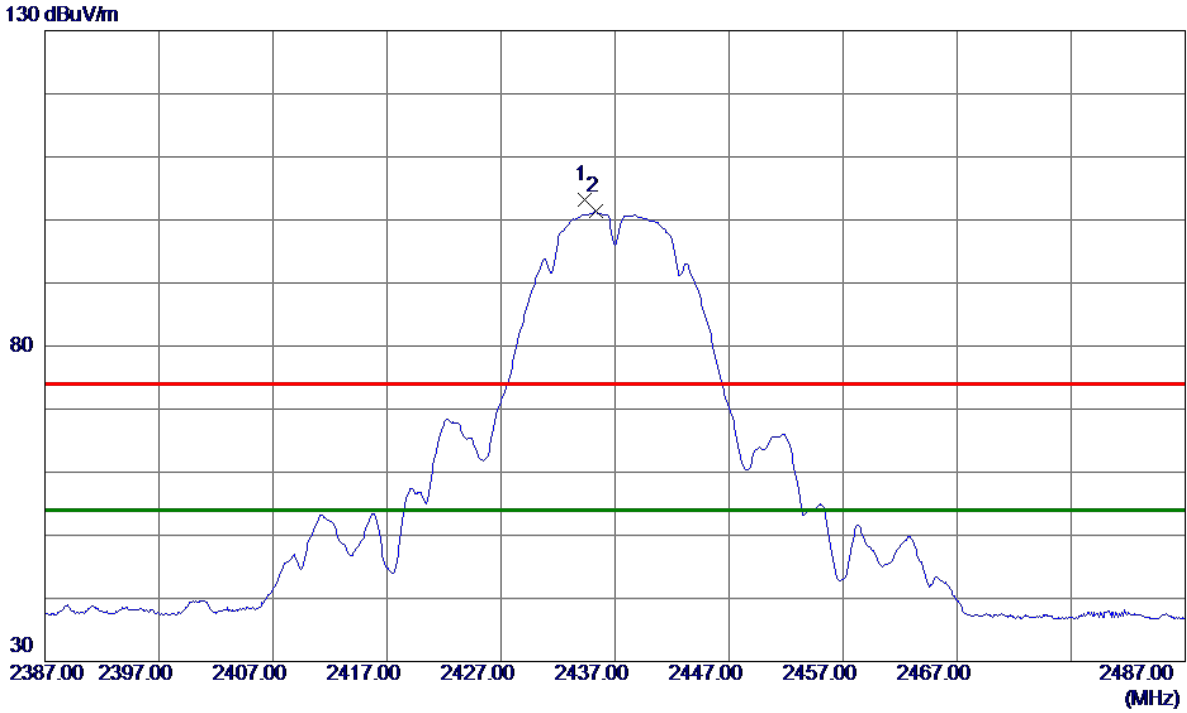

No.	Freq. MHz	Reading Level dBuV/m	Correct Factor dB	Measure ment dBuV/m	Limit dBuV/m	Margin dB	Detector	Comment
1	2434.3000	97.00	6.16	103.16	74.00	29.16	Peak	No Limit
2 *	2435.3000	95.19	6.16	101.35	54.00	47.35	AVG	No Limit

**REMARKS:**

- (1) Measurement Value = Reading Level + Correct Factor.
- (2) Margin Level = Measurement Value - Limit Value.

Test Mode: TX B Mode 2437 MHz

### Horizontal

80 dBuV/m

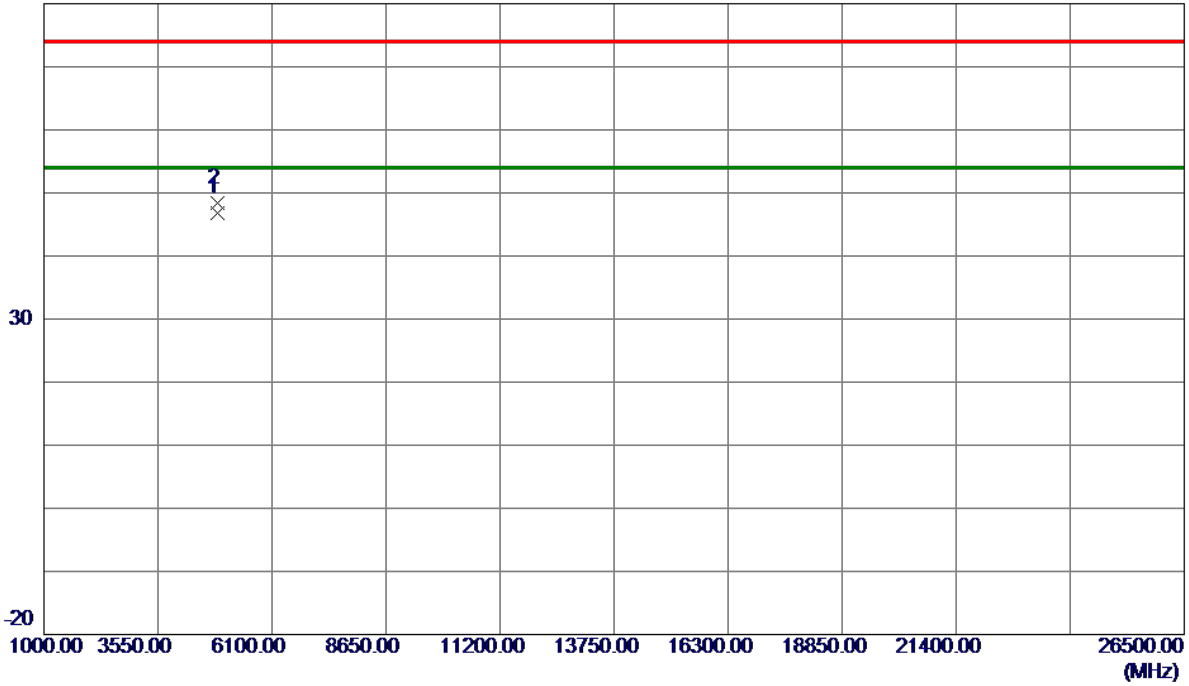

No.	Freq. MHz	Reading Level dBuV/m	Correct Factor dB	Measure ment dBuV/m	Limit dBuV/m	Margin dB	Detector	Comment
1 *	4874.0000	44.20	2.66	46.86	54.00	-7.14	AVG	
2	4874.0099	45.74	2.66	48.40	74.00	-25.60	Peak	

**REMARKS:**

- (1) Measurement Value = Reading Level + Correct Factor.
- (2) Margin Level = Measurement Value - Limit Value.

Test Mode: TX B Mode 2462 MHz

### Vertical

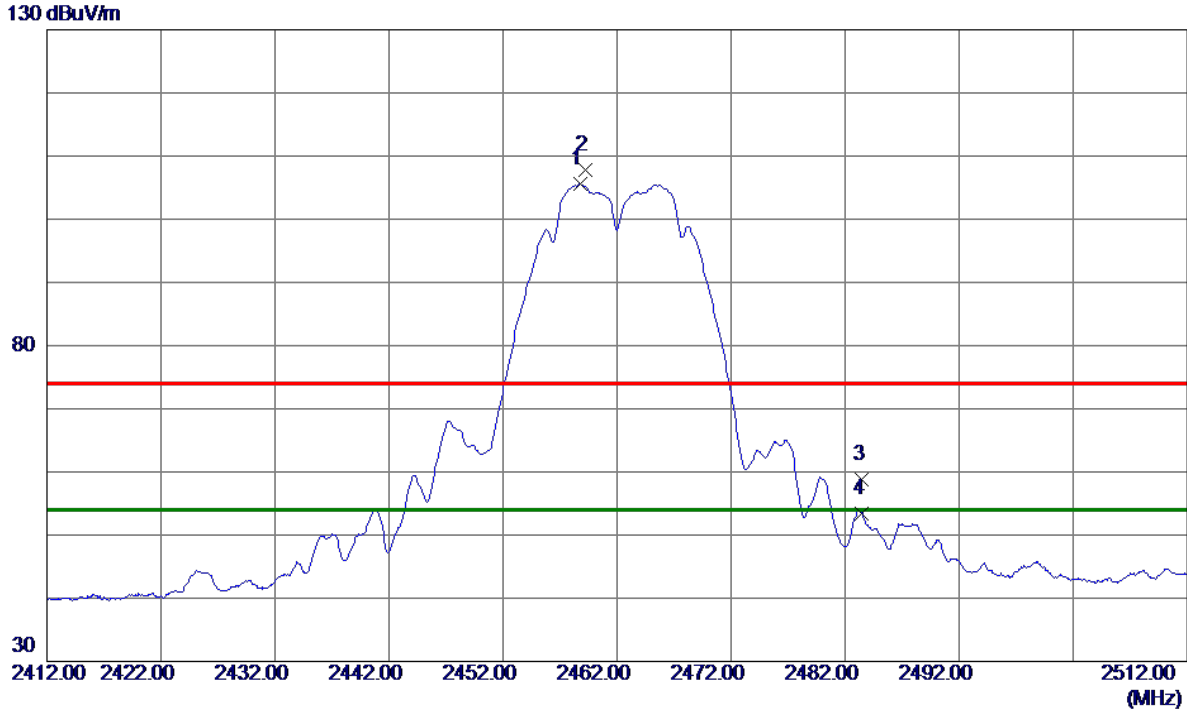

No.	Freq. MHz	Reading Level dBuV/m	Correct Factor dB	Measure ment dBuV/m	Limit dBuV/m	Margin dB	Detector	Comment
1 *	2458.7500	99.46	6.12	105.58	54.00	51.58	AVG	No Limit
2	2459.2000	101.69	6.12	107.81	74.00	33.81	Peak	No Limit
3	2483.5000	52.80	6.08	58.88	74.00	-15.12	Peak	
4	2483.5000	47.37	6.08	53.45	54.00	-0.55	AVG	

**REMARKS:**

- (1) Measurement Value = Reading Level + Correct Factor.
- (2) Margin Level = Measurement Value - Limit Value.

Test Mode: TX B Mode 2462 MHz

### Vertical

80 dBuV/m

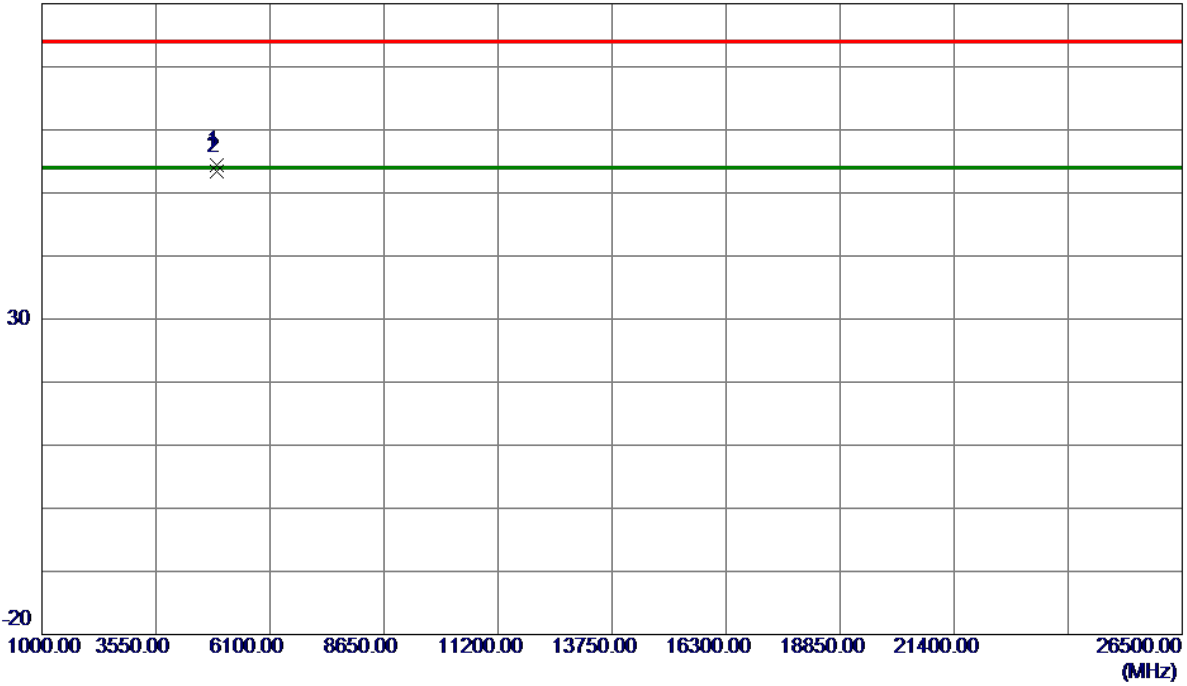

No.	Freq. MHz	Reading Level dBuV/m	Correct Factor dB	Measure ment dBuV/m	Limit dBuV/m	Margin dB	Detector	Comment
1	4923.9400	51.50	2.82	54.32	74.00	-19.68	Peak	
2 *	4924.0099	50.67	2.82	53.49	54.00	-0.51	AVG	

**REMARKS:**

- (1) Measurement Value = Reading Level + Correct Factor.
- (2) Margin Level = Measurement Value - Limit Value.

Test Mode: TX B Mode 2462 MHz

### Horizontal

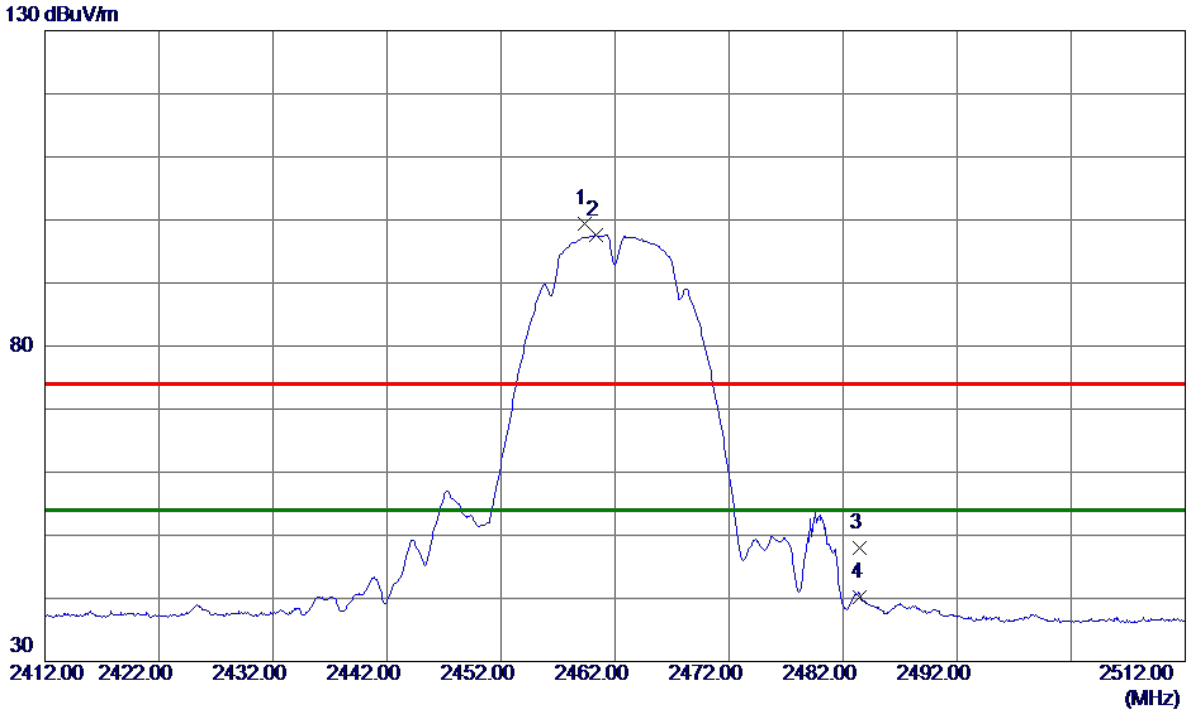

No.	Freq. MHz	Reading Level dBuV/m	Correct Factor dB	Measure ment dBuV/m	Limit dBuV/m	Margin dB	Detector	Comment
1	2459.3000	93.35	6.12	99.47	74.00	25.47	Peak	No Limit
2 *	2460.3000	91.45	6.12	97.57	54.00	43.57	AVG	No Limit
3	2483.4000	41.93	6.08	48.01	74.00	-25.99	Peak	
4	2483.5000	34.09	6.08	40.17	54.00	-13.83	AVG	

**REMARKS:**

- (1) Measurement Value = Reading Level + Correct Factor.
- (2) Margin Level = Measurement Value - Limit Value.

Test Mode: TX B Mode 2462 MHz

### Horizontal

80 dBuV/m

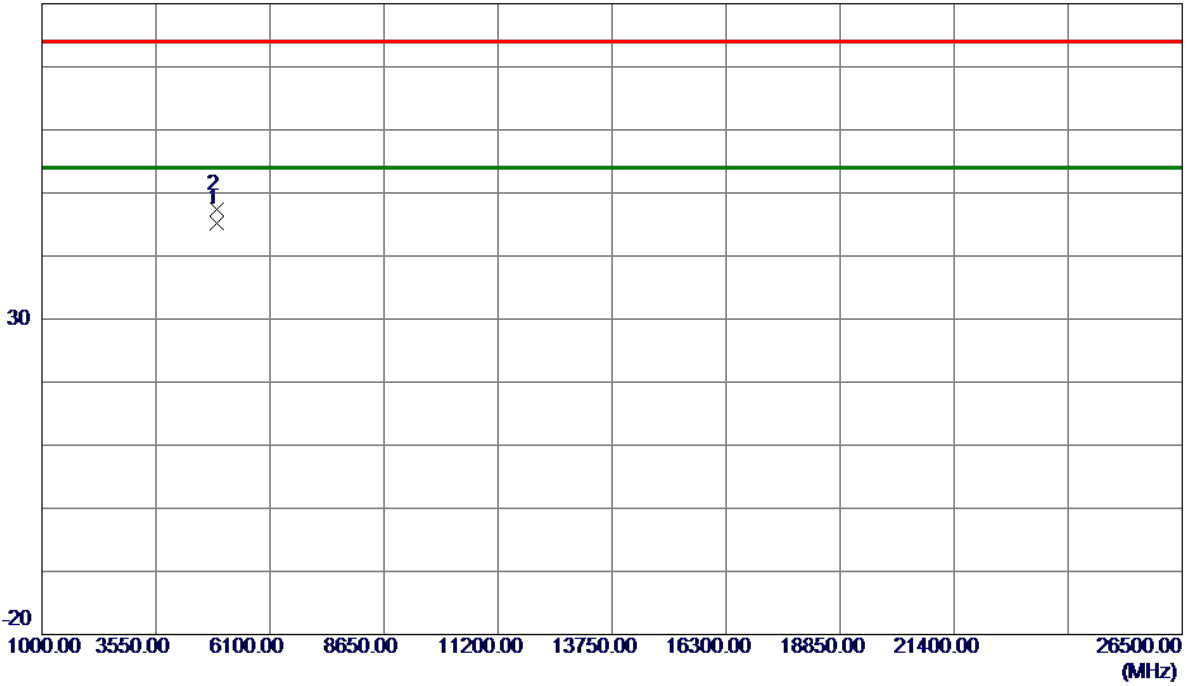

No.	Freq. MHz	Reading Level dBuV/m	Correct Factor dB	Measure ment dBuV/m	Limit dBuV/m	Margin dB	Detector	Comment
1 *	4924.0299	42.41	2.82	45.23	54.00	-8.77	AVG	
2	4924.1000	44.60	2.82	47.42	74.00	-26.58	Peak	

**REMARKS:**

- (1) Measurement Value = Reading Level + Correct Factor.
- (2) Margin Level = Measurement Value - Limit Value.

Test Mode: TX G Mode 2412 MHz

### Vertical

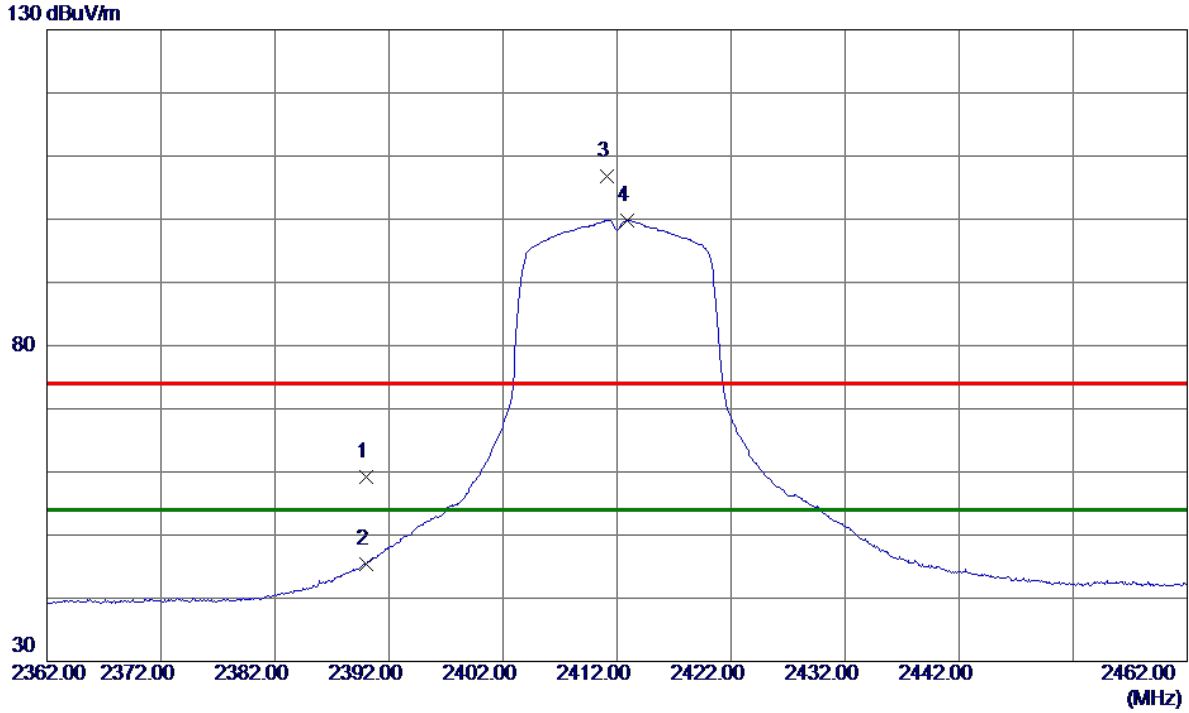

No.	Freq. MHz	Reading Level dBuV/m	Correct Factor dB	Measure ment dBuV/m	Limit dBuV/m	Margin dB	Detector	Comment
1	2390.0000	52.93	6.24	59.17	74.00	-14.83	Peak	
2	2390.0000	39.21	6.24	45.45	54.00	-8.55	AVG	
3	2411.1000	100.54	6.20	106.74	74.00	32.74	Peak	No Limit
4 *	2412.9000	93.65	6.20	99.85	54.00	45.85	AVG	No Limit

**REMARKS:**

(1) Measurement Value = Reading Level + Correct Factor.

(2) Margin Level = Measurement Value - Limit Value.



Test Mode: TX G Mode 2412 MHz

### Vertical

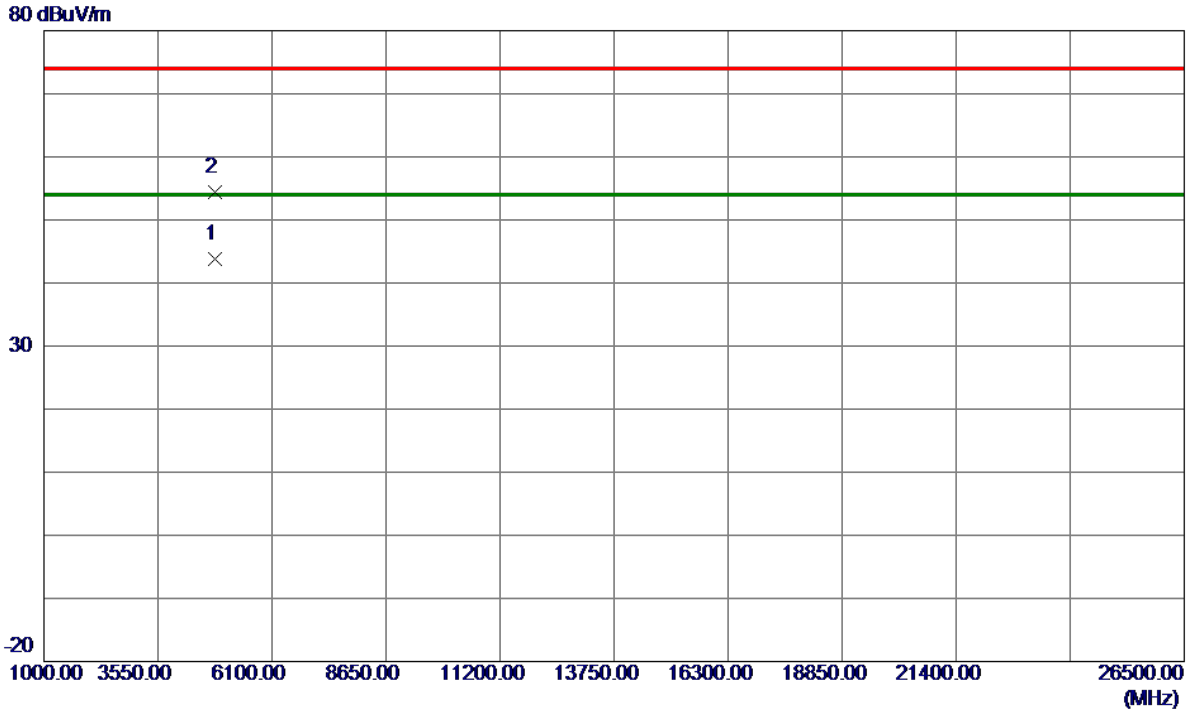

No.	Freq. MHz	Reading Level dBuV/m	Correct Factor dB	Measure ment dBuV/m	Limit dBuV/m	Margin dB	Detector	Comment
1 *	4824.0000	41.40	2.49	43.89	54.00	-10.11	AVG	
2	4826.9500	51.92	2.50	54.42	74.00	-19.58	Peak	

**REMARKS:**

- (1) Measurement Value = Reading Level + Correct Factor.
- (2) Margin Level = Measurement Value - Limit Value.

Test Mode: TX G Mode 2412 MHz

### Horizontal

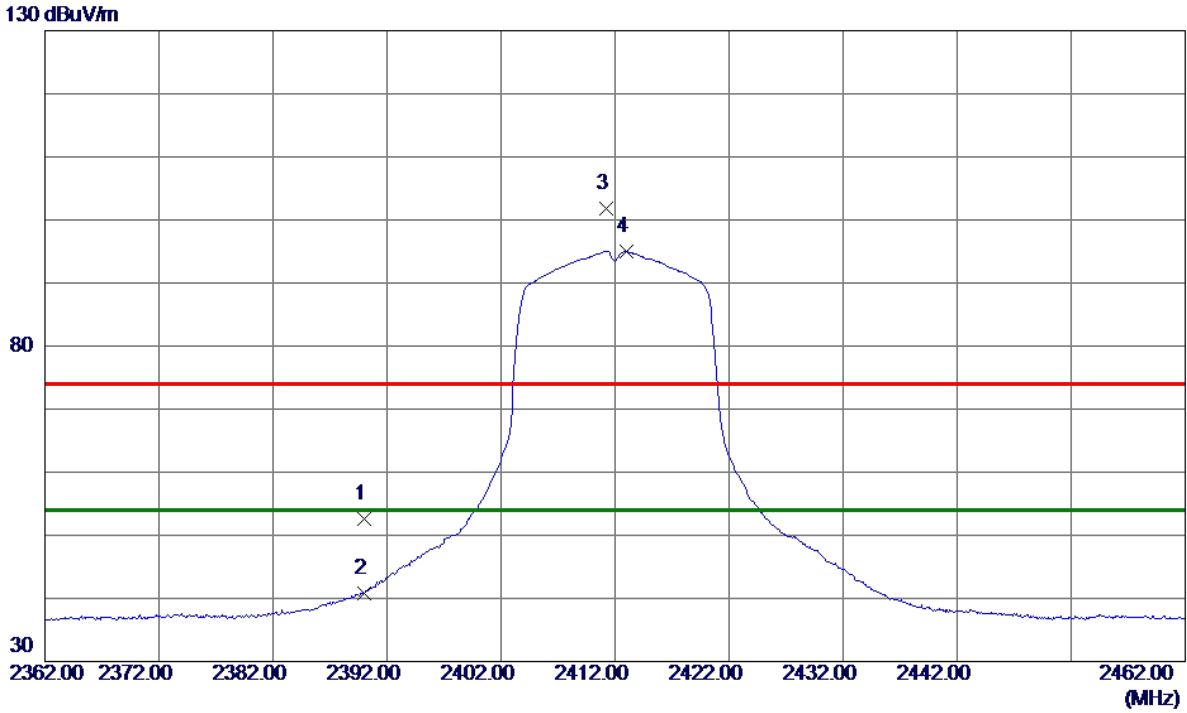

No.	Freq. MHz	Reading Level dBuV/m	Correct Factor dB	Measure ment dBuV/m	Limit dBuV/m	Margin dB	Detector	Comment
1	2390.0000	46.39	6.24	52.63	74.00	-21.37	Peak	
2	2390.0000	34.64	6.24	40.88	54.00	-13.12	AVG	
3	2411.2000	95.55	6.20	101.75	74.00	27.75	Peak	No Limit
4 *	2412.9500	88.83	6.20	95.03	54.00	41.03	AVG	No Limit

**REMARKS:**

- (1) Measurement Value = Reading Level + Correct Factor.
- (2) Margin Level = Measurement Value - Limit Value.

Test Mode: TX G Mode 2412 MHz

### Horizontal



No.	Freq. MHz	Reading Level dBuV/m	Correct Factor dB	Measure ment dBuV/m	Limit dBuV/m	Margin dB	Detector	Comment
1 *	4826.1800	34.92	2.50	37.42	54.00	-16.58	AVG	
2	4826.6600	45.34	2.50	47.84	74.00	-26.16	Peak	

REMARKS:  
 (1) Measurement Value = Reading Level + Correct Factor.  
 (2) Margin Level = Measurement Value - Limit Value.

Test Mode: TX G Mode 2437 MHz

### Vertical

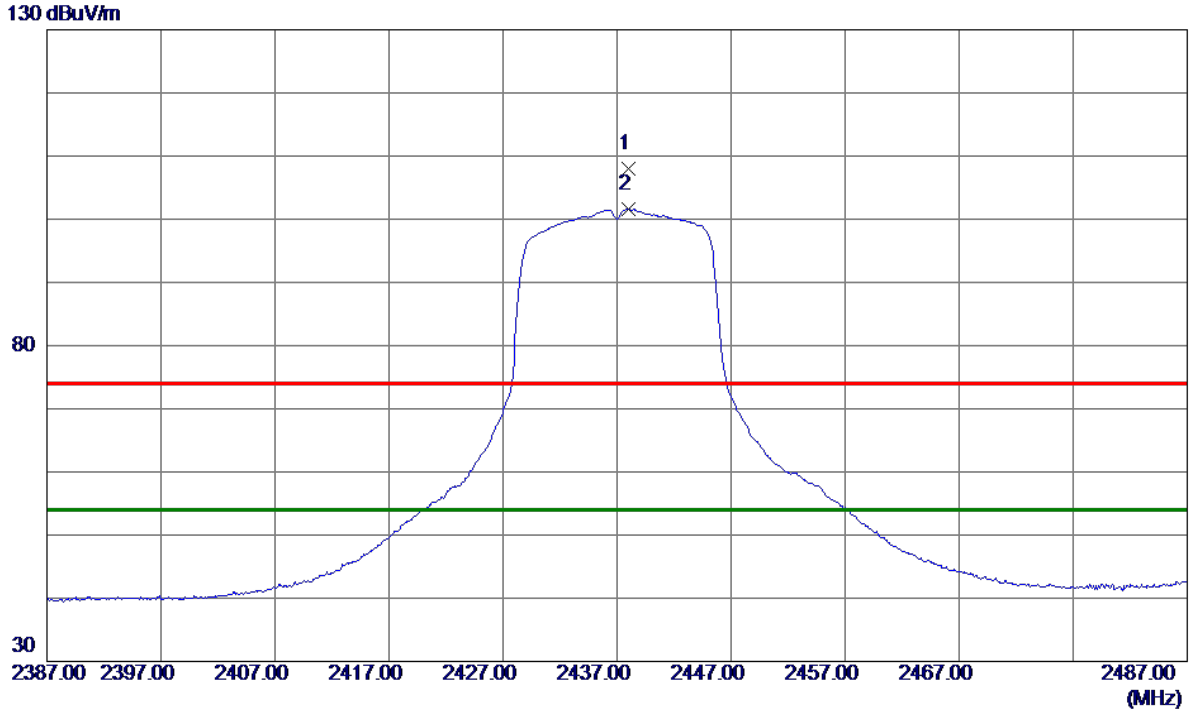

No.	Freq. MHz	Reading Level dBuV/m	Correct Factor dB	Measure ment dBuV/m	Limit dBuV/m	Margin dB	Detector	Comment
1	2438.0000	101.75	6.16	107.91	74.00	33.91	Peak	No Limit
2 *	2438.0000	95.44	6.16	101.60	54.00	47.60	AVG	No Limit

**REMARKS:**

- (1) Measurement Value = Reading Level + Correct Factor.
- (2) Margin Level = Measurement Value - Limit Value.

Test Mode: TX G Mode 2437 MHz

### Vertical

80 dBuV/m

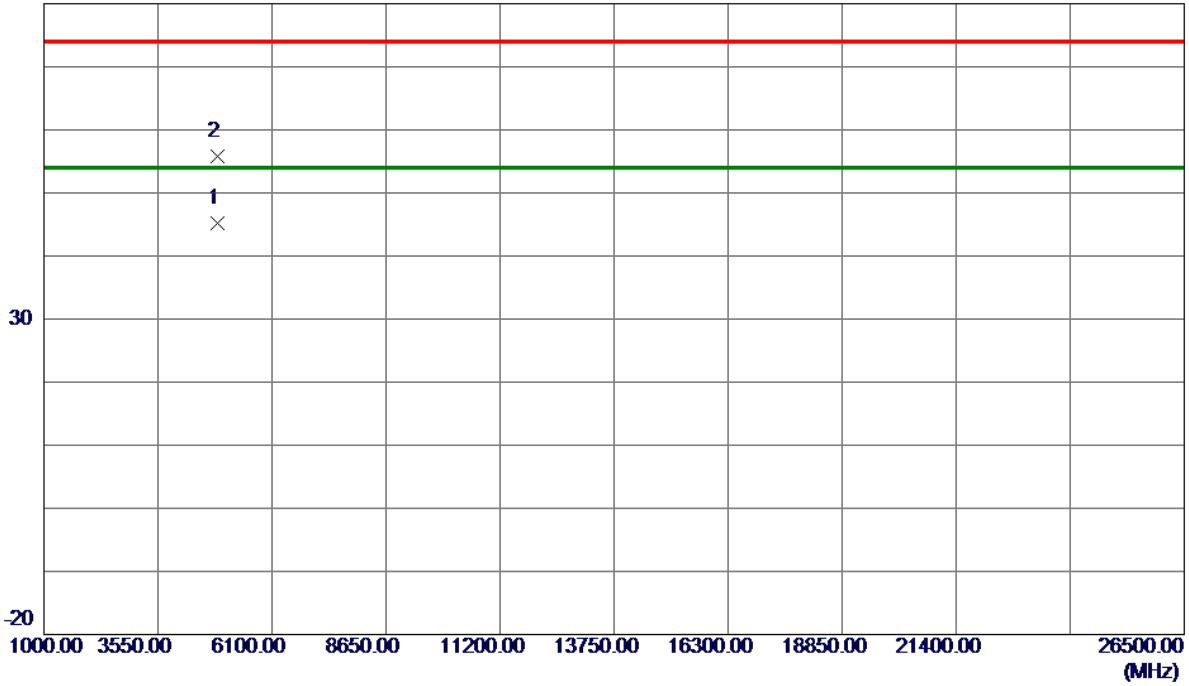

No.	Freq. MHz	Reading Level dBuV/m	Correct Factor dB	Measure ment dBuV/m	Limit dBuV/m	Margin dB	Detector	Comment
1 *	4876.2400	42.46	2.66	45.12	54.00	-8.88	AVG	
2	4877.0900	53.10	2.67	55.77	74.00	-18.23	Peak	

**REMARKS:**

- (1) Measurement Value = Reading Level + Correct Factor.
- (2) Margin Level = Measurement Value - Limit Value.

Test Mode: TX G Mode 2437 MHz

### Horizontal

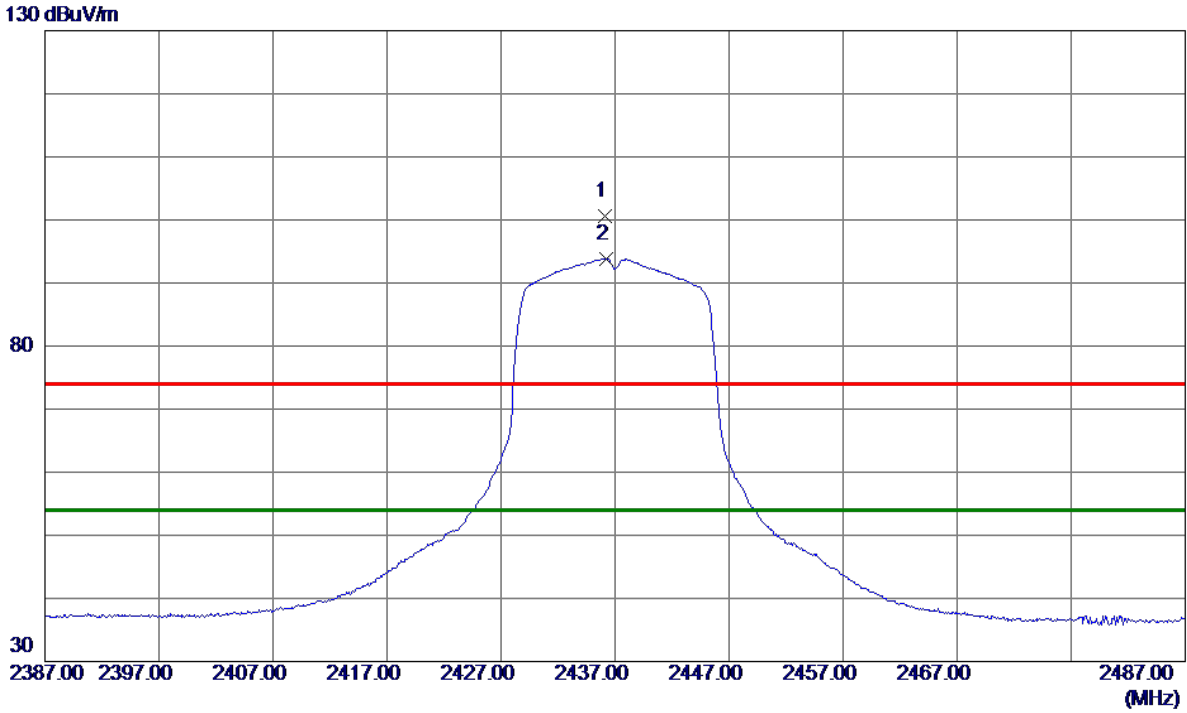

No.	Freq. MHz	Reading Level dBuV/m	Correct Factor dB	Measure ment dBuV/m	Limit dBuV/m	Margin dB	Detector	Comment
1	2436.1500	94.42	6.16	100.58	74.00	26.58	Peak	No Limit
2 *	2436.2500	87.73	6.16	93.89	54.00	39.89	AVG	No Limit

**REMARKS:**

- (1) Measurement Value = Reading Level + Correct Factor.
- (2) Margin Level = Measurement Value - Limit Value.

Test Mode: TX G Mode 2437 MHz

### Horizontal

80 dBuV/m

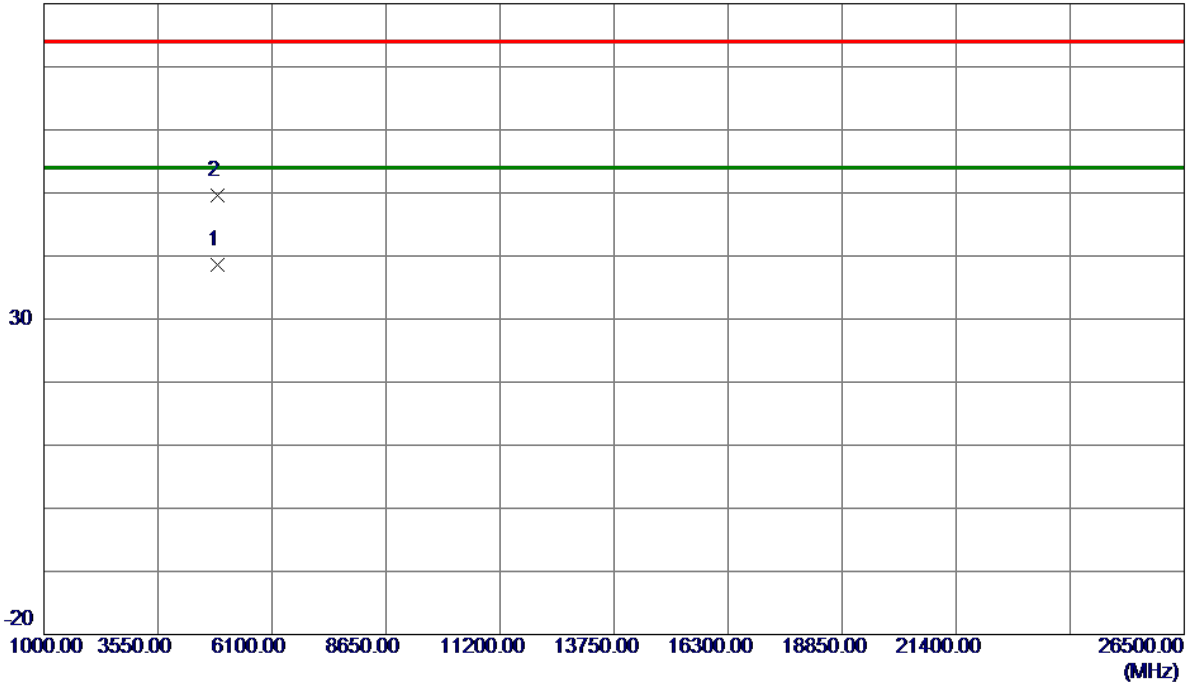

No.	Freq. MHz	Reading Level dBuV/m	Correct Factor dB	Measure ment dBuV/m	Limit dBuV/m	Margin dB	Detector	Comment
1 *	4876.1200	35.99	2.66	38.65	54.00	-15.35	AVG	
2	4877.0400	46.95	2.67	49.62	74.00	-24.38	Peak	

**REMARKS:**

- (1) Measurement Value = Reading Level + Correct Factor.
- (2) Margin Level = Measurement Value - Limit Value.

Test Mode: TX G Mode 2462 MHz

### Vertical

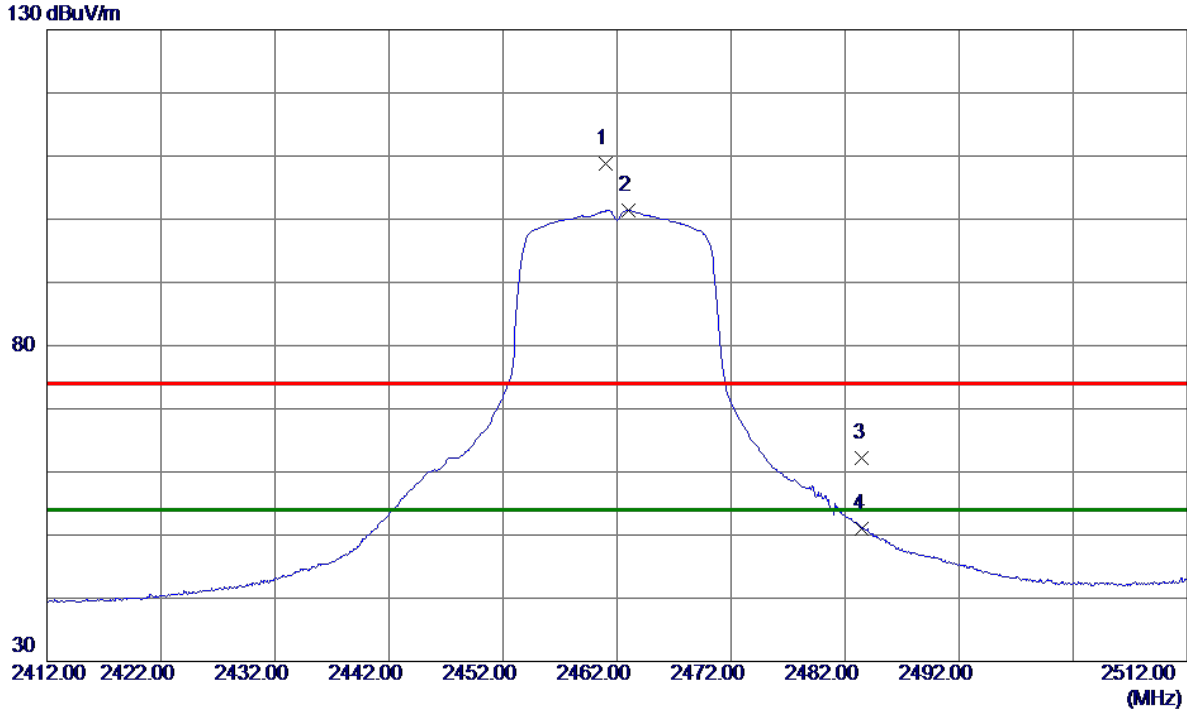

No.	Freq. MHz	Reading Level dBuV/m	Correct Factor dB	Measure ment dBuV/m	Limit dBuV/m	Margin dB	Detector	Comment
1	2461.0500	102.62	6.12	108.74	74.00	34.74	Peak	No Limit
2 *	2463.0000	95.26	6.12	101.38	54.00	47.38	AVG	No Limit
3	2483.5000	56.17	6.08	62.25	74.00	-11.75	Peak	
4	2483.5000	44.95	6.08	51.03	54.00	-2.97	AVG	

**REMARKS:**

- (1) Measurement Value = Reading Level + Correct Factor.
- (2) Margin Level = Measurement Value - Limit Value.



Test Mode: TX G Mode 2462 MHz

### Vertical

80 dBuV/m

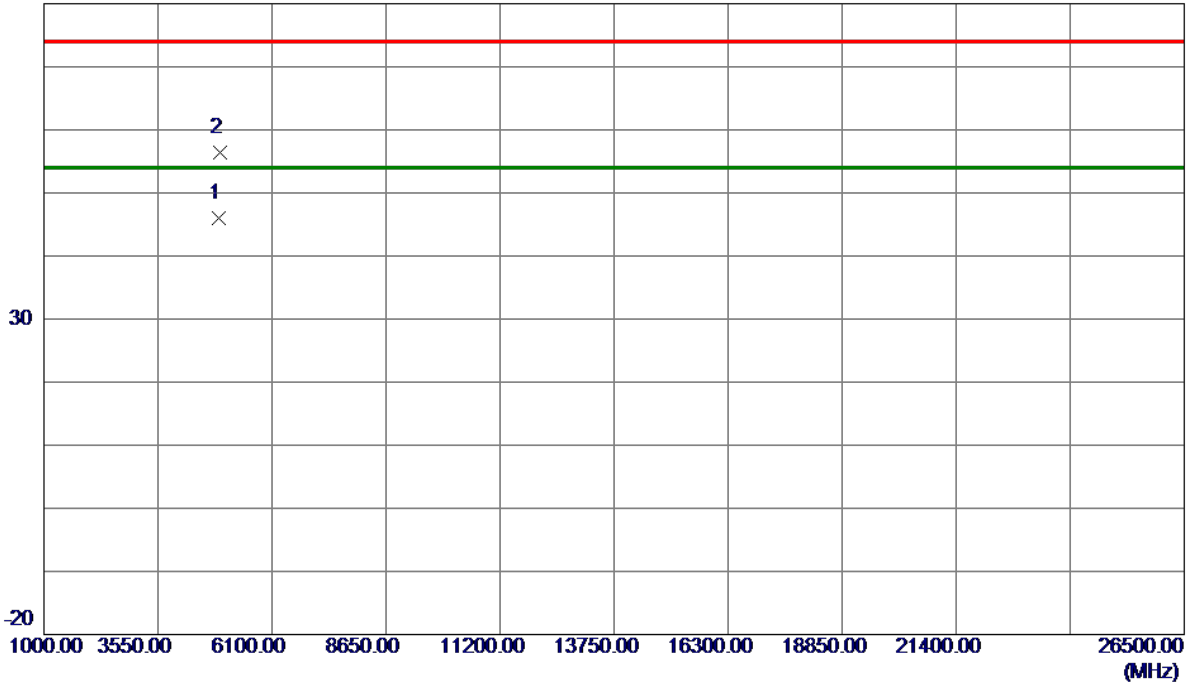

No.	Freq. MHz	Reading Level dBuV/m	Correct Factor dB	Measure ment dBuV/m	Limit dBuV/m	Margin dB	Detector	Comment
1 *	4924.0200	43.11	2.82	45.93	54.00	-8.07	AVG	
2	4926.9400	53.64	2.83	56.47	74.00	-17.53	Peak	

**REMARKS:**

- (1) Measurement Value = Reading Level + Correct Factor.
- (2) Margin Level = Measurement Value - Limit Value.

Test Mode: TX G Mode 2462 MHz

### Horizontal

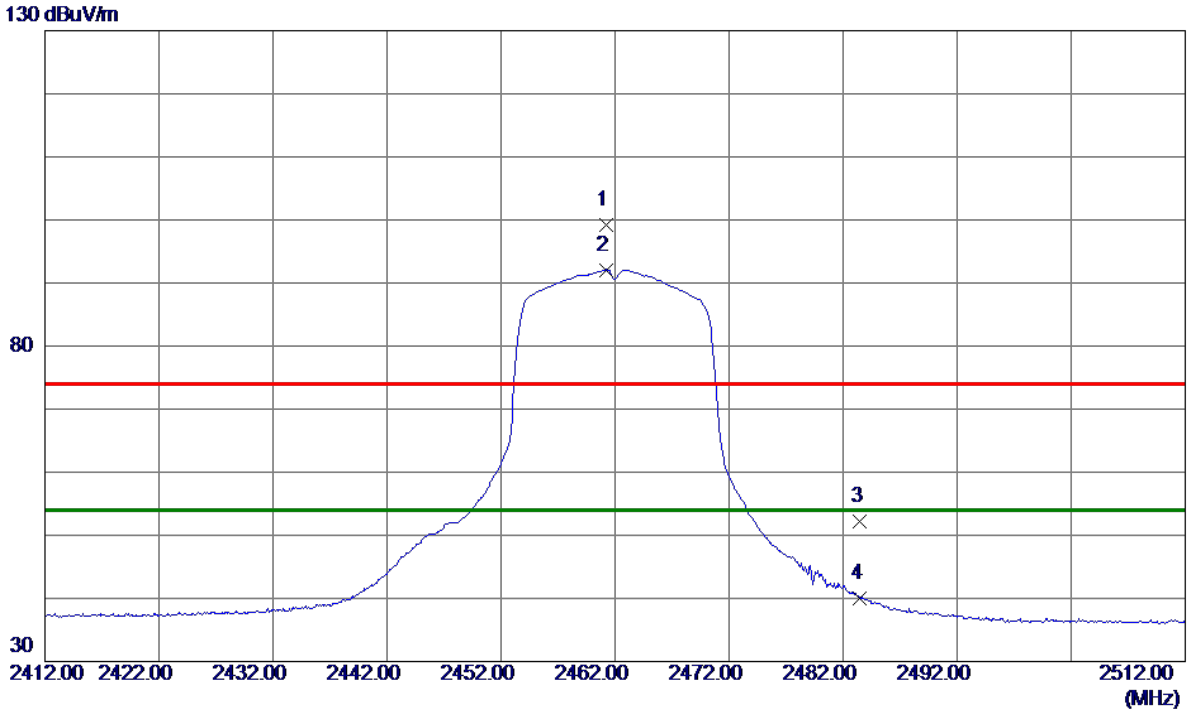

No.	Freq. MHz	Reading Level dBuV/m	Correct Factor dB	Measure ment dBuV/m	Limit dBuV/m	Margin dB	Detector	Comment
1	2461.2000	92.99	6.12	99.11	74.00	25.11	Peak	No Limit
2 *	2461.2500	85.98	6.12	92.10	54.00	38.10	AVG	No Limit
3	2483.5000	46.14	6.08	52.22	74.00	-21.78	Peak	
4	2483.5000	33.95	6.08	40.03	54.00	-13.97	AVG	

**REMARKS:**

- (1) Measurement Value = Reading Level + Correct Factor.
- (2) Margin Level = Measurement Value - Limit Value.

Test Mode: TX G Mode 2462 MHz

### Horizontal

80 dBuV/m

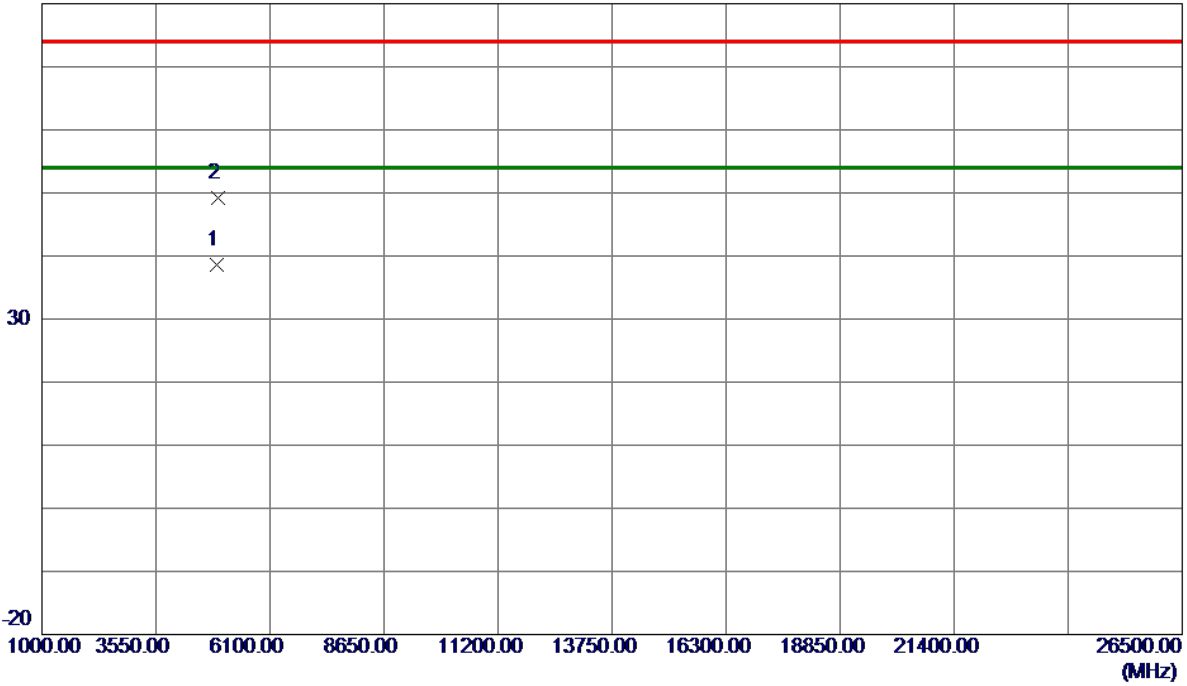

No.	Freq. MHz	Reading Level dBuV/m	Correct Factor dB	Measure ment dBuV/m	Limit dBuV/m	Margin dB	Detector	Comment
1 *	4924.1400	35.79	2.82	38.61	54.00	-15.39	AVG	
2	4926.2200	46.37	2.82	49.19	74.00	-24.81	Peak	

**REMARKS:**

(1) Measurement Value = Reading Level + Correct Factor.

(2) Margin Level = Measurement Value - Limit Value.

Test Mode: TX N-20M Mode 2412 MHz

### Vertical

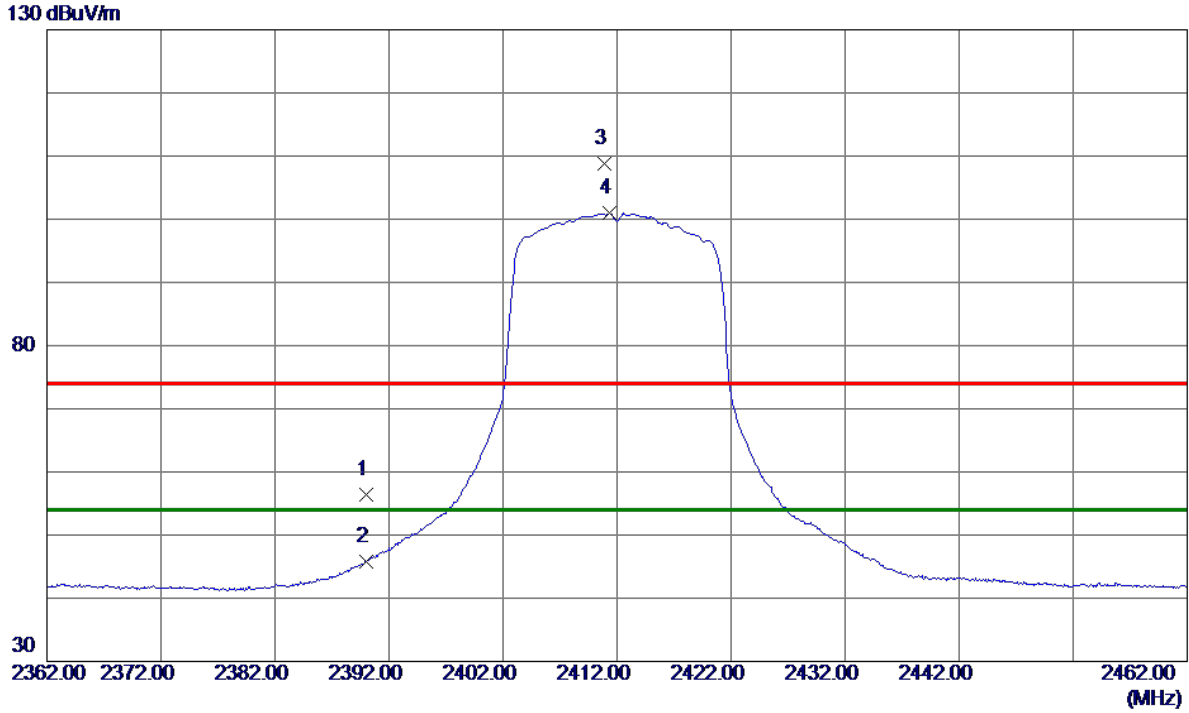

No.	Freq. MHz	Reading Level dBuV/m	Correct Factor dB	Measure ment dBuV/m	Limit dBuV/m	Margin dB	Detector	Comment
1	2390.0000	50.14	6.24	56.38	74.00	-17.62	Peak	
2	2390.0000	39.63	6.24	45.87	54.00	-8.13	AVG	
3	2410.9000	102.57	6.20	108.77	74.00	34.77	Peak	No Limit
4 *	2411.3500	94.70	6.20	100.90	54.00	46.90	AVG	No Limit

**REMARKS:**

- (1) Measurement Value = Reading Level + Correct Factor.
- (2) Margin Level = Measurement Value - Limit Value.

Test Mode: TX N-20M Mode 2412 MHz

### Vertical

80 dBuV/m

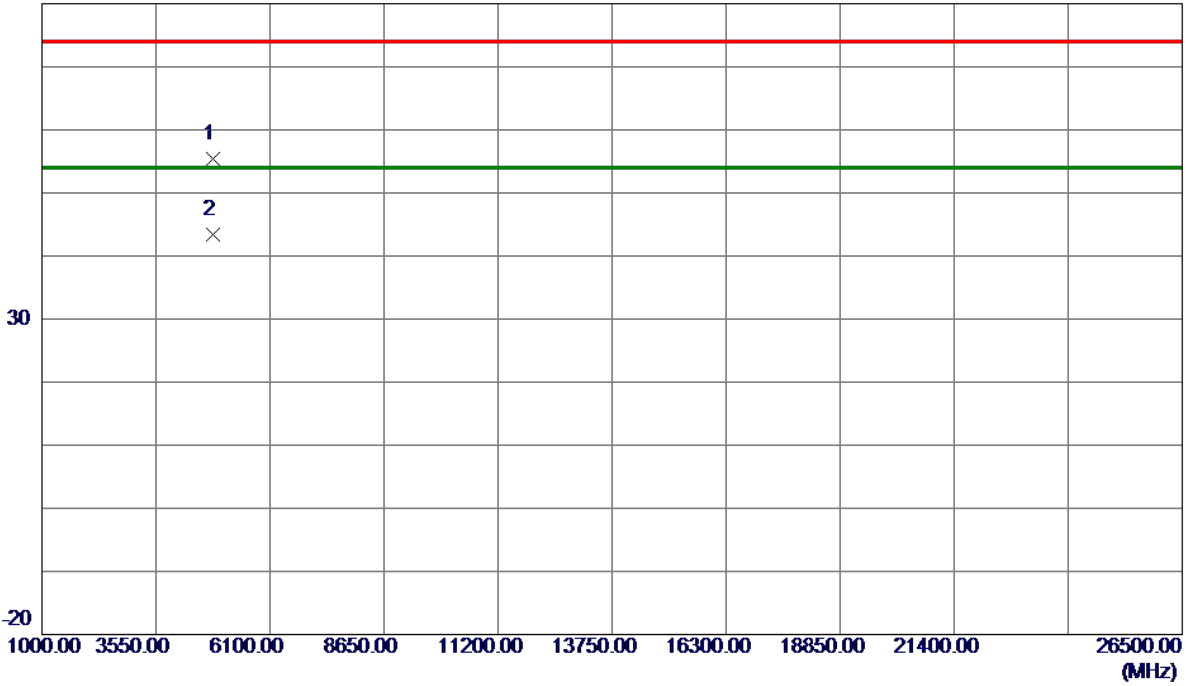

No.	Freq. MHz	Reading Level dBuV/m	Correct Factor dB	Measure ment dBuV/m	Limit dBuV/m	Margin dB	Detector	Comment
1	4823.3600	52.99	2.49	55.48	74.00	-18.52	Peak	
2 *	4824.0900	40.92	2.50	43.42	54.00	-10.58	AVG	

**REMARKS:**

- (1) Measurement Value = Reading Level + Correct Factor.
- (2) Margin Level = Measurement Value - Limit Value.

Test Mode: TX N-20M Mode 2412 MHz

### Horizontal

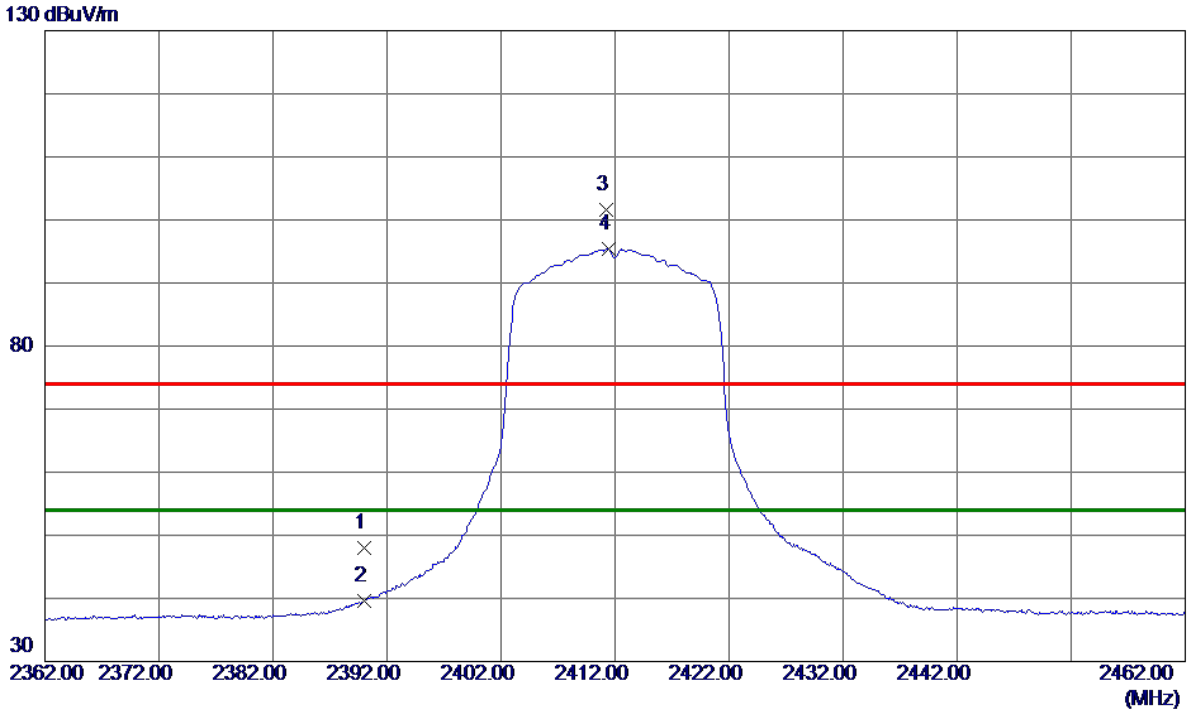

No.	Freq. MHz	Reading Level dBuV/m	Correct Factor dB	Measure ment dBuV/m	Limit dBuV/m	Margin dB	Detector	Comment
1	2390.0000	41.78	6.24	48.02	74.00	-25.98	Peak	
2	2390.0000	33.34	6.24	39.58	54.00	-14.42	AVG	
3	2411.2000	95.45	6.20	101.65	74.00	27.65	Peak	No Limit
4 *	2411.4000	89.21	6.20	95.41	54.00	41.41	AVG	No Limit

**REMARKS:**

- (1) Measurement Value = Reading Level + Correct Factor.
- (2) Margin Level = Measurement Value - Limit Value.

Test Mode: TX N-20M Mode 2412 MHz

### Horizontal

80 dBuV/m

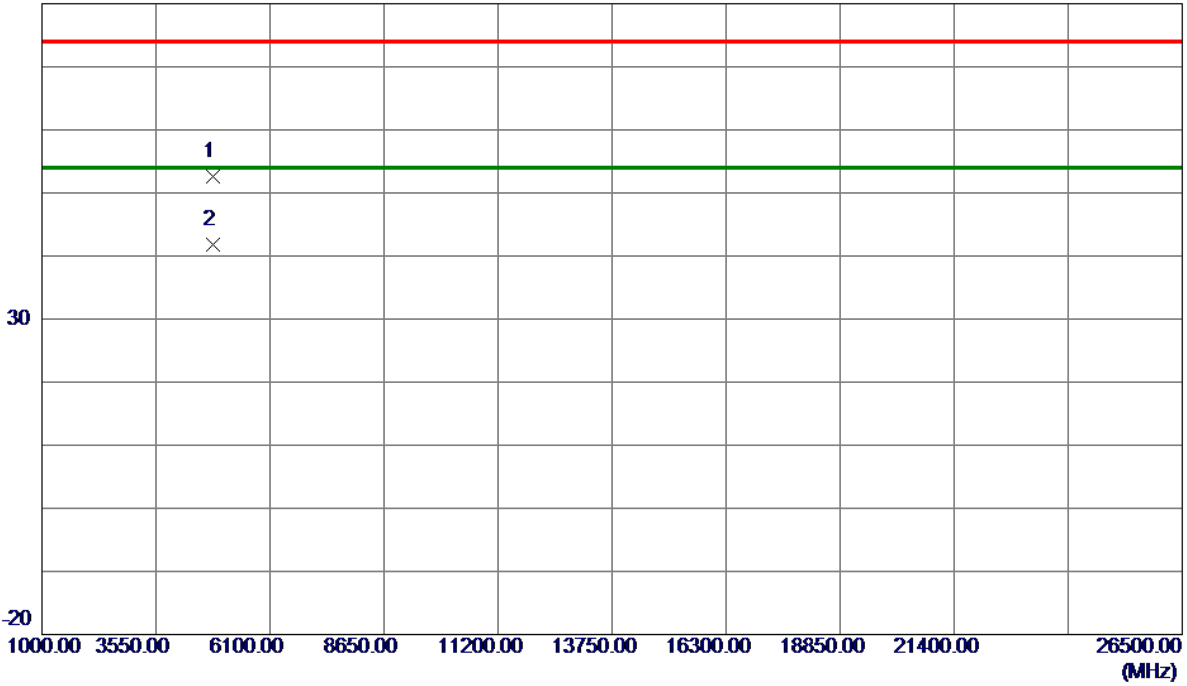

No.	Freq. MHz	Reading Level dBuV/m	Correct Factor dB	Measure ment dBuV/m	Limit dBuV/m	Margin dB	Detector	Comment
1	4821.8900	50.12	2.49	52.61	74.00	-21.39	Peak	
2 *	4823.9200	39.25	2.49	41.74	54.00	-12.26	AVG	

**REMARKS:**

- (1) Measurement Value = Reading Level + Correct Factor.
- (2) Margin Level = Measurement Value - Limit Value.

Test Mode: TX N-20M Mode 2437 MHz

### Vertical

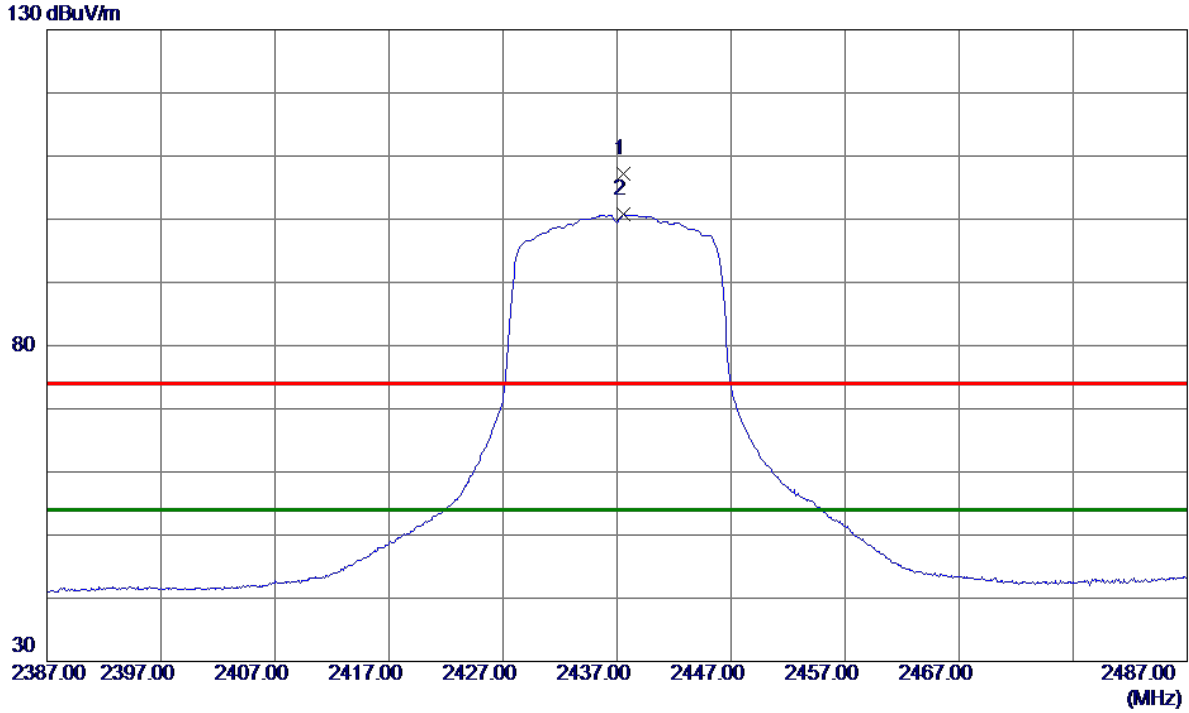

No.	Freq. MHz	Reading Level dBuV/m	Correct Factor dB	Measure ment dBuV/m	Limit dBuV/m	Margin dB	Detector	Comment
1	2437.6000	101.03	6.16	107.19	74.00	33.19	Peak	No Limit
2 *	2437.6000	94.60	6.16	100.76	54.00	46.76	AVG	No Limit

**REMARKS:**

(1) Measurement Value = Reading Level + Correct Factor.

(2) Margin Level = Measurement Value - Limit Value.



Test Mode: TX N-20M Mode 2437 MHz

### Vertical

80 dBuV/m

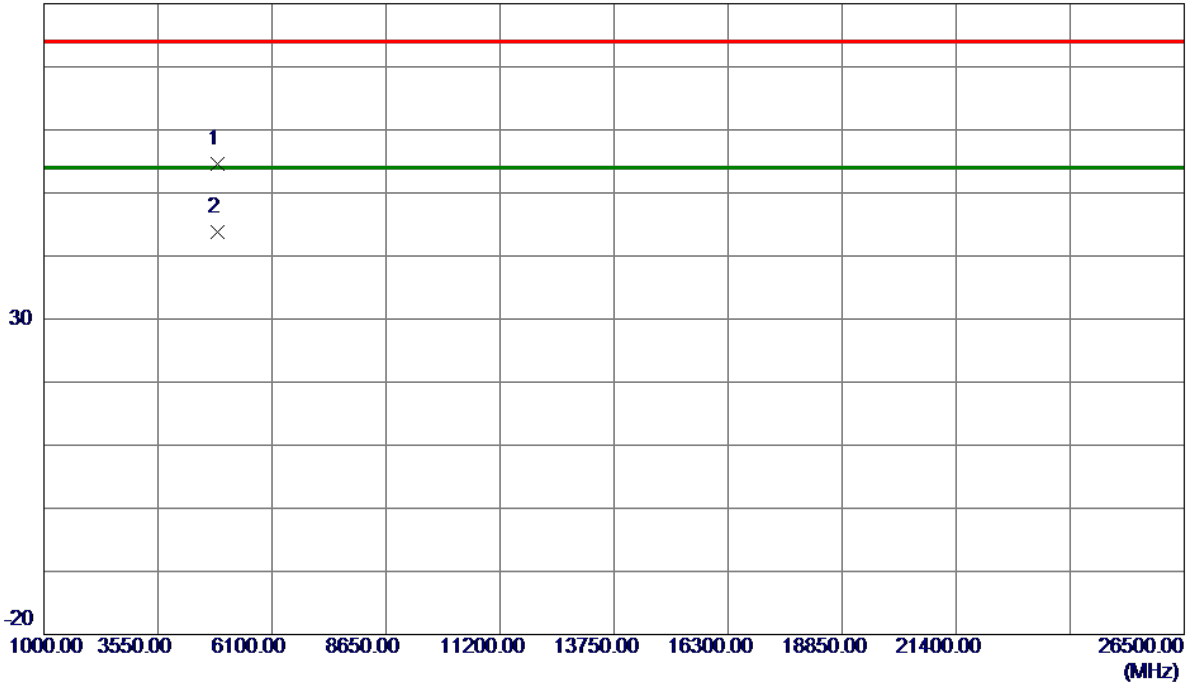

No.	Freq. MHz	Reading Level dBuV/m	Correct Factor dB	Measure ment dBuV/m	Limit dBuV/m	Margin dB	Detector	Comment
1	4871.9800	52.02	2.65	54.67	74.00	-19.33	Peak	
2 *	4873.9400	41.06	2.66	43.72	54.00	-10.28	AVG	

**REMARKS:**

- (1) Measurement Value = Reading Level + Correct Factor.
- (2) Margin Level = Measurement Value - Limit Value.

Test Mode: TX N-20M Mode 2437 MHz

### Horizontal

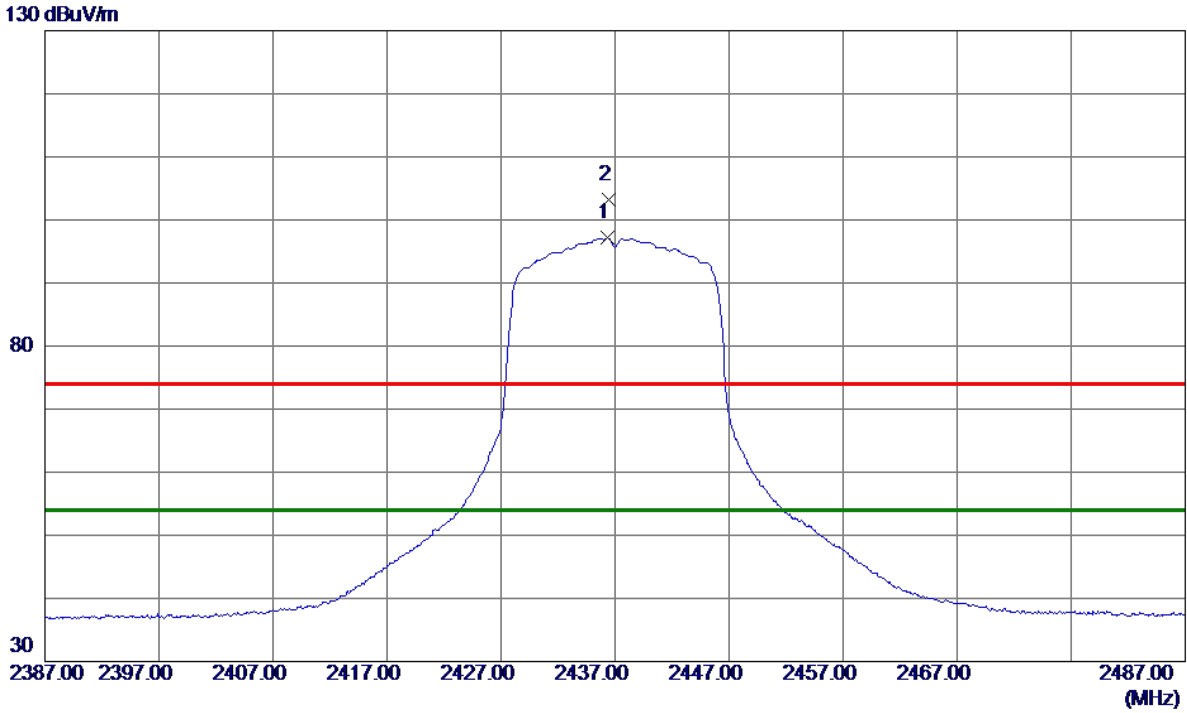

No.	Freq. MHz	Reading Level dBuV/m	Correct Factor dB	Measure ment dBuV/m	Limit dBuV/m	Margin dB	Detector	Comment
1 *	2436.3500	90.97	6.16	97.13	54.00	43.13	AVG	No Limit
2	2436.4500	97.03	6.16	103.19	74.00	29.19	Peak	No Limit

**REMARKS:**

- (1) Measurement Value = Reading Level + Correct Factor.
- (2) Margin Level = Measurement Value - Limit Value.

Test Mode: TX N-20M Mode 2437 MHz

### Horizontal

80 dBuV/m

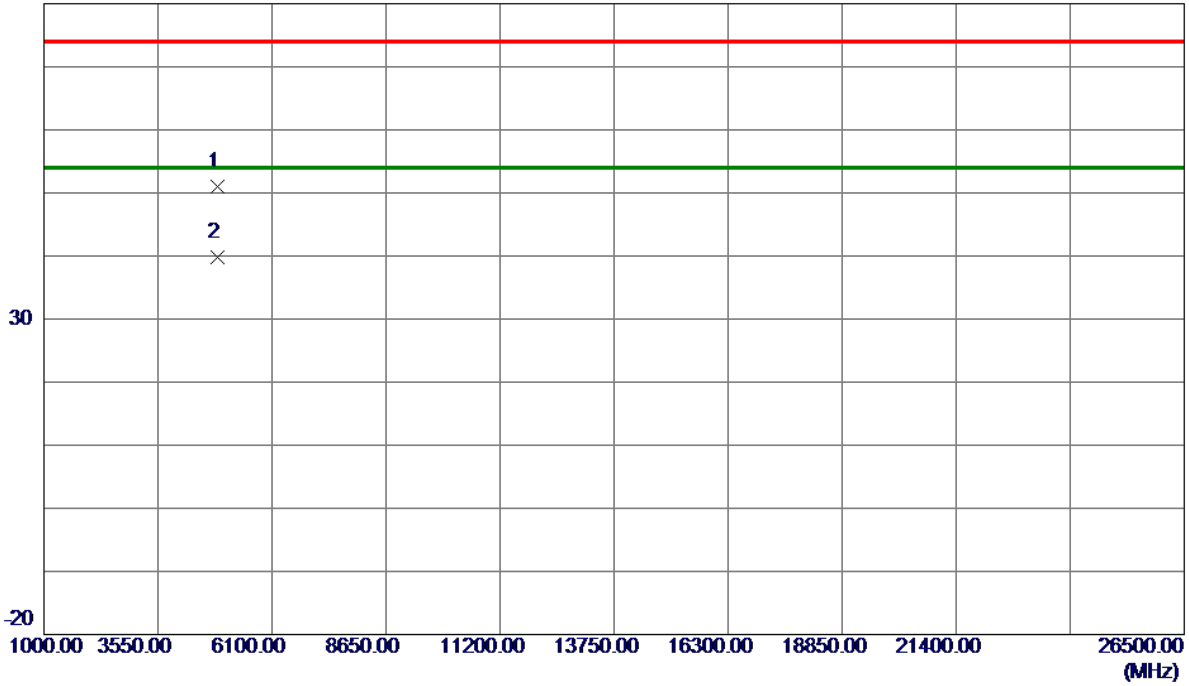

No.	Freq. MHz	Reading Level dBuV/m	Correct Factor dB	Measure ment dBuV/m	Limit dBuV/m	Margin dB	Detector	Comment
1	4872.0800	48.44	2.65	51.09	74.00	-22.91	Peak	
2 *	4873.7100	37.14	2.65	39.79	54.00	-14.21	AVG	

**REMARKS:**

(1) Measurement Value = Reading Level + Correct Factor.

(2) Margin Level = Measurement Value - Limit Value.

Test Mode: TX N-20M Mode 2462 MHz

### Vertical

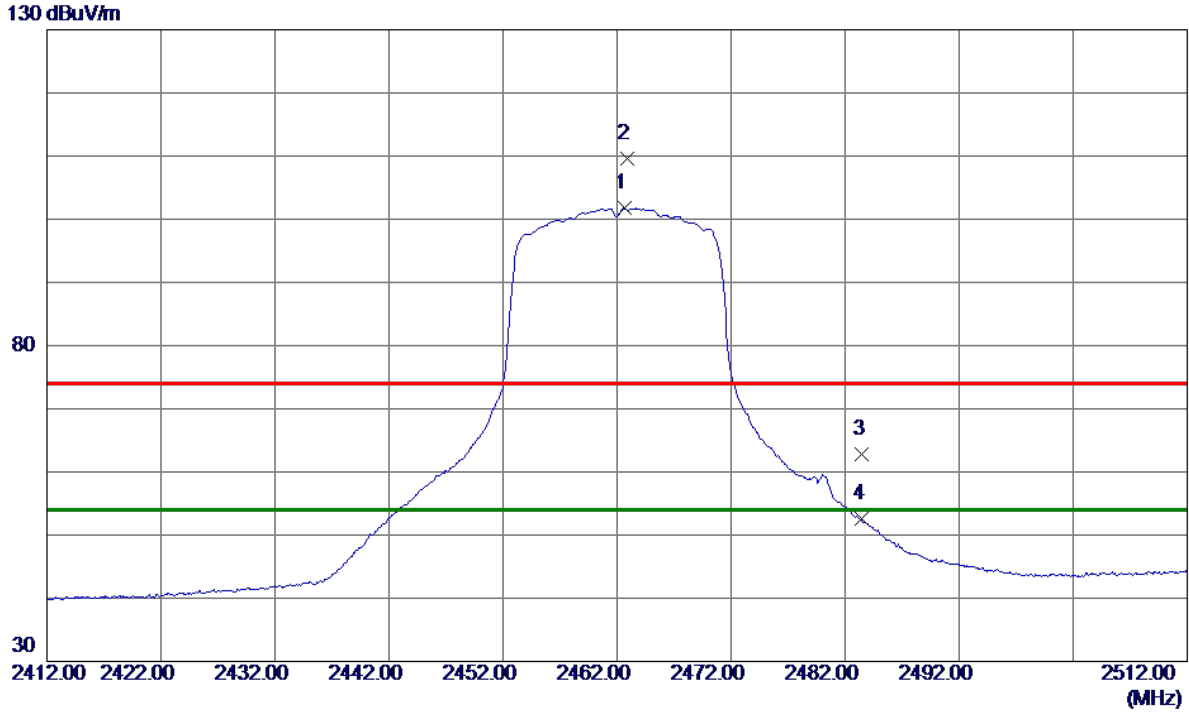

No.	Freq. MHz	Reading Level dBuV/m	Correct Factor dB	Measure ment dBuV/m	Limit dBuV/m	Margin dB	Detector	Comment
1 *	2462.6500	95.61	6.12	101.73	54.00	47.73	AVG	No Limit
2	2462.9000	103.49	6.12	109.61	74.00	35.61	Peak	No Limit
3	2483.5000	56.81	6.08	62.89	74.00	-11.11	Peak	
4	2483.5000	46.49	6.08	52.57	54.00	-1.43	AVG	

**REMARKS:**

- (1) Measurement Value = Reading Level + Correct Factor.
- (2) Margin Level = Measurement Value - Limit Value.

Test Mode: TX N-20M Mode 2462 MHz

### Vertical

80 dBuV/m

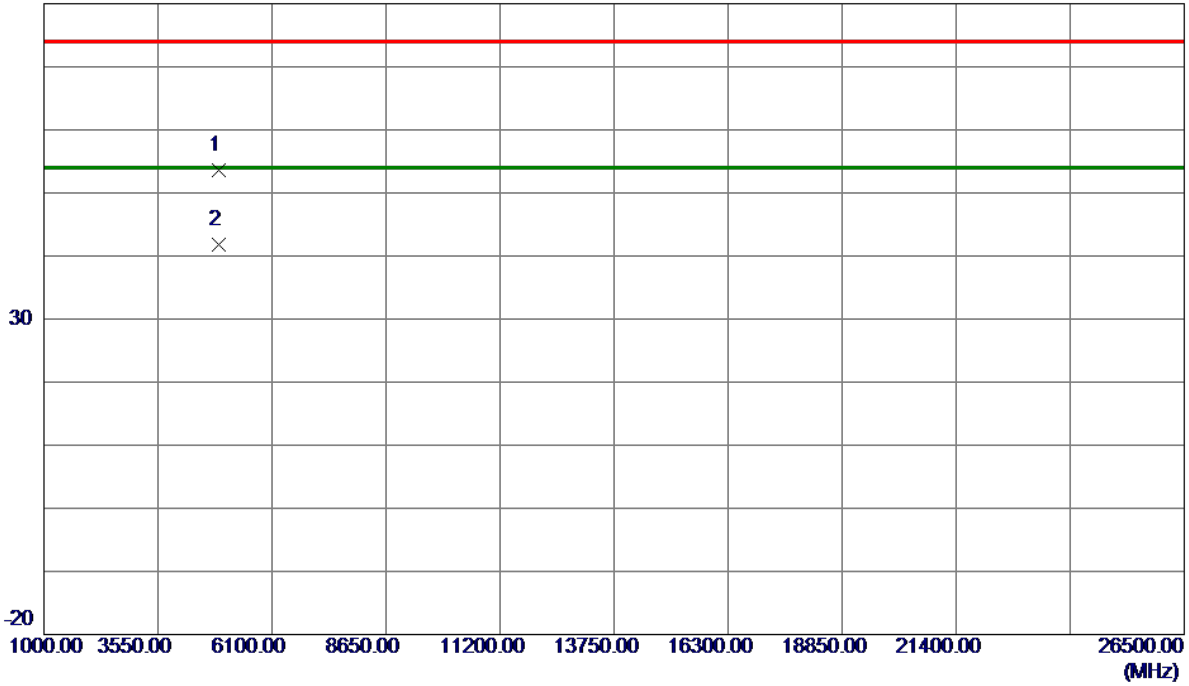

No.	Freq. MHz	Reading Level dBuV/m	Correct Factor dB	Measure ment dBuV/m	Limit dBuV/m	Margin dB	Detector	Comment
1	4923.1400	50.85	2.81	53.66	74.00	-20.34	Peak	
2 *	4923.8600	38.99	2.82	41.81	54.00	-12.19	AVG	

**REMARKS:**

- (1) Measurement Value = Reading Level + Correct Factor.
- (2) Margin Level = Measurement Value - Limit Value.

Test Mode: TX N-20M Mode 2462 MHz

### Horizontal

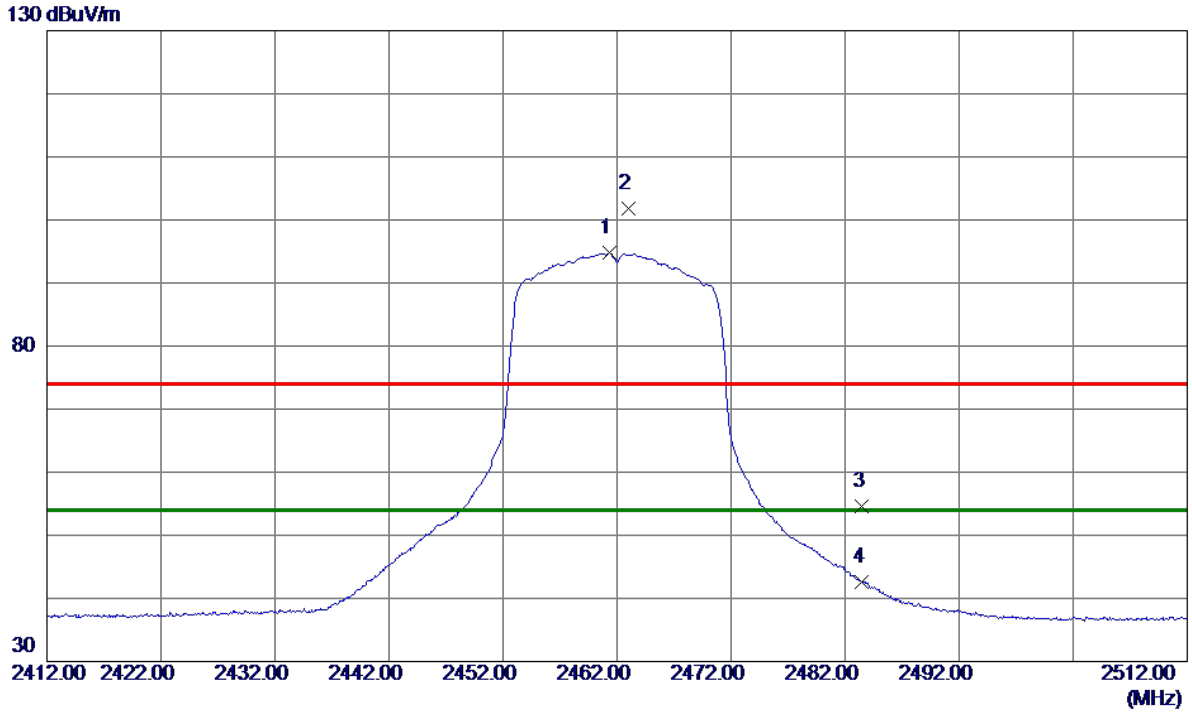

No.	Freq. MHz	Reading Level dBuV/m	Correct Factor dB	Measure ment dBuV/m	Limit dBuV/m	Margin dB	Detector	Comment
1 *	2461.3500	88.60	6.12	94.72	54.00	40.72	AVG	No Limit
2	2462.9500	95.75	6.12	101.87	74.00	27.87	Peak	No Limit
3	2483.5000	48.43	6.08	54.51	74.00	-19.49	Peak	
4	2483.5000	36.47	6.08	42.55	54.00	-11.45	AVG	

**REMARKS:**

- (1) Measurement Value = Reading Level + Correct Factor.
- (2) Margin Level = Measurement Value - Limit Value.

Test Mode: TX N-20M Mode 2462 MHz

### Horizontal

80 dBuV/m

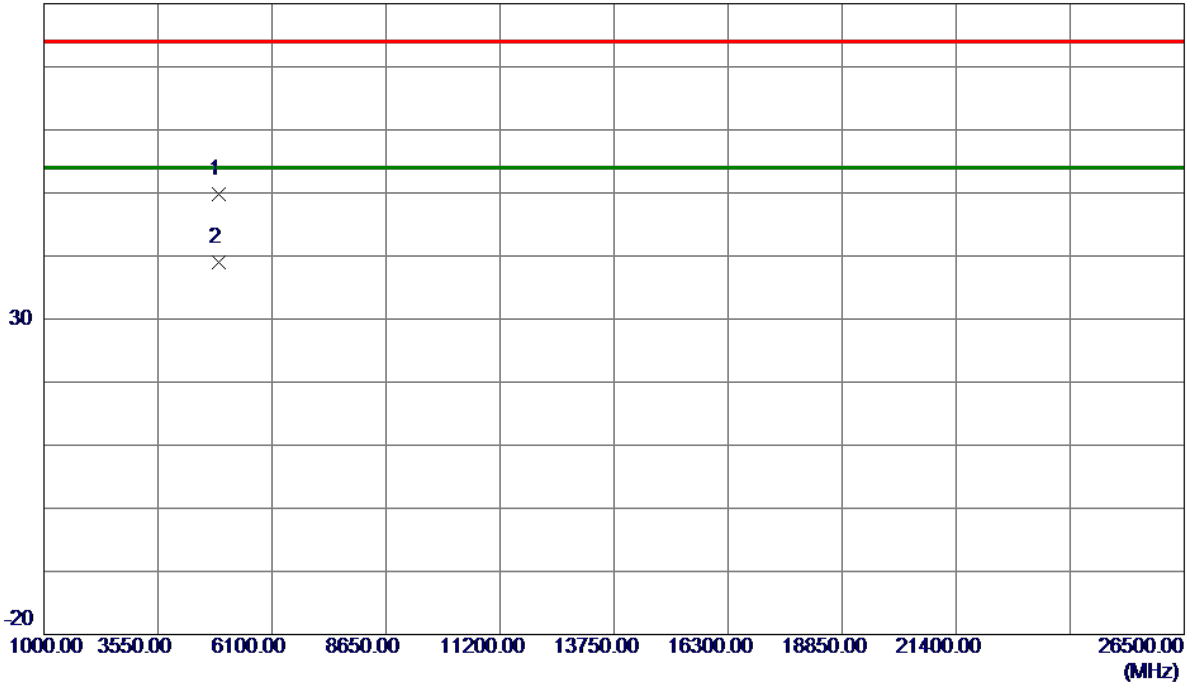

No.	Freq. MHz	Reading Level dBuV/m	Correct Factor dB	Measure ment dBuV/m	Limit dBuV/m	Margin dB	Detector	Comment
1	4919.9500	46.94	2.80	49.74	74.00	-24.26	Peak	
2 *	4923.8500	36.11	2.82	38.93	54.00	-15.07	AVG	

**REMARKS:**

(1) Measurement Value = Reading Level + Correct Factor.

(2) Margin Level = Measurement Value - Limit Value.

Test Mode: TX N-40M Mode 2422MHz

### Vertical

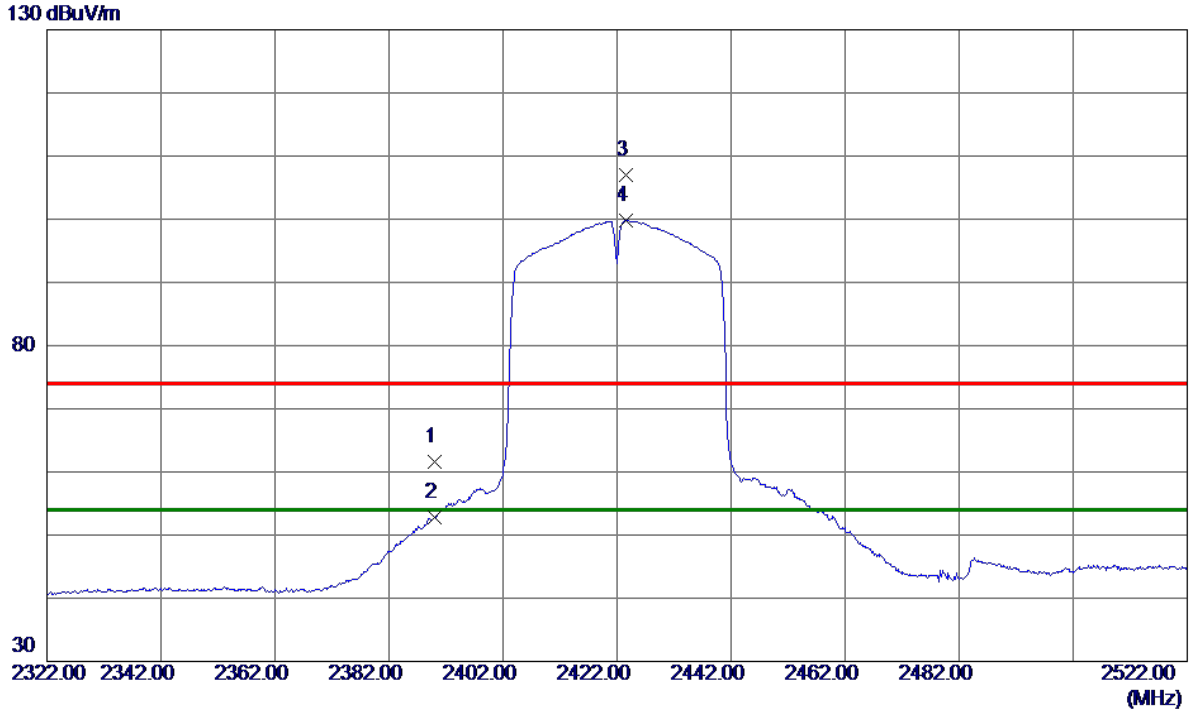

No.	Freq. MHz	Reading Level dBuV/m	Correct Factor dB	Measure ment dBuV/m	Limit dBuV/m	Margin dB	Detector	Comment
1	2390.0000	55.29	6.24	61.53	74.00	-12.47	Peak	
2	2390.0000	46.59	6.24	52.83	54.00	-1.17	AVG	
3	2423.5000	100.85	6.18	107.03	74.00	33.03	Peak	No Limit
4 *	2423.6000	93.68	6.18	99.86	54.00	45.86	AVG	No Limit

**REMARKS:**

- (1) Measurement Value = Reading Level + Correct Factor.
- (2) Margin Level = Measurement Value - Limit Value.



Test Mode: TX N-40M Mode 2422MHz

### Vertical

80 dBuV/m

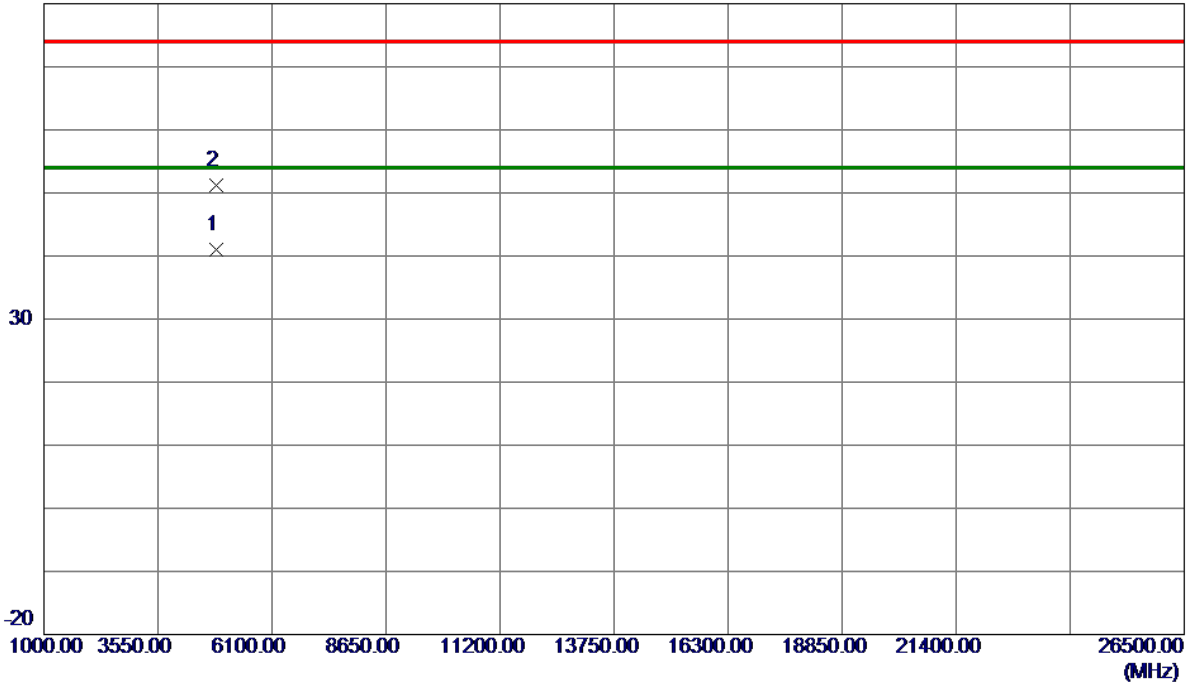

No.	Freq. MHz	Reading Level dBuV/m	Correct Factor dB	Measure ment dBuV/m	Limit dBuV/m	Margin dB	Detector	Comment
1 *	4844.0099	38.39	2.56	40.95	54.00	-13.05	AVG	
2	4844.8000	48.61	2.56	51.17	74.00	-22.83	Peak	

**REMARKS:**

- (1) Measurement Value = Reading Level + Correct Factor.
- (2) Margin Level = Measurement Value - Limit Value.

Test Mode: TX N-40M Mode 2422MHz

### Horizontal

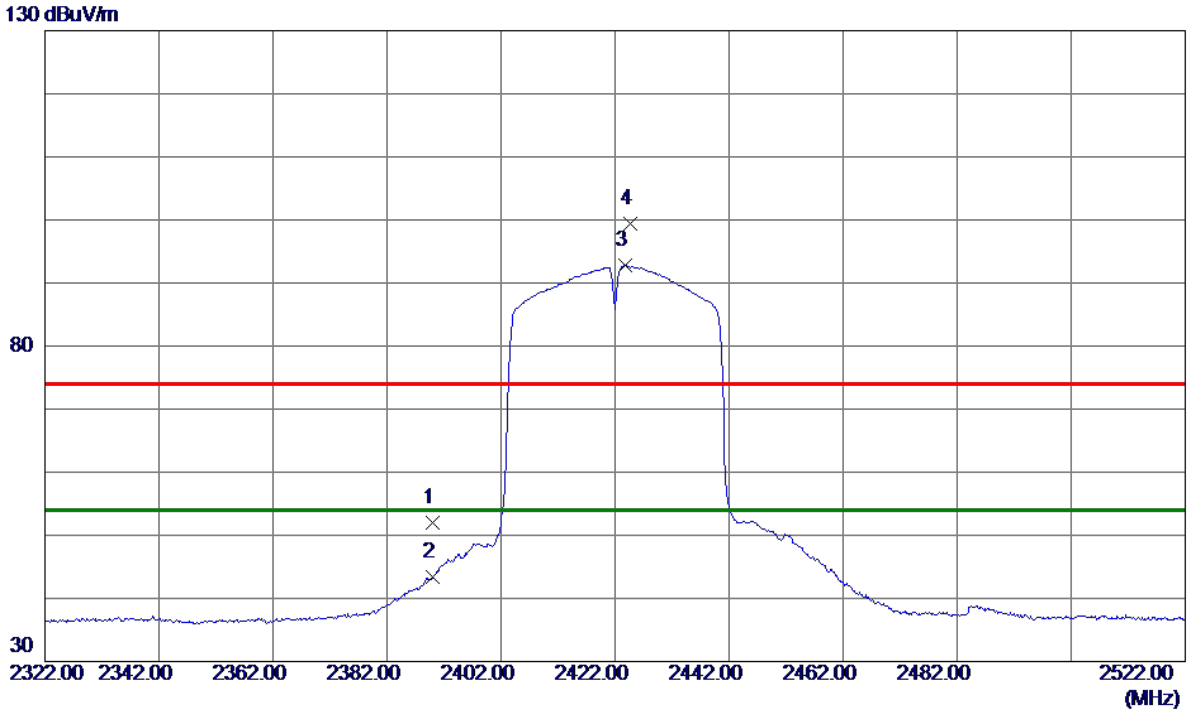

No.	Freq. MHz	Reading Level dBuV/m	Correct Factor dB	Measure ment dBuV/m	Limit dBuV/m	Margin dB	Detector	Comment
1	2390.0000	45.69	6.24	51.93	74.00	-22.07	Peak	
2	2390.0000	37.16	6.24	43.40	54.00	-10.60	AVG	
3 *	2423.8000	86.63	6.18	92.81	54.00	38.81	AVG	No Limit
4	2424.6000	93.18	6.18	99.36	74.00	25.36	Peak	No Limit

**REMARKS:**

- (1) Measurement Value = Reading Level + Correct Factor.
- (2) Margin Level = Measurement Value - Limit Value.

Test Mode: TX N-40M Mode 2422MHz

### Horizontal

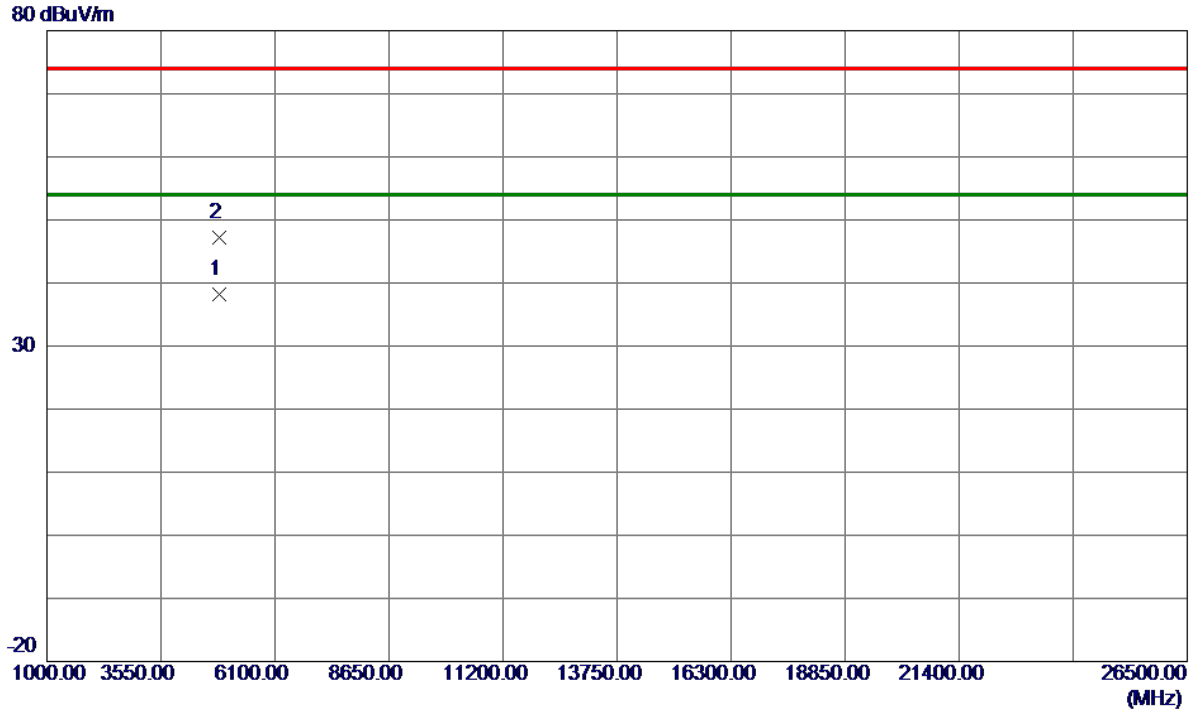

No.	Freq. MHz	Reading Level dBuV/m	Correct Factor dB	Measure ment dBuV/m	Limit dBuV/m	Margin dB	Detector	Comment
1 *	4844.0099	35.58	2.56	38.14	54.00	-15.86	AVG	
2	4848.9900	44.56	2.58	47.14	74.00	-26.86	Peak	

REMARKS:  
 (1) Measurement Value = Reading Level + Correct Factor.  
 (2) Margin Level = Measurement Value - Limit Value.

Test Mode: TX N-40M Mode 2437 MHz

### Vertical

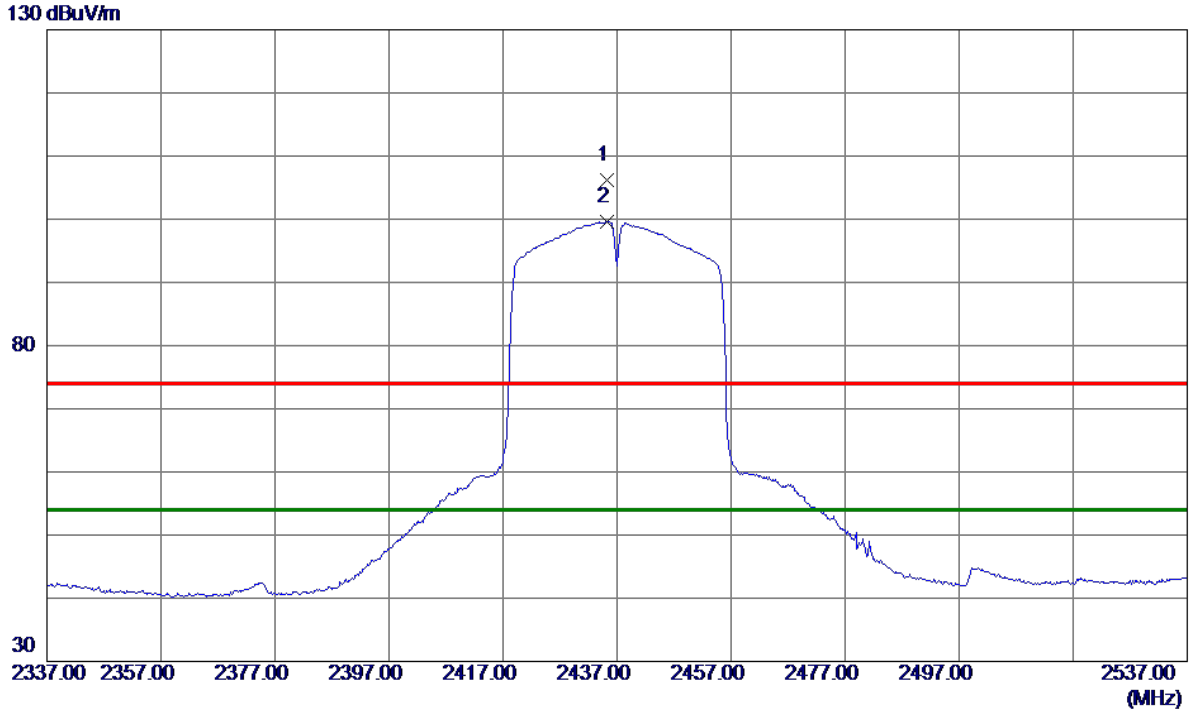

No.	Freq. MHz	Reading Level dBuV/m	Correct Factor dB	Measure ment dBuV/m	Limit dBuV/m	Margin dB	Detector	Comment
1	2435.2000	99.95	6.16	106.11	74.00	32.11	Peak	No Limit
2 *	2435.2000	93.45	6.16	99.61	54.00	45.61	AVG	No Limit

**REMARKS:**

(1) Measurement Value = Reading Level + Correct Factor.

(2) Margin Level = Measurement Value - Limit Value.

Test Mode: TX N-40M Mode 2437 MHz

### Vertical

80 dBuV/m

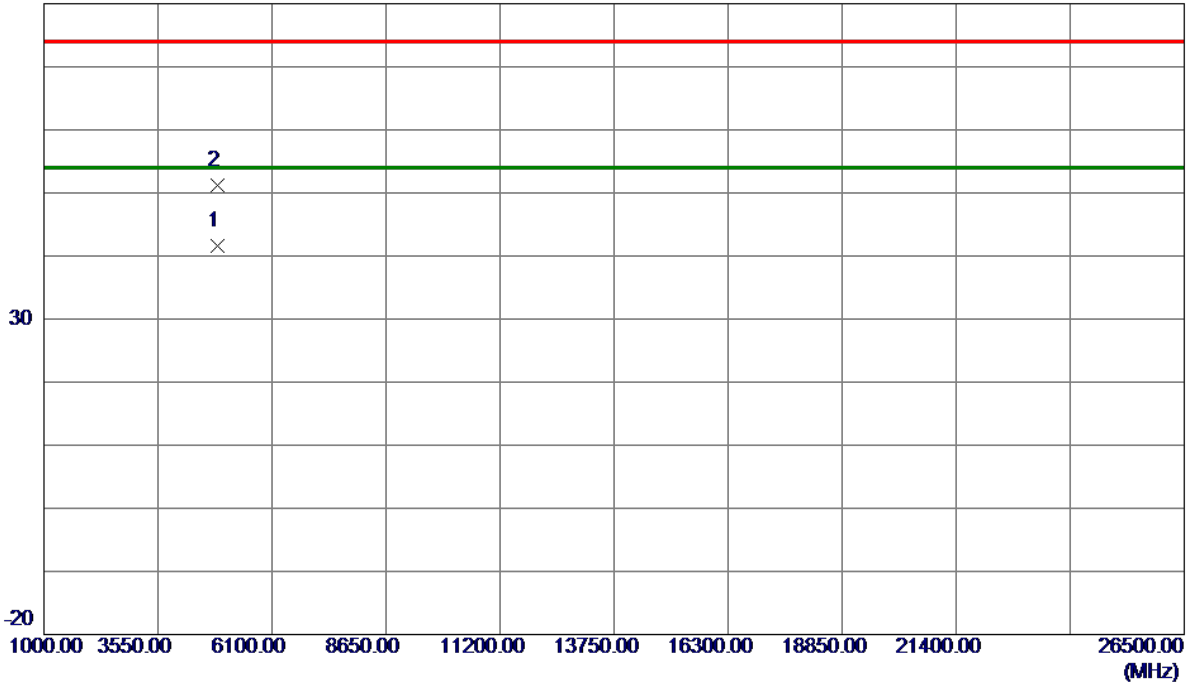

No.	Freq. MHz	Reading Level dBuV/m	Correct Factor dB	Measure ment dBuV/m	Limit dBuV/m	Margin dB	Detector	Comment
1 *	4874.1200	38.88	2.66	41.54	54.00	-12.46	AVG	
2	4874.8600	48.49	2.66	51.15	74.00	-22.85	Peak	

**REMARKS:**

- (1) Measurement Value = Reading Level + Correct Factor.
- (2) Margin Level = Measurement Value - Limit Value.

Test Mode: TX N-40M Mode 2437 MHz

### Horizontal

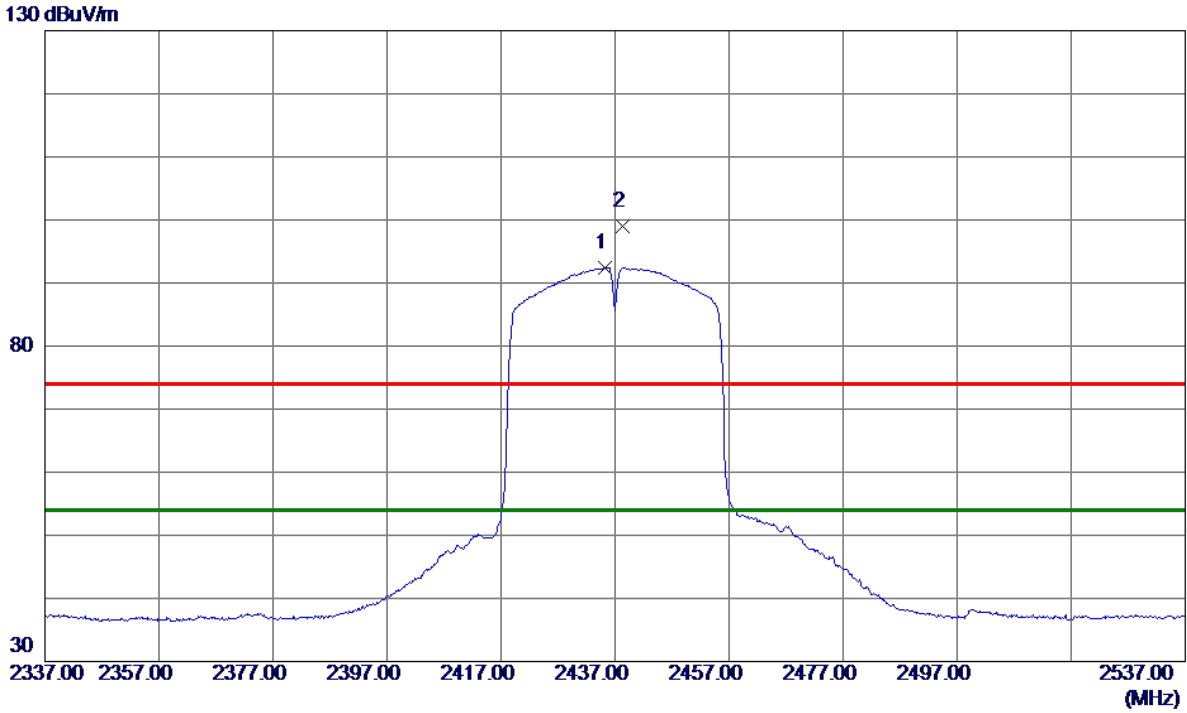

No.	Freq. MHz	Reading Level dBuV/m	Correct Factor dB	Measure ment dBuV/m	Limit dBuV/m	Margin dB	Detector	Comment
1 *	2435.3000	86.29	6.16	92.45	54.00	38.45	AVG	No Limit
2	2438.4000	92.87	6.16	99.03	74.00	25.03	Peak	No Limit

**REMARKS:**

- (1) Measurement Value = Reading Level + Correct Factor.
- (2) Margin Level = Measurement Value - Limit Value.

Test Mode: TX N-40M Mode 2437 MHz

### Horizontal

80 dBuV/m

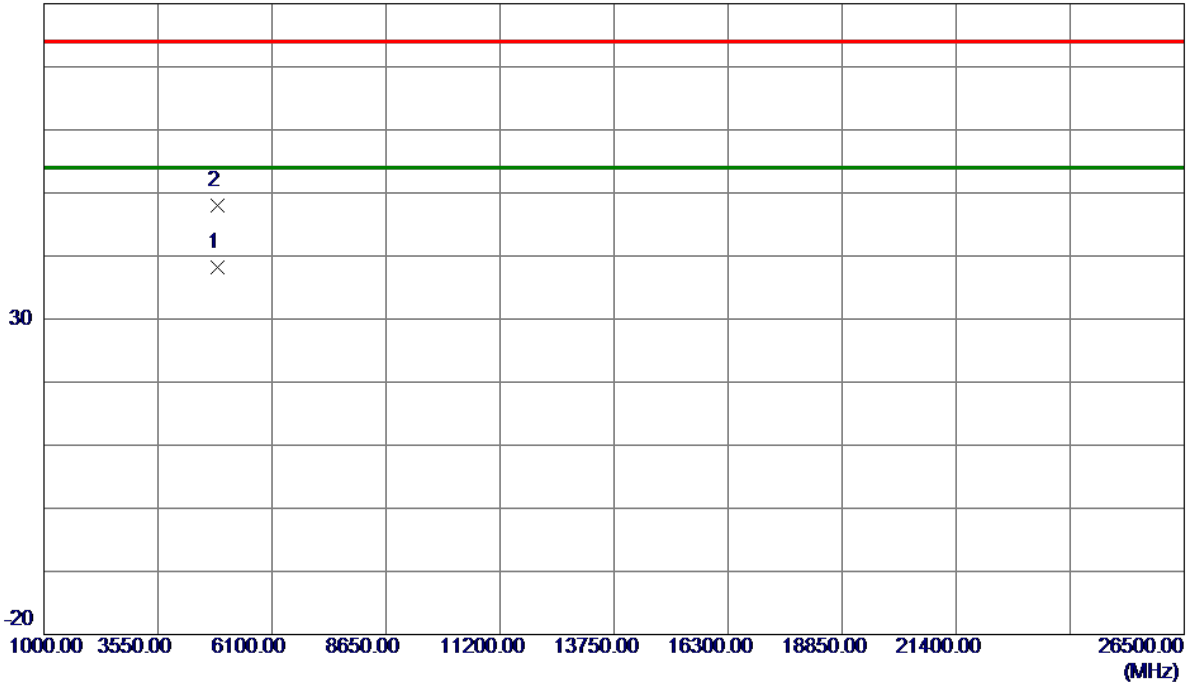

No.	Freq. MHz	Reading Level dBuV/m	Correct Factor dB	Measure ment dBuV/m	Limit dBuV/m	Margin dB	Detector	Comment
1 *	4873.9900	35.50	2.66	38.16	54.00	-15.84	AVG	
2	4874.8200	45.32	2.66	47.98	74.00	-26.02	Peak	

**REMARKS:**

(1) Measurement Value = Reading Level + Correct Factor.

(2) Margin Level = Measurement Value - Limit Value.

Test Mode: TX N-40M Mode 2452 MHz

### Vertical

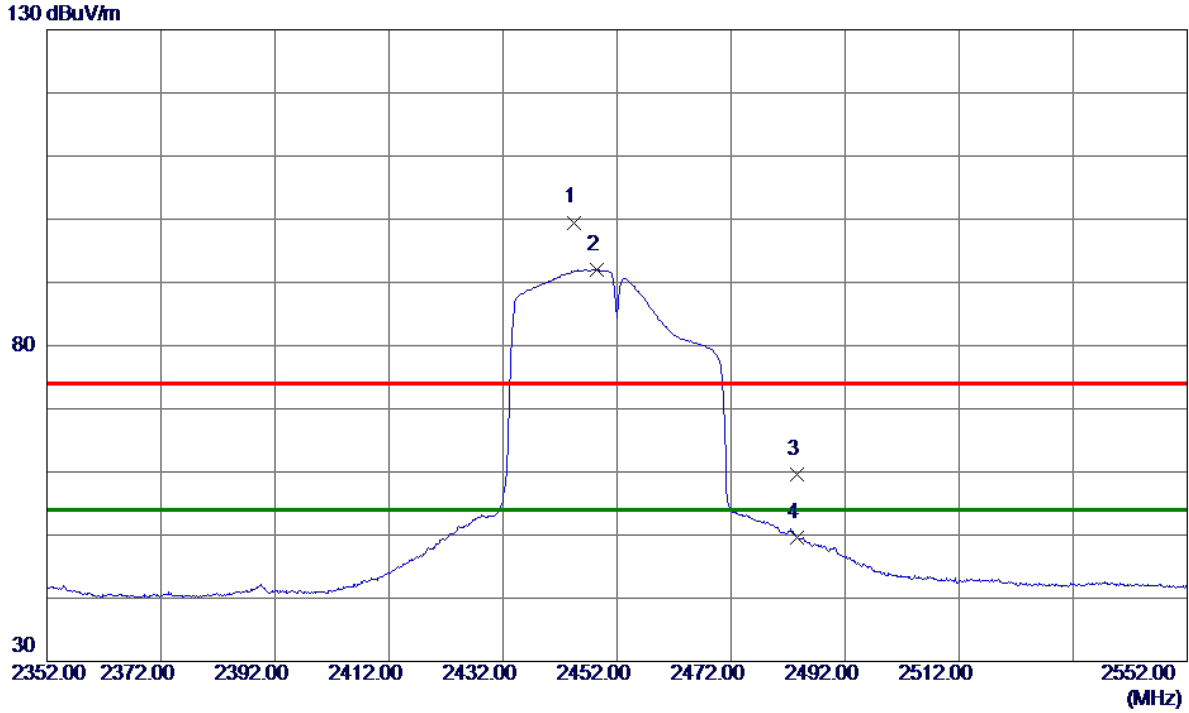

No.	Freq. MHz	Reading Level dBuV/m	Correct Factor dB	Measure ment dBuV/m	Limit dBuV/m	Margin dB	Detector	Comment
1	2444.5000	93.35	6.15	99.50	74.00	25.50	Peak	No Limit
2 *	2448.4000	85.85	6.14	91.99	54.00	37.99	AVG	No Limit
3	2483.5000	53.57	6.08	59.65	74.00	-14.35	Peak	
4	2483.5000	43.58	6.08	49.66	54.00	-4.34	AVG	

**REMARKS:**

- (1) Measurement Value = Reading Level + Correct Factor.
- (2) Margin Level = Measurement Value - Limit Value.



Test Mode: TX N-40M Mode 2452 MHz

### Vertical

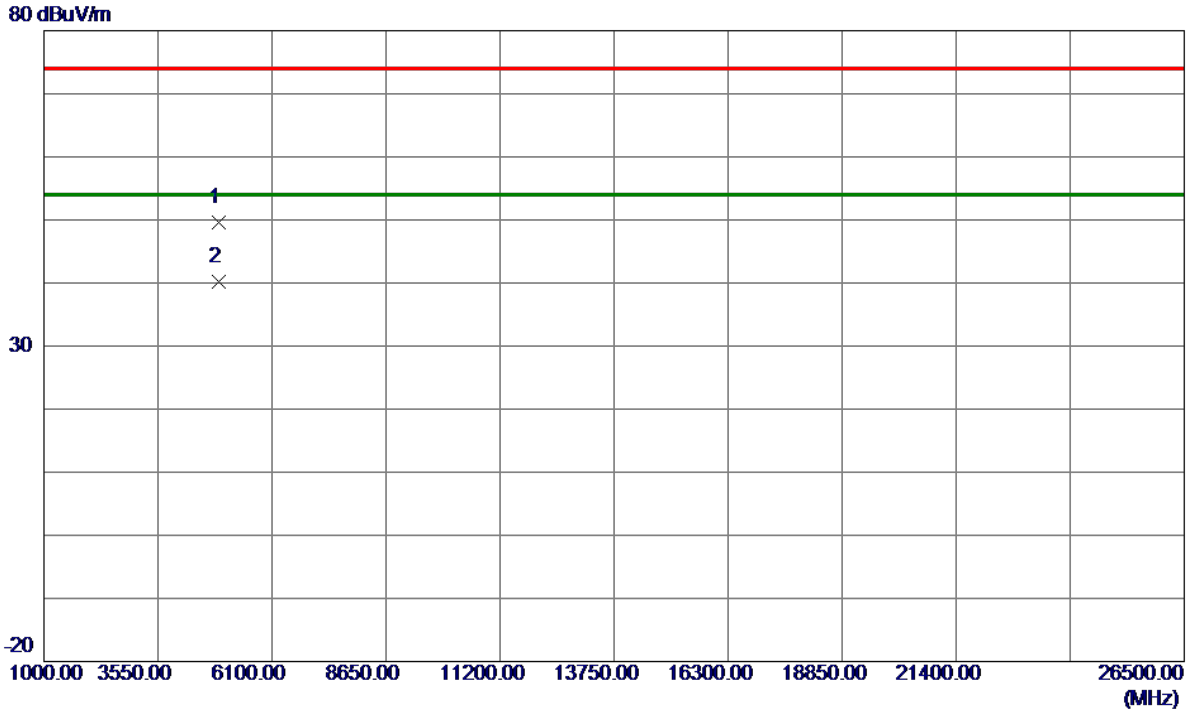

No.	Freq. MHz	Reading Level dBuV/m	Correct Factor dB	Measure ment dBuV/m	Limit dBuV/m	Margin dB	Detector	Comment
1	4903.9200	46.82	2.75	49.57	74.00	-24.43	Peak	
2 *	4904.0400	37.40	2.75	40.15	54.00	-13.85	AVG	

**REMARKS:**

- (1) Measurement Value = Reading Level + Correct Factor.
- (2) Margin Level = Measurement Value - Limit Value.

Test Mode: TX N-40M Mode 2452 MHz

### Horizontal

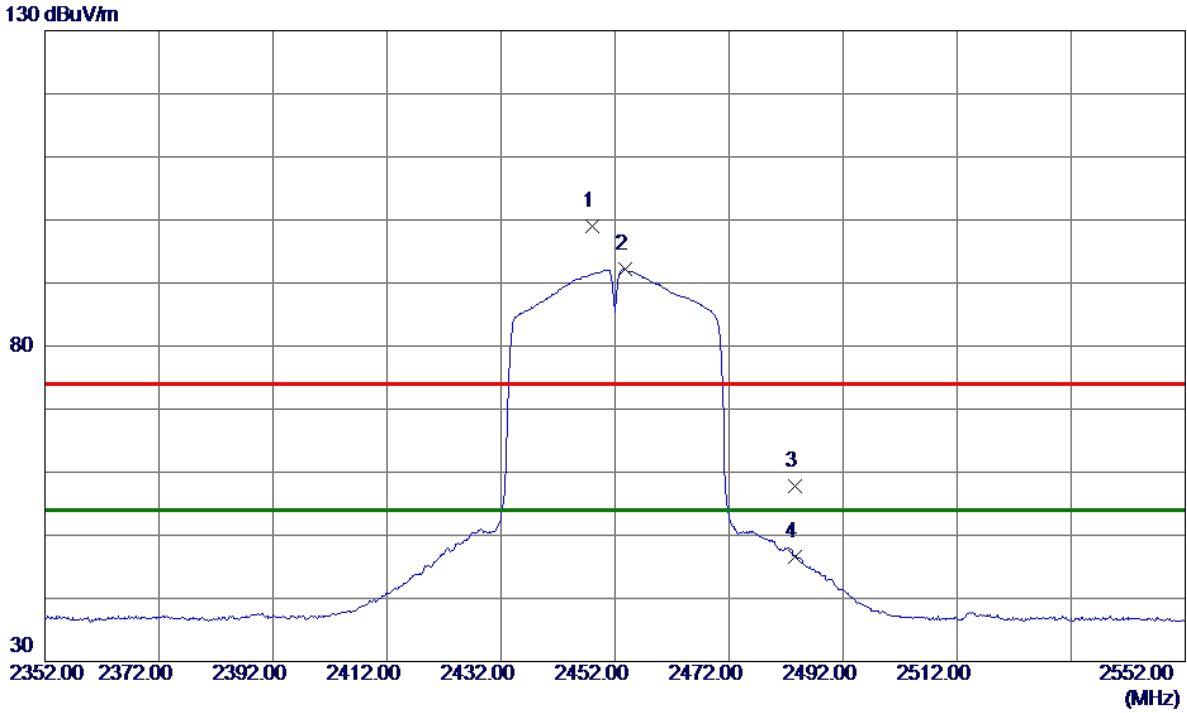

No.	Freq. MHz	Reading Level dBuV/m	Correct Factor dB	Measure ment dBuV/m	Limit dBuV/m	Margin dB	Detector	Comment
1	2448.0000	92.94	6.14	99.08	74.00	25.08	Peak	No Limit
2 *	2453.7000	86.10	6.13	92.23	54.00	38.23	AVG	No Limit
3	2483.5000	51.74	6.08	57.82	74.00	-16.18	Peak	
4	2483.5000	40.54	6.08	46.62	54.00	-7.38	AVG	

**REMARKS:**

- (1) Measurement Value = Reading Level + Correct Factor.
- (2) Margin Level = Measurement Value - Limit Value.

Test Mode: TX N-40M Mode 2452 MHz

### Horizontal

80 dBuV/m

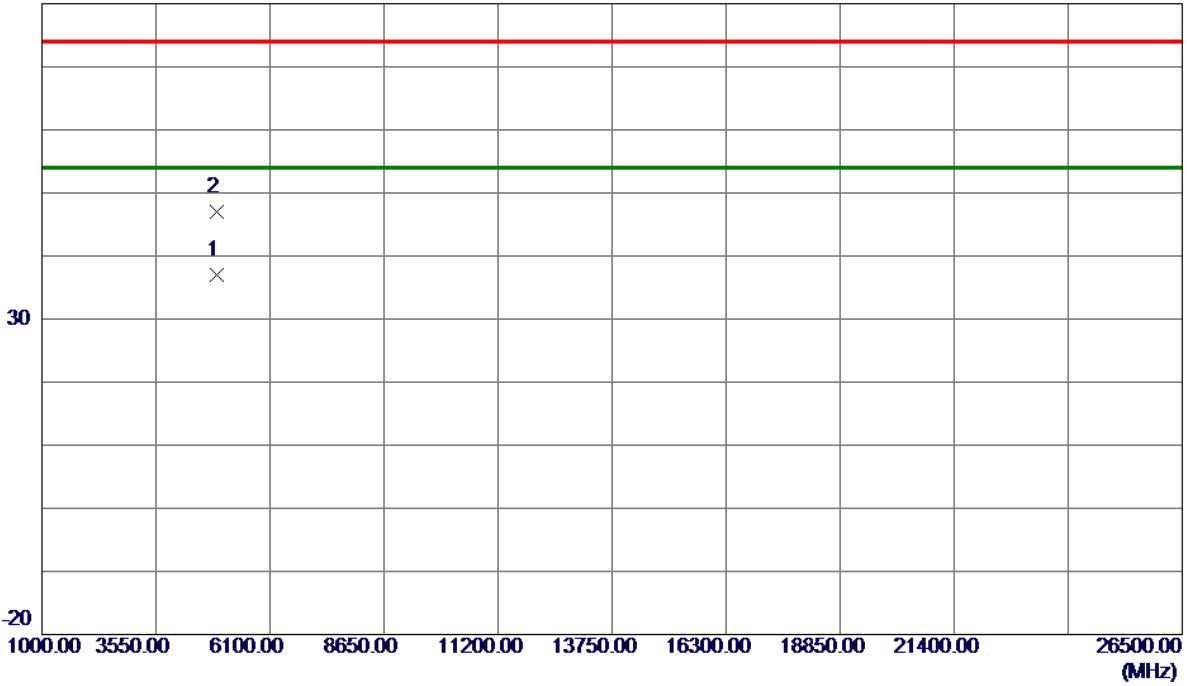

No.	Freq. MHz	Reading Level dBuV/m	Correct Factor dB	Measure ment dBuV/m	Limit dBuV/m	Margin dB	Detector	Comment
1 *	4904.4000	34.20	2.75	36.95	54.00	-17.05	AVG	
2	4904.7500	44.16	2.75	46.91	74.00	-27.09	Peak	

**REMARKS:**

- (1) Measurement Value = Reading Level + Correct Factor.
- (2) Margin Level = Measurement Value - Limit Value.

## APPENDIX E - BANDWIDTH

## Non-Beamforming

Test Mode	TX B Mode
-----------	-----------

Channel	Frequency (MHz)	6 dB Bandwidth (MHz)	6 dB Bandwidth Min. Limit (kHz)	Result
01	2412	10.19	500	Complies
06	2437	10.20	500	Complies
11	2462	10.20	500	Complies

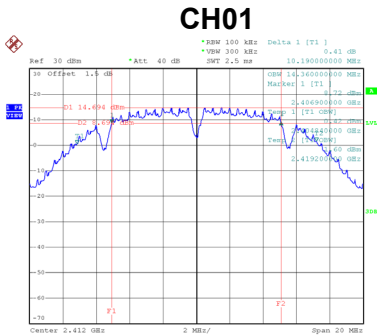

Date: 9\_SEP.2019 10:00:41

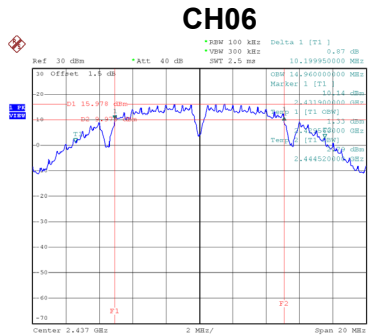

Date: 9\_SEP.2019 10:03:01

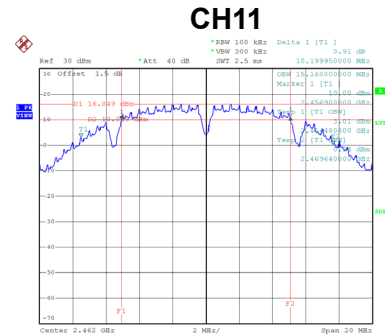

Date: 9\_SEP.2019 10:04:55

Channel	Frequency (MHz)	99 % Emission Bandwidth (MHz)	Result
01	2412	14.30	Complies
06	2437	15.90	Complies
11	2462	16.40	Complies

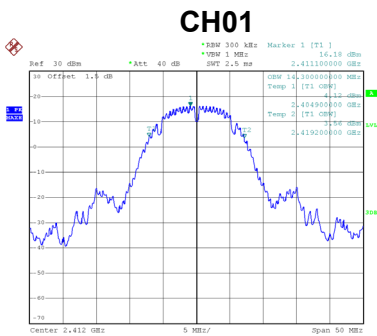

Date: 9\_SEP.2019 11:04:44

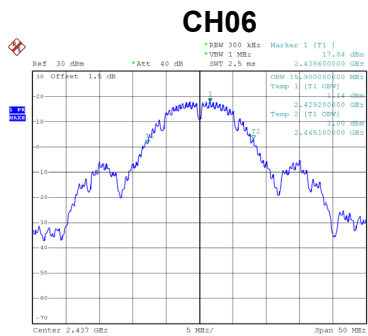

Date: 9\_SEP.2019 11:06:09

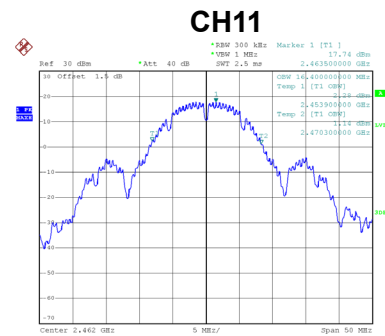

Date: 9\_SEP.2019 11:06:36



Test Mode	TX N-20M Mode
-----------	---------------

Channel	Frequency (MHz)	6 dB Bandwidth (MHz)	6 dB Bandwidth Min. Limit (kHz)	Result
01	2412	15.72	500	Complies
06	2437	16.38	500	Complies
11	2462	16.35	500	Complies

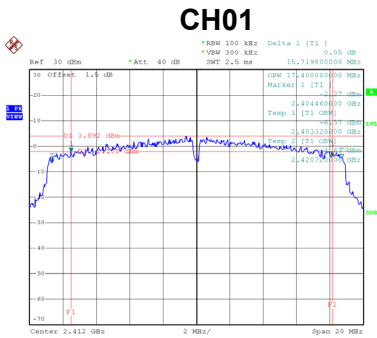

Date: 9.SEP.2019 10:18:36

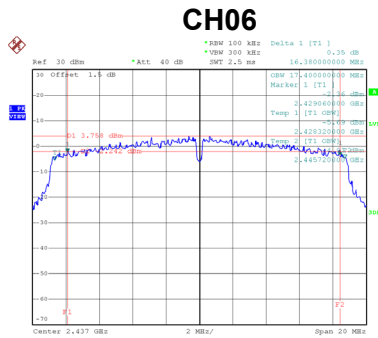

Date: 9.SEP.2019 10:19:54

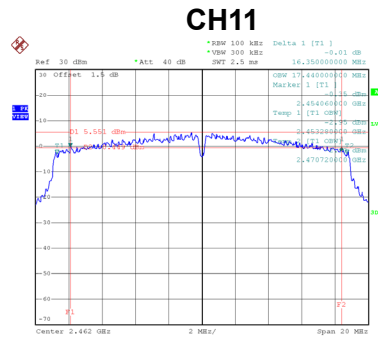

Date: 9.SEP.2019 10:21:18

Channel	Frequency (MHz)	99 % Emission Bandwidth (MHz)	Result
01	2412	17.50	Complies
06	2437	17.50	Complies
11	2462	17.50	Complies

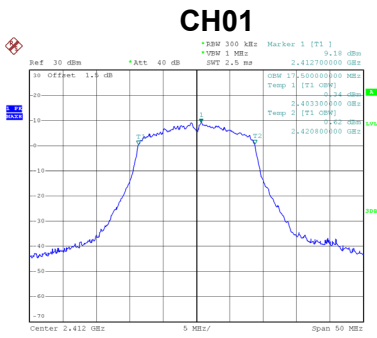

Date: 9.SEP.2019 11:10:47

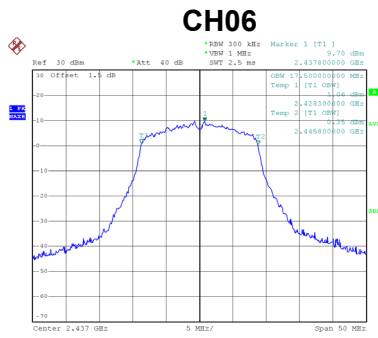

Date: 9.SEP.2019 11:11:12

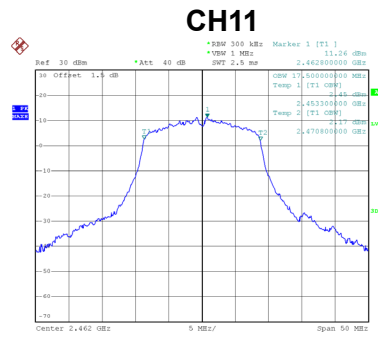

Date: 9.SEP.2019 11:13:41

Test Mode	TX N-40M Mode
-----------	---------------

Channel	Frequency (MHz)	6 dB Bandwidth (MHz)	6 dB Bandwidth Min. Limit (kHz)	Result
03	2422	31.44	500	Complies
06	2437	32.63	500	Complies
09	2452	32.72	500	Complies

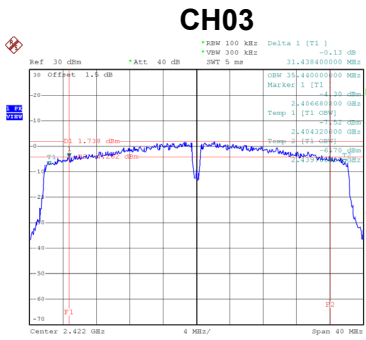

Date: 9.SEP.2019 10:22:57

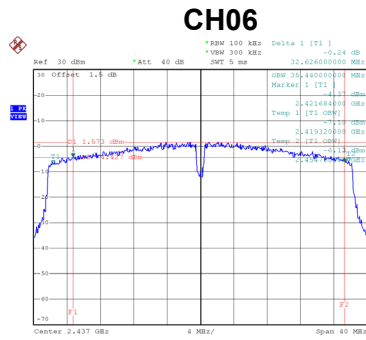

Date: 9.SEP.2019 10:24:45

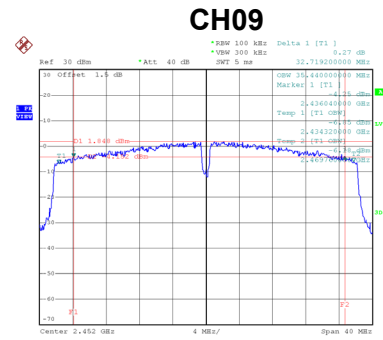

Date: 9.SEP.2019 10:26:16

Channel	Frequency (MHz)	99 % Emission Bandwidth (MHz)	Result
03	2422	35.40	Complies
06	2437	35.40	Complies
09	2452	35.40	Complies

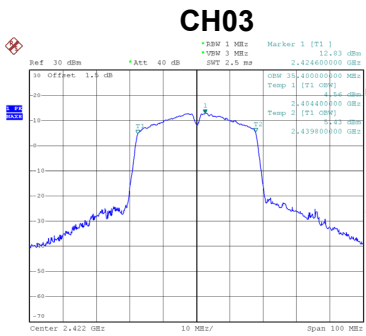

Date: 9.SEP.2019 11:14:52

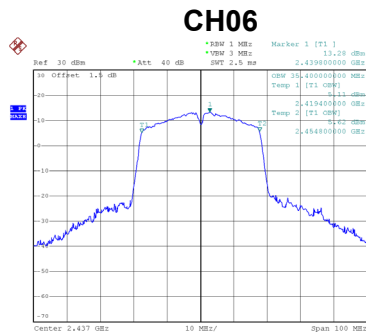

Date: 9.SEP.2019 11:15:19

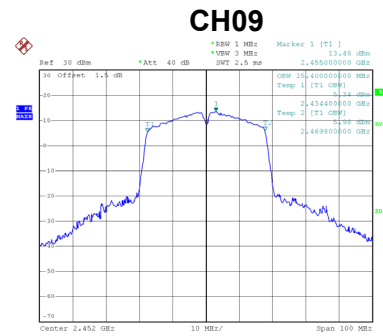

Date: 9.SEP.2019 11:15:56



## **APPENDIX F - MAXIMUM AVERAGE OUTPUT POWER**

### Non-Beamforming

Test Mode	TX B Mode
-----------	-----------

Channel	Frequency (MHz)	Output Power (dBm)	Output Power (W)	Max. Limit (dBm)	Max. Limit (W)	Result
01	2412	20.04	0.1009	30.00	1.0000	Complies
06	2437	19.89	0.0975	30.00	1.0000	Complies
11	2462	19.62	0.0916	30.00	1.0000	Complies

Test Mode	TX G Mode
-----------	-----------

Channel	Frequency (MHz)	Output Power (dBm)	Output Power (W)	Max. Limit (dBm)	Max. Limit (W)	Result
01	2412	20.53	0.1130	30.00	1.0000	Complies
06	2437	20.35	0.1084	30.00	1.0000	Complies
11	2462	20.22	0.1052	30.00	1.0000	Complies

Test Mode	TX N-20M Mode_Ant. 1
-----------	----------------------

Channel	Frequency (MHz)	Output Power (dBm)	Output Power (W)	Max. Limit (dBm)	Max. Limit (W)	Result
01	2412	17.91	0.0618	27.99	0.63	Complies
06	2437	17.23	0.0528	27.99	0.63	Complies
11	2462	17.59	0.0574	27.99	0.63	Complies

Test Mode	TX N-20M Mode_Ant. 2
-----------	----------------------

Channel	Frequency (MHz)	Output Power (dBm)	Output Power (W)	Max. Limit (dBm)	Max. Limit (W)	Result
01	2412	19.95	0.0989	27.99	0.63	Complies
06	2437	19.73	0.0940	27.99	0.63	Complies
11	2462	19.53	0.0897	27.99	0.63	Complies

Test Mode	TX N-20M Mode_Total
-----------	---------------------

Channel	Frequency (MHz)	Output Power (dBm)	Output Power (W)	Max. Limit (dBm)	Max. Limit (W)	Result
01	2412	22.06	0.1607	27.99	0.63	Complies
06	2437	21.67	0.1468	27.99	0.63	Complies
11	2462	21.68	0.1472	27.99	0.63	Complies

Test Mode	TX N-40M Mode_Ant. 1
-----------	----------------------

Channel	Frequency (MHz)	Output Power (dBm)	Output Power (W)	Max. Limit (dBm)	Max. Limit (W)	Result
03	2422	17.52	0.0565	27.99	0.63	Complies
06	2437	17.45	0.0556	27.99	0.63	Complies
09	2452	16.63	0.0460	27.99	0.63	Complies

Test Mode	TX N-40M Mode_Ant. 2
-----------	----------------------

Channel	Frequency (MHz)	Output Power (dBm)	Output Power (W)	Max. Limit (dBm)	Max. Limit (W)	Result
03	2422	19.09	0.0811	27.99	0.63	Complies
06	2437	18.74	0.0748	27.99	0.63	Complies
09	2452	16.54	0.0451	27.99	0.63	Complies

Test Mode	TX N-40M Mode_Total
-----------	---------------------

Channel	Frequency (MHz)	Output Power (dBm)	Output Power (W)	Max. Limit (dBm)	Max. Limit (W)	Result
03	2422	21.39	0.1376	27.99	0.63	Complies
06	2437	21.15	0.1304	27.99	0.63	Complies
09	2452	19.60	0.0911	27.99	0.63	Complies

### Beamforming

<b>Test Mode</b>	TX N-20M Mode_Ant. 1
------------------	----------------------

Channel	Frequency (MHz)	Output Power (dBm)	Output Power (W)	Max. Limit (dBm)	Max. Limit (W)	Result
01	2412	17.21	0.0526	28.00	0.63	Complies
06	2437	17.14	0.0518	28.00	0.63	Complies
11	2462	17.18	0.0522	28.00	0.63	Complies

<b>Test Mode</b>	TX N-20M Mode_Ant. 2
------------------	----------------------

Channel	Frequency (MHz)	Output Power (dBm)	Output Power (W)	Max. Limit (dBm)	Max. Limit (W)	Result
01	2412	19.41	0.0873	28.00	0.63	Complies
06	2437	18.89	0.0774	28.00	0.63	Complies
11	2462	18.73	0.0746	28.00	0.63	Complies

<b>Test Mode</b>	TX N-20M Mode_Total
------------------	---------------------

Channel	Frequency (MHz)	Output Power (dBm)	Output Power (W)	Max. Limit (dBm)	Max. Limit (W)	Result
01	2412	21.46	0.1399	28.00	0.63	Complies
06	2437	21.11	0.1292	28.00	0.63	Complies
11	2462	21.03	0.1269	28.00	0.63	Complies

Test Mode	TX N-40M Mode_Ant. 1
-----------	----------------------

Channel	Frequency (MHz)	Output Power (dBm)	Output Power (W)	Max. Limit (dBm)	Max. Limit (W)	Result
03	2422	16.91	0.0491	28.00	0.63	Complies
06	2437	16.85	0.0484	28.00	0.63	Complies
09	2452	16.03	0.0401	28.00	0.63	Complies

Test Mode	TX N-40M Mode_Ant. 2
-----------	----------------------

Channel	Frequency (MHz)	Output Power (dBm)	Output Power (W)	Max. Limit (dBm)	Max. Limit (W)	Result
03	2422	18.53	0.0713	28.00	0.63	Complies
06	2437	18.13	0.0650	28.00	0.63	Complies
09	2452	15.94	0.0393	28.00	0.63	Complies

Test Mode	TX N-40M Mode_Total
-----------	---------------------

Channel	Frequency (MHz)	Output Power (dBm)	Output Power (W)	Max. Limit (dBm)	Max. Limit (W)	Result
03	2422	20.81	0.1204	28.00	0.63	Complies
06	2437	20.55	0.1134	28.00	0.63	Complies
09	2452	19.00	0.0794	28.00	0.63	Complies

## **APPENDIX G - CONDUCTED SPURIOUS EMISSIONS**

## Non-Beamforming

Test Mode TX B Mode

### Bandedge-CH01

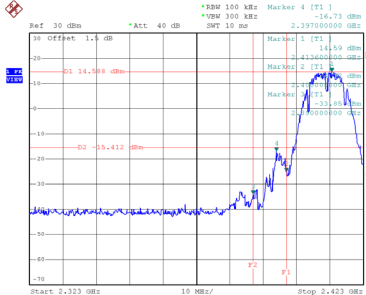

Date: 9.SEP.2019 10:00:51

### Bandedge-CH11

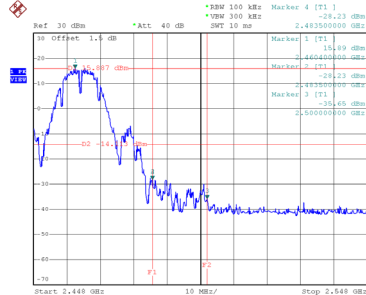

Date: 9.SEP.2019 10:05:04

### CH01 – 10th Harmonic of the fundamental frequency

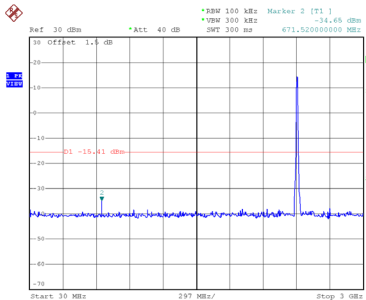

Date: 9.SEP.2019 10:01:05

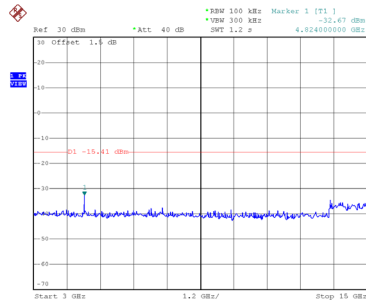

Date: 9.SEP.2019 10:01:14

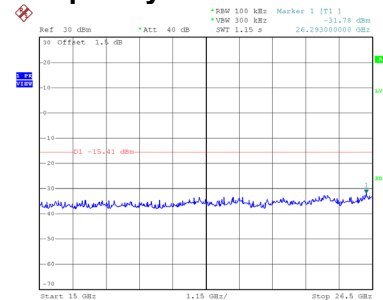

Date: 9.SEP.2019 10:01:22

### CH06 – 10th Harmonic of the fundamental frequency

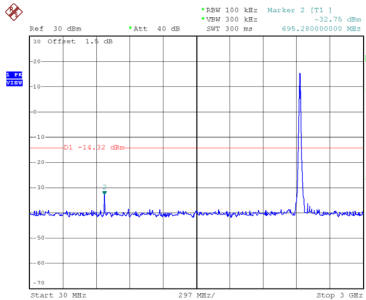

Date: 9.SEP.2019 10:03:22

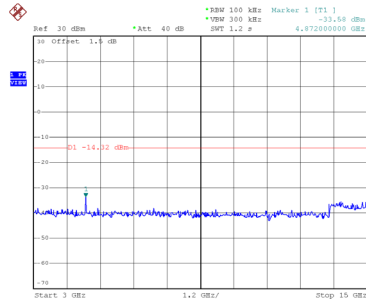

Date: 9.SEP.2019 10:03:30

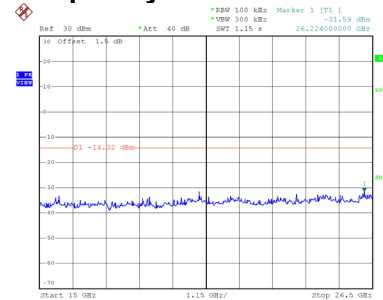

Date: 9.SEP.2019 10:03:38

### CH11 – 10th Harmonic of the fundamental frequency

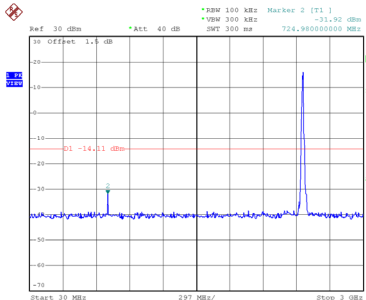

Date: 9.SEP.2019 10:05:17

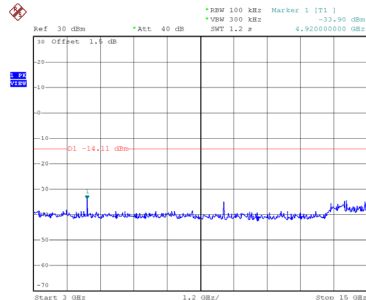

Date: 9.SEP.2019 10:05:26

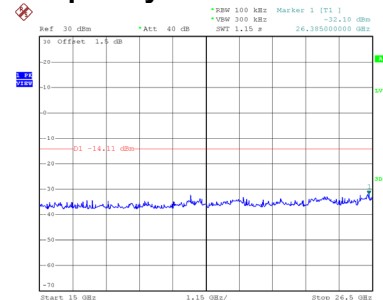

Date: 9.SEP.2019 10:05:34