

FCC Radio Test Report

FCC ID: V7TAC5V3

This report concerns: **Original Grant**

Project No. : 1912C183
Equipment : AC1200 Smart Dual-band WiFi Router
Brand Name : Tenda
Test Model : AC5
Series Model : N/A
Applicant : SHENZHEN TENDA TECHNOLOGY CO.,LTD
Address : 6-8 Floor, Tower E3, No. 1001, Zhongshanyuan Road, Nanshan District, Shenzhen, China. 518052
Manufacturer : SHENZHEN TENDA TECHNOLOGY CO.,LTD
Address : 6-8 Floor, Tower E3, No. 1001, Zhongshanyuan Road, Nanshan District, Shenzhen, China. 518052
Date of Receipt : Feb. 26, 2020
Date of Test : Feb. 27, 2020 ~ Feb. 28, 2020
Issued Date : Mar. 02, 2020
Report Version : R01
Test Sample : Engineering Sample No.: DG2019122778 for conducted, DG2019122777 for radiated.
Standard(s) : FCC Part15, Subpart E(15.407)
ANSI C63.10-2013
FCC KDB 789033 D02 General UNII Test Procedures New Rules v02r01
FCC KDB 662911 D01 Multiple Transmitter Output v02r01

The above equipment has been tested and found compliance with the requirement of the relative standards by BTL Inc.

Nick Chen

Prepared by : Nick Chen

Ethan Ma

Approved by : Ethan Ma



Certificate #5123.02

Add: No.3, Jinshagang 1st Road, Shixia, Dalang Town, Dongguan, Guangdong, China.

Tel: +86-769-8318-3000

Web: www.newbtl.com

Declaration

BTL represents to the client that testing is done in accordance with standard procedures as applicable and that test instruments used has been calibrated with standards traceable to international standard(s) and/or national standard(s).

BTL's reports apply only to the specific samples tested under conditions. It is manufacture's responsibility to ensure that additional production units of this model are manufactured with the identical electrical and mechanical components. **BTL** shall have no liability for any declarations, inferences or generalizations drawn by the client or others from **BTL** issued reports.

The report must not be used by the client to claim product certification, approval, or endorsement by NVLAP, NIST, A2LA, or any agency of the U.S. Government.

This report is the confidential property of the client. As a mutual protection to the clients, the public and ourselves, the test report shall not be reproduced, except in full, without our written approval.

BTL's laboratory quality assurance procedures are in compliance with the **ISO/IEC 17025** requirements, and accredited by the conformity assessment authorities listed in this test report.

BTL is not responsible for the sampling stage, so the results only apply to the sample as received.

The information, data and test plan are provided by manufacturer which may affect the validity of results, so it is manufacturer's responsibility to ensure that the apparatus meets the essential requirements of applied standards and in all the possible configurations as representative of its intended use.

Limitation

For the use of the authority's logo is limited unless the Test Standard(s)/Scope(s)/Item(s) mentioned in this test report is (are) included in the conformity assessment authorities acceptance respective.

Please note that the measurement uncertainty is provided for informational purpose only and are not use in determining the Pass/Fail results.

Table of Contents	Page
REPORT ISSUED HISTORY	6
1 . SUMMARY OF TEST RESULTS	7
1.1 TEST FACILITY	8
1.2 MEASUREMENT UNCERTAINTY	8
1.3 TEST ENVIRONMENT CONDITIONS	9
2 . GENERAL INFORMATION	10
2.1 GENERAL DESCRIPTION OF EUT	10
2.2 TEST MODES	13
2.3 PARAMETERS OF TEST SOFTWARE	15
2.4 DUTY CYCLE	17
2.5 BLOCK DIAGRAM SHOWING THE CONFIGURATION OF SYSTEM TESTED	19
2.6 SUPPORT UNITS	19
3 . AC POWER LINE CONDUCTED EMISSIONS TEST	20
3.1 LIMIT	20
3.2 TEST PROCEDURE	20
3.3 DEVIATION FROM TEST STANDARD	20
3.4 TEST SETUP	21
3.5 EUT OPERATION CONDITIONS	21
3.6 TEST RESULTS	21
4 . RADIATED EMISSIONS TEST	22
4.1 LIMIT	22
4.2 TEST PROCEDURE	23
4.3 DEVIATION FROM TEST STANDARD	23
4.4 TEST SETUP	24
4.5 EUT OPERATION CONDITIONS	26
4.6 TEST RESULTS - 9 KHZ to 30 MHZ	26
4.7 TEST RESULTS - 30 MHz TO 1000 MHz	26
4.8 TEST RESULTS - ABOVE 1000 MHz	26
5 . BANDWIDTH TEST	27
5.1 LIMIT	27
5.2 TEST PROCEDURE	27
5.3 DEVIATION FROM TEST STANDARD	27

Table of Contents	Page
5.4 TEST SETUP	28
5.5 EUT OPERATION CONDITIONS	28
5.6 TEST RESULTS	28
6 . CONDUCTED OUTPUT POWER TEST	29
6.1 LIMIT	29
6.2 TEST PROCEDURE	30
6.3 DEVIATION FROM STANDARD	30
6.4 TEST SETUP	30
6.5 EUT OPERATION CONDITIONS	30
6.6 TEST RESULTS	30
7 . POWER SPECTRAL DENSITY TEST	31
7.1 LIMIT	31
7.2 TEST PROCEDURE	31
7.3 DEVIATION FROM STANDARD	31
7.4 TEST SETUP	32
7.5 EUT OPERATION CONDITIONS	32
7.6 TEST RESULTS	32
8 . FREQUENCY STABILITY MEASUREMENT	33
8.1 LIMIT	33
8.2 TEST PROCEDURE	33
8.3 DEVIATION FROM STANDARD	33
8.4 TEST SETUP	34
8.5 EUT OPERATION CONDITIONS	34
8.6 TEST RESULTS	34
9 . MEASUREMENT INSTRUMENTS LIST	35
10 . EUT TEST PHOTOS	37
APPENDIX A - AC POWER LINE CONDUCTED EMISSIONS	41
APPENDIX B - RADIATED EMISSION - 9 KHZ TO 30 MHZ	46
APPENDIX C - RADIATED EMISSION - 30 MHZ TO 1 GHZ	51
APPENDIX D - RADIATED EMISSION - ABOVE 1000 MHZ	54
APPENDIX D - RADIATED EMISSION - ABOVE 1000 MHZ	57
APPENDIX E - BANDWIDTH	132

Table of Contents**Page****APPENDIX F - CONDUCTED OUTPUT POWER****151****APPENDIX G - POWER SPECTRAL DENSITY****173****APPENDIX H - FREQUENCY STABILITY****191**

REPORT ISSUED HISTORY

Report Version	Description	Issued Date
R00	Original Issue.	Feb. 11, 2020
R01	Modified the comments of TCB.	Mar. 02, 2020

1. SUMMARY OF TEST RESULTS

Test procedures according to the technical standard(s):

FCC Part15, Subpart E(15.407)				
Standard(s) Section	Test Item	Test Result	Judgement	Remark
15.207 15.407(b)	AC Power Line Conducted Emissions	APPENDIX A	PASS	-----
15.407(b) 15.205(a) 15.209(a)	Radiated Emissions	APPENDIX B APPENDIX C APPENDIX D	PASS	-----
15.407(a) 15.407(e)	Spectrum Bandwidth	APPENDIX E	PASS	-----
15.407(a)	Maximum Output Power	APPENDIX F	PASS	-----
15.407(a)	Power Spectral Density	APPENDIX G	PASS	-----
15.407(g)	Frequency Stability	APPENDIX H	PASS	-----
15.203	Antenna Requirements	-----	PASS	NOTE (3)
15.407(c)	Automatically Discontinue Transmission	-----	PASS	NOTE (3)

Note:

- (1) "N/A" denotes test is not applicable in this test report.
- (2) The device what use a permanently attached antenna were considered sufficient to comply with the provisions of 15.203.
- (3) During no any information transmission, the EUT can automatically discontinue transmission and become standby mode for power saving. the EUT can detect the controlling signal of ACK message transmitting from remote device and verify whether it shall resend or discontinue transmission.
- (4) For UNII-1 this device was functioned as a
 Access point device Client device

1.1 TEST FACILITY

The test facilities used to collect the test data in this report is at the location of No.3,Jinshagang 1st Road, Shixia, Dalang Town, Dongguan, Guangdong, China.

BTL's Test Firm Registration Number for FCC: 357015

BTL's Designation Number for FCC: CN1240

1.2 MEASUREMENT UNCERTAINTY

ISO/IEC 17025 requires that an estimate of the measurement uncertainties associated with the emissions test results be included in the report. The measurement uncertainties given below are based on a 95% confidence level (based on a coverage factor (k=2))

The BTL measurement uncertainty as below table:

A. AC power line conducted emissions test:

Test Site	Method	Measurement Frequency Range	U, (dB)
DG-C02	CISPR	150kHz ~ 30MHz	2.60

B. Radiated emissions test:

Test Site	Method	Measurement Frequency Range	Ant. H / V	U, (dB)
DG-CB03	CISPR	9kHz ~ 30MHz	V	3.79
		9kHz ~ 30MHz	H	3.57
		30MHz ~ 200MHz	V	4.88
		30MHz ~ 200MHz	H	4.14
		200MHz ~ 1,000MHz	V	4.62
		200MHz ~ 1,000MHz	H	4.80
		1GHz ~ 6GHz	-	4.58
		6GHz ~ 18GHz	-	5.18
		18GHz ~ 26.5GHz	-	3.62
		26.5GHz ~ 40GHz	-	4.00

Note: Unless specifically mentioned, the uncertainty of measurement has not been taken into account to declare the compliance or non-compliance to the specification.

1.3 TEST ENVIRONMENT CONDITIONS

Test Item	Temperature	Humidity	Test Voltage	Tested By
AC Power Line Conducted Emissions	25°C	53%	AC 120V/60Hz AC 240V/50Hz	Laughing Zhan
Radiated Emissions-9K-30MHz	24°C	68%	AC 120V/60Hz	Laughing Zhang
Radiated Emissions-30 MHz to 1GHz	24°C	68%	AC 120V/60Hz	Laughing Zhang
Radiated Emissions-Above 1000 MHz	24°C	68%	AC 120V/60Hz	Laughing Zhang
Spectrum Bandwidth	25°C	60%	DC 9V	Jonas Chen
Maximum Output Power	25°C	60%	DC 9V	Damon Deng
Power Spectral Density	25°C	60%	DC 9V	Jonas Chen
Frequency Stability	Normal & Extreme	60%	Normal & Extreme	Jonas Chen

2. GENERAL INFORMATION

2.1 GENERAL DESCRIPTION OF EUT

Equipment	AC1200 Smart Dual-band WiFi Router
Brand Name	Tenda
Test Model	AC5
Series Model	N/A
Model Difference(s)	N/A
Power Source	DC voltage supplied from AC/DC adapter. Model: BN052-A09009E
Power Rating	I/P: 100-240V~50/60Hz 0.3A O/P: 9V \equiv 1.0A
Operation Frequency	UNII-1: 5150 MHz~5250 MHz UNII-3: 5725 MHz~5850 MHz
Modulation Type	OFDM
Bit Rate of Transmitter	Up to 866.7 Mbps
Maximum Conducted Output Power for UNII-1 Non-Beamforming	IEEE 802.11a: 18.64 dBm (0.0731 W) IEEE 802.11n (HT20): 19.03 dBm (0.0800 W) IEEE 802.11n (HT40): 19.44 dBm (0.0879 W) IEEE 802.11ac (VHT20): 18.97 dBm (0.0789 W) IEEE 802.11ac (VHT40): 20.35 dBm (0.1084 W) IEEE 802.11ac (VHT80): 18.74 dBm (0.0748 W)
Maximum Conducted Output Power for UNII-3 Non-Beamforming	IEEE 802.11a: 12.90 dBm (0.0195 W) IEEE 802.11n (HT20): 15.05 dBm (0.0320 W) IEEE 802.11n (HT40): 16.16 dBm (0.0413 W) IEEE 802.11ac (VHT20): 14.92 dBm (0.0310 W) IEEE 802.11ac (VHT40): 17.12 dBm (0.0515 W) IEEE 802.11ac (VHT80): 18.32 dBm (0.0679 W)
Maximum Conducted Output Power for UNII-1 Beamforming	IEEE 802.11n (HT20): 18.85 dBm (0.0767 W) IEEE 802.11n (HT40): 19.30 dBm (0.0851 W) IEEE 802.11ac (VHT20): 18.85 dBm (0.0767 W) IEEE 802.11ac (VHT40): 20.25 dBm (0.1059 W) IEEE 802.11ac (VHT80): 18.59 dBm (0.0723 W)
Maximum Conducted Output Power for UNII-3 Beamforming	IEEE 802.11n (HT20): 14.95 dBm (0.0313 W) IEEE 802.11n (HT40): 16.06 dBm (0.0404 W) IEEE 802.11ac (VHT20): 14.81 dBm (0.0303 W) IEEE 802.11ac (VHT40): 17.05 dBm (0.0507 W) IEEE 802.11ac (VHT80): 18.01 dBm (0.0632 W)

Note:

1. For a more detailed features description, please refer to the manufacturer's specifications or the user's manual.

2. Channel List:

IEEE 802.11a IEEE 802.11n (HT20) IEEE 802.11ac (VHT20)		IEEE 802.11n (HT40) IEEE 802.11ac (VHT40)		IEEE 802.11ac (VHT80)	
UNII-1		UNII-1		UNII-1	
Channel	Frequency (MHz)	Channel	Frequency (MHz)	Channel	Frequency (MHz)
36	5180	38	5190	42	5210
40	5200	46	5230		
44	5220				
48	5240				

IEEE 802.11a IEEE 802.11n (HT20) IEEE 802.11ac (VHT20)		IEEE 802.11n (HT40) IEEE 802.11ac (VHT40)		IEEE 802.11ac (VHT80)	
UNII-3		UNII-3		UNII-3	
Channel	Frequency (MHz)	Channel	Frequency (MHz)	Channel	Frequency (MHz)
149	5745	151	5755	155	5775
153	5765	159	5795		
157	5785				
161	5805				
165	5825				

3. Antenna Specification:

Ant.	Brand	Model Name	Antenna Type	Connector	Gain (dBi)
1	N/A	N/A	Dipole	N/A	5
2	N/A	N/A	Dipole	N/A	5

Note:

(1) For Non-Beamforming Function:

Antenna Gain=5 dBi. This EUT supports MIMO 2X2, any transmit signals are correlated with each other, so Directional gain = $G_{Ant.} + 10\log(N)$ dBi, that is Directional gain = $5 + 10\log(2)$ dBi = 8.01. So, the UNII-1, UNII-3 output power limit is $30 - (8.01 - 6) = 27.99$. The UNII-1 power spectral density limit is $17 - (8.01 - 6) = 14.99$, the UNII-3 power spectral density limit is $30 - (8.01 - 6) = 27.99$.

(2) For Beamforming Function:

Beamforming Gain=3 dBi, Directional gain=3+5=8 dBi. So, the UNII-1, UNII-3 output power limit is $30 - (8 - 6) = 28$. The UNII-1 power spectral density limit is $17 - (8 - 6) = 15$, the UNII-3 power spectral density limit is $30 - (8 - 6) = 28$.

4. Table for Antenna Configuration:

For Non Beamforming:

Operating Mode	TX Mode	1TX	2TX
IEEE 802.11a		V (Ant. 1)	
IEEE 802.11n (HT20)			V (Ant. 1 + Ant. 2)
IEEE 802.11n (HT40)		-	V (Ant. 1 + Ant. 2)
IEEE 802.11ac (VHT20)			V (Ant. 1 + Ant. 2)
IEEE 802.11ac (VHT40)			V (Ant. 1 + Ant. 2)
IEEE 802.11ac (VHT80)			V (Ant. 1 + Ant. 2)

For Beamforming:

Operating Mode	TX Mode	2TX
IEEE 802.11n (HT20)		V (Ant. 1 + Ant. 2)
IEEE 802.11n (HT40)		V (Ant. 1 + Ant. 2)
IEEE 802.11ac (VHT20)		V (Ant. 1 + Ant. 2)
IEEE 802.11ac (VHT40)		V (Ant. 1 + Ant. 2)
IEEE 802.11ac (VHT80)		V (Ant. 1 + Ant. 2)

2.2 TEST MODES

The test system was pre-tested based on the consideration of all possible combinations of EUT operation mode.

Pretest Mode	Description
Mode 1	TX A Mode / CH36, CH40, CH48 (UNII-1)
Mode 2	TX N (HT20) Mode / CH36, CH40, CH48 (UNII-1)
Mode 3	TX N (HT40) Mode / CH38, CH46 (UNII-1)
Mode 4	TX AC (VHT20) Mode / CH36, CH40, CH48 (UNII-1)
Mode 5	TX AC (VHT40) Mode / CH38, CH46 (UNII-1)
Mode 6	TX AC (VHT80) Mode / CH42 (UNII-1)
Mode 7	TX A Mode / CH149,CH157,CH165 (UNII-3)
Mode 8	TX N (HT20) Mode / CH149,CH157,CH165 (UNII-3)
Mode 9	TX N (HT40) Mode / CH151,CH159 (UNII-3)
Mode 10	TX AC (VHT20) Mode / CH149,CH157,CH165 (UNII-3)
Mode 11	TX AC (VHT40) Mode / CH151,CH159 (UNII-3)
Mode 12	TX AC (VHT80) Mode / CH155 (UNII-3)
Mode 13	TX AC(VHT40) Mode / CH38 (UNII-1)

Following mode(s) was (were) found to be the worst case(s) and selected for the final test.

AC power line conducted emissions test	
Final Test Mode	Description
Mode 13	TX AC(VHT40) Mode / CH38 (UNII-1)

Radiated emissions test – Below 1GHz	
Final Test Mode	Description
Mode 13	TX AC(VHT40) Mode / CH38 (UNII-1)

Radiated emissions test – Above 1GHz	
Final Test Mode	Description
Mode 1	TX A Mode / CH36, CH40, CH48 (UNII-1)
Mode 2	TX AC (VHT20) Mode / CH36, CH40, CH48 (UNII-1)
Mode 3	TX AC (VHT40) Mode / CH38, CH46 (UNII-1)
Mode 4	TX AC (VHT80) Mode / CH42 (UNII-1)
Mode 5	TX A Mode / CH149,CH157,CH165 (UNII-3)
Mode 6	TX AC (VHT20) Mode / CH149,CH157,CH165 (UNII-3)
Mode 7	TX AC (VHT40) Mode / CH151,CH159 (UNII-3)
Mode 8	TX AC (VHT80) Mode / CH155 (UNII-3)

Conducted test	
Test Mode	Description
Mode 1	TX A Mode / CH36, CH40, CH48 (UNII-1)
Mode 2	TX AC (VHT20) Mode / CH36, CH40, CH48 (UNII-1)
Mode 3	TX AC (VHT40) Mode / CH38, CH46 (UNII-1)
Mode 4	TX AC (VHT80) Mode / CH42 (UNII-1)
Mode 5	TX A Mode / CH149,CH157,CH165 (UNII-3)
Mode 6	TX AC (VHT20) Mode / CH149,CH157,CH165 (UNII-3)
Mode 7	TX AC (VHT40) Mode / CH151,CH159 (UNII-3)
Mode 8	TX AC (VHT80) Mode / CH155 (UNII-3)

Note:

- (1) For radiated emission below 1 GHz test, the IEEE 802.11ac40 is found to be the worst case and recorded.
- (2) For radiated emission above 1 GHz test, 1GHz~26.5GHz and 26.5GHz~40GHz have been pre-tested and in this report only recorded the worst case. The remaining spurious points are all below the limit value of 20dB.
- (3) The measurements for Power were tested, the worst case were IEEE 802.11a mode, IEEE 802.11ac(VHT20) mode, IEEE 802.11ac(VHT40) mode, IEEE 802.11ac(VHT80), only worst case were documented for other test items except Bandwidth.
- (4) The measurements for Power were tested, the worst case were Non - Beamforming, only worst case were documented for other test items.
- (5) For radiated emissions, the WLAN 2.4G G Mode 2412MHz+RLAN 5G AC 40 Mode 5190MHz was found the worst case of simultaneous transmission and recorded.

2.3 PARAMETERS OF TEST SOFTWARE

Non-Beamforming

UNII-1			
Test Software	MP_TEST		
Test Frequency (MHz)	5180	5200	5240
IEEE 802.11a	102	86	83
IEEE 802.11n (HT20)	92/92	87/87	83/83
IEEE 802.11ac (VHT20)	92/92	86/86	87/87
Test Frequency (MHz)	5190	5230	
IEEE 802.11n (HT40)	93/93	93/93	
IEEE 802.11ac (VHT40)	94/94	94/94	
Test Frequency (MHz)	5210		
IEEE 802.11ac (VHT80)	90/90		

UNII-3			
Test Software	MP_TEST		
Test Frequency (MHz)	5745	5785	5825
IEEE 802.11a	74	74	75
IEEE 802.11n (HT20)	73/73	72/72	75/75
IEEE 802.11ac (VHT20)	71/71	72/72	74/74
Test Frequency (MHz)	5755	5795	
IEEE 802.11n (HT40)	77/77	80/80	
IEEE 802.11ac (VHT40)	77/77	81/81	
Test Frequency (MHz)	5775		
IEEE 802.11ac (VHT80)	90/90		

Beamforming

UNII-1			
Test Software	MP_TEST		
Test Frequency (MHz)	5180	5200	5240
IEEE 802.11n (HT20)	92/92	87/87	83/83
IEEE 802.11ac (VHT20)	92/92	86/86	87/87
Test Frequency (MHz)	5190	5230	5240
IEEE 802.11n (HT40)	93/93	93/93	83/83
IEEE 802.11ac (VHT40)	94/94	94/94	83/83
Test Frequency (MHz)	5210	5230	5240
IEEE 802.11ac (VHT80)	90/90	83/83	83/83

UNII-3			
Test Software	MP_TEST		
Test Frequency (MHz)	5745	5785	5825
IEEE 802.11n (HT20)	73/73	72/72	75/75
IEEE 802.11ac (VHT20)	71/71	72/72	74/74
Test Frequency (MHz)	5755	5795	5825
IEEE 802.11n (HT40)	77/77	80/80	75/75
IEEE 802.11ac (VHT40)	77/77	81/81	75/75
Test Frequency (MHz)	5775	5795	5825
IEEE 802.11ac (VHT80)	90/90	83/83	83/83

2.4 DUTY CYCLE

If duty cycle is $\geq 98\%$, duty factor is not required.
 If duty cycle is $< 98\%$, duty factor shall be considered.
 The output power = measured power + duty factor.

IEEE 802.11a

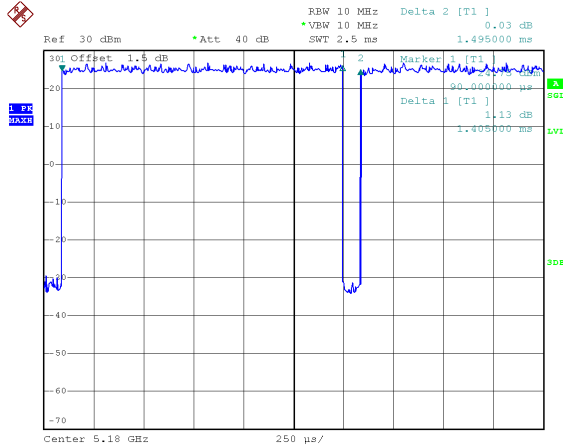

Date: 3.JAN.2020 15:30:06

Duty cycle = 1.405 ms / 1.495 ms = 93.98%
 Duty Factor = $10 \log(1 / \text{Duty cycle}) = 0.27$

IEEE 802.11n (HT20)

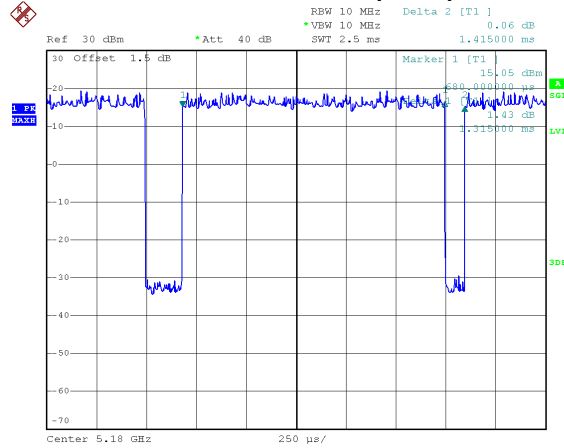

Date: 3.JAN.2020 15:30:35

Duty cycle = 1.315 ms / 1.415 ms = 92.93%
 Duty Factor = $10 \log(1 / \text{Duty cycle}) = 0.32$

IEEE 802.11n (HT40)

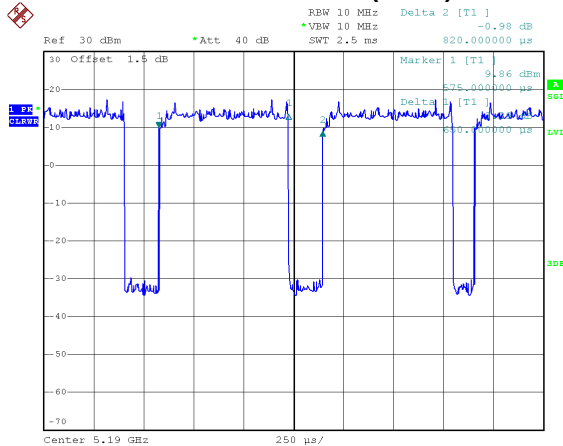

Date: 3.JAN.2020 15:32:05

Duty cycle = 0.650 ms / 0.820 ms = 79.27%
 Duty Factor = $10 \log(1 / \text{Duty cycle}) = 1.01$

IEEE 802.11ac (VHT20)

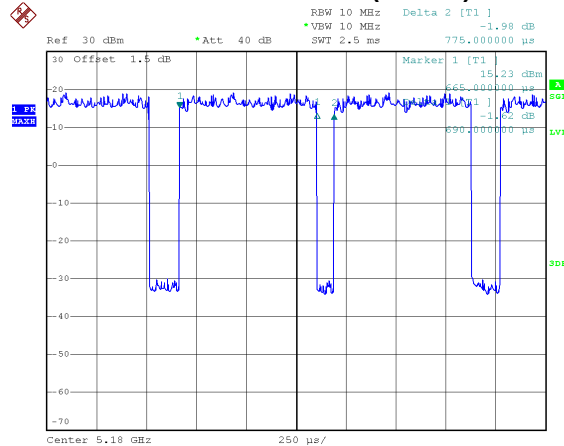

Date: 3.JAN.2020 15:31:07

Duty cycle = 0.690 ms / 0.775 ms = 89.03%
 Duty Factor = $10 \log(1 / \text{Duty cycle}) = 0.50$

IEEE 802.11ac (VHT40)

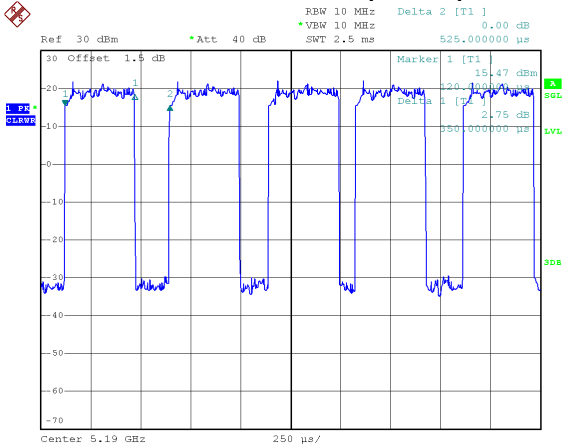

Date: 3.JAN.2020 15:32:47

Duty cycle = 0.350 ms / 0.525 ms = 66.67%
 Duty Factor = 10 log(1 / Duty cycle) = 1.76

IEEE 802.11ac (VHT80)

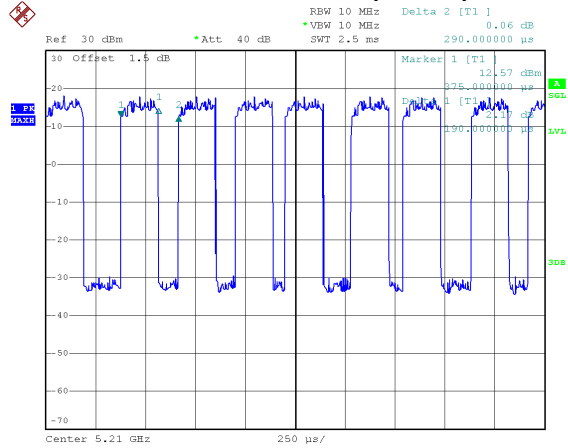

Date: 3.JAN.2020 15:33:10

Duty cycle = 0.190 ms / 0.290 ms = 65.52%
 Duty Factor = 10 log(1 / Duty cycle) = 1.84

NOTE:

For IEEE 802.11a, IEEE 802.11n (HT20) and IEEE 802.11ac (VHT20):

For radiated emissions frequency above 1 GHz, the resolution bandwidth of test receiver/spectrum analyzer is 1 MHz and the video bandwidth is 1 kHz (Duty cycle < 98%).

For IEEE 802.11n (HT40) and IEEE 802.11ac (VHT40):

For radiated emissions frequency above 1 GHz, the resolution bandwidth of test receiver/spectrum analyzer is 1 MHz and the video bandwidth is 2 kHz (Duty cycle < 98%).

For IEEE 802.11ac (VHT80):

For radiated emissions frequency above 1 GHz, the resolution bandwidth of test receiver/spectrum analyzer is 1 MHz and the video bandwidth is 3 kHz (Duty cycle < 98%).

2.5 BLOCK DIAGRAM SHOWING THE CONFIGURATION OF SYSTEM TESTED

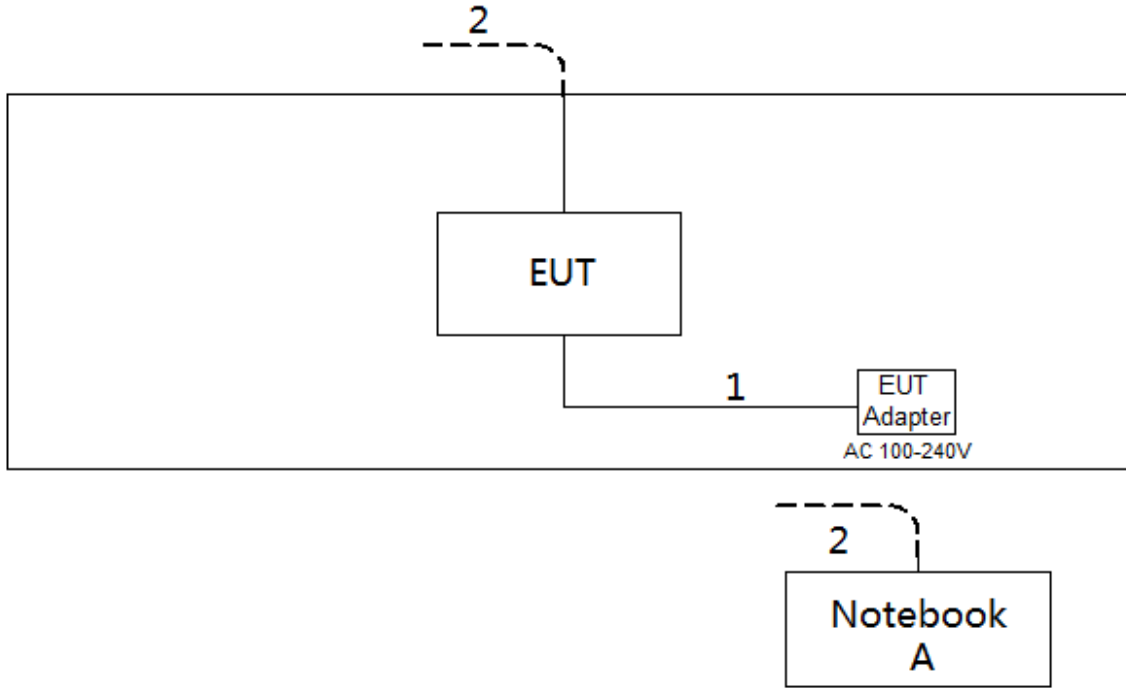

2.6 SUPPORT UNITS

Item	Equipment	Brand	Model No.	Series No.
A	Notebook	Dell	Inspiron 15-7559	N/A

Item	Cable Type	Shielded Type	Ferrite Core	Length
1	DC Cable	NO	NO	1.5m
2	RJ45 Cable	NO	NO	10m

3. AC POWER LINE CONDUCTED EMISSIONS TEST

3.1 LIMIT

Frequency (MHz)	Limit (dBµV)	
	Quasi-peak	Average
0.15 - 0.5	66 to 56*	56 to 46*
0.50 - 5.0	56	46
5.0 - 30.0	60	50

NOTE:

- (1) The tighter limit applies at the band edges.
- (2) The limit of " * " marked band means the limitation decreases linearly with the logarithm of the frequency in the range.

The following table is the setting of the receiver

Receiver Parameter	Setting
Attenuation	10 dB
Start Frequency	0.15 MHz
Stop Frequency	30 MHz
IF Bandwidth	9 KHz

3.2 TEST PROCEDURE

- a. The EUT was placed 0.8 meters from the horizontal ground plane with EUT being connected to the power mains through a line impedance stabilization network (LISN). All other support equipment powered from additional LISN(s). The LISN provide 50 Ohm/ 50uH of coupling impedance for the measuring instrument.
- b. Interconnecting cables that hang closer than 40 cm to the ground plane shall be folded back and forth in the center forming a bundle 30 to 40 cm long.
- c. I/O cables that are not connected to a peripheral shall be bundled in the center. The end of the cable may be terminated, if required, using the correct terminating impedance. The overall length shall not exceed 1 m.
- d. LISN at least 80 cm from nearest part of EUT chassis.
- e. For the actual test configuration, please refer to the related Item -EUT Test Photos.

3.3 DEVIATION FROM TEST STANDARD

No deviation

3.4 TEST SETUP

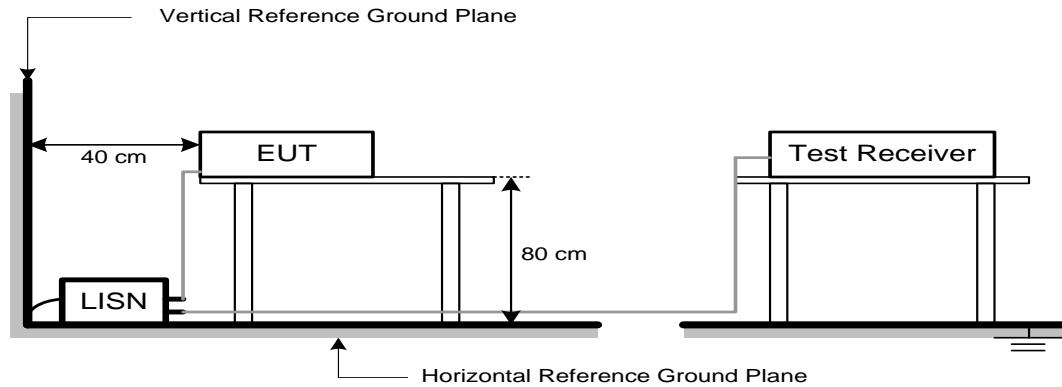

3.5 EUT OPERATION CONDITIONS

The EUT was configured for testing in a typical fashion (as a customer would normally use it). The EUT has been programmed to continuously transmit during test. This operating condition was tested and used to collect the included data.

The EUT was programmed to be in continuously transmitting/TX mode.

3.6 TEST RESULTS

Please refer to the APPENDIX A.

4. RADIATED EMISSIONS TEST

4.1 LIMIT

In case the emission fall within the restricted band specified on 15.205(a), then the 15.209(a) limit in the table below has to be followed.

LIMITS OF RADIATED EMISSIONS MEASUREMENT (9 kHz to 1000 MHz)

Frequency (MHz)	Field Strength (microvolts/meter)	Measurement Distance (meters)
0.009-0.490	2400/F(kHz)	300
0.490-1.705	24000/F(kHz)	30
1.705-30.0	30	30
30-88	100	3
88-216	150	3
216-960	200	3
Above 960	500	3

LIMITS OF UNWANTED EMISSION OUT OF THE RESTRICTED BANDS

Frequency (MHz)	EIRP Limit (dBm/MHz)	Equivalent Field Strength at 3m (dBμV/m)
5150-5250	-27	68.3
5250-5350	-27	68.3
5470-5725	-27	68.3
5725-5850	-27 NOTE (2)	68.3
	10 NOTE (2)	105.3
	15.6 NOTE (2)	110.9
	27 NOTE (2)	122.3

NOTE:

(1) The following formula is used to convert the equipment isotropic radiated power (eirp) to field strength:

$$E = \frac{1000000\sqrt{30P}}{3} \mu\text{V/m, where P is the eirp (Watts)}$$

(2) According to 15.407(b)(4)(i), all emissions shall be limited to a level of -27 dBm/MHz at 75 MHz or more above or below the band edge increasing linearly to 10 dBm/MHz at 25 MHz above or below the band edge, and from 25 MHz above or below the band edge increasing linearly to a level of 15.6 dBm/MHz at 5 MHz above or below the band edge, and from 5 MHz above or below the band edge increasing linearly to a level of 27 dBm/MHz at the band edge.

4.2 TEST PROCEDURE

- a. The measuring distance of 3 m shall be used for measurements. The EUT was placed on the top of a rotating table 0.8 meter above the ground at a 3 meter semi-anechoic chamber. The table was rotated 360 degrees to determine the position of the highest radiation.(below 1GHz)
- b. The measuring distance of 3 m shall be used for measurements. The EUT was placed on the top of a rotating table 1.5 meter above the ground at a 3 meter semi-anechoic chamber. The table was rotated 360 degrees to determine the position of the highest radiation.(above 1GHz)
- c. The height of the equipment or of the substitution antenna shall be 0.8m or 1.5m; the height of the test antenna shall vary between 1 m to 4 m. Both horizontal and vertical polarizations of the antenna are set to make the measurement.
- d. For each suspected emission, the EUT was arranged to its worst case and then the antenna was tuned to heights find the maximum reading (used Bore sight function).
- e. The receiver system was set to peak and average detect function and specified bandwidth with maximum hold mode when the test frequency is above 1 GHz.
- f. The initial step in collecting radiated emission data is a receiver peak detector mode pre-scanning the measurement frequency range. Significant peaks are then marked and then Quasi Peak detector mode re-measured.
- g. All readings are Peak unless otherwise stated QP in column of Note. Peak denotes that the Peak reading compliance with the QP Limits and then QP Mode measurement didn't perform. (below 1 GHz)
- h. All readings are Peak Mode value unless otherwise stated AVG in column of Note. If the Peak Mode Measured value compliance with the Peak Limits and lower than AVG Limits, the EUT shall be deemed to meet both Peak & AVG Limits and then only Peak Mode was measured, but AVG Mode didn't perform. (above 1 GHz)
- i. For the actual test configuration, please refer to the related Item –EUT Test Photos.

4.3 DEVIATION FROM TEST STANDARD

No deviation

4.4 TEST SETUP

9 kHz to 30 MHz

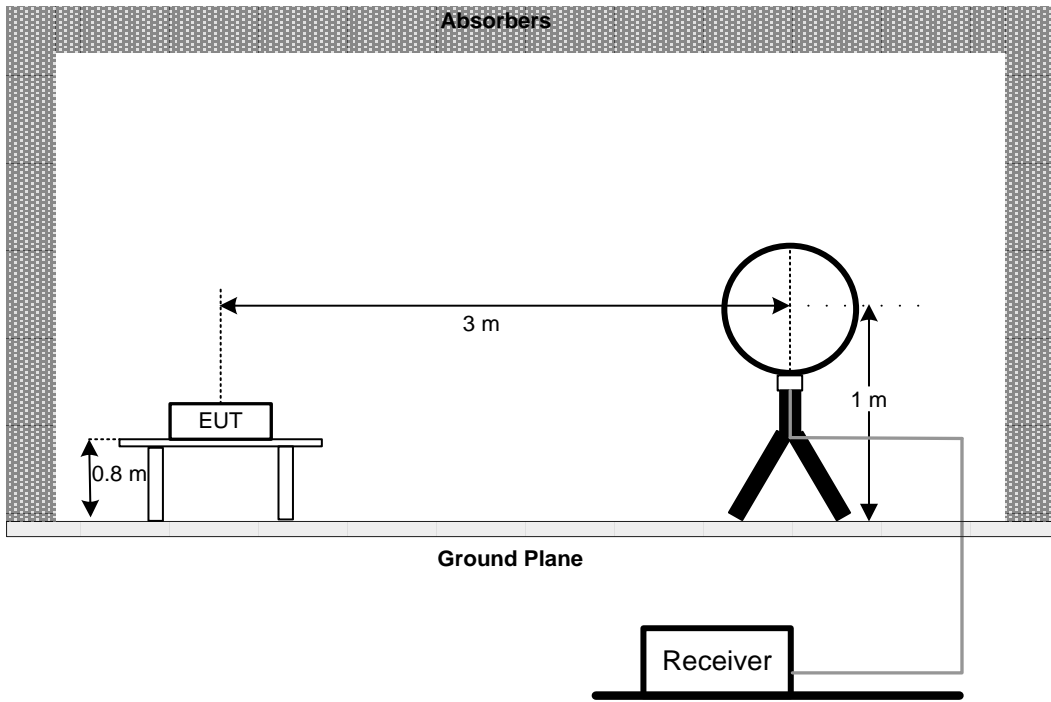

30 MHz to 1 GHz

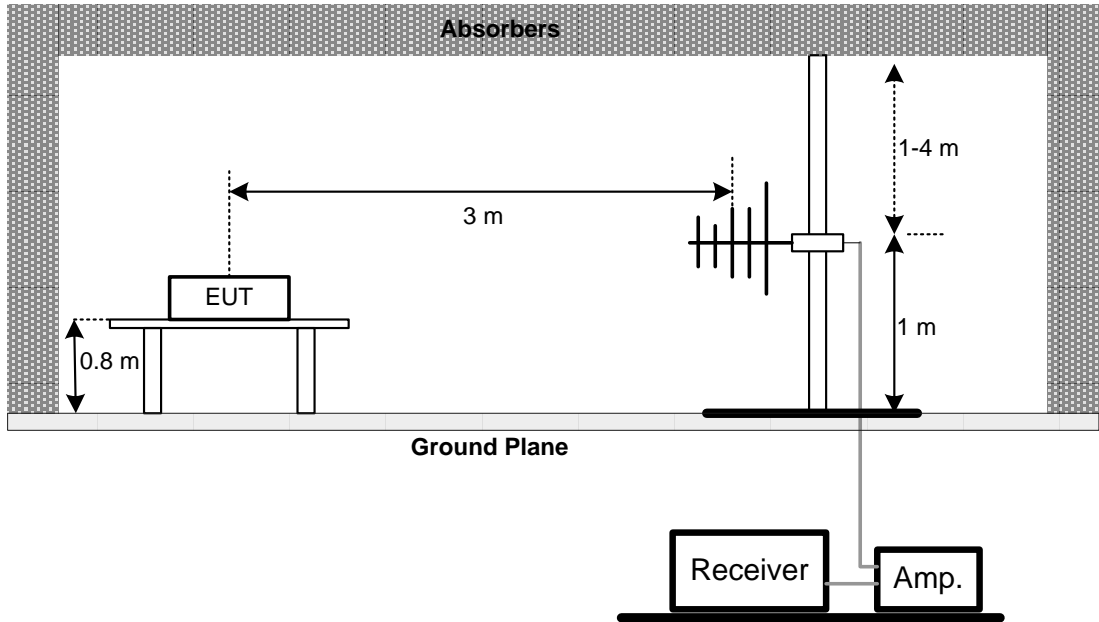

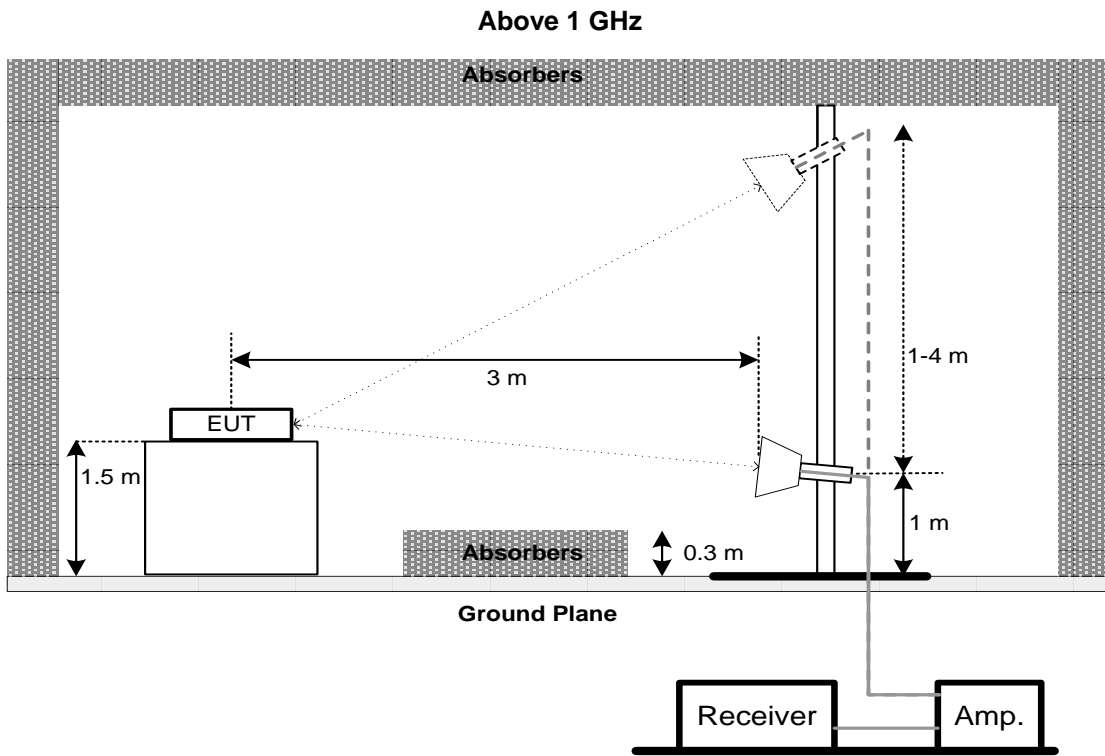

4.5 EUT OPERATION CONDITIONS

The EUT tested system was configured as the statements of 3.5 unless otherwise a special operating condition is specified in the follows during the testing.

4.6 TEST RESULTS - 9 KHZ to 30 MHZ

Please refer to the APPENDIX B

Remark:

- (1) Distance extrapolation factor = $40 \log(\text{specific distance} / \text{test distance})$ (dB).
- (2) Limit line = specific limits (dBuV) + distance extrapolation factor.

4.7 TEST RESULTS - 30 MHz TO 1000 MHz

Please refer to the APPENDIX C.

4.8 TEST RESULTS - ABOVE 1000 MHz

Please refer to the APPENDIX D.

Remark:

- (1) No limit: This is fundamental signal, the judgment is not applicable.
For fundamental signal judgment was referred to Peak output test.

5. BANDWIDTH TEST

5.1 LIMIT

FCC Part15, Subpart E (15.407)			
Section	Test Item	Limit	Frequency Range (MHz)
15.407(a)	26 dB Bandwidth	-	5150-5250
	26 dB Bandwidth	-	5250-5350
15.407(e)	26 dB Bandwidth	-	5470-5725
	6 dB Bandwidth	Minimum 500 kHz	5725-5850

5.2 TEST PROCEDURE

a. The EUT was directly connected to the spectrum analyzer and antenna output port as show in the block diagram below

b. Spectrum Setting:

For UNII-1, UNII-2A, UNII-2C:

Spectrum Parameter	Setting
Attenuation	Auto
Span Frequency	> 26 dB Bandwidth
RBW	300 kHz (Bandwidth 20 MHz) 1 MHz (Bandwidth 40 MHz and 80 MHz)
VBW	1 MHz (Bandwidth 20 MHz) 3 MHz (Bandwidth 40 MHz and 80 MHz)
Detector	Peak
Trace	Max Hold
Sweep Time	Auto

For UNII-3:

Spectrum Parameter	Setting
Attenuation	Auto
Span Frequency	6 dB Bandwidth
RBW	100 kHz
VBW	300 kHz
Detector	Peak
Trace	Max Hold
Sweep Time	Auto

c. Measured the spectrum width with power higher than 26 dB below carrier

5.3 DEVIATION FROM TEST STANDARD

No deviation.

5.4 TEST SETUP

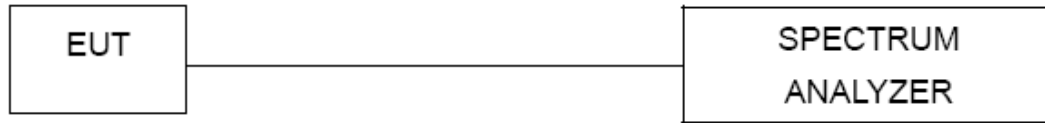

5.5 EUT OPERATION CONDITIONS

The EUT was programmed to be in continuously transmitting mode.

5.6 TEST RESULTS

Please refer to the APPENDIX E.

6. CONDUCTED OUTPUT POWER TEST

6.1 LIMIT

FCC Part15, Subpart E (15.407)			
Section	Test Item	Limit	Frequency Range (MHz)
15.407(a)	Conducted Output Power	AP device: 1 Watt (30 dBm) Client device: 250 mW (24 dBm)	5150-5250
		250 mW (24 dBm)	5250-5350
		250 mW (24 dBm)	5470-5725
		1 Watt (30dBm)	5725-5850

Note:

- a. For an outdoor access point operating in the band 5.15-5.25 GHz, the maximum conducted output power over the frequency band of operation shall not exceed 1 W provided the maximum antenna gain does not exceed 6 dBi. In addition, the maximum power spectral density shall not exceed 17 dBm in any 1 megahertz band. If transmitting antennas of directional gain greater than 6 dBi are used, both the maximum conducted output power and the maximum power spectral density shall be reduced by the amount in dB that the directional gain of the antenna exceeds 6 dBi. The maximum e.i.r.p. at any elevation angle above 30 degrees as measured from the horizon must not exceed 125 mW (21 dBm).
For an indoor access point operating in the band 5.15-5.25 GHz, the maximum conducted output power over the frequency band of operation shall not exceed 1 W provided the maximum antenna gain does not exceed 6 dBi. In addition, the maximum power spectral density shall not exceed 17 dBm in any 1 megahertz band. If transmitting antennas of directional gain greater than 6 dBi are used, both the maximum conducted output power and the maximum power spectral density shall be reduced by the amount in dB that the directional gain of the antenna exceeds 6 dBi.
- b. For the 5.25-5.35 GHz and 5.47-5.725 GHz bands, the maximum conducted output power over the frequency bands of operation shall not exceed the lesser of 250 mW or 11 dBm + 10log B, where B is the 26dB Bandwidth in megahertz.

6.2 TEST PROCEDURE

- a. The EUT was directly connected to the power meter and antenna output port as show in the block diagram below.
- b. Test test was performed in accordance with method of FCC KDB 789033 D02 General UNII Test Procedures New Rules v02r01.

6.3 DEVIATION FROM STANDARD

No deviation.

6.4 TEST SETUP



6.5 EUT OPERATION CONDITIONS

The EUT was programmed to be in continuously transmitting mode.

6.6 TEST RESULTS

Please refer to the APPENDIX F.

7. POWER SPECTRAL DENSITY TEST

7.1 LIMIT

FCC Part15, Subpart E (15.407)			
Section	Test Item	Limit	Frequency Range (MHz)
15.407(a)	Power Spectral Density	AP device: 17 dBm/MHz Client device: 11 dBm/MHz	5150-5250
		11 dBm/MHz	5250-5350
		11 dBm/MHz	5470-5725
		30 dBm/500 kHz	5725-5850

7.2 TEST PROCEDURE

a. The EUT was directly connected to the spectrum analyzer and antenna output port as show in the block diagram below.

b. Spectrum Setting

Spectrum Parameter	Setting
Attenuation	Auto
Span Frequency	Encompass the entire emissions bandwidth (EBW) of the signal
RBW	= 1 MHz.
VBW	≥ 3 MHz.
Detector	RMS
Trace average	100 trace
Sweep Time	Auto

Note:

- For UNII-3, according to KDB publication 789033 D02 General UNII Test Procedures New Rules v02r01, section II.F.5., it is acceptable to set RBW at 1 MHz and VBW at 3 MHz if the spectrum analyzer does not have 500 kHz RBW.
- The value measured with RBW=1 MHz is to be added with $10\log(500\text{ kHz}/1\text{ MHz})$ which is -3 dB. For example, if the measured value is +10dBm using RBW=1 MHz (that is +10 dBm/MHz), then the converted value will be +7dBm/500kHz.

7.3 DEVIATION FROM STANDARD

No deviation.

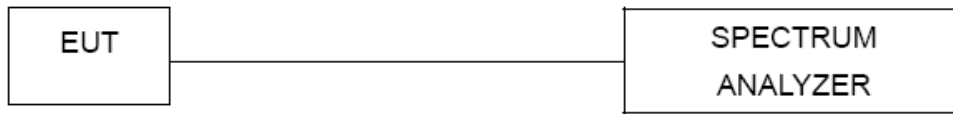
7.4 TEST SETUP**7.5 EUT OPERATION CONDITIONS**

The EUT was programmed to be in continuously transmitting mode.

7.6 TEST RESULTS

Please refer to the APPENDIX G.

8. FREQUENCY STABILITY MEASUREMENT

8.1 LIMIT

FCC Part15, Subpart E (15.407)			
Section	Test Item	Limit	Frequency Range (MHz)
15.407(g)	Frequency Stability	An emission is maintained within the band of operation under all conditions of normal operation as specified in the users manual.	5150-5250
			5250-5350
			5470-5725
			5725-5850

8.2 TEST PROCEDURE

a. The EUT was directly connected to the spectrum analyzer and antenna output port as show in the block diagram below.

b. Spectrum Setting:

Spectrum Parameter	Setting
Attenuation	Auto
Span Frequency	Entire absence of modulation emissions bandwidth
RBW	10 kHz
VBW	10 kHz
Sweep Time	Auto

c. The test extreme voltage is to change the primary supply voltage from 85 to 115 percent of the nominal value.

d. User manual temperature is 0°C~40°C.

8.3 DEVIATION FROM STANDARD

No deviation.

8.4 TEST SETUP

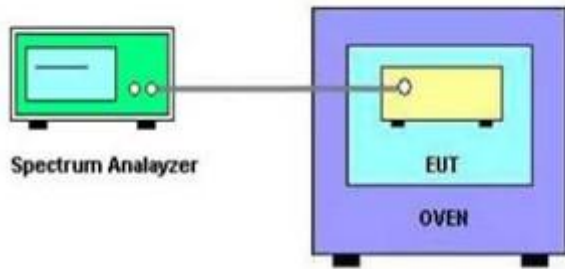

8.5 EUT OPERATION CONDITIONS

The EUT was programmed to be in continuously transmitting mode.

8.6 TEST RESULTS

Please refer to the APPENDIX H.

9. MEASUREMENT INSTRUMENTS LIST

AC Power Line Conducted Emissions					
Item	Kind of Equipment	Manufacturer	Type No.	Serial No.	Calibrated until
1	EMI Test Receiver	R&S	ESCI	100382	Mar. 10, 2020
2	LISN	EMCO	3816/2	52765	Mar. 10, 2020
3	TWO-LINE V-NETWORK	R&S	ENV216	101447	May. 19, 2020
4	50Ω Terminator	SHX	TF5-3	15041305	Mar. 10, 2020
5	Measurement Software	Farad	EZ-EMC Ver.NB-03A1-01	N/A	N/A
6	Cable	N/A	RG223	12m	Mar. 12, 2020

Radiated Emissions - 9 kHz to 30 MHz					
Item	Kind of Equipment	Manufacturer	Type No.	Serial No.	Calibrated until
1	Loop Antenna	EM	EM-6876-1	230	Jan. 15, 2020
2	Cable	N/A	RG 213/U	C-102	May 31, 2020
3	EMI Test Receiver	R&S	ESCI	100895	Mar. 10, 2020
4	Measurement Software	Farad	EZ-EMC Ver.NB-03A1-01	N/A	N/A

Radiated Emissions - 30 MHz to 1 GHz					
Item	Kind of Equipment	Manufacturer	Type No.	Serial No.	Calibrated until
1	Antenna	Schwarzbeck	VULB9160	9160-3232	Mar. 09, 2020
2*	Amplifier	HP	8447D	2944A09673	Aug. 11, 2021
3	Receiver	Agilent	N9038A	MY52130039	Aug. 03, 2020
4	Cable	emci	LMR-400(30MHz-1 GHz)(8m+5m)	N/A	May 24, 2020
5	Controller	CT	SC100	N/A	N/A
6	Controller	MF	MF-7802	MF780208416	N/A
7	Measurement Software	Farad	EZ-EMC Ver.NB-03A1-01	N/A	N/A

Radiated Emissions - Above 1 GHz					
Item	Kind of Equipment	Manufacturer	Type No.	Serial No.	Calibrated until
1	Double Ridged Guide Antenna	ETS	3115	75789	Mar. 09, 2020
2	Broad-Band Horn Antenna	Schwarzbeck	BBHA 9170	9170319	Jun. 23, 2020
3	Amplifier	Agilent	8449B	3008A02333	Mar. 10, 2020
4	Microwave Preamplifier With Adaptor	EMC INSTRUMENT	EMC2654045	980039 & HA01	Mar. 10, 2020
5	Receiver	Agilent	N9038A	MY52130039	Aug. 03, 2020
6	Controller	CT	SC100	N/A	N/A
7	Controller	MF	MF-7802	MF780208416	N/A
8	Cable	mitron	B10-01-01-12M	18072744	Jun. 29, 2020
9	Measurement Software	Farad	EZ-EMC Ver.NB-03A1-01	N/A	N/A

**Bandwidth &
Conducted Output Power &
Power Spectral Density**

Item	Kind of Equipment	Manufacturer	Type No.	Serial No.	Calibrated until
1	Spectrum Analyzer	R&S	FSP40	100185	Aug. 03, 2020

Frequency Stability

Item	Kind of Equipment	Manufacturer	Type No.	Serial No.	Calibrated until
1	Spectrum Analyzer	R&S	FSP40	100185	Aug. 03, 2020
2	Precision Oven Tester	Bell	BTH-50C	20170306001	Mar. 10, 2020

Remark: "N/A" denotes no model name, serial no. or calibration specified.

"**" calibration period of equipment list is three year.

Except * item, all calibration period of equipment list is one year.

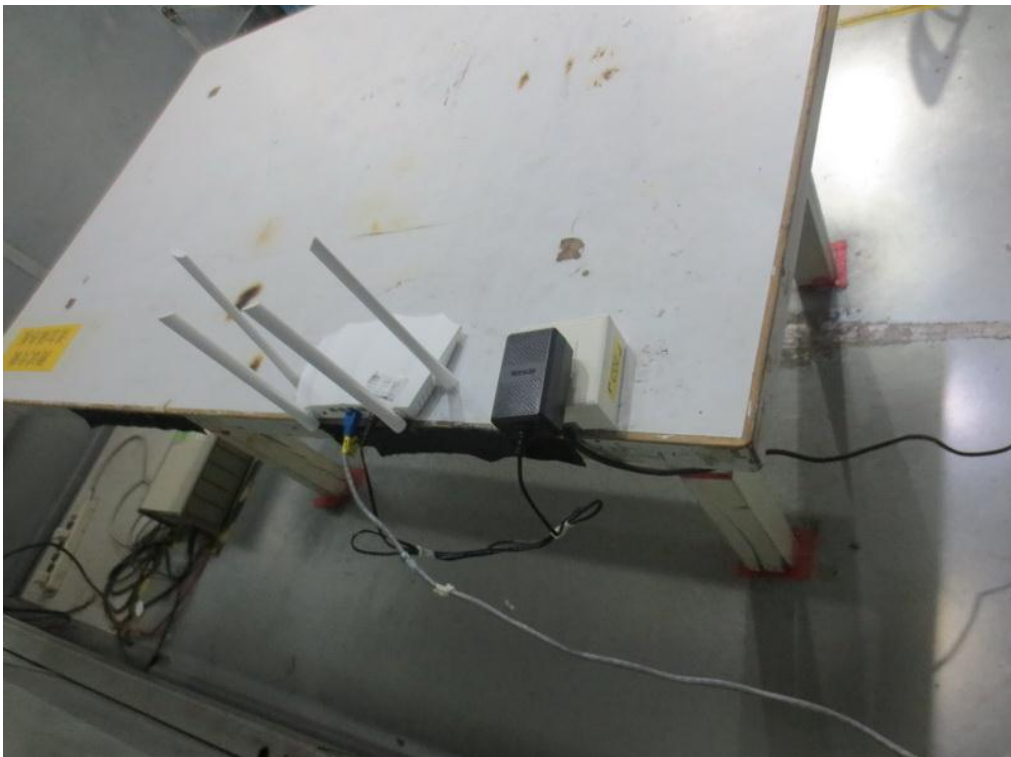
10. EUT TEST PHOTOS**AC Power Line Conducted Emissions Test Photos**

Radiated Emissions Test Photos**9 kHz to 30 MHz**

Radiated Emissions Test Photos**30 MHz to 1 GHz**

Radiated Emissions Test Photos**Above 1 GHz**

APPENDIX A - AC POWER LINE CONDUCTED EMISSIONS

Test Mode:	TX AC40 MODE CHANNEL 38
Test Voltage	AC 120V/60Hz

Line

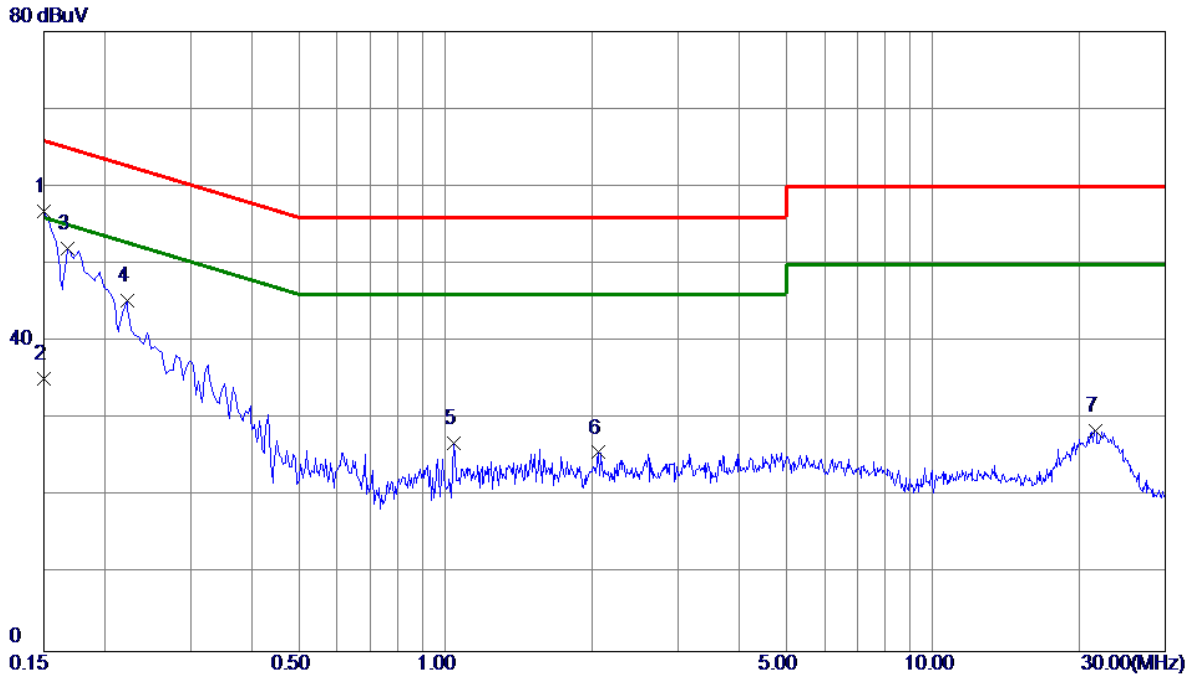

No.	Freq. MHz	Reading Level dBuV	Correct Factor dB	Measure ment dBuV	Limit dBuV	Margin dB	Detector	Comment
1 *	0.1500	46.98	9.82	56.80	66.00	-9.20	Peak	
2	0.1500	25.36	9.82	35.18	56.00	-20.82	AVG	
3	0.1680	42.20	9.82	52.02	65.06	-13.04	Peak	
4	0.2220	35.40	9.82	45.22	62.74	-17.52	Peak	
5	1.0410	16.89	9.92	26.81	56.00	-29.19	Peak	
6	2.0579	15.68	10.00	25.68	56.00	-30.32	Peak	
7	21.5700	17.38	11.17	28.55	60.00	-31.45	Peak	

REMARKS:

- (1) Measurement Value = Reading Level + Correct Factor.
- (2) Margin Level = Measurement Value - Limit Value.
- (3) The test result has included the cable loss.

Test Mode:	TX AC40 MODE CHANNEL 38
Test Voltage	AC 120V/60Hz

Neutral

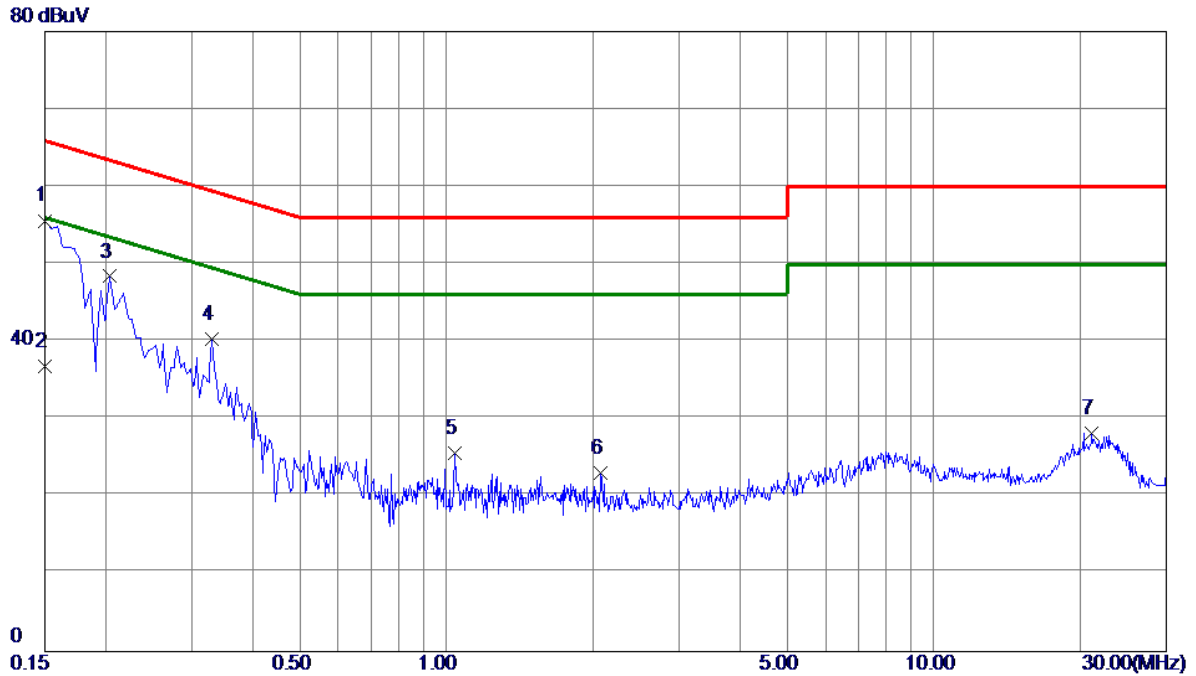

No.	Freq. MHz	Reading Level dBuV	Correct Factor dB	Measure ment dBuV	Limit dBuV	Margin dB	Detector	Comment
1 *	0.1500	45.69	9.91	55.60	66.00	-10.40	Peak	
2	0.1500	26.83	9.91	36.74	56.00	-19.26	AVG	
3	0.2040	38.50	9.90	48.40	63.45	-15.05	Peak	
4	0.3300	30.41	9.98	40.39	59.45	-19.06	Peak	
5	1.0410	15.41	10.12	25.53	56.00	-30.47	Peak	
6	2.0760	12.85	10.19	23.04	56.00	-32.96	Peak	
7	21.0840	16.67	11.48	28.15	60.00	-31.85	Peak	

Note: The test result has included the cable loss.

REMARKS:

- (1) Measurement Value = Reading Level + Correct Factor.
- (2) Margin Level = Measurement Value - Limit Value.
- (3) The test result has included the cable loss.

Test Mode:	TX AC40 MODE CHANNEL 38
Test Voltage	AC 240V/50Hz

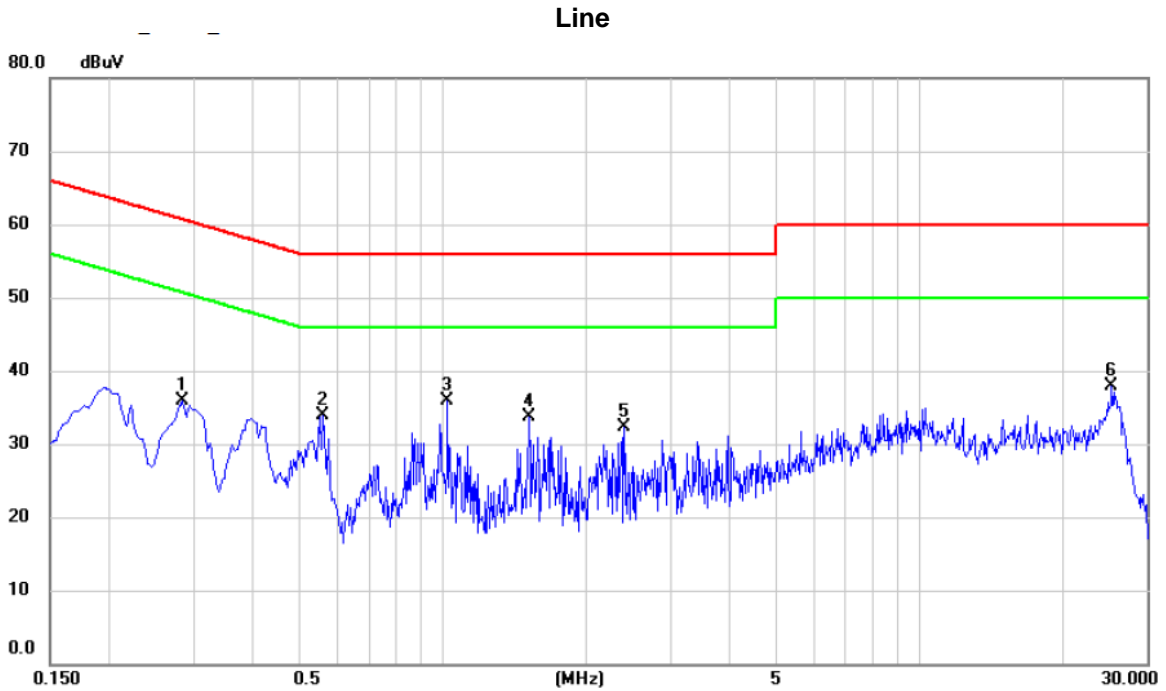

No.	Mk.	Freq. MHz	Reading Level dBuV	Correct Factor dB	Measure- ment dBuV	Limit dBuV	Margin dB	Detector	Comment
1		0.2850	26.01	9.81	35.82	60.67	-24.85	peak	
2		0.5595	23.99	9.83	33.82	56.00	-22.18	peak	
3	*	1.0230	25.97	9.85	35.82	56.00	-20.18	peak	
4		1.5180	23.88	9.87	33.75	56.00	-22.25	peak	
5		2.4045	22.39	9.91	32.30	56.00	-23.70	peak	
6		25.2825	27.11	10.74	37.85	60.00	-22.15	peak	

REMARKS:

- (1) Measurement Value = Reading Level + Correct Factor.
- (2) Margin Level = Measurement Value - Limit Value.
- (3) The test result has included the cable loss.

Test Mode:	TX AC40 MODE CHANNEL 38
Test Voltage	AC 240V/50Hz

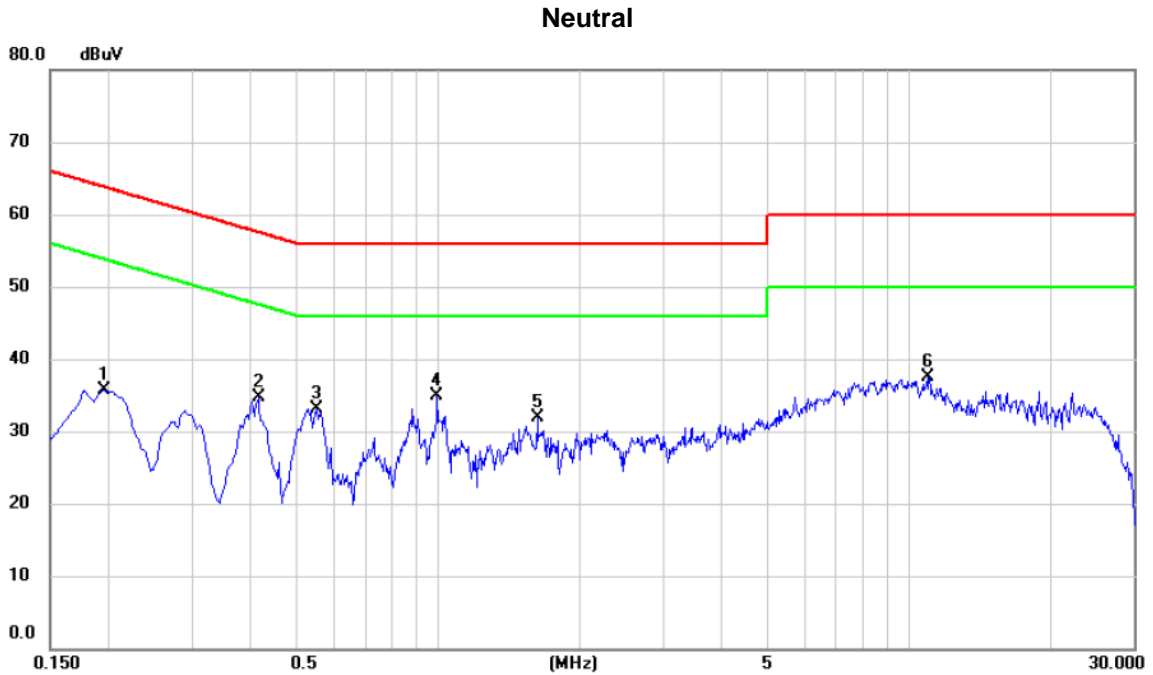

No. Mk.	Freq. MHz	Reading Level dBuV	Correct Factor dB	Measure- ment dBuV	Limit dBuV	Margin dB	Detector	Comment
1	0.1950	25.89	9.87	35.76	63.82	-28.06	peak	
2	0.4155	24.67	9.96	34.63	57.54	-22.91	peak	
3	0.5505	23.08	9.98	33.06	56.00	-22.94	peak	
4 *	0.9960	24.83	10.05	34.88	56.00	-21.12	peak	
5	1.6260	21.89	10.08	31.97	56.00	-24.03	peak	
6	10.9545	26.95	10.55	37.50	60.00	-22.50	peak	

REMARKS:

- (1) Measurement Value = Reading Level + Correct Factor.
- (2) Margin Level = Measurement Value - Limit Value.
- (3) The test result has included the cable loss.

APPENDIX B - RADIATED EMISSION - 9 KHZ TO 30 MHZ

Test Mode: TX AC40 MODE CHANNEL 38

Ant 0°

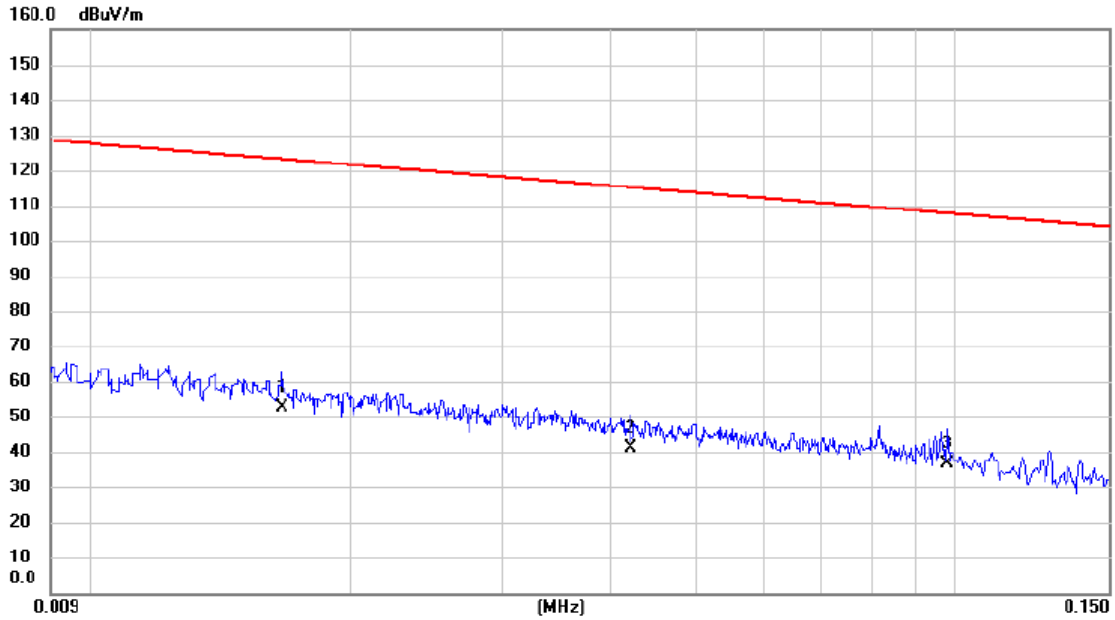

No.	Mk.	Freq.	Reading Level	Correct Factor	Measurement	Limit	Margin	Detector	Comment
		MHz	dBuV	dB	dBuV/m	dBuV/m	dB		
1	*	0.0167	37.68	14.81	52.49	123.15	-70.66	AVG	
2		0.0421	27.13	13.90	41.03	115.12	-74.09	AVG	
3		0.0978	23.05	13.54	36.59	107.80	-71.21	AVG	

REMARKS:

- (1) Measurement Value = Reading Level + Correct Factor.
- (2) Margin Level = Measurement Value - Limit Value.

Test Mode: TX AC40 MODE CHANNEL 38

Ant 0°

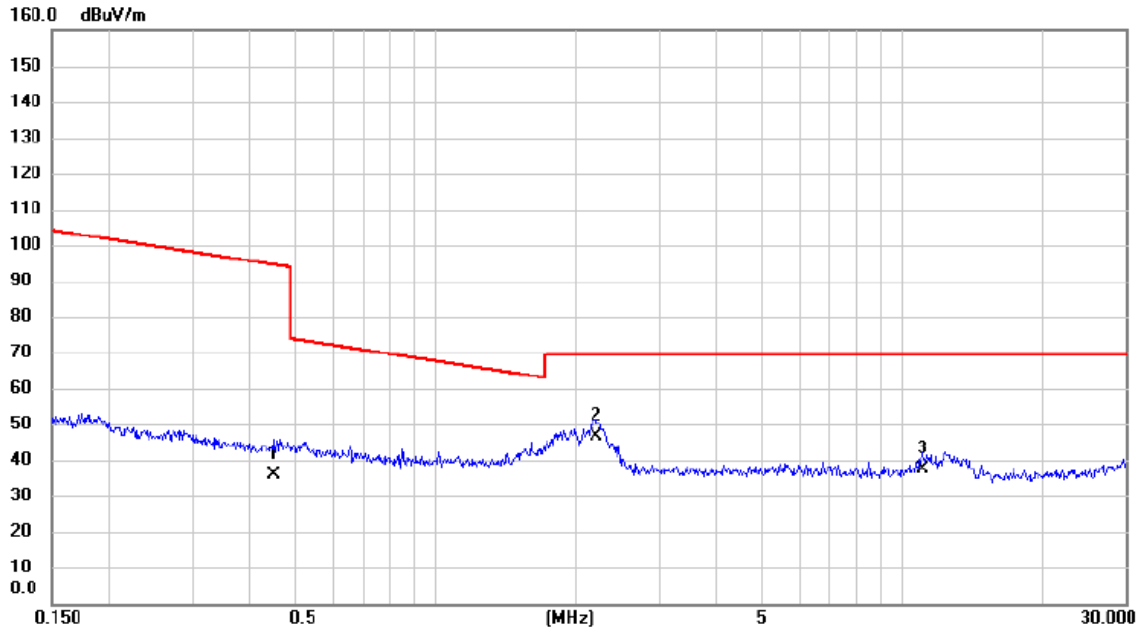

No.	Mk.	Freq.	Reading Level	Correct Factor	Measurement	Limit	Margin	Detector	Comment
		MHz	dBuV	dB	dBuV/m	dBuV/m	dB		
1		0.4492	22.81	13.18	35.99	94.56	-58.57	AVG	
2	*	2.2015	34.93	11.70	46.63	69.54	-22.91	QP	
3		11.0211	25.77	11.62	37.39	69.54	-32.15	QP	

REMARKS:

- (1) Measurement Value = Reading Level + Correct Factor.
- (2) Margin Level = Measurement Value - Limit Value.

Test Mode: TX AC40 MODE CHANNEL 38

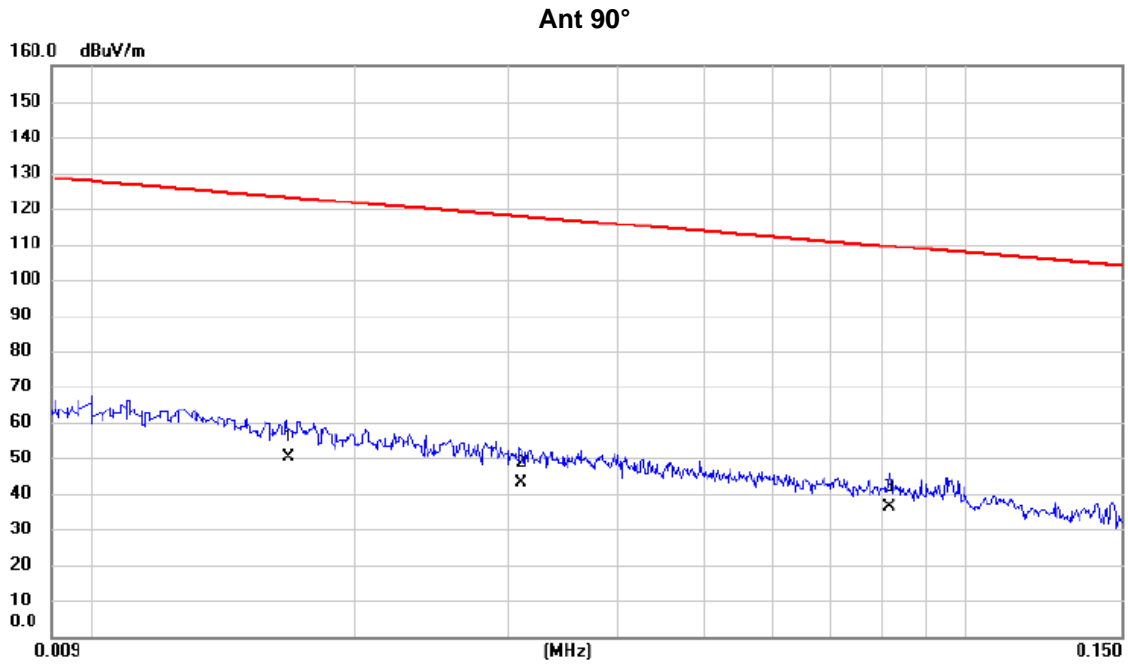

No.	Mk.	Freq.	Reading Level	Correct Factor	Measurement	Limit	Margin	Detector	Comment
		MHz	dBuV	dB	dBuV/m	dBuV/m	dB		
1	*	0.0168	35.59	14.78	50.37	123.10	-72.73	AVG	
2		0.0310	29.13	13.86	42.99	117.78	-74.79	AVG	
3		0.0815	22.52	13.54	36.06	109.38	-73.32	AVG	

REMARKS:

- (1) Measurement Value = Reading Level + Correct Factor.
- (2) Margin Level = Measurement Value - Limit Value.

Test Mode: TX AC40 MODE CHANNEL 38

Ant 90°

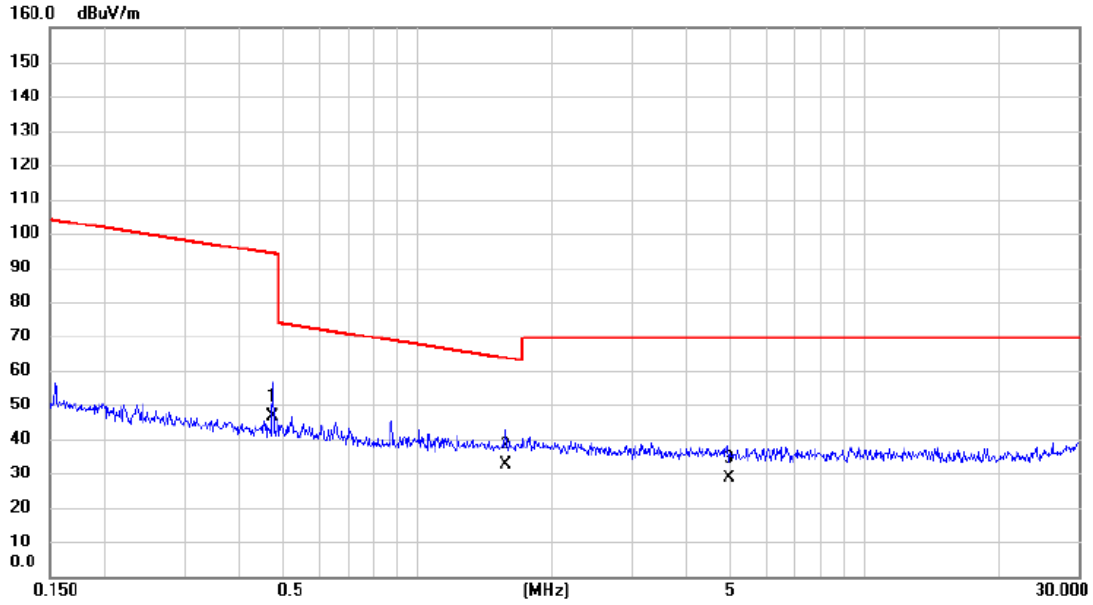

No.	Mk.	Freq.	Reading Level	Correct Factor	Measurement	Limit	Margin	Detector	Comment
		MHz	dBuV	dB	dBuV/m	dBuV/m	dB		
1		0.4736	33.38	13.12	46.50	94.10	-47.60	AVG	
2	*	1.5766	20.51	12.11	32.62	63.65	-31.03	QP	
3		4.9520	17.86	10.86	28.72	69.54	-40.82	QP	

REMARKS:

- (1) Measurement Value = Reading Level + Correct Factor.
- (2) Margin Level = Measurement Value - Limit Value.

APPENDIX C - RADIATED EMISSION - 30 MHZ TO 1 GHZ

Test Mode: TX AC40 MODE CHANNEL 38

Vertical

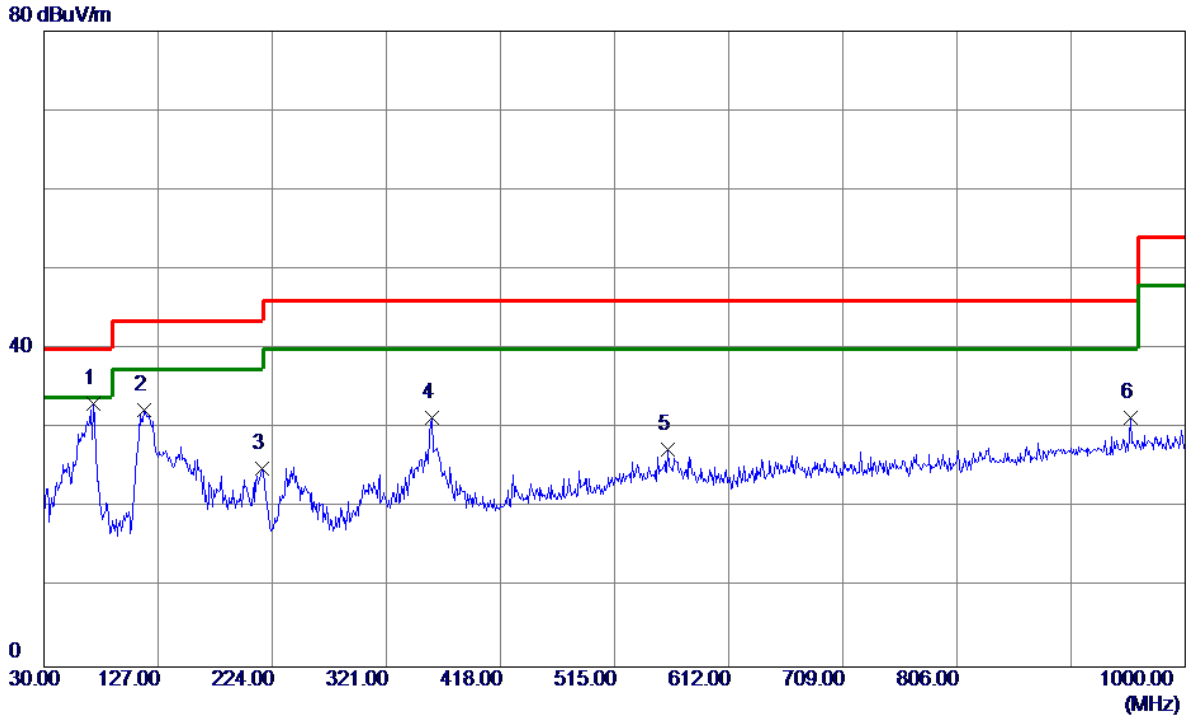

No.	Freq. MHz	Reading Level dBuV/m	Correct Factor dB	Measure ment dBuV/m	Limit dBuV/m	Margin dB	Detector	Comment
1 *	71.7100	49.69	-16.56	33.13	40.00	-6.87	Peak	
2	115.3600	46.05	-13.78	32.27	43.50	-11.23	Peak	
3	215.2700	40.19	-15.16	25.03	43.50	-18.47	Peak	
4	359.8000	41.81	-10.51	31.30	46.00	-14.70	Peak	
5	560.5900	34.29	-6.96	27.33	46.00	-18.67	Peak	
6	953.4400	32.03	-0.65	31.38	46.00	-14.62	Peak	

REMARKS:

- (1) Measurement Value = Reading Level + Correct Factor.
- (2) Margin Level = Measurement Value - Limit Value.

Test Mode: TX AC40 MODE CHANNEL 38

Horizontal

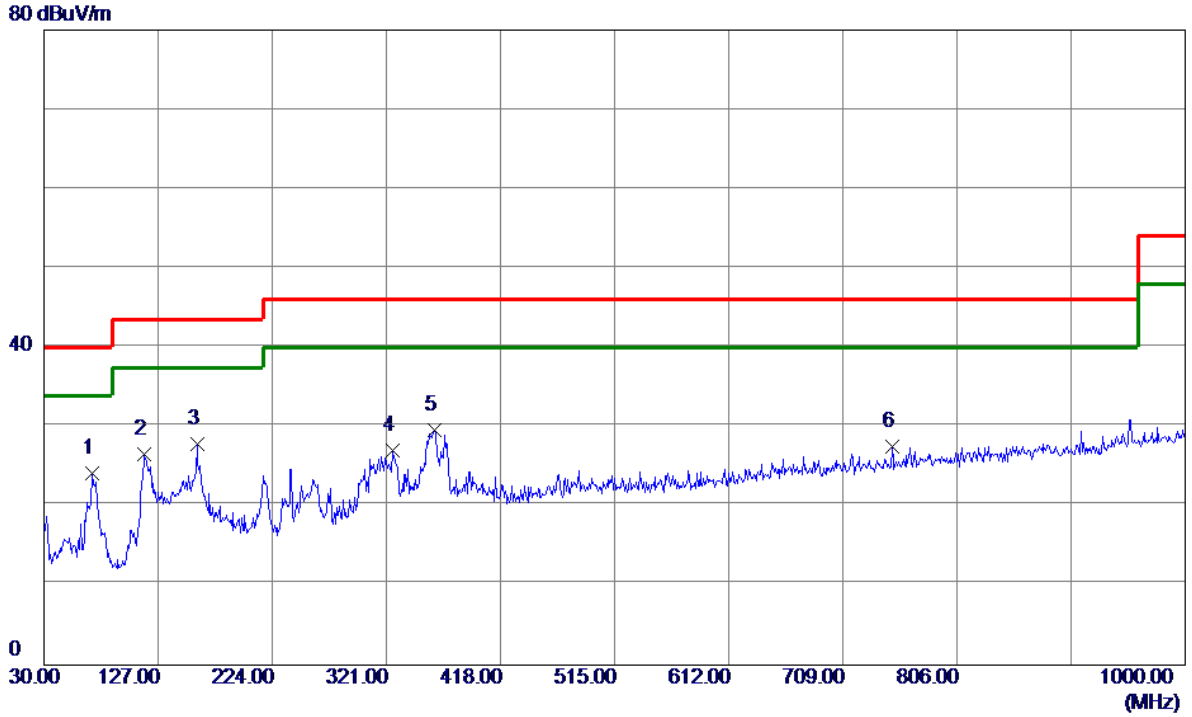

No.	Freq. MHz	Reading Level dBuV/m	Correct Factor dB	Measure ment dBuV/m	Limit dBuV/m	Margin dB	Detector	Comment
1	70.7400	40.50	-16.37	24.13	40.00	-15.87	Peak	
2	115.3600	40.27	-13.78	26.49	43.50	-17.01	Peak	
3 *	159.9800	38.97	-11.07	27.90	43.50	-15.60	Peak	
4	325.8500	38.24	-11.13	27.11	46.00	-18.89	Peak	
5	361.7400	40.02	-10.46	29.56	46.00	-16.44	Peak	
6	750.7100	31.14	-3.66	27.48	46.00	-18.52	Peak	

REMARKS:

- (1) Measurement Value = Reading Level + Correct Factor.
- (2) Margin Level = Measurement Value - Limit Value.

APPENDIX D - RADIATED EMISSION - ABOVE 1000 MHZ

Test Mode: TX AC40 MODE CHANNEL 38

Vertical

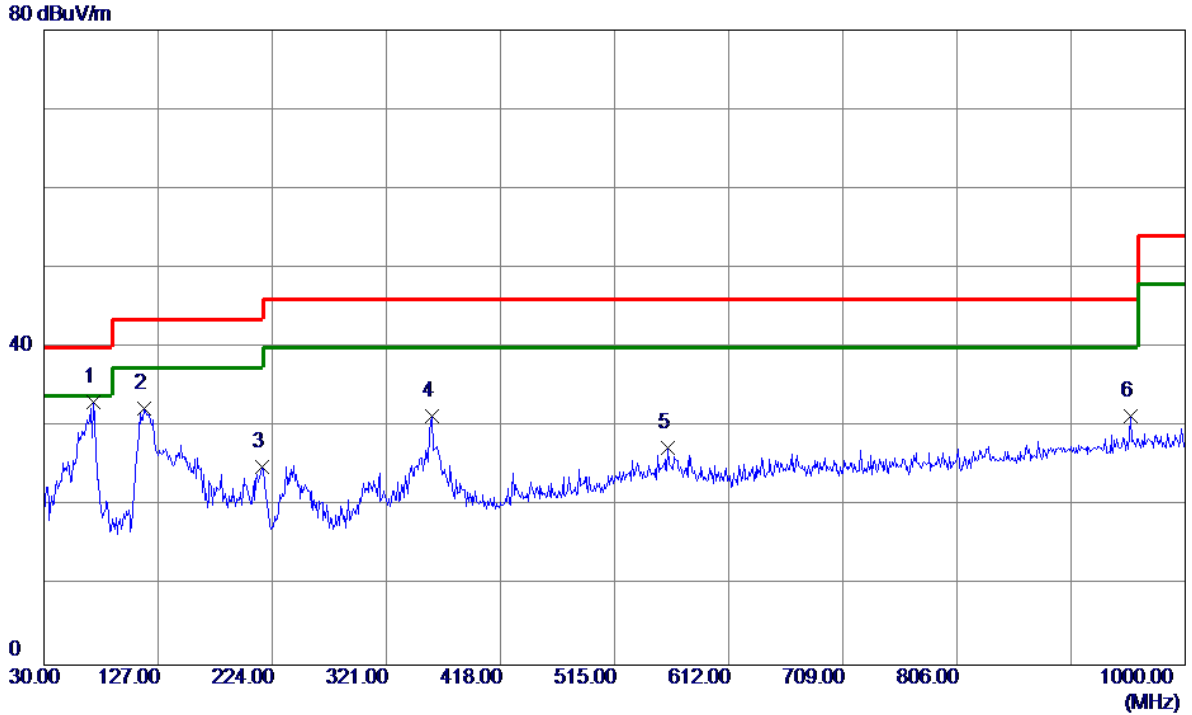

No.	Freq. MHz	Reading Level dBuV/m	Correct Factor dB	Measure ment dBuV/m	Limit dBuV/m	Margin dB	Detector	Comment
1 *	71.7100	49.69	-16.56	33.13	40.00	-6.87	Peak	
2	115.3600	46.05	-13.78	32.27	43.50	-11.23	Peak	
3	215.2700	40.19	-15.16	25.03	43.50	-18.47	Peak	
4	359.8000	41.81	-10.51	31.30	46.00	-14.70	Peak	
5	560.5900	34.29	-6.96	27.33	46.00	-18.67	Peak	
6	953.4400	32.03	-0.65	31.38	46.00	-14.62	Peak	

REMARKS:

- (1) Measurement Value = Reading Level + Correct Factor.
- (2) Margin Level = Measurement Value - Limit Value.

Test Mode: TX AC40 MODE CHANNEL 38

Horizontal

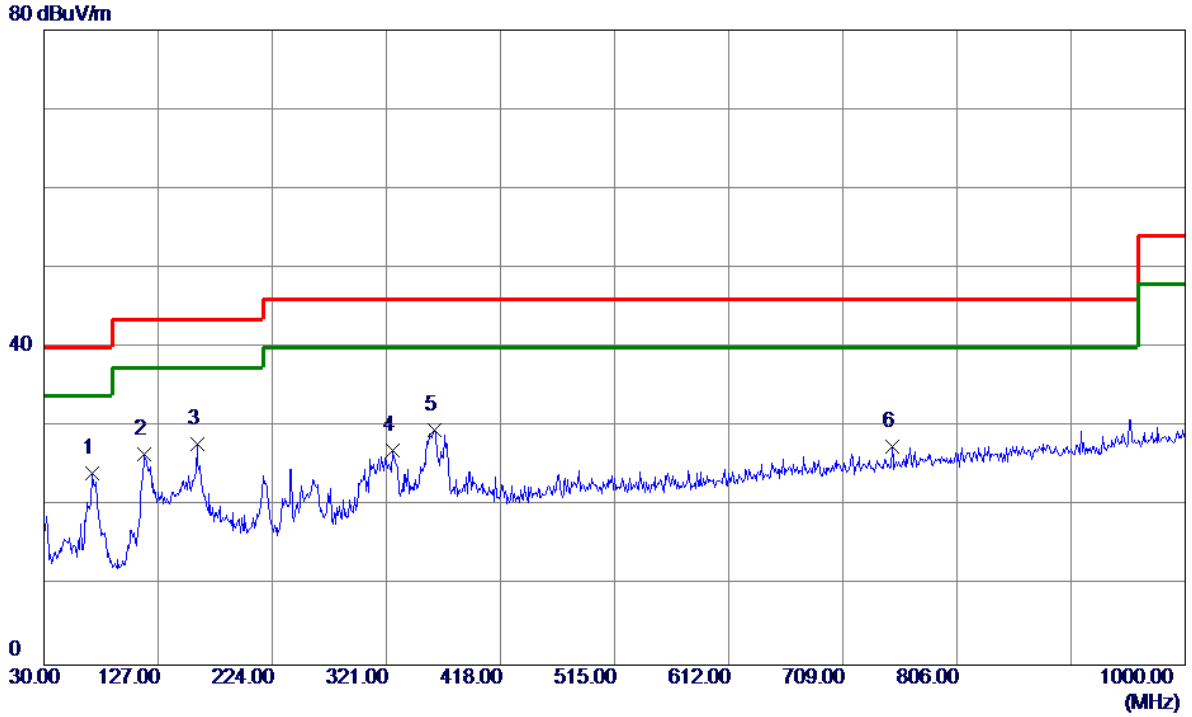

No.	Freq. MHz	Reading Level dBuV/m	Correct Factor dB	Measure ment dBuV/m	Limit dBuV/m	Margin dB	Detector	Comment
1	70.7400	40.50	-16.37	24.13	40.00	-15.87	Peak	
2	115.3600	40.27	-13.78	26.49	43.50	-17.01	Peak	
3 *	159.9800	38.97	-11.07	27.90	43.50	-15.60	Peak	
4	325.8500	38.24	-11.13	27.11	46.00	-18.89	Peak	
5	361.7400	40.02	-10.46	29.56	46.00	-16.44	Peak	
6	750.7100	31.14	-3.66	27.48	46.00	-18.52	Peak	

REMARKS:

- (1) Measurement Value = Reading Level + Correct Factor.
- (2) Margin Level = Measurement Value - Limit Value.

APPENDIX D - RADIATED EMISSION - ABOVE 1000 MHZ

Orthogonal Axis	X
Test Mode	UNII-1_TX A Mode 5180 MHz

Vertical

130 dBuV/m

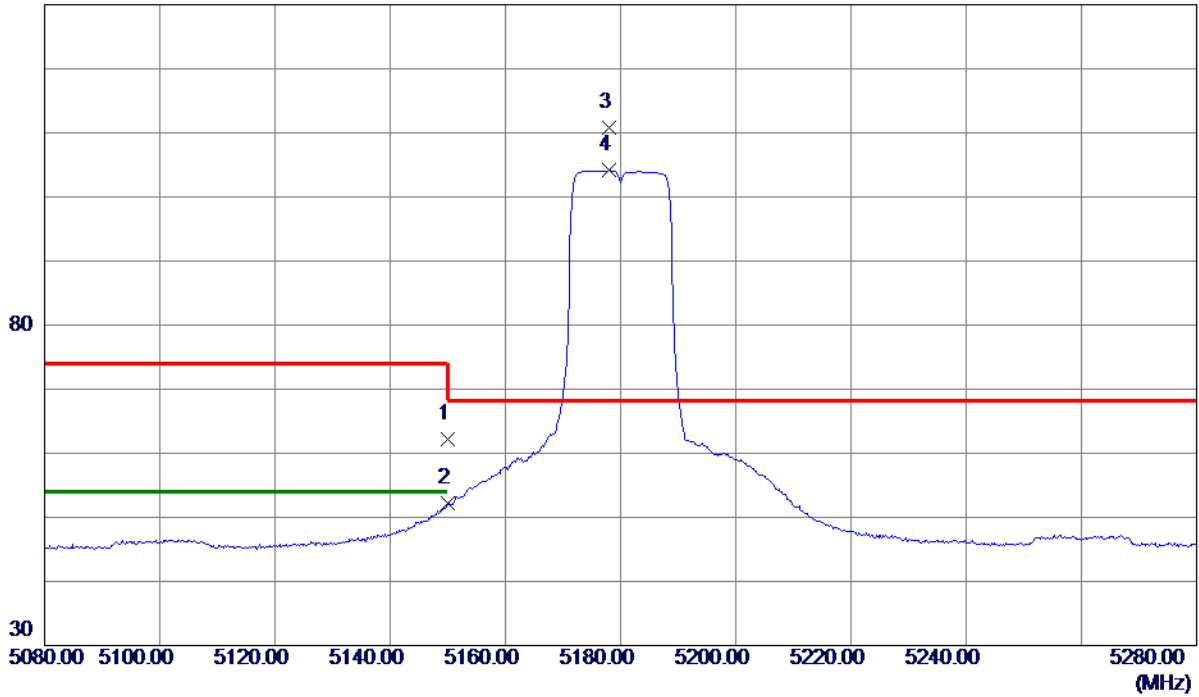

No.	Freq. MHz	Reading Level dBuV/m	Correct Factor dB	Measure ment dBuV/m	Limit dBuV/m	Margin dB	Detector	Comment
1	5150.0000	43.00	19.18	62.18	74.00	-11.82	Peak	
2	5150.0000	33.11	19.18	52.29	54.00	-1.71	AVG	
3 *	5178.0000	91.55	19.28	110.83	68.30	42.53	Peak	No Limit
4	5178.0000	84.93	19.28	104.21	999.00	-894.79	AVG	No Limit

REMARKS:

- (1) Measurement Value = Reading Level + Correct Factor.
- (2) Margin Level = Measurement Value - Limit Value.

Orthogonal Axis	X
Test Mode	UNII-1_TX A Mode 5180 MHz

Vertical

80 dBuV/m

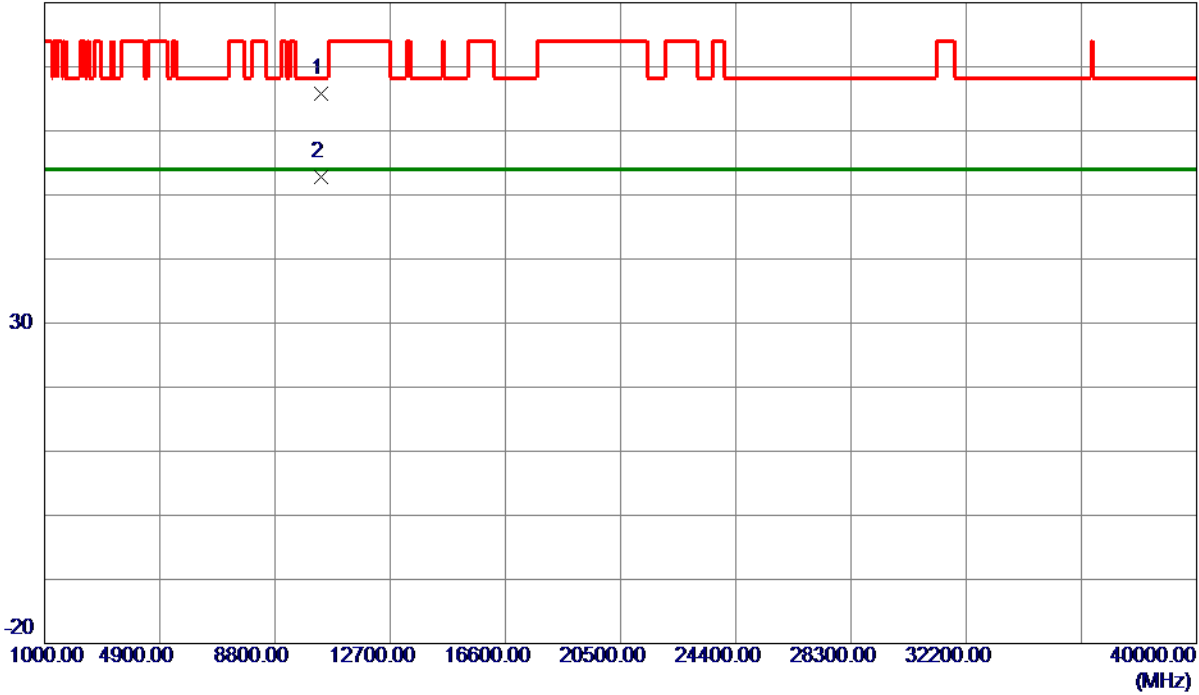

No.	Freq. MHz	Reading Level dBuV/m	Correct Factor dB	Measure ment dBuV/m	Limit dBuV/m	Margin dB	Detector	Comment
1	10355.0500	45.81	19.94	65.75	68.30	-2.55	Peak	
2 *	10356.1200	32.78	19.95	52.73	54.00	-1.27	AVG	

REMARKS:

- (1) Measurement Value = Reading Level + Correct Factor.
- (2) Margin Level = Measurement Value - Limit Value.

Orthogonal Axis	X
Test Mode	UNII-1_TX A Mode 5180 MHz

Horizontal

130 dBuV/m

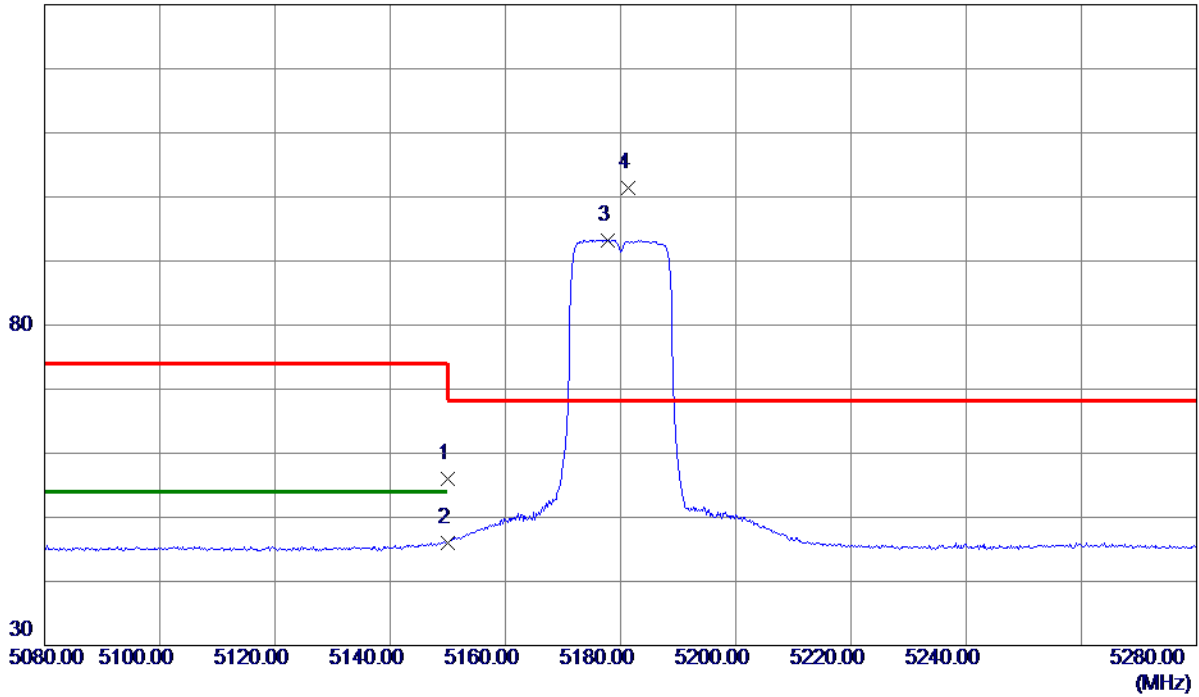

No.	Freq. MHz	Reading Level dBuV/m	Correct Factor dB	Measure ment dBuV/m	Limit dBuV/m	Margin dB	Detector	Comment
1	5150.0000	36.88	19.18	56.06	74.00	-17.94	Peak	
2	5150.0000	26.90	19.18	46.08	54.00	-7.92	AVG	
3	5177.8000	74.00	19.28	93.28	999.00	-905.72	AVG	No Limit
4 *	5181.4000	82.06	19.29	101.35	68.30	33.05	Peak	No Limit

REMARKS:

- (1) Measurement Value = Reading Level + Correct Factor.
- (2) Margin Level = Measurement Value - Limit Value.

Orthogonal Axis	X
Test Mode	UNII-1_TX A Mode 5180 MHz

Horizontal

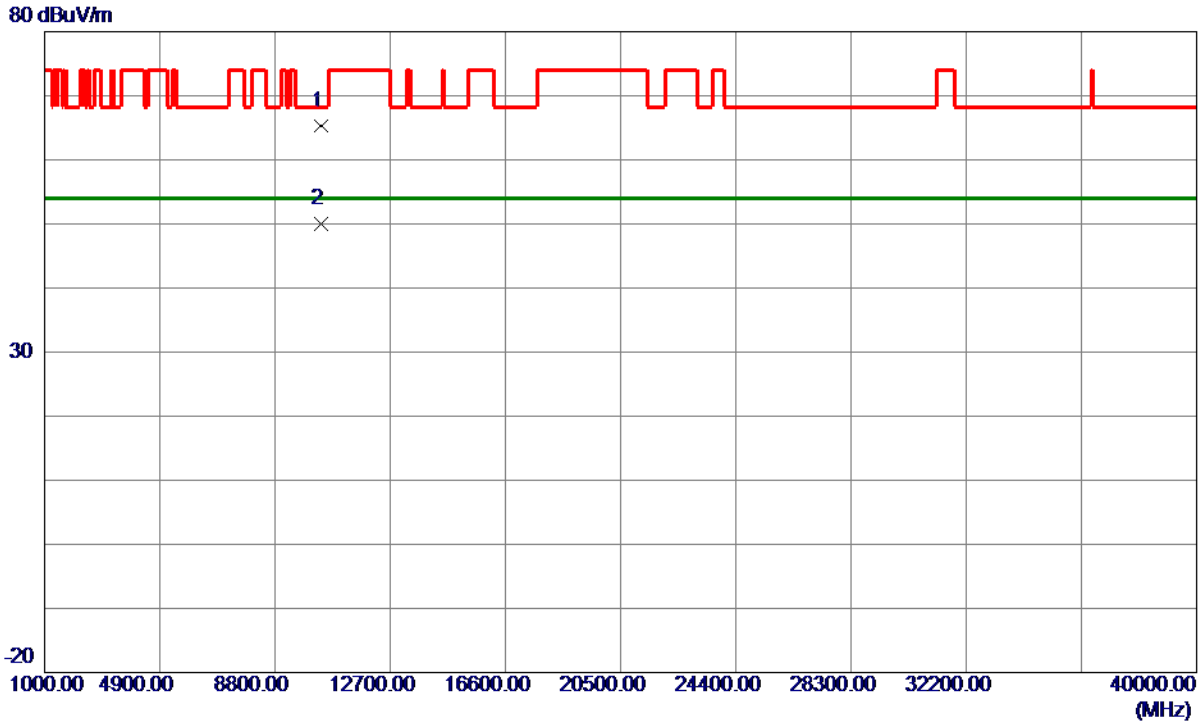

No.	Freq. MHz	Reading Level dBuV/m	Correct Factor dB	Measure ment dBuV/m	Limit dBuV/m	Margin dB	Detector	Comment
1 *	10359.4100	45.34	19.96	65.30	68.30	-3.00	Peak	
2	10356.1200	30.01	19.95	49.96	54.00	-4.04	AVG	

REMARKS:

- (1) Measurement Value = Reading Level + Correct Factor.
- (2) Margin Level = Measurement Value - Limit Value.

Orthogonal Axis	X
Test Mode	UNII-1_TX A Mode 5200 MHz

Vertical

130 dBuV/m

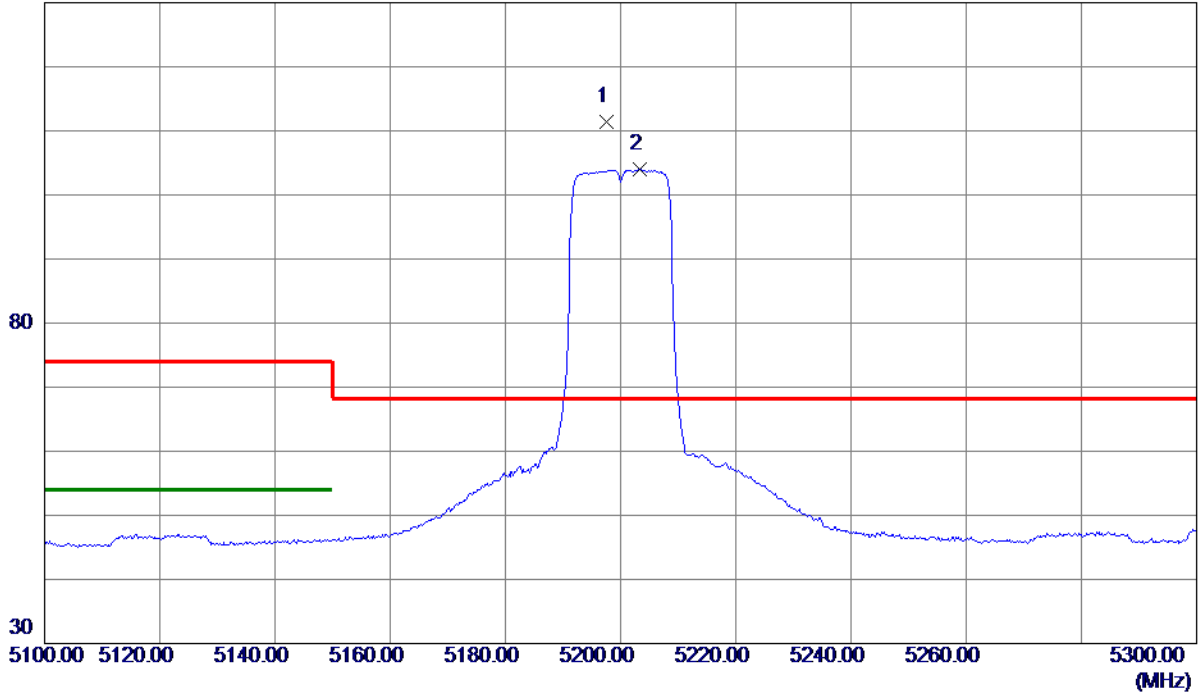

No.	Freq. MHz	Reading Level dBuV/m	Correct Factor dB	Measure ment dBuV/m	Limit dBuV/m	Margin dB	Detector	Comment
1 *	5197.6000	92.03	19.35	111.38	68.30	43.08	Peak	No Limit
2	5203.4000	84.60	19.37	103.97	999.00	-895.03	AVG	No Limit

REMARKS:

- (1) Measurement Value = Reading Level + Correct Factor.
- (2) Margin Level = Measurement Value - Limit Value.

Orthogonal Axis	X
Test Mode	UNII-1_TX A Mode 5200 MHz

Vertical

80 dBuV/m

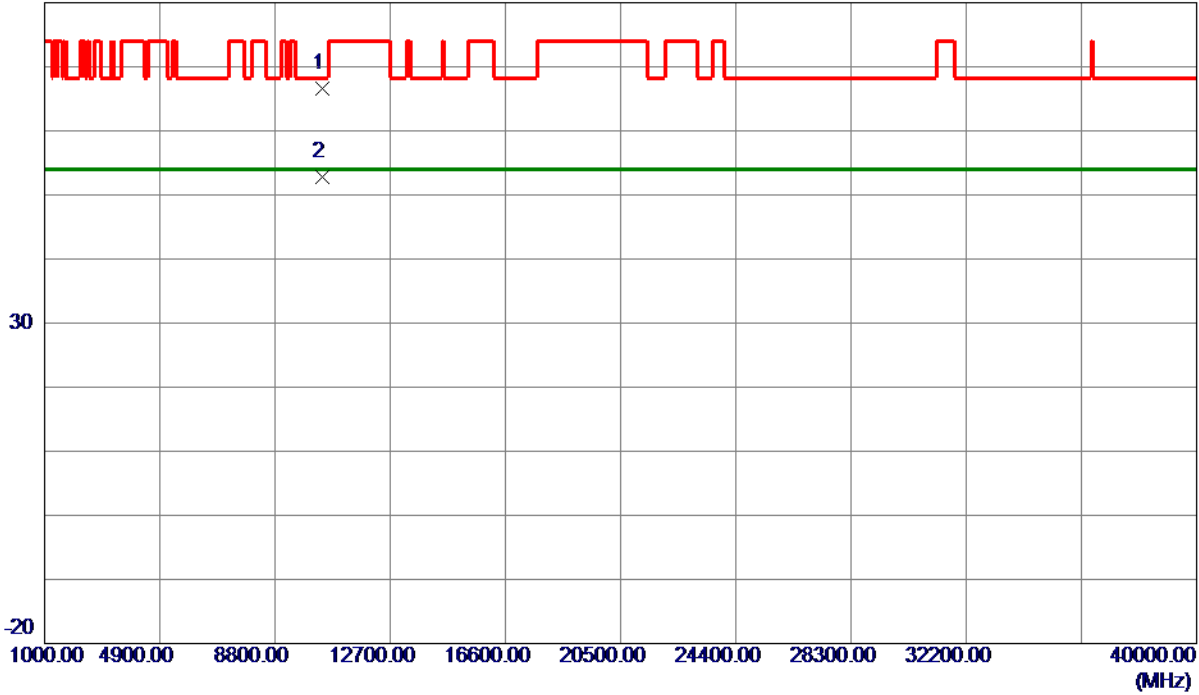

No.	Freq. MHz	Reading Level dBuV/m	Correct Factor dB	Measure ment dBuV/m	Limit dBuV/m	Margin dB	Detector	Comment
1	10399.6000	46.54	20.08	66.62	68.30	-1.68	Peak	
2 *	10398.6100	32.75	20.07	52.82	54.00	-1.18	AVG	

REMARKS:

- (1) Measurement Value = Reading Level + Correct Factor.
- (2) Margin Level = Measurement Value - Limit Value.

Orthogonal Axis	X
Test Mode	UNII-1_TX A Mode 5200 MHz

Horizontal

130 dBuV/m

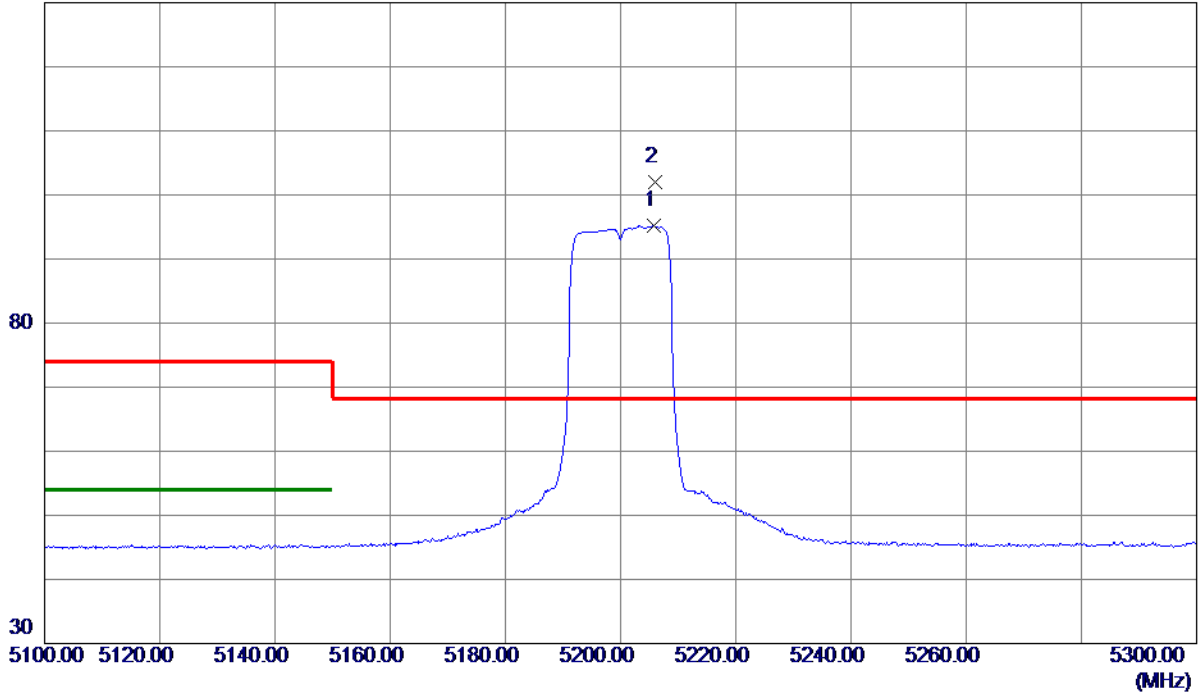

No.	Freq. MHz	Reading Level dBuV/m	Correct Factor dB	Measure ment dBuV/m	Limit dBuV/m	Margin dB	Detector	Comment
1	5205.8000	75.76	19.38	95.14	999.00	-903.86	AVG	No Limit
2 *	5206.0000	82.71	19.38	102.09	68.30	33.79	Peak	No Limit

REMARKS:

- (1) Measurement Value = Reading Level + Correct Factor.
- (2) Margin Level = Measurement Value - Limit Value.

Orthogonal Axis	X
Test Mode	UNII-1_TX A Mode 5200 MHz

Horizontal

80 dBuV/m

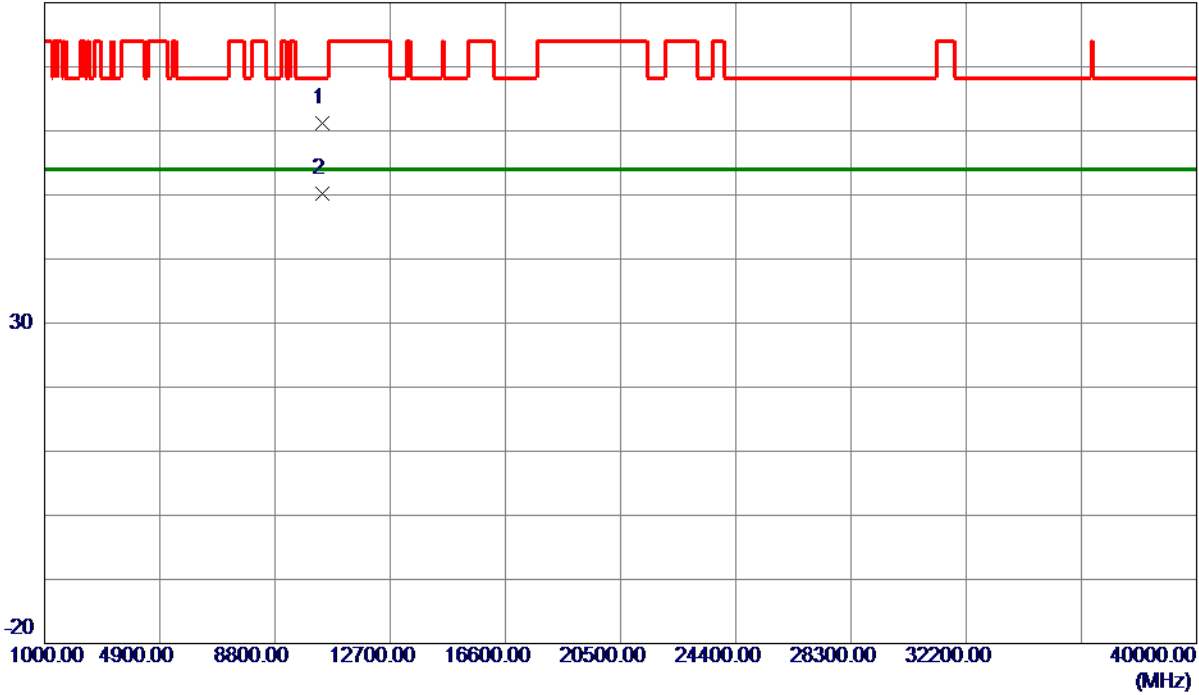

No.	Freq. MHz	Reading Level dBuV/m	Correct Factor dB	Measure ment dBuV/m	Limit dBuV/m	Margin dB	Detector	Comment
1	10392.9000	41.07	20.06	61.13	68.30	-7.17	Peak	
2 *	10392.8400	30.13	20.06	50.19	54.00	-3.81	AVG	

REMARKS:

- (1) Measurement Value = Reading Level + Correct Factor.
- (2) Margin Level = Measurement Value - Limit Value.

Orthogonal Axis	X
Test Mode	UNII-1_TX A Mode 5240 MHz

Vertical

130 dBuV/m

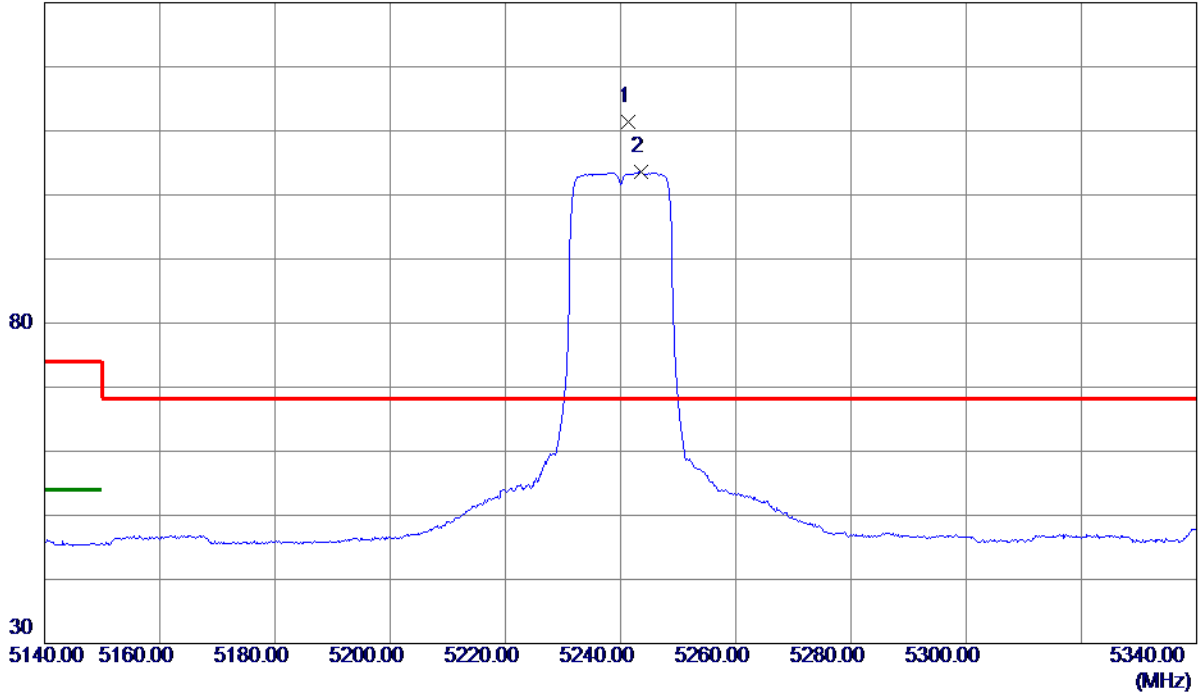

No.	Freq. MHz	Reading Level dBuV/m	Correct Factor dB	Measure ment dBuV/m	Limit dBuV/m	Margin dB	Detector	Comment
1 *	5241.4000	91.85	19.51	111.36	68.30	43.06	Peak	No Limit
2	5243.6000	84.02	19.52	103.54	999.00	-895.46	AVG	No Limit

REMARKS:

- (1) Measurement Value = Reading Level + Correct Factor.
- (2) Margin Level = Measurement Value - Limit Value.

Orthogonal Axis	X
Test Mode	UNII-1_TX A Mode 5240 MHz

Vertical

80 dBuV/m

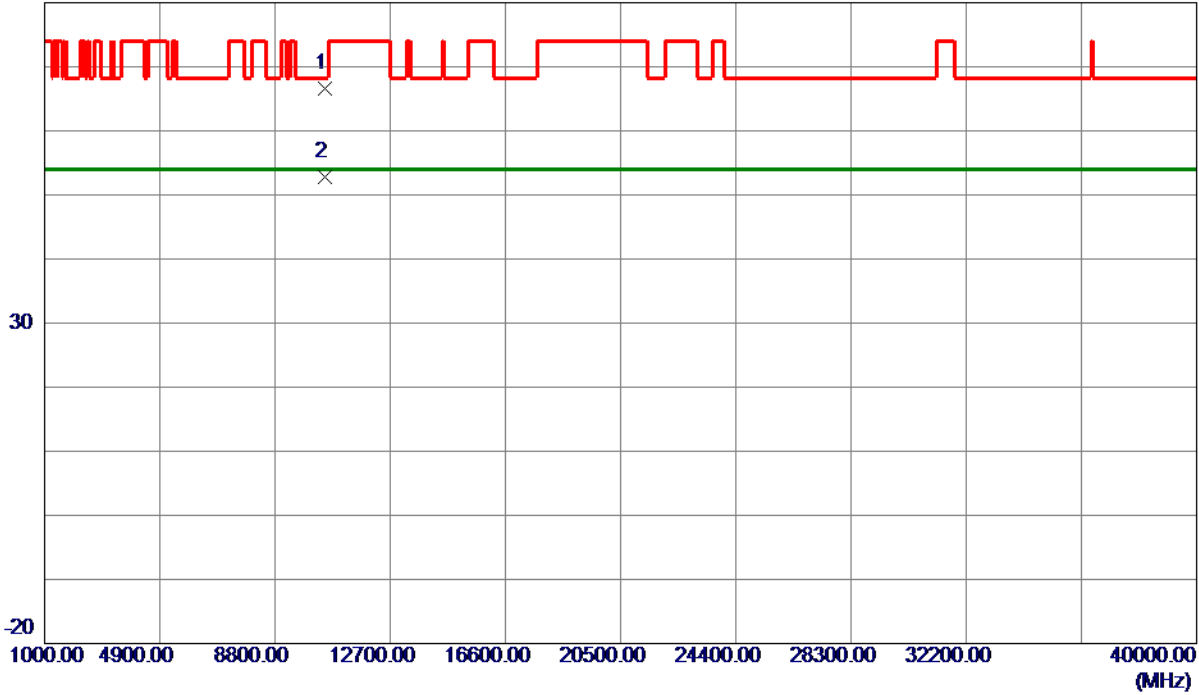

No.	Freq. MHz	Reading Level dBuV/m	Correct Factor dB	Measure ment dBuV/m	Limit dBuV/m	Margin dB	Detector	Comment
1	10479.5000	46.32	20.31	66.63	68.30	-1.67	Peak	
2 *	10479.6520	32.55	20.31	52.86	54.00	-1.14	AVG	

REMARKS:

- (1) Measurement Value = Reading Level + Correct Factor.
- (2) Margin Level = Measurement Value - Limit Value.

Orthogonal Axis	X
Test Mode	UNII-1_TX A Mode 5240 MHz

Horizontal

130 dBuV/m

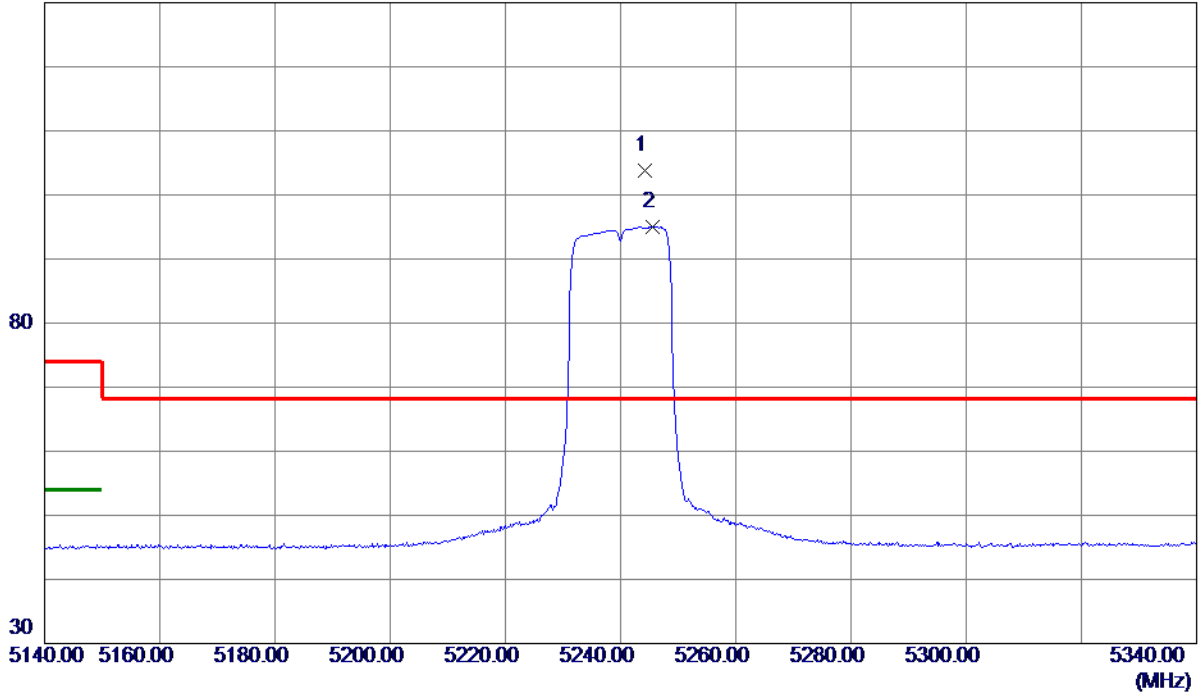

No.	Freq. MHz	Reading Level dBuV/m	Correct Factor dB	Measure ment dBuV/m	Limit dBuV/m	Margin dB	Detector	Comment
1 *	5244.2000	84.32	19.52	103.84	68.30	35.54	Peak	No Limit
2	5245.6000	75.57	19.53	95.10	999.00	-903.90	AVG	No Limit

REMARKS:

- (1) Measurement Value = Reading Level + Correct Factor.
- (2) Margin Level = Measurement Value - Limit Value.

Orthogonal Axis	X
Test Mode	UNII-1_TX A Mode 5240 MHz

Horizontal

80 dBuV/m

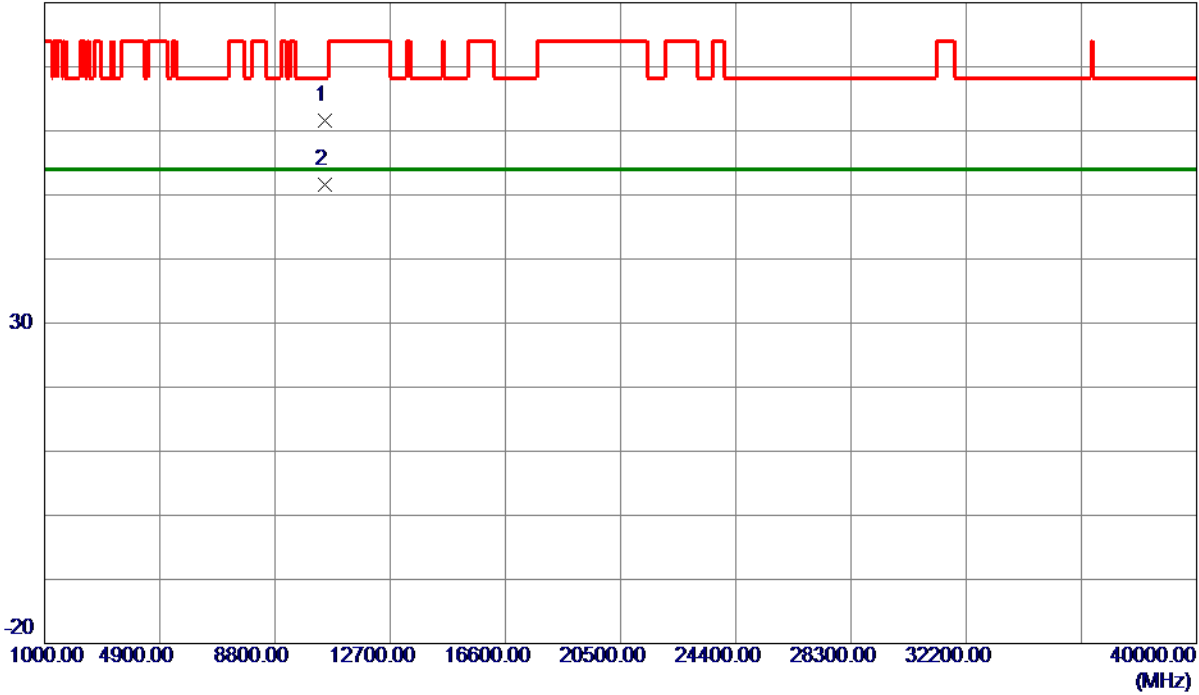

No.	Freq. MHz	Reading Level dBuV/m	Correct Factor dB	Measure ment dBuV/m	Limit dBuV/m	Margin dB	Detector	Comment
1	10482.6500	41.19	20.32	61.51	68.30	-6.79	Peak	
2 *	10482.4100	31.28	20.32	51.60	54.00	-2.40	AVG	

REMARKS:

- (1) Measurement Value = Reading Level + Correct Factor.
- (2) Margin Level = Measurement Value - Limit Value.

Orthogonal Axis	X
Test Mode	UNII-3_TX A Mode 5745 MHz

Vertical

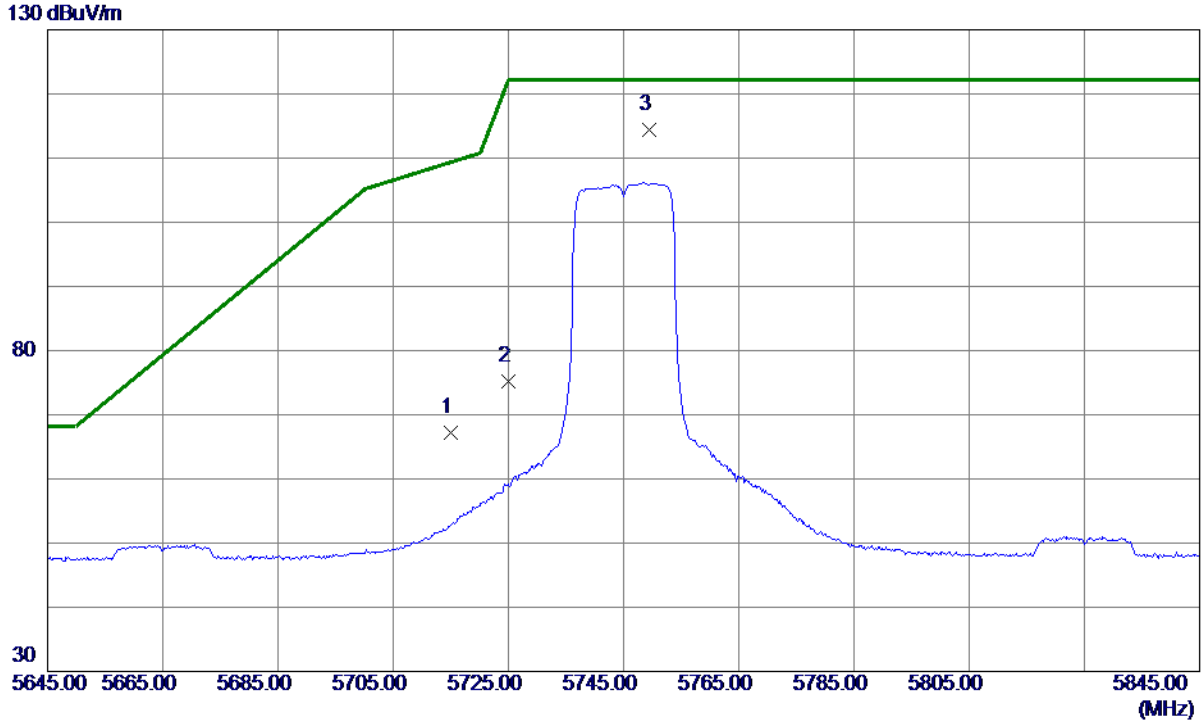

No.	Freq. MHz	Reading Level dBuV/m	Correct Factor dB	Measure ment dBuV/m	Limit dBuV/m	Margin dB	Detector	Comment
1	5715.0000	45.76	21.50	67.26	109.40	-42.14	Peak	
2	5725.0000	53.70	21.55	75.25	122.20	-46.95	Peak	
3 *	5749.4000	92.67	21.67	114.34	122.20	-7.86	Peak	No Limit

REMARKS:

- (1) Measurement Value = Reading Level + Correct Factor.
- (2) Margin Level = Measurement Value - Limit Value.

Orthogonal Axis	X
Test Mode	UNII-3_TX A Mode 5745 MHz

Vertical

80 dBuV/m

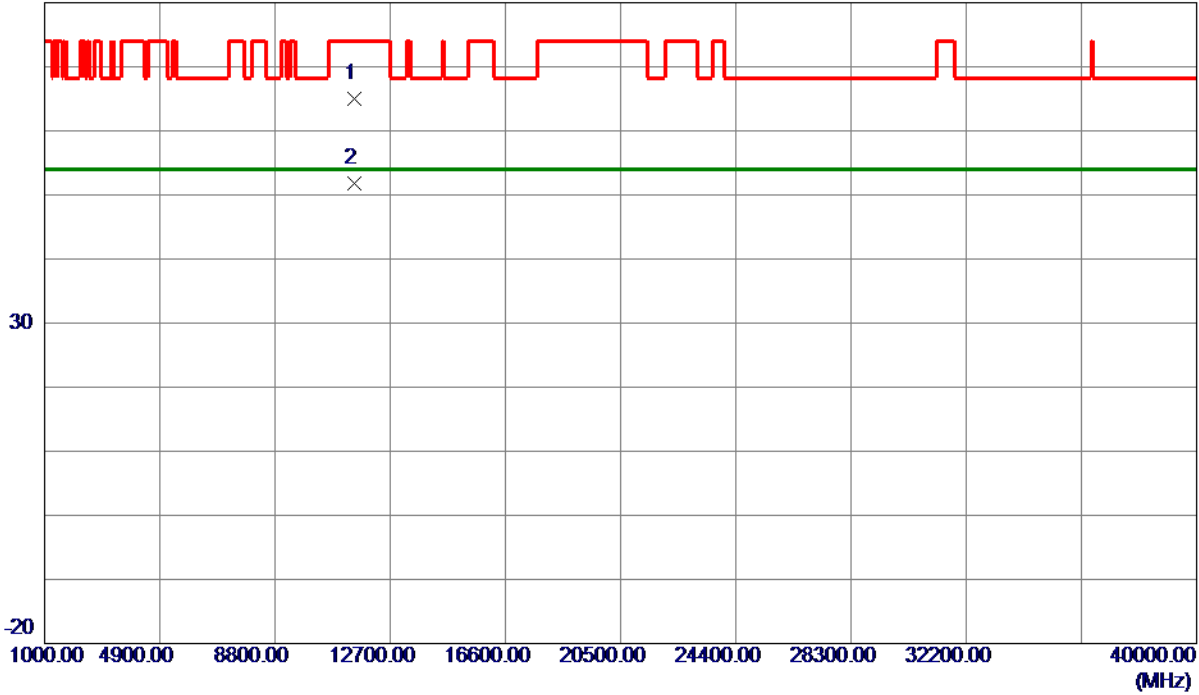

No.	Freq. MHz	Reading Level dBuV/m	Correct Factor dB	Measure ment dBuV/m	Limit dBuV/m	Margin dB	Detector	Comment
1	11489.3500	45.29	19.71	65.00	74.00	-9.00	Peak	
2 *	11489.9000	32.14	19.70	51.84	54.00	-2.16	AVG	

REMARKS:

- (1) Measurement Value = Reading Level + Correct Factor.
- (2) Margin Level = Measurement Value - Limit Value.

Orthogonal Axis	X
Test Mode	UNII-3_TX A Mode 5745 MHz

Horizontal

130 dBuV/m

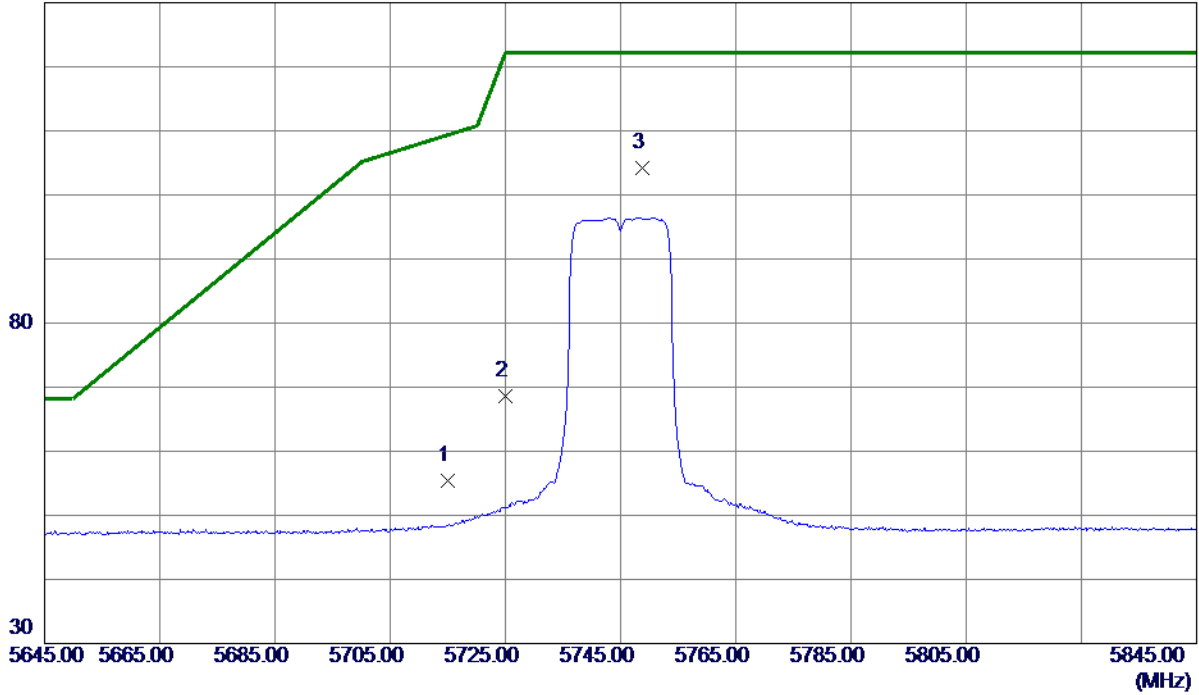

No.	Freq. MHz	Reading Level dBuV/m	Correct Factor dB	Measure ment dBuV/m	Limit dBuV/m	Margin dB	Detector	Comment
1	5715.0000	33.95	21.50	55.45	109.40	-53.95	Peak	
2	5725.0000	47.02	21.55	68.57	122.20	-53.63	Peak	
3 *	5748.8000	82.59	21.67	104.26	122.20	-17.94	Peak	No Limit

REMARKS:

- (1) Measurement Value = Reading Level + Correct Factor.
- (2) Margin Level = Measurement Value - Limit Value.

Orthogonal Axis	X
Test Mode	UNII-3_TX A Mode 5745 MHz

Horizontal

80 dBuV/m

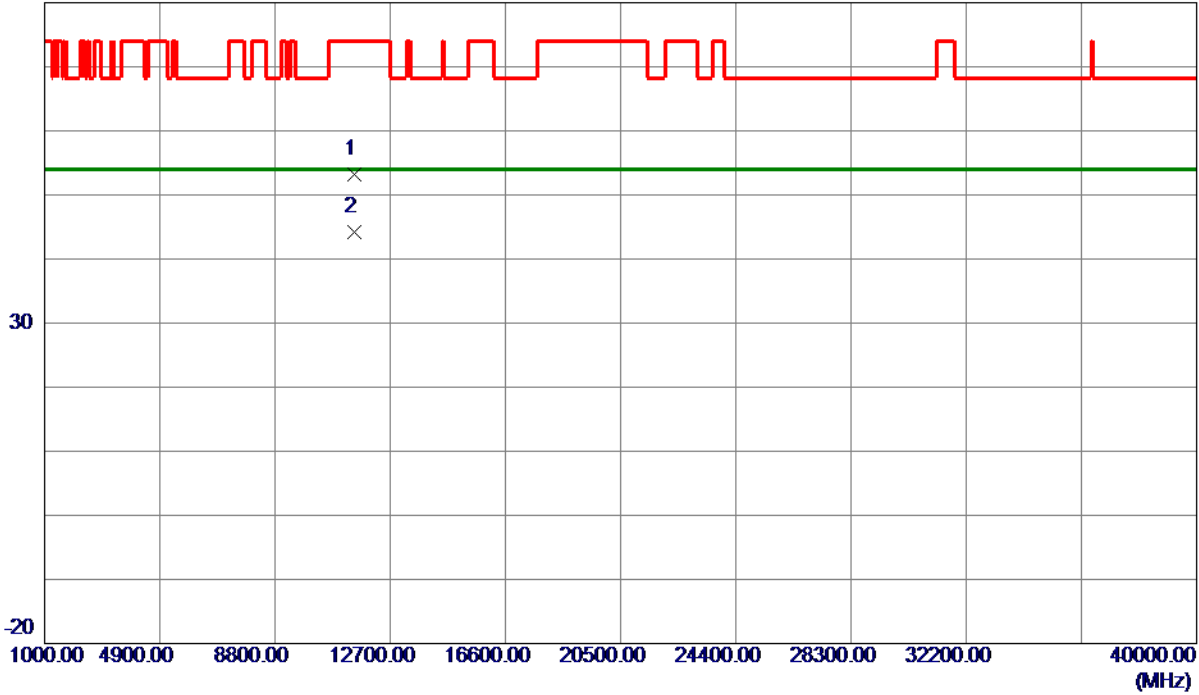

No.	Freq. MHz	Reading Level dBuV/m	Correct Factor dB	Measure ment dBuV/m	Limit dBuV/m	Margin dB	Detector	Comment
1	11490.1000	33.48	19.70	53.18	74.00	-20.82	Peak	
2 *	11491.4500	24.58	19.70	44.28	54.00	-9.72	AVG	

REMARKS:

- (1) Measurement Value = Reading Level + Correct Factor.
- (2) Margin Level = Measurement Value - Limit Value.

Orthogonal Axis	X
Test Mode	UNII-3_TX A Mode 5785 MHz

Vertical

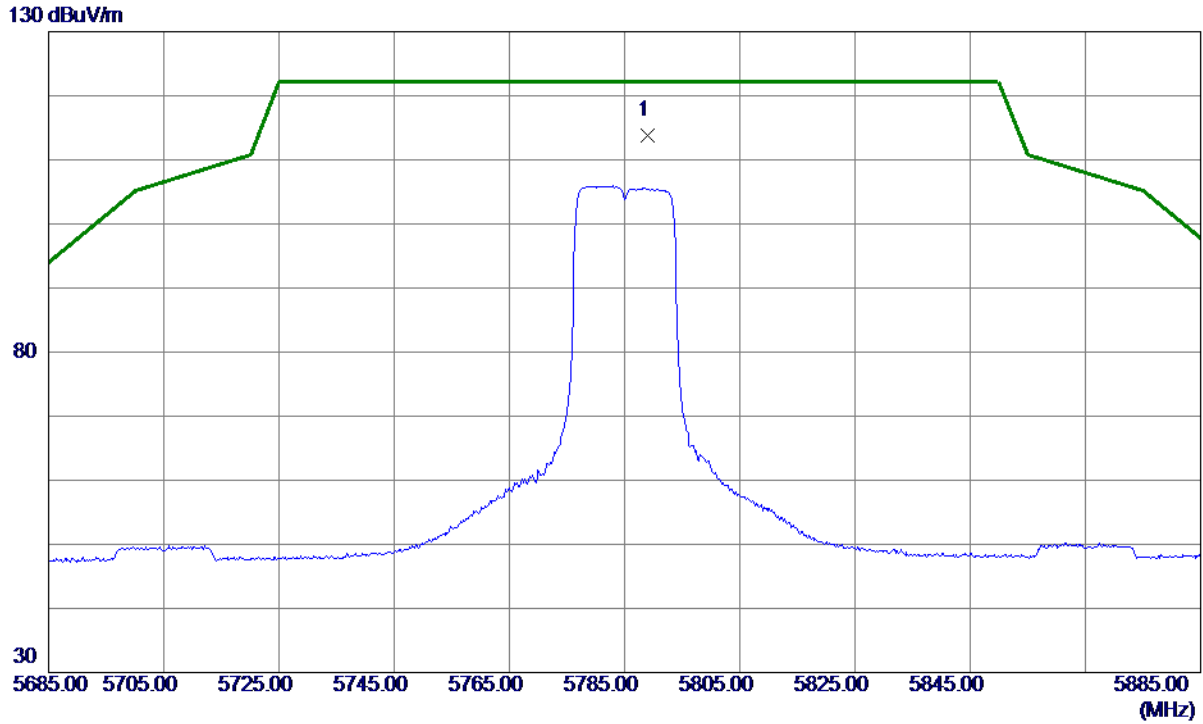

No.	Freq. MHz	Reading Level dBuV/m	Correct Factor dB	Measure ment dBuV/m	Limit dBuV/m	Margin dB	Detector	Comment
1 *	5789.0000	92.02	21.86	113.88	122.20	-8.32	Peak	No Limit

REMARKS:

- (1) Measurement Value = Reading Level + Correct Factor.
- (2) Margin Level = Measurement Value - Limit Value.

Orthogonal Axis	X
Test Mode	UNII-3_TX A Mode 5785 MHz

Vertical

80 dBuV/m

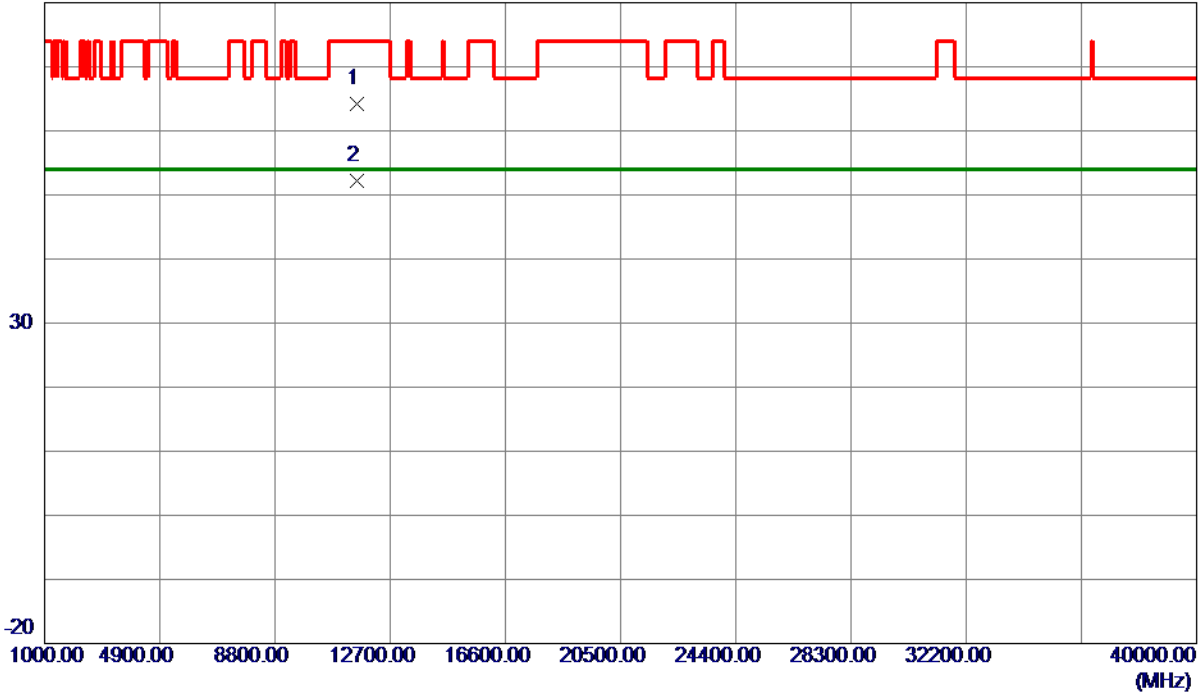

No.	Freq. MHz	Reading Level dBuV/m	Correct Factor dB	Measure ment dBuV/m	Limit dBuV/m	Margin dB	Detector	Comment
1	11569.6000	44.73	19.49	64.22	74.00	-9.78	Peak	
2 *	11570.3500	32.79	19.49	52.28	54.00	-1.72	AVG	

REMARKS:

- (1) Measurement Value = Reading Level + Correct Factor.
- (2) Margin Level = Measurement Value - Limit Value.

Orthogonal Axis	X
Test Mode	UNII-3_TX A Mode 5785 MHz

Horizontal

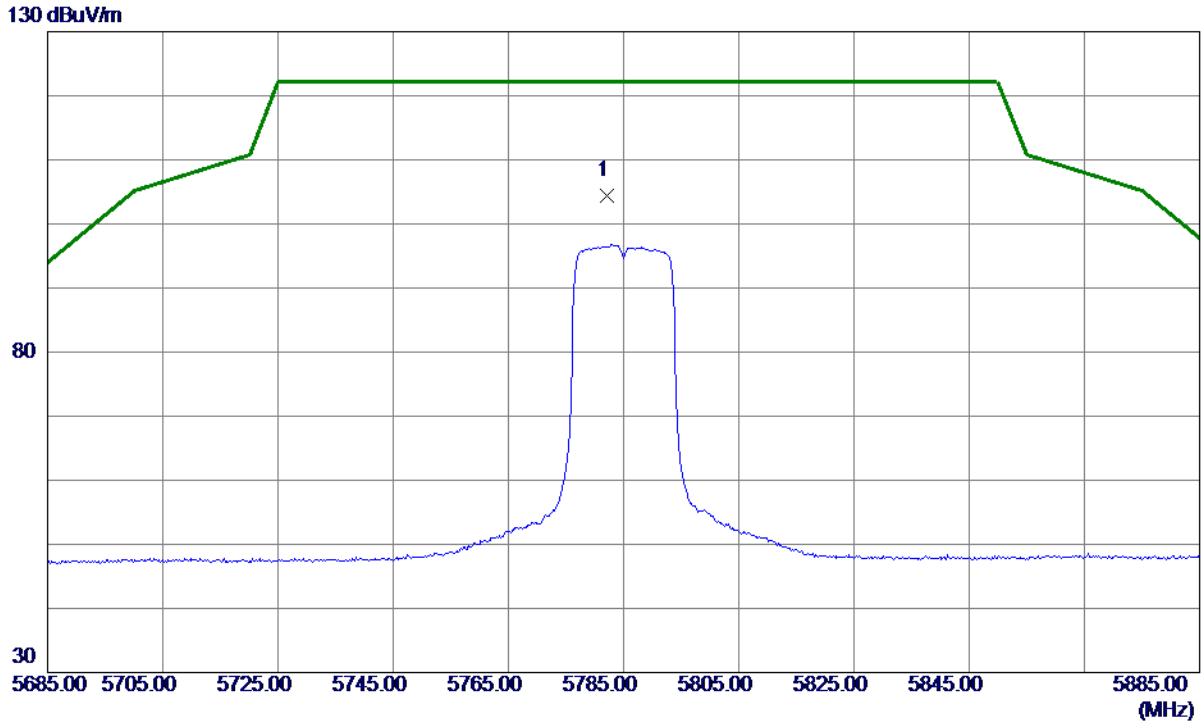

No.	Freq. MHz	Reading Level dBuV/m	Correct Factor dB	Measure ment dBuV/m	Limit dBuV/m	Margin dB	Detector	Comment
1 *	5782.2000	82.55	21.83	104.38	122.20	-17.82	Peak	No Limit

REMARKS:

- (1) Measurement Value = Reading Level + Correct Factor.
- (2) Margin Level = Measurement Value - Limit Value.

Orthogonal Axis	X
Test Mode	UNII-3_TX A Mode 5785 MHz

Horizontal

80 dBuV/m

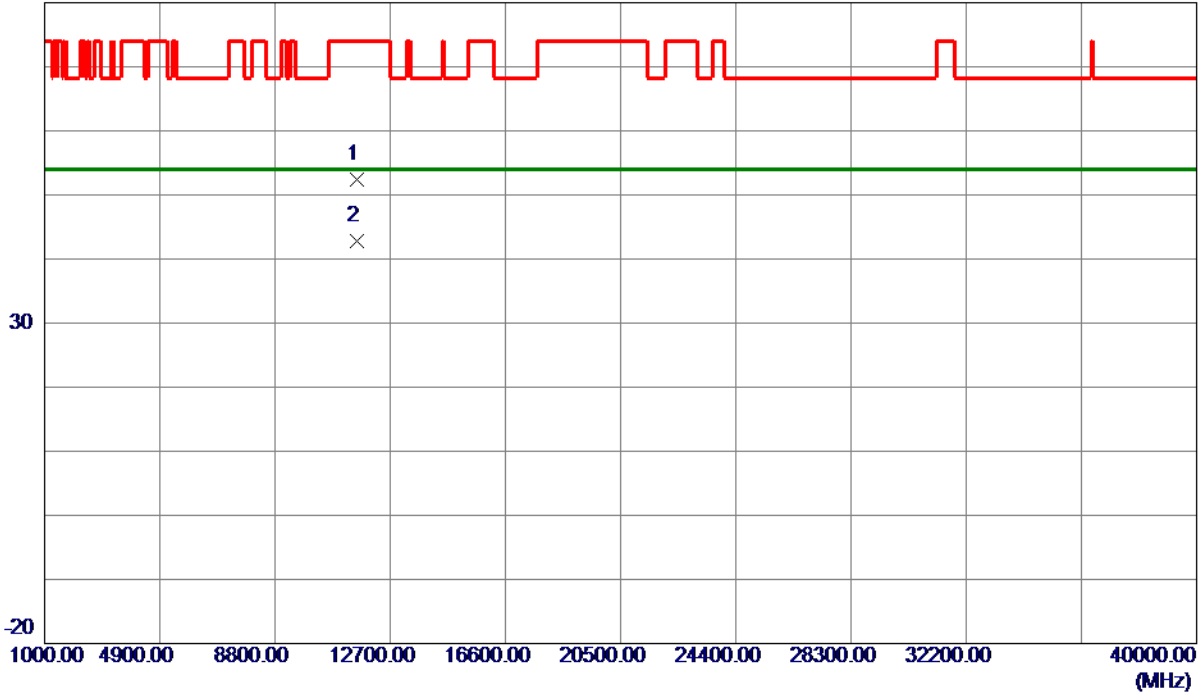

No.	Freq. MHz	Reading Level dBuV/m	Correct Factor dB	Measure ment dBuV/m	Limit dBuV/m	Margin dB	Detector	Comment
1	11569.3000	32.93	19.49	52.42	74.00	-21.58	Peak	
2 *	11569.7500	23.31	19.49	42.80	54.00	-11.20	AVG	

REMARKS:

- (1) Measurement Value = Reading Level + Correct Factor.
- (2) Margin Level = Measurement Value - Limit Value.

Orthogonal Axis	X
Test Mode	UNII-3_TX A Mode 5825 MHz

Vertical

130 dBuV/m

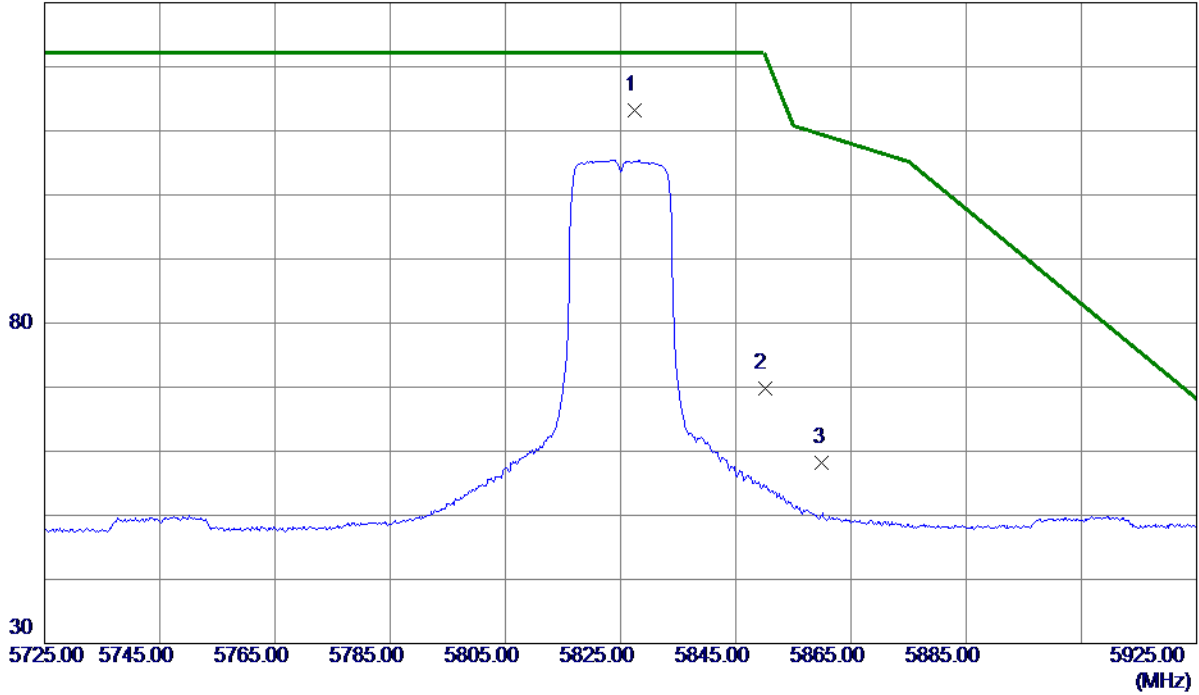

No.	Freq. MHz	Reading Level dBuV/m	Correct Factor dB	Measure ment dBuV/m	Limit dBuV/m	Margin dB	Detector	Comment
1 *	5827.4000	91.08	22.05	113.13	122.20	-9.07	Peak	No Limit
2	5850.0000	47.72	22.16	69.88	122.20	-52.32	Peak	
3	5860.0000	35.96	22.21	58.17	109.40	-51.23	Peak	

REMARKS:

- (1) Measurement Value = Reading Level + Correct Factor.
- (2) Margin Level = Measurement Value - Limit Value.

Orthogonal Axis	X
Test Mode	UNII-3_TX A Mode 5825 MHz

Vertical

80 dBuV/m

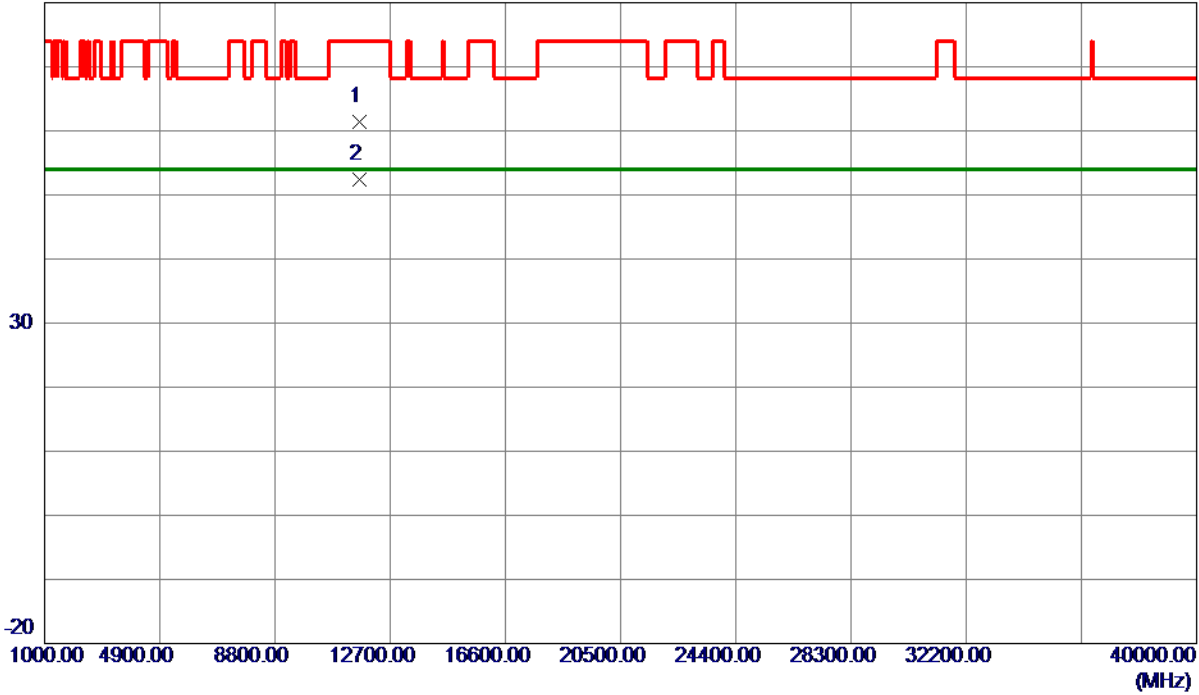

No.	Freq. MHz	Reading Level dBuV/m	Correct Factor dB	Measure ment dBuV/m	Limit dBuV/m	Margin dB	Detector	Comment
1	11650.1000	42.05	19.27	61.32	74.00	-12.68	Peak	
2 *	11650.2500	33.10	19.27	52.37	54.00	-1.63	AVG	

REMARKS:

- (1) Measurement Value = Reading Level + Correct Factor.
- (2) Margin Level = Measurement Value - Limit Value.

Orthogonal Axis	X
Test Mode	UNII-3_TX A Mode 5825 MHz

Horizontal

130 dBuV/m

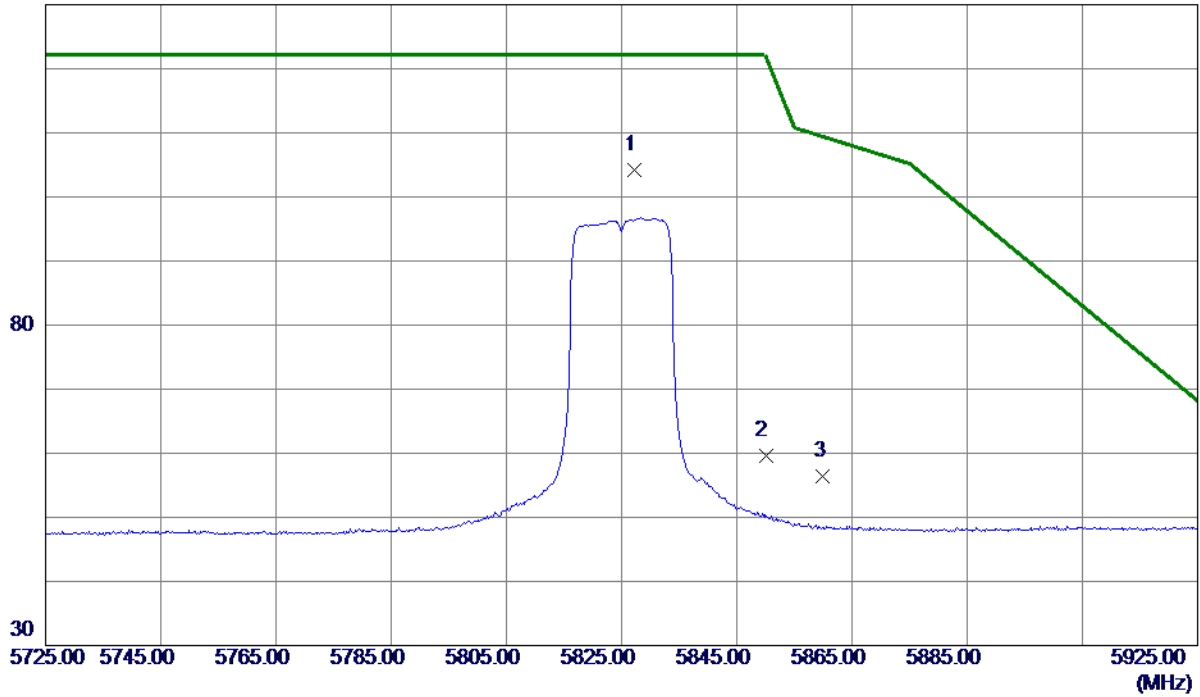

No.	Freq. MHz	Reading Level dBuV/m	Correct Factor dB	Measure ment dBuV/m	Limit dBuV/m	Margin dB	Detector	Comment
1 *	5827.2000	82.13	22.05	104.18	122.20	-18.02	Peak	No Limit
2	5850.0000	37.46	22.16	59.62	122.20	-62.58	Peak	
3	5860.0000	34.12	22.21	56.33	109.40	-53.07	Peak	

REMARKS:

- (1) Measurement Value = Reading Level + Correct Factor.
- (2) Margin Level = Measurement Value - Limit Value.

Orthogonal Axis	X
Test Mode	UNII-3_TX A Mode 5825 MHz

Horizontal

80 dBuV/m

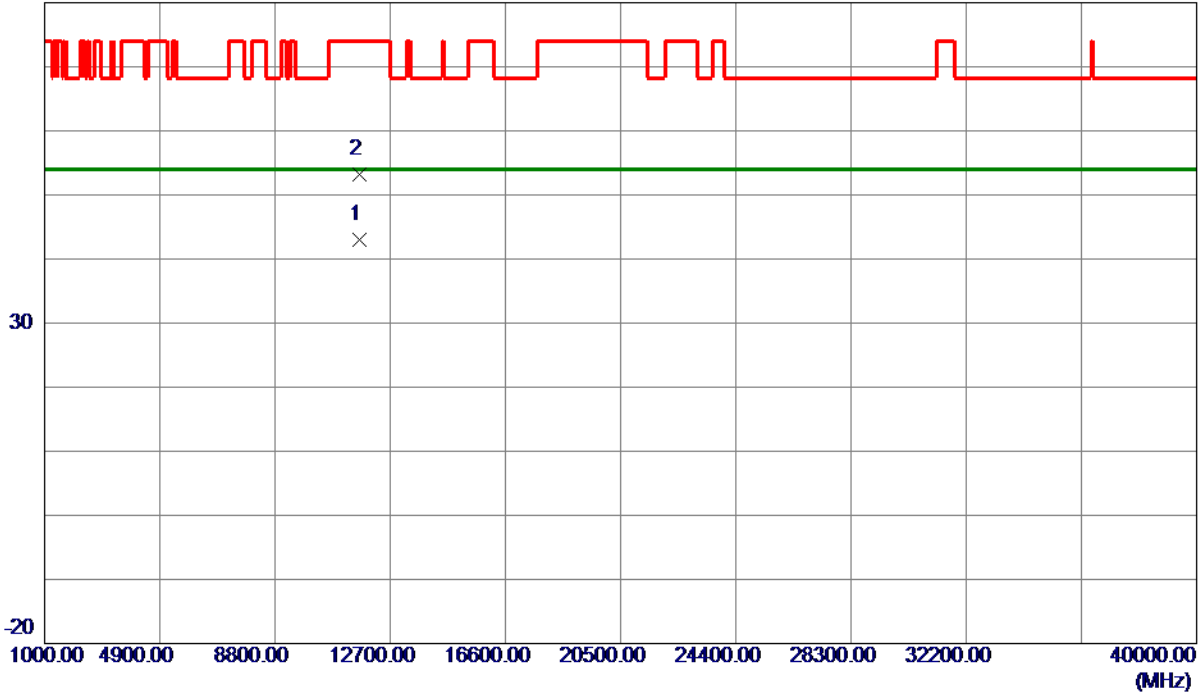

No.	Freq. MHz	Reading Level dBuV/m	Correct Factor dB	Measure ment dBuV/m	Limit dBuV/m	Margin dB	Detector	Comment
1 *	11649.6500	23.73	19.27	43.00	54.00	-11.00	AVG	
2	11649.8500	33.95	19.27	53.22	74.00	-20.78	Peak	

REMARKS:

- (1) Measurement Value = Reading Level + Correct Factor.
- (2) Margin Level = Measurement Value - Limit Value.

Orthogonal Axis	X
Test Mode	UNII-1_TX AC (VHT20) Mode 5180 MHz

Vertical

130 dBuV/m

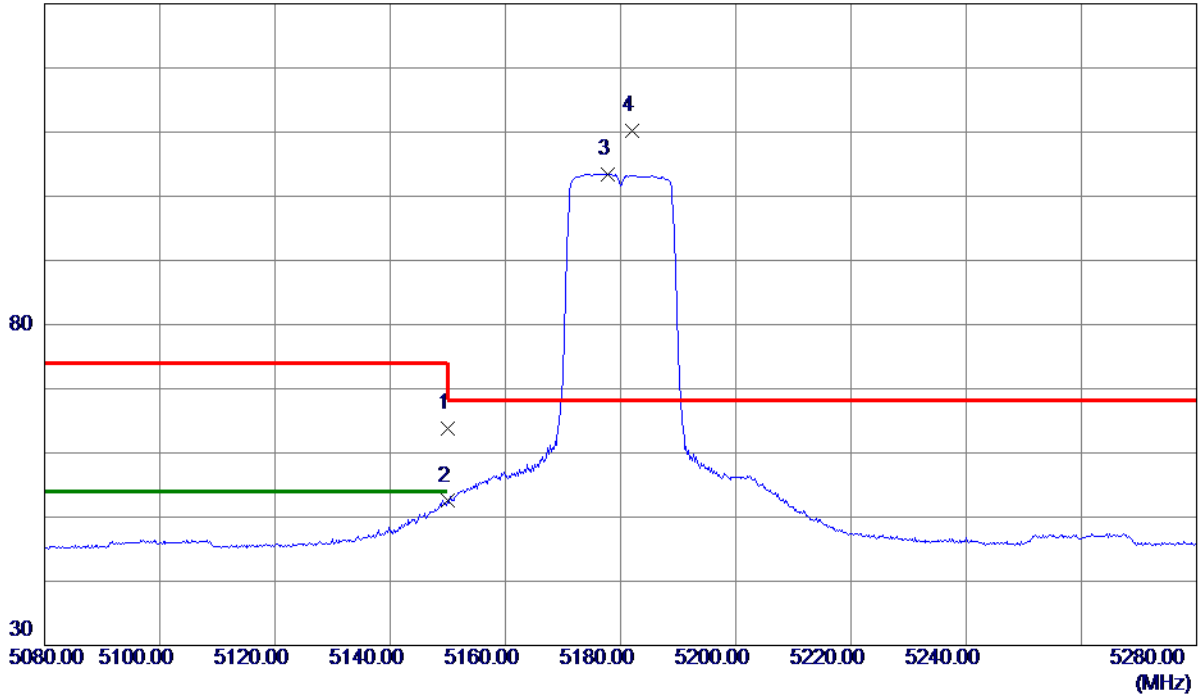

No.	Freq. MHz	Reading Level dBuV/m	Correct Factor dB	Measure ment dBuV/m	Limit dBuV/m	Margin dB	Detector	Comment
1	5150.0000	44.53	19.18	63.71	74.00	-10.29	Peak	
2	5150.0000	33.32	19.18	52.50	54.00	-1.50	AVG	
3	5177.8000	84.21	19.28	103.49	999.00	-895.51	AVG	No Limit
4 *	5182.0000	90.82	19.29	110.11	68.30	41.81	Peak	No Limit

REMARKS:

- (1) Measurement Value = Reading Level + Correct Factor.
- (2) Margin Level = Measurement Value - Limit Value.

Orthogonal Axis	X
Test Mode	UNII-1_TX AC (VHT20) Mode 5180 MHz

Vertical

80 dBuV/m

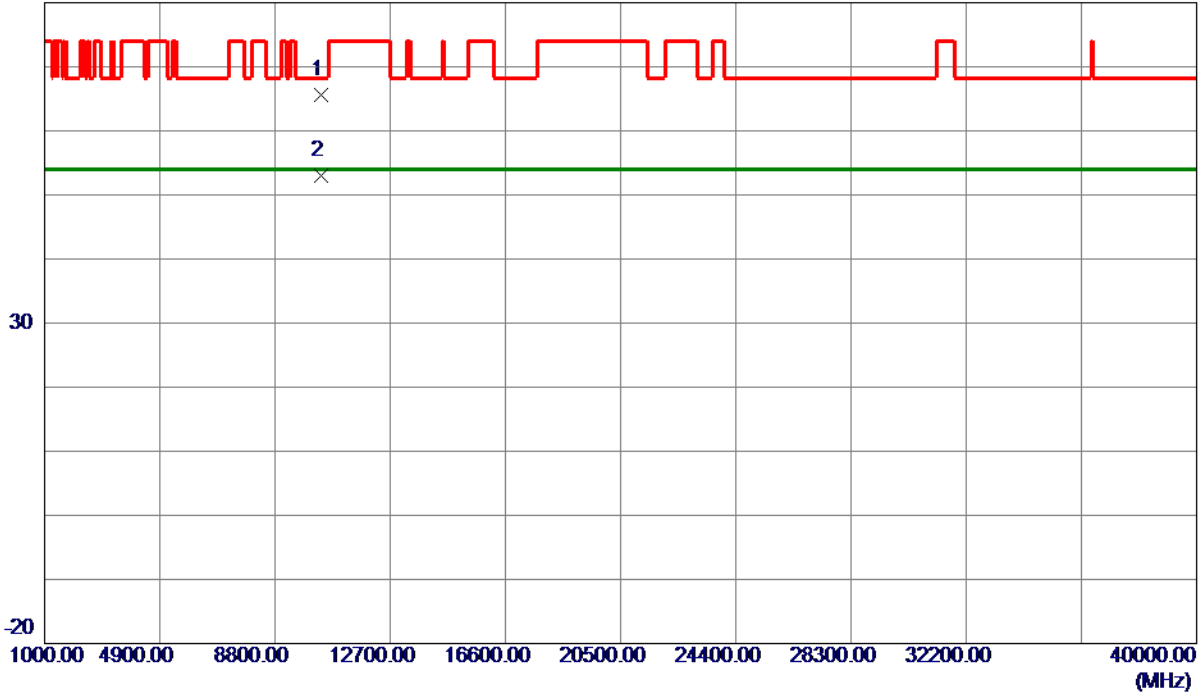

No.	Freq. MHz	Reading Level dBuV/m	Correct Factor dB	Measure ment dBuV/m	Limit dBuV/m	Margin dB	Detector	Comment
1	10360.9000	45.60	19.96	65.56	68.30	-2.74	Peak	
2 *	10360.7800	32.97	19.96	52.93	54.00	-1.07	AVG	

REMARKS:

- (1) Measurement Value = Reading Level + Correct Factor.
- (2) Margin Level = Measurement Value - Limit Value.

Orthogonal Axis	X
Test Mode	UNII-1_TX AC (VHT20) Mode 5180 MHz

Horizontal

130 dBuV/m

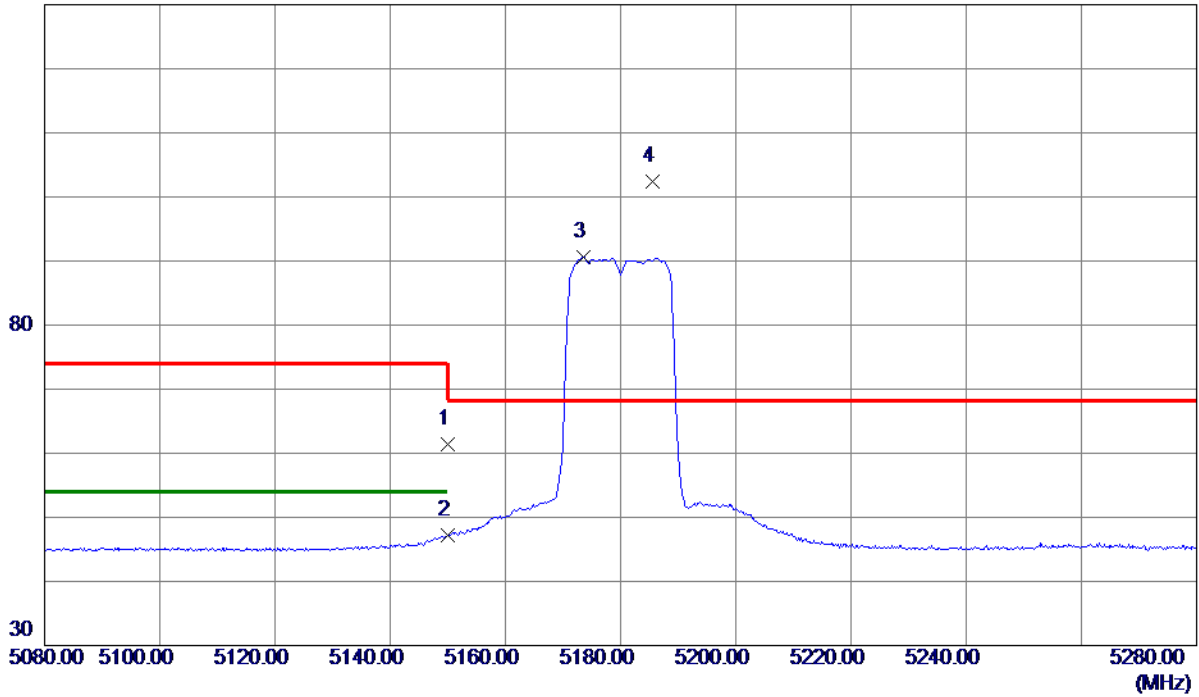

No.	Freq. MHz	Reading Level dBuV/m	Correct Factor dB	Measure ment dBuV/m	Limit dBuV/m	Margin dB	Detector	Comment
1	5150.0000	42.20	19.18	61.38	74.00	-12.62	Peak	
2	5150.0000	27.94	19.18	47.12	54.00	-6.88	AVG	
3	5173.6000	71.41	19.26	90.67	999.00	-908.33	AVG	No Limit
4 *	5185.6000	83.01	19.31	102.32	68.30	34.02	Peak	No Limit

REMARKS:

- (1) Measurement Value = Reading Level + Correct Factor.
- (2) Margin Level = Measurement Value - Limit Value.

Orthogonal Axis	X
Test Mode	UNII-1_TX AC (VHT20) Mode 5180 MHz

Horizontal

80 dBuV/m

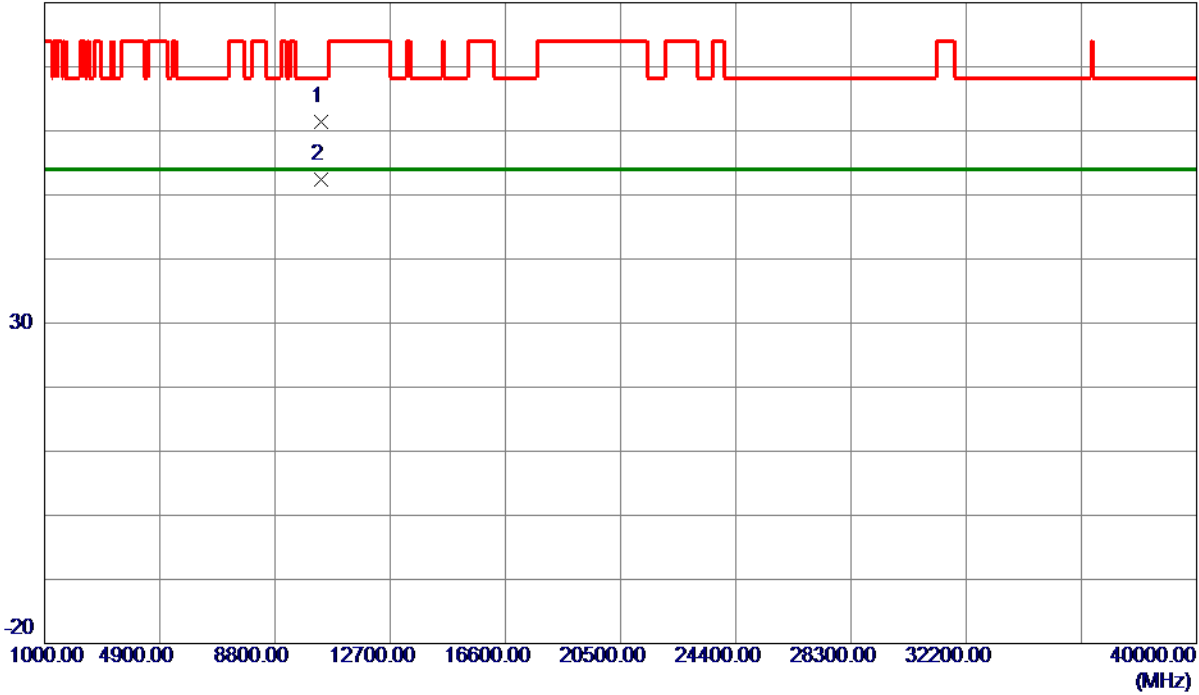

No.	Freq. MHz	Reading Level dBuV/m	Correct Factor dB	Measure ment dBuV/m	Limit dBuV/m	Margin dB	Detector	Comment
1	10357.3000	41.49	19.95	61.44	68.30	-6.86	Peak	
2 *	10357.2400	32.45	19.95	52.40	54.00	-1.60	AVG	

REMARKS:

- (1) Measurement Value = Reading Level + Correct Factor.
- (2) Margin Level = Measurement Value - Limit Value.

Orthogonal Axis	X
Test Mode	UNII-1_TX AC (VHT20) Mode 5200 MHz

Vertical

130 dBuV/m

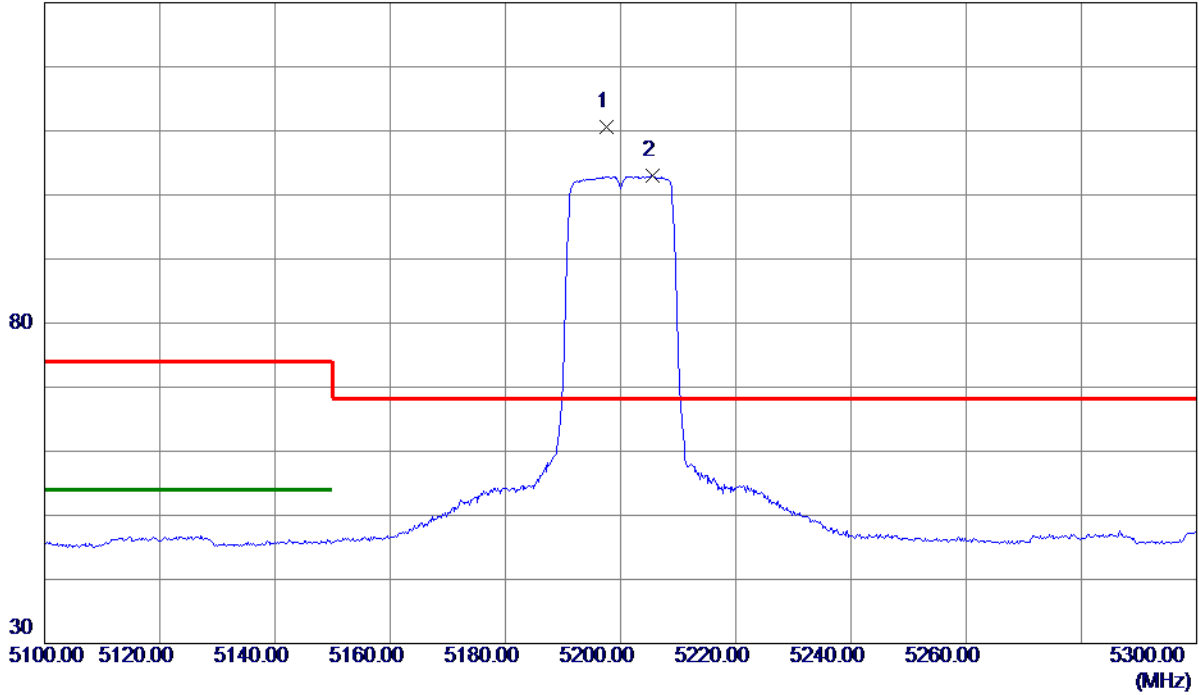

No.	Freq. MHz	Reading Level dBuV/m	Correct Factor dB	Measure ment dBuV/m	Limit dBuV/m	Margin dB	Detector	Comment
1 *	5197.6000	91.26	19.35	110.61	68.30	42.31	Peak	No Limit
2	5205.6000	83.60	19.38	102.98	999.00	-896.02	AVG	No Limit

REMARKS:

- (1) Measurement Value = Reading Level + Correct Factor.
- (2) Margin Level = Measurement Value - Limit Value.

Orthogonal Axis	X
Test Mode	UNII-1_TX AC (VHT20) Mode 5200 MHz

Vertical

80 dBuV/m

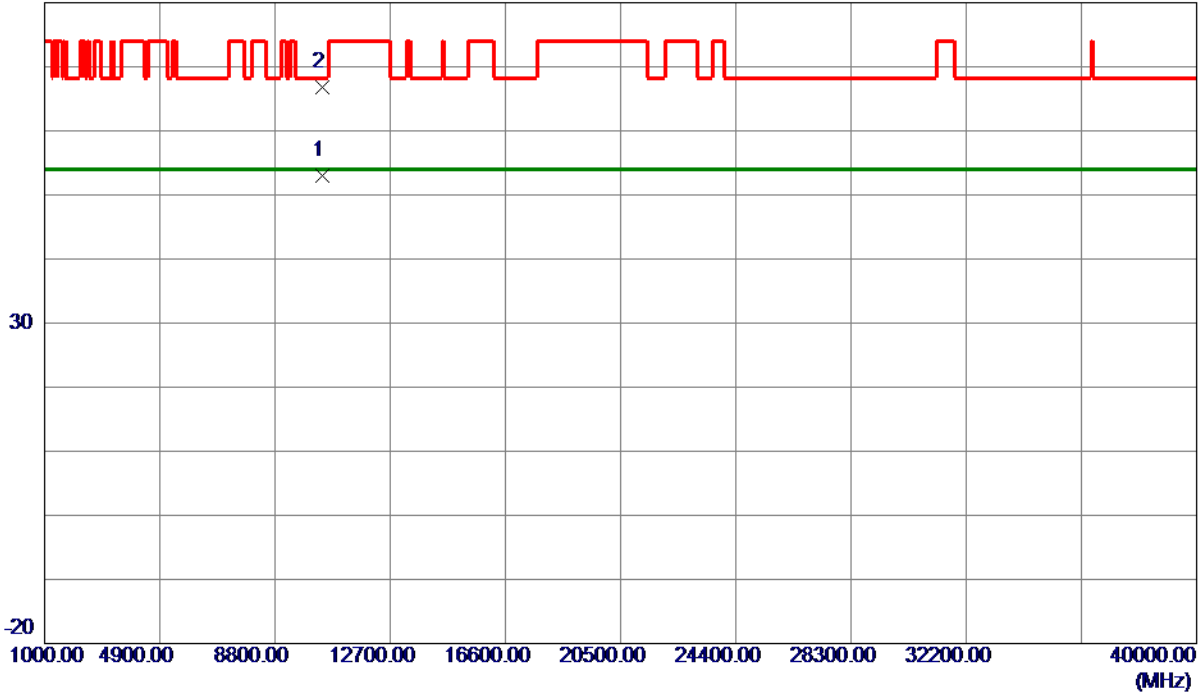

No.	Freq. MHz	Reading Level dBuV/m	Correct Factor dB	Measure ment dBuV/m	Limit dBuV/m	Margin dB	Detector	Comment
1 *	10391.1400	32.94	20.05	52.99	54.00	-1.01	AVG	
2	10400.5000	46.78	20.08	66.86	68.30	-1.44	Peak	

REMARKS:

- (1) Measurement Value = Reading Level + Correct Factor.
- (2) Margin Level = Measurement Value - Limit Value.

Orthogonal Axis	X
Test Mode	UNII-1_TX AC (VHT20) Mode 5200 MHz

Horizontal

130 dBuV/m

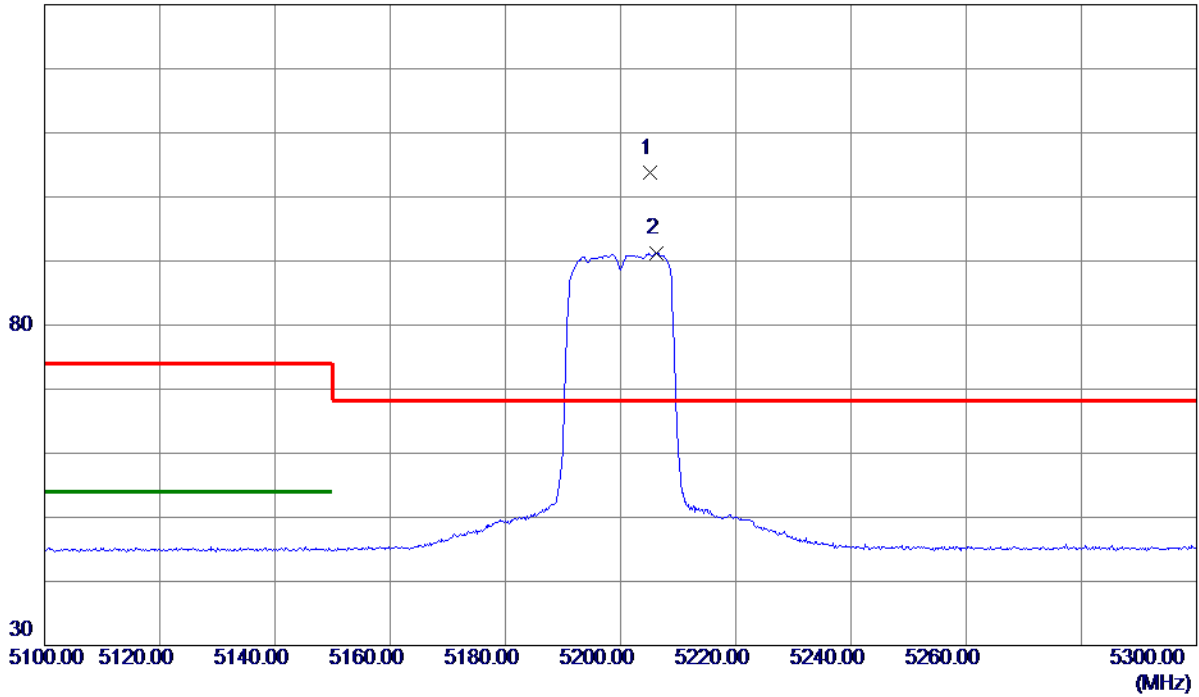

No.	Freq. MHz	Reading Level dBuV/m	Correct Factor dB	Measure ment dBuV/m	Limit dBuV/m	Margin dB	Detector	Comment
1 *	5205.2000	84.32	19.38	103.70	68.30	35.40	Peak	No Limit
2	5206.2000	71.84	19.38	91.22	999.00	-907.78	AVG	No Limit

REMARKS:

- (1) Measurement Value = Reading Level + Correct Factor.
- (2) Margin Level = Measurement Value - Limit Value.

Orthogonal Axis	X
Test Mode	UNII-1_TX AC (VHT20) Mode 5200 MHz

Horizontal

80 dBuV/m

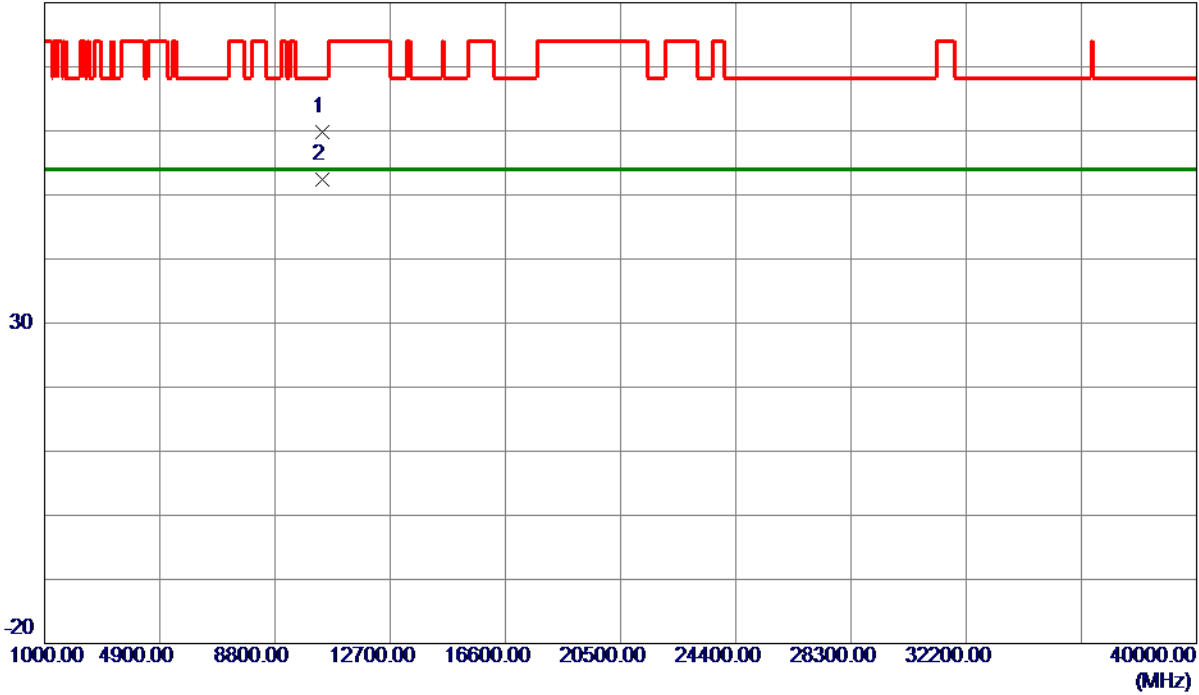

No.	Freq. MHz	Reading Level dBuV/m	Correct Factor dB	Measure ment dBuV/m	Limit dBuV/m	Margin dB	Detector	Comment
1	10391.1000	39.78	20.05	59.83	68.30	-8.47	Peak	
2 *	10390.0410	32.31	20.05	52.36	54.00	-1.64	AVG	

REMARKS:

- (1) Measurement Value = Reading Level + Correct Factor.
- (2) Margin Level = Measurement Value - Limit Value.

Orthogonal Axis	X
Test Mode	UNII-1_TX AC (VHT20) Mode 5240 MHz

Vertical

130 dBuV/m

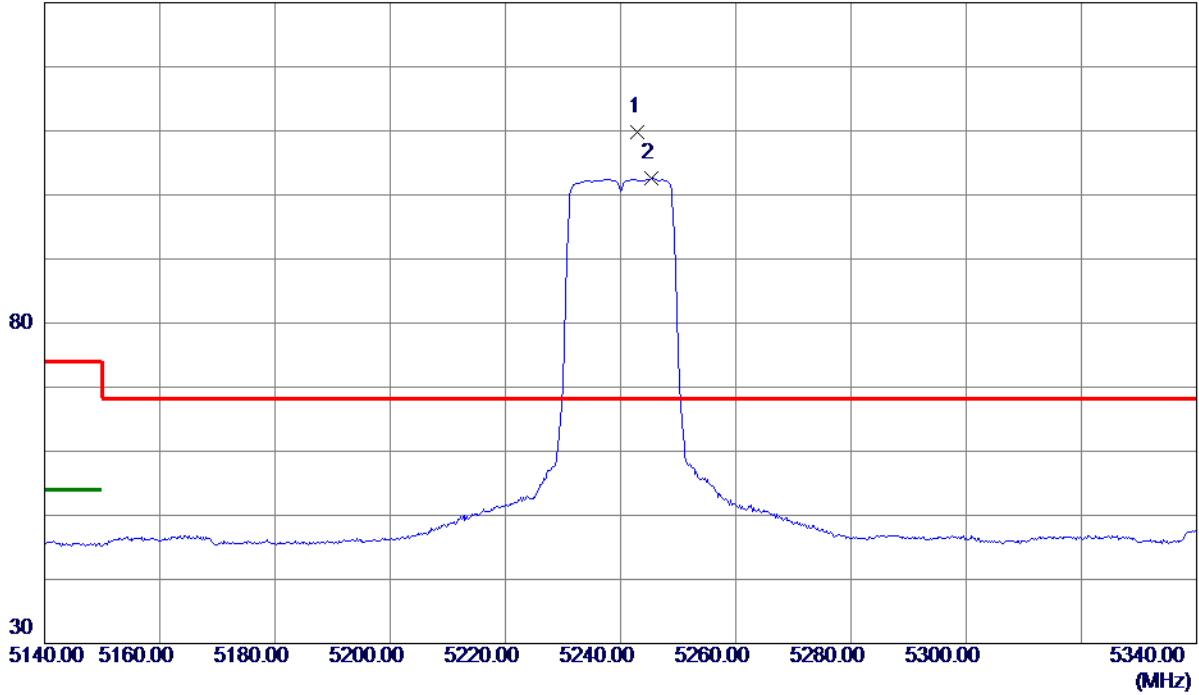

No.	Freq. MHz	Reading Level dBuV/m	Correct Factor dB	Measure ment dBuV/m	Limit dBuV/m	Margin dB	Detector	Comment
1 *	5243.0000	90.20	19.52	109.72	68.30	41.42	Peak	No Limit
2	5245.4000	83.00	19.53	102.53	999.00	-896.47	AVG	No Limit

REMARKS:

- (1) Measurement Value = Reading Level + Correct Factor.
- (2) Margin Level = Measurement Value - Limit Value.

Orthogonal Axis	X
Test Mode	UNII-1_TX AC (VHT20) Mode 5240 MHz

Vertical

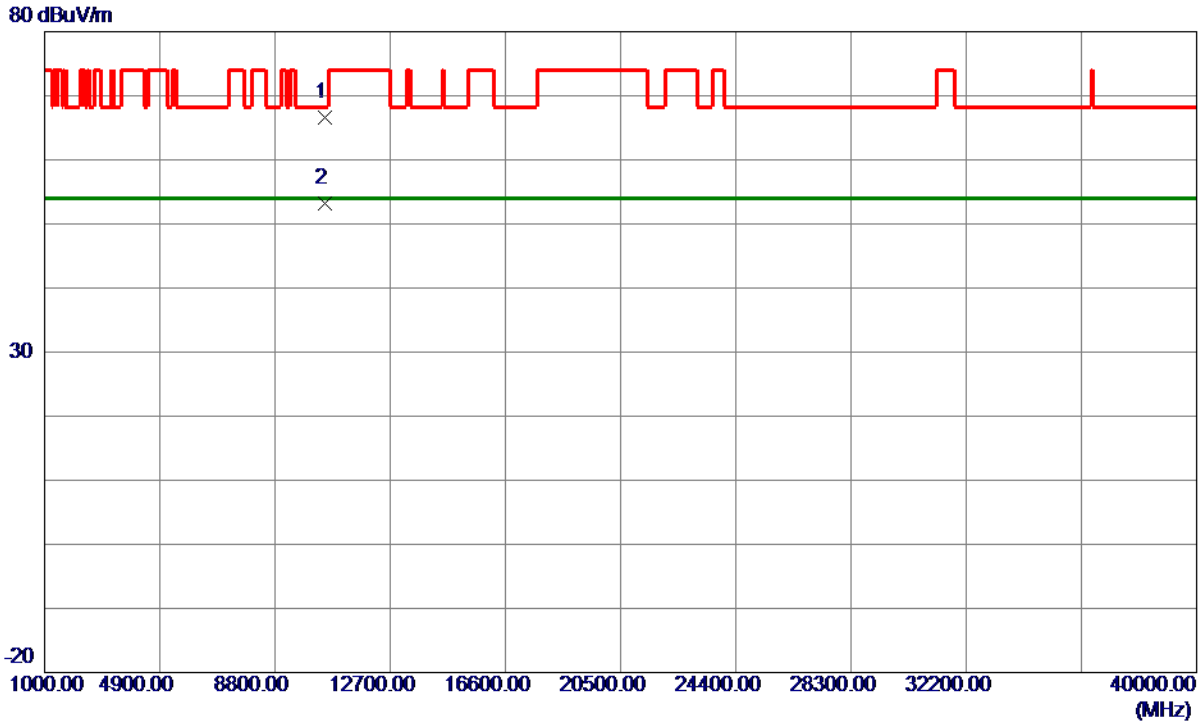

No.	Freq. MHz	Reading Level dBuV/m	Correct Factor dB	Measure ment dBuV/m	Limit dBuV/m	Margin dB	Detector	Comment
1	10485.0000	46.24	20.33	66.57	68.30	-1.73	Peak	
2 *	10485.2310	32.79	20.33	53.12	54.00	-0.88	AVG	

REMARKS:

- (1) Measurement Value = Reading Level + Correct Factor.
- (2) Margin Level = Measurement Value - Limit Value.

Orthogonal Axis	X
Test Mode	UNII-1_TX AC (VHT20) Mode 5240 MHz

Horizontal

130 dBuV/m

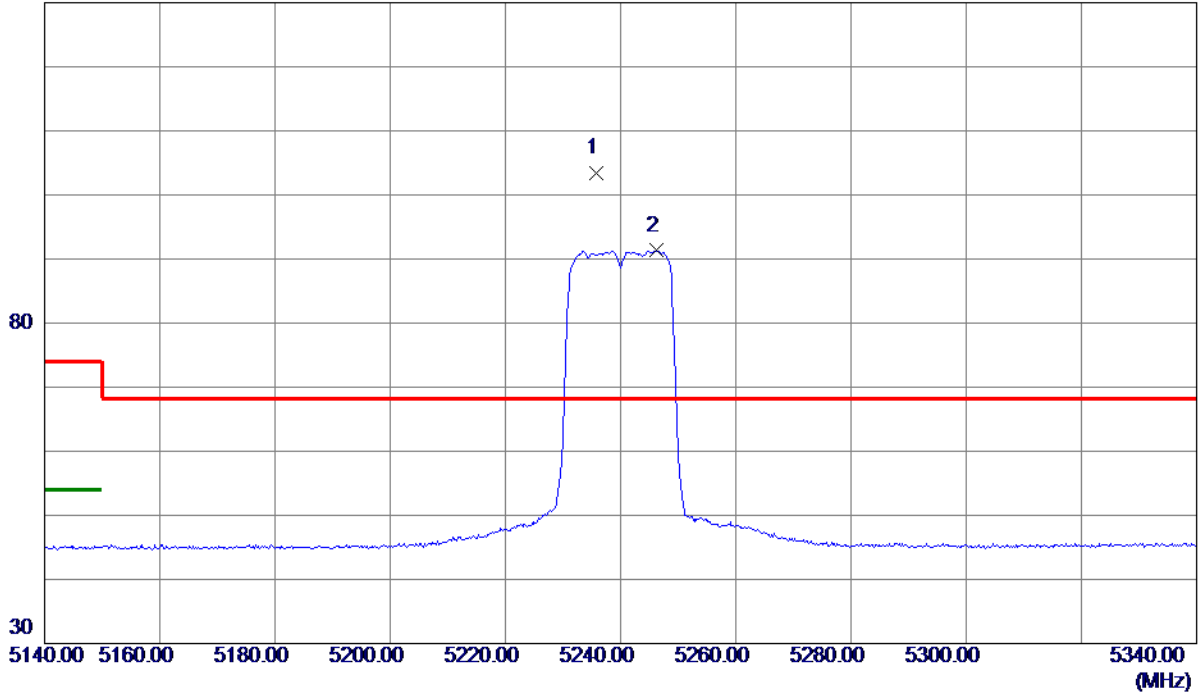

No.	Freq. MHz	Reading Level dBuV/m	Correct Factor dB	Measure ment dBuV/m	Limit dBuV/m	Margin dB	Detector	Comment
1 *	5235.8000	83.97	19.49	103.46	68.30	35.16	Peak	No Limit
2	5246.2000	71.77	19.53	91.30	999.00	-907.70	AVG	No Limit

REMARKS:

- (1) Measurement Value = Reading Level + Correct Factor.
- (2) Margin Level = Measurement Value - Limit Value.

Orthogonal Axis	X
Test Mode	UNII-1_TX AC (VHT20) Mode 5240 MHz

Horizontal

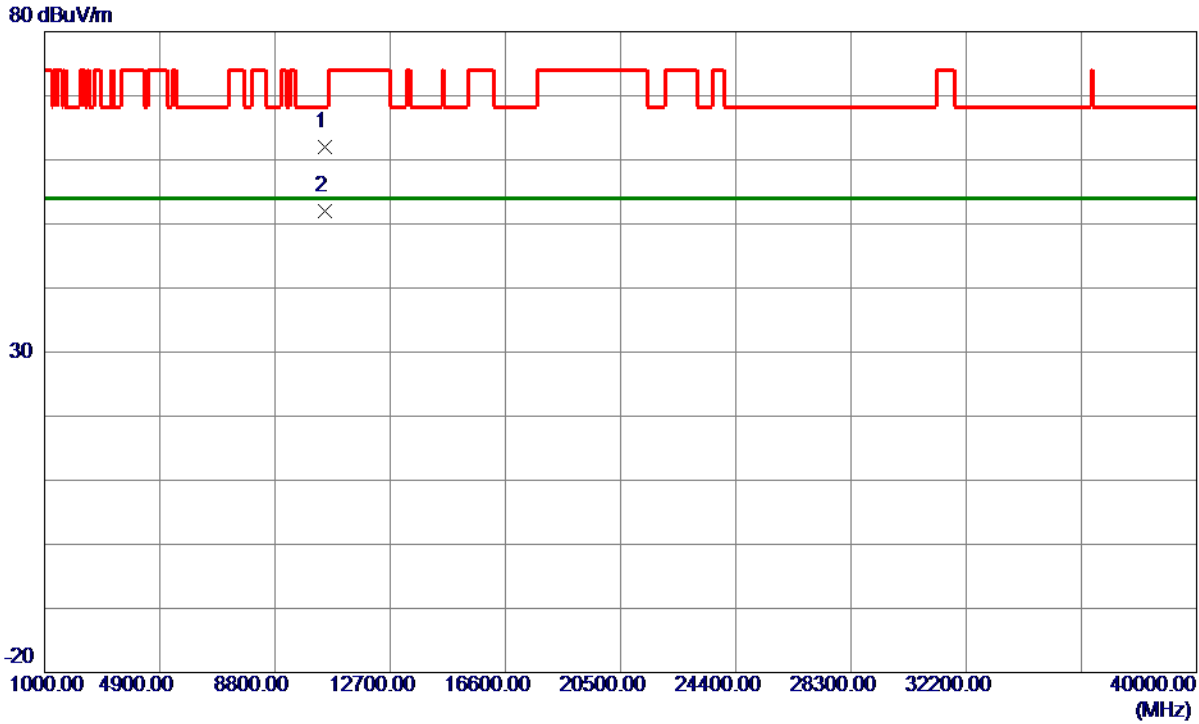

No.	Freq. MHz	Reading Level dBuV/m	Correct Factor dB	Measure ment dBuV/m	Limit dBuV/m	Margin dB	Detector	Comment
1	10483.1500	41.73	20.32	62.05	68.30	-6.25	Peak	
2 *	10483.1040	31.74	20.32	52.06	54.00	-1.94	AVG	

REMARKS:

- (1) Measurement Value = Reading Level + Correct Factor.
- (2) Margin Level = Measurement Value - Limit Value.

Orthogonal Axis	X
Test Mode	UNII-1_TX AC (VHT40) Mode 5190 MHz

Vertical

130 dBuV/m

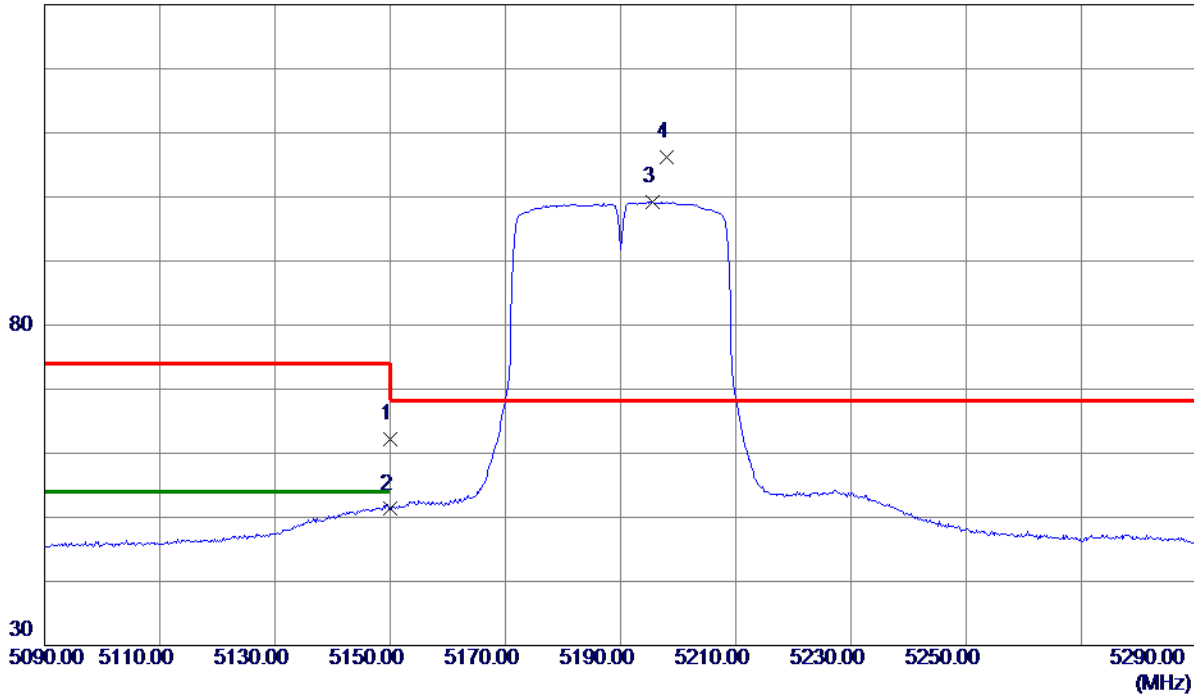

No.	Freq. MHz	Reading Level dBuV/m	Correct Factor dB	Measure ment dBuV/m	Limit dBuV/m	Margin dB	Detector	Comment
1	5150.0000	42.98	19.18	62.16	74.00	-11.84	Peak	
2	5150.0000	32.12	19.18	51.30	54.00	-2.70	AVG	
3	5195.6000	79.85	19.34	99.19	999.00	-899.81	AVG	No Limit
4 *	5198.0000	86.82	19.35	106.17	68.30	37.87	Peak	No Limit

REMARKS:

- (1) Measurement Value = Reading Level + Correct Factor.
- (2) Margin Level = Measurement Value - Limit Value.

Orthogonal Axis	X
Test Mode	UNII-1_TX AC (VHT40) Mode 5190 MHz

Vertical

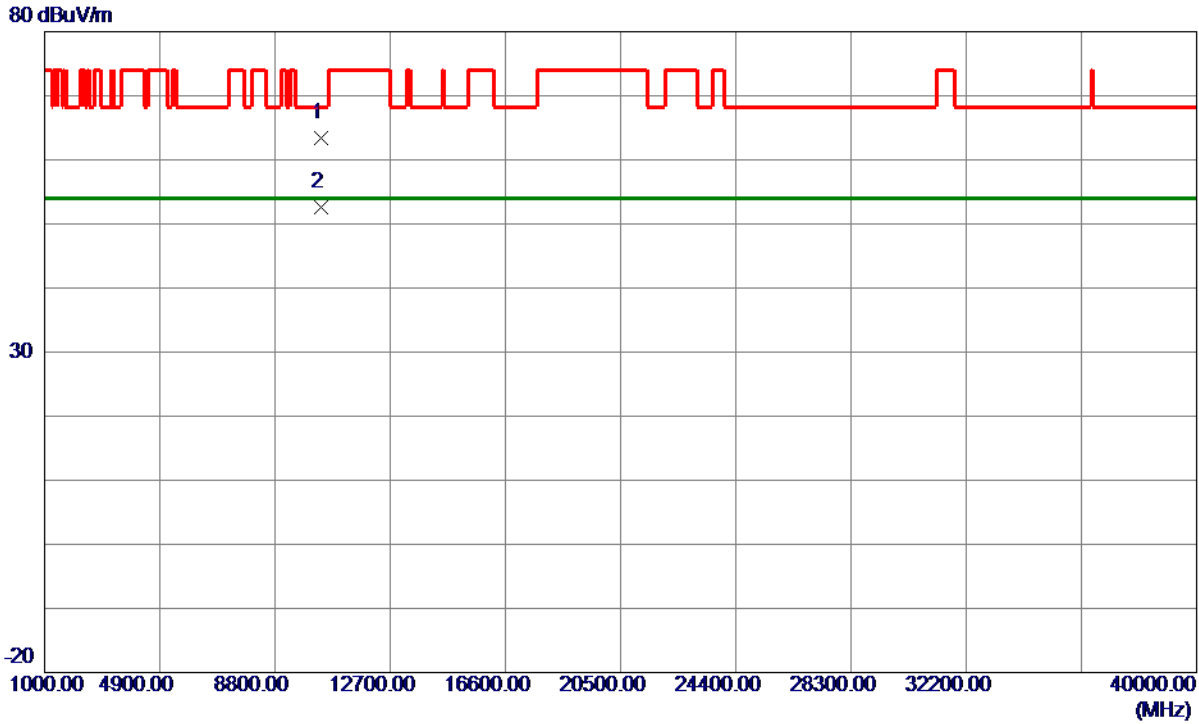

No.	Freq. MHz	Reading Level dBuV/m	Correct Factor dB	Measure ment dBuV/m	Limit dBuV/m	Margin dB	Detector	Comment
1	10379.0020	43.40	20.02	63.42	68.30	-4.88	Peak	
2 *	10379.1240	32.56	20.02	52.58	54.00	-1.42	AVG	

REMARKS:

- (1) Measurement Value = Reading Level + Correct Factor.
- (2) Margin Level = Measurement Value - Limit Value.

Orthogonal Axis	X
Test Mode	UNII-1_TX AC (VHT40) Mode 5190 MHz

Horizontal

130 dBuV/m

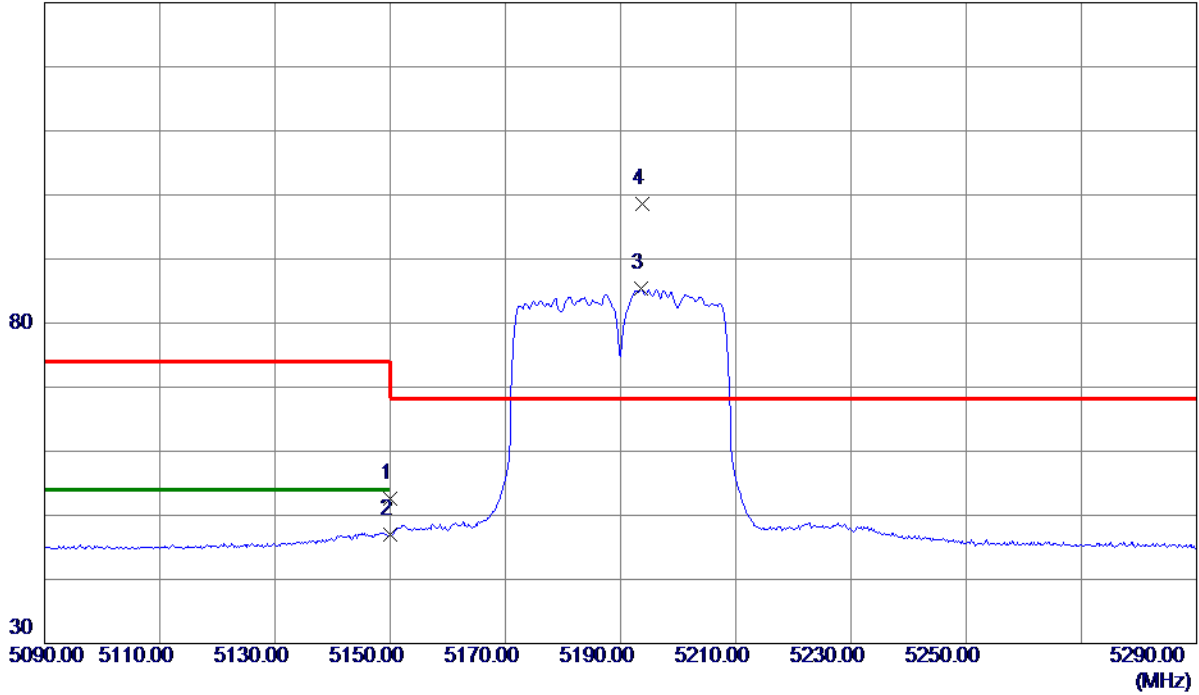

No.	Freq. MHz	Reading Level dBuV/m	Correct Factor dB	Measure ment dBuV/m	Limit dBuV/m	Margin dB	Detector	Comment
1	5150.0000	33.37	19.18	52.55	74.00	-21.45	Peak	
2	5150.0000	27.76	19.18	46.94	54.00	-7.06	AVG	
3	5193.6000	65.97	19.34	85.31	999.00	-913.69	AVG	No Limit
4 *	5193.8000	79.20	19.34	98.54	68.30	30.24	Peak	No Limit

REMARKS:

- (1) Measurement Value = Reading Level + Correct Factor.
- (2) Margin Level = Measurement Value - Limit Value.

Orthogonal Axis	X
Test Mode	UNII-1_TX AC (VHT40) Mode 5190 MHz

Horizontal

80 dBuV/m

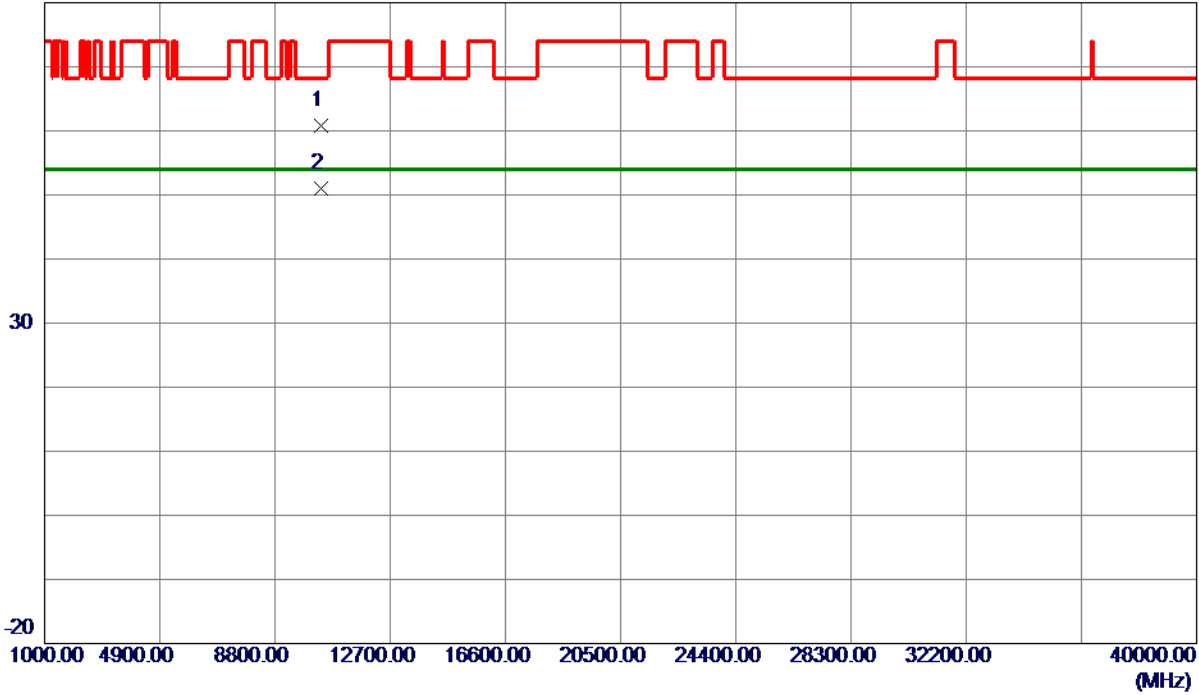

No.	Freq. MHz	Reading Level dBuV/m	Correct Factor dB	Measure ment dBuV/m	Limit dBuV/m	Margin dB	Detector	Comment
1	10376.4000	40.79	20.01	60.80	68.30	-7.50	Peak	
2 *	10376.3200	31.01	20.01	51.02	54.00	-2.98	AVG	

REMARKS:

- (1) Measurement Value = Reading Level + Correct Factor.
- (2) Margin Level = Measurement Value - Limit Value.

Orthogonal Axis	X
Test Mode	UNII-1_TX AC (VHT40) Mode 5230 MHz

Vertical

130 dBuV/m

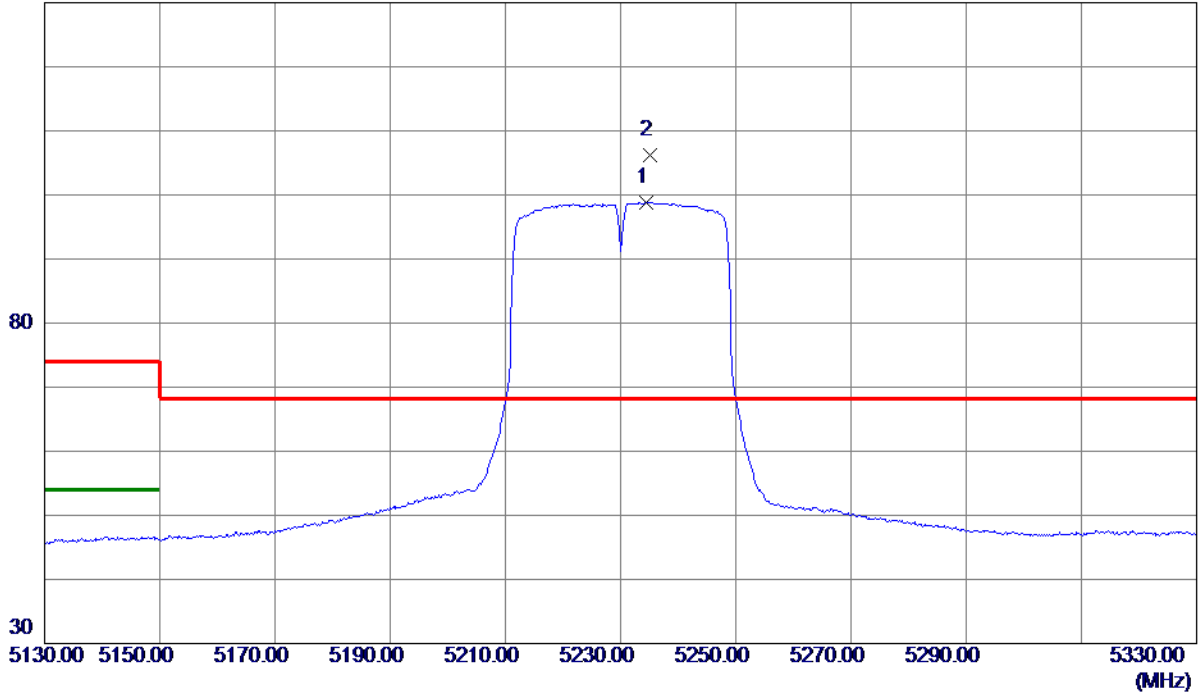

No.	Freq. MHz	Reading Level dBuV/m	Correct Factor dB	Measure ment dBuV/m	Limit dBuV/m	Margin dB	Detector	Comment
1	5234.4000	79.27	19.49	98.76	999.00	-900.24	AVG	No Limit
2 *	5235.2000	86.79	19.49	106.28	68.30	37.98	Peak	No Limit

REMARKS:

- (1) Measurement Value = Reading Level + Correct Factor.
- (2) Margin Level = Measurement Value - Limit Value.

Orthogonal Axis	X
Test Mode	UNII-1_TX AC (VHT40) Mode 5230 MHz

Vertical

80 dBuV/m

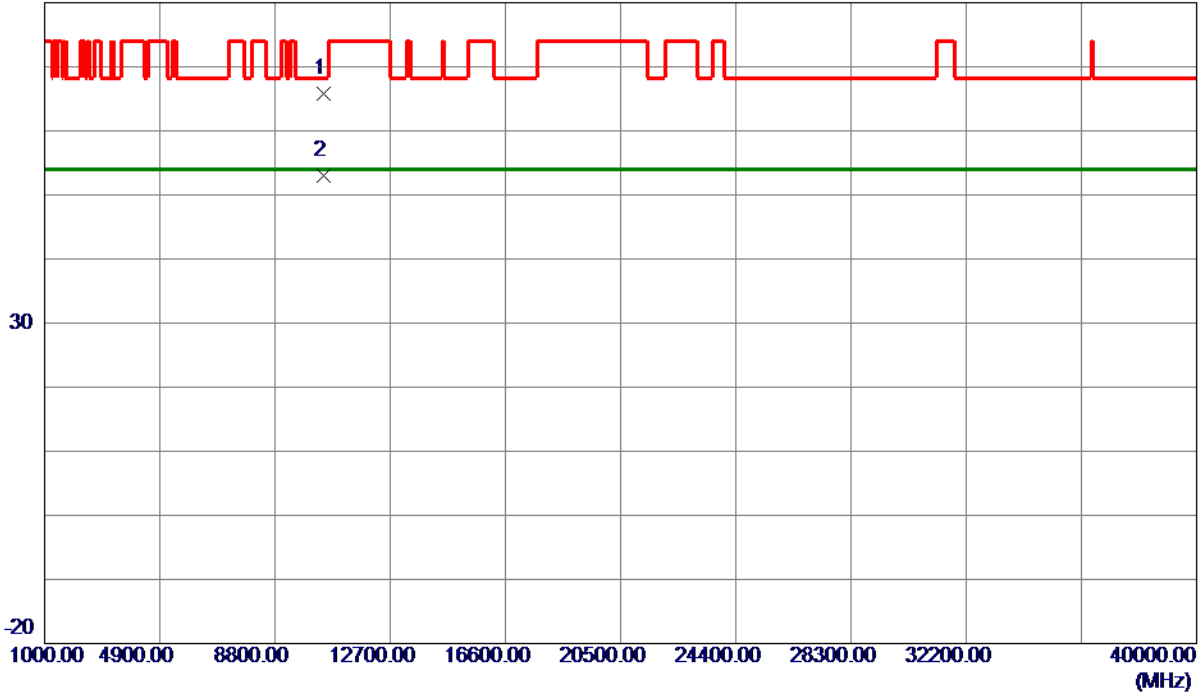

No.	Freq. MHz	Reading Level dBuV/m	Correct Factor dB	Measure ment dBuV/m	Limit dBuV/m	Margin dB	Detector	Comment
1	10458.8420	45.47	20.25	65.72	68.30	-2.58	Peak	
2 *	10458.7420	32.78	20.25	53.03	54.00	-0.97	AVG	

REMARKS:

- (1) Measurement Value = Reading Level + Correct Factor.
- (2) Margin Level = Measurement Value - Limit Value.

Orthogonal Axis	X
Test Mode	UNII-1_TX AC (VHT40) Mode 5230 MHz

Horizontal

130 dBuV/m

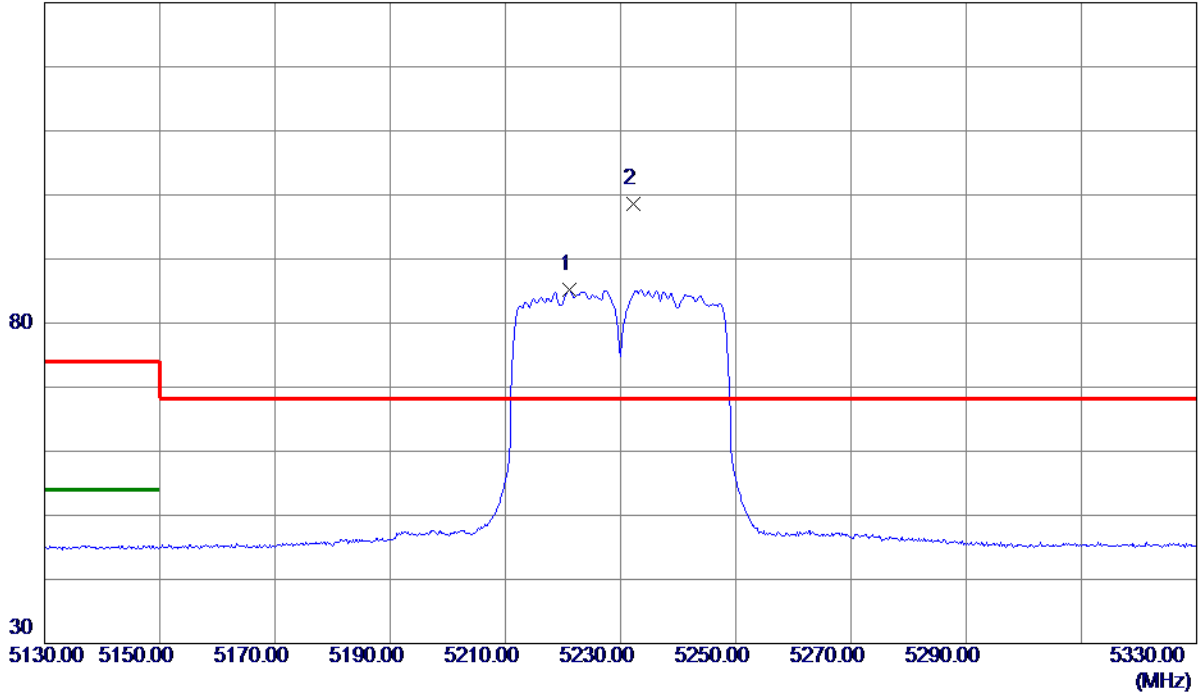

No.	Freq. MHz	Reading Level dBuV/m	Correct Factor dB	Measure ment dBuV/m	Limit dBuV/m	Margin dB	Detector	Comment
1	5221.2000	65.68	19.44	85.12	999.00	-913.88	AVG	No Limit
2 *	5232.2000	79.04	19.48	98.52	68.30	30.22	Peak	No Limit

REMARKS:

- (1) Measurement Value = Reading Level + Correct Factor.
- (2) Margin Level = Measurement Value - Limit Value.

Orthogonal Axis	X
Test Mode	UNII-1_TX AC (VHT40) Mode 5230 MHz

Horizontal

80 dBuV/m

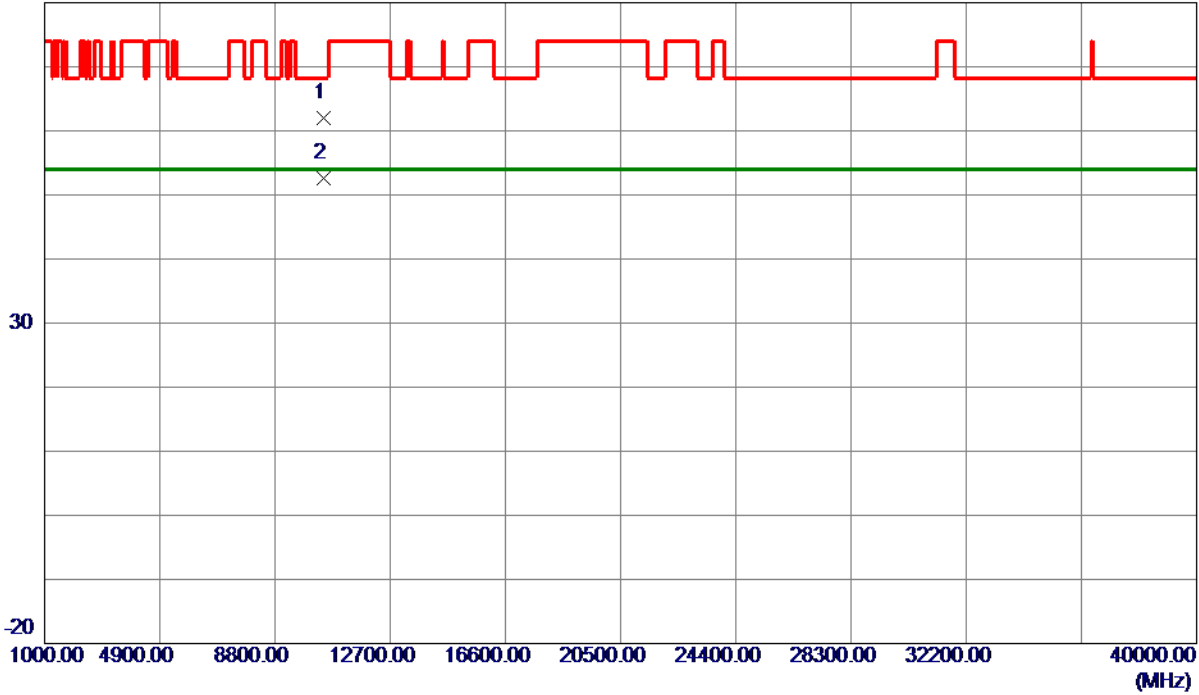

No.	Freq. MHz	Reading Level dBuV/m	Correct Factor dB	Measure ment dBuV/m	Limit dBuV/m	Margin dB	Detector	Comment
1	10456.7000	41.66	20.25	61.91	68.30	-6.39	Peak	
2 *	10455.8400	32.42	20.24	52.66	54.00	-1.34	AVG	

REMARKS:

- (1) Measurement Value = Reading Level + Correct Factor.
- (2) Margin Level = Measurement Value - Limit Value.

Orthogonal Axis	X
Test Mode	UNII-1_TX AC (VHT80) Mode 5210 MHz

Vertical

130 dBuV/m

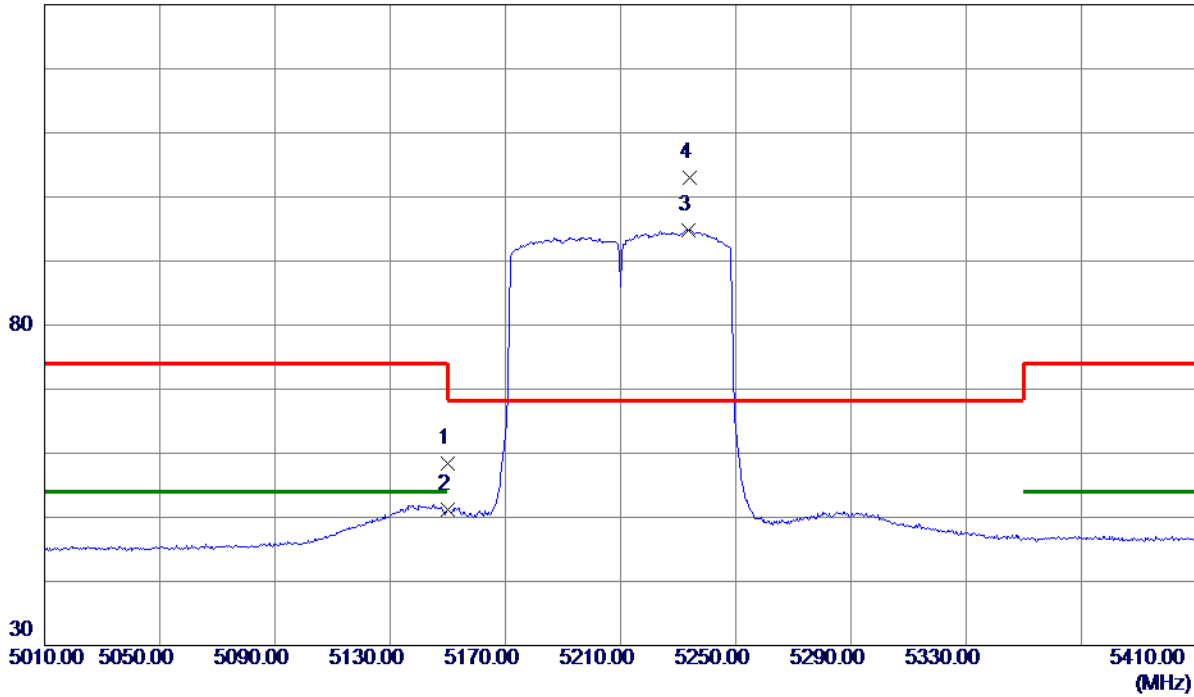

No.	Freq. MHz	Reading Level dBuV/m	Correct Factor dB	Measure ment dBuV/m	Limit dBuV/m	Margin dB	Detector	Comment
1	5150.0000	39.30	19.18	58.48	74.00	-15.52	Peak	
2	5150.0000	31.98	19.18	51.16	54.00	-2.84	AVG	
3	5233.6000	75.38	19.48	94.86	999.00	-904.14	AVG	No Limit
4 *	5234.0000	83.42	19.48	102.90	68.30	34.60	Peak	No Limit

REMARKS:

- (1) Measurement Value = Reading Level + Correct Factor.
- (2) Margin Level = Measurement Value - Limit Value.

Orthogonal Axis	X
Test Mode	UNII-1_TX AC (VHT80) Mode 5210 MHz

Vertical

80 dBuV/m

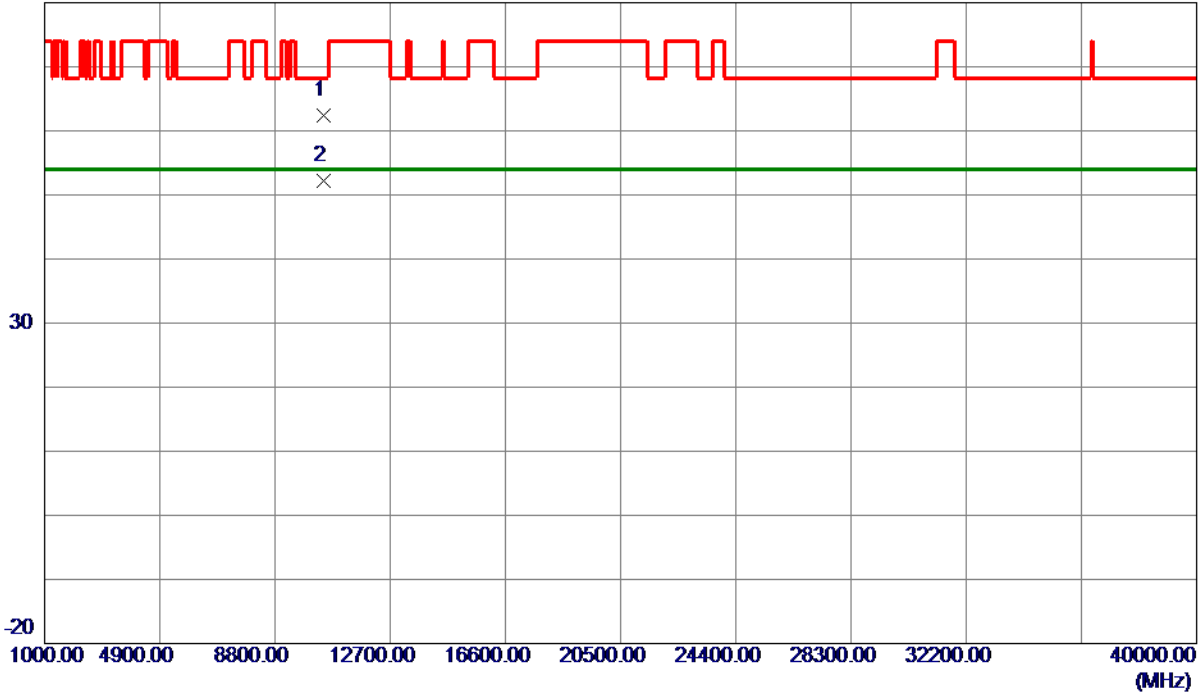

No.	Freq. MHz	Reading Level dBuV/m	Correct Factor dB	Measure ment dBuV/m	Limit dBuV/m	Margin dB	Detector	Comment
1	10428.8500	42.31	20.16	62.47	68.30	-5.83	Peak	
2 *	10427.6500	32.12	20.16	52.28	54.00	-1.72	AVG	

REMARKS:

- (1) Measurement Value = Reading Level + Correct Factor.
- (2) Margin Level = Measurement Value - Limit Value.

Orthogonal Axis	X
Test Mode	UNII-1_TX AC (VHT80) Mode 5210 MHz

Horizontal

130 dBuV/m

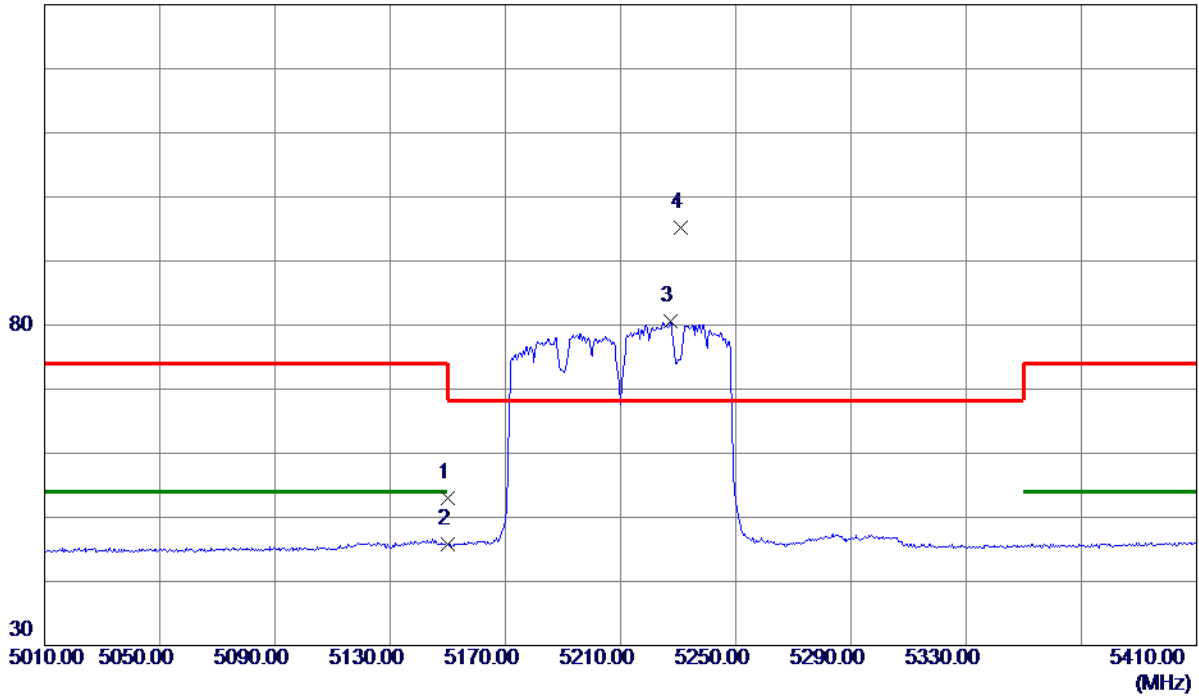

No.	Freq. MHz	Reading Level dBuV/m	Correct Factor dB	Measure ment dBuV/m	Limit dBuV/m	Margin dB	Detector	Comment
1	5150.0000	33.84	19.18	53.02	74.00	-20.98	Peak	
2	5150.0000	26.64	19.18	45.82	54.00	-8.18	AVG	
3	5227.2000	61.11	19.46	80.57	999.00	-918.43	AVG	No Limit
4 *	5230.8000	75.80	19.47	95.27	68.30	26.97	Peak	No Limit

REMARKS:

- (1) Measurement Value = Reading Level + Correct Factor.
- (2) Margin Level = Measurement Value - Limit Value.

Orthogonal Axis	X
Test Mode	UNII-1_TX AC (VHT80) Mode 5210 MHz

Horizontal

80 dBuV/m

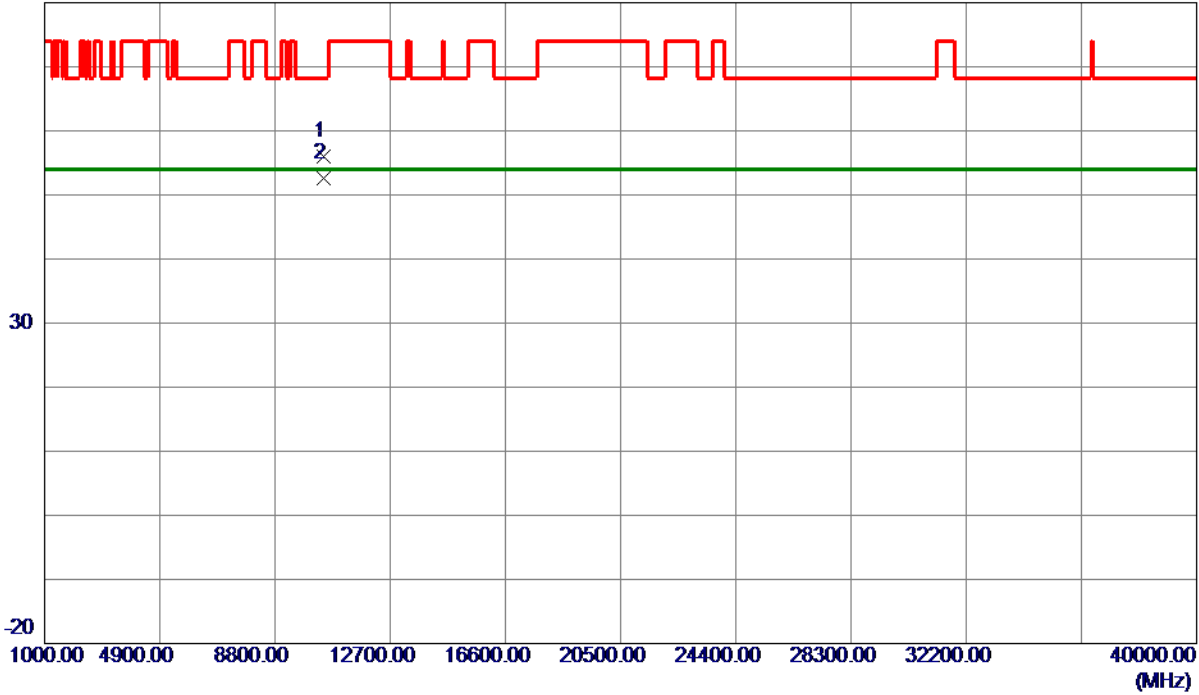

No.	Freq. MHz	Reading Level dBuV/m	Correct Factor dB	Measure ment dBuV/m	Limit dBuV/m	Margin dB	Detector	Comment
1	10436.6500	35.75	20.19	55.94	68.30	-12.36	Peak	
2 *	10436.4100	32.42	20.19	52.61	54.00	-1.39	AVG	

REMARKS:

- (1) Measurement Value = Reading Level + Correct Factor.
- (2) Margin Level = Measurement Value - Limit Value.

Orthogonal Axis	X
Test Mode	UNII-3_TX AC (VHT20) Mode 5745 MHz

Vertical

130 dBuV/m

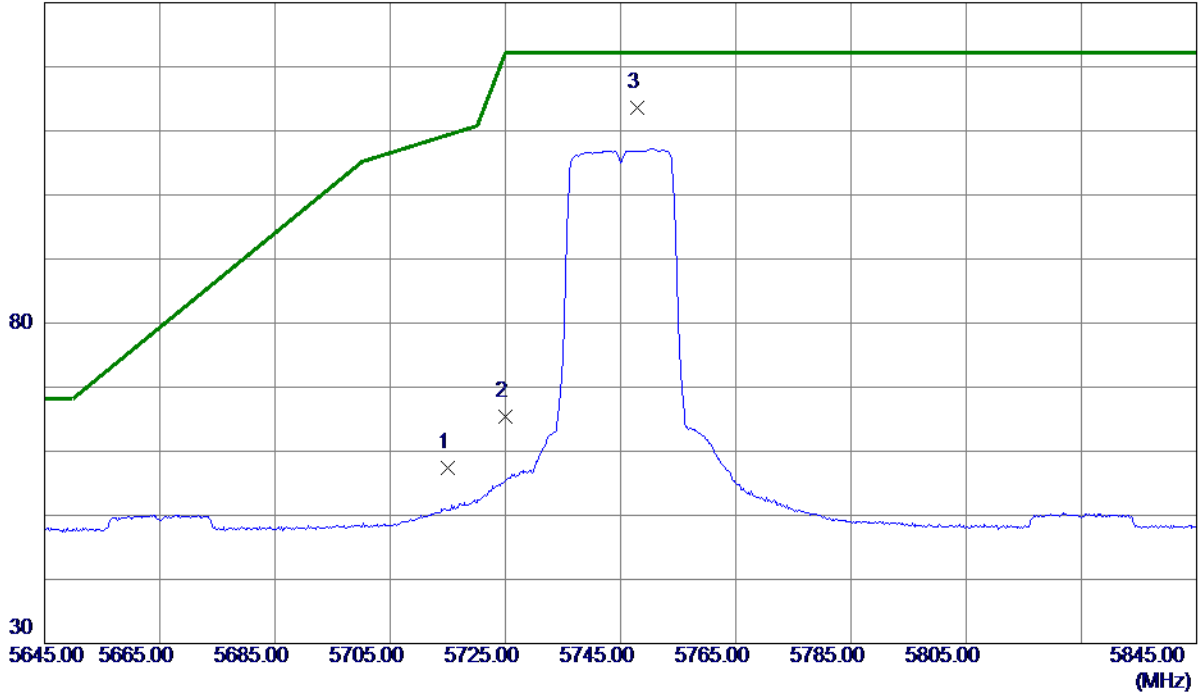

No.	Freq. MHz	Reading Level dBuV/m	Correct Factor dB	Measure ment dBuV/m	Limit dBuV/m	Margin dB	Detector	Comment
1	5715.0000	35.97	21.50	57.47	109.40	-51.93	Peak	
2	5725.0000	43.88	21.55	65.43	122.20	-56.77	Peak	
3 *	5747.8000	91.90	21.66	113.56	122.20	-8.64	Peak	No Limit

REMARKS:

- (1) Measurement Value = Reading Level + Correct Factor.
- (2) Margin Level = Measurement Value - Limit Value.

Orthogonal Axis	X
Test Mode	UNII-3_TX AC (VHT20) Mode 5745 MHz

Vertical

80 dBuV/m

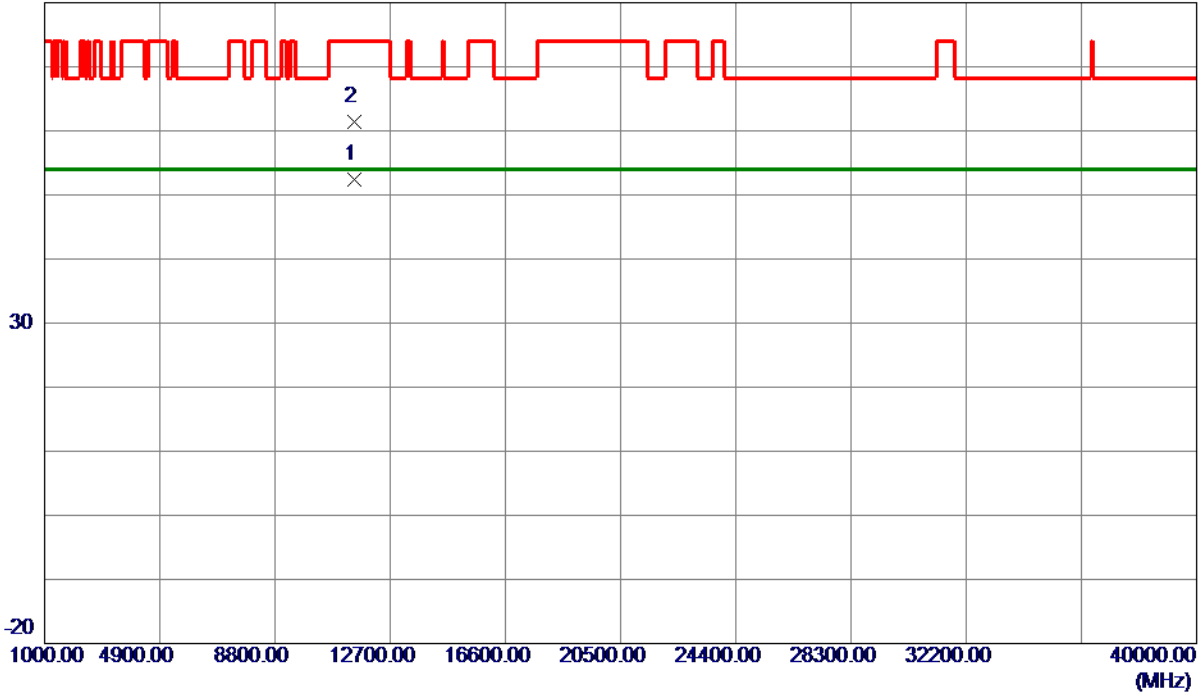

No.	Freq. MHz	Reading Level dBuV/m	Correct Factor dB	Measure ment dBuV/m	Limit dBuV/m	Margin dB	Detector	Comment
1 *	11488.7500	32.70	19.71	52.41	54.00	-1.59	AVG	
2	11495.0000	41.79	19.69	61.48	74.00	-12.52	Peak	

REMARKS:

- (1) Measurement Value = Reading Level + Correct Factor.
- (2) Margin Level = Measurement Value - Limit Value.

Orthogonal Axis	X
Test Mode	UNII-3_TX AC (VHT20) Mode 5745 MHz

Horizontal

130 dBuV/m

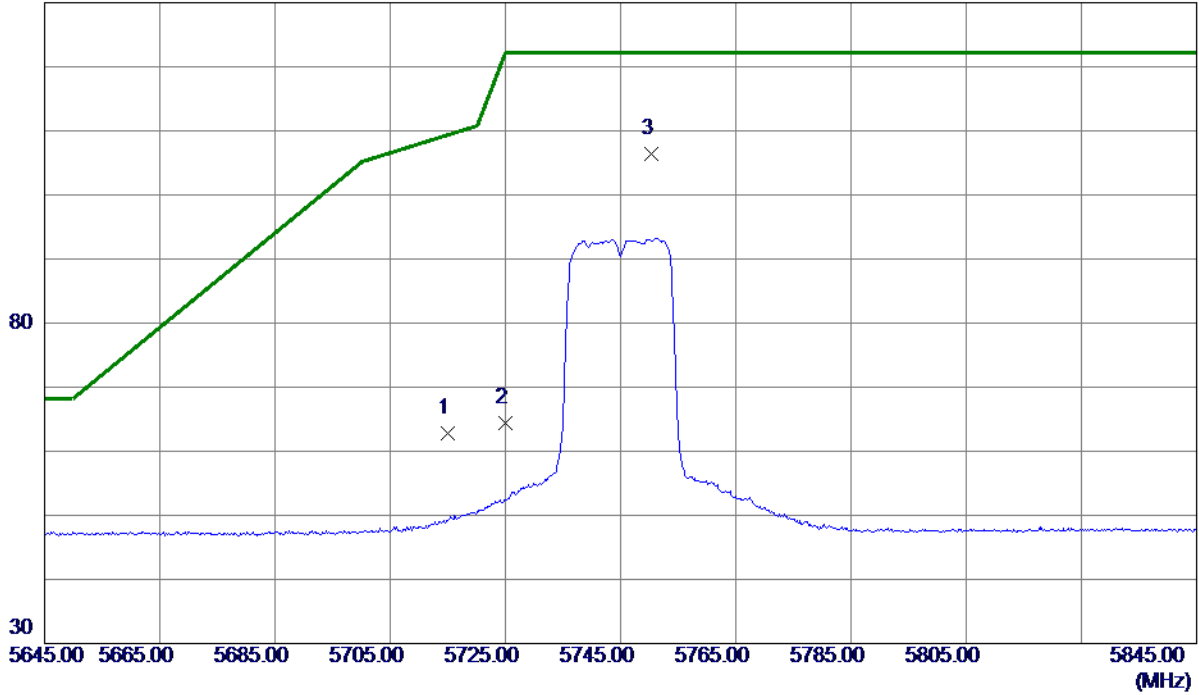

No.	Freq. MHz	Reading Level dBuV/m	Correct Factor dB	Measure ment dBuV/m	Limit dBuV/m	Margin dB	Detector	Comment
1	5715.0000	41.33	21.50	62.83	109.40	-46.57	Peak	
2	5725.0000	42.77	21.55	64.32	122.20	-57.88	Peak	
3 *	5750.4000	84.65	21.67	106.32	122.20	-15.88	Peak	No Limit

REMARKS:

- (1) Measurement Value = Reading Level + Correct Factor.
- (2) Margin Level = Measurement Value - Limit Value.

Orthogonal Axis	X
Test Mode	UNII-3_TX AC (VHT20) Mode 5745 MHz

Horizontal

80 dBuV/m

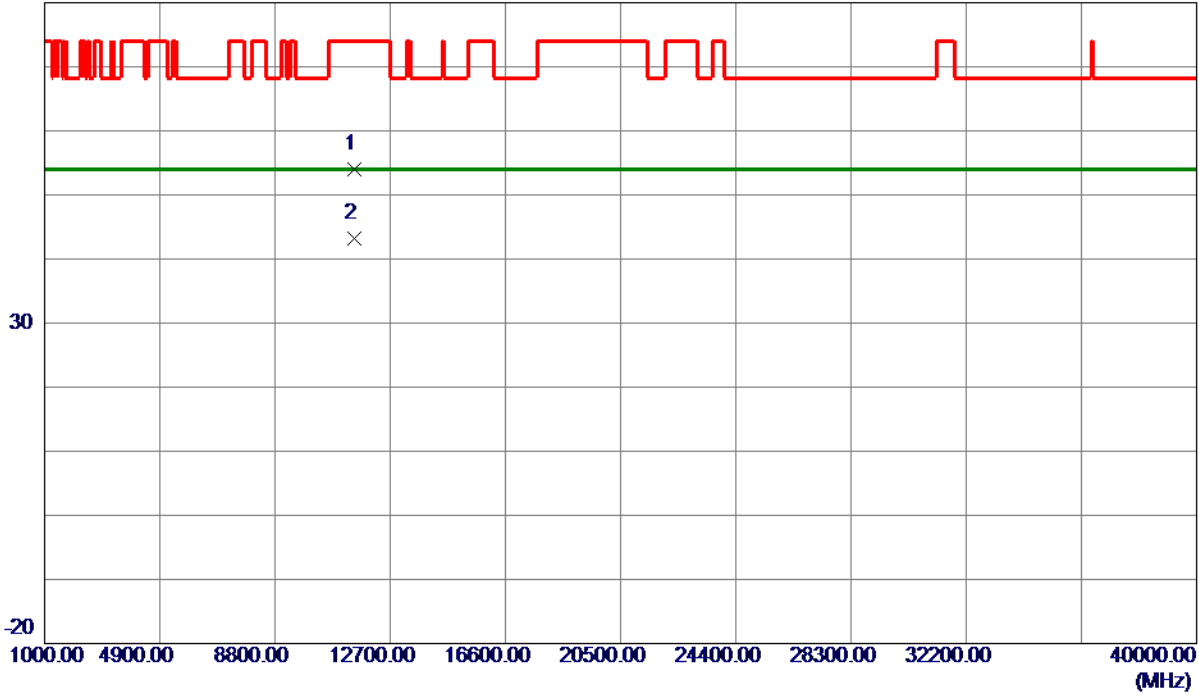

No.	Freq. MHz	Reading Level dBuV/m	Correct Factor dB	Measure ment dBuV/m	Limit dBuV/m	Margin dB	Detector	Comment
1	11490.2500	34.30	19.70	54.00	74.00	-20.00	Peak	
2 *	11491.0500	23.55	19.70	43.25	54.00	-10.75	AVG	

REMARKS:

- (1) Measurement Value = Reading Level + Correct Factor.
- (2) Margin Level = Measurement Value - Limit Value.

Orthogonal Axis	X
Test Mode	UNII-3_TX AC (VHT20) Mode 5785 MHz

Vertical

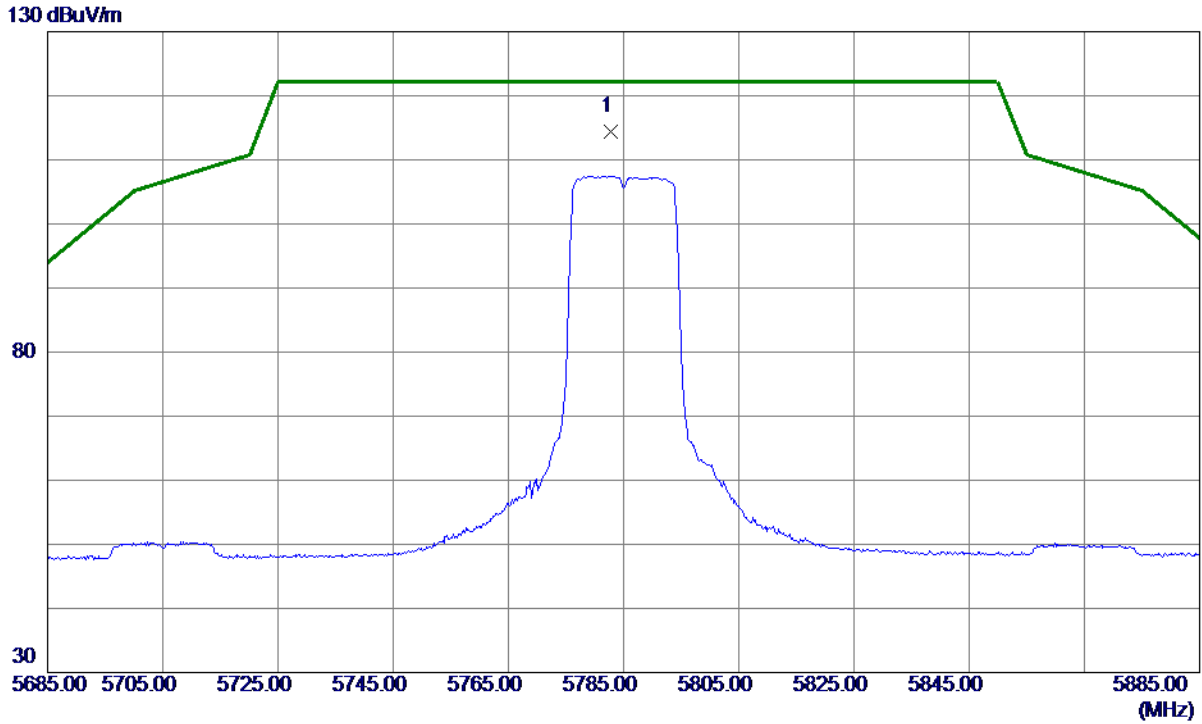

No.	Freq. MHz	Reading Level dBuV/m	Correct Factor dB	Measure ment dBuV/m	Limit dBuV/m	Margin dB	Detector	Comment
1 *	5782.8000	92.58	21.83	114.41	122.20	-7.79	Peak	No Limit

REMARKS:

- (1) Measurement Value = Reading Level + Correct Factor.
- (2) Margin Level = Measurement Value - Limit Value.

Orthogonal Axis	X
Test Mode	UNII-3_TX AC (VHT20) Mode 5785 MHz

Vertical

80 dBuV/m

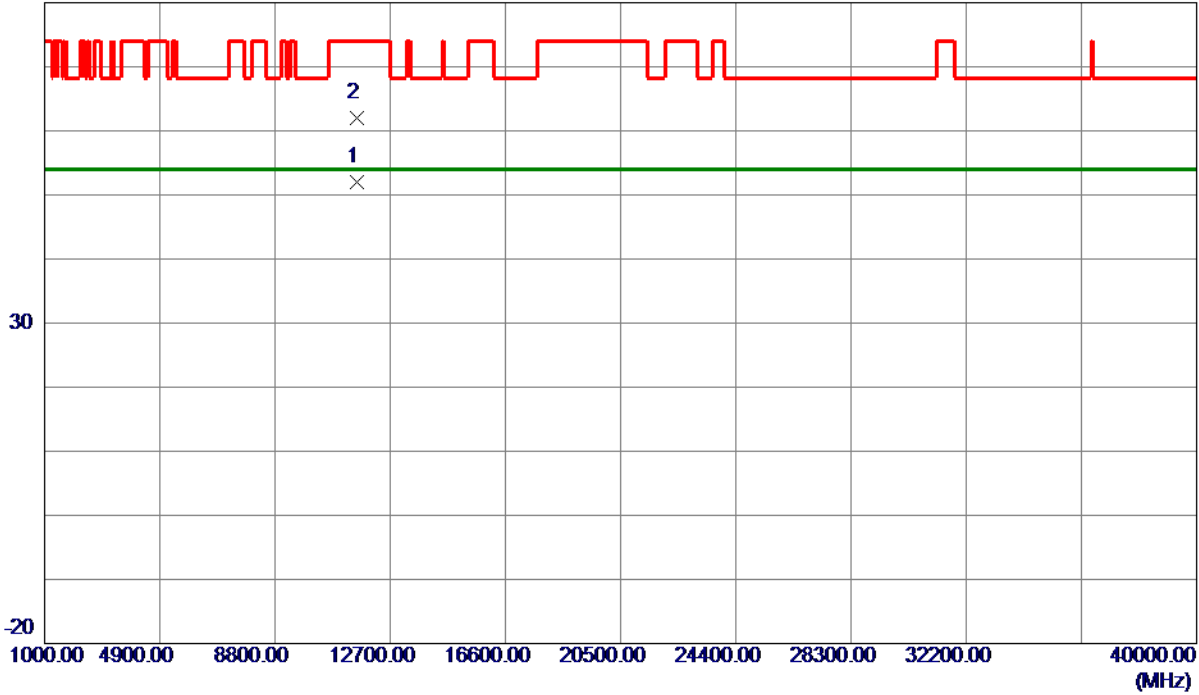

No.	Freq. MHz	Reading Level dBuV/m	Correct Factor dB	Measure ment dBuV/m	Limit dBuV/m	Margin dB	Detector	Comment
1 *	11569.6500	32.60	19.49	52.09	54.00	-1.91	AVG	
2	11570.5500	42.51	19.49	62.00	74.00	-12.00	Peak	

REMARKS:

- (1) Measurement Value = Reading Level + Correct Factor.
- (2) Margin Level = Measurement Value - Limit Value.

Orthogonal Axis	X
Test Mode	UNII-3_TX AC (VHT20) Mode 5785 MHz

Horizontal

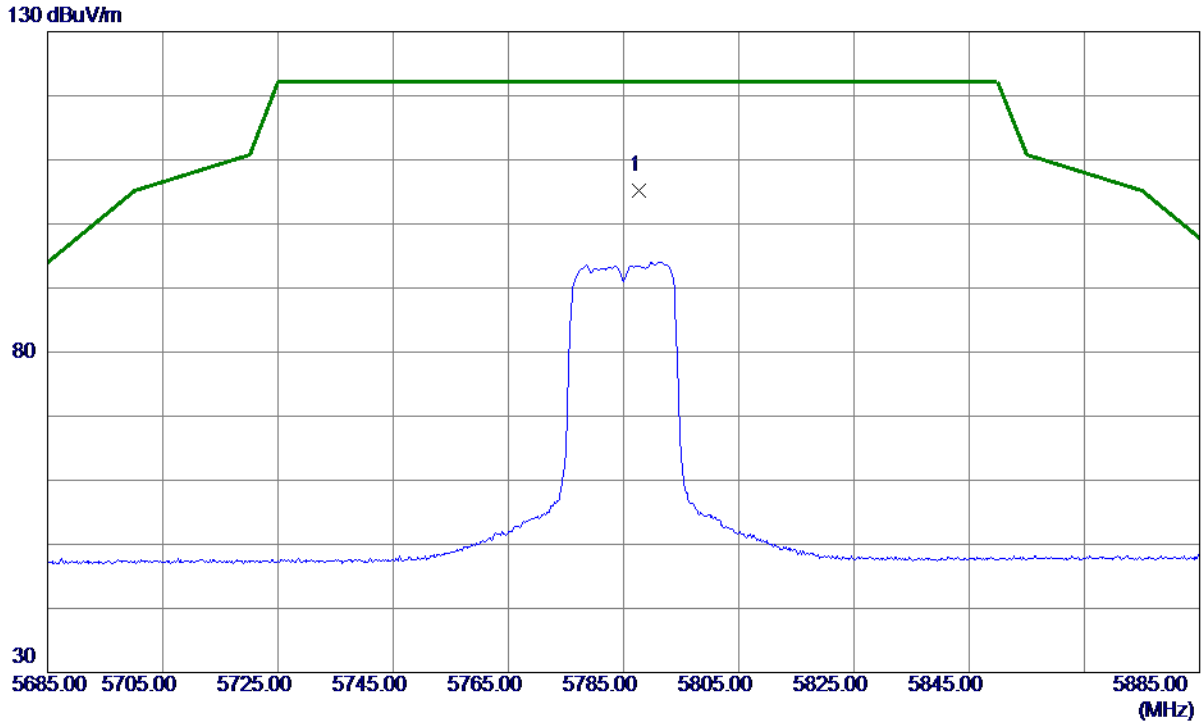

No.	Freq. MHz	Reading Level dBuV/m	Correct Factor dB	Measure ment dBuV/m	Limit dBuV/m	Margin dB	Detector	Comment
1 *	5787.6000	83.43	21.86	105.29	122.20	-16.91	Peak	No Limit

REMARKS:

- (1) Measurement Value = Reading Level + Correct Factor.
- (2) Margin Level = Measurement Value - Limit Value.

Orthogonal Axis	X
Test Mode	UNII-3_TX AC (VHT20) Mode 5785 MHz

Horizontal

80 dBuV/m

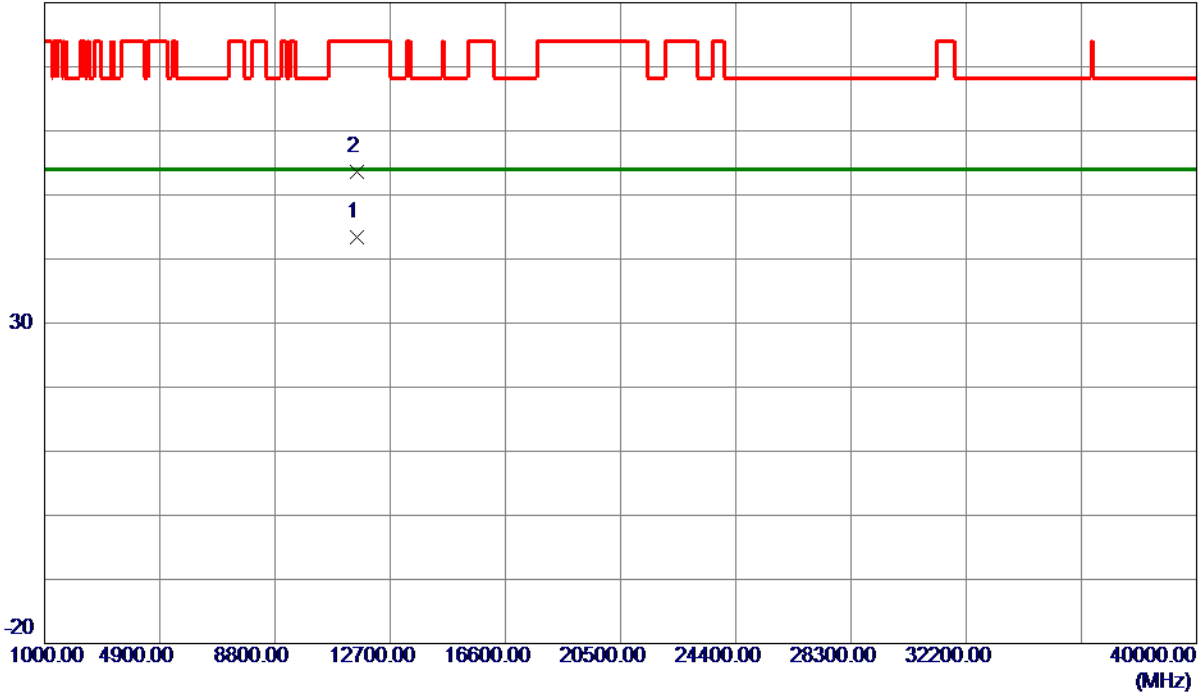

No.	Freq. MHz	Reading Level dBuV/m	Correct Factor dB	Measure ment dBuV/m	Limit dBuV/m	Margin dB	Detector	Comment
1 *	11571.1500	23.98	19.49	43.47	54.00	-10.53	AVG	
2	11578.2500	34.05	19.47	53.52	74.00	-20.48	Peak	

REMARKS:

- (1) Measurement Value = Reading Level + Correct Factor.
- (2) Margin Level = Measurement Value - Limit Value.

Orthogonal Axis	X
Test Mode	UNII-3_TX AC (VHT20) Mode 5825 MHz

Vertical

130 dBuV/m

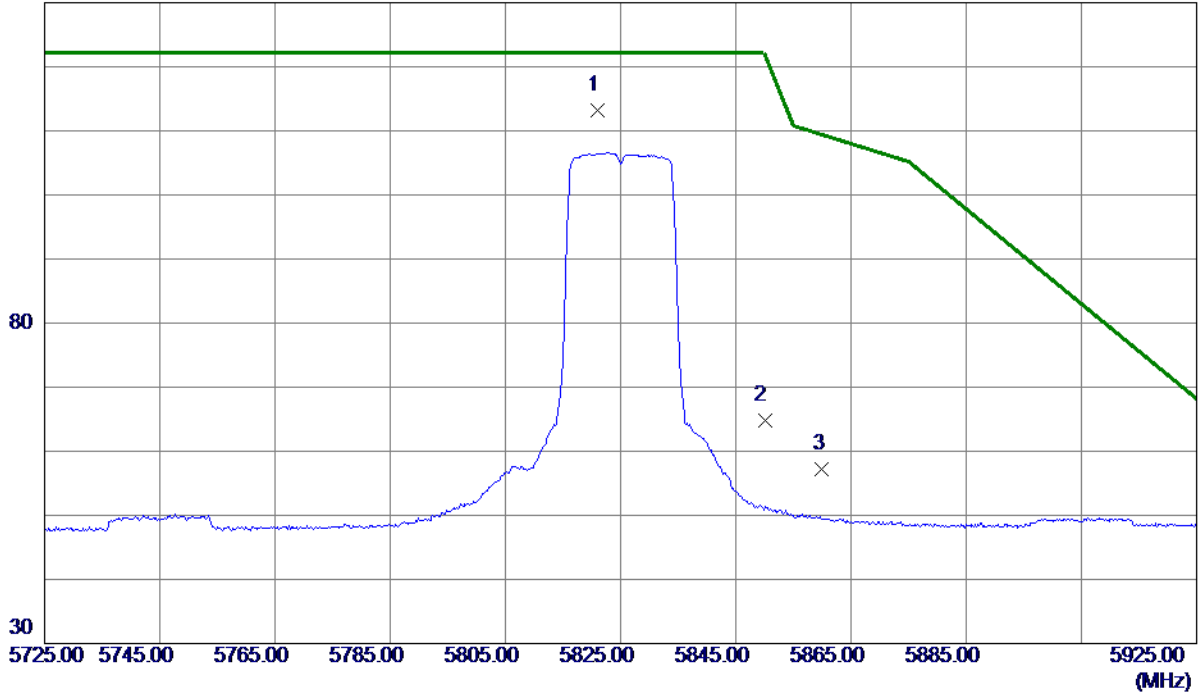

No.	Freq. MHz	Reading Level dBuV/m	Correct Factor dB	Measure ment dBuV/m	Limit dBuV/m	Margin dB	Detector	Comment
1 *	5821.0000	91.12	22.02	113.14	122.20	-9.06	Peak	No Limit
2	5850.0000	42.65	22.16	64.81	122.20	-57.39	Peak	
3	5860.0000	34.92	22.21	57.13	109.40	-52.27	Peak	

REMARKS:

- (1) Measurement Value = Reading Level + Correct Factor.
- (2) Margin Level = Measurement Value - Limit Value.

Orthogonal Axis	X
Test Mode	UNII-3_TX AC (VHT20) Mode 5825 MHz

Vertical

80 dBuV/m

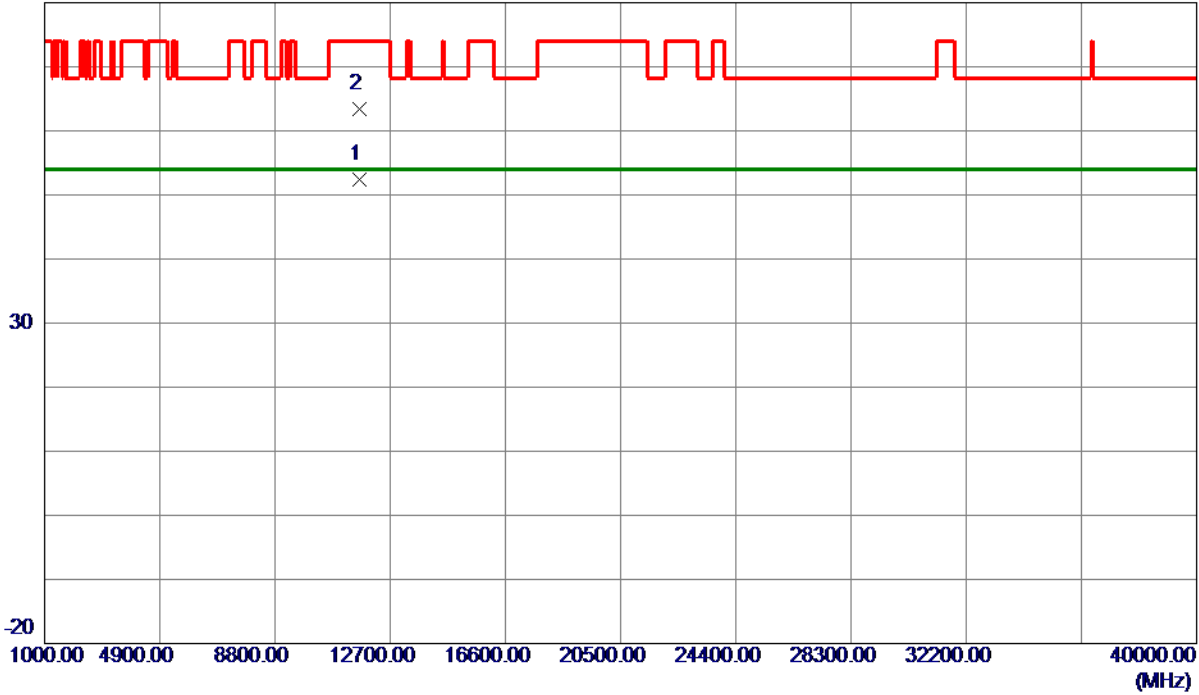

No.	Freq. MHz	Reading Level dBuV/m	Correct Factor dB	Measure ment dBuV/m	Limit dBuV/m	Margin dB	Detector	Comment
1 *	11649.6500	33.05	19.27	52.32	54.00	-1.68	AVG	
2	11650.8500	44.06	19.26	63.32	74.00	-10.68	Peak	

REMARKS:

- (1) Measurement Value = Reading Level + Correct Factor.
- (2) Margin Level = Measurement Value - Limit Value.

Orthogonal Axis	X
Test Mode	UNII-3_TX AC (VHT20) Mode 5825 MHz

Horizontal

130 dBuV/m

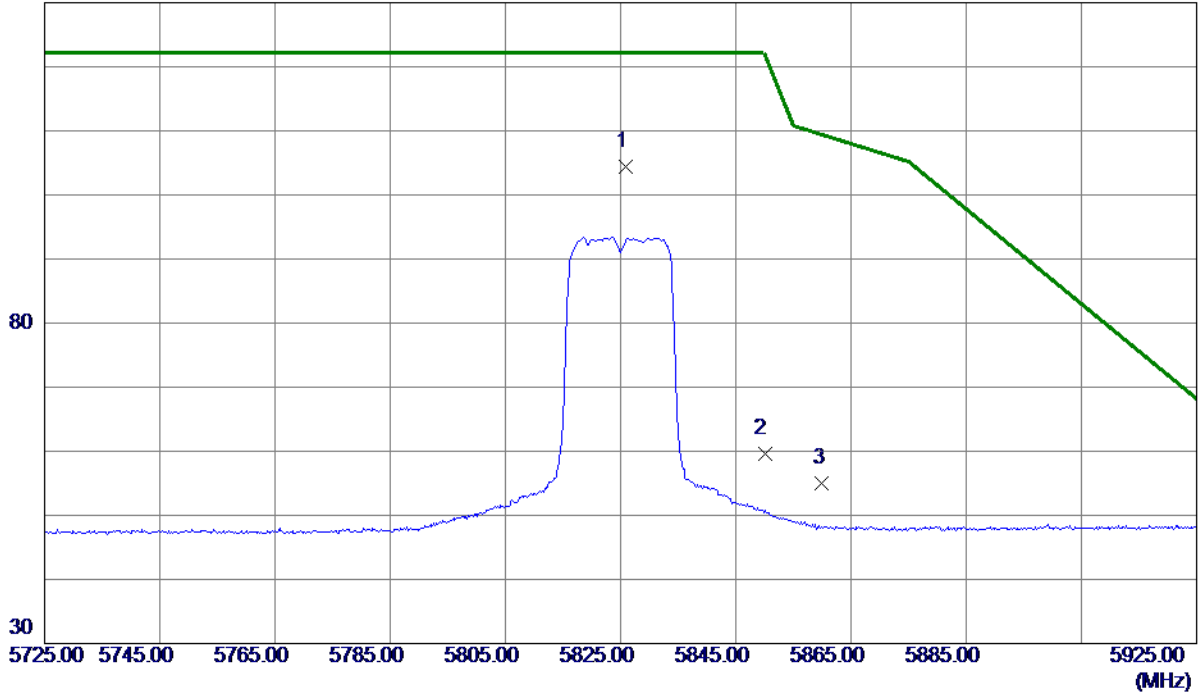

No.	Freq. MHz	Reading Level dBuV/m	Correct Factor dB	Measure ment dBuV/m	Limit dBuV/m	Margin dB	Detector	Comment
1 *	5825.8000	82.41	22.04	104.45	122.20	-17.75	Peak	No Limit
2	5850.0000	37.37	22.16	59.53	122.20	-62.67	Peak	
3	5860.0000	32.83	22.21	55.04	109.40	-54.36	Peak	

REMARKS:

- (1) Measurement Value = Reading Level + Correct Factor.
- (2) Margin Level = Measurement Value - Limit Value.

Orthogonal Axis	X
Test Mode	UNII-3_TX AC (VHT20) Mode 5825 MHz

Horizontal

80 dBuV/m

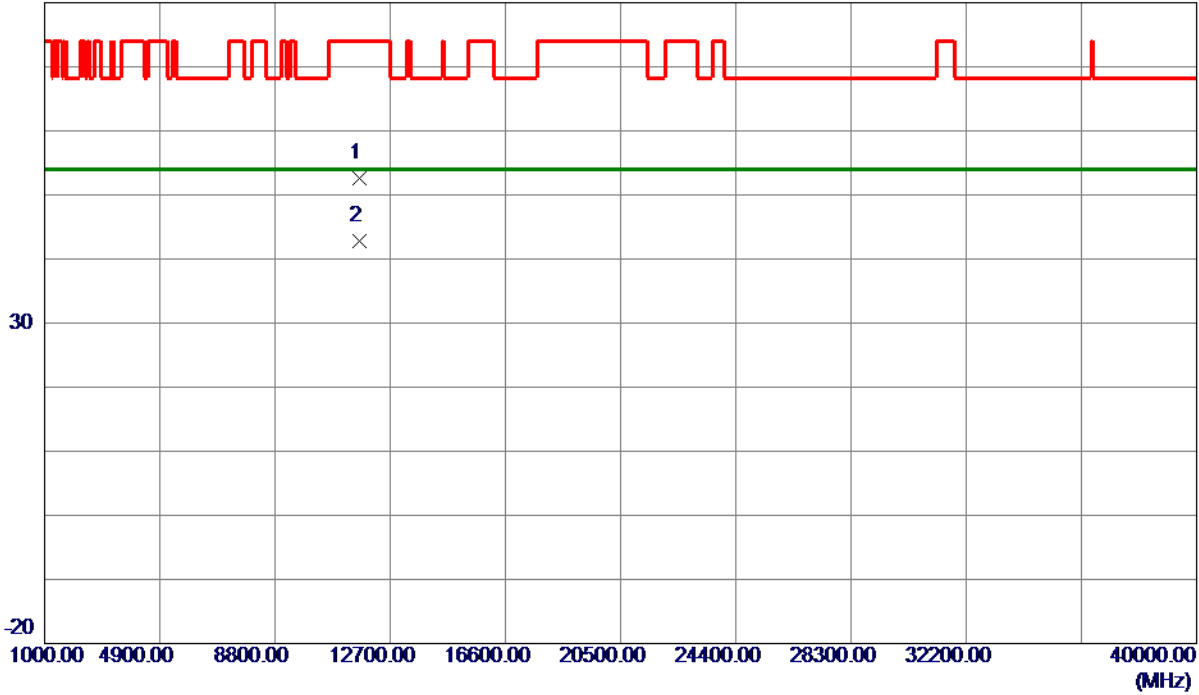

No.	Freq. MHz	Reading Level dBuV/m	Correct Factor dB	Measure ment dBuV/m	Limit dBuV/m	Margin dB	Detector	Comment
1	11641.5000	33.26	19.29	52.55	74.00	-21.45	Peak	
2 *	11651.2000	23.59	19.26	42.85	54.00	-11.15	AVG	

REMARKS:

- (1) Measurement Value = Reading Level + Correct Factor.
- (2) Margin Level = Measurement Value - Limit Value.

Orthogonal Axis	X
Test Mode	UNII-3_TX AC (VHT40) Mode 5755 MHz

Vertical

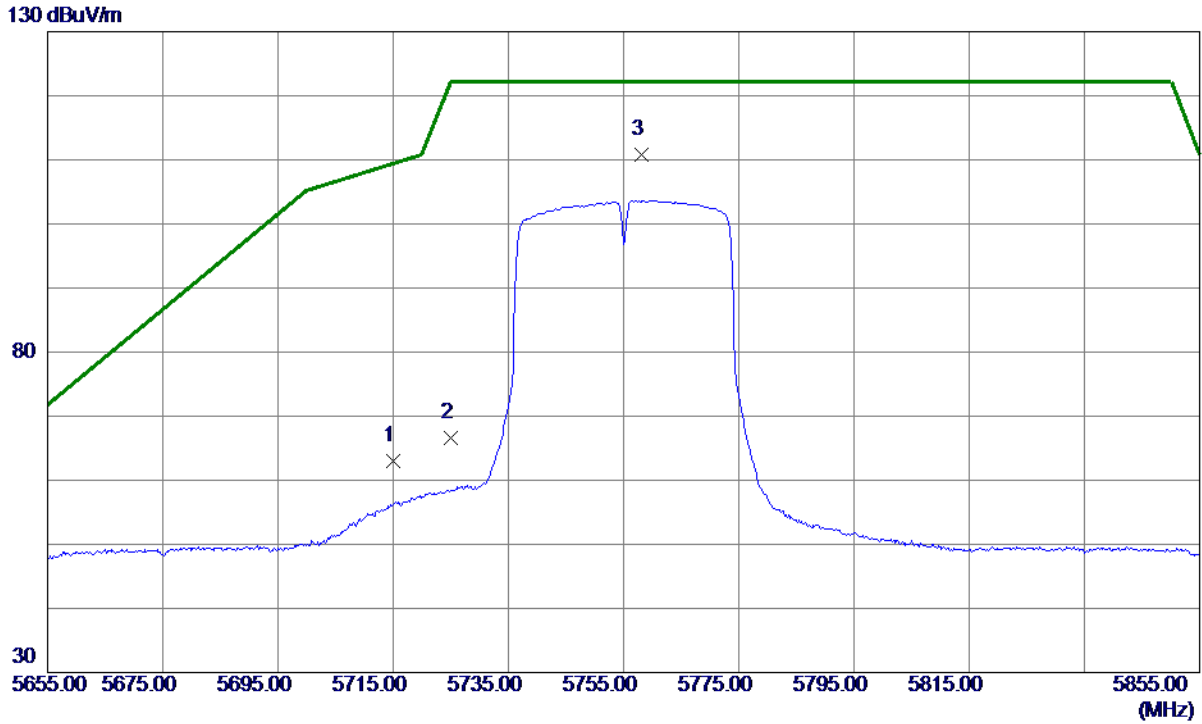

No.	Freq. MHz	Reading Level dBuV/m	Correct Factor dB	Measure ment dBuV/m	Limit dBuV/m	Margin dB	Detector	Comment
1	5715.0000	41.55	21.50	63.05	109.40	-46.35	Peak	
2	5725.0000	45.06	21.55	66.61	122.20	-55.59	Peak	
3 *	5758.2000	89.07	21.71	110.78	122.20	-11.42	Peak	No Limit

REMARKS:

- (1) Measurement Value = Reading Level + Correct Factor.
- (2) Margin Level = Measurement Value - Limit Value.

Orthogonal Axis	X
Test Mode	UNII-3_TX AC (VHT40) Mode 5755 MHz

Vertical

80 dBuV/m

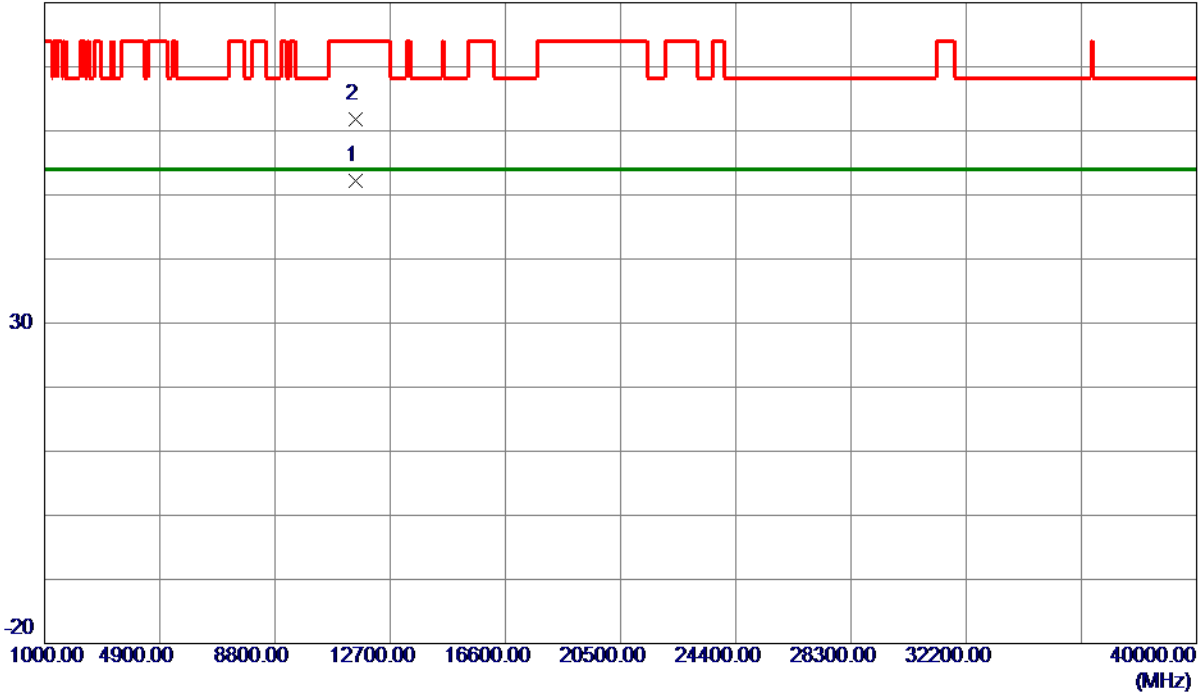

No.	Freq. MHz	Reading Level dBuV/m	Correct Factor dB	Measure ment dBuV/m	Limit dBuV/m	Margin dB	Detector	Comment
1 *	11509.9500	32.47	19.66	52.13	54.00	-1.87	AVG	
2	11511.6500	42.12	19.65	61.77	74.00	-12.23	Peak	

REMARKS:

- (1) Measurement Value = Reading Level + Correct Factor.
- (2) Margin Level = Measurement Value - Limit Value.

Orthogonal Axis	X
Test Mode	UNII-3_TX AC (VHT40) Mode 5755 MHz

Horizontal

130 dBuV/m

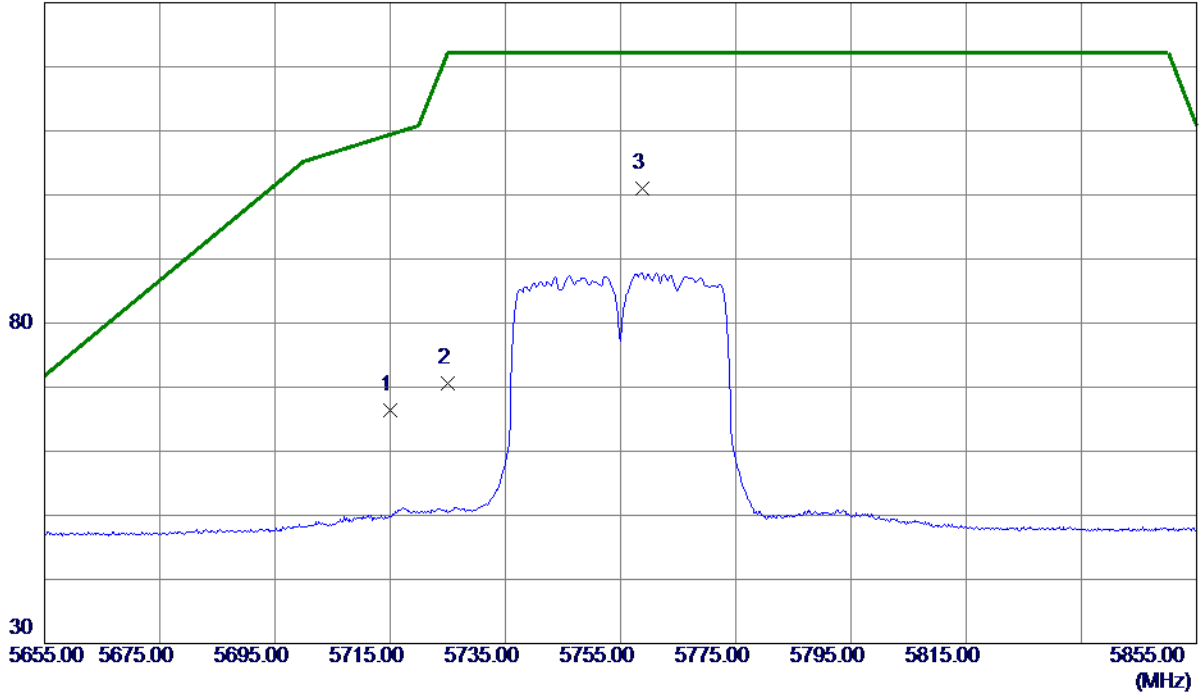

No.	Freq. MHz	Reading Level dBuV/m	Correct Factor dB	Measure ment dBuV/m	Limit dBuV/m	Margin dB	Detector	Comment
1	5715.0000	44.95	21.50	66.45	109.40	-42.95	Peak	
2	5725.0000	49.04	21.55	70.59	122.20	-51.61	Peak	
3 *	5758.8000	79.20	21.72	100.92	122.20	-21.28	Peak	No Limit

REMARKS:

- (1) Measurement Value = Reading Level + Correct Factor.
- (2) Margin Level = Measurement Value - Limit Value.

Orthogonal Axis	X
Test Mode	UNII-3_TX AC (VHT40) Mode 5755 MHz

Horizontal

80 dBuV/m

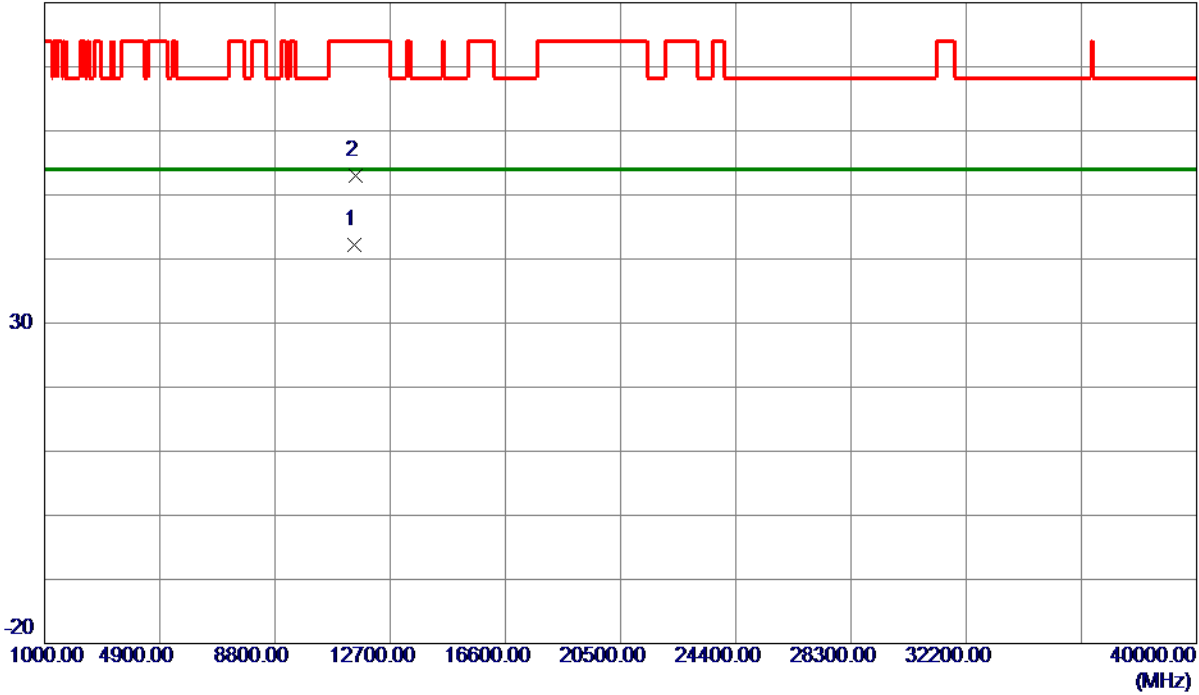

No.	Freq. MHz	Reading Level dBuV/m	Correct Factor dB	Measure ment dBuV/m	Limit dBuV/m	Margin dB	Detector	Comment
1 *	11502.8200	22.54	19.68	42.22	54.00	-11.78	AVG	
2	11508.7400	33.28	19.66	52.94	74.00	-21.06	Peak	

REMARKS:

- (1) Measurement Value = Reading Level + Correct Factor.
- (2) Margin Level = Measurement Value - Limit Value.

Orthogonal Axis	X
Test Mode	UNII-3_TX AC (VHT40) Mode 5795 MHz

Vertical

130 dBuV/m

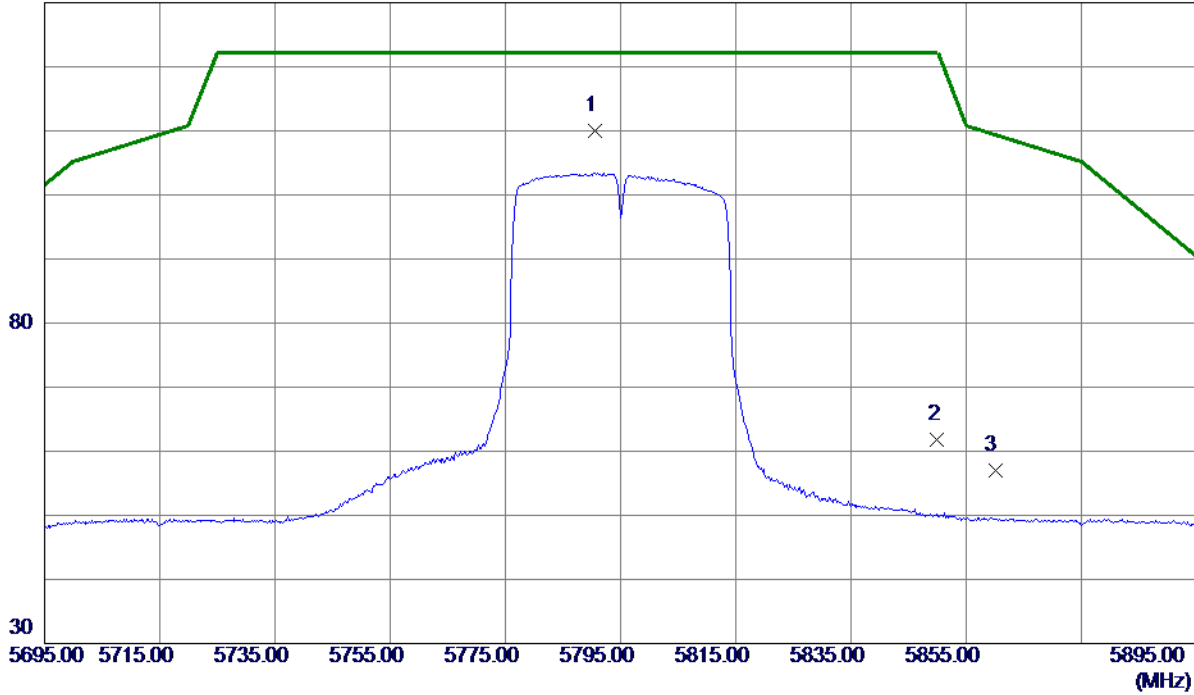

No.	Freq. MHz	Reading Level dBuV/m	Correct Factor dB	Measure ment dBuV/m	Limit dBuV/m	Margin dB	Detector	Comment
1 *	5790.6000	88.08	21.87	109.95	122.20	-12.25	Peak	No Limit
2	5850.0000	39.70	22.16	61.86	122.20	-60.34	Peak	
3	5860.0000	34.84	22.21	57.05	109.40	-52.35	Peak	

REMARKS:

- (1) Measurement Value = Reading Level + Correct Factor.
- (2) Margin Level = Measurement Value - Limit Value.

Orthogonal Axis	X
Test Mode	UNII-3_TX AC (VHT40) Mode 5795 MHz

Vertical

80 dBuV/m

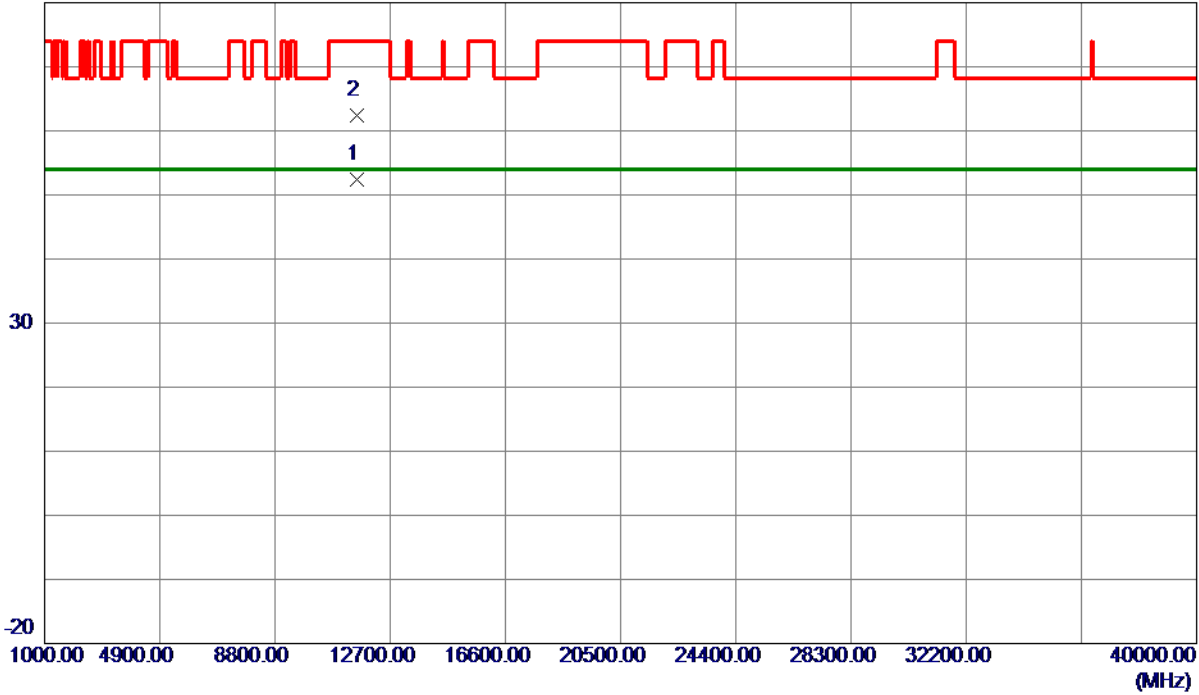

No.	Freq. MHz	Reading Level dBuV/m	Correct Factor dB	Measure ment dBuV/m	Limit dBuV/m	Margin dB	Detector	Comment
1 *	11590.0000	32.94	19.43	52.37	54.00	-1.63	AVG	
2	11591.3000	43.02	19.43	62.45	74.00	-11.55	Peak	

REMARKS:

- (1) Measurement Value = Reading Level + Correct Factor.
- (2) Margin Level = Measurement Value - Limit Value.

Orthogonal Axis	X
Test Mode	UNII-3_TX AC (VHT40) Mode 5795 MHz

Horizontal

130 dBuV/m

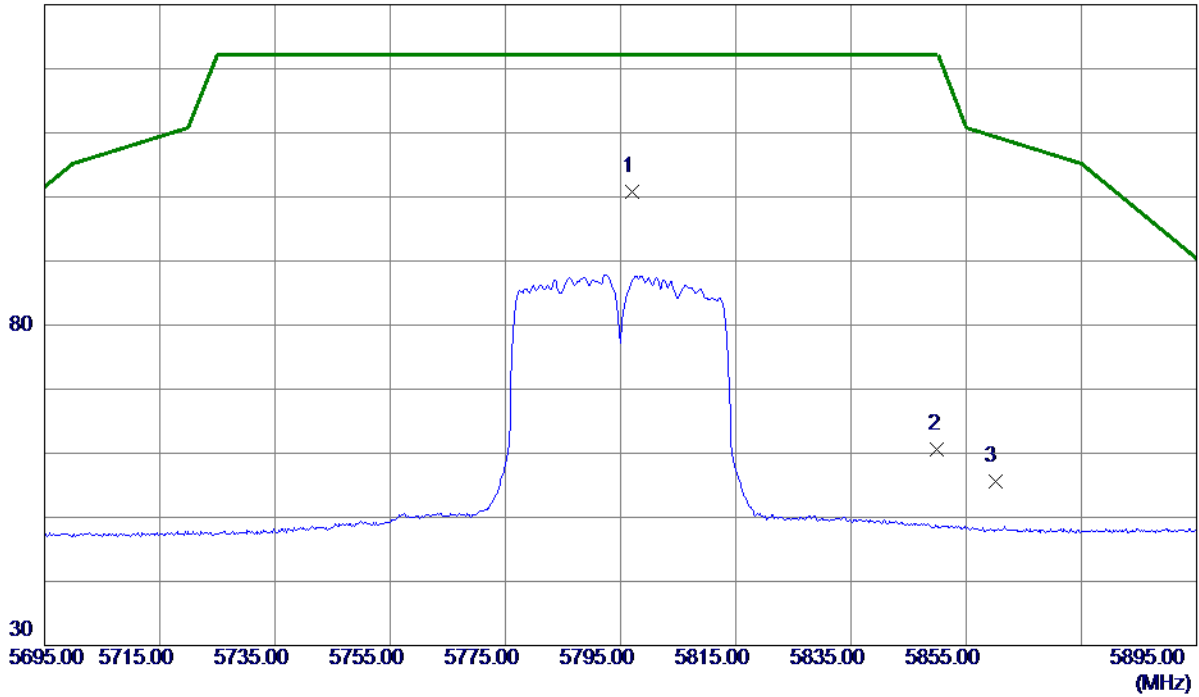

No.	Freq. MHz	Reading Level dBuV/m	Correct Factor dB	Measure ment dBuV/m	Limit dBuV/m	Margin dB	Detector	Comment
1 *	5797.0000	78.94	21.90	100.84	122.20	-21.36	Peak	No Limit
2	5850.0000	38.43	22.16	60.59	122.20	-61.61	Peak	
3	5860.0000	33.32	22.21	55.53	109.40	-53.87	Peak	

REMARKS:

- (1) Measurement Value = Reading Level + Correct Factor.
- (2) Margin Level = Measurement Value - Limit Value.

Orthogonal Axis	X
Test Mode	UNII-3_TX AC (VHT40) Mode 5795 MHz

Horizontal

80 dBuV/m

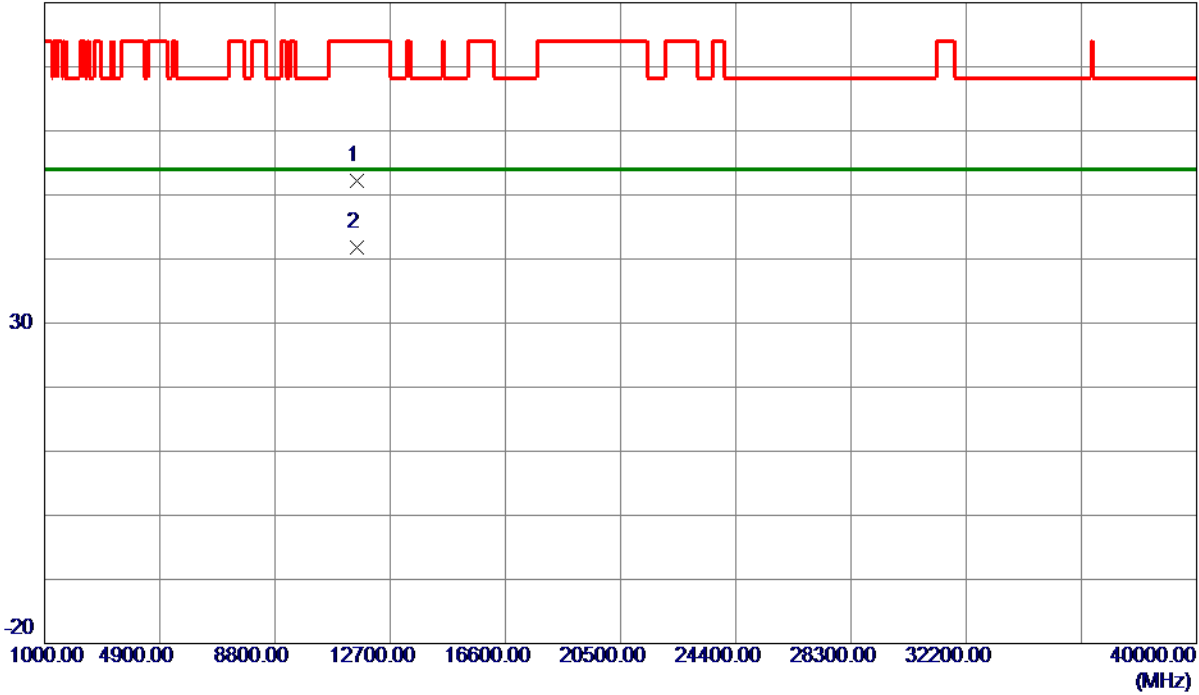

No.	Freq. MHz	Reading Level dBuV/m	Correct Factor dB	Measure ment dBuV/m	Limit dBuV/m	Margin dB	Detector	Comment
1	11584.3000	32.74	19.45	52.19	74.00	-21.81	Peak	
2 *	11588.8800	22.39	19.44	41.83	54.00	-12.17	AVG	

REMARKS:

- (1) Measurement Value = Reading Level + Correct Factor.
- (2) Margin Level = Measurement Value - Limit Value.

Orthogonal Axis	X
Test Mode	UNII-3_TX AC (VHT80) Mode 5775 MHz

Vertical

130 dBuV/m

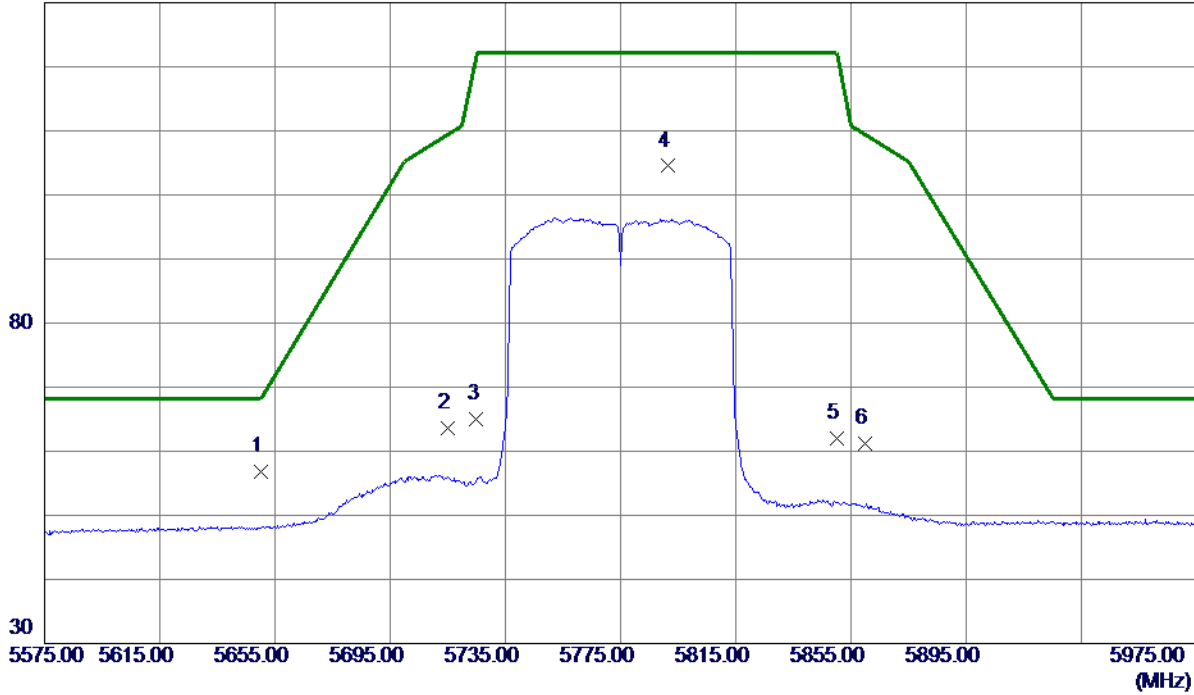

No.	Freq. MHz	Reading Level dBuV/m	Correct Factor dB	Measure ment dBuV/m	Limit dBuV/m	Margin dB	Detector	Comment
1 *	5650.2000	35.68	21.19	56.87	68.35	-11.48	Peak	
2	5715.0000	42.18	21.50	63.68	109.40	-45.72	Peak	
3	5725.0000	43.47	21.55	65.02	122.20	-57.18	Peak	
4	5791.4000	82.63	21.87	104.50	122.20	-17.70	Peak	No Limit
5	5850.0000	39.84	22.16	62.00	122.20	-60.20	Peak	
6	5860.0000	39.02	22.21	61.23	109.40	-48.17	Peak	

REMARKS:

- (1) Measurement Value = Reading Level + Correct Factor.
- (2) Margin Level = Measurement Value - Limit Value.

Orthogonal Axis	X
Test Mode	UNII-3_TX AC (VHT80) Mode 5775 MHz

Vertical

80 dBuV/m

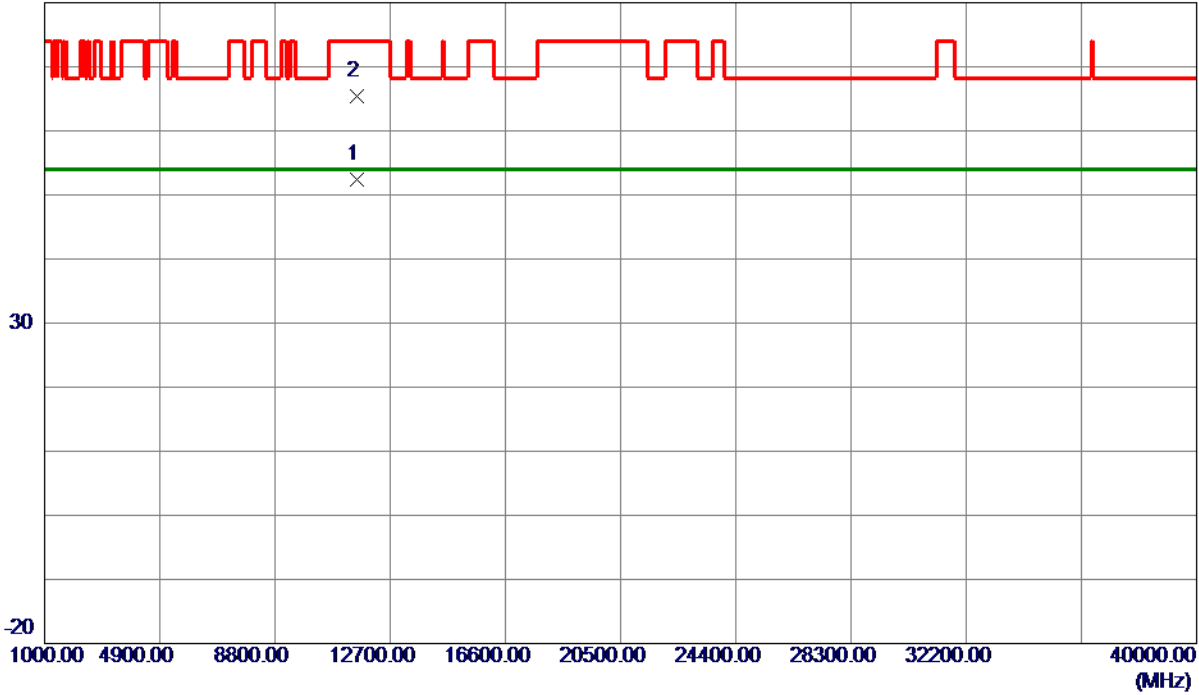

No.	Freq. MHz	Reading Level dBuV/m	Correct Factor dB	Measure ment dBuV/m	Limit dBuV/m	Margin dB	Detector	Comment
1 *	11556.3000	32.89	19.53	52.42	54.00	-1.58	AVG	
2	11566.5000	45.96	19.50	65.46	74.00	-8.54	Peak	

REMARKS:

- (1) Measurement Value = Reading Level + Correct Factor.
- (2) Margin Level = Measurement Value - Limit Value.

Orthogonal Axis	X
Test Mode	UNII-3_TX AC (VHT80) Mode 5775 MHz

Horizontal

130 dBuV/m

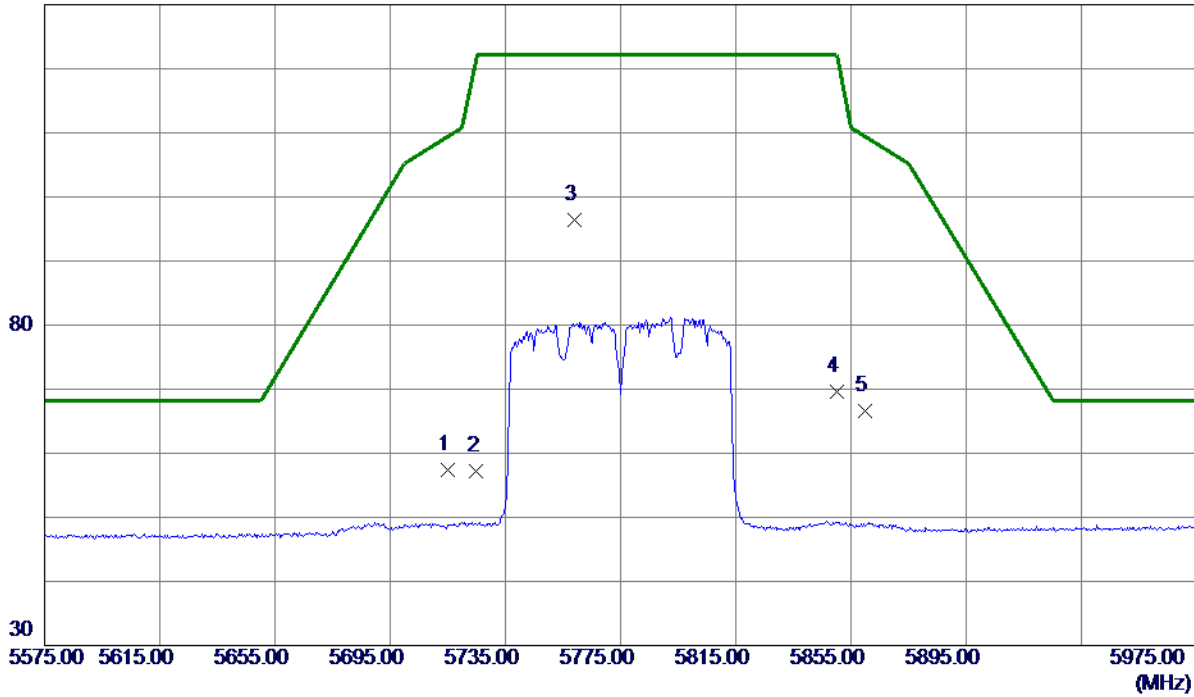

No.	Freq. MHz	Reading Level dBuV/m	Correct Factor dB	Measure ment dBuV/m	Limit dBuV/m	Margin dB	Detector	Comment
1	5715.0000	35.87	21.50	57.37	109.40	-52.03	Peak	
2	5725.0000	35.69	21.55	57.24	122.20	-64.96	Peak	
3 *	5759.0000	74.61	21.72	96.33	122.20	-25.87	Peak	No Limit
4	5850.0000	47.44	22.16	69.60	122.20	-52.60	Peak	
5	5860.0000	44.34	22.21	66.55	109.40	-42.85	Peak	

REMARKS:

- (1) Measurement Value = Reading Level + Correct Factor.
- (2) Margin Level = Measurement Value - Limit Value.

Orthogonal Axis	X
Test Mode	UNII-3_TX AC (VHT80) Mode 5775 MHz

Horizontal

80 dBuV/m

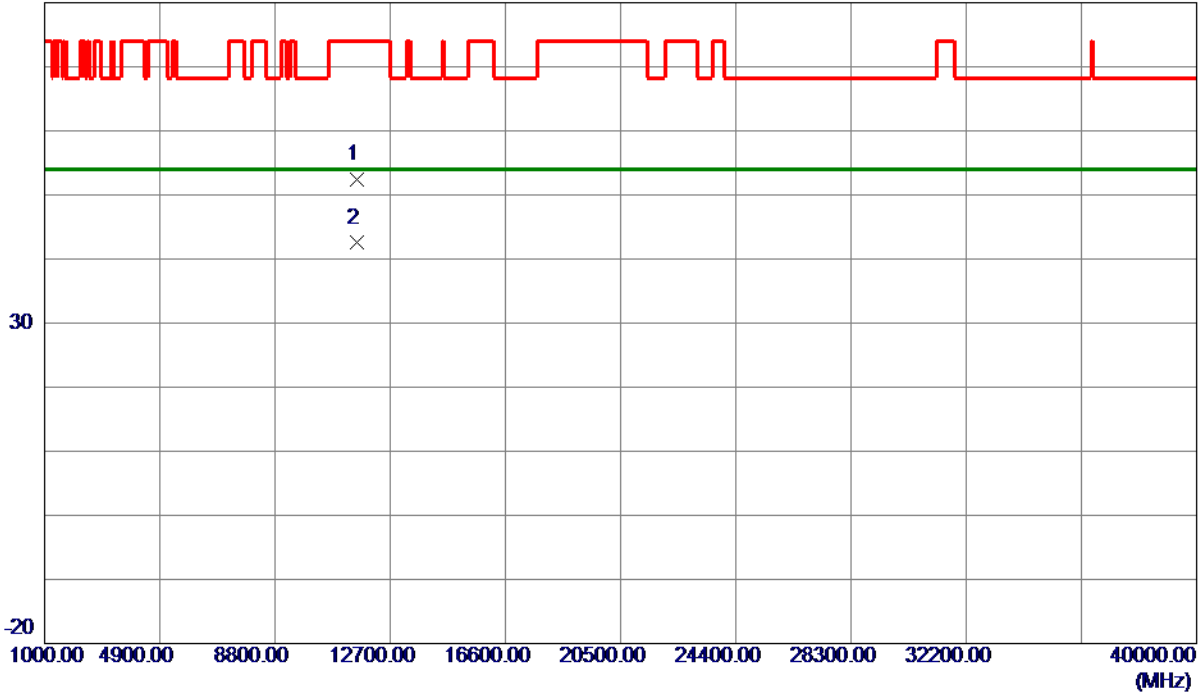

No.	Freq. MHz	Reading Level dBuV/m	Correct Factor dB	Measure ment dBuV/m	Limit dBuV/m	Margin dB	Detector	Comment
1	11556.9000	32.94	19.53	52.47	74.00	-21.53	Peak	
2 *	11558.5000	22.98	19.52	42.50	54.00	-11.50	AVG	

REMARKS:

- (1) Measurement Value = Reading Level + Correct Factor.
- (2) Margin Level = Measurement Value - Limit Value.

The worst case of simultaneous transmission:

Test Mode:	TX G Mode 2412+AC 40 Mode 5190MHz
------------	-----------------------------------

Vertical

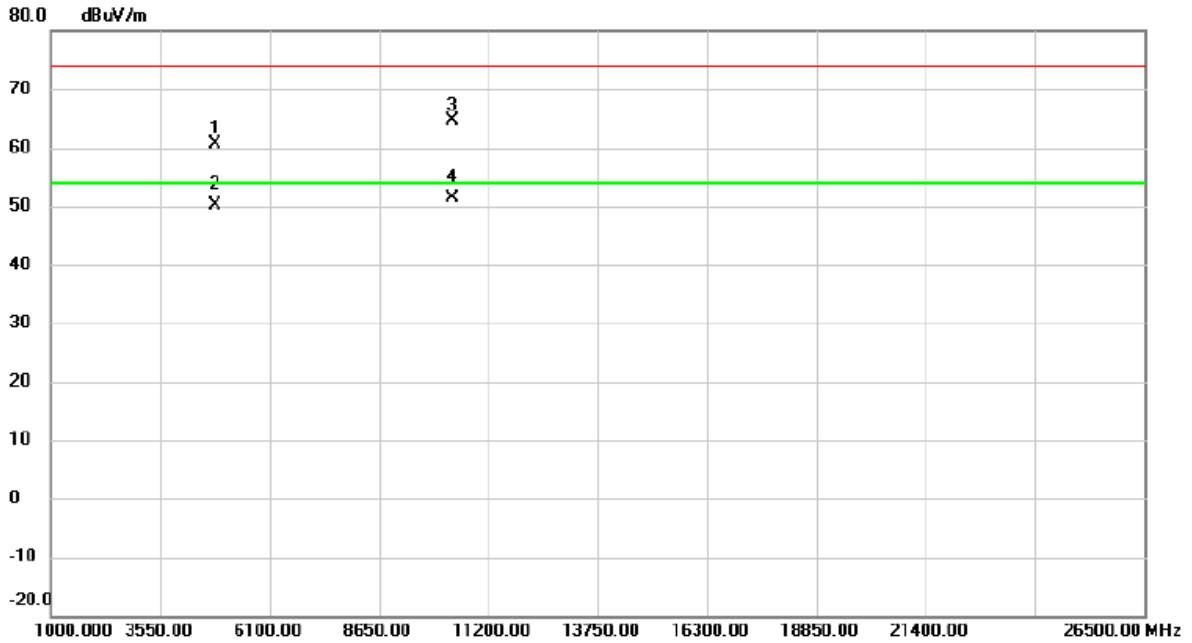

No.	Mk.	Freq. MHz	Reading Level dBuV	Correct Factor dB	Measure- ment dBuV/m	Limit dBuV/m	Margin dB	Detector	Comment
1		4823.138	52.58	8.04	60.62	74.00	-13.38	peak	
2		4824.215	42.17	8.04	50.21	54.00	-3.79	AVG	
3		10381.340	44.59	20.02	64.61	74.00	-9.39	peak	
4	*	10380.000	31.25	20.02	51.27	54.00	-2.73	AVG	

REMARKS:

- (1) Measurement Value = Reading Level + Correct Factor.
- (2) Margin Level = Measurement Value - Limit Value.

Test Mode: TX G Mode 2412+AC 40 Mode 5190MHz

Horizontal



No.	Mk.	Freq. MHz	Reading Level dBuV	Correct Factor dB	Measure- ment dBuV/m	Limit dBuV/m	Margin dB	Detector	Comment
1		4823.865	34.75	8.04	42.79	54.00	-11.21	AVG	
2		4824.115	44.89	8.04	52.93	74.00	-21.07	peak	
3		10381.663	39.98	20.02	60.00	74.00	-14.00	peak	
4	*	10382.124	25.46	20.03	45.49	54.00	-8.51	AVG	

REMARKS:

- (1) Measurement Value = Reading Level + Correct Factor.
- (2) Margin Level = Measurement Value - Limit Value.

APPENDIX E - BANDWIDTH

Non-Beamforming

Test Mode	UNII-1_TX A Mode_Ant. 1
-----------	-------------------------

Channel	Frequency (MHz)	26 dB Bandwidth (MHz)	99 % Emission Bandwidth (MHz)
36	5180	22.16	16.60
40	5200	18.86	16.60
48	5240	18.89	16.60

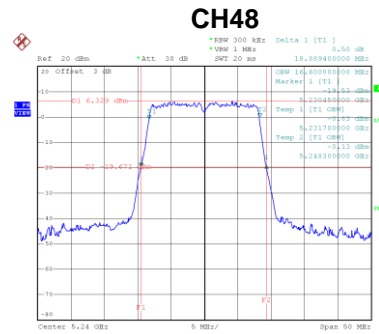
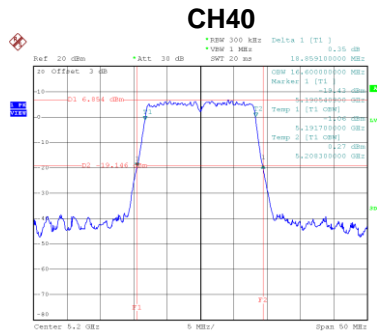
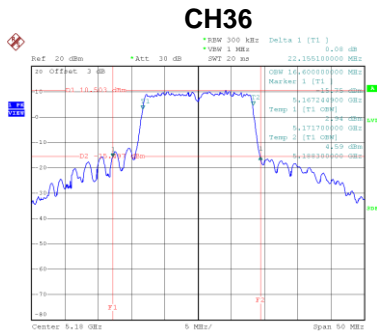

Test Mode	UNII-1_TX N (HT20) Mode_Ant. 1
-----------	--------------------------------

Channel	Frequency (MHz)	26 dB Bandwidth (MHz)	99 % Emission Bandwidth (MHz)
36	5180	19.95	17.70
40	5200	19.95	17.70
48	5240	19.90	17.60

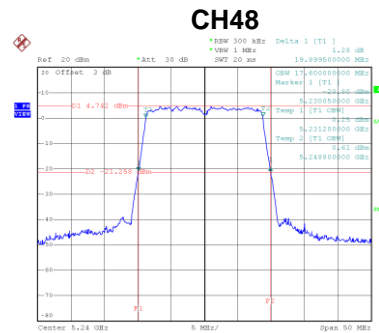
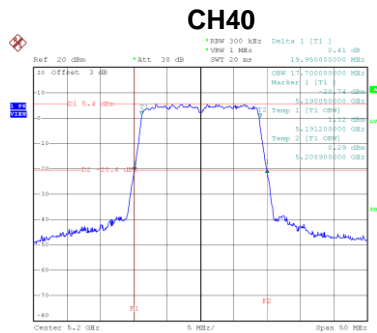
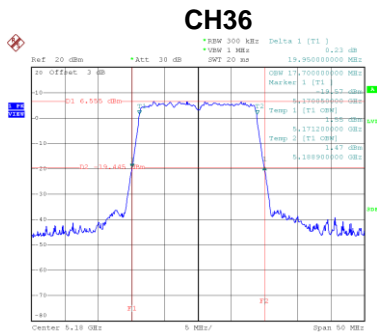

Test Mode	UNII-1_TX N (HT40) Mode_Ant. 1
-----------	--------------------------------

Channel	Frequency (MHz)	26 dB Bandwidth (MHz)	99 % Emission Bandwidth (MHz)
38	5190	43.10	36.80
46	5230	43.10	36.60

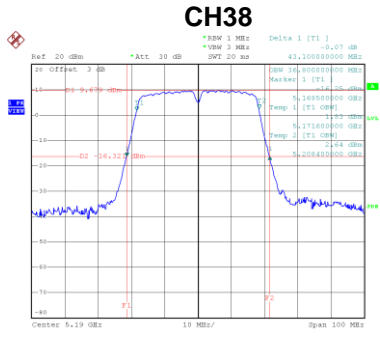

Date: 6.JAN.2020 13:14:27

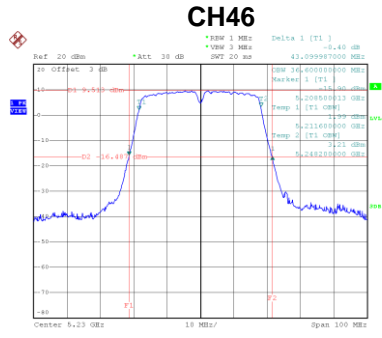

Date: 6.JAN.2020 13:15:25

Test Mode	UNII-3_TX A Mode_Ant. 1
-----------	-------------------------

Channel	Frequency (MHz)	6 dB Bandwidth (MHz)	6 dB Bandwidth Min. Limit (kHz)	Result
149	5745	16.65	500	Complies
157	5785	16.65	500	Complies
165	5825	16.65	500	Complies

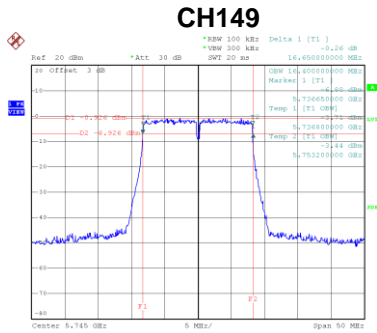

Date: 6.JAN.2020 12:51:06

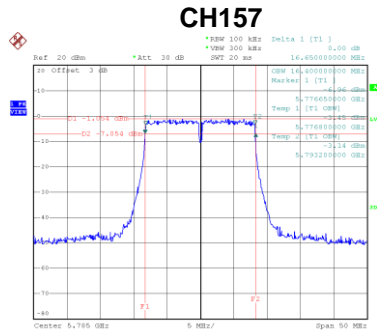

Date: 6.JAN.2020 12:57:04

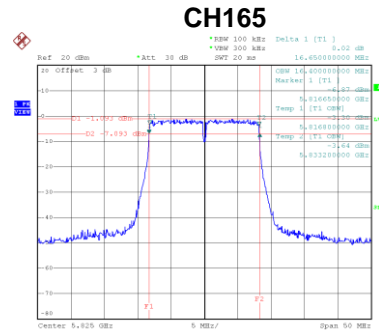

Date: 6.JAN.2020 13:01:20

Channel	Frequency (MHz)	99 % Emission Bandwidth (MHz)	Result
149	5745	16.60	Complies
157	5785	16.60	Complies
165	5825	16.60	Complies

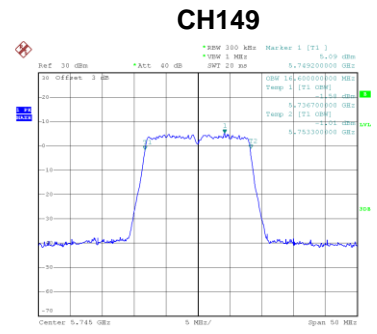

Date: 6.JAN.2020 12:58:11

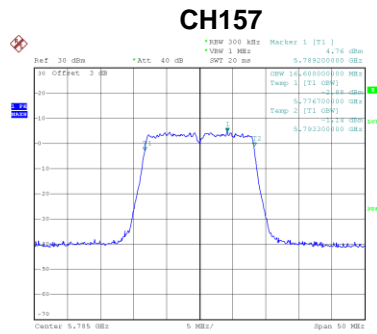

Date: 6.JAN.2020 12:57:39

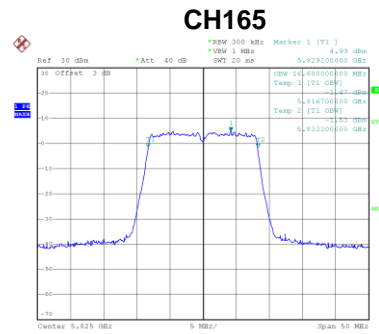

Date: 6.JAN.2020 13:02:47

Test Mode	UNII-3_TX N (HT20) Mode_Ant. 1
-----------	--------------------------------

Channel	Frequency (MHz)	6 dB Bandwidth (MHz)	6 dB Bandwidth Min. Limit (kHz)	Result
149	5745	17.75	500	Complies
157	5785	17.85	500	Complies
165	5825	17.85	500	Complies

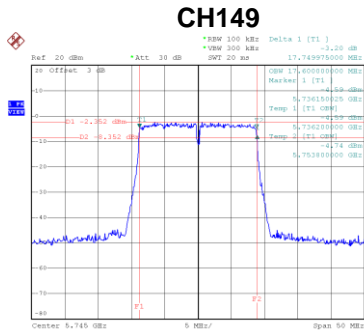

Date: 6.JAN.2020 13:07:12

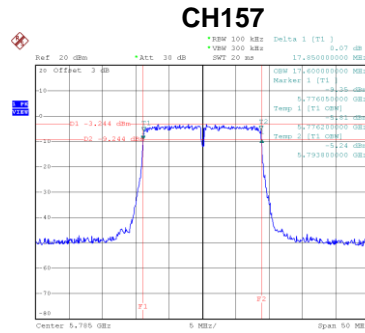

Date: 6.JAN.2020 13:09:06

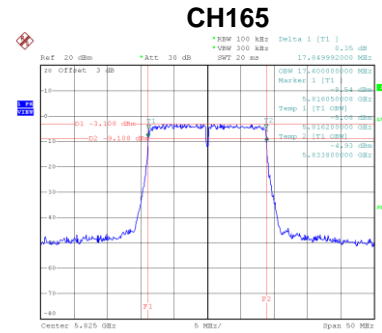

Date: 6.JAN.2020 13:11:10

Channel	Frequency (MHz)	99 % Emission Bandwidth (MHz)	Result
149	5745	17.70	Complies
157	5785	17.70	Complies
165	5825	17.70	Complies

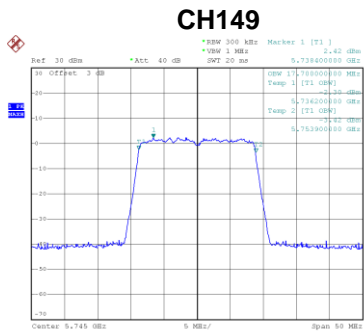

Date: 6.JAN.2020 13:07:26

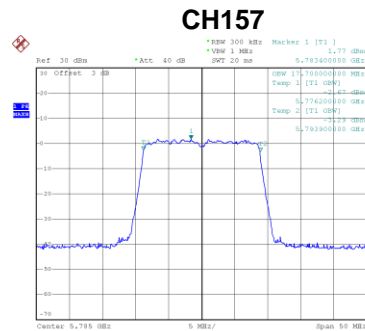

Date: 6.JAN.2020 13:09:31

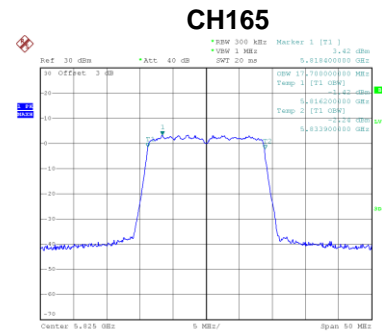

Date: 6.JAN.2020 13:12:46

Test Mode	UNII-3_TX N (HT40) Mode_Ant. 1
-----------	--------------------------------

Channel	Frequency (MHz)	6 dB Bandwidth (MHz)	6 dB Bandwidth Min. Limit (kHz)	Result
151	5755	36.59	500	Complies
159	5795	36.80	500	Complies

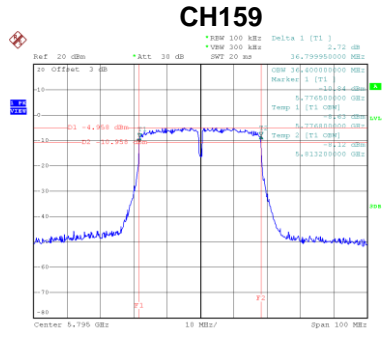
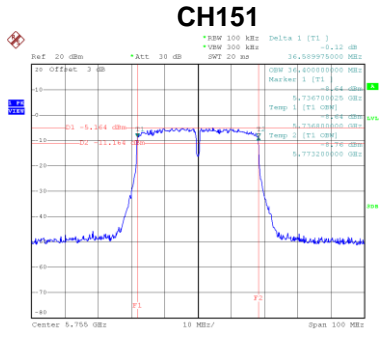

Channel	Frequency (MHz)	99 % Emission Bandwidth (MHz)	Result
151	5755	36.80	Complies
159	5795	36.80	Complies

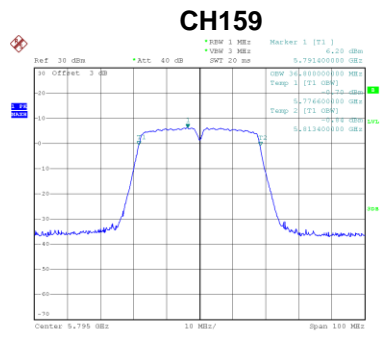
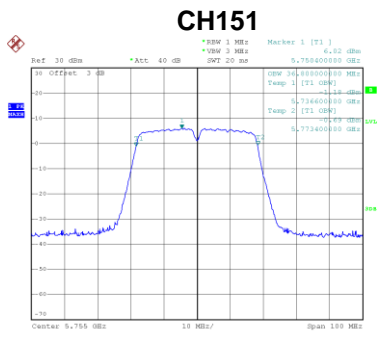

Test Mode	UNII-1_TX AC (VHT20) Mode_Ant. 1
-----------	----------------------------------

Channel	Frequency (MHz)	26 dB Bandwidth (MHz)	99 % Emission Bandwidth (MHz)
36	5180	19.75	17.70
40	5200	19.75	17.70
48	5240	19.85	17.70

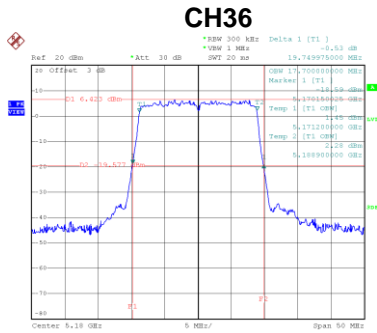

Date: 6.JAN.2020 13:21:15

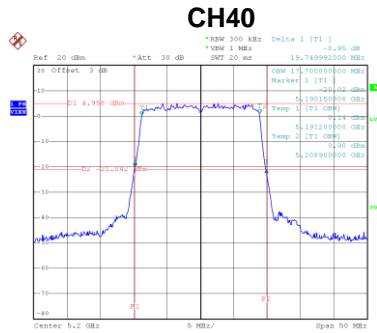

Date: 6.JAN.2020 13:22:21

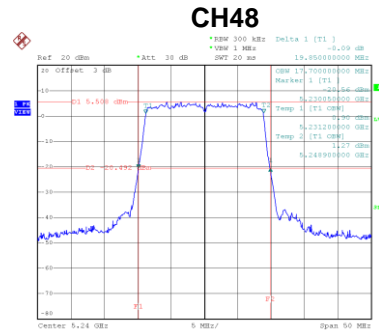

Date: 6.JAN.2020 13:23:24

Test Mode	UNII-1_TX AC (VHT40) Mode_Ant. 1
-----------	----------------------------------

Channel	Frequency (MHz)	26 dB Bandwidth (MHz)	99 % Emission Bandwidth (MHz)
38	5190	42.41	36.60
46	5230	42.59	36.60

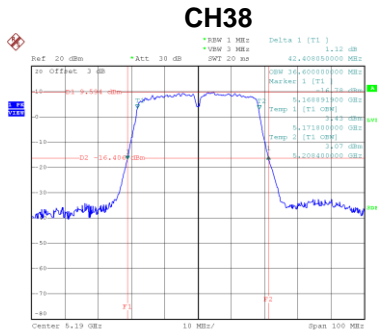

Date: 6.JAN.2020 13:32:05

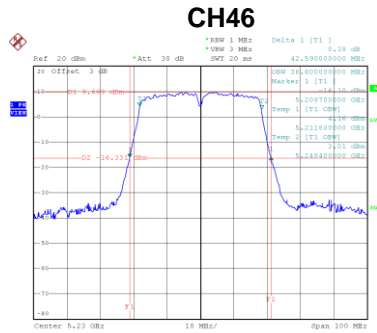

Date: 6.JAN.2020 13:33:38

Test Mode	UNII-1_TX AC (VHT80) _Ant. 1
-----------	------------------------------

Channel	Frequency (MHz)	26 dB Bandwidth (MHz)	99 % Emission Bandwidth (MHz)
42	5210	82.00	75.60

CH42

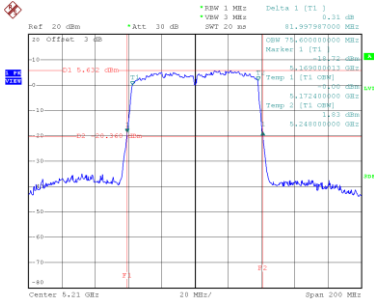

Date: 6.JAN.2020 13:40:29

Test Mode	UNII-3_TX AC (VHT20) Mode_Ant. 1
-----------	----------------------------------

Channel	Frequency (MHz)	6 dB Bandwidth (MHz)	6 dB Bandwidth Min. Limit (kHz)	Result
149	5745	17.90	500	Complies
157	5785	17.90	500	Complies
165	5825	17.90	500	Complies

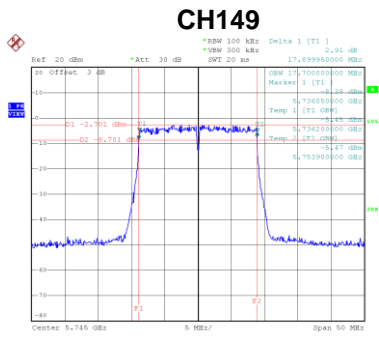

Date: 6.JAN.2020 13:25:03

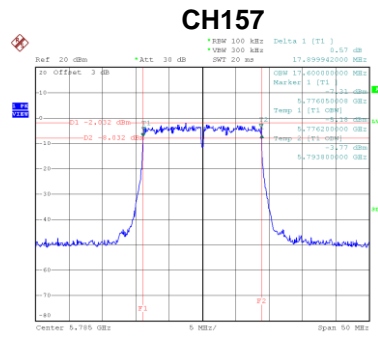

Date: 6.JAN.2020 13:27:41

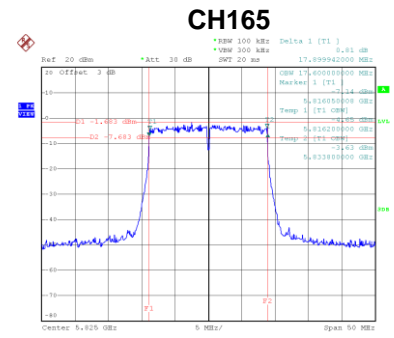

Date: 6.JAN.2020 13:29:44

Channel	Frequency (MHz)	99 % Emission Bandwidth (MHz)	Result
149	5745	17.70	Complies
157	5785	17.70	Complies
165	5825	17.70	Complies

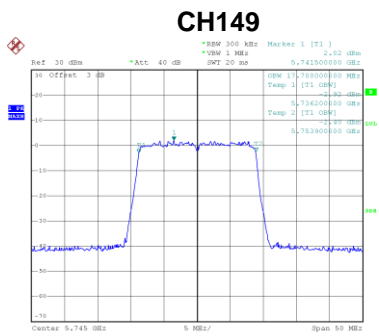

Date: 6.JAN.2020 13:25:48

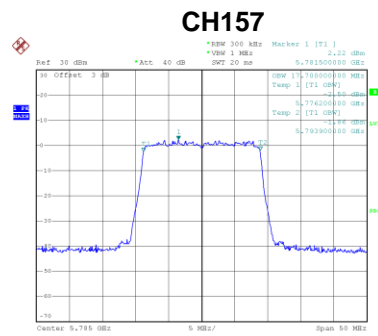

Date: 6.JAN.2020 13:27:58

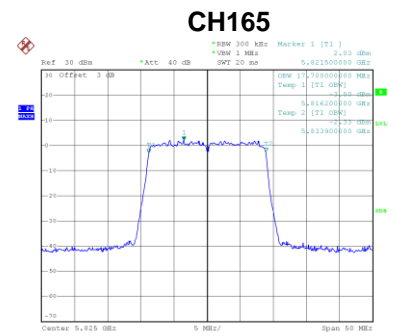

Date: 6.JAN.2020 13:29:59

Test Mode	UNII-3_TX AC (VHT40) Mode_Ant. 1
-----------	----------------------------------

Channel	Frequency (MHz)	6 dB Bandwidth (MHz)	6 dB Bandwidth Min. Limit (kHz)	Result
151	5755	36.70	500	Complies
159	5795	36.50	500	Complies

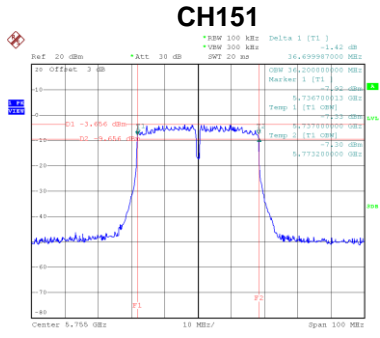

Date: 6.JAN.2020 13:35:19

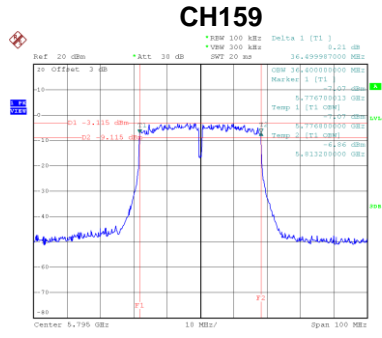

Date: 6.JAN.2020 13:38:14

Channel	Frequency (MHz)	99 % Emission Bandwidth (MHz)	Result
151	5755	36.80	Complies
159	5795	36.80	Complies

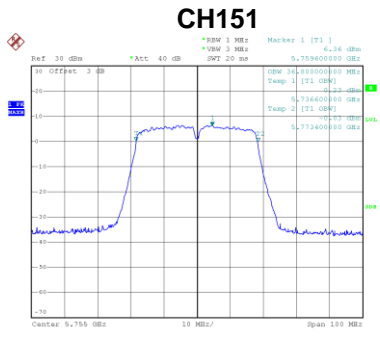

Date: 6.JAN.2020 13:36:28

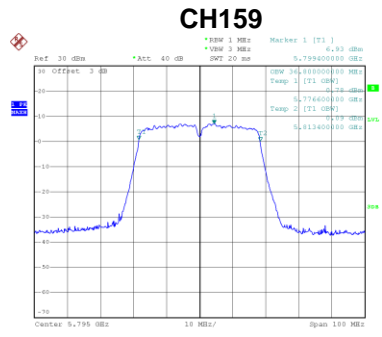

Date: 6.JAN.2020 13:38:29

Test Mode	UNII-3_TX AC (VHT80) _Ant. 1
-----------	------------------------------

Channel	Frequency (MHz)	6 dB Bandwidth (MHz)	6 dB Bandwidth Min. Limit (kHz)	Result
155	5775	76.40	500	Complies

CH155

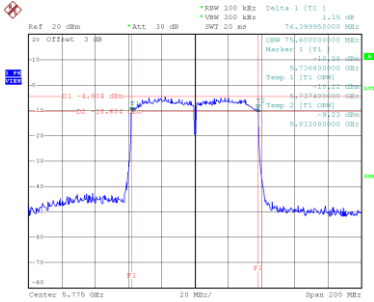

Channel	Frequency (MHz)	99 % Emission Bandwidth (MHz)	Result
155	5775	75.60	Complies

CH155

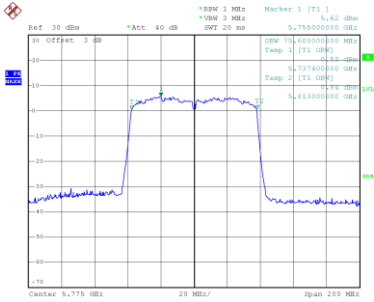

Beamforming

Test Mode	UNII-1_TX N (HT20) Mode_Ant. 1
-----------	--------------------------------

Channel	Frequency (MHz)	26 dB Bandwidth (MHz)	99 % Emission Bandwidth (MHz)
36	5180	19.95	17.70
40	5200	19.95	17.70
48	5240	19.90	17.60

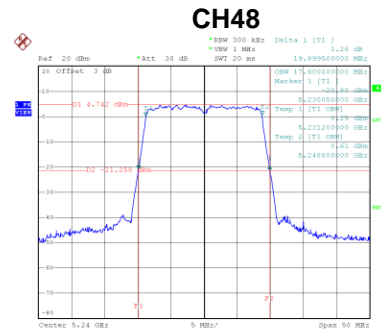
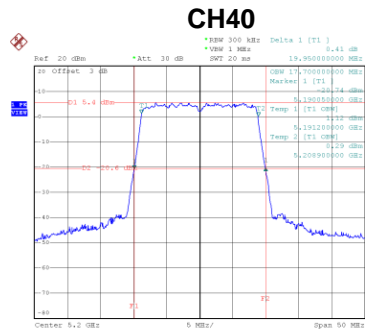
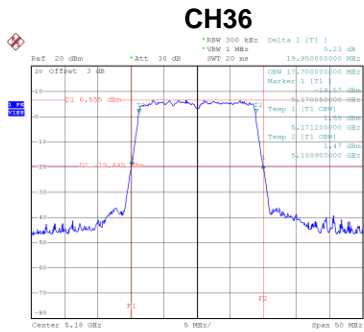

Date: 6.JAN.2020 13:04:18

Date: 6.JAN.2020 13:05:13

Date: 6.JAN.2020 13:06:06

Test Mode	UNII-1_TX N (HT40) Mode_Ant. 1
-----------	--------------------------------

Channel	Frequency (MHz)	26 dB Bandwidth (MHz)	99 % Emission Bandwidth (MHz)
38	5190	43.10	36.80
46	5230	43.10	36.60

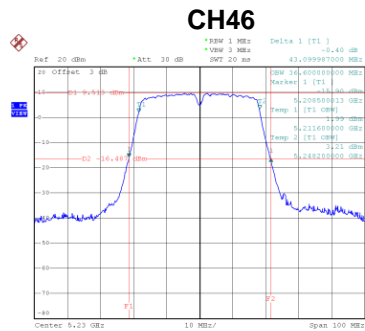
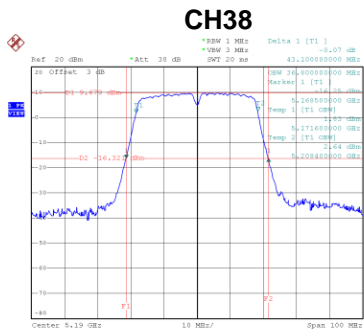

Date: 6.JAN.2020 13:14:27

Date: 6.JAN.2020 13:15:25

Test Mode UNII-3_TX N (HT20) Mode_Ant. 1

Channel	Frequency (MHz)	6 dB Bandwidth (MHz)	6 dB Bandwidth Min. Limit (kHz)	Result
149	5745	17.75	500	Complies
157	5785	17.85	500	Complies
165	5825	17.85	500	Complies

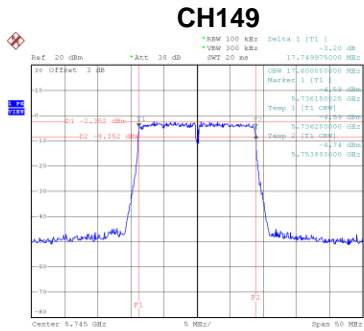

Date: 6.JAN.2020 13:07:12

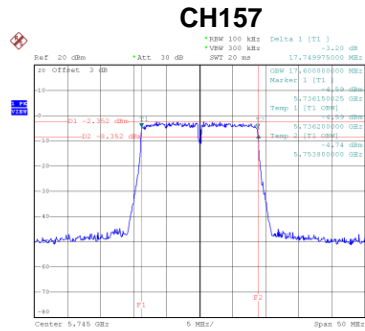

Date: 6.JAN.2020 13:07:12

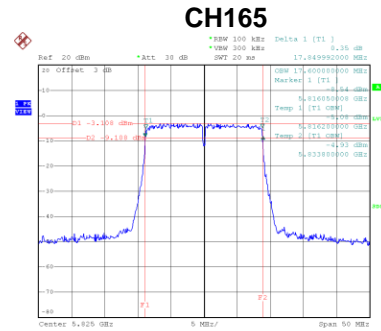

Date: 6.JAN.2020 13:11:10

Channel	Frequency (MHz)	99 % Emission Bandwidth (MHz)	Result
149	5745	17.70	Complies
157	5785	17.70	Complies
165	5825	17.70	Complies

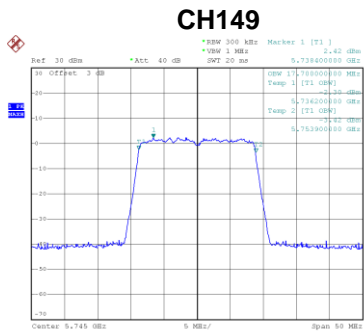

Date: 6.JAN.2020 13:07:26

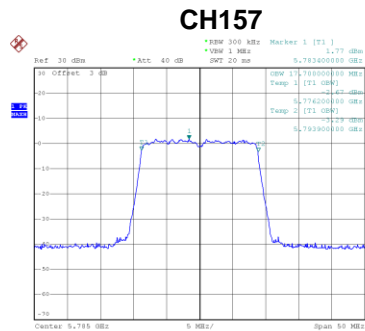

Date: 6.JAN.2020 13:09:31

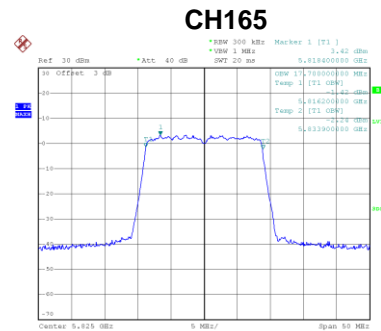

Date: 6.JAN.2020 13:12:46

Test Mode	UNII-3_TX N (HT40) Mode_Ant. 1
-----------	--------------------------------

Channel	Frequency (MHz)	6 dB Bandwidth (MHz)	6 dB Bandwidth Min. Limit (kHz)	Result
151	5755	36.59	500	Complies
159	5795	36.80	500	Complies

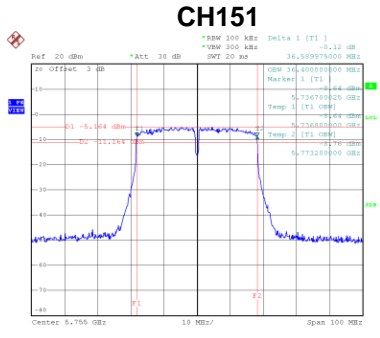

Date: 6.JAN.2020 13:16:56

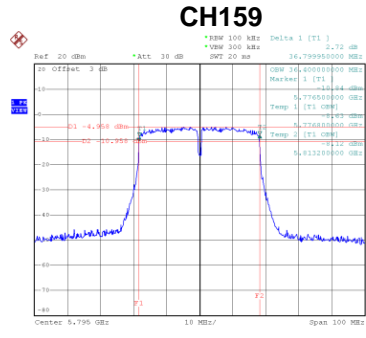

Date: 6.JAN.2020 13:18:56

Channel	Frequency (MHz)	99 % Emission Bandwidth (MHz)	Result
151	5755	36.80	Complies
159	5795	36.80	Complies

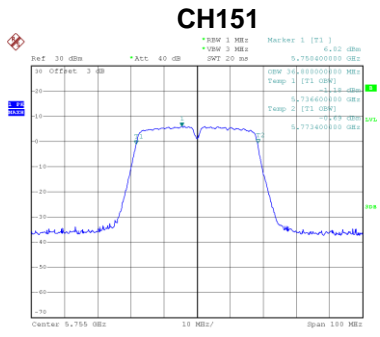

Date: 6.JAN.2020 13:17:22

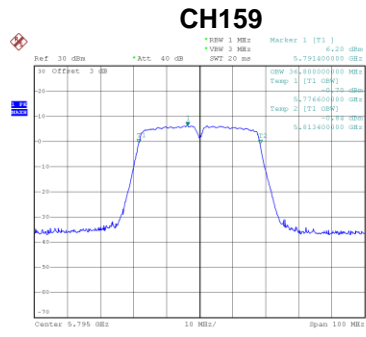

Date: 6.JAN.2020 13:19:13

Test Mode	UNII-1_TX AC (VHT20) Mode_Ant. 1
-----------	----------------------------------

Channel	Frequency (MHz)	26 dB Bandwidth (MHz)	99 % Emission Bandwidth (MHz)
36	5180	19.75	17.70
40	5200	19.75	17.70
48	5240	19.85	17.70

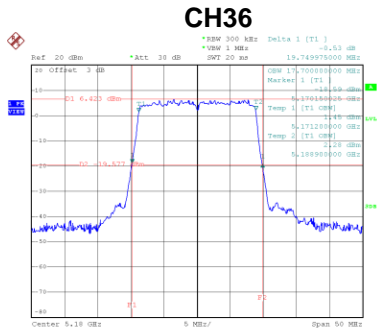

Date: 6.JAN.2020 13:21:15

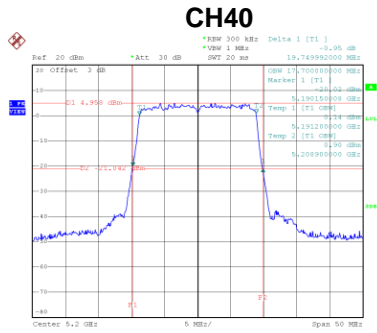

Date: 6.JAN.2020 13:22:21

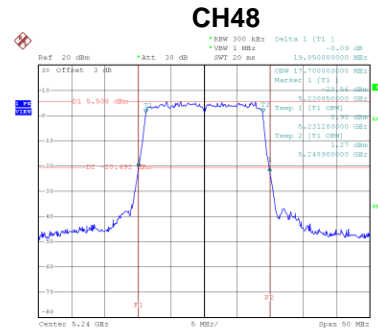

Date: 6.JAN.2020 13:23:24

Test Mode	UNII-1_TX AC (VHT40) Mode_Ant. 1
-----------	----------------------------------

Channel	Frequency (MHz)	26 dB Bandwidth (MHz)	99 % Emission Bandwidth (MHz)
38	5190	42.41	36.60
46	5230	42.60	36.60

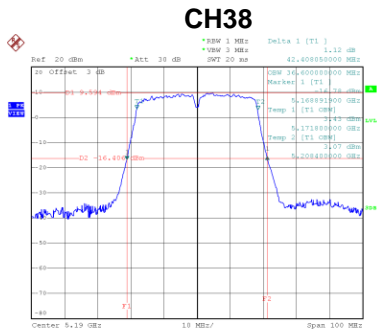

Date: 6.JAN.2020 13:32:05

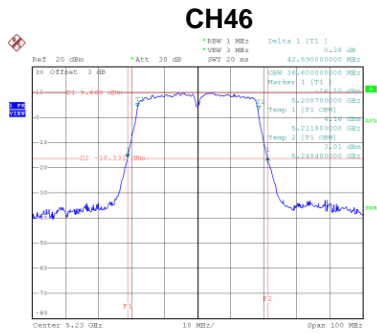

Date: 6.JAN.2020 13:33:38

Test Mode	UNII-1_TX AC (VHT80) _Ant. 1
-----------	------------------------------

Channel	Frequency (MHz)	26 dB Bandwidth (MHz)	99 % Emission Bandwidth (MHz)
42	5210	82.00	75.60

CH42

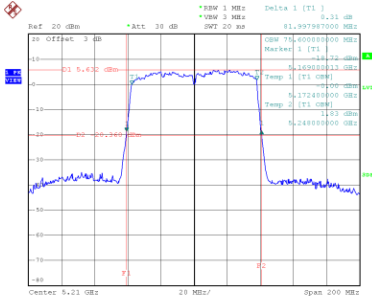

Date: 6.JAN.2020 13:40:29

Test Mode	UNII-3_TX AC (VHT20) Mode_Ant. 1
-----------	----------------------------------

Channel	Frequency (MHz)	6 dB Bandwidth (MHz)	6 dB Bandwidth Min. Limit (kHz)	Result
149	5745	17.90	500	Complies
157	5785	17.90	500	Complies
165	5825	17.90	500	Complies

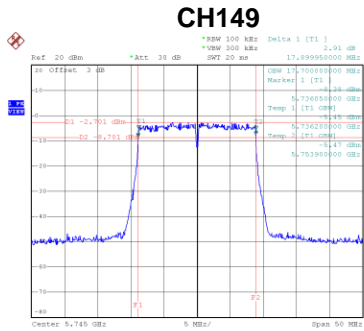

Date: 6.JAN.2020 13:25:03

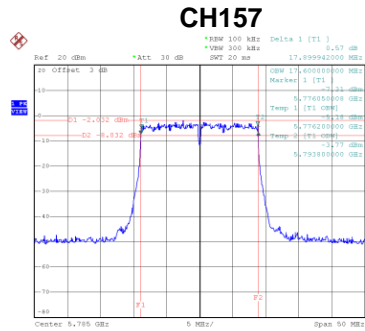

Date: 6.JAN.2020 13:27:41

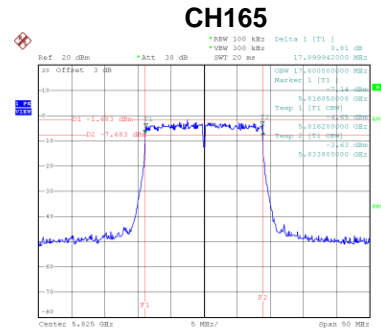

Date: 6.JAN.2020 13:29:44

Channel	Frequency (MHz)	99 % Emission Bandwidth (MHz)	Result
149	5745	17.70	Complies
157	5785	17.70	Complies
165	5825	17.70	Complies

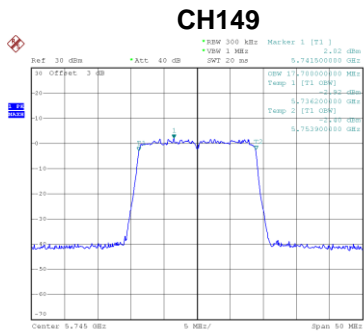

Date: 6.JAN.2020 13:25:48

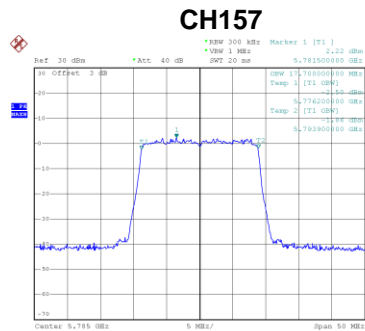

Date: 6.JAN.2020 13:27:58

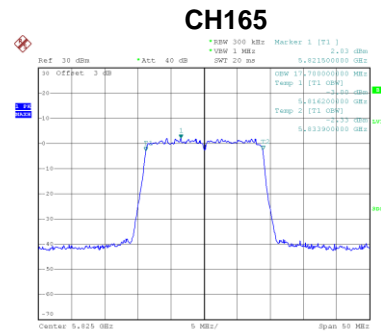

Date: 6.JAN.2020 13:29:59

Test Mode	UNII-3_TX AC (VHT40) Mode_Ant. 1
-----------	----------------------------------

Channel	Frequency (MHz)	6 dB Bandwidth (MHz)	6 dB Bandwidth Min. Limit (kHz)	Result
151	5755	36.70	500	Complies
159	5795	36.50	500	Complies

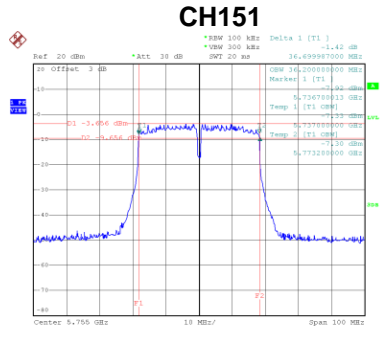

Date: 6.JAN.2020 13:35:19

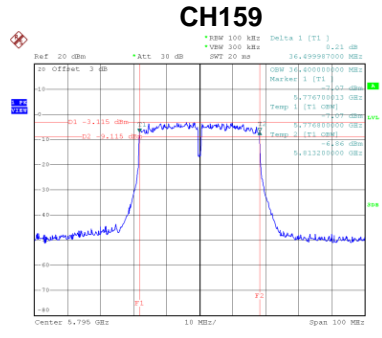

Date: 6.JAN.2020 13:38:14

Channel	Frequency (MHz)	99 % Emission Bandwidth (MHz)	Result
151	5755	36.80	Complies
159	5795	36.80	Complies

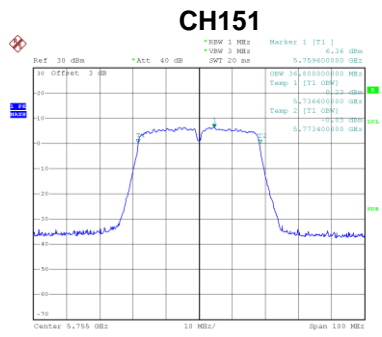

Date: 6.JAN.2020 13:36:28

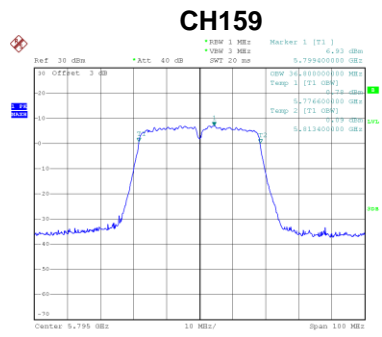

Date: 6.JAN.2020 13:38:29

Test Mode	UNII-3_TX AC (VHT80) _Ant. 1
-----------	------------------------------

Channel	Frequency (MHz)	6 dB Bandwidth (MHz)	6 dB Bandwidth Min. Limit (kHz)	Result
155	5775	76.40	500	Complies

CH155

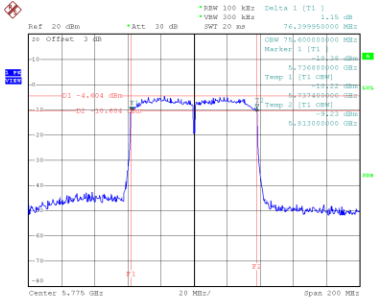

Date: 6.JAN.2020 13:42:28

Channel	Frequency (MHz)	99 % Emission Bandwidth (MHz)	Result
155	5775	75.60	Complies

CH155

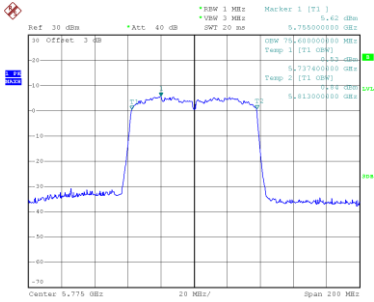

Date: 6.JAN.2020 13:42:51

APPENDIX F - CONDUCTED OUTPUT POWER

Non-Beamforming

Test Mode	UNII-1_TX A Mode
-----------	------------------

Channel	Frequency (MHz)	Conducted Output Power (dBm)	Duty Factor	Conducted Output Power + Duty Factor (dBm)	Max. Limit (dBm)	Max. Limit (W)	Result
36	5180	18.37	0.27	18.64	30.00	1.00	Complies
40	5200	14.98	0.27	15.25	30.00	1.00	Complies
48	5240	14.35	0.27	14.62	30.00	1.00	Complies

Test Mode	UNII-3_TX A Mode
-----------	------------------

Channel	Frequency (MHz)	Conducted Output Power (dBm)	Duty Factor	Conducted Output Power + Duty Factor (dBm)	Max. Limit (dBm)	Max. Limit (W)	Result
149	5745	12.31	0.27	12.58	30.00	1.00	Complies
157	5785	12.41	0.27	12.68	30.00	1.00	Complies
165	5825	12.63	0.27	12.90	30.00	1.00	Complies

Test Mode	UNII-1_TX N (HT20) Mode_Ant. 1
-----------	--------------------------------

Channel	Frequency (MHz)	Conducted Output Power (dBm)	Duty Factor	Conducted Output Power + Duty Factor (dBm)	Max. Limit (dBm)	Max. Limit (W)	Result
36	5180	15.13	0.32	15.45	30.00	1.00	Complies
40	5200	14.11	0.32	14.43	30.00	1.00	Complies
48	5240	14.03	0.32	14.35	30.00	1.00	Complies

Test Mode	UNII-1_TX N (HT20) Mode_Ant. 2
-----------	--------------------------------

Channel	Frequency (MHz)	Conducted Output Power (dBm)	Duty Factor	Conducted Output Power + Duty Factor (dBm)	Max. Limit (dBm)	Max. Limit (W)	Result
36	5180	16.21	0.32	16.53	30.00	1.00	Complies
40	5200	15.02	0.32	15.34	30.00	1.00	Complies
48	5240	14.34	0.32	14.66	30.00	1.00	Complies

Test Mode	UNII-1_TX N (HT20) Mode_Total
-----------	-------------------------------

Channel	Frequency (MHz)	Conducted Output Power (dBm)	Max. Limit (dBm)	Max. Limit (W)	Result
36	5180	19.03	27.99	0.63	Complies
40	5200	17.92	27.99	0.63	Complies
48	5240	17.52	27.99	0.63	Complies

Test Mode	UNII-1_TX N (HT40) Mode_Ant. 1
-----------	--------------------------------

Channel	Frequency (MHz)	Conducted Output Power (dBm)	Duty Factor	Conducted Output Power + Duty Factor (dBm)	Max. Limit (dBm)	Max. Limit (W)	Result
38	5190	15.03	1.01	16.04	30.00	1.00	Complies
46	5230	14.95	1.01	15.96	30.00	1.00	Complies

Test Mode	UNII-1_TX N (HT40) Mode_Ant. 2
-----------	--------------------------------

Channel	Frequency (MHz)	Conducted Output Power (dBm)	Duty Factor	Conducted Output Power + Duty Factor (dBm)	Max. Limit (dBm)	Max. Limit (W)	Result
38	5190	15.77	1.01	16.78	30.00	1.00	Complies
46	5230	15.53	1.01	16.54	30.00	1.00	Complies

Test Mode	UNII-1_TX N (HT40) Mode_Total
-----------	-------------------------------

Channel	Frequency (MHz)	Conducted Output Power (dBm)	Max. Limit (dBm)	Max. Limit (W)	Result
38	5190	19.44	27.99	0.63	Complies
46	5230	19.27	27.99	0.63	Complies

Test Mode	UNII-3_TX N (HT20) Mode_Ant. 1
-----------	--------------------------------

Channel	Frequency (MHz)	Conducted Output Power (dBm)	Duty Factor	Conducted Output Power + Duty Factor (dBm)	Max. Limit (dBm)	Max. Limit (W)	Result
149	5745	11.35	0.32	11.67	30.00	1.00	Complies
157	5785	10.67	0.32	10.99	30.00	1.00	Complies
165	5825	11.23	0.32	11.55	30.00	1.00	Complies

Test Mode	UNII-3_TX N (HT20) Mode_Ant. 2
-----------	--------------------------------

Channel	Frequency (MHz)	Conducted Output Power (dBm)	Duty Factor	Conducted Output Power + Duty Factor (dBm)	Max. Limit (dBm)	Max. Limit (W)	Result
149	5745	11.65	0.32	11.97	30.00	1.00	Complies
157	5785	11.21	0.32	11.53	30.00	1.00	Complies
165	5825	12.17	0.32	12.49	30.00	1.00	Complies

Test Mode	UNII-3_TX N (HT20) Mode_Total
-----------	-------------------------------

Channel	Frequency (MHz)	Conducted Output Power (dBm)	Max. Limit (dBm)	Max. Limit (W)	Result
149	5745	14.83	27.99	0.63	Complies
157	5785	14.28	27.99	0.63	Complies
165	5825	15.05	27.99	0.63	Complies

Test Mode	UNII-3_TX N (HT40) Mode_Ant. 1
-----------	--------------------------------

Channel	Frequency (MHz)	Conducted Output Power (dBm)	Duty Factor	Conducted Output Power + Duty Factor (dBm)	Max. Limit (dBm)	Max. Limit (W)	Result
151	5755	11.12	1.01	12.13	30.00	1.00	Complies
159	5795	11.77	1.01	12.78	30.00	1.00	Complies

Test Mode	UNII-3_TX N (HT40) Mode_Ant. 2
-----------	--------------------------------

Channel	Frequency (MHz)	Conducted Output Power (dBm)	Duty Factor	Conducted Output Power + Duty Factor (dBm)	Max. Limit (dBm)	Max. Limit (W)	Result
151	5755	12.03	1.01	13.04	30.00	1.00	Complies
159	5795	12.49	1.01	13.50	30.00	1.00	Complies

Test Mode	UNII-3_TX N (HT40) Mode_Total
-----------	-------------------------------

Channel	Frequency (MHz)	Conducted Output Power (dBm)	Max. Limit (dBm)	Max. Limit (W)	Result
151	5755	15.62	27.99	0.63	Complies
159	5795	16.16	27.99	0.63	Complies

Test Mode	UNII-1_TX AC (VHT20) Mode_Ant. 1
-----------	----------------------------------

Channel	Frequency (MHz)	Conducted Output Power (dBm)	Duty Factor	Conducted Output Power + Duty Factor (dBm)	Max. Limit (dBm)	Max. Limit (W)	Result
36	5180	15.25	0.50	15.75	30.00	1.00	Complies
40	5200	13.65	0.50	14.15	30.00	1.00	Complies
48	5240	13.84	0.50	14.34	30.00	1.00	Complies

Test Mode	UNII-1_TX AC (VHT20) Mode_Ant. 2
-----------	----------------------------------

Channel	Frequency (MHz)	Conducted Output Power (dBm)	Duty Factor	Conducted Output Power + Duty Factor (dBm)	Max. Limit (dBm)	Max. Limit (W)	Result
36	5180	15.66	0.50	16.16	30.00	1.00	Complies
40	5200	14.47	0.50	14.97	30.00	1.00	Complies
48	5240	14.62	0.50	15.12	30.00	1.00	Complies

Test Mode	UNII-1_TX AC (VHT20) Mode_Total
-----------	---------------------------------

Channel	Frequency (MHz)	Conducted Output Power (dBm)	Max. Limit (dBm)	Max. Limit (W)	Result
36	5180	18.97	27.99	0.63	Complies
40	5200	17.59	27.99	0.63	Complies
48	5240	17.76	27.99	0.63	Complies

Test Mode	UNII-1_TX AC (VHT40) Mode_Ant. 1
-----------	----------------------------------

Channel	Frequency (MHz)	Conducted Output Power (dBm)	Duty Factor	Conducted Output Power + Duty Factor (dBm)	Max. Limit (dBm)	Max. Limit (W)	Result
38	5190	15.21	1.76	16.97	30.00	1.00	Complies
46	5230	15.13	1.76	16.89	30.00	1.00	Complies

Test Mode	UNII-1_TX AC (VHT40) Mode_Ant. 2
-----------	----------------------------------

Channel	Frequency (MHz)	Conducted Output Power (dBm)	Duty Factor	Conducted Output Power + Duty Factor (dBm)	Max. Limit (dBm)	Max. Limit (W)	Result
38	5190	15.92	1.76	17.68	30.00	1.00	Complies
46	5230	15.97	1.76	17.73	30.00	1.00	Complies

Test Mode	UNII-1_TX AC (VHT40) Mode_Total
-----------	---------------------------------

Channel	Frequency (MHz)	Conducted Output Power (dBm)	Max. Limit (dBm)	Max. Limit (W)	Result
38	5190	20.35	27.99	0.63	Complies
46	5230	20.34	27.99	0.63	Complies

Test Mode	UNII-1_TX AC (VHT80) Mode_Ant. 1
-----------	----------------------------------

Channel	Frequency (MHz)	Conducted Output Power (dBm)	Duty Factor	Conducted Output Power + Duty Factor (dBm)	Max. Limit (dBm)	Max. Limit (W)	Result
42	5210	13.55	1.84	15.39	30.00	1.00	Complies

Test Mode	UNII-1_TX AC (VHT80) Mode_Ant. 2
-----------	----------------------------------

Channel	Frequency (MHz)	Conducted Output Power (dBm)	Duty Factor	Conducted Output Power + Duty Factor (dBm)	Max. Limit (dBm)	Max. Limit (W)	Result
42	5210	14.21	1.84	16.05	30.00	1.00	Complies

Test Mode	UNII-1_TX AC (VHT80) Mode_Total
-----------	---------------------------------

Channel	Frequency (MHz)	Conducted Output Power (dBm)	Max. Limit (dBm)	Max. Limit (W)	Result
42	5210	18.74	27.99	0.63	Complies

Test Mode	UNII-3_TX AC (VHT20) Mode_Ant. 1
-----------	----------------------------------

Channel	Frequency (MHz)	Conducted Output Power (dBm)	Duty Factor	Conducted Output Power + Duty Factor (dBm)	Max. Limit (dBm)	Max. Limit (W)	Result
149	5745	10.76	0.50	11.26	30.00	1.00	Complies
157	5785	10.56	0.50	11.06	30.00	1.00	Complies
165	5825	11.14	0.50	11.64	30.00	1.00	Complies

Test Mode	UNII-3_TX AC (VHT20) Mode_Ant. 2
-----------	----------------------------------

Channel	Frequency (MHz)	Conducted Output Power (dBm)	Duty Factor	Conducted Output Power + Duty Factor (dBm)	Max. Limit (dBm)	Max. Limit (W)	Result
149	5745	11.11	0.50	11.61	30.00	1.00	Complies
157	5785	11.51	0.50	12.01	30.00	1.00	Complies
165	5825	11.65	0.50	12.15	30.00	1.00	Complies

Test Mode	UNII-3_TX AC (VHT20) Mode_Total
-----------	---------------------------------

Channel	Frequency (MHz)	Conducted Output Power (dBm)	Max. Limit (dBm)	Max. Limit (W)	Result
149	5745	14.45	27.99	0.63	Complies
157	5785	14.58	27.99	0.63	Complies
165	5825	14.92	27.99	0.63	Complies

Test Mode	UNII-3_TX AC (VHT40) Mode_Ant. 1
-----------	----------------------------------

Channel	Frequency (MHz)	Conducted Output Power (dBm)	Duty Factor	Conducted Output Power + Duty Factor (dBm)	Max. Limit (dBm)	Max. Limit (W)	Result
151	5755	11.38	1.76	13.14	30.00	1.00	Complies
159	5795	11.75	1.76	13.51	30.00	1.00	Complies

Test Mode	UNII-3_TX AC (VHT40) Mode_Ant. 2
-----------	----------------------------------

Channel	Frequency (MHz)	Conducted Output Power (dBm)	Duty Factor	Conducted Output Power + Duty Factor (dBm)	Max. Limit (dBm)	Max. Limit (W)	Result
151	5755	11.78	1.76	13.54	30.00	1.00	Complies
159	5795	12.87	1.76	14.63	30.00	1.00	Complies

Test Mode	UNII-3_TX AC (VHT40) Mode_Total
-----------	---------------------------------

Channel	Frequency (MHz)	Conducted Output Power (dBm)	Max. Limit (dBm)	Max. Limit (W)	Result
151	5755	16.36	27.99	0.63	Complies
159	5795	17.12	27.99	0.63	Complies

Test Mode	UNII-3_TX AC (VHT80) Mode_Ant. 1
-----------	----------------------------------

Channel	Frequency (MHz)	Conducted Output Power (dBm)	Duty Factor	Conducted Output Power + Duty Factor (dBm)	Max. Limit (dBm)	Max. Limit (W)	Result
155	5775	13.02	1.84	14.86	30.00	1.00	Complies

Test Mode	UNII-3_TX AC (VHT80) Mode_Ant. 2
-----------	----------------------------------

Channel	Frequency (MHz)	Conducted Output Power (dBm)	Duty Factor	Conducted Output Power + Duty Factor (dBm)	Max. Limit (dBm)	Max. Limit (W)	Result
155	5775	13.88	1.84	15.72	30.00	1.00	Complies

Test Mode	UNII-3_TX AC (VHT80) Mode_Total
-----------	---------------------------------

Channel	Frequency (MHz)	Conducted Output Power (dBm)	Max. Limit (dBm)	Max. Limit (W)	Result
155	5775	18.32	27.99	0.63	Complies

Beamforming

Test Mode	UNII-1_TX N (HT20) Mode_Ant. 1
-----------	--------------------------------

Channel	Frequency (MHz)	Conducted Output Power (dBm)	Duty Factor	Conducted Output Power + Duty Factor (dBm)	Max. Limit (dBm)	Max. Limit (W)	Result
36	5180	15.03	0.32	15.35	30.00	1.00	Complies
40	5200	13.95	0.32	14.27	30.00	1.00	Complies
48	5240	13.82	0.32	14.14	30.00	1.00	Complies

Test Mode	UNII-1_TX N (HT20) Mode_Ant. 2
-----------	--------------------------------

Channel	Frequency (MHz)	Conducted Output Power (dBm)	Duty Factor	Conducted Output Power + Duty Factor (dBm)	Max. Limit (dBm)	Max. Limit (W)	Result
36	5180	15.97	0.32	16.29	30.00	1.00	Complies
40	5200	14.74	0.32	15.06	30.00	1.00	Complies
48	5240	14.24	0.32	14.56	30.00	1.00	Complies

Test Mode	UNII-1_TX N (HT20) Mode_Total
-----------	-------------------------------

Channel	Frequency (MHz)	Conducted Output Power (dBm)	Max. Limit (dBm)	Max. Limit (W)	Result
36	5180	18.85	28.00	0.63	Complies
40	5200	17.69	28.00	0.63	Complies
48	5240	17.36	28.00	0.63	Complies

Test Mode	UNII-1_TX N (HT40) Mode_Ant. 1
-----------	--------------------------------

Channel	Frequency (MHz)	Conducted Output Power (dBm)	Duty Factor	Conducted Output Power + Duty Factor (dBm)	Max. Limit (dBm)	Max. Limit (W)	Result
38	5190	14.87	1.01	15.88	30.00	1.00	Complies
46	5230	14.79	1.01	15.80	30.00	1.00	Complies

Test Mode	UNII-1_TX N (HT40) Mode_Ant. 2
-----------	--------------------------------

Channel	Frequency (MHz)	Conducted Output Power (dBm)	Duty Factor	Conducted Output Power + Duty Factor (dBm)	Max. Limit (dBm)	Max. Limit (W)	Result
38	5190	15.65	1.01	16.66	30.00	1.00	Complies
46	5230	15.23	1.01	16.24	30.00	1.00	Complies

Test Mode	UNII-1_TX N (HT40) Mode_Total
-----------	-------------------------------

Channel	Frequency (MHz)	Conducted Output Power (dBm)	Max. Limit (dBm)	Max. Limit (W)	Result
38	5190	19.30	28.00	0.63	Complies
46	5230	19.03	28.00	0.63	Complies

Test Mode	UNII-3_TX N (HT20) Mode_Ant. 1
-----------	--------------------------------

Channel	Frequency (MHz)	Conducted Output Power (dBm)	Duty Factor	Conducted Output Power + Duty Factor (dBm)	Max. Limit (dBm)	Max. Limit (W)	Result
149	5745	11.17	0.32	11.49	30.00	1.00	Complies
157	5785	10.43	0.32	10.75	30.00	1.00	Complies
165	5825	11.17	0.32	11.49	30.00	1.00	Complies

Test Mode	UNII-3_TX N (HT20) Mode_Ant. 2
-----------	--------------------------------

Channel	Frequency (MHz)	Conducted Output Power (dBm)	Duty Factor	Conducted Output Power + Duty Factor (dBm)	Max. Limit (dBm)	Max. Limit (W)	Result
149	5745	11.32	0.32	11.64	30.00	1.00	Complies
157	5785	11.22	0.32	11.54	30.00	1.00	Complies
165	5825	12.03	0.32	12.35	30.00	1.00	Complies

Test Mode	UNII-3_TX N (HT20) Mode_Total
-----------	-------------------------------

Channel	Frequency (MHz)	Conducted Output Power (dBm)	Max. Limit (dBm)	Max. Limit (W)	Result
149	5745	14.57	28.00	0.63	Complies
157	5785	14.17	28.00	0.63	Complies
165	5825	14.95	28.00	0.63	Complies

Test Mode	UNII-3_TX N (HT40) Mode_Ant. 1
-----------	--------------------------------

Channel	Frequency (MHz)	Conducted Output Power (dBm)	Duty Factor	Conducted Output Power + Duty Factor (dBm)	Max. Limit (dBm)	Max. Limit (W)	Result
151	5755	11.02	1.01	12.03	30.00	1.00	Complies
159	5795	11.72	1.01	12.73	30.00	1.00	Complies

Test Mode	UNII-3_TX N (HT40) Mode_Ant. 2
-----------	--------------------------------

Channel	Frequency (MHz)	Conducted Output Power (dBm)	Duty Factor	Conducted Output Power + Duty Factor (dBm)	Max. Limit (dBm)	Max. Limit (W)	Result
151	5755	11.84	1.01	12.85	30.00	1.00	Complies
159	5795	12.34	1.01	13.35	30.00	1.00	Complies

Test Mode	UNII-3_TX N (HT40) Mode_Total
-----------	-------------------------------

Channel	Frequency (MHz)	Conducted Output Power (dBm)	Max. Limit (dBm)	Max. Limit (W)	Result
151	5755	15.47	28.00	0.63	Complies
159	5795	16.06	28.00	0.63	Complies

Test Mode	UNII-1_TX AC (VHT20) Mode_Ant. 1
-----------	----------------------------------

Channel	Frequency (MHz)	Conducted Output Power (dBm)	Duty Factor	Conducted Output Power + Duty Factor (dBm)	Max. Limit (dBm)	Max. Limit (W)	Result
36	5180	15.14	0.50	15.64	30.00	1.00	Complies
40	5200	13.37	0.50	13.87	30.00	1.00	Complies
48	5240	13.74	0.50	14.24	30.00	1.00	Complies

Test Mode	UNII-1_TX AC (VHT20) Mode_Ant. 2
-----------	----------------------------------

Channel	Frequency (MHz)	Conducted Output Power (dBm)	Duty Factor	Conducted Output Power + Duty Factor (dBm)	Max. Limit (dBm)	Max. Limit (W)	Result
36	5180	15.52	0.50	16.02	30.00	1.00	Complies
40	5200	14.25	0.50	14.75	30.00	1.00	Complies
48	5240	14.51	0.50	15.01	30.00	1.00	Complies

Test Mode	UNII-1_TX AC (VHT20) Mode_Total
-----------	---------------------------------

Channel	Frequency (MHz)	Conducted Output Power (dBm)	Max. Limit (dBm)	Max. Limit (W)	Result
36	5180	18.85	28.00	0.63	Complies
40	5200	17.35	28.00	0.63	Complies
48	5240	17.66	28.00	0.63	Complies

Test Mode	UNII-1_TX AC (VHT40) Mode_Ant. 1
-----------	----------------------------------

Channel	Frequency (MHz)	Conducted Output Power (dBm)	Duty Factor	Conducted Output Power + Duty Factor (dBm)	Max. Limit (dBm)	Max. Limit (W)	Result
38	5190	15.15	1.76	16.91	30.00	1.00	Complies
46	5230	14.98	1.76	16.74	30.00	1.00	Complies

Test Mode	UNII-1_TX AC (VHT40) Mode_Ant. 2
-----------	----------------------------------

Channel	Frequency (MHz)	Conducted Output Power (dBm)	Duty Factor	Conducted Output Power + Duty Factor (dBm)	Max. Limit (dBm)	Max. Limit (W)	Result
38	5190	15.79	1.76	17.55	30.00	1.00	Complies
46	5230	15.85	1.76	17.61	30.00	1.00	Complies

Test Mode	UNII-1_TX AC (VHT40) Mode_Total
-----------	---------------------------------

Channel	Frequency (MHz)	Conducted Output Power (dBm)	Max. Limit (dBm)	Max. Limit (W)	Result
38	5190	20.25	28.00	0.63	Complies
46	5230	20.21	28.00	0.63	Complies

Test Mode	UNII-1_TX AC (VHT80) Mode_Ant. 1
-----------	----------------------------------

Channel	Frequency (MHz)	Conducted Output Power (dBm)	Duty Factor	Conducted Output Power + Duty Factor (dBm)	Max. Limit (dBm)	Max. Limit (W)	Result
42	5210	13.34	1.84	15.18	30.00	1.00	Complies

Test Mode	UNII-1_TX AC (VHT80) Mode_Ant. 2
-----------	----------------------------------

Channel	Frequency (MHz)	Conducted Output Power (dBm)	Duty Factor	Conducted Output Power + Duty Factor (dBm)	Max. Limit (dBm)	Max. Limit (W)	Result
42	5210	14.11	1.84	15.95	30.00	1.00	Complies

Test Mode	UNII-1_TX AC (VHT80) Mode_Total
-----------	---------------------------------

Channel	Frequency (MHz)	Conducted Output Power (dBm)	Max. Limit (dBm)	Max. Limit (W)	Result
42	5210	18.59	28.00	0.63	Complies

Test Mode	UNII-3_TX AC (VHT20) Mode_Ant. 1
-----------	----------------------------------

Channel	Frequency (MHz)	Conducted Output Power (dBm)	Duty Factor	Conducted Output Power + Duty Factor (dBm)	Max. Limit (dBm)	Max. Limit (W)	Result
149	5745	10.66	0.50	11.16	30.00	1.00	Complies
157	5785	10.39	0.50	10.89	30.00	1.00	Complies
165	5825	11.11	0.50	11.61	30.00	1.00	Complies

Test Mode	UNII-3_TX AC (VHT20) Mode_Ant. 2
-----------	----------------------------------

Channel	Frequency (MHz)	Conducted Output Power (dBm)	Duty Factor	Conducted Output Power + Duty Factor (dBm)	Max. Limit (dBm)	Max. Limit (W)	Result
149	5745	11.03	0.50	11.53	30.00	1.00	Complies
157	5785	11.42	0.50	11.92	30.00	1.00	Complies
165	5825	11.47	0.50	11.97	30.00	1.00	Complies

Test Mode	UNII-3_TX AC (VHT20) Mode_Total
-----------	---------------------------------

Channel	Frequency (MHz)	Conducted Output Power (dBm)	Max. Limit (dBm)	Max. Limit (W)	Result
149	5745	14.36	28.00	0.63	Complies
157	5785	14.45	28.00	0.63	Complies
165	5825	14.81	28.00	0.63	Complies

Test Mode	UNII-3_TX AC (VHT40) Mode_Ant. 1
-----------	----------------------------------

Channel	Frequency (MHz)	Conducted Output Power (dBm)	Duty Factor	Conducted Output Power + Duty Factor (dBm)	Max. Limit (dBm)	Max. Limit (W)	Result
151	5755	11.29	1.76	13.05	30.00	1.00	Complies
159	5795	11.76	1.76	13.52	30.00	1.00	Complies

Test Mode	UNII-3_TX AC (VHT40) Mode_Ant. 2
-----------	----------------------------------

Channel	Frequency (MHz)	Conducted Output Power (dBm)	Duty Factor	Conducted Output Power + Duty Factor (dBm)	Max. Limit (dBm)	Max. Limit (W)	Result
151	5755	11.67	1.76	13.43	30.00	1.00	Complies
159	5795	12.74	1.76	14.50	30.00	1.00	Complies

Test Mode	UNII-3_TX AC (VHT40) Mode_Total
-----------	---------------------------------

Channel	Frequency (MHz)	Conducted Output Power (dBm)	Max. Limit (dBm)	Max. Limit (W)	Result
151	5755	16.26	28.00	0.63	Complies
159	5795	17.05	28.00	0.63	Complies

Test Mode	UNII-3_TX AC (VHT80) Mode_Ant. 1
-----------	----------------------------------

Channel	Frequency (MHz)	Conducted Output Power (dBm)	Duty Factor	Conducted Output Power + Duty Factor (dBm)	Max. Limit (dBm)	Max. Limit (W)	Result
155	5775	12.77	1.84	14.61	30.00	1.00	Complies

Test Mode	UNII-3_TX AC (VHT80) Mode_Ant. 2
-----------	----------------------------------

Channel	Frequency (MHz)	Conducted Output Power (dBm)	Duty Factor	Conducted Output Power + Duty Factor (dBm)	Max. Limit (dBm)	Max. Limit (W)	Result
155	5775	13.53	1.84	15.37	30.00	1.00	Complies

Test Mode	UNII-3_TX AC (VHT80) Mode_Total
-----------	---------------------------------

Channel	Frequency (MHz)	Conducted Output Power (dBm)	Max. Limit (dBm)	Max. Limit (W)	Result
155	5775	18.01	28.00	0.63	Complies

APPENDIX G - POWER SPECTRAL DENSITY

Non-Beamforming

Test Mode	UNII-1_TX A Mode
-----------	------------------

Channel	Frequency (MHz)	Power Spectral Density (dBm/MHz)	Duty Factor	Power Spectral Density + Duty Factor (dBm/MHz)	Max. Limit (dBm/MHz)	Result
36	5180	7.43	0.27	7.70	17.00	Complies
40	5200	3.87	0.27	4.14	17.00	Complies
48	5240	3.39	0.27	3.66	17.00	Complies

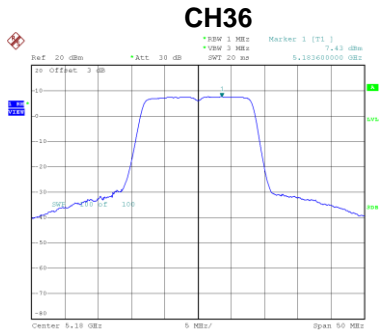

Date: 6.JAN.2020 12:42:05

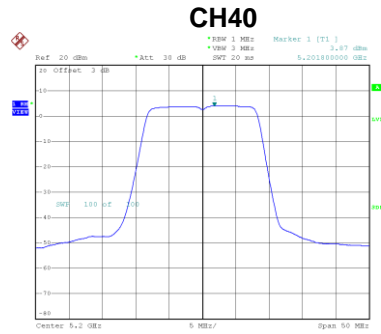

Date: 6.JAN.2020 12:46:25

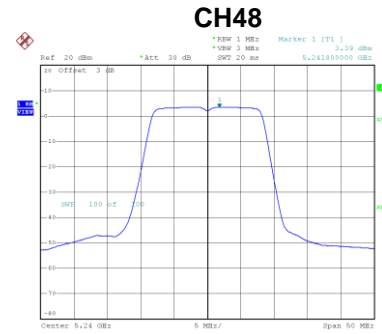

Date: 6.JAN.2020 12:47:54

Test Mode	UNII-1_TX AC (VHT20) Mode_Ant. 1
-----------	----------------------------------

Channel	Frequency (MHz)	Power Spectral Density (dBm/MHz)	Duty Factor	Power Spectral Density + Duty Factor (dBm/MHz)	Max. Limit (dBm/MHz)	Result
36	5180	3.15	0.50	3.65	17.00	Complies
40	5200	1.57	0.50	2.07	17.00	Complies
48	5240	2.18	0.50	2.68	17.00	Complies

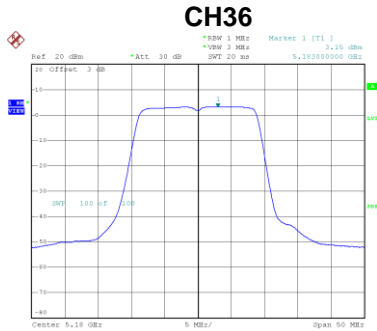

Date: 6.JAN.2020 13:20:21

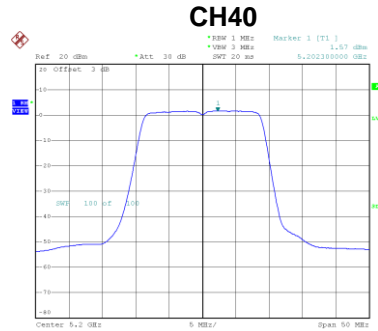

Date: 6.JAN.2020 13:21:28

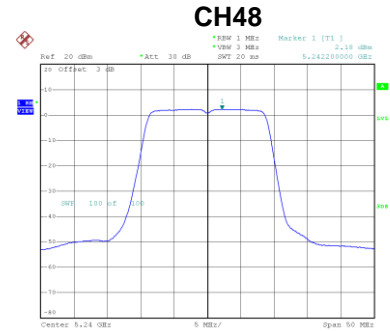

Date: 6.JAN.2020 13:22:33

Test Mode	UNII-1_TX AC (VHT20) Mode_Ant. 2
-----------	----------------------------------

Channel	Frequency (MHz)	Power Spectral Density (dBm/MHz)	Duty Factor	Power Spectral Density + Duty Factor (dBm/MHz)	Max. Limit (dBm/MHz)	Result
36	5180	3.62	0.50	4.12	17.00	Complies
40	5200	2.46	0.50	2.96	17.00	Complies
48	5240	3.30	0.50	3.80	17.00	Complies

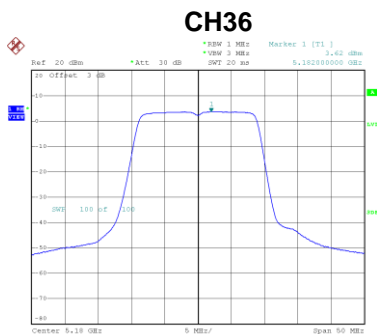

Date: 6.JAN.2020 13:49:51

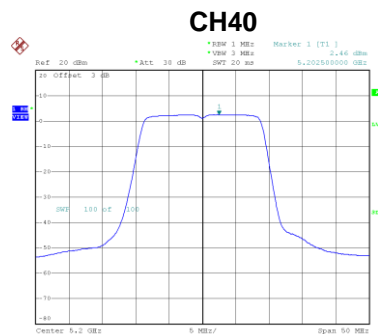

Date: 6.JAN.2020 13:50:23

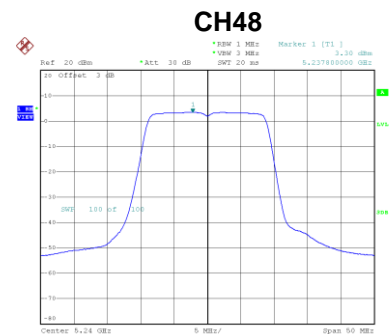

Date: 6.JAN.2020 13:50:56

Test Mode	UNII-1_TX AC (VHT20) Mode_Total
-----------	---------------------------------

Channel	Frequency (MHz)	Power Spectral Density (dBm/MHz)	Max. Limit (dBm/MHz)	Result
36	5180	6.91	14.99	Complies
40	5200	5.55	14.99	Complies
48	5240	6.29	14.99	Complies

Test Mode	UNII-1_TX AC (VHT40) Mode_Ant. 1
-----------	----------------------------------

Channel	Frequency (MHz)	Power Spectral Density (dBm/MHz)	Duty Factor	Power Spectral Density + Duty Factor (dBm/MHz)	Max. Limit (dBm/MHz)	Result
38	5190	0.87	1.76	2.63	17.00	Complies
46	5230	0.93	1.76	2.69	17.00	Complies

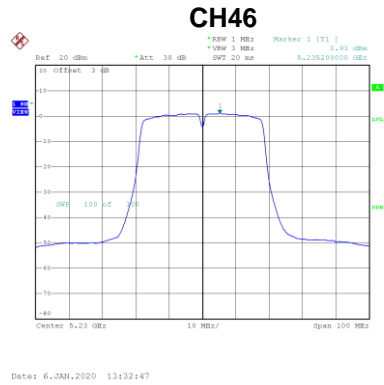
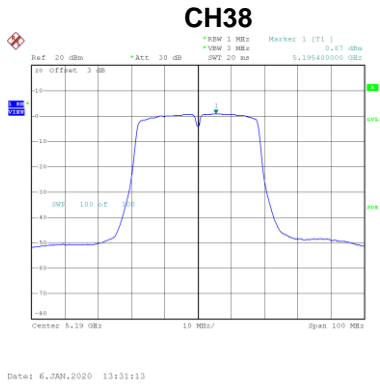

Test Mode	UNII-1_TX AC (VHT40) Mode_Ant. 2
-----------	----------------------------------

Channel	Frequency (MHz)	Power Spectral Density (dBm/MHz)	Duty Factor	Power Spectral Density + Duty Factor (dBm/MHz)	Max. Limit (dBm/MHz)	Result
38	5190	1.62	1.76	3.38	17.00	Complies
46	5230	1.97	1.76	3.73	17.00	Complies

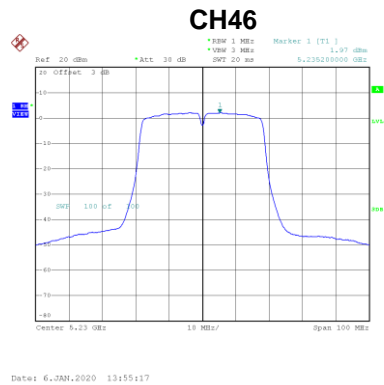
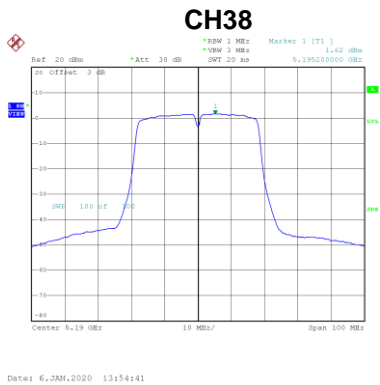

Test Mode	UNII-1_TX AC (VHT40) Mode_Total
-----------	---------------------------------

Channel	Frequency (MHz)	Power Spectral Density (dBm/MHz)	Max. Limit (dBm/MHz)	Result
38	5190	6.03	14.99	Complies
46	5230	6.25	14.99	Complies

Test Mode	UNII-1_TX AC (VHT80) Mode_Ant. 1
-----------	----------------------------------

Channel	Frequency (MHz)	Power Spectral Density (dBm/MHz)	Duty Factor	Power Spectral Density + Duty Factor (dBm/MHz)	Max. Limit (dBm/MHz)	Result
42	5210	-3.08	1.84	-1.24	17.00	Complies

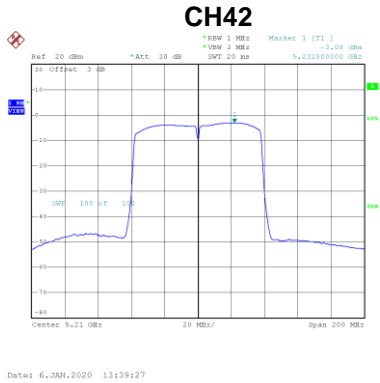

Test Mode	UNII-1_TX AC (VHT80) Mode_Ant. 2
-----------	----------------------------------

Channel	Frequency (MHz)	Power Spectral Density (dBm/MHz)	Duty Factor	Power Spectral Density + Duty Factor (dBm/MHz)	Max. Limit (dBm/MHz)	Result
42	5210	-2.53	1.84	-0.69	17.00	Complies

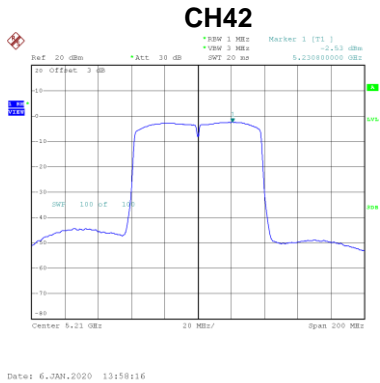

Test Mode	UNII-1_TX AC (VHT80) Mode_Total
-----------	---------------------------------

Channel	Frequency (MHz)	Power Spectral Density (dBm/MHz)	Max. Limit (dBm/MHz)	Result
42	5210	2.05	14.99	Complies

Test Mode UNII-3_TX A Mode

Channel	Frequency (MHz)	Power Spectral Density (dBm/500 kHz)	Duty Factor	Power Spectral Density + Duty Factor (dBm/500 kHz)	Max. Limit (dBm/500 kHz)	Result
149	5745	-1.14	0.27	-0.87	30.00	Complies
157	5785	-1.32	0.27	-1.05	30.00	Complies
165	5825	-1.39	0.27	-1.12	30.00	Complies

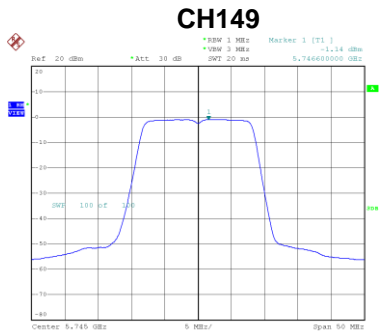

Date: 6.JAN.2020 12:50:10

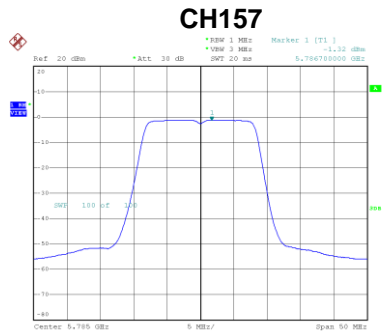

Date: 6.JAN.2020 12:56:09

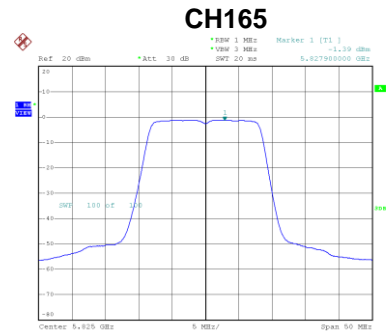

Date: 6.JAN.2020 13:00:22

Test Mode UNII-3_TX AC (VHT20) Mode_Ant. 1

Channel	Frequency (MHz)	Power Spectral Density (dBm/500 kHz)	Duty Factor	Power Spectral Density + Duty Factor (dBm/500 kHz)	Max. Limit (dBm/500 kHz)	Result
149	5745	-4.04	0.50	-3.54	30.00	Complies
157	5785	-3.97	0.50	-3.47	30.00	Complies
165	5825	-4.06	0.50	-3.56	30.00	Complies

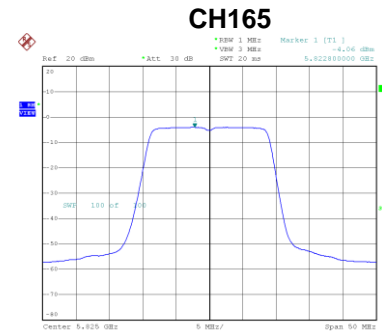
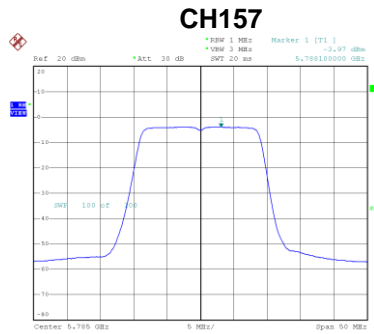
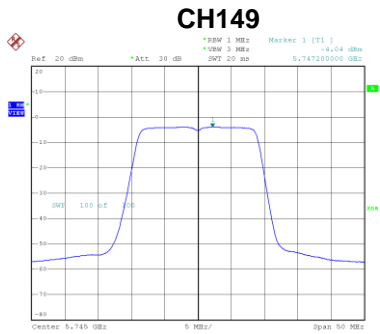

Date: 6.JAN.2020 13:24:09

Date: 6.JAN.2020 13:26:46

Date: 6.JAN.2020 13:28:49

Test Mode UNII-3_TX AC (VHT20) Mode_Ant. 2

Channel	Frequency (MHz)	Power Spectral Density (dBm/500 kHz)	Duty Factor	Power Spectral Density + Duty Factor (dBm/500 kHz)	Max. Limit (dBm/500 kHz)	Result
149	5745	-3.15	0.50	-2.65	30.00	Complies
157	5785	-3.68	0.50	-3.18	30.00	Complies
165	5825	-2.43	0.50	-1.93	30.00	Complies

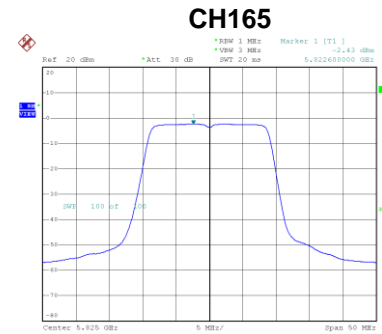
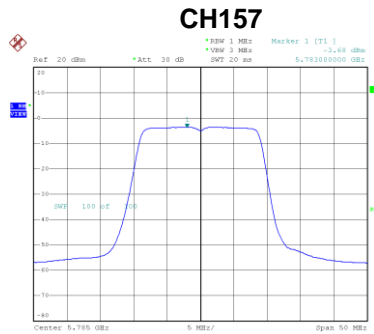
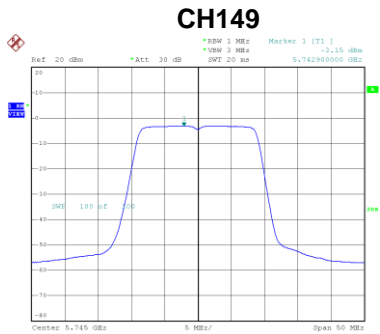

Date: 6.JAN.2020 13:51:37

Date: 6.JAN.2020 13:52:23

Date: 6.JAN.2020 13:53:44

Test Mode	UNII-3_TX AC (VHT20) Mode_Total
-----------	---------------------------------

Channel	Frequency (MHz)	Power Spectral Density (dBm/500 kHz)	Max. Limit (dBm/500 kHz)	Result
149	5745	-0.06	27.99	Complies
157	5785	-0.31	27.99	Complies
165	5825	0.35	27.99	Complies

Test Mode	UNII-3_TX AC (VHT40) Mode_Ant. 1
-----------	----------------------------------

Channel	Frequency (MHz)	Power Spectral Density (dBm/500 kHz)	Duty Factor	Power Spectral Density + Duty Factor (dBm/500 kHz)	Max. Limit (dBm/500 kHz)	Result
151	5755	-5.40	1.76	-3.64	30.00	Complies
159	5795	-4.77	1.76	-3.01	30.00	Complies

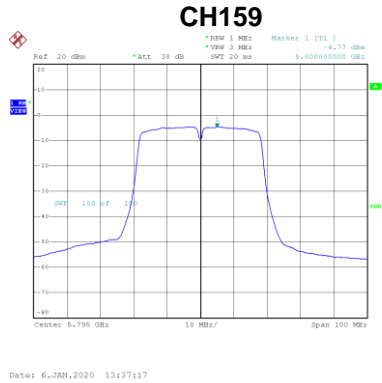
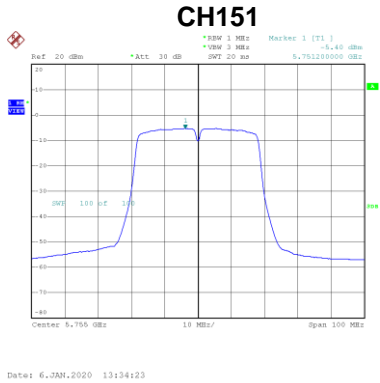

Test Mode	UNII-3_TX AC (VHT40) Mode_Ant. 2
-----------	----------------------------------

Channel	Frequency (MHz)	Power Spectral Density (dBm/500 kHz)	Duty Factor	Power Spectral Density + Duty Factor (dBm/500 kHz)	Max. Limit (dBm/500 kHz)	Result
151	5755	-4.68	1.76	-2.92	30.00	Complies
159	5795	-4.17	1.76	-2.41	30.00	Complies

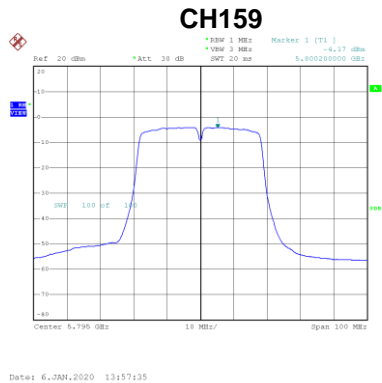
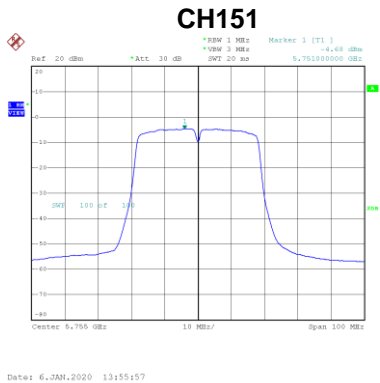

Test Mode	UNII-3_TX AC (VHT40) Mode_Total
-----------	---------------------------------

Channel	Frequency (MHz)	Power Spectral Density (dBm/500 kHz)	Max. Limit (dBm/500 kHz)	Result
151	5755	-0.25	27.99	Complies
159	5795	0.31	27.99	Complies

Test Mode	UNII-3_TX AC (VHT80) Mode_Ant. 1
-----------	----------------------------------

Channel	Frequency (MHz)	Power Spectral Density (dBm/500 kHz)	Duty Factor	Power Spectral Density + Duty Factor (dBm/500 kHz)	Max. Limit (dBm/500 kHz)	Result
155	5775	-5.95	1.84	-4.11	30.00	Complies

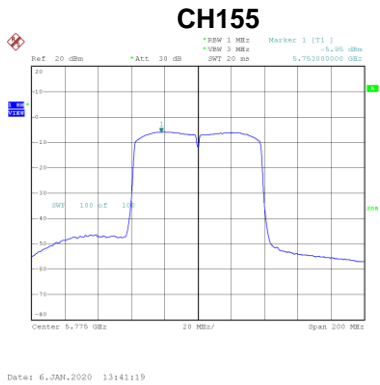

Test Mode	UNII-3_TX AC (VHT80) Mode_Ant. 2
-----------	----------------------------------

Channel	Frequency (MHz)	Power Spectral Density (dBm/500 kHz)	Duty Factor	Power Spectral Density + Duty Factor (dBm/500 kHz)	Max. Limit (dBm/500 kHz)	Result
155	5775	-5.51	1.84	-3.67	30.00	Complies

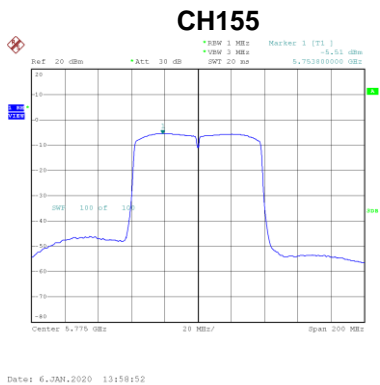

Test Mode	UNII-3_TX AC (VHT80) Mode_Total
-----------	---------------------------------

Channel	Frequency (MHz)	Power Spectral Density (dBm/500 kHz)	Max. Limit (dBm/500 kHz)	Result
155	5775	-0.88	27.99	Complies

Beamforming

Test Mode UNII-1_TX AC (VHT20) Mode_Ant. 1

Channel	Frequency (MHz)	Power Spectral Density (dBm/MHz)	Duty Factor	Power Spectral Density + Duty Factor (dBm/MHz)	Max. Limit (dBm/MHz)	Result
36	5180	3.15	0.50	3.55	17.00	Complies
40	5200	1.57	0.50	2.07	17.00	Complies
48	5240	2.18	0.50	2.68	17.00	Complies

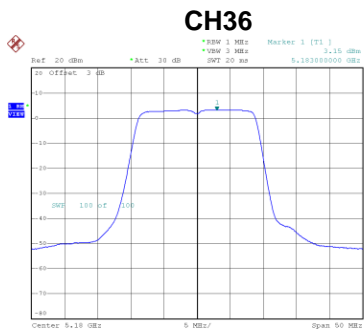

Date: 6.JAN.2020 13:20:21

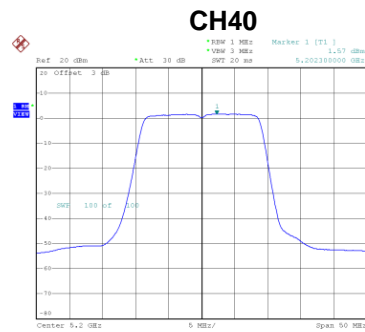

Date: 6.JAN.2020 13:21:28

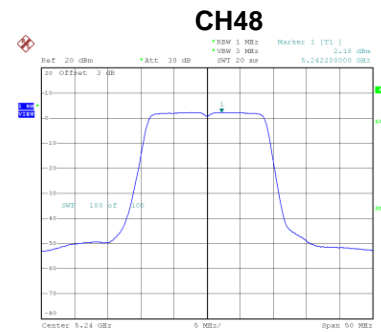

Date: 6.JAN.2020 13:22:33

Test Mode UNII-1_TX AC (VHT20) Mode_Ant. 2

Channel	Frequency (MHz)	Power Spectral Density (dBm/MHz)	Duty Factor	Power Spectral Density + Duty Factor (dBm/MHz)	Max. Limit (dBm/MHz)	Result
36	5180	3.62	0.50	4.12	17.00	Complies
40	5200	2.46	0.50	2.96	17.00	Complies
48	5240	3.30	0.50	3.80	17.00	Complies

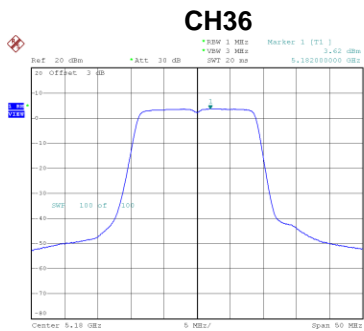

Date: 6.JAN.2020 13:49:51

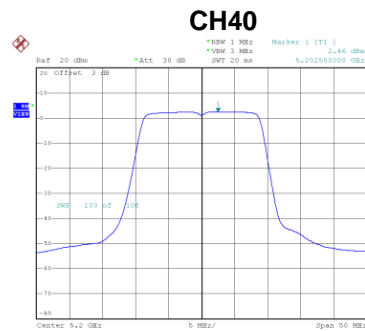

Date: 6.JAN.2020 13:50:23

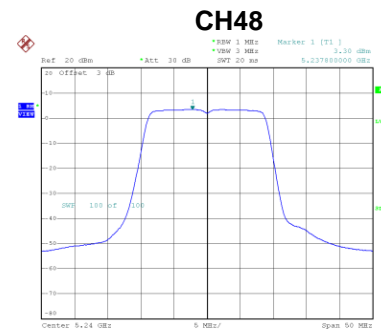

Date: 6.JAN.2020 13:50:56

Test Mode	UNII-1_TX AC (VHT20) Mode_Total
-----------	---------------------------------

Channel	Frequency (MHz)	Power Spectral Density (dBm/MHz)	Max. Limit (dBm/MHz)	Result
36	5180	-96.49	15.00	Complies
40	5200	-96.49	15.00	Complies
48	5240	-96.49	15.00	Complies

Test Mode	UNII-1_TX AC (VHT40) Mode_Ant. 1
-----------	----------------------------------

Channel	Frequency (MHz)	Power Spectral Density (dBm/MHz)	Duty Factor	Power Spectral Density + Duty Factor (dBm/MHz)	Max. Limit (dBm/MHz)	Result
38	5190	0.87	1.76	2.63	17.00	Complies
46	5230	0.93	1.76	2.69	17.00	Complies

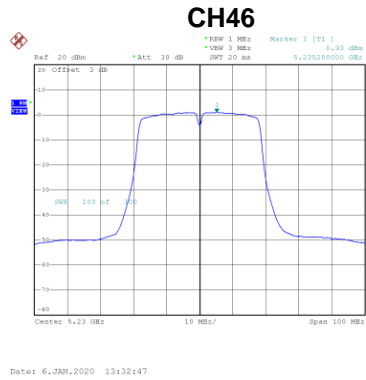
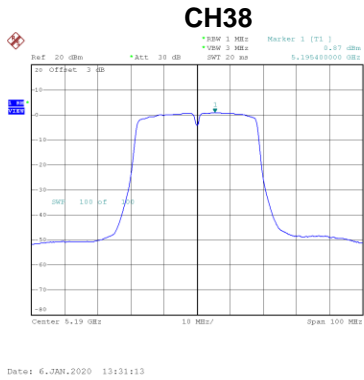

Test Mode	UNII-1_TX AC (VHT40) Mode_Ant. 2
-----------	----------------------------------

Channel	Frequency (MHz)	Power Spectral Density (dBm/MHz)	Duty Factor	Power Spectral Density + Duty Factor (dBm/MHz)	Max. Limit (dBm/MHz)	Result
38	5190	1.62	1.76	3.38	17.00	Complies
46	5230	1.97	1.76	3.73	17.00	Complies

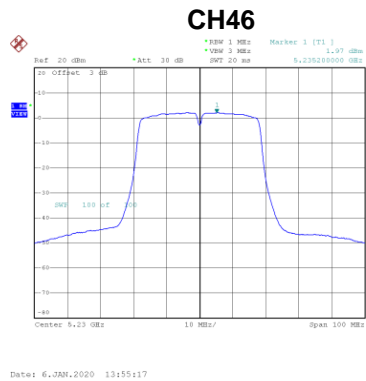
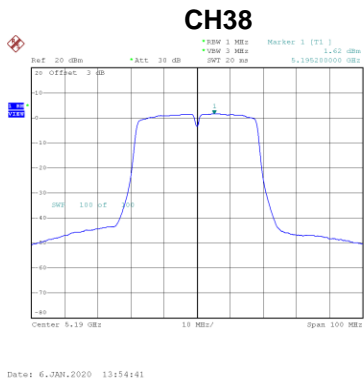

Test Mode	UNII-1_TX AC (VHT40) Mode_Total
-----------	---------------------------------

Channel	Frequency (MHz)	Power Spectral Density (dBm/MHz)	Max. Limit (dBm/MHz)	Result
38	5190	-95.23	17.00	Complies
46	5230	-95.23	17.00	Complies

Test Mode	UNII-1_TX AC (VHT80) Mode_Ant. 1
-----------	----------------------------------

Channel	Frequency (MHz)	Power Spectral Density (dBm/MHz)	Duty Factor	Power Spectral Density + Duty Factor (dBm/MHz)	Max. Limit (dBm/MHz)	Result
42	5210	-3.08	1.84	-1.24	17.00	Complies

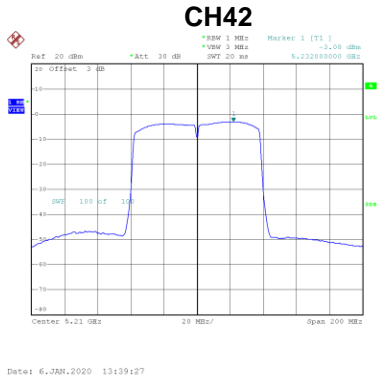

Test Mode	UNII-1_TX AC (VHT80) Mode_Ant. 2
-----------	----------------------------------

Channel	Frequency (MHz)	Power Spectral Density (dBm/MHz)	Duty Factor	Power Spectral Density + Duty Factor (dBm/MHz)	Max. Limit (dBm/MHz)	Result
42	5210	-2.53	1.84	-0.69	17.00	Complies

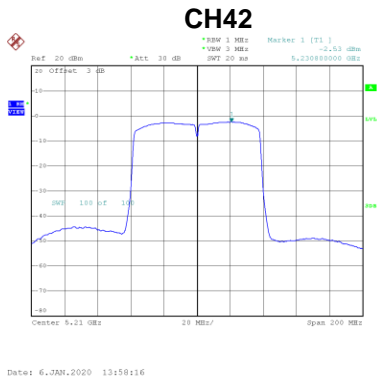

Test Mode	UNII-1_TX AC (VHT80) Mode_Total
-----------	---------------------------------

Channel	Frequency (MHz)	Power Spectral Density (dBm/MHz)	Max. Limit (dBm/MHz)	Result
42	5210	-95.15	15.00	Complies

Test Mode UNII-3_TX AC (VHT20) Mode_Ant. 1

Channel	Frequency (MHz)	Power Spectral Density (dBm/500 kHz)	Duty Factor	Power Spectral Density + Duty Factor (dBm/500 kHz)	Max. Limit (dBm/500 kHz)	Result
149	5745	-4.04	0.50	-3.54	30.00	Complies
157	5785	-3.97	0.50	-3.47	30.00	Complies
165	5825	-4.06	0.50	-3.56	30.00	Complies

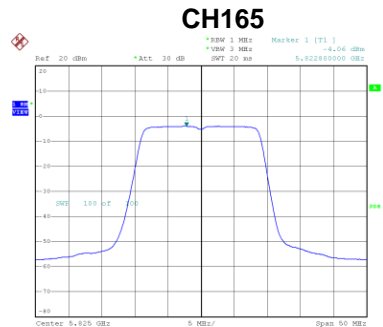
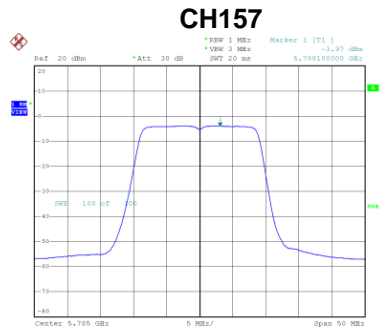
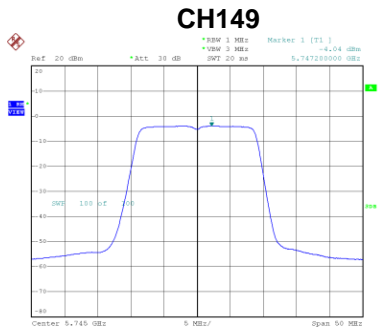

Date: 6.JAN.2020 13:24:09

Date: 6.JAN.2020 13:26:46

Date: 6.JAN.2020 13:28:49

Test Mode UNII-3_TX AC (VHT20) Mode_Ant. 2

Channel	Frequency (MHz)	Power Spectral Density (dBm/500 kHz)	Duty Factor	Power Spectral Density + Duty Factor (dBm/500 kHz)	Max. Limit (dBm/500 kHz)	Result
149	5745	-3.15	0.50	-2.65	30.00	Complies
157	5785	-3.68	0.50	-3.18	30.00	Complies
165	5825	-2.43	0.50	-1.93	30.00	Complies

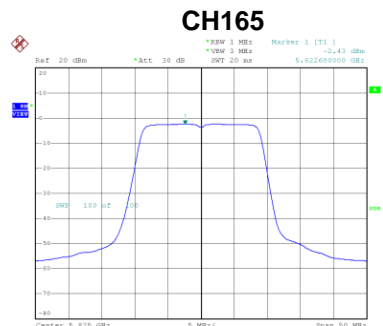
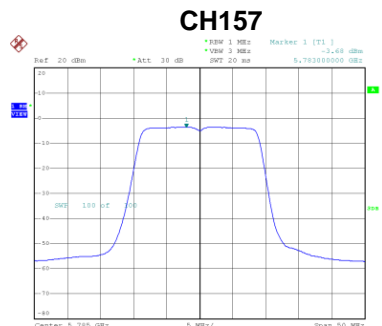
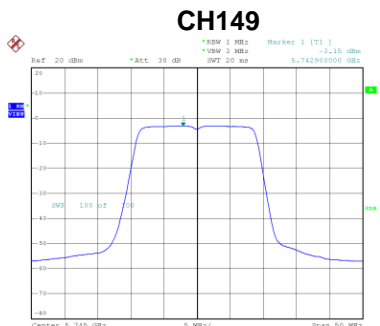

Date: 6.JAN.2020 13:51:37

Date: 6.JAN.2020 13:52:23

Date: 6.JAN.2020 13:53:44

Test Mode	UNII-3_TX AC (VHT20) Mode_Total
-----------	---------------------------------

Channel	Frequency (MHz)	Power Spectral Density (dBm/500 kHz)	Max. Limit (dBm/500 kHz)	Result
149	5745	-96.49	28.00	Complies
157	5785	-96.49	28.00	Complies
165	5825	-96.49	28.00	Complies

Test Mode	UNII-3_TX AC (VHT40) Mode_Ant. 1
-----------	----------------------------------

Channel	Frequency (MHz)	Power Spectral Density (dBm/500 kHz)	Duty Factor	Power Spectral Density + Duty Factor (dBm/500 kHz)	Max. Limit (dBm/500 kHz)	Result
151	5755	-5.40	1.76	-3.64	30.00	Complies
159	5795	-4.77	1.76	-3.01	30.00	Complies

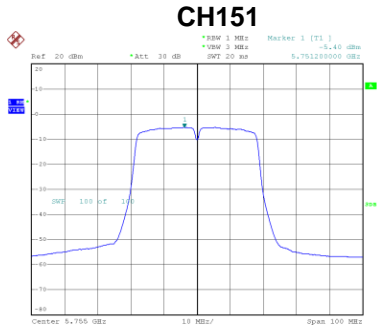

Date: 6.JAN.2020 13:34:23

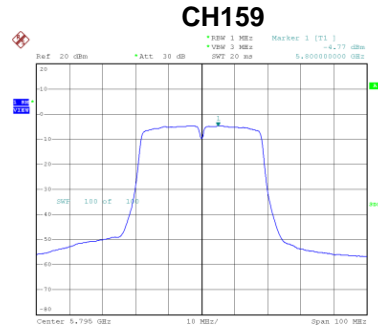

Date: 6.JAN.2020 13:37:17

Test Mode	UNII-3_TX AC (VHT40) Mode_Ant. 2
-----------	----------------------------------

Channel	Frequency (MHz)	Power Spectral Density (dBm/500 kHz)	Duty Factor	Power Spectral Density + Duty Factor (dBm/500 kHz)	Max. Limit (dBm/500 kHz)	Result
151	5755	-4.68	1.76	-2.92	30.00	Complies
159	5795	-4.17	1.76	-2.41	30.00	Complies

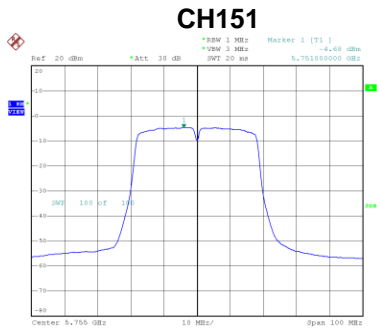

Date: 6.JAN.2020 13:55:57

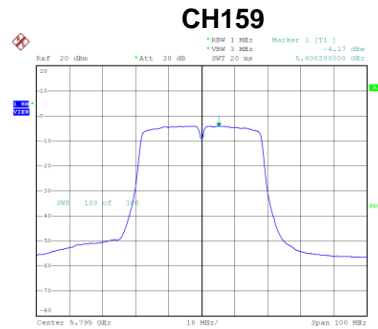

Date: 6.JAN.2020 13:57:35

Test Mode	UNII-3_TX AC (VHT40) Mode_Total
-----------	---------------------------------

Channel	Frequency (MHz)	Power Spectral Density (dBm/500 kHz)	Max. Limit (dBm/500 kHz)	Result
151	5755	-95.23	28.00	Complies
159	5795	-95.23	28.00	Complies

Test Mode	UNII-3_TX AC (VHT80) Mode_Ant. 1
-----------	----------------------------------

Channel	Frequency (MHz)	Power Spectral Density (dBm/500 kHz)	Duty Factor	Power Spectral Density + Duty Factor (dBm/500 kHz)	Max. Limit (dBm/500 kHz)	Result
155	5775	-5.95	1.84	-4.11	30.00	Complies

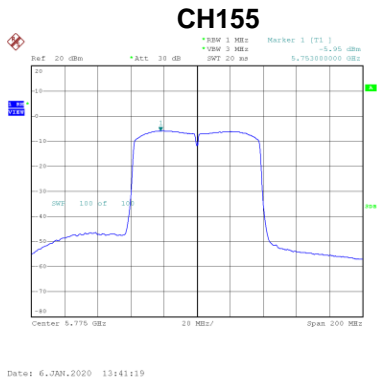

Test Mode	UNII-3_TX AC (VHT80) Mode_Ant. 2
-----------	----------------------------------

Channel	Frequency (MHz)	Power Spectral Density (dBm/500 kHz)	Duty Factor	Power Spectral Density + Duty Factor (dBm/500 kHz)	Max. Limit (dBm/500 kHz)	Result
155	5775	-5.51	1.84	-3.67	30.00	Complies

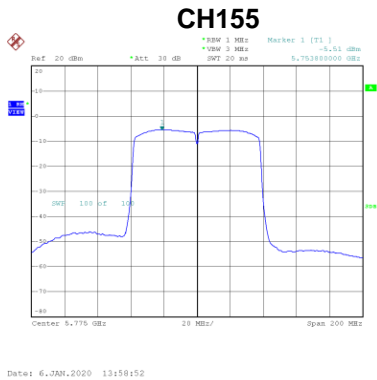

Test Mode	UNII-3_TX AC (VHT80) Mode_Total
-----------	---------------------------------

Channel	Frequency (MHz)	Power Spectral Density (dBm/500 kHz)	Max. Limit (dBm/500 kHz)	Result
155	5775	-95.15	28.00	Complies

APPENDIX H - FREQUENCY STABILITY

Test Mode	UNII-1
-----------	--------

Voltage vs. Frequency Stability

Voltage	Measurement Frequency (MHz)
(V)	5180.0000
138	5179.9868
120	5179.9860
102	5179.9860
Maximum Deviation (MHz)	0.0140
Maximum Deviation (ppm)	2.7027

Temperature vs. Frequency Stability

Temperature	Measurement Frequency (MHz)
(°C)	5180.0000
0	5179.9856
5	5179.9856
10	5179.9856
20	5179.9856
30	5179.9856
40	5179.9856
Maximum Deviation (MHz)	0.0144
Maximum Deviation (ppm)	2.7799

Test Mode	UNII-3
-----------	--------

Voltage vs. Frequency Stability

Voltage	Measurement Frequency (MHz)
(V)	5745.0000
132	5744.9848
120	5744.9848
108	5744.9848
Maximum Deviation (MHz)	0.0152
Maximum Deviation (ppm)	2.6458

Temperature vs. Frequency Stability

Temperature	Measurement Frequency (MHz)
(°C)	5745.0000
0	5744.9848
5	5744.9852
10	5744.9848
20	5744.9848
30	5744.9848
40	5744.9848
Maximum Deviation (MHz)	0.0152
Maximum Deviation (ppm)	2.6458

End of Test Report