

FCC Radio Test Report

FCC ID: V7TAC18

This report concerns (check one): Original Grant Class I Change Class II Change

Project No. : 1608C055
Equipment : AC1900 Enhanced Smart Dual-band Gigabit WiFi Router
Model Name : AC18
Applicant : SHENZHEN TENDA TECHNOLOGY CO.,LTD
Address : 6-8 Floor, Tower E3, No. 1001, Zhongshanyuan Road, Nanshan District, Shenzhen, China. 518052

Date of Receipt : Aug. 05, 2016
Date of Test : Aug. 05, 2016 ~ Jan. 09, 2017
Issued Date : Jan. 09, 2017
Tested by : BTL Inc.

Testing Engineer :

Shawn Xiao

(Shawn Xiao)

Technical Manager :

David Mao

(David Mao)

Authorized Signatory :

Steven Lu

(Steven Lu)

B T L I N C .

No.3, Jinshagang 1st Road, Shixia, Dalang Town, Dongguan,
Guangdong, China.

TEL: +86-769-8318-3000 FAX: +86-769-8319-6000

Declaration

BTL represents to the client that testing is done in accordance with standard procedures as applicable and that test instruments used has been calibrated with standards traceable to international standard(s) and/or national standard(s).

BTL's reports apply only to the specific samples tested under conditions. It is manufacture's responsibility to ensure that additional production units of this model are manufactured with the identical electrical and mechanical components. **BTL** shall have no liability for any declarations, inferences or generalizations drawn by the client or others from **BTL** issued reports.

BTL's report must not be used by the client to claim product certification, approval, or endorsement by NVLAP, NIST, or any agency of the Federal Government.

This report is the confidential property of the client. As a mutual protection to the clients, the public and **BTL-self**, extracts from the test report shall not be reproduced except in full with **BTL's** authorized written approval.

BTL's laboratory quality assurance procedures are in compliance with the **ISO Guide 17025** requirements, and accredited by the conformity assessment authorities listed in this test report.

Limitation

For the use of the authority's logo is limited unless the Test Standard(s)/Scope(s)/Item(s) mentioned in this test report is (are) included in the conformity assessment authorities acceptance respective.

Table of Contents

Page

1 . CERTIFICATION	6
2 . SUMMARY OF TEST RESULTS	7
2.1 TEST FACILITY	8
2.2 MEASUREMENT UNCERTAINTY	8
3 . GENERAL INFORMATION	9
3.1 GENERAL DESCRIPTION OF EUT	9
3.2 DESCRIPTION OF TEST MODES	11
3.3 TABLE OF PARAMETERS OF TEXT SOFTWARE SETTING	13
3.4 BLOCK DIAGRAM SHOWING THE CONFIGURATION OF SYSTEM TESTED	14
3.5 DESCRIPTION OF SUPPORT UNITS	14
4 . EMC EMISSION TEST	15
4.1 CONDUCTED EMISSION MEASUREMENT	15
4.1.1 POWER LINE CONDUCTED EMISSION LIMITS	15
4.1.2 TEST PROCEDURE	15
4.1.3 DEVIATION FROM TEST STANDARD	15
4.1.4 TEST SETUP	16
4.1.5 EUT OPERATING CONDITIONS	16
4.1.6 EUT TEST CONDITIONS	16
4.1.7 TEST RESULTS	16
4.2 RADIATED EMISSION MEASUREMENT	17
4.2.1 RADIATED EMISSION LIMITS	17
4.2.2 TEST PROCEDURE	18
4.2.3 DEVIATION FROM TEST STANDARD	18
4.2.4 TEST SETUP	19
4.2.5 EUT OPERATING CONDITIONS	20
4.2.6 EUT TEST CONDITIONS	20
4.2.7 TEST RESULTS (9KHZ TO 30MHZ)	21
4.2.8 TEST RESULTS (30MHZ TO 1000 MHZ)	21
4.2.9 TEST RESULTS (ABOVE 1000 MHZ)	21
5 . BANDWIDTH TEST	22
5.1 APPLIED PROCEDURES	22
5.1.1 TEST PROCEDURE	22
5.1.2 DEVIATION FROM STANDARD	22
5.1.3 TEST SETUP	22
5.1.4 EUT OPERATION CONDITIONS	22
5.1.5 EUT TEST CONDITIONS	22
5.1.6 TEST RESULTS	22
6 . MAXIMUM PEAK CONDUCTED OUTPUT POWER TEST	23

Table of Contents	Page
6.1 APPLIED PROCEDURES / LIMIT	23
6.1.1 TEST PROCEDURE	23
6.1.2 DEVIATION FROM STANDARD	23
6.1.3 TEST SETUP	23
6.1.4 EUT OPERATION CONDITIONS	23
6.1.5 EUT TEST CONDITIONS	23
6.1.6 TEST RESULTS	23
7 . ANTENNA CONDUCTED SPURIOUS EMISSION	24
7.1 APPLIED PROCEDURES / LIMIT	24
7.1.1 TEST PROCEDURE	24
7.1.2 DEVIATION FROM STANDARD	24
7.1.3 TEST SETUP	24
7.1.4 EUT OPERATION CONDITIONS	24
7.1.5 EUT TEST CONDITIONS	24
7.1.6 TEST RESULTS	24
8 . POWER SPECTRAL DENSITY TEST	25
8.1 APPLIED PROCEDURES / LIMIT	25
8.1.1 TEST PROCEDURE	25
8.1.2 DEVIATION FROM STANDARD	25
8.1.3 TEST SETUP	25
8.1.4 EUT OPERATION CONDITIONS	25
8.1.5 EUT TEST CONDITIONS	25
8.1.6 TEST RESULTS	25
9 . MEASUREMENT INSTRUMENTS LIST	26
10 . EUT TEST PHOTO	28
ATTACHMENT A - CONDUCTED EMISSION	32
ATTACHMENT B - RADIATED EMISSION (9KHZ TO 30MHZ)	35
ATTACHMENT C - RADIATED EMISSION (30MHZ TO 1000MHZ)	37
ATTACHMENT D - RADIATED EMISSION (ABOVE 1000MHZ)	44
ATTACHMENT E - BANDWIDTH	95
ATTACHMENT F – MAXIMUM PEAK CONDUCTED OUTPUT POWER	104
ATTACHMENT G - ANTENNA CONDUCTED SPURIOUS EMISSION	108
ATTACHMENT H - POWER SPECTRAL DENSITY	158

REPORT ISSUED HISTORY

Issued No.	Description	Issued Date
BTL-FCCP-1-1608C055	Original Issue.	Jan. 09, 2017

1. CERTIFICATION

Equipment : AC1900 Enhanced Smart Dual-band Gigabit WiFi Router
Brand Name : Tenda
Model Name : AC18
Applicant : SHENZHEN TENDA TECHNOLOGY CO.,LTD
Manufacturer : SHENZHEN TENDA TECHNOLOGY CO.,LTD
Address : 6-8 Floor, Tower E3, No. 1001, Zhongshanyuan Road, Nanshan District,
Shenzhen, China. 518052
Date of Test : Aug. 05, 2016 ~ Jan. 09, 2017
Test Sample : Engineering Sample
Standard(s) : FCC Part15, Subpart C:(15.247) / ANSI C63.10-2013

The above equipment has been tested and found compliance with the requirement of the relative standards by BTL Inc.

The test data, data evaluation, and equipment configuration contained in our test report (Ref No. BTL-FCCP-1-1608C055) were obtained utilizing the test procedures, test instruments, test sites that has been accredited by the Authority of TAF according to the ISO-17025 quality assessment standard and technical standard(s).

2. SUMMARY OF TEST RESULTS

Test procedures according to the technical standard(s):

Applied Standard(s): FCC Part15 (15.247) , Subpart C			
Standard(s) Section	Test Item	Judgment	Remark
15.207	Conducted Emission	PASS	
15.247(d)	Antenna conducted Spurious Emission	PASS	
15.247(a)(2)	6dB Bandwidth	PASS	
15.247(b)(3)	Peak Output Power	PASS	
15.247(e)	Power Spectral Density	PASS	
15.203	Antenna Requirement	PASS	
15.209/15.205	Transmitter Radiated Emissions	PASS	

NOTE:

(1) "N/A" denotes test is not applicable in this test report.

2.1 TEST FACILITY

The test facilities used to collect the test data in this report is at the location of No.3, Jinshagang 1st Road, Shixia, Dalang Town, Dongguan, Guangdong, China.
 BTL's test firm number for FCC: 319330

2.2 MEASUREMENT UNCERTAINTY

Where relevant, the following measurement uncertainty levels have been estimated for tests performed on the EUT as specified in CISPR 16-4-2. The BTL measurement uncertainty is less than the CISPR 16-4-2 U_{CISPR} requirement.

The reported uncertainty of measurement $y \pm U$, where expanded uncertainty U is based on a standard uncertainty multiplied by a coverage factor of $k=2$, providing a level of confidence of approximately 95 %.

A. Conducted Measurement:

Test Site	Method	Measurement Frequency Range	U, (dB)
DG-C02	CISPR	150 KHz ~ 30MHz	2.32

B. Radiated Measurement:

Test Site	Method	Measurement Frequency Range	Ant. H / V	U, (dB)
DG-CB03	CISPR	9KHz~30MHz	V	3.79
		9KHz~30MHz	H	3.57
		30MHz ~ 200MHz	V	3.82
		30MHz ~ 200MHz	H	3.78
		200MHz ~ 1,000MHz	V	4.10
		200MHz ~ 1,000MHz	H	4.06
		1GHz~18GHz	V	3.12
		1GHz~18GHz	H	3.68
		18GHz~40GHz	V	4.15
		18GHz~40GHz	H	4.14

Note: Unless specifically mentioned, the uncertainty of measurement has not been taken into account to declare the compliance or non-compliance to the specification.

3. GENERAL INFORMATION

3.1 GENERAL DESCRIPTION OF EUT

Equipment	AC1900 Enhanced Smart Dual-band Gigabit WiFi Router	
Brand Name	Tenda	
Model Name	AC18	
Model Difference	N/A	
Product Description	Operation Frequency	2412~2462 MHz
	Modulation Technology	802.11b:DSSS 802.11g:OFDM 802.11n:OFDM
	Bit Rate of Transmitter	802.11b: 11/5.5/2/1 Mbps 802.11g: 54/48/36/24/18/12/9/6 Mbps 802.11n up to 300 Mbps
	Output Power (Max.)	802.11b: 28.12dBm 802.11g: 27.32dBm 802.11n(20MHz):27.38dBm 802.11n(40MHz): 27.33dBm
Power Source	DC voltage supplied from AC/DC adapter. Brand Name: SHENZHEN HEWEISHUN NETWORK TECHNOLOGY CO.,LTD. Model Name:BN059-A30012U	
Power Rating	IP: 100-240V~50/60Hz 0.9A OP:12V --- 2.5A	

Note:

1. For a more detailed features description, please refer to the manufacturer's specifications or the user's manual.

2. Channel List:

CH01 – CH11 for 802.11b, 802.11g, 802.11n(20MHz) CH03 – CH09 for 802.11n(40MHz)							
Channel	Frequency (MHz)	Channel	Frequency (MHz)	Channel	Frequency (MHz)	Channel	Frequency (MHz)
01	2412	04	2427	07	2442	10	2457
02	2417	05	2432	08	2447	11	2462
03	2422	06	2437	09	2452		

3. Table for Filed Antenna

Ant.	Brand	Model Name	Antenna Type	Connector	Gain (dBi)
1	Tenda	AC18 V1.0	Dipole	N/A	3
2	Tenda	AC18 V1.0	Dipole	N/A	3
3	Tenda	AC18 V1.0	Dipole	N/A	3

Note:

The EUT incorporates a MIMO function. Physically, the EUT provides three completed transmitters and receivers (3T3R), all transmit signals are completely correlated, then, **Direction gain** = $G_{ANT} + 10\log(N_{ANT}/N_{SS})$, where N_{SS} = the number of independent spatial streams of data. This EUT can only work with three spatial data streams, the $N_{SS}=1$ is worst case. Directional gain = $3 + 10\log(3/1) = 3 + 4.77 = 7.77$ dBi.
 So the power limit is $30 - 7.7 + 6 = 28.30$ dB, the power density limit is $8 - 7.7 + 6 = 6.3$ dB

4.

Operating Mode TX Mode	1TX	3TX
	802.11b	V (ANT 1)
802.11g	V (ANT 1)	-
802.11n(20MHz)	-	V (ANT 1 + ANT 2+ANT 3)
802.11n(40MHz)	-	V (ANT 1 + ANT 2+ANT 3)

3.2 DESCRIPTION OF TEST MODES

To investigate the maximum EMI emission characteristics generated from EUT, the test system was pre-scanning tested based on the consideration of following EUT operation mode or test configuration mode which possibly have effect on EMI emission level. Each of these EUT operation mode(s) or test configuration mode(s) mentioned above was evaluated respectively.

Pretest Mode	Description
Mode 1	TX B MODE CHANNEL 01/06/11
Mode 2	TX G MODE CHANNEL 01/06/11
Mode 3	TX N-20MHZ MODE CHANNEL 01/06/11
Mode 4	TX N-40MHZ MODE CHANNEL 03/06/09
Mode 5	TX Mode

The EUT system operated these modes were found to be the worst case during the pre-scanning test as following:

For Conducted Test	
Final Test Mode	Description
Mode 5	TX Mode

For Radiated Test	
Final Test Mode	Description
Mode 1	TX B MODE CHANNEL 01/06/11
Mode 2	TX G MODE CHANNEL 01/06/11
Mode 3	TX N-20MHZ MODE CHANNEL 01/06/11
Mode 4	TX N-40MHZ MODE CHANNEL 03/06/09

For Band Edge Test	
Final Test Mode	Description
Mode 1	TX B MODE CHANNEL 01/06/11
Mode 2	TX G MODE CHANNEL 01/06/11
Mode 3	TX N-20MHZ MODE CHANNEL 01/06/11
Mode 4	TX N-40MHZ MODE CHANNEL 03/06/09

6dB Spectrum Bandwidth	
Final Test Mode	Description
Mode 1	TX B MODE CHANNEL 01/06/11
Mode 2	TX G MODE CHANNEL 01/06/11
Mode 3	TX N-20MHZ MODE CHANNEL 01/06/11
Mode 4	TX N-40MHZ MODE CHANNEL 03/06/09

Maximum Conducted Output Power	
Final Test Mode	Description
Mode 1	TX B MODE CHANNEL 01/06/11
Mode 2	TX G MODE CHANNEL 01/06/11
Mode 3	TX N-20MHZ MODE CHANNEL 01/06/11
Mode 4	TX N-40MHZ MODE CHANNEL 03/06/09

Power Spectral Density	
Final Test Mode	Description
Mode 1	TX B MODE CHANNEL 01/06/11
Mode 2	TX G MODE CHANNEL 01/06/11
Mode 3	TX N-20MHZ MODE CHANNEL 01/06/11
Mode 4	TX N-40MHZ MODE CHANNEL 03/06/09

Note:

- (1) The measurements are performed at the high, middle, low available channels.
- (2) 802.11b mode: DBPSK (1Mbps)
 802.11g mode: OFDM (6Mbps)
 802.11n HT20 mode : BPSK (13Mbps)
 802.11n HT40 mode : BPSK (27Mbps)
 For radiated emission tests, the highest output powers were set for final test.
- (3) For radiated below 1G test, the 802.11b is found to be the worst case and recorded.
- (4) The EUT was programmed to be in continuously transmitting mode and the transmit duty cycle is not less than 98%.

3.3 TABLE OF PARAMETERS OF TEXT SOFTWARE SETTING

During testing, channel & power controlling software provided by the customer was used to control the operating channel as well as the output power level. The RF output power selection is for the setting of RF output power expected by the customer and is going to be fixed on the firmware of the final end product power parameters of WLAN

Test software version	RT3x7xQA		
Frequency (MHz)	2412	2437	2462
802.11b	100	110	103
802.11g	75	98	82
802.11n (20MHz)	60	64	64
Frequency	2422	2437	2452
802.11n (40MHz)	62	64	63

3.4 BLOCK DIAGRAM SHOWING THE CONFIGURATION OF SYSTEM TESTED

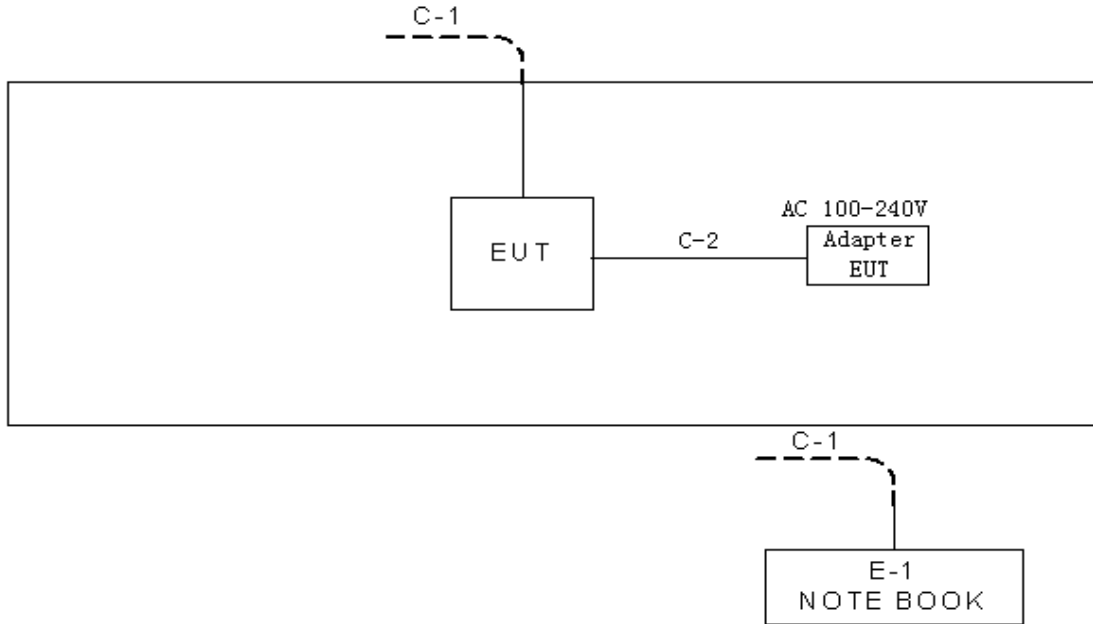

3.5 DESCRIPTION OF SUPPORT UNITS

The EUT has been tested as an independent unit together with other necessary accessories or support units. The following support units or accessories were used to form a representative test configuration during the tests.

Item	Equipment	Mfr/Brand	Model/Type No.	FCC ID	Series No.
E-1	NOTEBOOK	Dell	DCSM 745	DOC	G7K832X

Item	Shielded Type	Ferrite Core	Length	Note
C-1	NO	NO	10m	RJ45 Cable
C-2	NO	NO	1.2m	Power Cable

4. EMC EMISSION TEST

4.1 CONDUCTED EMISSION MEASUREMENT

4.1.1 POWER LINE CONDUCTED EMISSION LIMITS (Frequency Range 150KHz-30MHz)

Frequency of Emission (MHz)	Conducted Limit (dB μ V)	
	Quasi-peak	Average
0.15 -0.50	66 to 56*	56 to 46*
0.50 -5.0	56	46
5.0 -30.0	60	50

Note:

- (1) The limit of " * " decreases with the logarithm of the frequency
- (2) The test result calculated as following:
 Measurement Value = Reading Level + Correct Factor
 Correct Factor = Insertion Loss + Cable Loss + Attenuator Factor(if use)
 Margin Level = Measurement Value - Limit Value

The following table is the setting of the receiver

Receiver Parameters	Setting
Attenuation	10 dB
Start Frequency	0.15 MHz
Stop Frequency	30 MHz
IF Bandwidth	9 KHz

4.1.2 TEST PROCEDURE

- a. The EUT was placed 0.8 meters from the horizontal ground plane with EUT being connected to the power mains through a line impedance stabilization network (LISN). All other support equipments powered from additional LISN(s). The LISN provide 50 Ohm/ 50uH of coupling impedance for the measuring instrument.
- b. Interconnecting cables that hang closer than 40 cm to the ground plane shall be folded back and forth in the center forming a bundle 30 to 40 cm long.
- c. I/O cables that are not connected to a peripheral shall be bundled in the center. The end of the cable may be terminated, if required, using the correct terminating impedance. The overall length shall not exceed 1 m.
- d. LISN at least 80 cm from nearest part of EUT chassis.
- e. For the actual test configuration, please refer to the related Item –EUT Test Photos.

4.1.3 DEVIATION FROM TEST STANDARD

No deviation

4.1.4 TEST SETUP

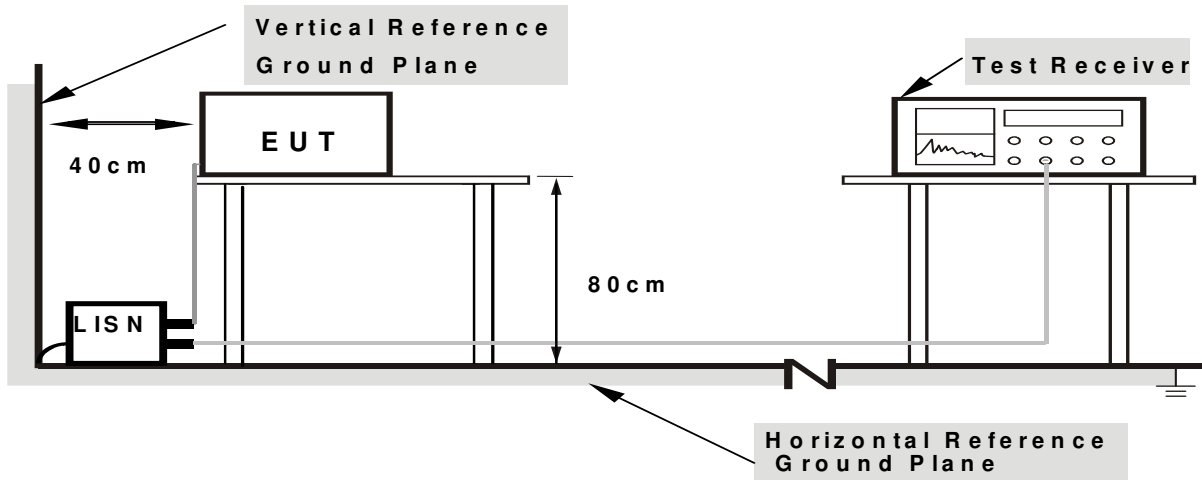

- Note: 1.Support units were connected to second LISN.
 2.Both of LISNs (AMN) are 80 cm from EUT and at least 80 from other units and other metal planes

4.1.5 EUT OPERATING CONDITIONS

The EUT was placed on the test table and programmed in normal function.

4.1.6 EUT TEST CONDITIONS

Temperature: 25°C Relative Humidity: 55% Test Voltage: AC 120V/60Hz

4.1.7 TEST RESULTS

Please refer to the Attachment A.

4.2 RADIATED EMISSION MEASUREMENT

4.2.1 RADIATED EMISSION LIMITS

In case the emission fall within the restricted band specified on 15.205(a), then the 15.209(a) limit in the table below has to be followed.

LIMITS OF RADIATED EMISSION MEASUREMENT (9KHz-1000MHz)

Frequency (MHz)	Field Strength (microvolts/meter)	Measurement Distance (meters)
0.009~0.490	2400/F(KHz)	300
0.490~1.705	24000/F(KHz)	30
1.705~30.0	30	30
30~88	100	3
88~216	150	3
216~960	200	3
960~1000	500	3

LIMITS OF RADIATED EMISSION MEASUREMENT (Above 1000MHz)

Frequency (MHz)	(dBuV/m) (at 3 meters)	
	PEAK	AVERAGE
Above 1000	74	54

Notes:

- (1) The limit for radiated test was performed according to FCC PART 15C.
- (2) The tighter limit applies at the band edges.
- (3) Emission level (dBuV/m)=20log Emission level (uV/m).
- (4) The test result calculated as following:
 Measurement Value = Reading Level + Correct Factor
 Correct Factor = Antenna Factor + Cable Loss - Amplifier Gain(if use)
 Margin Level = Measurement Value - Limit Value

Spectrum Parameter	Setting
Attenuation	Auto
Start Frequency	1000 MHz
Stop Frequency	10th carrier harmonic
RBW / VBW (Emission in restricted band)	1MHz / 3MHz for Peak, 1MHz / 1/T for Average

Receiver Parameter	Setting
Attenuation	Auto
Start ~ Stop Frequency	9KHz~90KHz for PK/AVG detector
Start ~ Stop Frequency	90KHz~110KHz for QP detector
Start ~ Stop Frequency	110KHz~490KHz for PK/AVG detector
Start ~ Stop Frequency	490KHz~30MHz for QP detector
Start ~ Stop Frequency	30MHz~1000MHz for QP detector

4.2.2 TEST PROCEDURE

- a. The measuring distance of at 3 m shall be used for measurements. The EUT was placed on the top of a rotating table 0.8 meter above the ground at a 3 meter semi-anechoic chamber. The table was rotated 360 degrees to determine the position of the highest radiation.(below 1GHz)
- b. The measuring distance of at 3 m shall be used for measurements. The EUT was placed on the top of a rotating table 1.5 meter above the ground at a 3 meter semi-anechoic chamber. The table was rotated 360 degrees to determine the position of the highest radiation.(above 1GHz)
- c. The height of the equipment or of the substitution antenna shall be 0.8m or 1.5m; the height of the test antenna shall vary between 1 m to 4 m. Both horizontal and vertical polarizations of the antenna are set to make the measurement.
- d. For each suspected emission, the EUT was arranged to its worst case and then the antenna was tuned to heights find the maximum reading (used Bore sight function).
- e. The receiver system was set to peak and average detect function and specified bandwidth with maximum hold mode when the test frequency is above 1GHz.
- f. The initial step in collecting conducted emission data is a receiver peak detector mode pre-scanning the measurement frequency range. Significant peaks are then marked and then Quasi Peak detector mode re-measured.
- g. All readings are Peak unless otherwise stated QP in column of Note. Peak denotes that the Peak reading compliance with the QP Limits and then QP Mode measurement didn't perform. (below 1GHz)
- h. All readings are Peak Mode value unless otherwise stated AVG in column of Note. If the Peak Mode Measured value compliance with the Peak Limits and lower than AVG Limits, the EUT shall be deemed to meet both Peak & AVG Limits and then only Peak Mode was measured, but AVG Mode didn't perform. (above 1GHz)
- i. For the actual test configuration, please refer to the related Item –EUT Test Photos.

4.2.3 DEVIATION FROM TEST STANDARD

No deviation

4.2.4 TEST SETUP

(A) Radiated Emission Test Set-Up Frequency Below 1 GHz

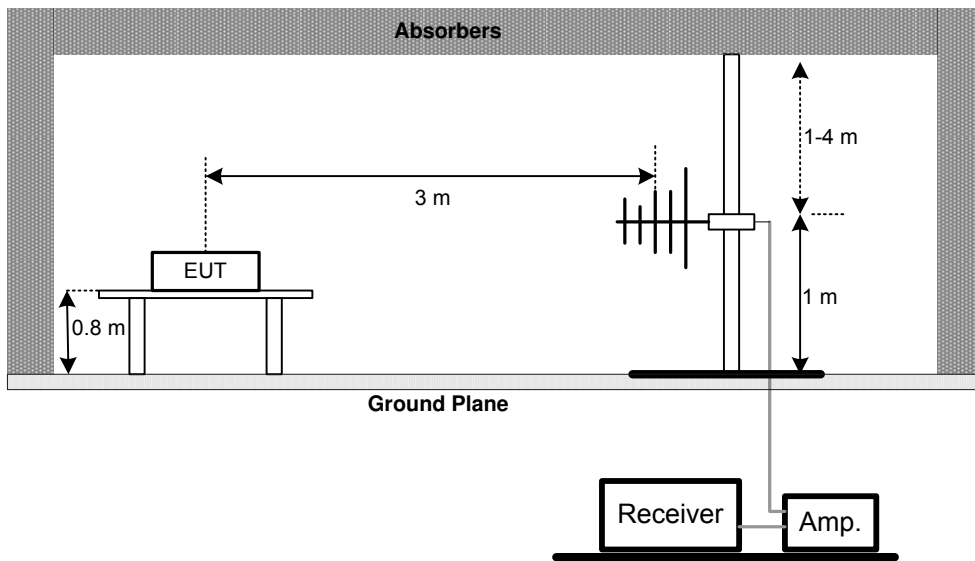

(B) Radiated Emission Test Set-Up Frequency Above 1 GHz

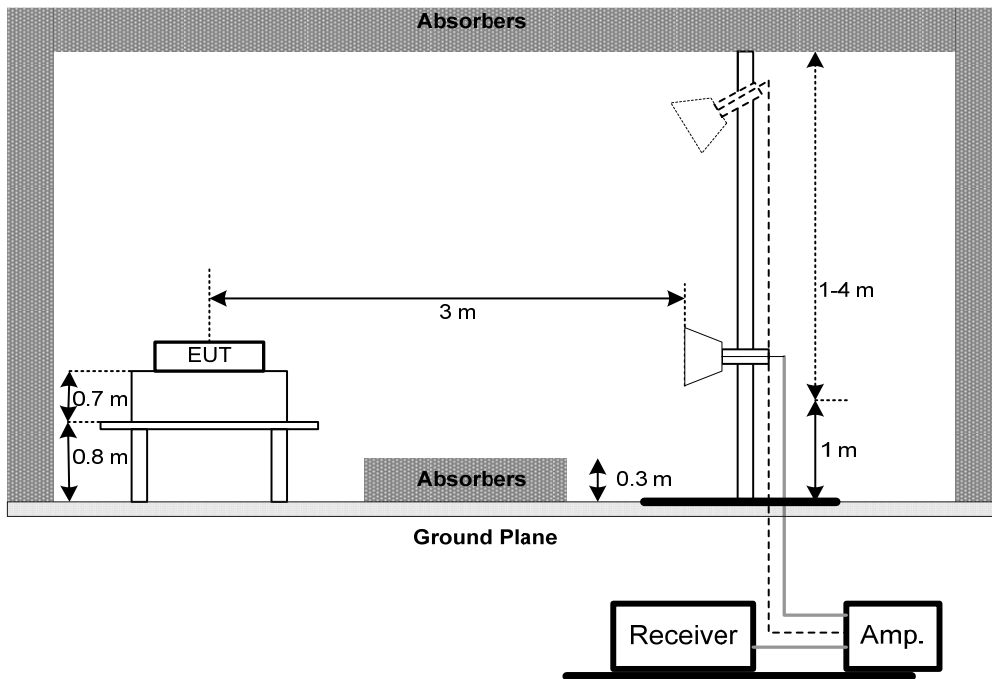

(C) For Radiated Emissions Below 30MHz

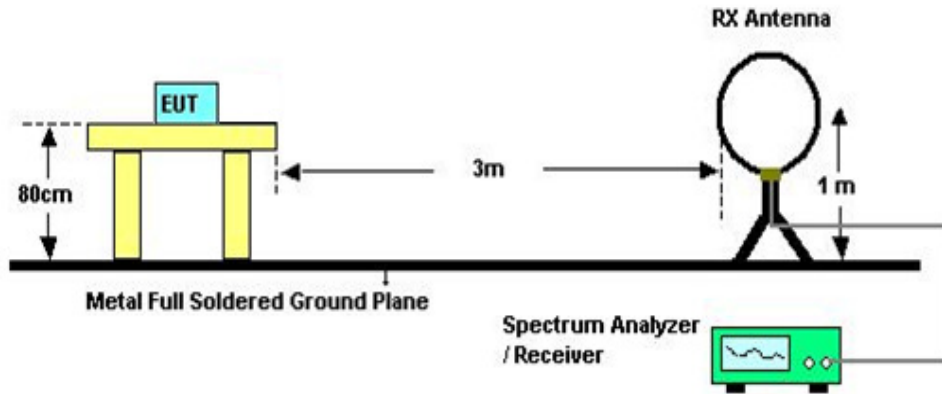

4.2.5 EUT OPERATING CONDITIONS

The EUT was programmed to be in continuously transmitting mode.

4.2.6 EUT TEST CONDITIONS

Temperature: 25°C Relative Humidity: 55% Test Voltage: AC 120V/60Hz

4.2.7 TEST RESULTS (9KHZ TO 30MHZ)

Please refer to the Attachment B

Remark:

- (1) The amplitude of spurious emissions which are attenuated by more than 20 dB below the permissible value has no need to be reported.
- (2) Distance extrapolation factor = $40 \log(\text{specific distance} / \text{test distance})$ (dB).
- (3) Limit line = specific limits (dBuV) + distance extrapolation factor.

4.2.8 TEST RESULTS (30MHZ TO 1000 MHZ)

Please refer to the Attachment C.

4.2.9 TEST RESULTS (ABOVE 1000 MHZ)

Please refer to the Attachment D.

Remark:

- (1) No limit: This is fundamental signal, the judgment is not applicable.
For fundamental signal judgment was referred to Peak output test.

5. BANDWIDTH TEST

5.1 APPLIED PROCEDURES

FCC Part15 (15.247) , Subpart C			
Section	Test Item	Frequency Range (MHz)	Result
15.247(a)(2)	Bandwidth	2400-2483.5	PASS

5.1.1 TEST PROCEDURE

- a. The EUT was directly connected to the spectrum analyzer and antenna output port as show in the block diagram below,
- b. Spectrum Setting: RBW= 100KHz, VBW=300KHz, Sweep time = 2.5 ms.

5.1.2 DEVIATION FROM STANDARD

No deviation.

5.1.3 TEST SETUP

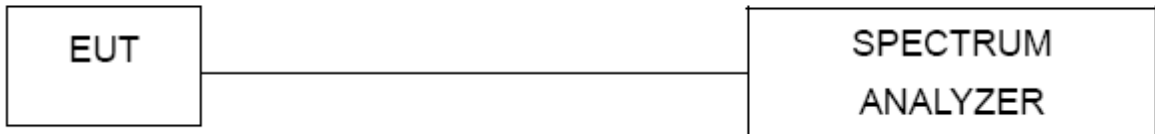

5.1.4 EUT OPERATION CONDITIONS

The EUT was programmed to be in continuously transmitting mode.

5.1.5 EUT TEST CONDITIONS

Temperature: 25°C Relative Humidity: 55% Test Voltage: AC 120V/60Hz

5.1.6 TEST RESULTS

Please refer to the Attachment E.

6. MAXIMUM PEAK CONDUCTED OUTPUT POWER TEST

6.1 APPLIED PROCEDURES / LIMIT

FCC Part15 (15.247) , Subpart C				
Section	Test Item	Limit	Frequency Range (MHz)	Result
15.247(b)(3)	Maximum Output Power	1 Watt or 30dBm	2400-2483.5	PASS

6.1.1 TEST PROCEDURE

- a. The EUT was directly connected to the power meter and antenna output port as show in the block diagram below,
- b. The maximum peak conducted output power was performed in accordance with method 9.1.2 of FCC KDB 558074 D01 DTS Meas Guidance v03r05 and FCC KDB 662911 D01 Multiple Transmitter Output v02r01.

6.1.2 DEVIATION FROM STANDARD

No deviation.

6.1.3 TEST SETUP

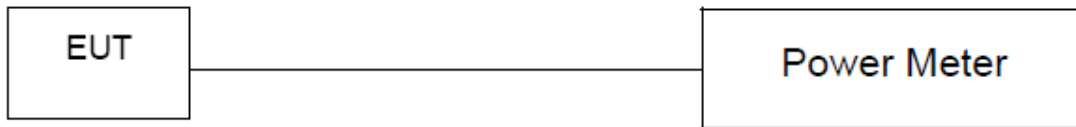

6.1.4 EUT OPERATION CONDITIONS

The EUT was programmed to be in continuously transmitting mode.

6.1.5 EUT TEST CONDITIONS

Temperature: 25°C Relative Humidity: 55% Test Voltage: AC 120V/60Hz

6.1.6 TEST RESULTS

Please refer to the Attachment F.

7. ANTENNA CONDUCTED SPURIOUS EMISSION

7.1 APPLIED PROCEDURES / LIMIT

In any 100 kHz bandwidth outside the frequency band in which the spread spectrum or digitally modulated device is operating, the RF power that is produced shall be at least 20 dB below that in the 100 kHz bandwidth within the band that contains the highest level of the desired power, based on either an RF conducted or a radiated measurement, provided that the transmitter demonstrates compliance with the peak conducted power limits.

7.1.1 TEST PROCEDURE

- a. The EUT was directly connected to the spectrum analyzer and antenna output port as show in the block diagram below,
- b. Spectrum Setting: RBW= 100KHz, VBW=300KHz, Sweep time = Auto.
- c. Offset=antenna gain+cable loss

7.1.2 DEVIATION FROM STANDARD

No deviation.

7.1.3 TEST SETUP

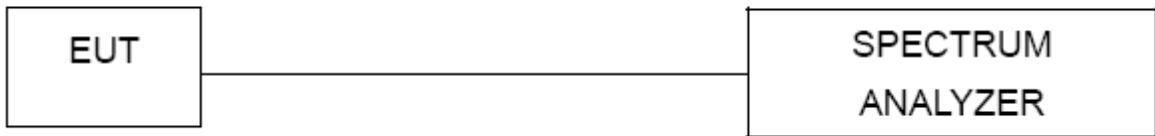

7.1.4 EUT OPERATION CONDITIONS

The EUT was programmed to be in continuously transmitting mode.

7.1.5 EUT TEST CONDITIONS

Temperature: 25°C Relative Humidity: 55% Test Voltage: AC 120V/60Hz

7.1.6 TEST RESULTS

Please refer to the Attachment G.

8. POWER SPECTRAL DENSITY TEST

8.1 APPLIED PROCEDURES / LIMIT

FCC Part15 (15.247) , Subpart C				
Section	Test Item	Limit	Frequency Range (MHz)	Result
15.247(e)	Power Spectral Density	8 dBm (in any 3KHz)	2400-2483.5	PASS

8.1.1 TEST PROCEDURE

- a. The EUT was directly connected to the spectrum analyzer and antenna output port as show in the block diagram below,
- b. Spectrum Setting: RBW=3KHz, VBW=10KHz, Sweep time = Auto.

8.1.2 DEVIATION FROM STANDARD

No deviation.

8.1.3 TEST SETUP

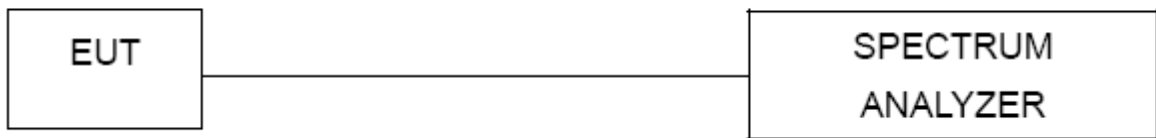

8.1.4 EUT OPERATION CONDITIONS

The EUT was programmed to be in continuously transmitting mode.

8.1.5 EUT TEST CONDITIONS

Temperature: 25°C Relative Humidity: 55% Test Voltage: AC 120V/60Hz

8.1.6 TEST RESULTS

Please refer to the Attachment H.

9. MEASUREMENT INSTRUMENTS LIST

Conducted Emission Measurement					
Item	Kind of Equipment	Manufacturer	Type No.	Serial No.	Calibrated until
1	LISN	EMCO	3816/2	0052765	Mar. 27, 2017
2	LISN	R&S	ENV216	101447	Mar. 27, 2017
3	Test Cable	emci	RG223(9KHz-30MHz)	C_17	Mar. 10, 2017
4	EMI Test Receiver	R&S	ESCI	100382	Mar. 27, 2017
5	50Ω Terminator	SHX	TF2-3G-A	08122901	Mar. 27, 2017
6	Measurement Software	Farad	EZ-EMC Ver.NB-03A1-01	N/A	N/A

Radiated Emission Measurement					
Item	Kind of Equipment	Manufacturer	Type No.	Serial No.	Calibrated until
1	Antenna	Schwarzbeck	VULB9160	9160-3232	Mar. 27, 2017
2	Amplifier	HP	8447D	2944A09673	Nov. 09, 2016
3	Receiver	AGILENT	N9038A	MY52130039	Oct. 11, 2016
4	Test Cable	emci	LMR-400(30MHz-1GHz)	C-01	Jun. 26, 2017
5	Control	CT	SC100	N/A	N/A
6	Position Control	MF	MF-7802	MF780208416	N/A
7	Antenna	ETS	3115	00075789	Mar. 27, 2017
8	Amplifier	Agilent	8449B	3008A02274	Nov. 01, 2016
9	Receiver	AGILENT	N9038A	MY52130039	Oct. 11, 2016
10	Test Cable	emci	EMC104-SM-SM-10000(1GHz-26.5GHz)	C-68	Jun. 26, 2017
11	Controller	CT	SC100	N/A	N/A
12	Broad-Band Horn Antenna	Schwarzbeck	BBHA 9170	9170319	Apr. 23, 2017
13	Microwave Pre-amplifier With Adaptor	EMC INSTRUMENT	EMC2654045	980039 & HA01	Mar. 27, 2017
14	Active Loop Antenna	R&S	HFH2-Z2	830749/020	Sep. 07, 2016
15	Measurement Software	Farad	EZ-EMC Ver.NB-03A1-01	N/A	N/A

6dB Bandwidth Measurement					
Item	Kind of Equipment	Manufacturer	Type No.	Serial No.	Calibrated until
1	Spectrum Analyzer	R&S	FSP 40	100185	Oct. 11, 2016

Peak Output Power Measurement					
Item	Kind of Equipment	Manufacturer	Type No.	Serial No.	Calibrated until
1	P-series Power meter	Agilent	N1911A	MY45100473	Oct. 26, 2016
2	Wireband Power sensor	Agilent	N1921A	MY51100041	Oct. 26, 2016

Antenna Conducted Spurious Emission Measurement					
Item	Kind of Equipment	Manufacturer	Type No.	Serial No.	Calibrated until
1	Spectrum Analyzer	R&S	FSP 40	100185	Oct. 11, 2016

Power Spectral Density Measurement					
Item	Kind of Equipment	Manufacturer	Type No.	Serial No.	Calibrated until
1	Spectrum Analyzer	R&S	FSP 40	100185	Oct. 11, 2016

Remark: "N/A" denotes no model name, serial no. or calibration specified.
 All calibration period of equipment list is one year.

10. EUT TEST PHOTO

Conducted Measurement Photos



Radiated Measurement Photos

9KHz to 30MHz



Radiated Measurement Photos

30MHz to 1000MHz

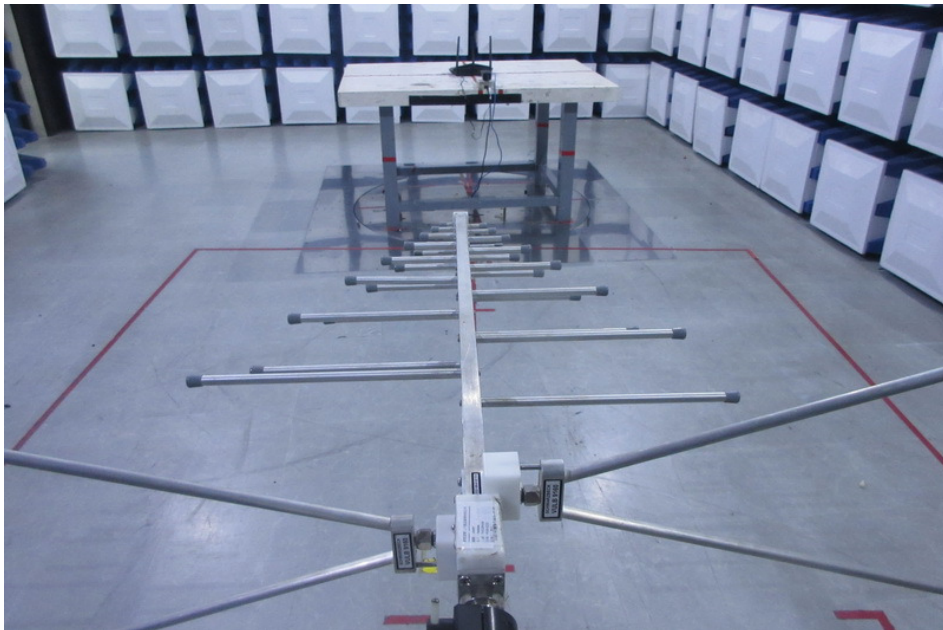

Radiated Measurement Photos

Above 1000MHz

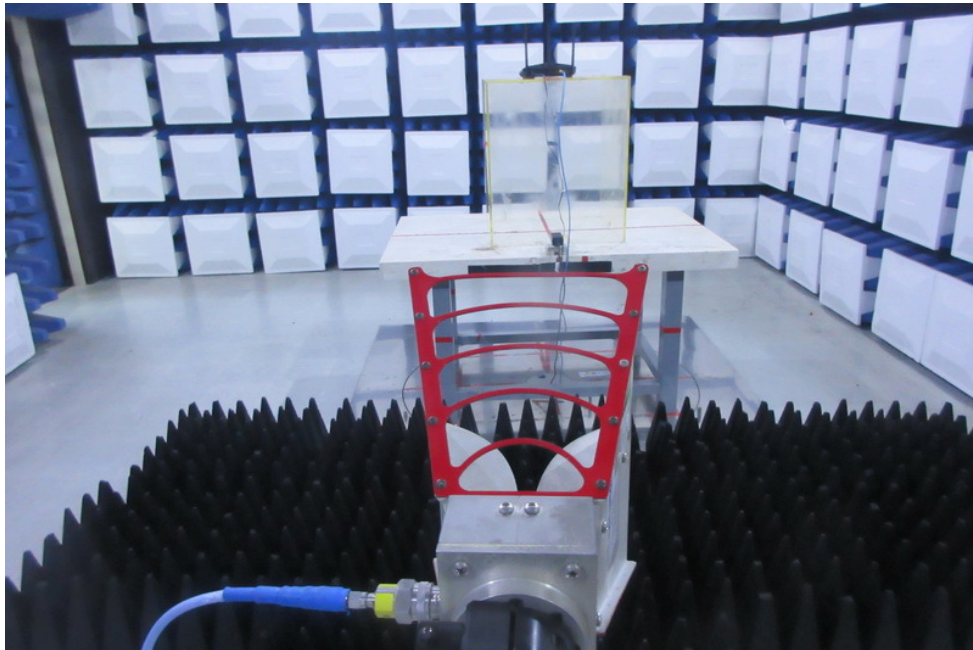
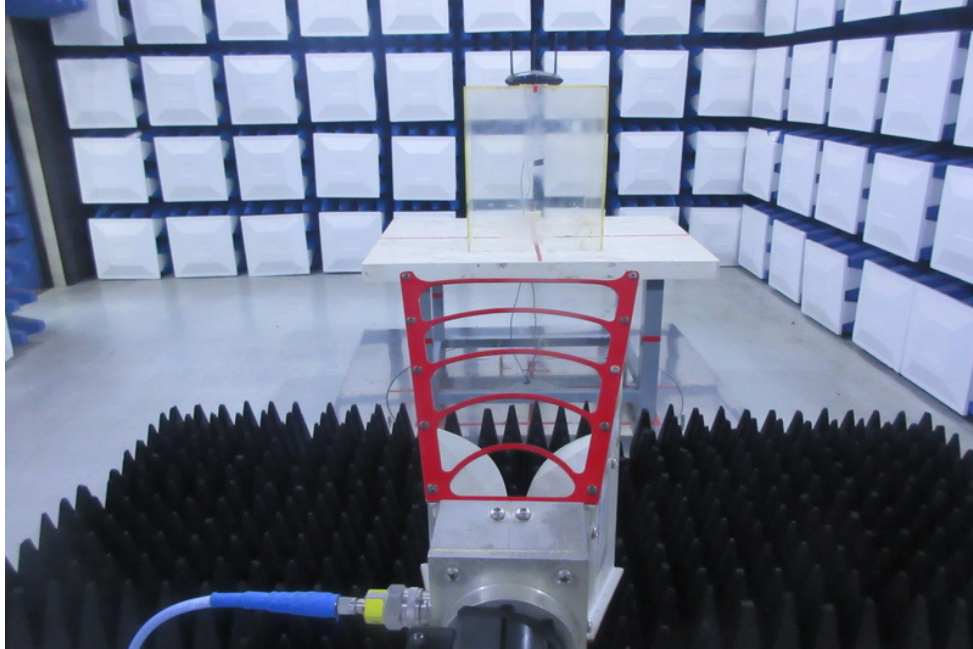

ATTACHMENT A - CONDUCTED EMISSION

Test Mode : TX Mode

Line

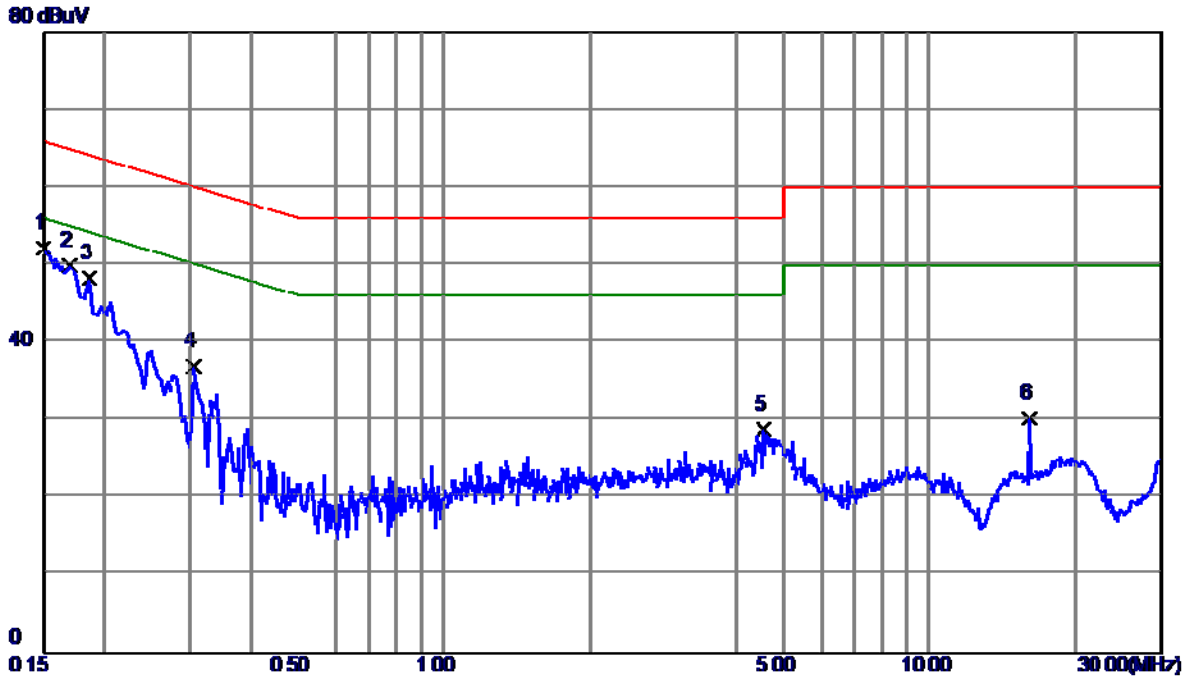

No.	Freq. MHz	Reading Level dBuV	Correct Factor dB	Measure ment dBuV	Limit dBuV	Margin dB	Detector	Comment
1 *	0.1500	42.70	9.52	52.22	66.00	-13.78	Peak	
2	0.1700	40.33	9.52	49.85	64.96	-15.11	Peak	
3	0.1860	38.77	9.53	48.30	64.21	-15.91	Peak	
4	0.3060	27.41	9.53	36.94	60.08	-23.14	Peak	
5	4.5620	18.66	10.08	28.74	56.00	-27.26	Peak	
6	16.1020	19.87	10.37	30.24	60.00	-29.76	Peak	

Test Mode : TX Mode

Neutral

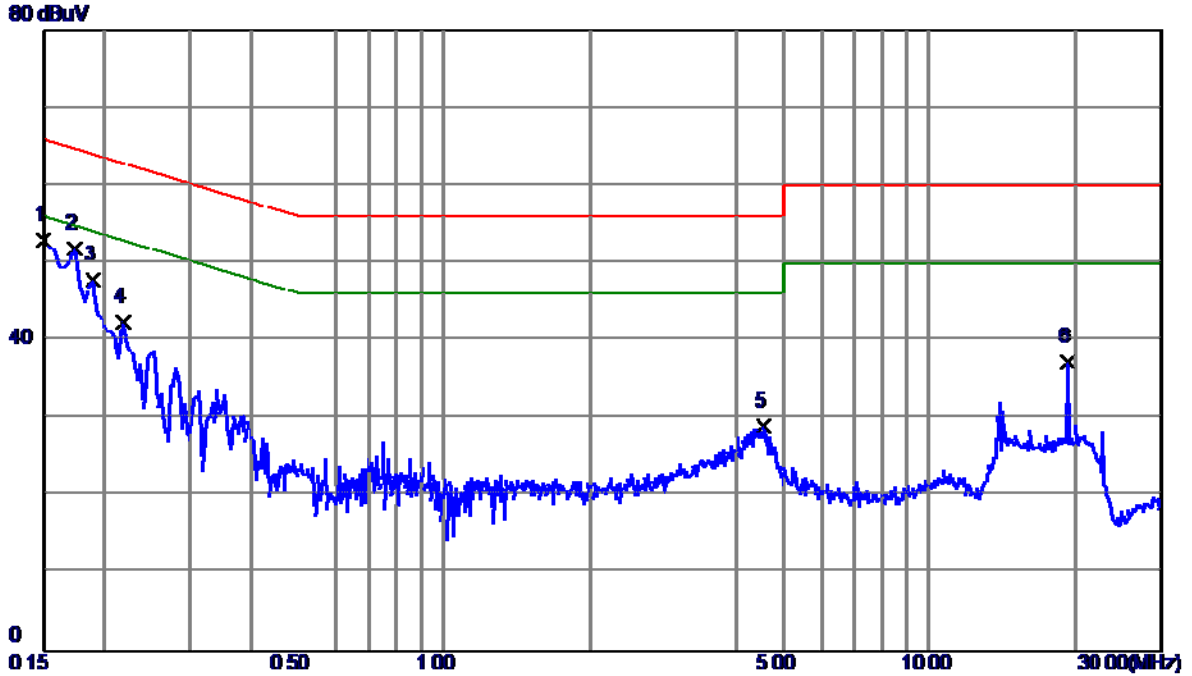

No.	Freq. MHz	Reading Level dBuV	Correct Factor dB	Measure ment dBuV	Limit dBuV	Margin dB	Detector	Comment
1	0.1500	43.43	9.52	52.95	66.00	-13.05	Peak	
2 *	0.1740	42.33	9.44	51.77	64.77	-13.00	Peak	
3	0.1900	38.41	9.49	47.90	64.04	-16.14	Peak	
4	0.2180	32.93	9.53	42.46	62.89	-20.43	Peak	
5	4.5660	19.03	9.95	28.98	56.00	-27.02	Peak	
6	19.2660	26.82	10.48	37.30	60.00	-22.70	Peak	

ATTACHMENT B - RADIATED EMISSION (9KHZ TO 30MHZ)

Test Mode:	TX B MODE CHANNEL 01
------------	----------------------

Frequency (MHz)	Ant 0°/90°	Read level dBuV/m	Factor (dB)	Measured(FS) (dBuV/m)	Limit (dBuV/m)	Margin (dB)	Note
0.0097	0°	13.41	24.9523	38.3623	127.8688	-89.5065	AVG
0.0097	0°	14.28	24.9523	39.2323	147.8688	-108.6365	PEAK
0.028	0°	6.73	23.7933	30.5233	118.6611	-88.1377	AVG
0.028	0°	8.12	23.7933	31.9133	138.6611	-106.7477	PEAK
0.036	0°	3.17	23.2867	26.4567	116.4782	-90.0215	AVG
0.036	0°	5.58	23.2867	28.8667	136.4782	-107.6115	PEAK
0.0587	0°	1.16	22.2260	23.3860	112.2315	-88.8455	AVG
0.0587	0°	2.53	22.2260	24.7560	132.2315	-107.4755	PEAK
0.5058	0°	19.36	19.8186	39.1786	73.5246	-34.3461	QP
1.9514	0°	23.71	19.5049	43.2149	69.5400	-26.3251	QP

Frequency (MHz)	Ant 0°/90°	Read level dBuV/m	Factor (dB)	Measured(FS) (dBuV/m)	Limit (dBuV/m)	Margin (dB)	Note
0.0123	90°	13.16	24.3000	37.4600	125.8061	-88.3461	AVG
0.0123	90°	14.89	24.3000	39.1900	145.8061	-106.6161	PEAK
0.0243	90°	7.28	24.0277	31.3077	119.8921	-88.5844	AVG
0.0243	90°	8.94	24.0277	32.9677	139.8921	-106.9244	PEAK
0.0427	90°	5.23	22.8623	28.0923	114.9957	-86.9033	AVG
0.0427	90°	6.19	22.8623	29.0523	134.9957	-105.9433	PEAK
0.0567	90°	1.54	22.2660	23.8060	112.5326	-88.7266	AVG
0.0567	90°	2.86	22.2660	25.1260	132.5326	-107.4066	PEAK
0.6201	90°	22.17	20.1843	42.3543	71.7550	-29.4007	QP
2.0567	90°	24.56	19.4660	44.0260	69.5400	-25.5140	QP

ATTACHMENT C - RADIATED EMISSION (30MHZ TO 1000MHZ)

Test Mode: TX B MODE CHANNEL 01

Vertical

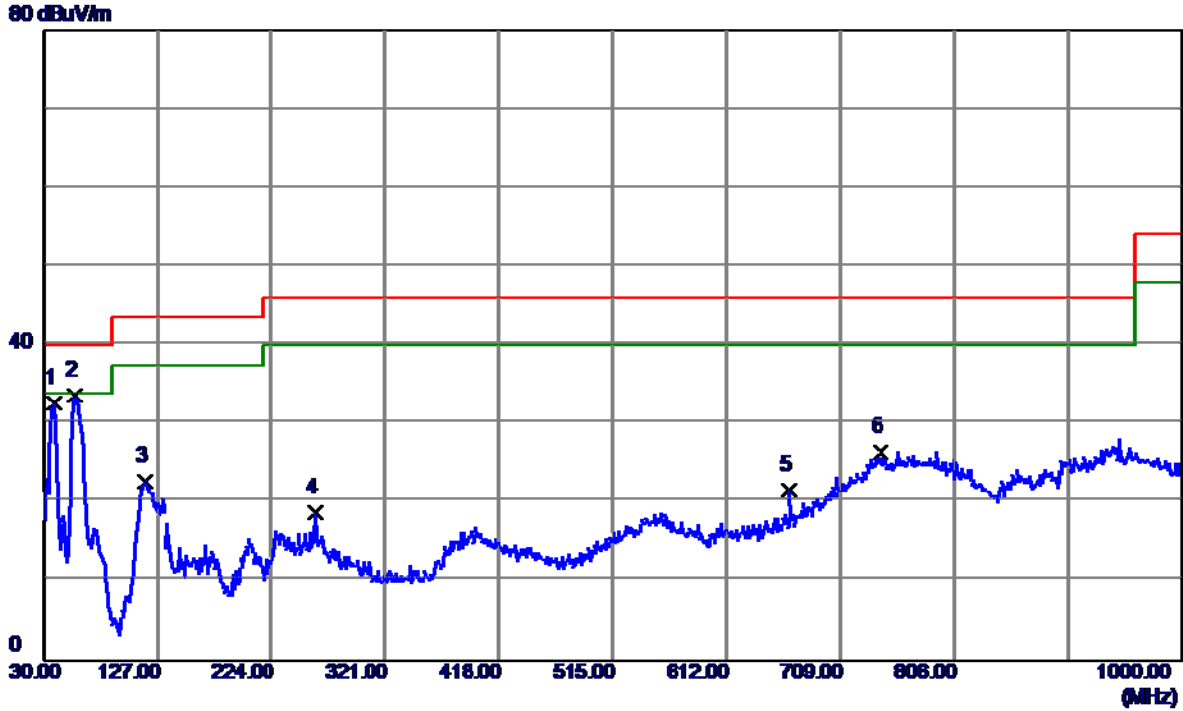

No.	Freq. MHz	Reading Level dBuV/m	Correct Factor dB	Measure ment dBuV/m	Limit dBuV/m	Margin dB	Detector	Comment
1	38.7300	53.47	-20.80	32.67	40.00	-7.33	Peak	
2 *	57.1600	54.61	-20.95	33.66	40.00	-6.34	Peak	
3	116.3300	44.37	-21.58	22.79	43.50	-20.71	Peak	
4	261.8299	34.46	-15.77	18.69	46.00	-27.31	Peak	
5	666.3200	33.10	-11.50	21.60	46.00	-24.40	Peak	
6	743.9200	30.60	-4.14	26.46	46.00	-19.54	Peak	

Test Mode: TX B MODE CHANNEL 01

Horizontal

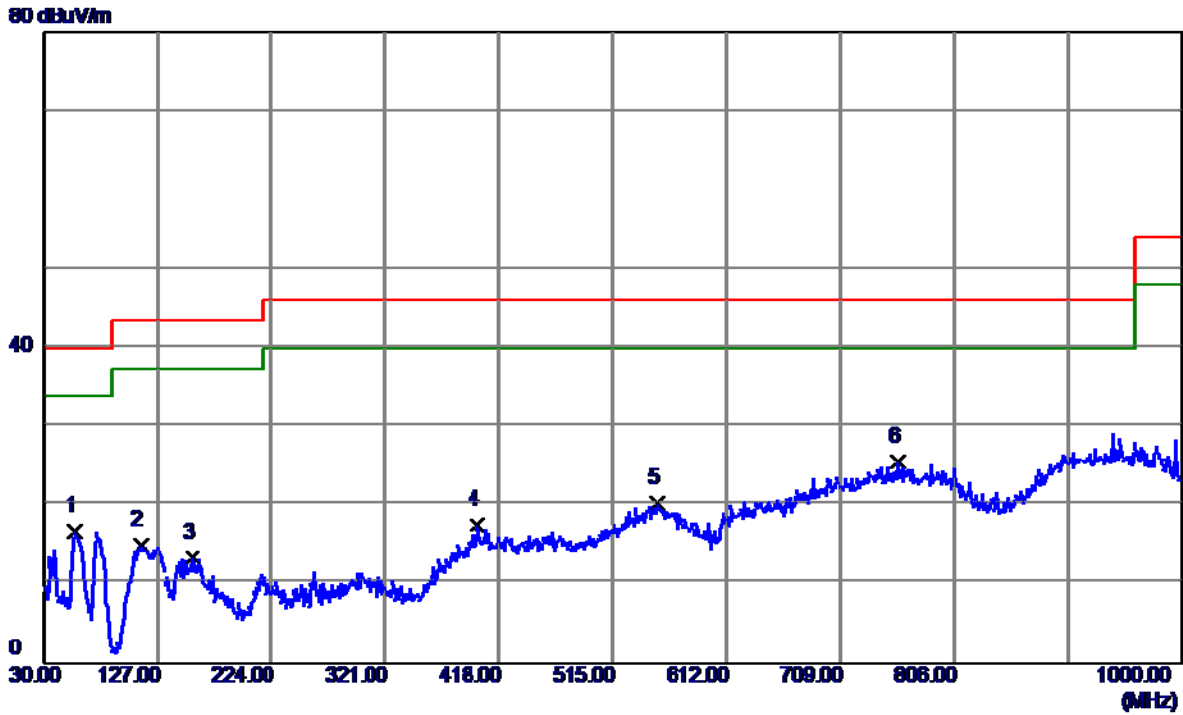

No.	Freq. MHz	Reading Level dBuV/m	Correct Factor dB	Measure ment dBuV/m	Limit dBuV/m	Margin dB	Detector	Comment
1	57.1600	37.81	-21.03	16.78	40.00	-23.22	Peak	
2	112.4500	39.15	24.16	14.99	43.50	28.51	Peak	
3	157.0700	35.04	-21.56	13.48	43.50	-30.02	Peak	
4	399.5700	30.46	-12.79	17.67	46.00	-28.33	Peak	
5	552.8300	29.24	-8.95	20.29	46.00	-25.71	Peak	
6 *	758.4699	30.86	-5.22	25.64	46.00	-20.36	Peak	

Test Mode: TX B MODE CHANNEL 06

Vertical

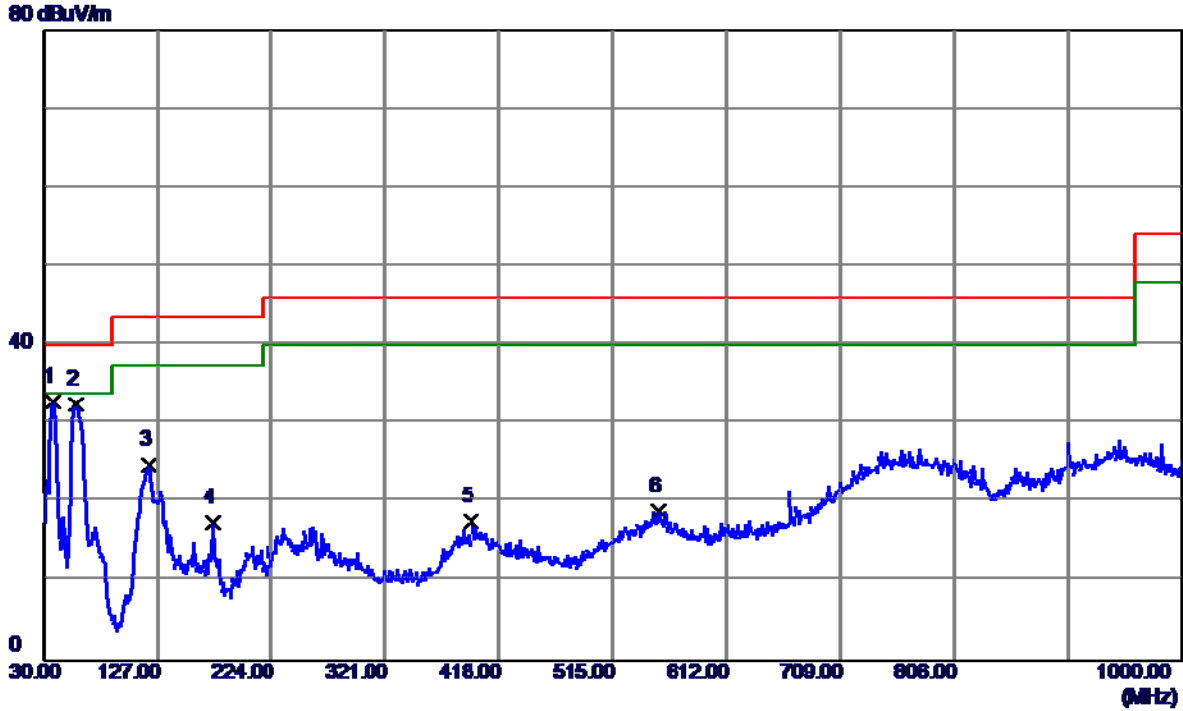

No.	Freq. MHz	Reading Level dBuV/m	Correct Factor dB	Measure ment dBuV/m	Limit dBuV/m	Margin dB	Detector	Comment
1 *	37.7599	53.68	-20.92	32.76	40.00	-7.24	Peak	
2	58.1300	53.82	-21.29	32.53	40.00	-7.47	Peak	
3	119.2400	45.31	-20.43	24.88	43.50	-18.62	Peak	
4	174.5300	35.44	-17.99	17.45	43.50	-26.05	Peak	
5	394.7200	30.10	-12.55	17.55	46.00	-28.45	Peak	
6	553.8000	29.65	-10.75	18.90	46.00	-27.10	Peak	

Test Mode: TX B MODE CHANNEL 06

Horizontal

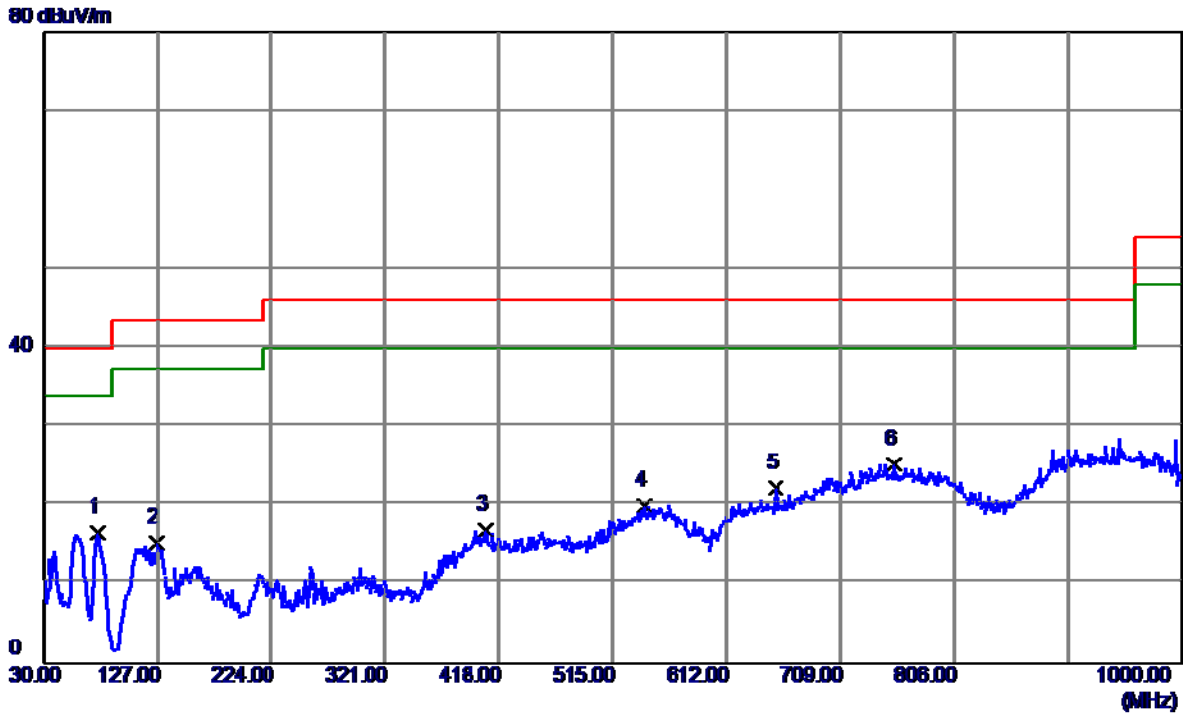

No.	Freq. MHz	Reading Level dBuV/m	Correct Factor dB	Measure ment dBuV/m	Limit dBuV/m	Margin dB	Detector	Comment
1	76.5600	42.49	-25.87	16.62	40.00	-23.38	Peak	
2	126.0300	38.52	23.14	15.38	43.50	28.12	Peak	
3	407.3299	29.85	-12.90	16.95	46.00	-29.05	Peak	
4	542.1599	29.53	-9.53	20.00	46.00	-26.00	Peak	
5	653.7100	31.55	-9.38	22.17	46.00	-23.83	Peak	
6 *	755.5600	30.49	-5.28	25.21	46.00	-20.79	Peak	

Test Mode: TX B MODE CHANNEL 11

Vertical

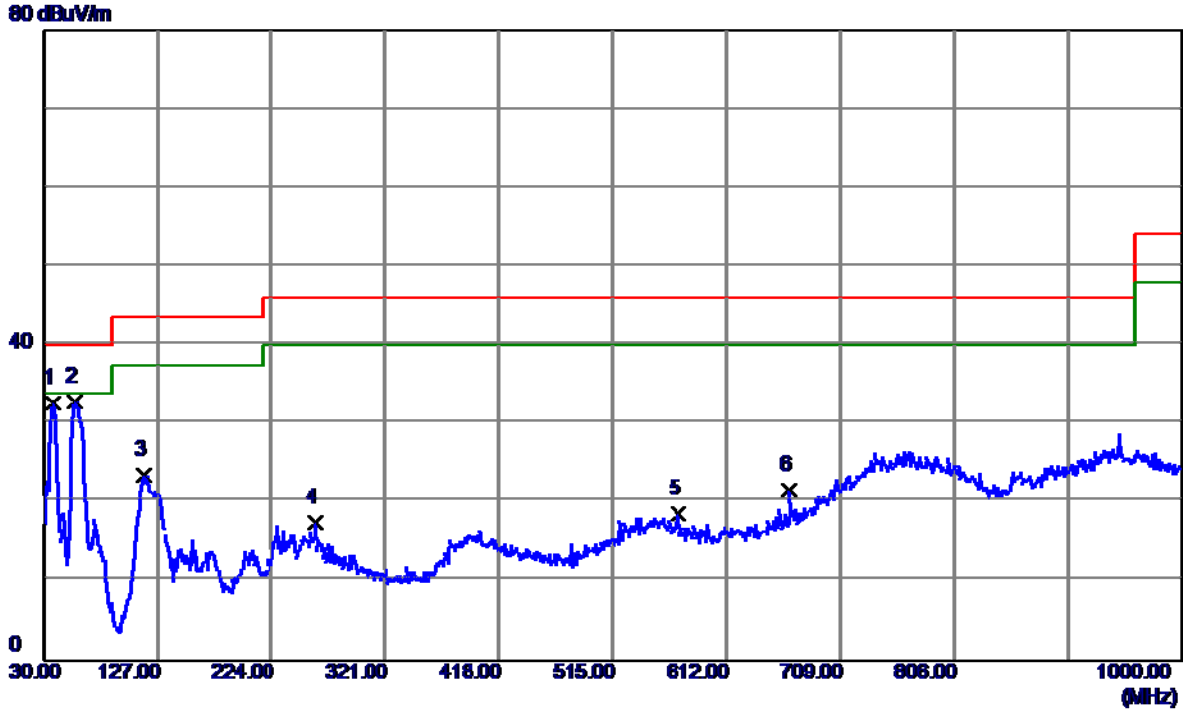

No.	Freq. MHz	Reading Level dBuV/m	Correct Factor dB	Measure ment dBuV/m	Limit dBuV/m	Margin dB	Detector	Comment
1	37.7599	53.56	-20.92	32.64	40.00	-7.36	Peak	
2 *	57.1600	53.82	-20.95	32.87	40.00	-7.13	Peak	
3	115.3600	45.46	-21.96	23.50	43.50	-20.00	Peak	
4	261.8299	33.23	-15.77	17.46	46.00	-28.54	Peak	
5	571.2600	30.33	-11.83	18.50	46.00	-27.50	Peak	
6	666.3200	33.06	-11.50	21.56	46.00	-24.44	Peak	

Test Mode: TX B MODE CHANNEL 11

Horizontal

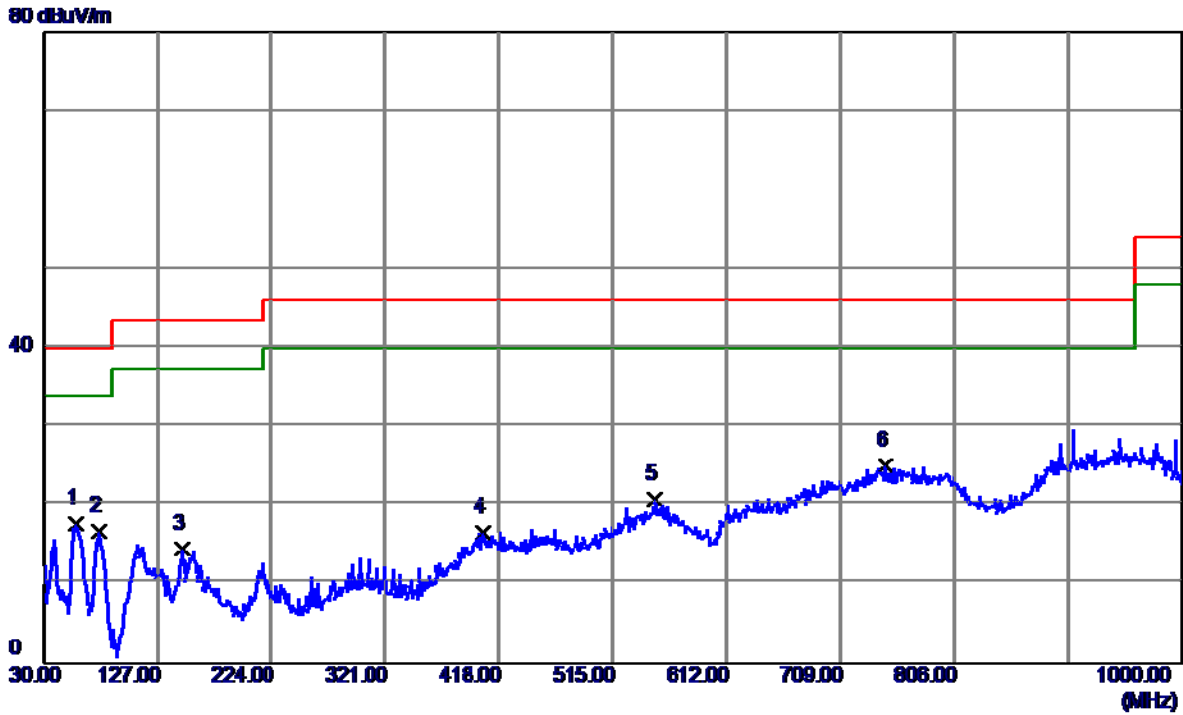

No.	Freq. MHz	Reading Level dBuV/m	Correct Factor dB	Measure ment dBuV/m	Limit dBuV/m	Margin dB	Detector	Comment
1	58.1300	39.08	-21.32	17.76	40.00	-22.24	Peak	
2	77.5300	42.71	25.91	16.80	40.00	23.20	Peak	
3	148.3400	37.73	-23.24	14.49	43.50	-29.01	Peak	
4	405.3900	29.57	-12.86	16.71	46.00	-29.29	Peak	
5	550.8900	29.63	-8.83	20.80	46.00	-25.20	Peak	
6 *	747.8000	30.41	-5.34	25.07	46.00	-20.93	Peak	

ATTACHMENT D - RADIATED EMISSION (ABOVE 1000MHZ)

Orthogonal Axis :	X
Test Mode :	TX B MODE 2412MHz

Vertical

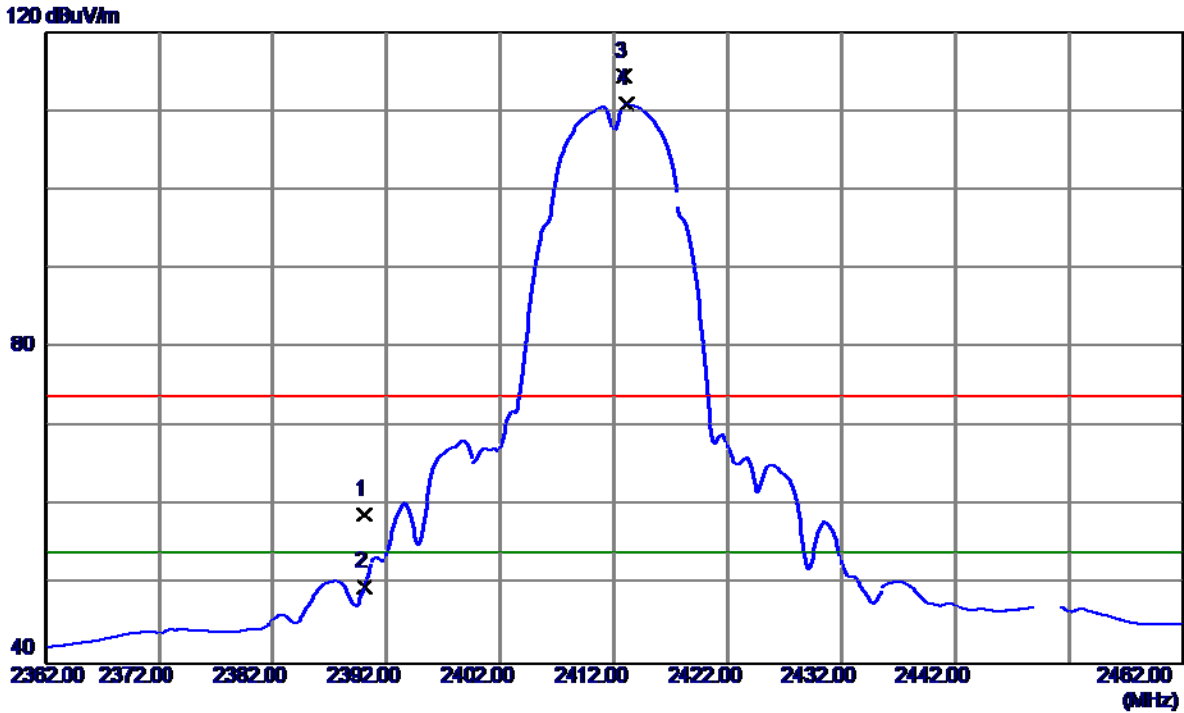

No.	Freq. MHz	Reading Level dBuV/m	Correct Factor dB	Measure ment dBuV/m	Limit dBuV/m	Margin dB	Detector	Comment
1	2390.0000	25.80	33.01	58.81	74.00	-15.19	Peak	
2	2390.0000	16.74	33.01	49.75	54.00	-4.25	AVG	
3	2412.9000	81.23	33.11	114.34	74.00	40.34	Peak	No Limit
4 *	2413.1000	77.72	33.11	110.83	54.00	56.83	AVG	No Limit

Orthogonal Axis :	X
Test Mode :	TX B MODE 2412MHz

Vertical

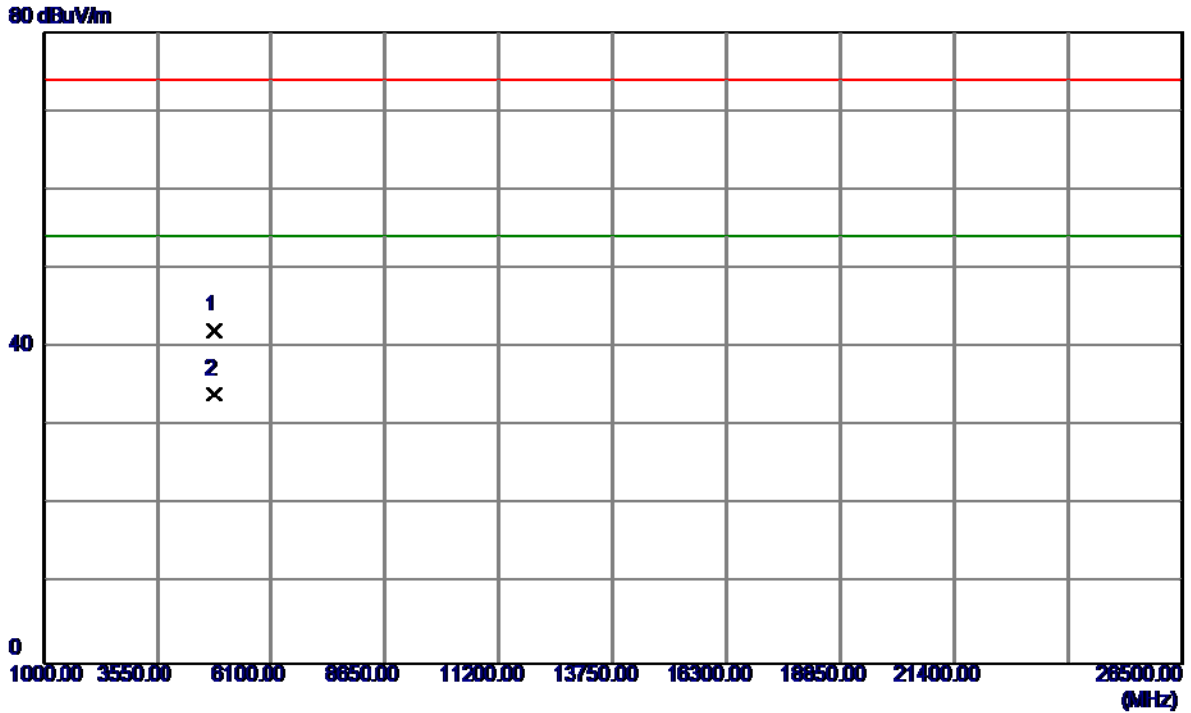

No.	Freq. MHz	Reading Level dBuV/m	Correct Factor dB	Measure ment dBuV/m	Limit dBuV/m	Margin dB	Detector	Comment
1	4823.8360	37.31	4.85	42.16	74.00	-31.84	Peak	
2 *	4823.9600	29.25	4.85	34.10	54.00	-19.90	AVG	

Orthogonal Axis :	X
Test Mode :	TX B MODE 2412MHz

Horizontal

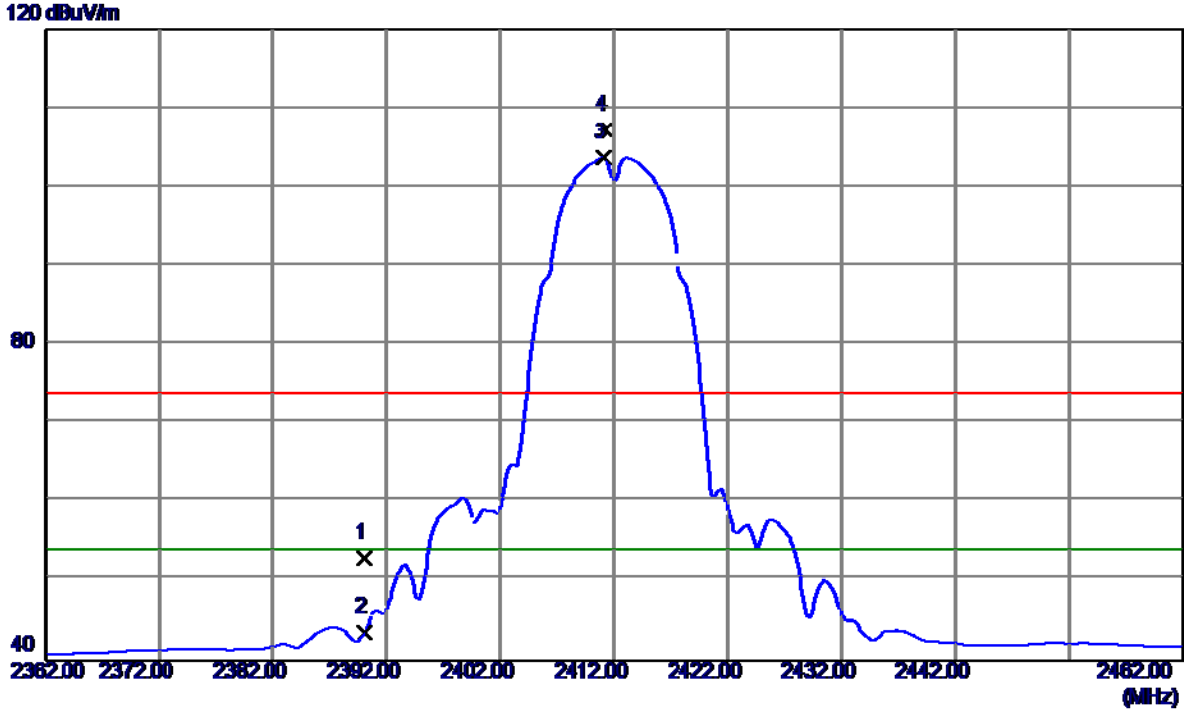

No.	Freq. MHz	Reading Level dBuV/m	Correct Factor dB	Measure ment dBuV/m	Limit dBuV/m	Margin dB	Detector	Comment
1	2390.0000	19.91	33.01	52.92	74.00	-21.08	Peak	
2	2390.0000	10.47	33.01	43.48	54.00	-10.52	AVG	
3 *	2411.1000	70.55	33.10	103.65	54.00	49.65	AVG	No Limit
4	2411.2000	74.08	33.10	107.18	74.00	33.18	Peak	No Limit

Orthogonal Axis :	X
Test Mode :	TX B MODE 2412MHz

Horizontal

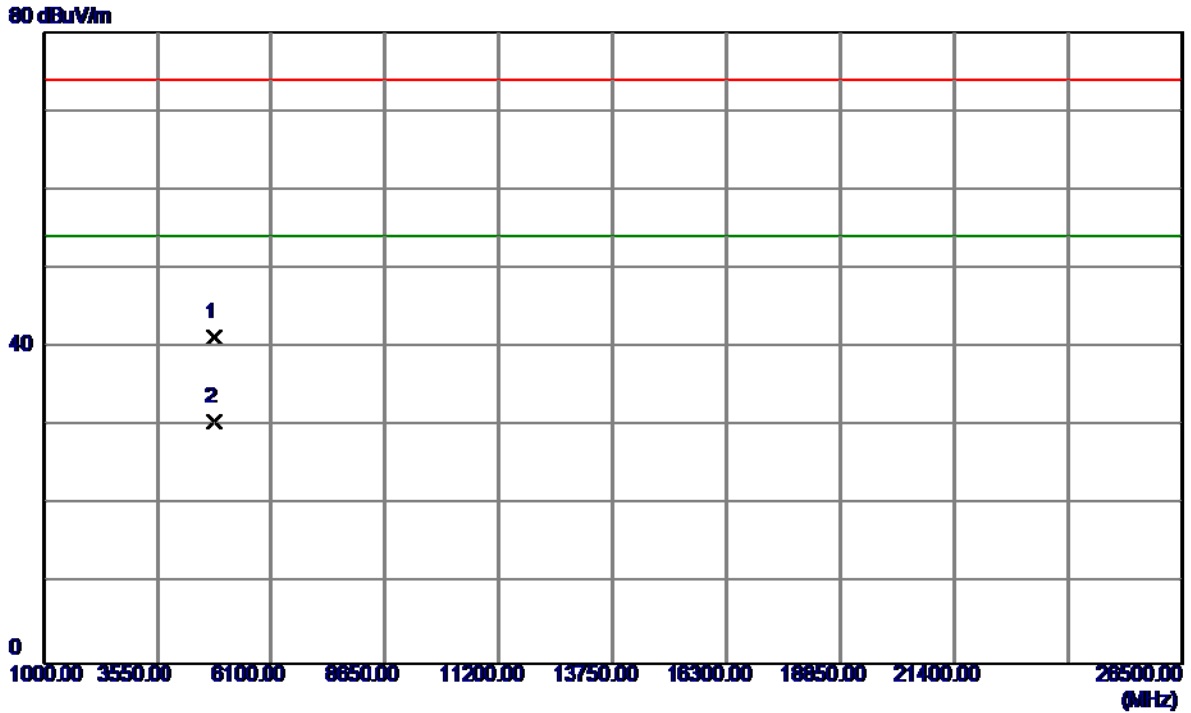

No.	Freq. MHz	Reading Level dBuV/m	Correct Factor dB	Measure ment dBuV/m	Limit dBuV/m	Margin dB	Detector	Comment
1	4823.9720	36.41	4.85	41.26	74.00	-32.74	Peak	
2 *	4823.9760	25.64	4.85	30.49	54.00	-23.51	AVG	

Orthogonal Axis :	X
Test Mode :	TX B MODE 2437MHz

Vertical

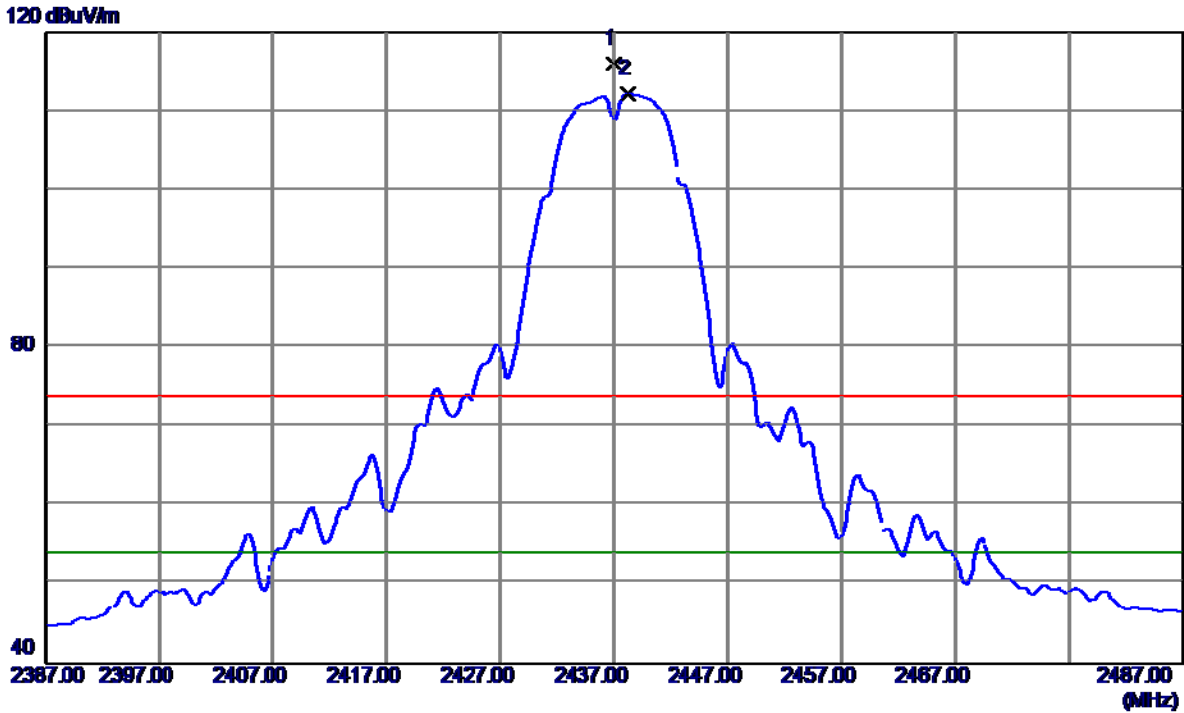

No.	Freq. MHz	Reading Level dBuV/m	Correct Factor dB	Measure ment dBuV/m	Limit dBuV/m	Margin dB	Detector	Comment
1	2437.0000	82.83	33.21	116.04	74.00	42.04	Peak	No Limit
2 *	2438.2000	78.96	33.21	112.17	54.00	58.17	AVG	No Limit

Orthogonal Axis :	X
Test Mode :	TX B MODE 2437MHz

Vertical

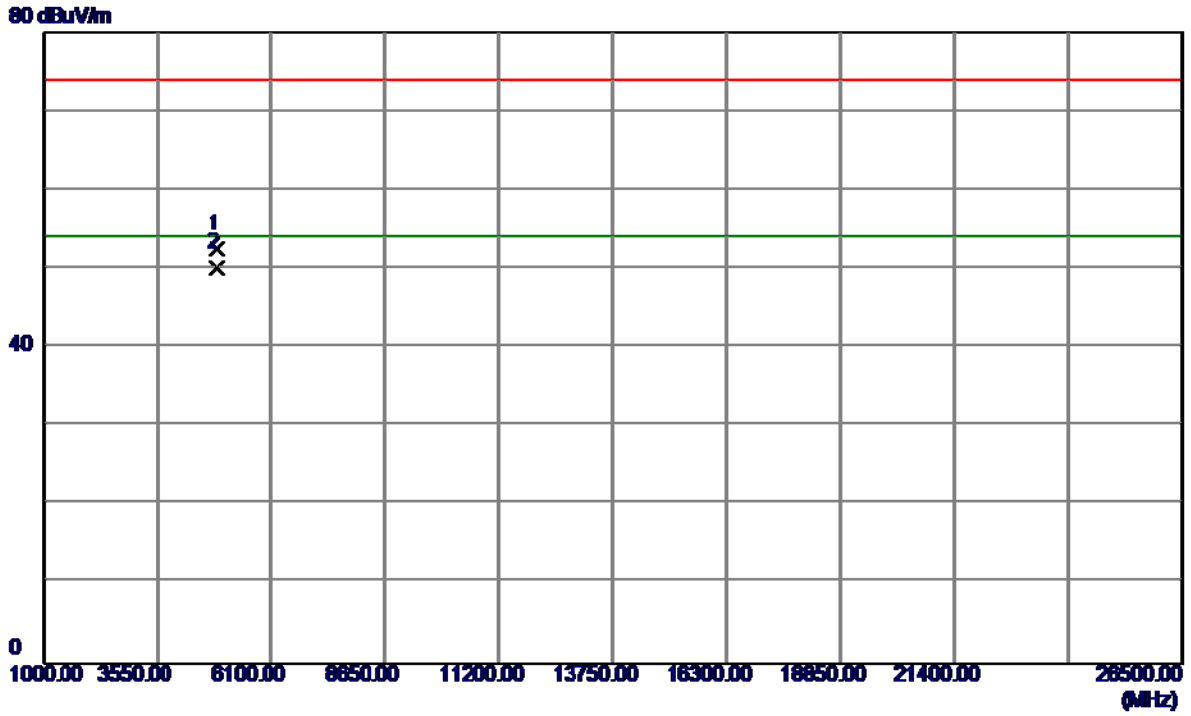

No.	Freq. MHz	Reading Level dBuV/m	Correct Factor dB	Measure ment dBuV/m	Limit dBuV/m	Margin dB	Detector	Comment
1	4873.9500	47.46	5.07	52.53	74.00	-21.47	Peak	
2 *	4873.9650	45.00	5.07	50.07	54.00	-3.93	AVG	

Orthogonal Axis :	X
Test Mode :	TX B MODE 2437MHz

Horizontal

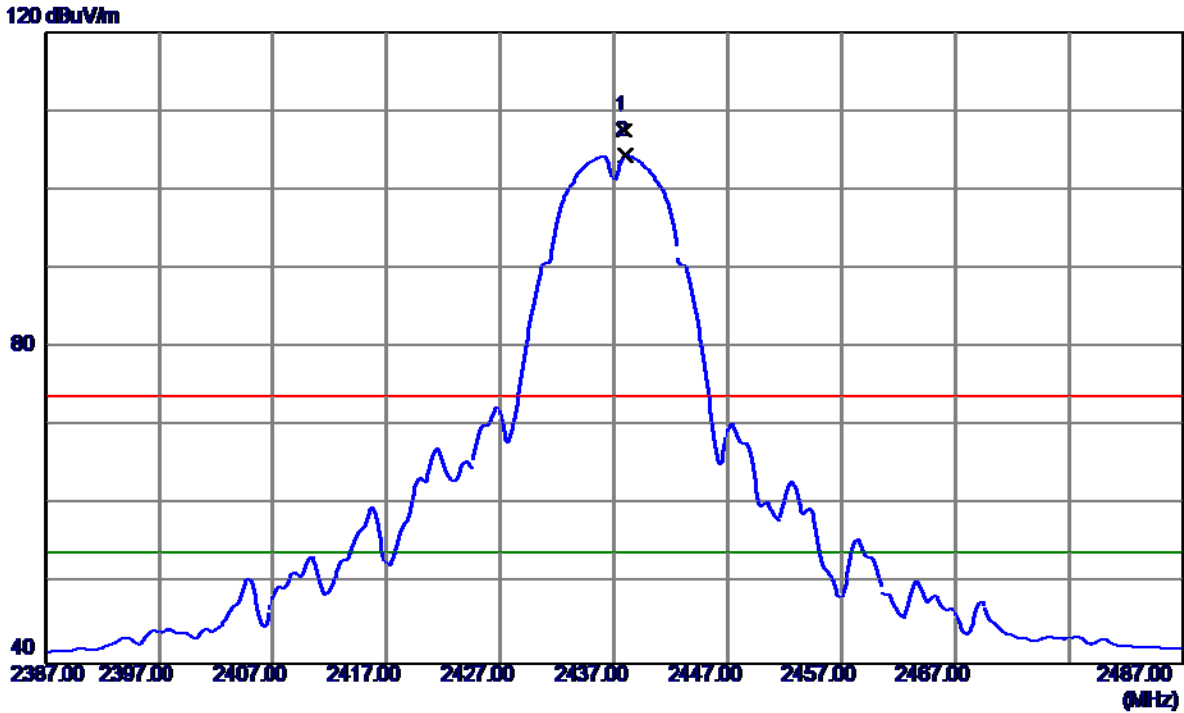

No.	Freq. MHz	Reading Level dBuV/m	Correct Factor dB	Measure ment dBuV/m	Limit dBuV/m	Margin dB	Detector	Comment
1	2437.9000	74.37	33.21	107.58	74.00	33.58	Peak	No Limit
2 *	2438.0000	71.07	33.21	104.28	54.00	50.28	AVG	No Limit

Orthogonal Axis :	X
Test Mode :	TX B MODE 2437MHz

Horizontal

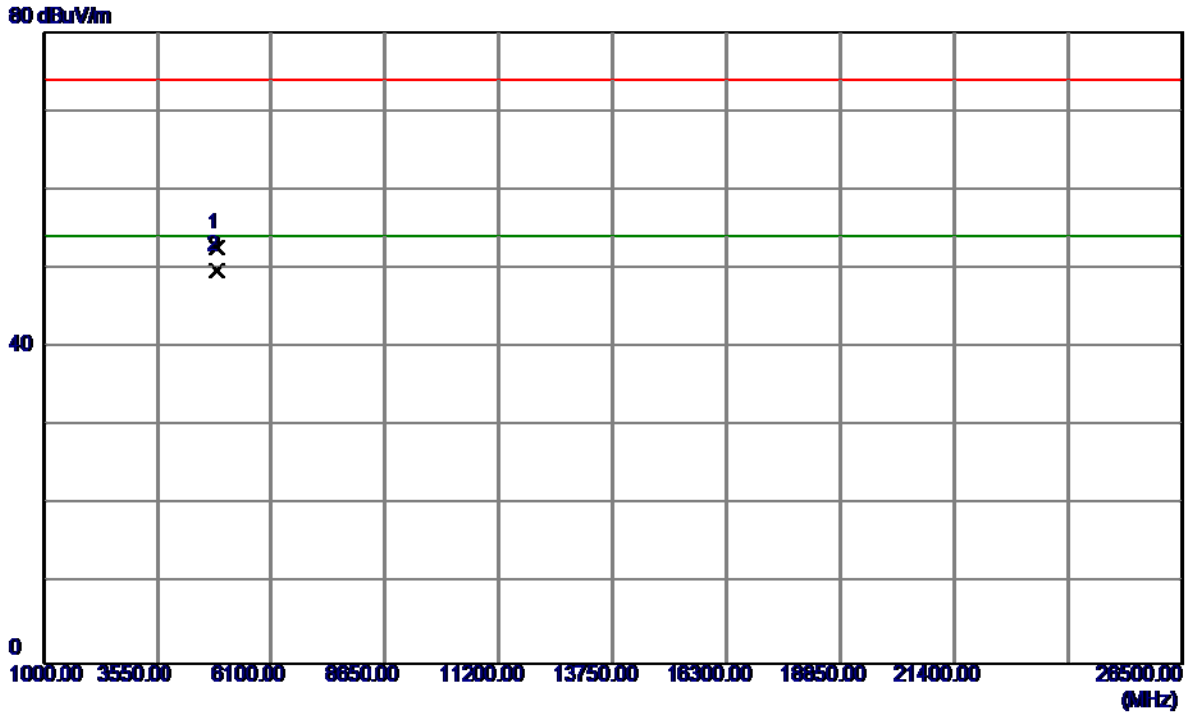

No.	Freq. MHz	Reading Level dBuV/m	Correct Factor dB	Measure ment dBuV/m	Limit dBuV/m	Margin dB	Detector	Comment
1	4873.9450	47.58	5.07	52.65	74.00	-21.35	Peak	
2 *	4873.9700	44.70	5.07	49.77	54.00	-4.23	AVG	

Orthogonal Axis :	X
Test Mode :	TX B MODE 2462MHz

Vertical

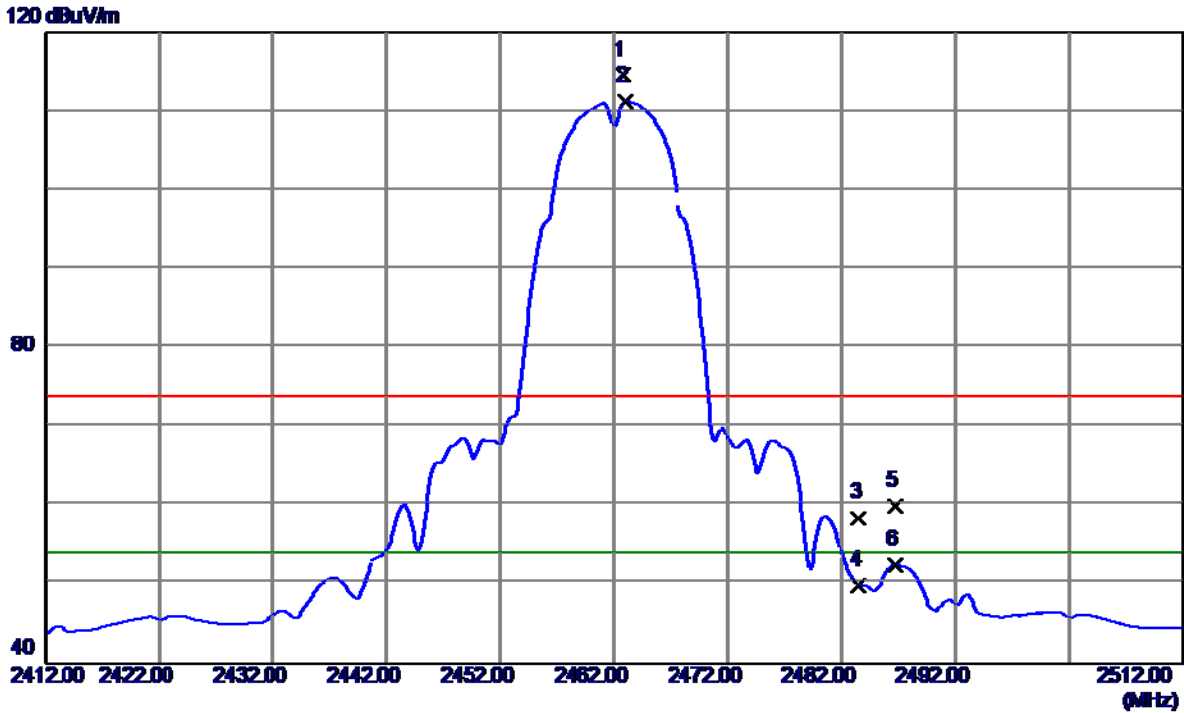

No.	Freq. MHz	Reading Level dBuV/m	Correct Factor dB	Measure ment dBuV/m	Limit dBuV/m	Margin dB	Detector	Comment
1	2462.8000	81.27	33.31	114.58	74.00	40.58	Peak	No Limit
2 *	2463.0000	77.91	33.32	111.23	54.00	57.23	AVG	No Limit
3	2483.5000	25.08	33.40	58.48	74.00	-15.52	Peak	
4	2483.5000	16.52	33.40	49.92	54.00	-4.08	AVG	
5	2486.8000	26.59	33.41	60.00	74.00	-14.00	Peak	
6	2486.8000	19.11	33.41	52.52	54.00	-1.48	AVG	

Orthogonal Axis :	X
Test Mode :	TX B MODE 2462MHz

Vertical

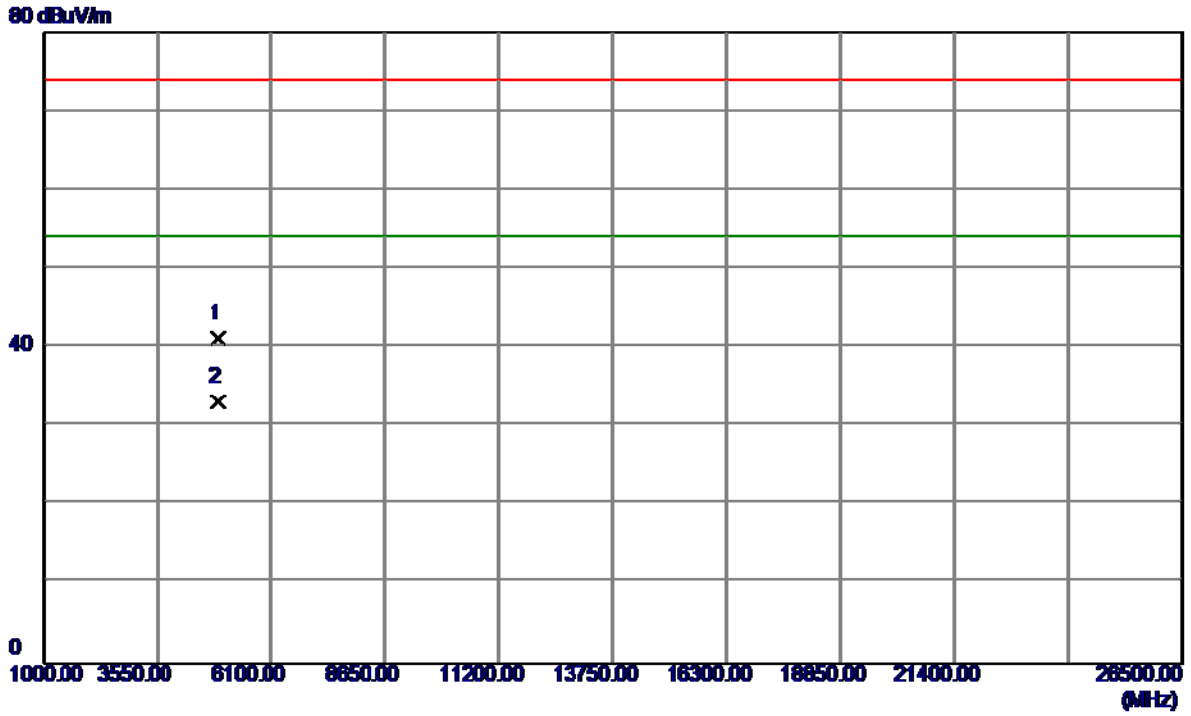

No.	Freq. MHz	Reading Level dBuV/m	Correct Factor dB	Measure ment dBuV/m	Limit dBuV/m	Margin dB	Detector	Comment
1	4923.9300	35.89	5.28	41.17	74.00	-32.83	Peak	
2 *	4923.9800	27.86	5.28	33.14	54.00	-20.86	AVG	

Orthogonal Axis :	X
Test Mode :	TX B MODE 2462MHz

Horizontal

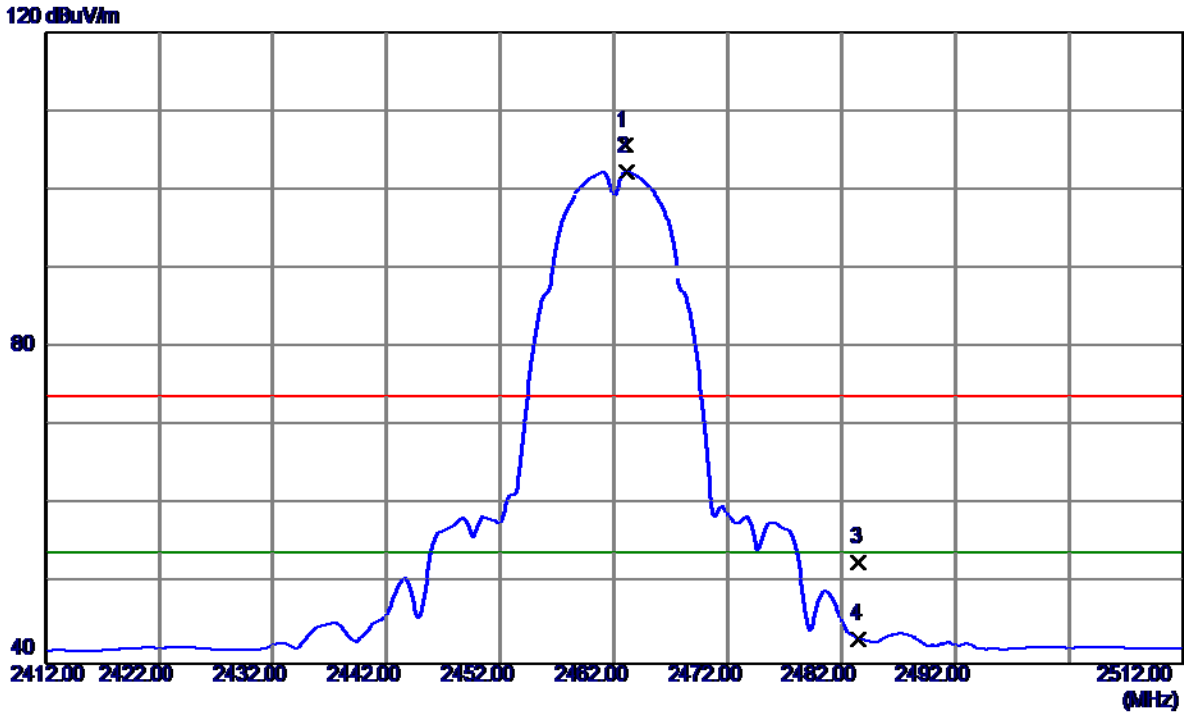

No.	Freq. MHz	Reading Level dBuV/m	Correct Factor dB	Measure ment dBuV/m	Limit dBuV/m	Margin dB	Detector	Comment
1	2463.0000	72.33	33.32	105.65	74.00	31.65	Peak	No Limit
2 *	2463.1000	68.97	33.32	102.29	54.00	48.29	AVG	No Limit
3	2483.5000	19.33	33.40	52.73	74.00	-21.27	Peak	
4	2483.5000	9.64	33.40	43.04	54.00	-10.96	AVG	

Orthogonal Axis :	X
Test Mode :	TX B MODE 2462MHz

Horizontal

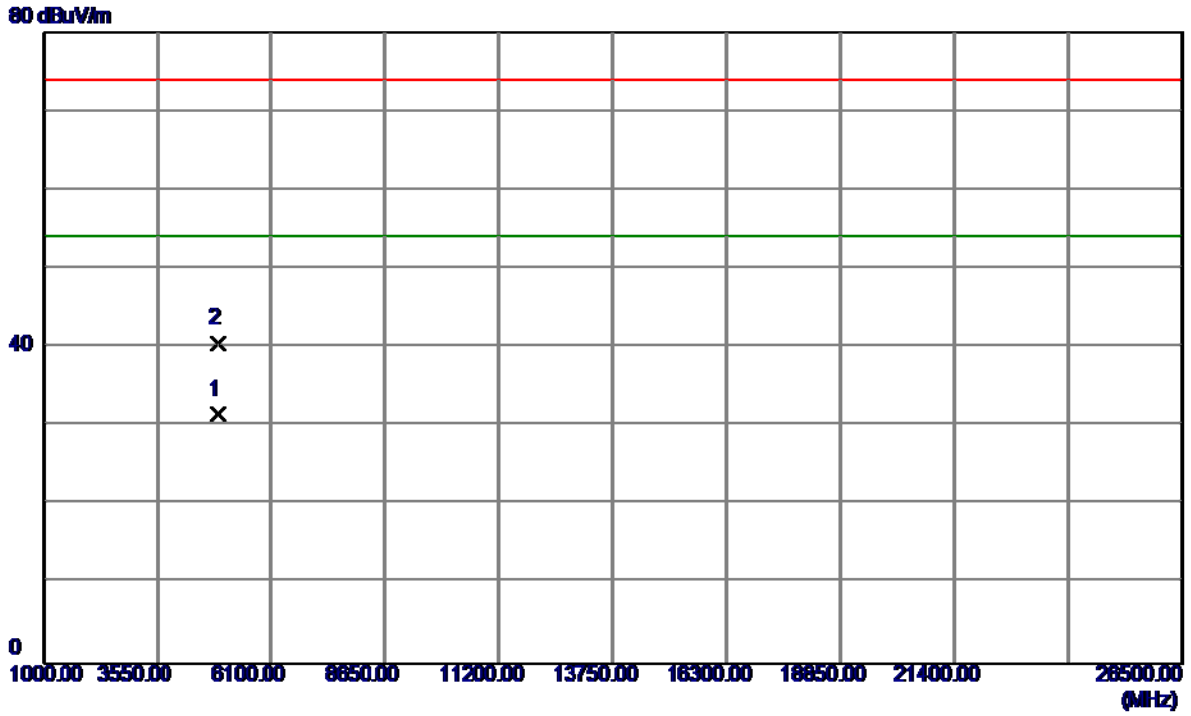

No.	Freq. MHz	Reading Level dBuV/m	Correct Factor dB	Measure ment dBuV/m	Limit dBuV/m	Margin dB	Detector	Comment
1 *	4923.9600	26.20	5.28	31.48	54.00	-22.52	AVG	
2	4924.0500	35.23	5.28	40.51	74.00	-33.49	Peak	

Orthogonal Axis :	X
Test Mode :	TX G MODE 2412MHz

Vertical

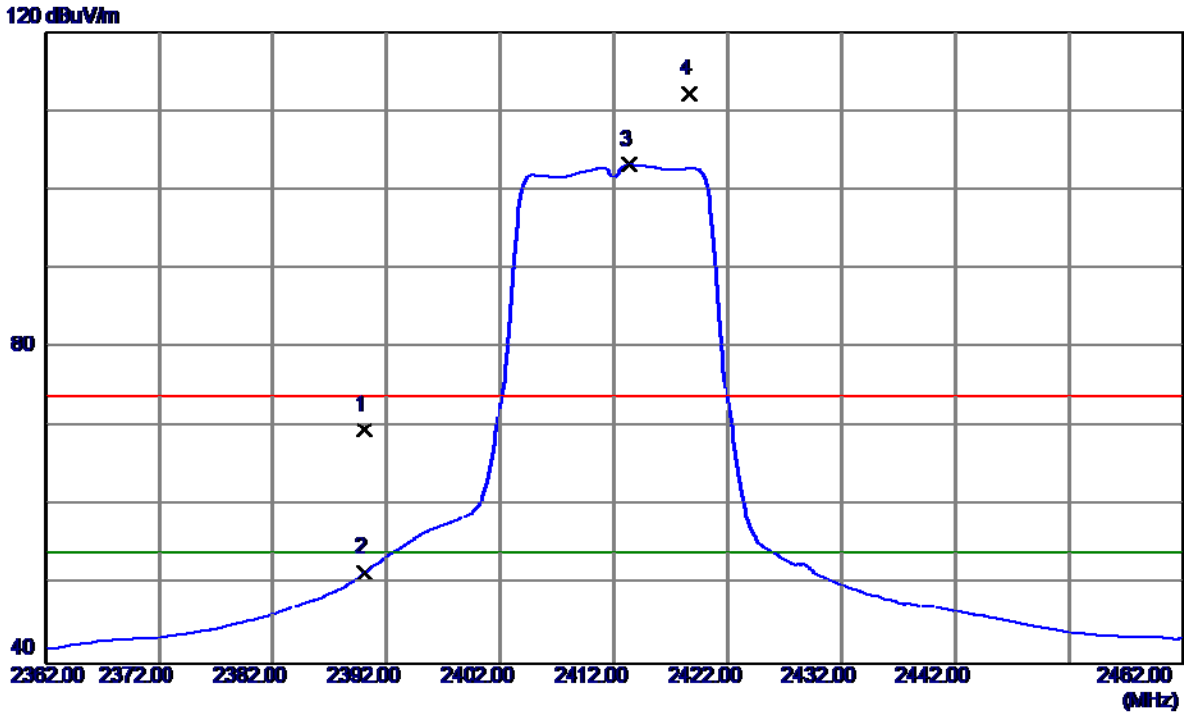

No.	Freq. MHz	Reading Level dBuV/m	Correct Factor dB	Measure ment dBuV/m	Limit dBuV/m	Margin dB	Detector	Comment
1	2390.0000	36.65	33.01	69.66	74.00	-4.34	Peak	
2	2390.0000	18.54	33.01	51.55	54.00	-2.45	AVG	
3 *	2413.3000	70.03	33.11	103.14	54.00	49.14	AVG	No Limit
4	2418.7000	79.01	33.13	112.14	74.00	38.14	Peak	No Limit

Orthogonal Axis :	X
Test Mode :	TX G MODE 2412MHz

Vertical

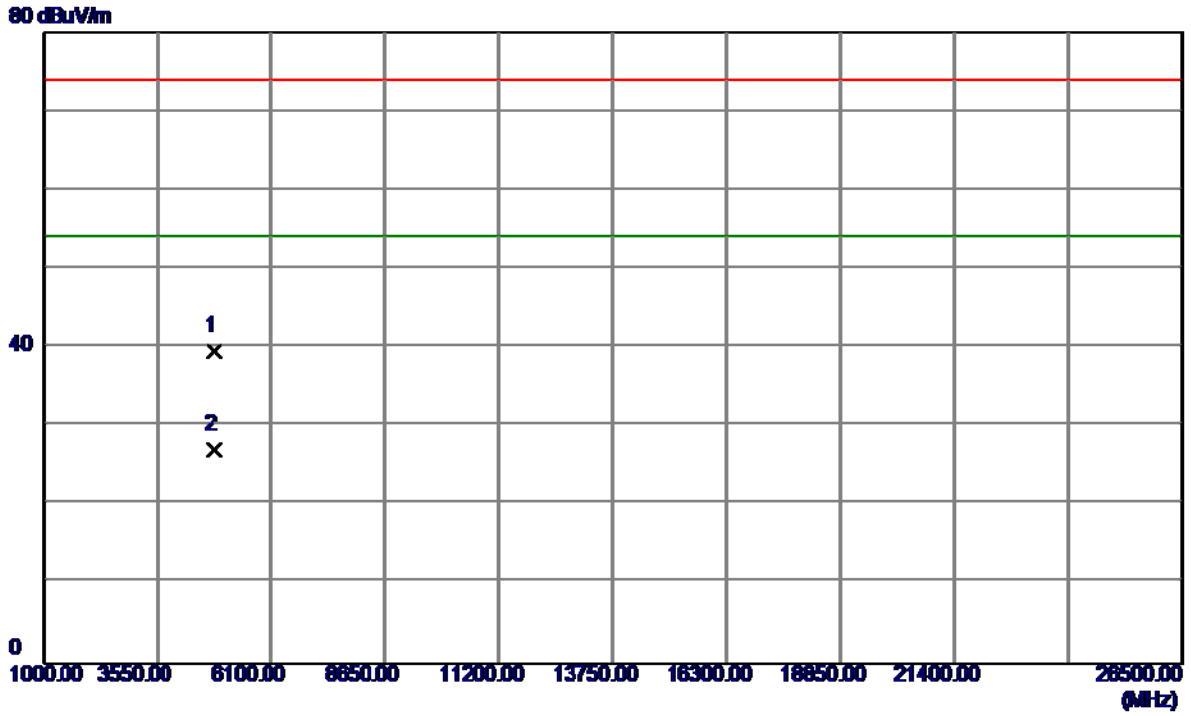

No.	Freq. MHz	Reading Level dBuV/m	Correct Factor dB	Measure ment dBuV/m	Limit dBuV/m	Margin dB	Detector	Comment
1	4822.2450	34.70	4.85	39.55	74.00	-34.45	Peak	
2 *	4823.8250	22.19	4.85	27.04	54.00	-26.96	AVG	

Orthogonal Axis :	X
Test Mode :	TX G MODE 2412MHz

Horizontal

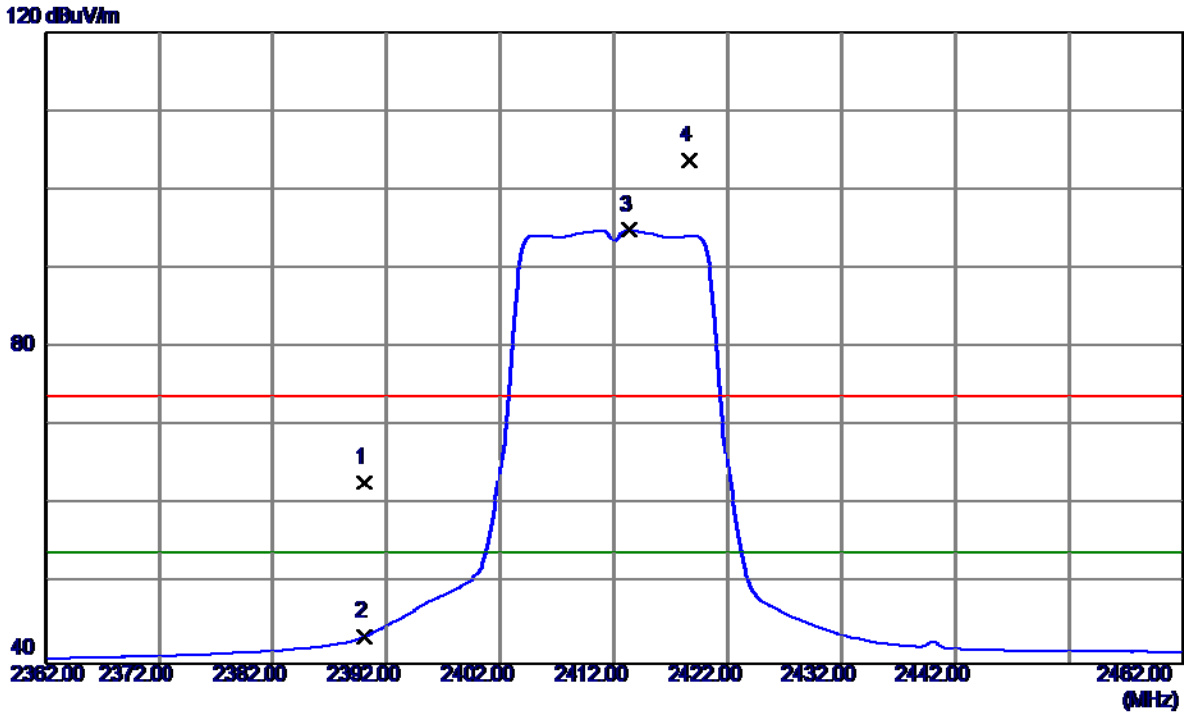

No.	Freq. MHz	Reading Level dBuV/m	Correct Factor dB	Measure ment dBuV/m	Limit dBuV/m	Margin dB	Detector	Comment
1	2390.0000	29.80	33.01	62.81	74.00	-11.19	Peak	
2	2390.0000	10.40	33.01	43.41	54.00	-10.59	AVG	
3 *	2413.3000	61.70	33.11	94.81	54.00	40.81	AVG	No Limit
4	2418.7000	70.59	33.13	103.72	74.00	29.72	Peak	No Limit

Orthogonal Axis :	X
Test Mode :	TX G MODE 2412MHz

Horizontal

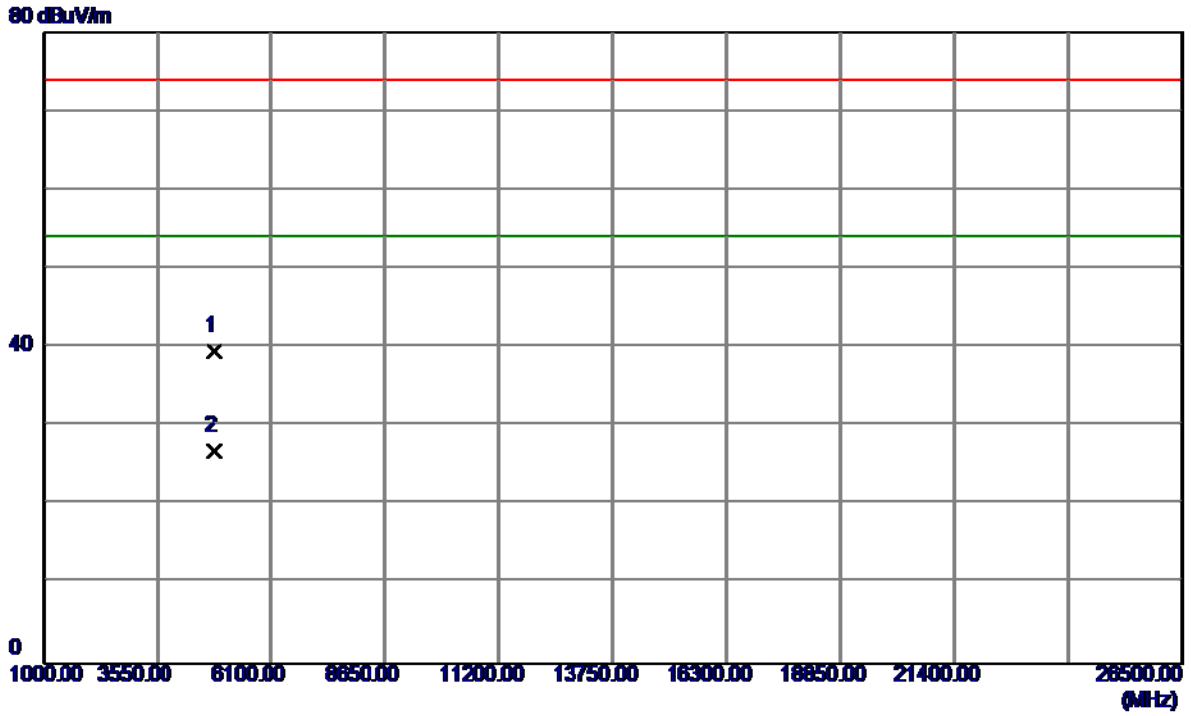

No.	Freq. MHz	Reading Level dBuV/m	Correct Factor dB	Measure ment dBuV/m	Limit dBuV/m	Margin dB	Detector	Comment
1	4822.5050	34.60	4.85	39.45	74.00	-34.55	Peak	
2 *	4826.1650	22.07	4.86	26.93	54.00	-27.07	AVG	

Orthogonal Axis :	X
Test Mode :	TX G MODE 2437MHz

Vertical

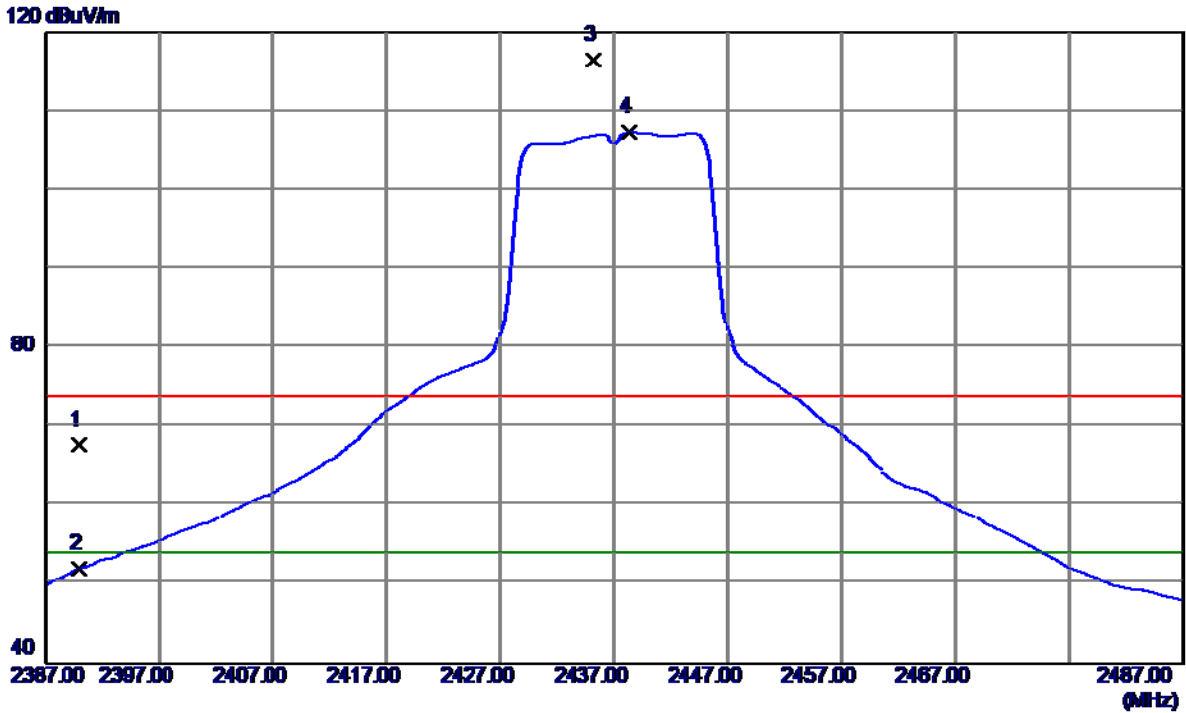

No.	Freq. MHz	Reading Level dBuV/m	Correct Factor dB	Measure ment dBuV/m	Limit dBuV/m	Margin dB	Detector	Comment
1	2390.0000	34.71	33.01	67.72	74.00	-6.28	Peak	
2	2390.0000	18.98	33.01	51.99	54.00	-2.01	AVG	
3	2435.2000	83.26	33.20	116.46	74.00	42.46	Peak	No Limit
4 *	2438.3000	74.13	33.21	107.34	54.00	53.34	AVG	No Limit

Orthogonal Axis :	X
Test Mode :	TX G MODE 2437MHz

Vertical

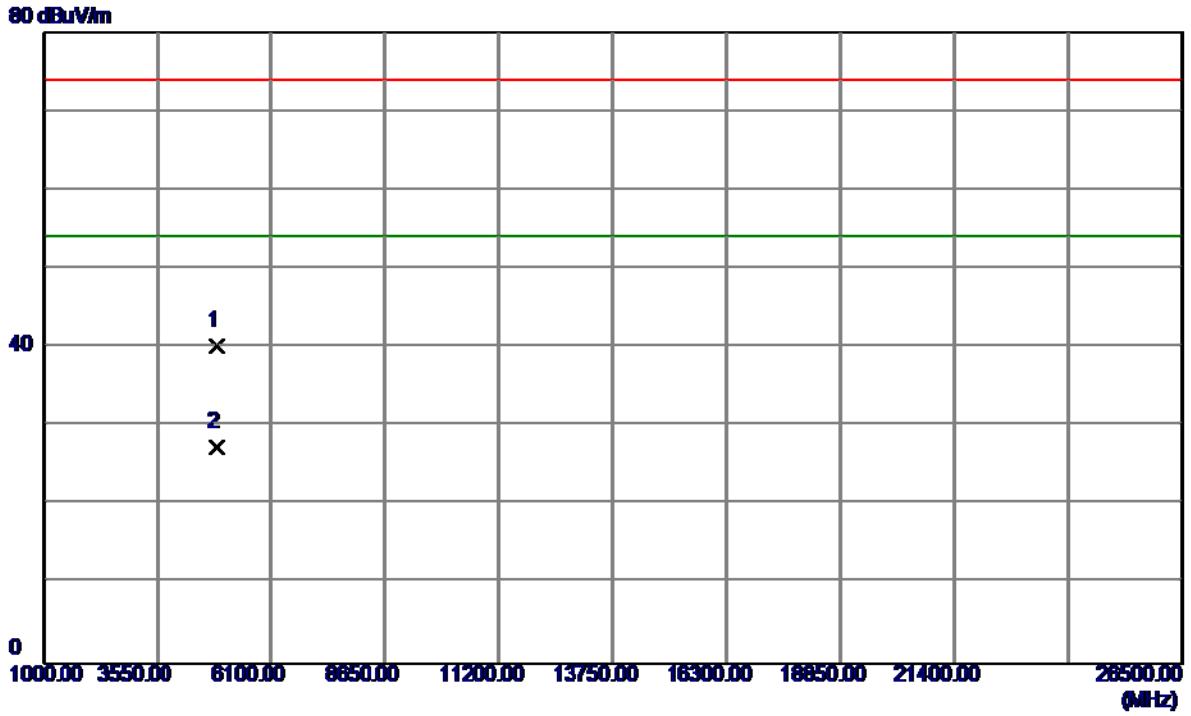

No.	Freq. MHz	Reading Level dBuV/m	Correct Factor dB	Measure ment dBuV/m	Limit dBuV/m	Margin dB	Detector	Comment
1	4873.4900	35.14	5.06	40.20	74.00	-33.80	Peak	
2 *	4873.9850	22.26	5.07	27.33	54.00	-26.67	AVG	

Orthogonal Axis :	X
Test Mode :	TX G MODE 2437MHz

Horizontal

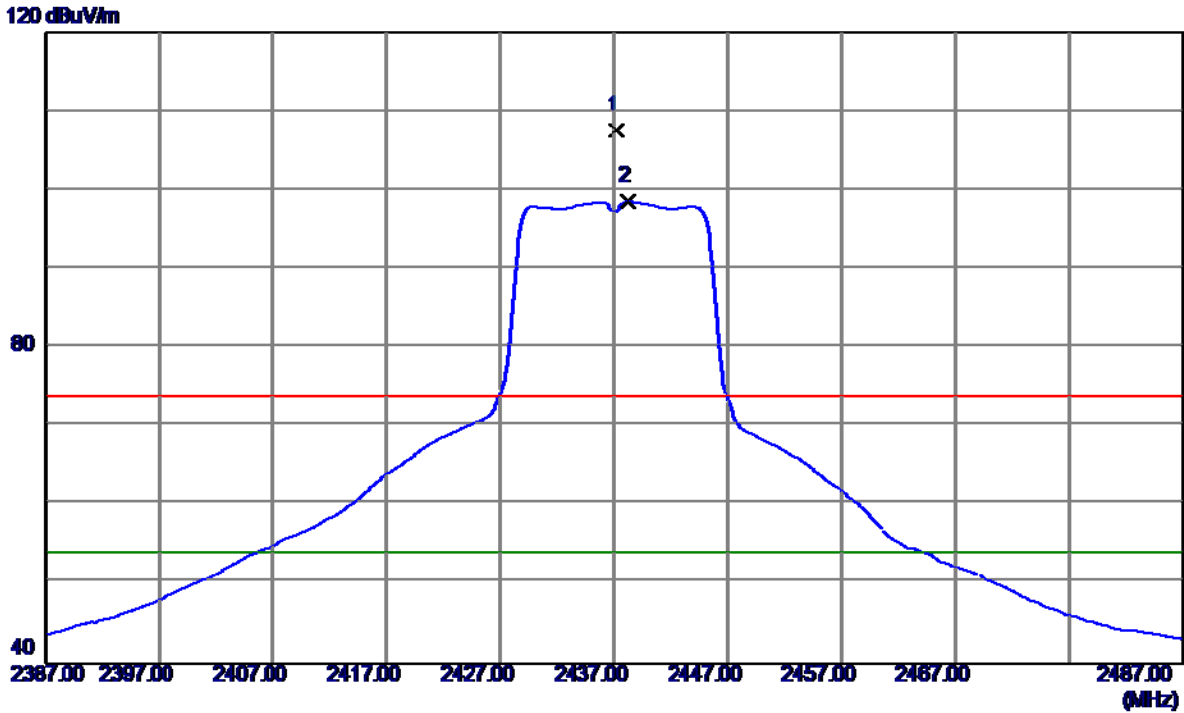

No.	Freq. MHz	Reading Level dBuV/m	Correct Factor dB	Measure ment dBuV/m	Limit dBuV/m	Margin dB	Detector	Comment
1	2437.2000	74.39	33.21	107.60	74.00	33.60	Peak	No Limit
2 *	2438.2000	65.32	33.21	98.53	54.00	44.53	AVG	No Limit

Orthogonal Axis :	X
Test Mode :	TX G MODE 2437MHz

Horizontal

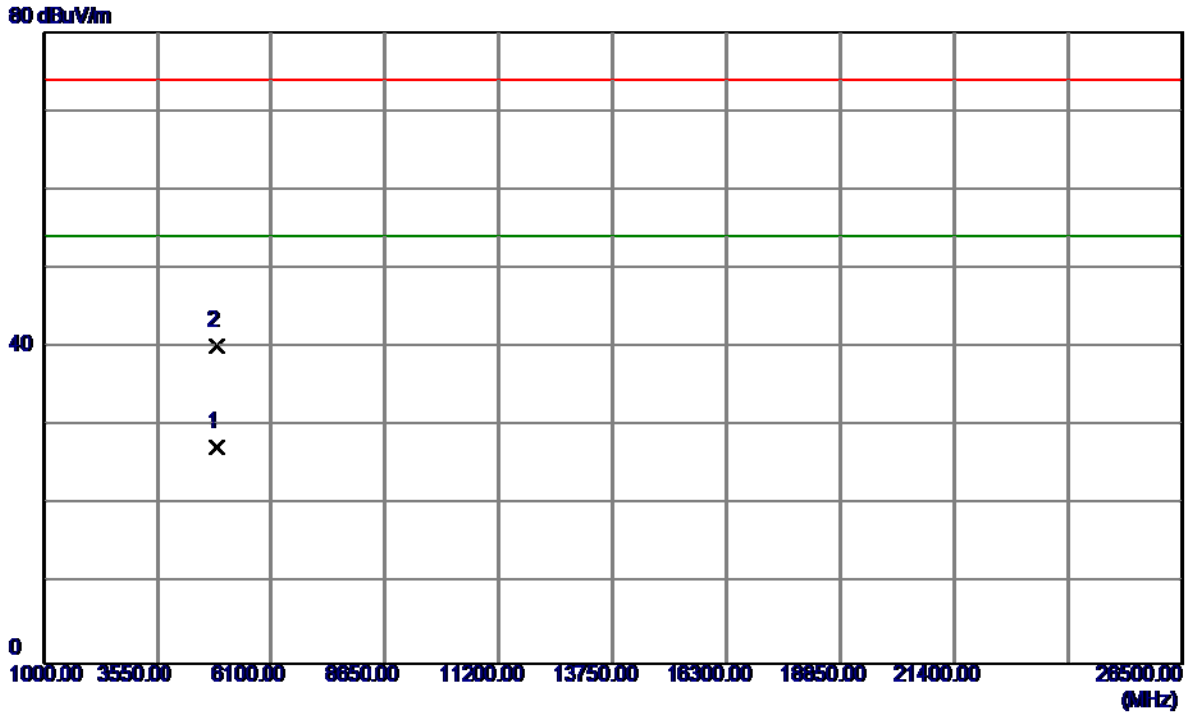

No.	Freq. MHz	Reading Level dBuV/m	Correct Factor dB	Measure ment dBuV/m	Limit dBuV/m	Margin dB	Detector	Comment
1 *	4874.0150	22.29	5.07	27.36	54.00	-26.64	AVG	
2	4874.8600	35.03	5.07	40.10	74.00	-33.90	Peak	

Orthogonal Axis :	X
Test Mode :	TX G MODE 2462MHz

Vertical

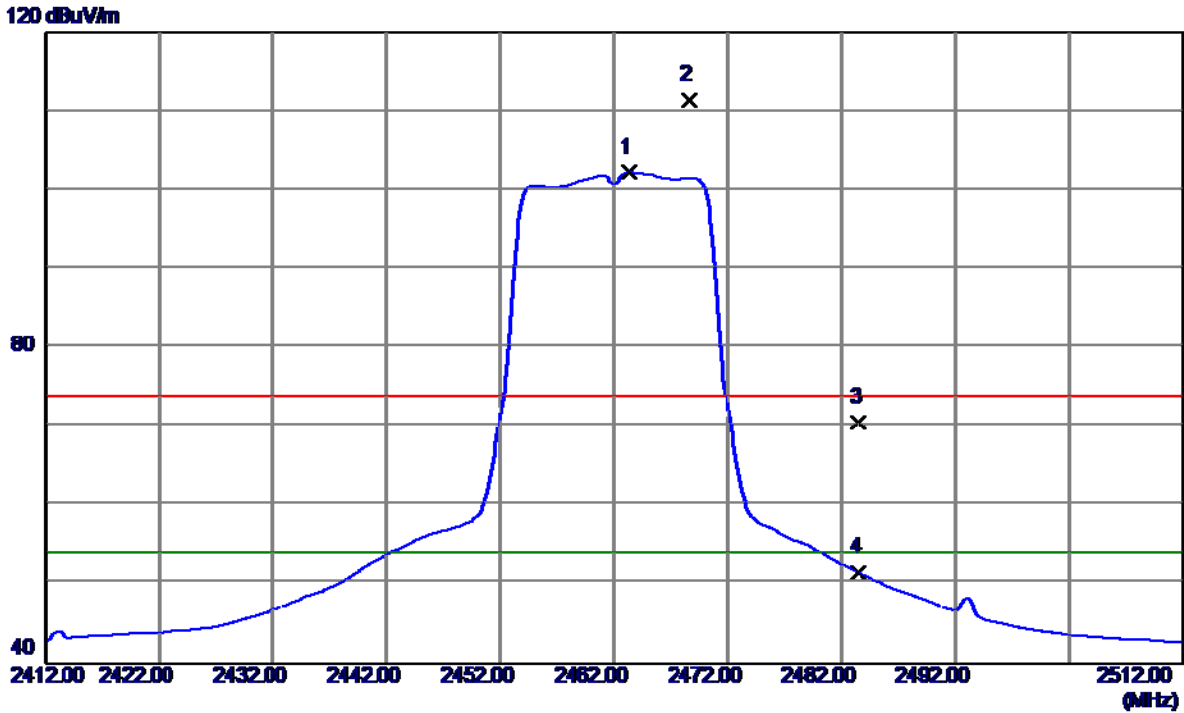

No.	Freq. MHz	Reading Level dBuV/m	Correct Factor dB	Measure ment dBuV/m	Limit dBuV/m	Margin dB	Detector	Comment
1 *	2463.3000	68.86	33.32	102.18	54.00	48.18	AVG	No Limit
2	2468.7000	78.03	33.34	111.37	74.00	37.37	Peak	No Limit
3	2483.5000	37.13	33.40	70.53	74.00	-3.47	Peak	
4	2483.5000	18.08	33.40	51.48	54.00	-2.52	AVG	

Orthogonal Axis :	X
Test Mode :	TX G MODE 2462MHz

Vertical

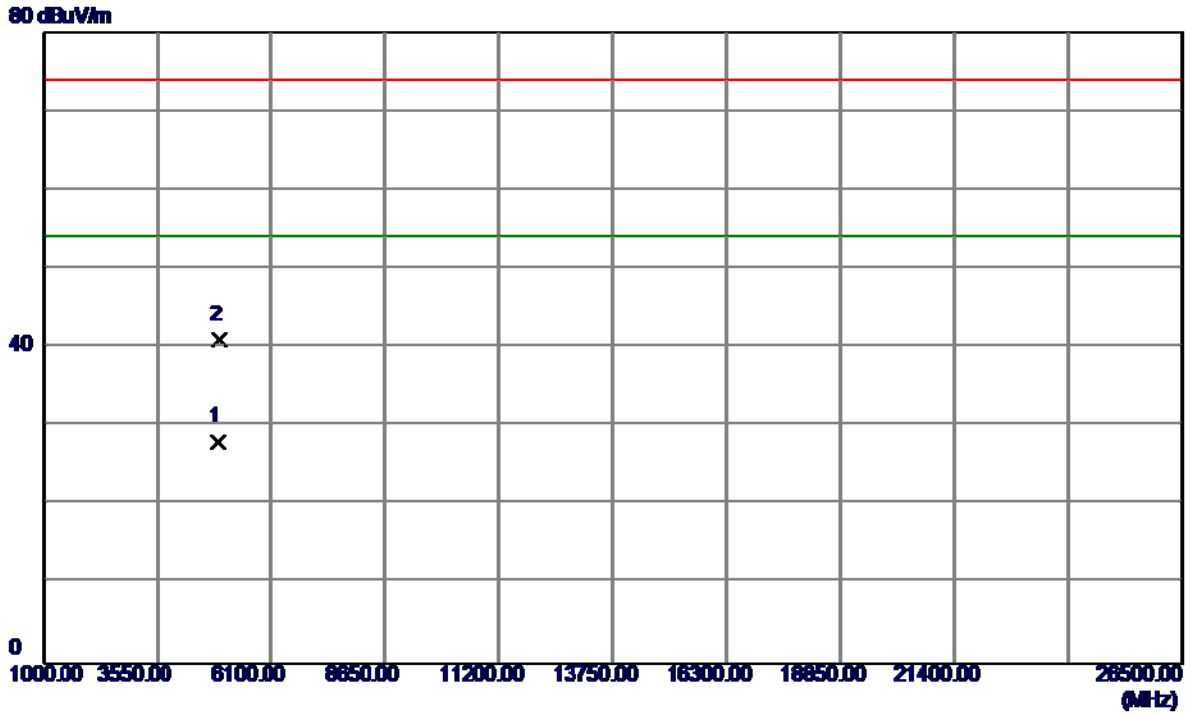

No.	Freq. MHz	Reading Level dBuV/m	Correct Factor dB	Measure ment dBuV/m	Limit dBuV/m	Margin dB	Detector	Comment
1 *	4923.3600	22.79	5.27	28.06	54.00	-25.94	AVG	
2	4924.8250	35.74	5.28	41.02	74.00	-32.98	Peak	

Orthogonal Axis :	X
Test Mode :	TX G MODE 2462MHz

Horizontal

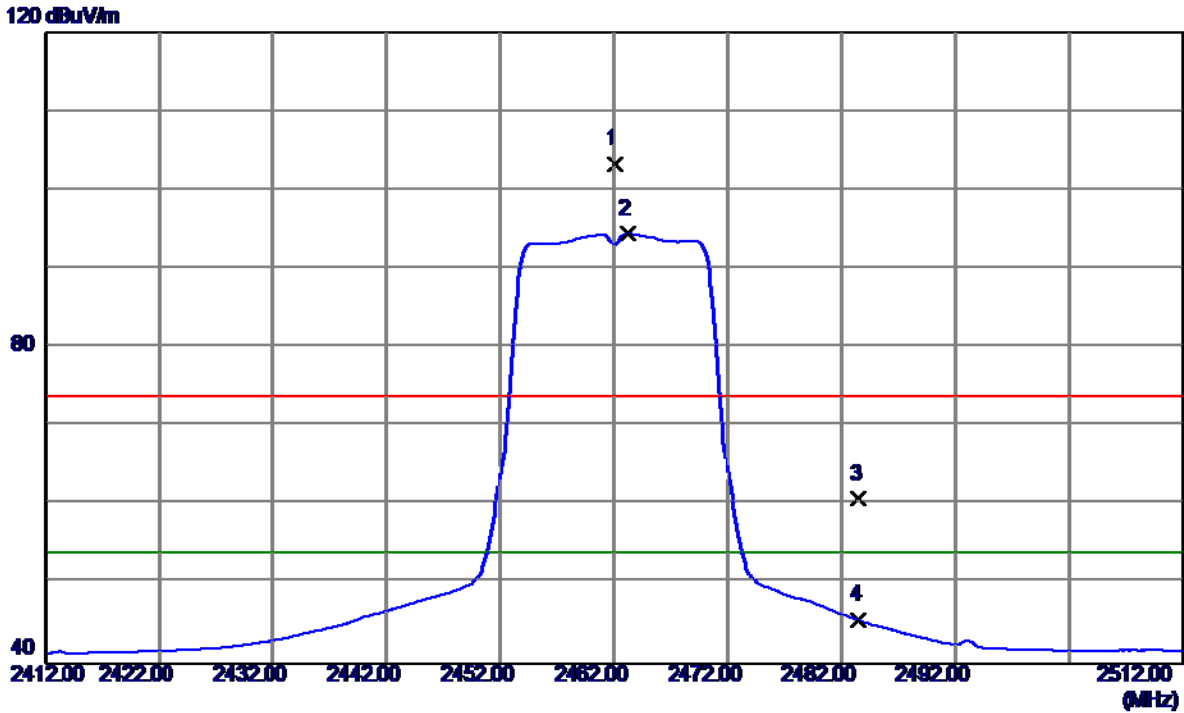

No.	Freq. MHz	Reading Level dBuV/m	Correct Factor dB	Measure ment dBuV/m	Limit dBuV/m	Margin dB	Detector	Comment
1	2462.1000	69.87	33.31	103.18	74.00	29.18	Peak	No Limit
2 *	2463.2000	61.02	33.32	94.34	54.00	40.34	AVG	No Limit
3	2483.5000	27.41	33.40	60.81	74.00	-13.19	Peak	
4	2483.5000	12.00	33.40	45.40	54.00	-8.60	AVG	

Orthogonal Axis :	X
Test Mode :	TX G MODE 2462MHz

Horizontal

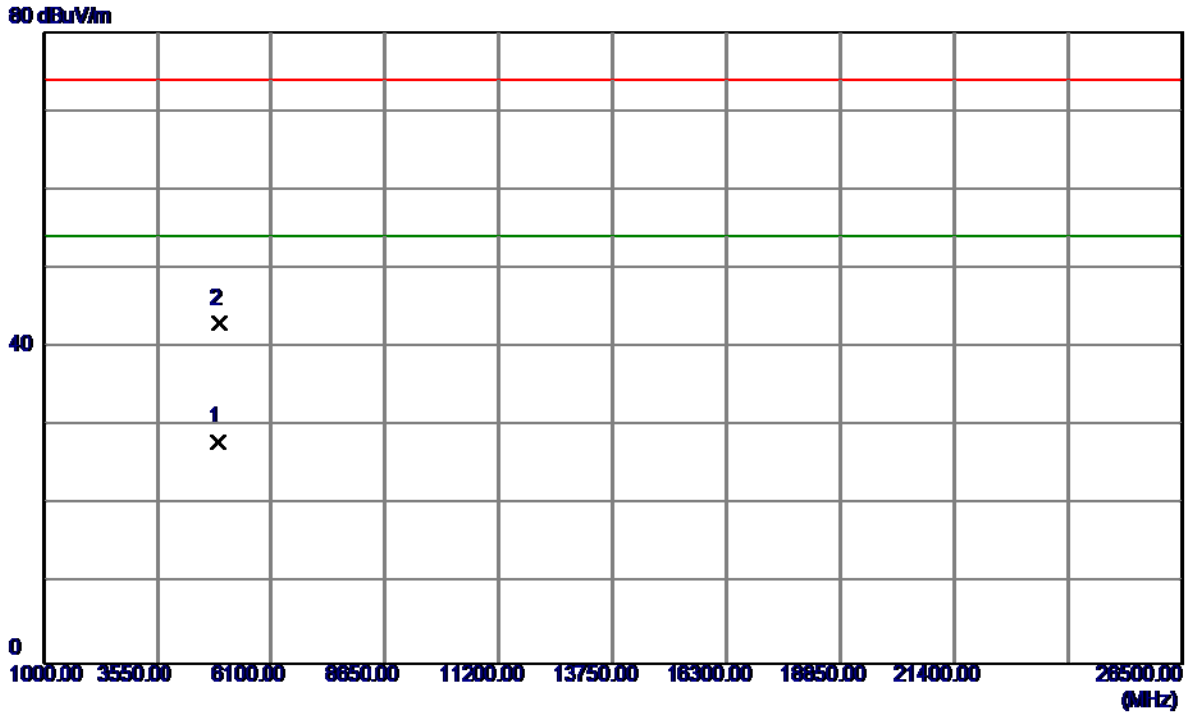

No.	Freq. MHz	Reading Level dBuV/m	Correct Factor dB	Measure ment dBuV/m	Limit dBuV/m	Margin dB	Detector	Comment
1 *	4923.9950	22.76	5.28	28.04	54.00	-25.96	AVG	
2	4926.2900	37.68	5.29	42.97	74.00	-31.03	Peak	

Orthogonal Axis :	X
Test Mode :	TX N-20M MODE 2412MHz

Vertical

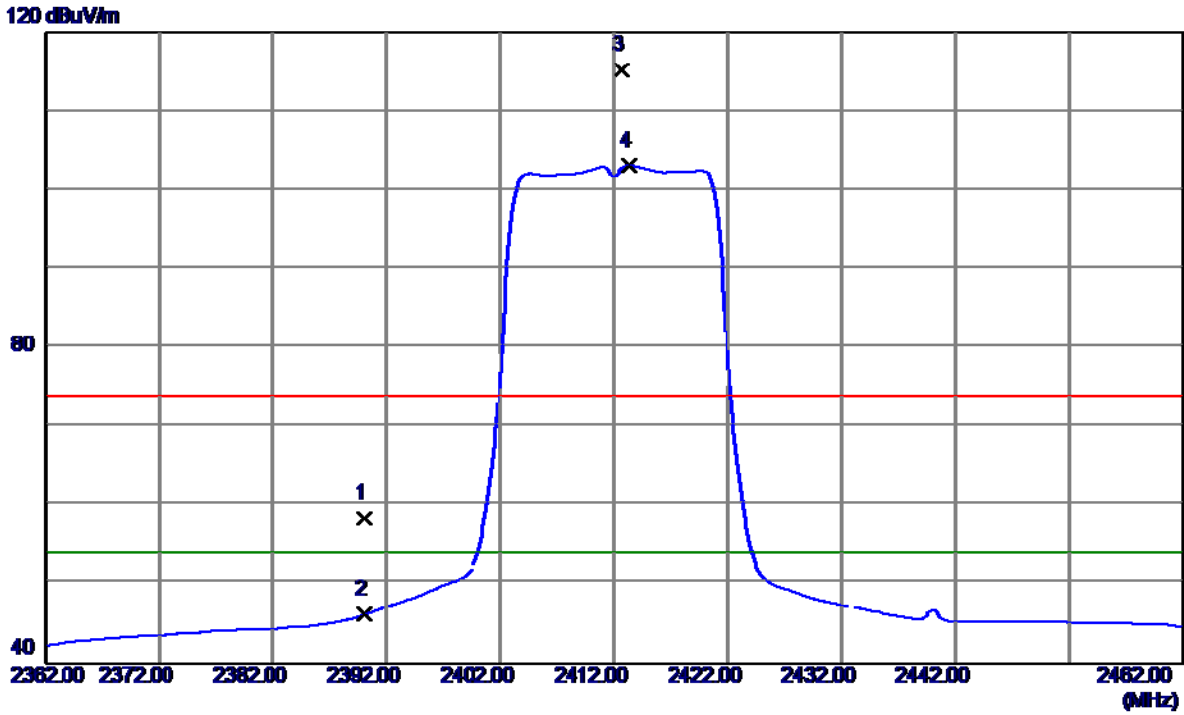

No.	Freq. MHz	Reading Level dBuV/m	Correct Factor dB	Measure ment dBuV/m	Limit dBuV/m	Margin dB	Detector	Comment
1	2390.0000	25.38	33.01	58.39	74.00	-15.61	Peak	
2	2390.0000	13.17	33.01	46.18	54.00	-7.82	AVG	
3	2412.7000	82.05	33.11	115.16	74.00	41.16	Peak	No Limit
4 *	2413.3000	69.96	33.11	103.07	54.00	49.07	AVG	No Limit

Orthogonal Axis :	X
Test Mode :	TX N-20M MODE 2412MHz

Vertical

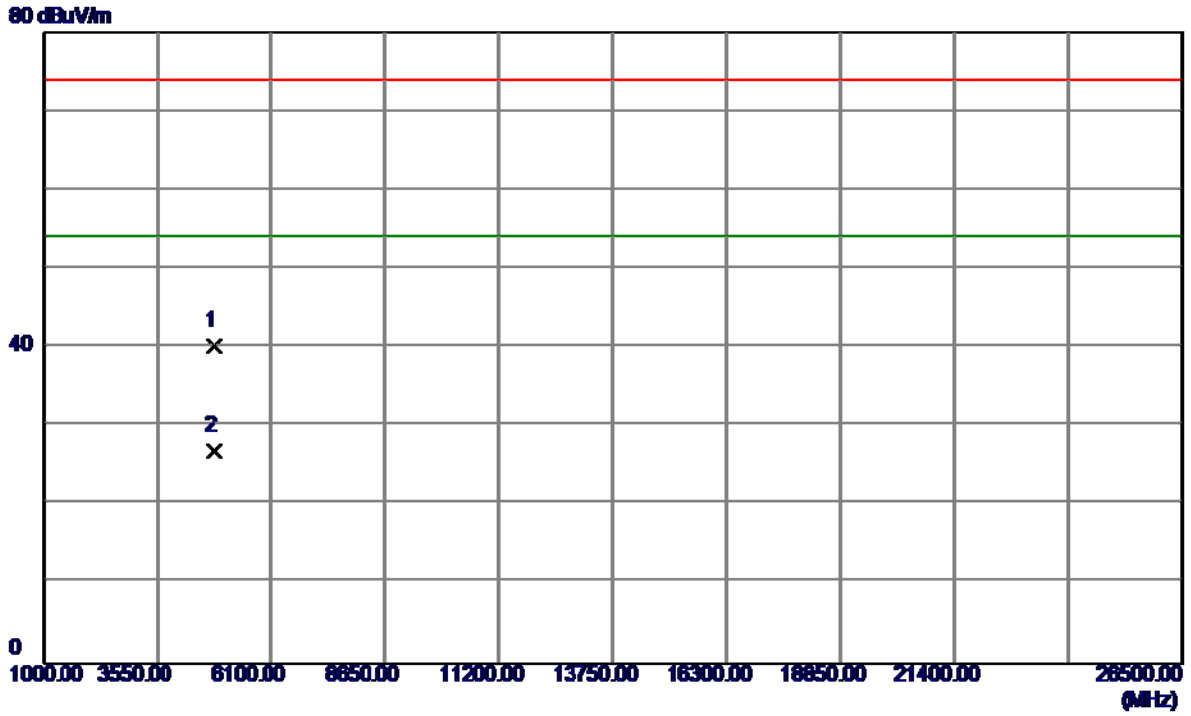

No.	Freq. MHz	Reading Level dBuV/m	Correct Factor dB	Measure ment dBuV/m	Limit dBuV/m	Margin dB	Detector	Comment
1	4824.1000	35.36	4.85	40.21	74.00	-33.79	Peak	
2 *	4824.9200	22.08	4.86	26.94	54.00	-27.06	AVG	

Orthogonal Axis :	X
Test Mode :	TX N-20M MODE 2412MHz

Horizontal

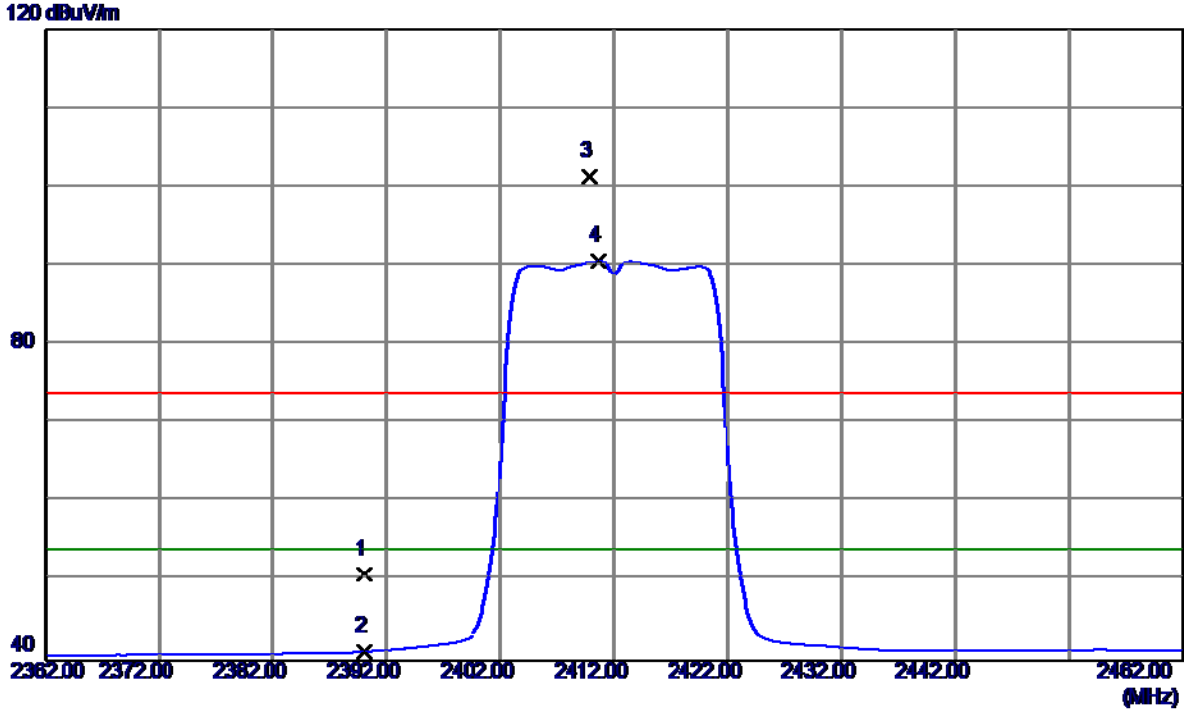

No.	Freq. MHz	Reading Level dBuV/m	Correct Factor dB	Measure ment dBuV/m	Limit dBuV/m	Margin dB	Detector	Comment
1	2390.0000	17.80	33.01	50.81	74.00	-23.19	Peak	
2	2390.0000	8.13	33.01	41.14	54.00	-12.86	AVG	
3	2409.9000	68.18	33.09	101.27	74.00	27.27	Peak	No Limit
4 *	2410.7000	57.40	33.10	90.50	54.00	36.50	AVG	No Limit

Orthogonal Axis :	X
Test Mode :	TX N-20M MODE 2412MHz

Horizontal

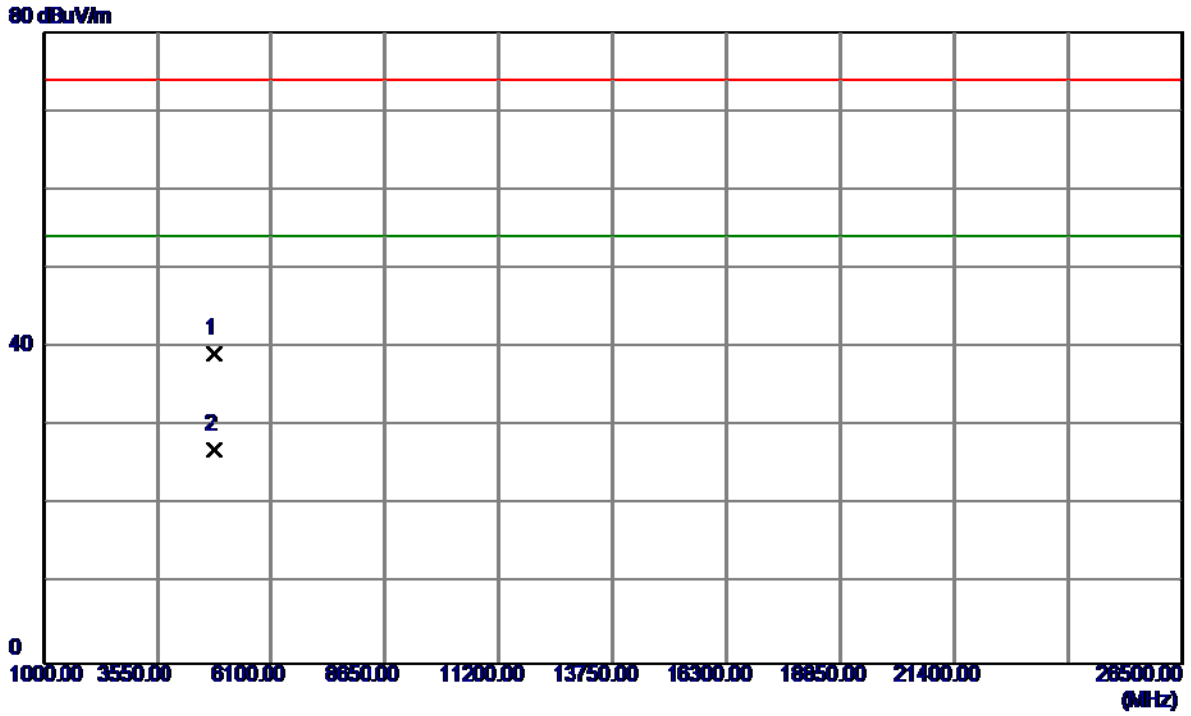

No.	Freq. MHz	Reading Level dBuV/m	Correct Factor dB	Measure ment dBuV/m	Limit dBuV/m	Margin dB	Detector	Comment
1	4824.4300	34.38	4.86	39.24	74.00	-34.76	Peak	
2 *	4824.8100	22.16	4.86	27.02	54.00	-26.98	AVG	

Orthogonal Axis :	X
Test Mode :	TX N-20M MODE 2437MHz

Vertical

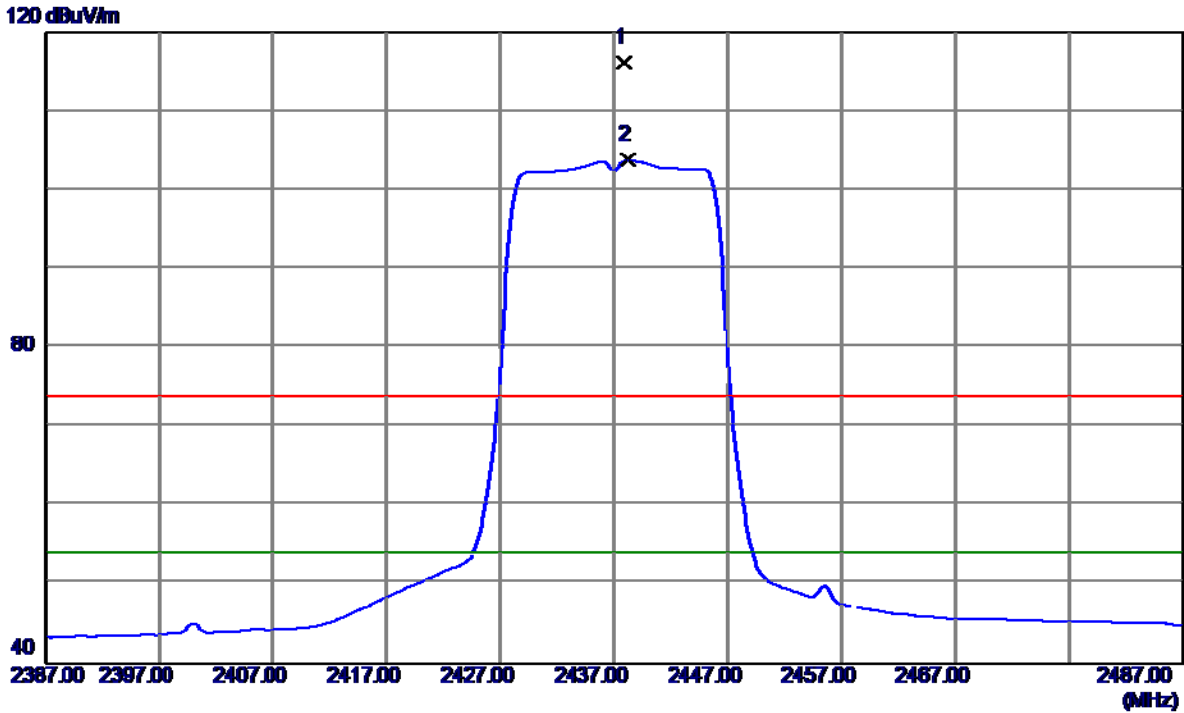

No.	Freq. MHz	Reading Level dBuV/m	Correct Factor dB	Measure ment dBuV/m	Limit dBuV/m	Margin dB	Detector	Comment
1	2437.9000	82.98	33.21	116.19	74.00	42.19	Peak	No Limit
2 *	2438.2000	70.55	33.21	103.76	54.00	49.76	AVG	No Limit

Orthogonal Axis :	X
Test Mode :	TX N-20M MODE 2437MHz

Vertical

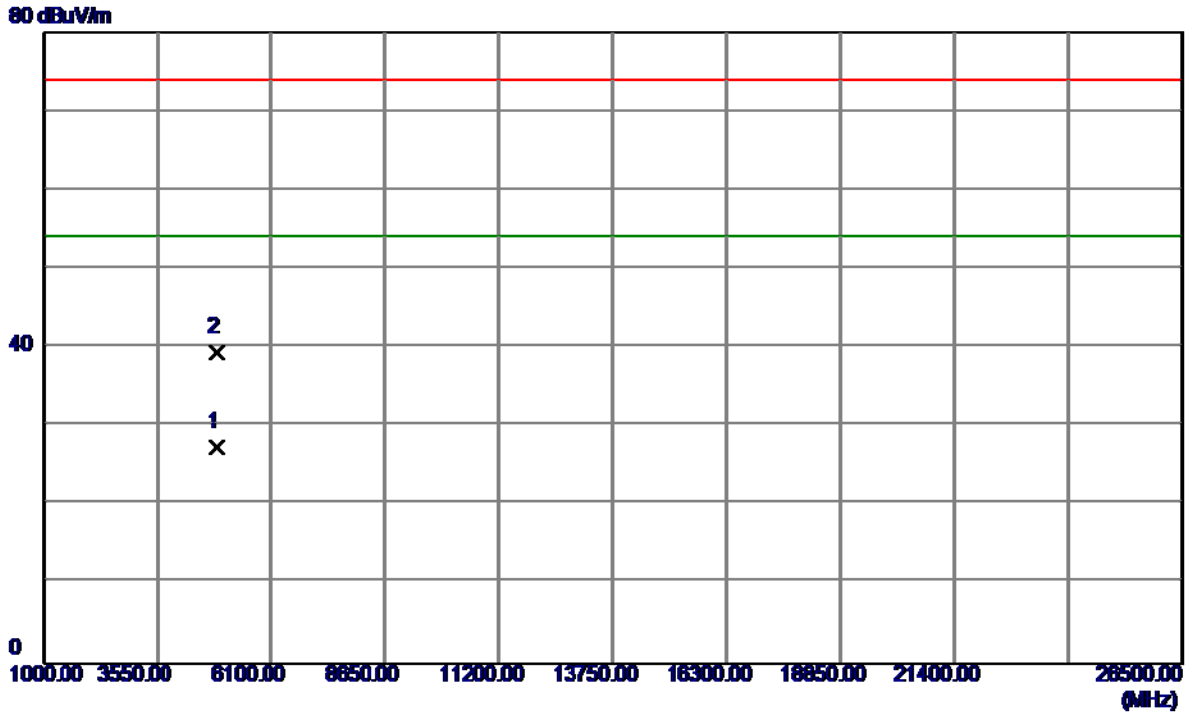

No.	Freq. MHz	Reading Level dBuV/m	Correct Factor dB	Measure ment dBuV/m	Limit dBuV/m	Margin dB	Detector	Comment
1 *	4873.7500	22.30	5.06	27.36	54.00	-26.64	AVG	
2	4874.7300	34.32	5.07	39.39	74.00	-34.61	Peak	

Orthogonal Axis :	X
Test Mode :	TX N-20M MODE 2437MHz

Horizontal

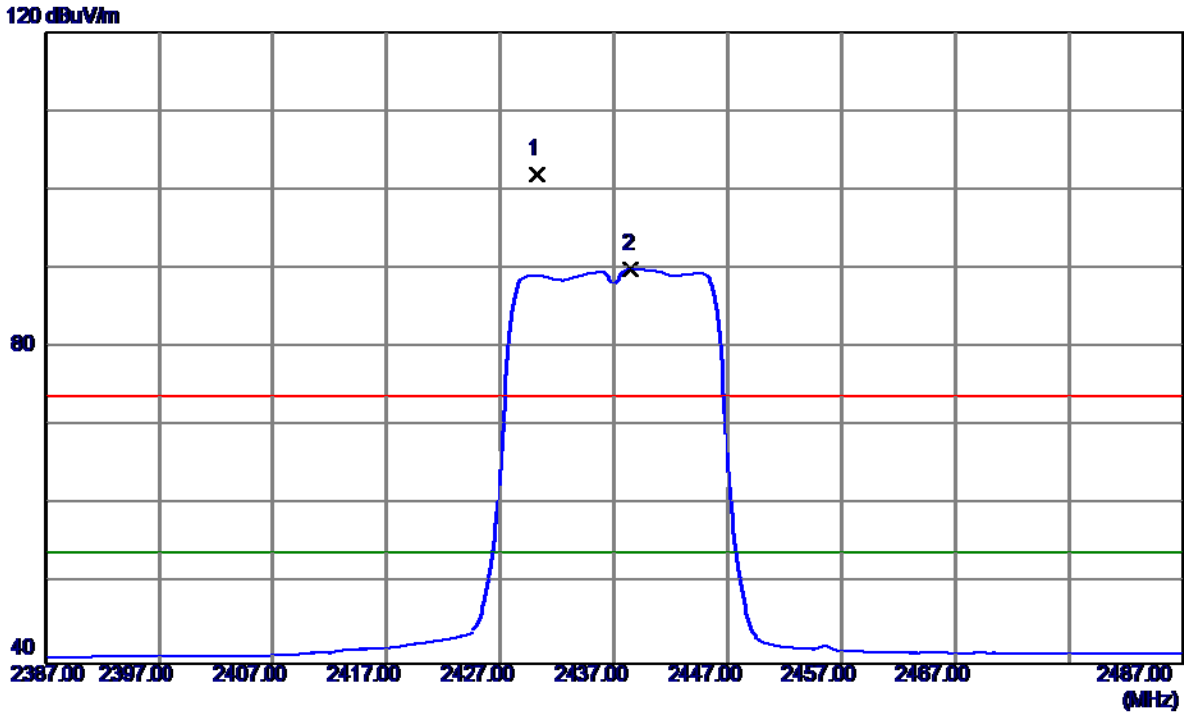

No.	Freq. MHz	Reading Level dBuV/m	Correct Factor dB	Measure ment dBuV/m	Limit dBuV/m	Margin dB	Detector	Comment
1	2430.2000	68.72	33.18	101.90	74.00	27.90	Peak	No Limit
2 *	2438.5000	56.73	33.21	89.94	54.00	35.94	AVG	No Limit

Orthogonal Axis :	X
Test Mode :	TX N-20M MODE 2437MHz

Horizontal

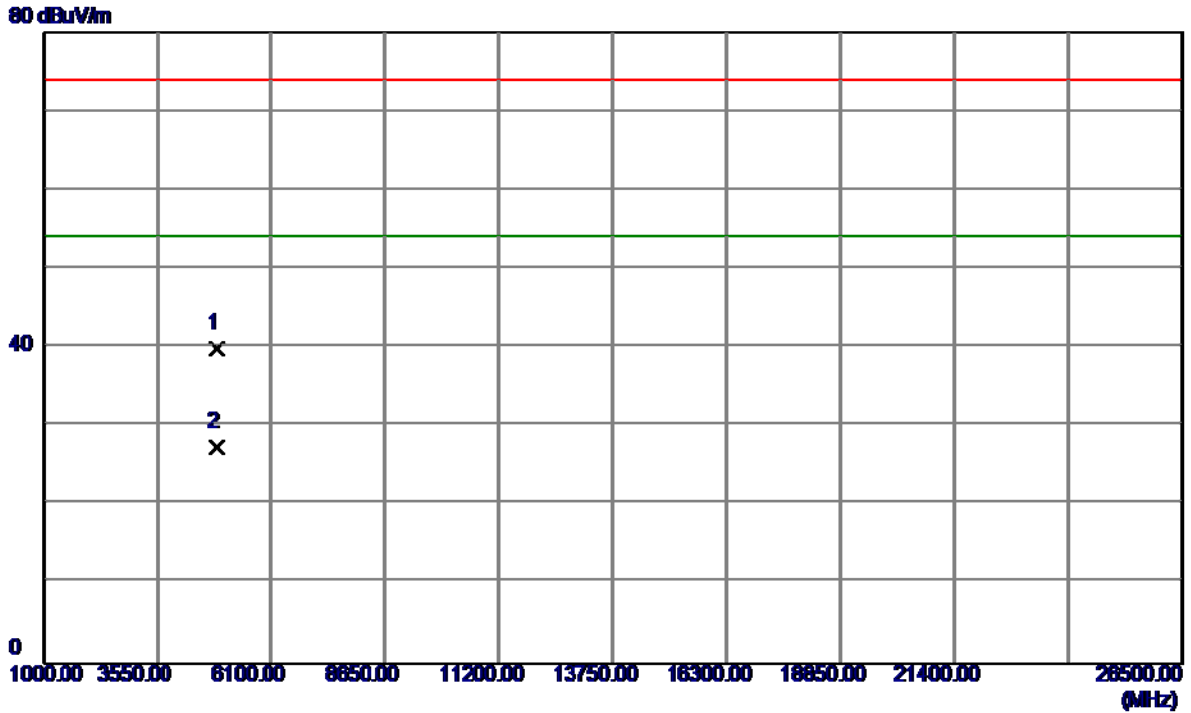

No.	Freq. MHz	Reading Level dBuV/m	Correct Factor dB	Measure ment dBuV/m	Limit dBuV/m	Margin dB	Detector	Comment
1	4872.8400	34.76	5.06	39.82	74.00	-34.18	Peak	
2 *	4874.2900	22.36	5.07	27.43	54.00	-26.57	AVG	

Orthogonal Axis :	X
Test Mode :	TX N-20M MODE 2462MHz

Vertical

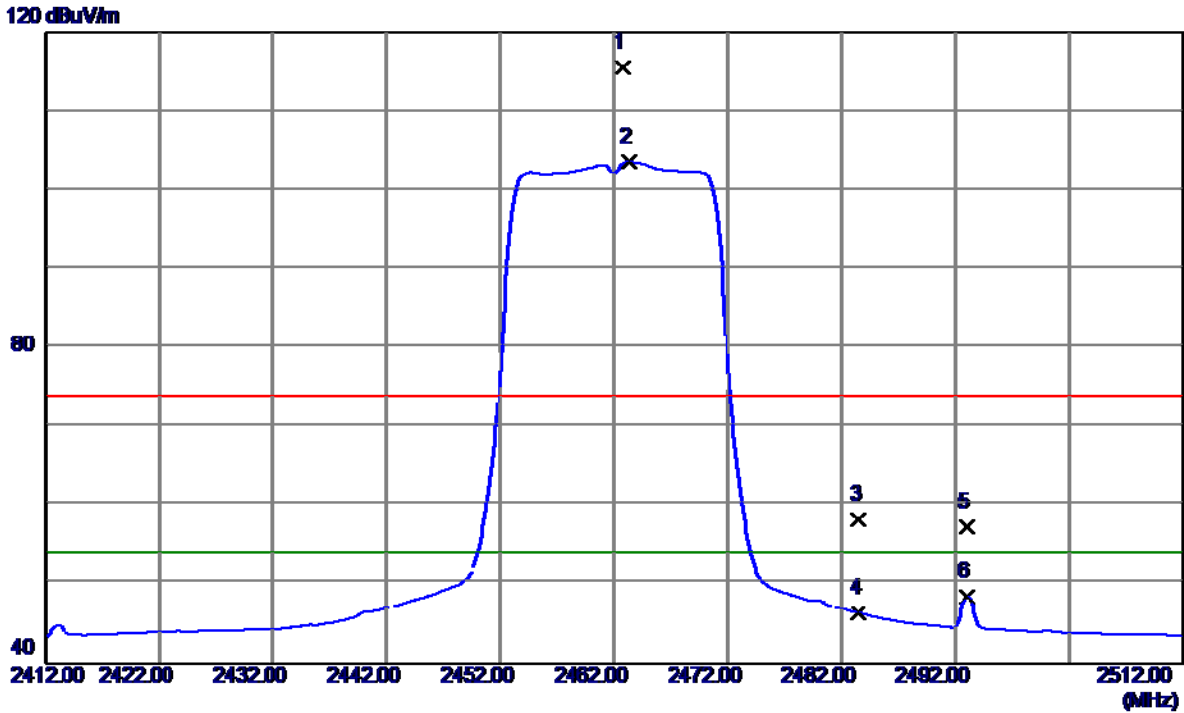

No.	Freq. MHz	Reading Level dBuV/m	Correct Factor dB	Measure ment dBuV/m	Limit dBuV/m	Margin dB	Detector	Comment
1	2462.8000	82.19	33.31	115.50	74.00	41.50	Peak	No Limit
2 *	2463.3000	70.19	33.32	103.51	54.00	49.51	AVG	No Limit
3	2483.5000	24.77	33.40	58.17	74.00	-15.83	Peak	
4	2483.5000	13.00	33.40	46.40	54.00	-7.60	AVG	
5	2493.0000	23.82	33.44	57.26	74.00	-16.74	Peak	
6	2493.0000	15.04	33.44	48.48	54.00	-5.52	AVG	

Orthogonal Axis :	X
Test Mode :	TX N-20M MODE 2462MHz

Vertical

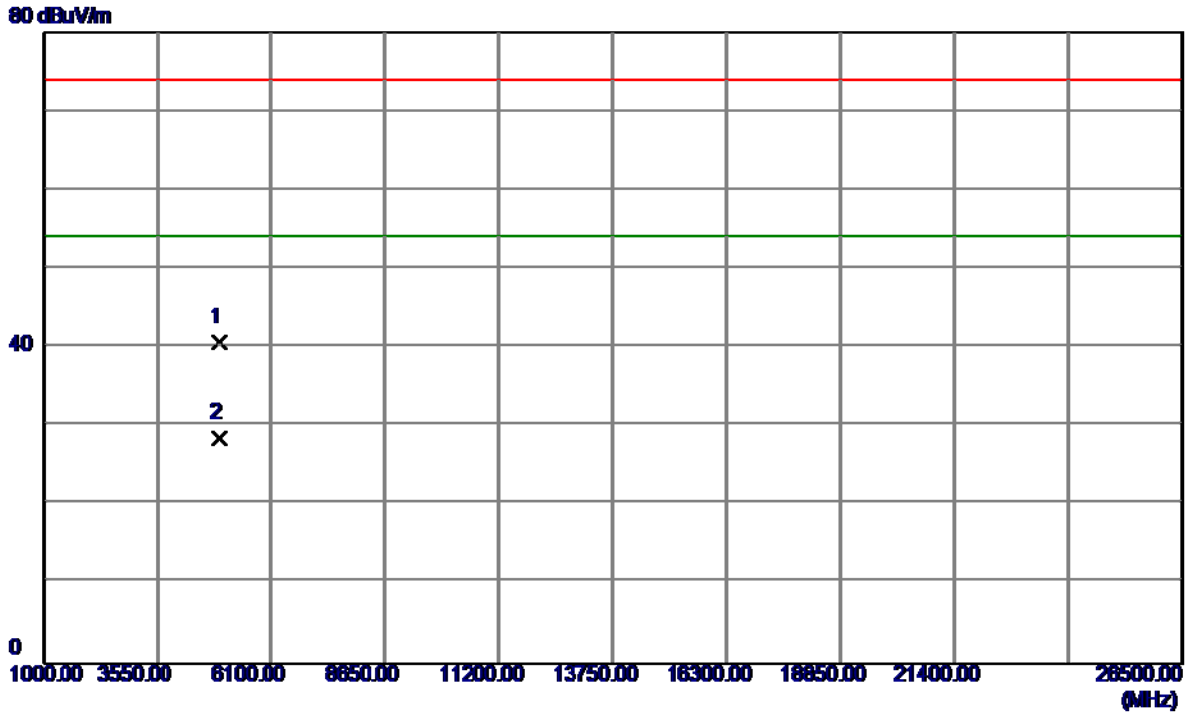

No.	Freq. MHz	Reading Level dBuV/m	Correct Factor dB	Measure ment dBuV/m	Limit dBuV/m	Margin dB	Detector	Comment
1	4925.5500	35.41	5.28	40.69	74.00	-33.31	Peak	
2 *	4947.7500	23.14	5.38	28.52	54.00	-25.48	AVG	

Orthogonal Axis :	X
Test Mode :	TX N-20M MODE 2462MHz

Horizontal

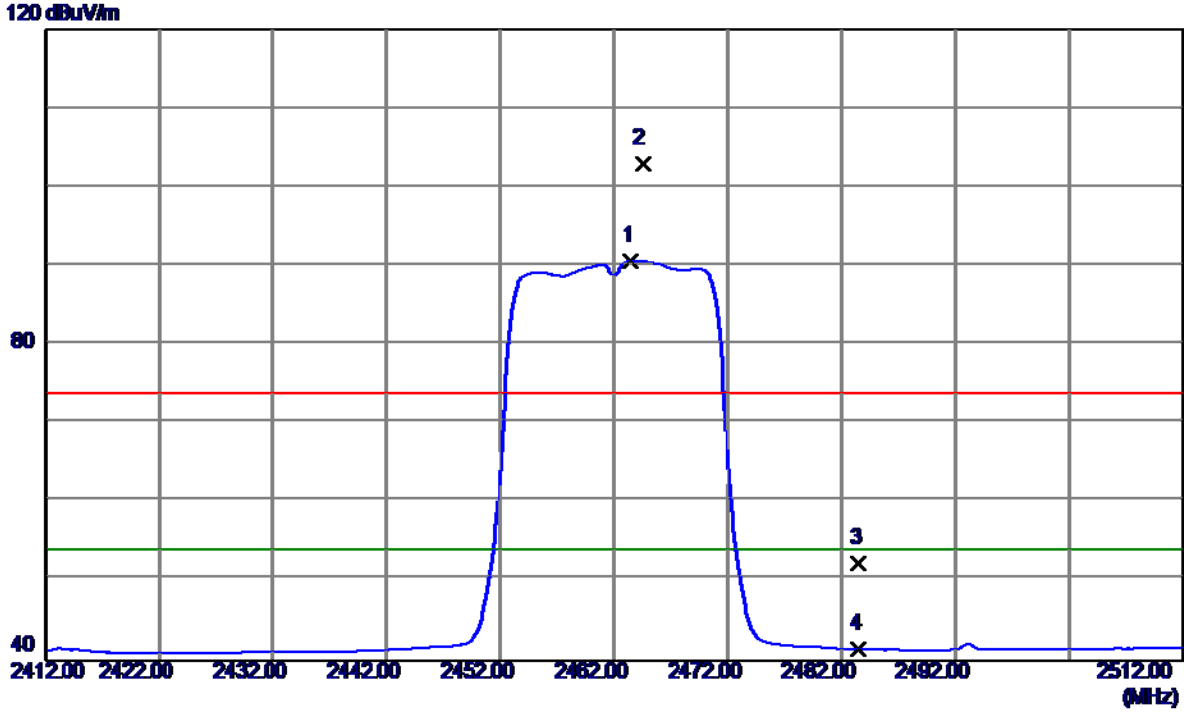

No.	Freq. MHz	Reading Level dBuV/m	Correct Factor dB	Measure ment dBuV/m	Limit dBuV/m	Margin dB	Detector	Comment
1 *	2463.5000	57.30	33.32	90.62	54.00	36.62	AVG	No Limit
2	2464.5000	69.64	33.32	102.96	74.00	28.96	Peak	No Limit
3	2483.5000	18.87	33.40	52.27	74.00	-21.73	Peak	
4	2483.5000	8.03	33.40	41.43	54.00	-12.57	AVG	

Orthogonal Axis :	X
Test Mode :	TX N-20M MODE 2462MHz

Horizontal

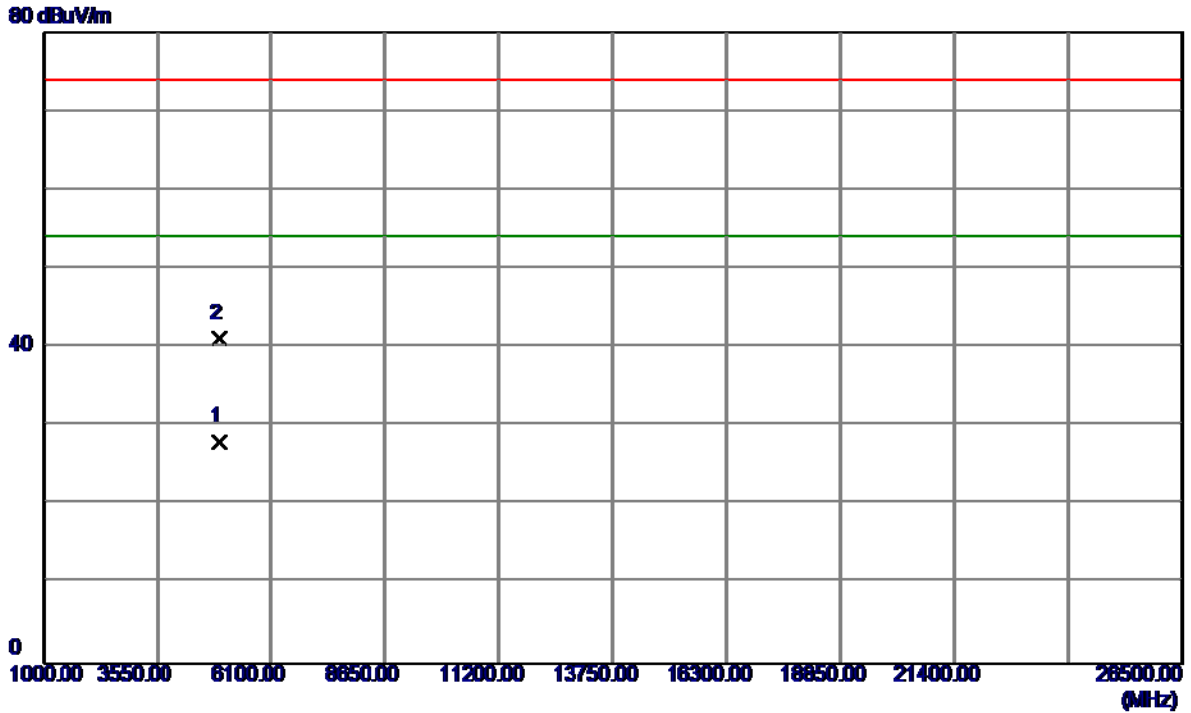

No.	Freq. MHz	Reading Level dBuV/m	Correct Factor dB	Measure ment dBuV/m	Limit dBuV/m	Margin dB	Detector	Comment
1 *	4924.5000	22.74	5.28	28.02	54.00	-25.98	AVG	
2	4925.2000	35.82	5.28	41.10	74.00	-32.90	Peak	

Orthogonal Axis :	X
Test Mode :	TX N-40M MODE 2422MHz

Vertical

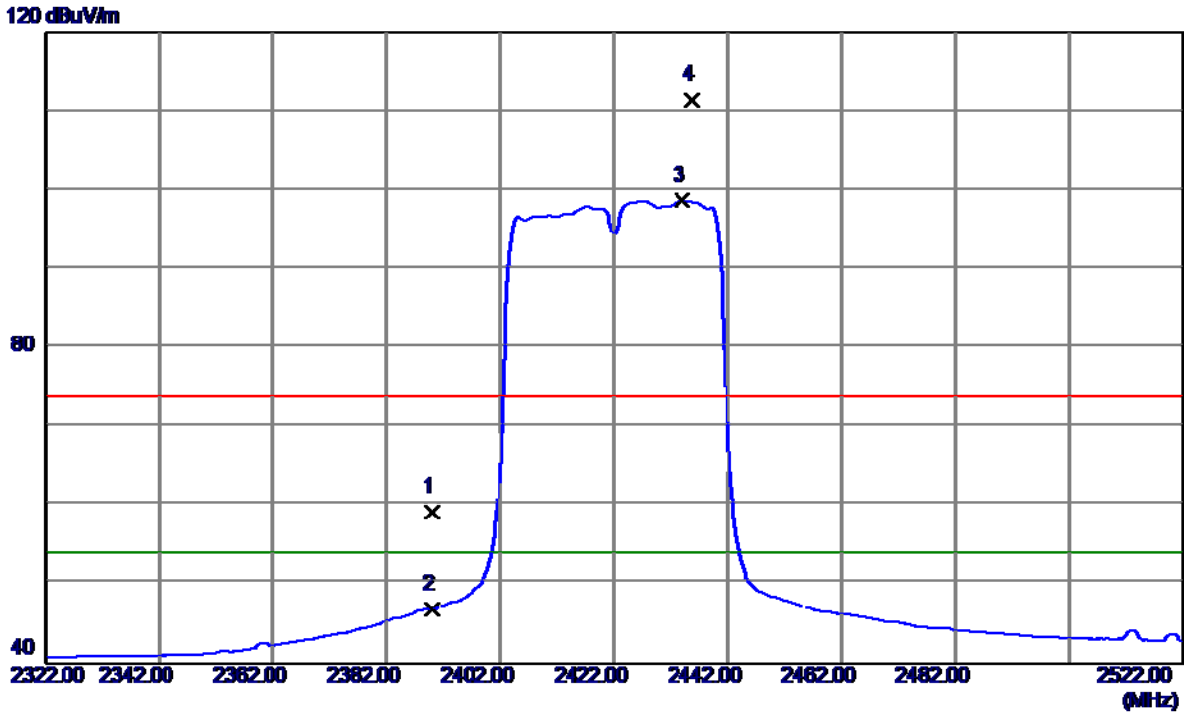

No.	Freq. MHz	Reading Level dBuV/m	Correct Factor dB	Measure ment dBuV/m	Limit dBuV/m	Margin dB	Detector	Comment
1	2390.0000	26.24	33.01	59.25	74.00	-14.75	Peak	
2	2390.0000	13.82	33.01	46.83	54.00	-7.17	AVG	
3 *	2434.0000	65.45	33.19	98.64	54.00	44.64	AVG	No Limit
4	2435.8000	78.16	33.20	111.36	74.00	37.36	Peak	No Limit

Orthogonal Axis :	X
Test Mode :	TX N-40M MODE 2422MHz

Vertical

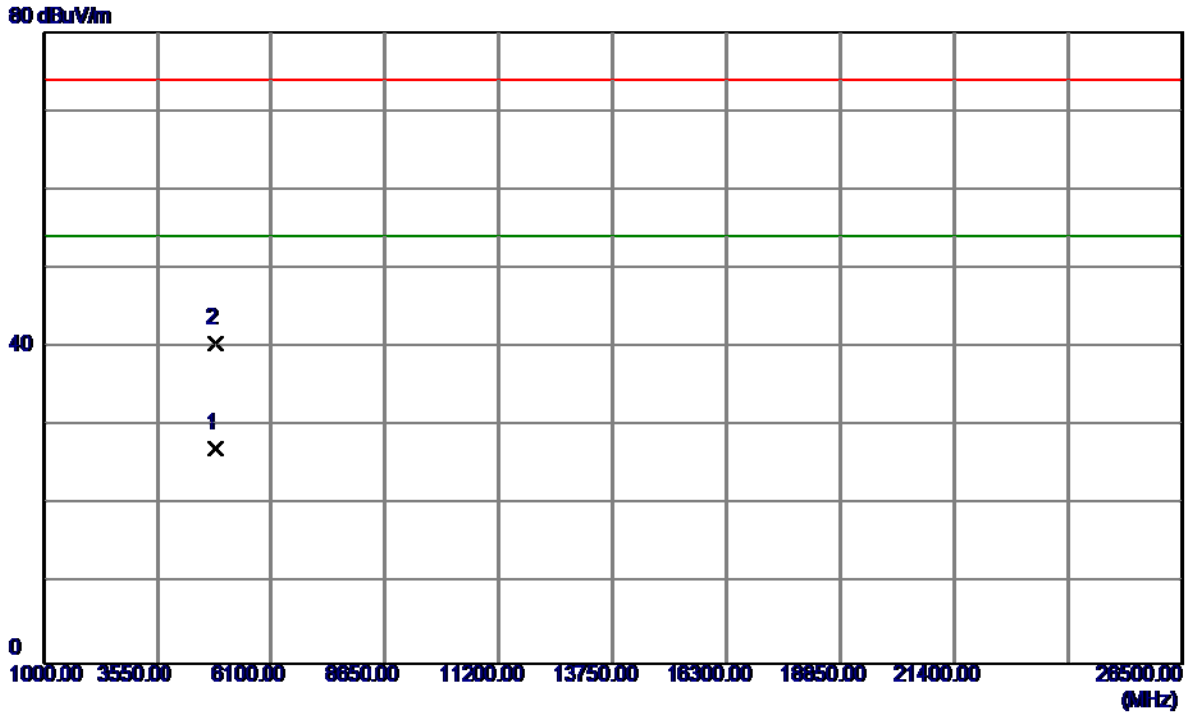

No.	Freq. MHz	Reading Level dBuV/m	Correct Factor dB	Measure ment dBuV/m	Limit dBuV/m	Margin dB	Detector	Comment
1 *	4844.1000	22.33	4.94	27.27	54.00	-26.73	AVG	
2	4844.1700	35.61	4.94	40.55	74.00	-33.45	Peak	

Orthogonal Axis :	X
Test Mode :	TX N-40M MODE 2422MHz

Horizontal

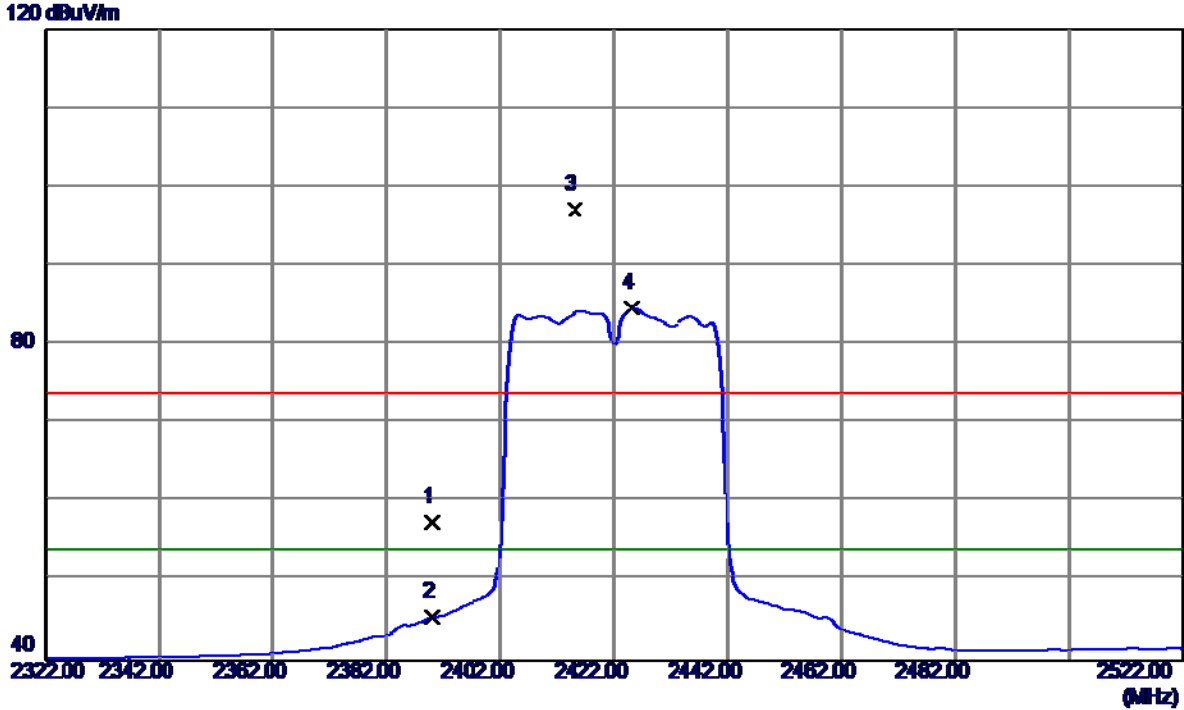

No.	Freq. MHz	Reading Level dBuV/m	Correct Factor dB	Measure ment dBuV/m	Limit dBuV/m	Margin dB	Detector	Comment
1	2390.0000	24.50	33.01	57.51	74.00	-16.49	Peak	
2	2390.0000	12.41	33.01	45.42	54.00	-8.58	AVG	
3	2415.0000	64.01	33.11	97.12	74.00	23.12	Peak	No Limit
4 *	2425.2000	51.41	33.16	84.57	54.00	30.57	AVG	No Limit

Orthogonal Axis :	X
Test Mode :	TX N-40M MODE 2422MHz

Horizontal

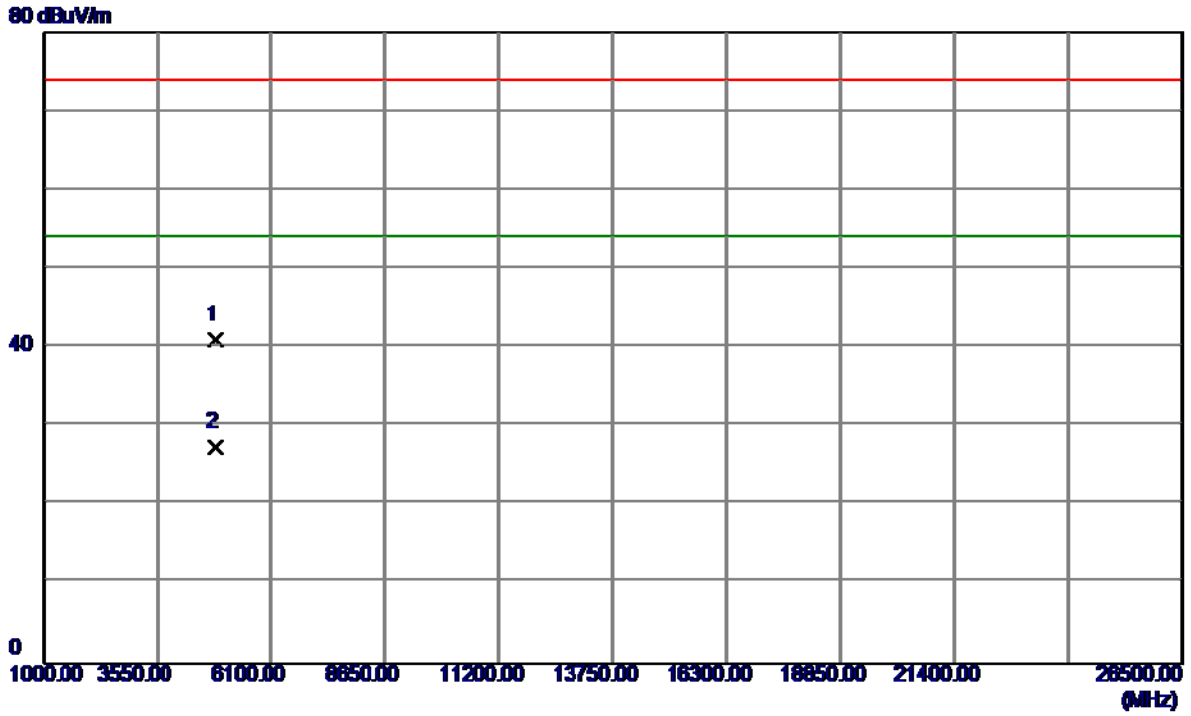

No.	Freq. MHz	Reading Level dBuV/m	Correct Factor dB	Measure ment dBuV/m	Limit dBuV/m	Margin dB	Detector	Comment
1	4844.3500	35.96	4.94	40.90	74.00	-33.10	Peak	
2 *	4844.3600	22.38	4.94	27.32	54.00	-26.68	AVG	

Orthogonal Axis :	X
Test Mode :	TX N-40M MODE 2437MHz

Vertical

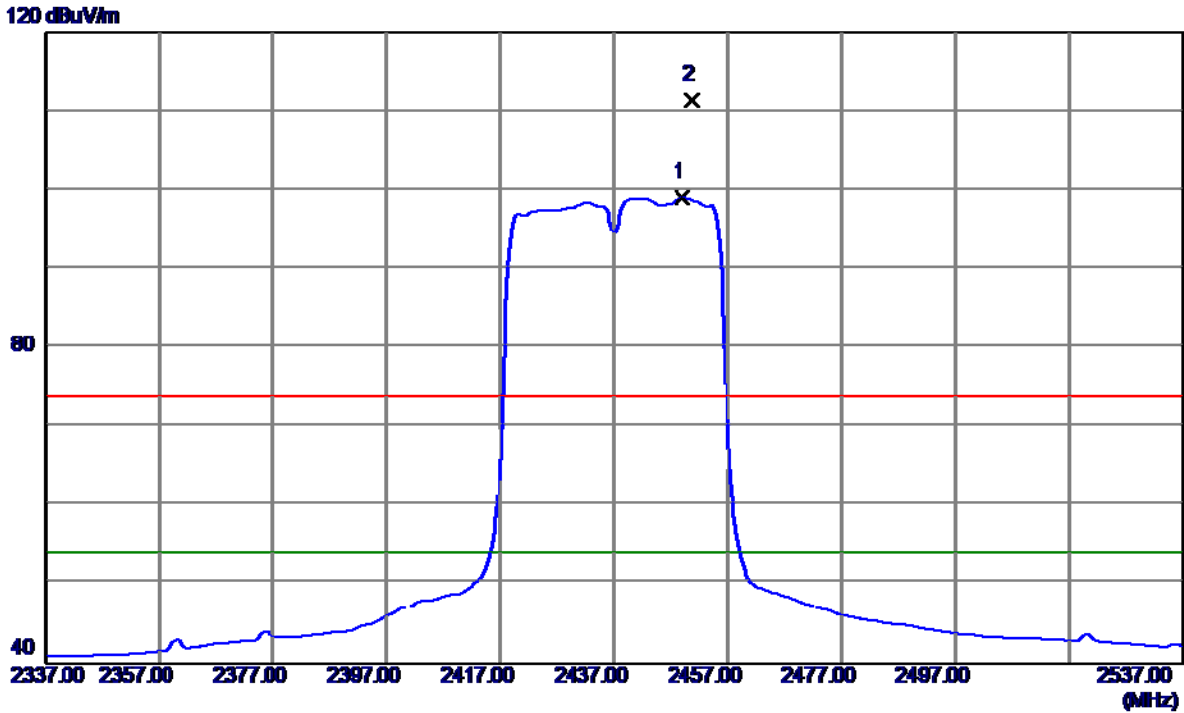

No.	Freq. MHz	Reading Level dBuV/m	Correct Factor dB	Measure ment dBuV/m	Limit dBuV/m	Margin dB	Detector	Comment
1 *	2449.0000	65.74	33.26	99.00	54.00	45.00	AVG	No Limit
2	2450.8000	78.13	33.26	111.39	74.00	37.39	Peak	No Limit

Orthogonal Axis :	X
Test Mode :	TX N-40M MODE 2437MHz

Vertical

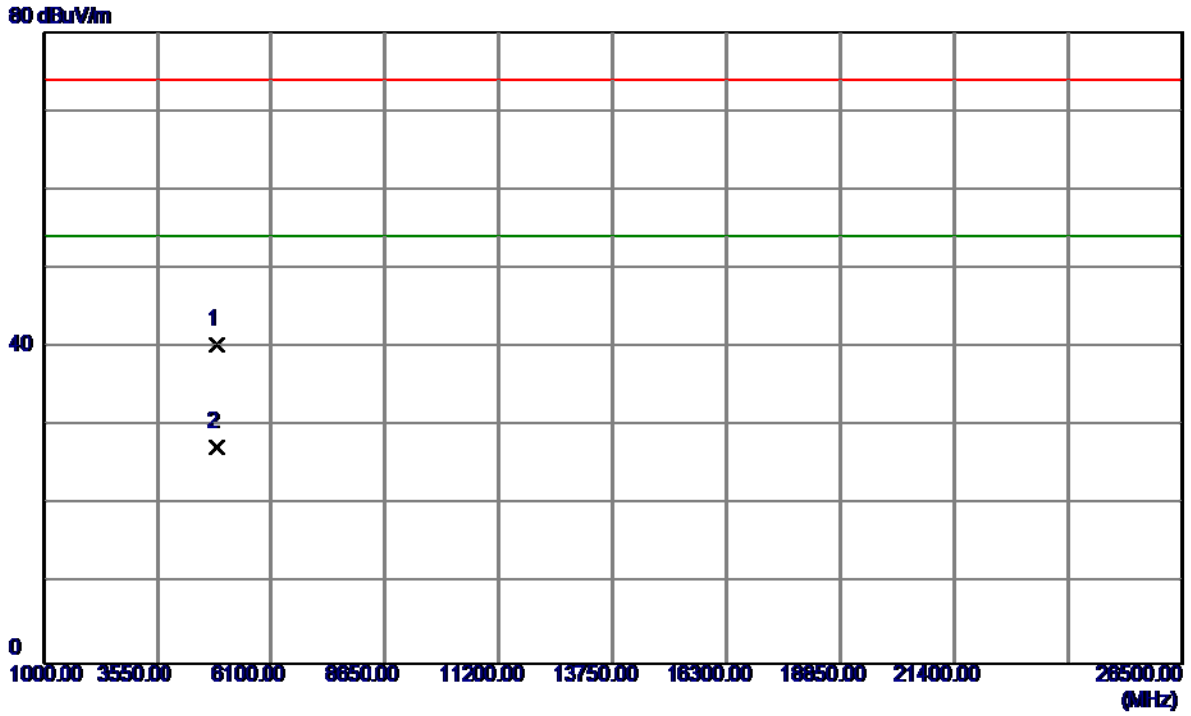

No.	Freq. MHz	Reading Level dBuV/m	Correct Factor dB	Measure ment dBuV/m	Limit dBuV/m	Margin dB	Detector	Comment
1	4873.5099	35.33	5.06	40.39	74.00	-33.61	Peak	
2 *	4874.1500	22.34	5.07	27.41	54.00	-26.59	AVG	

Orthogonal Axis :	X
Test Mode :	TX N-40M MODE 2437MHz

Horizontal

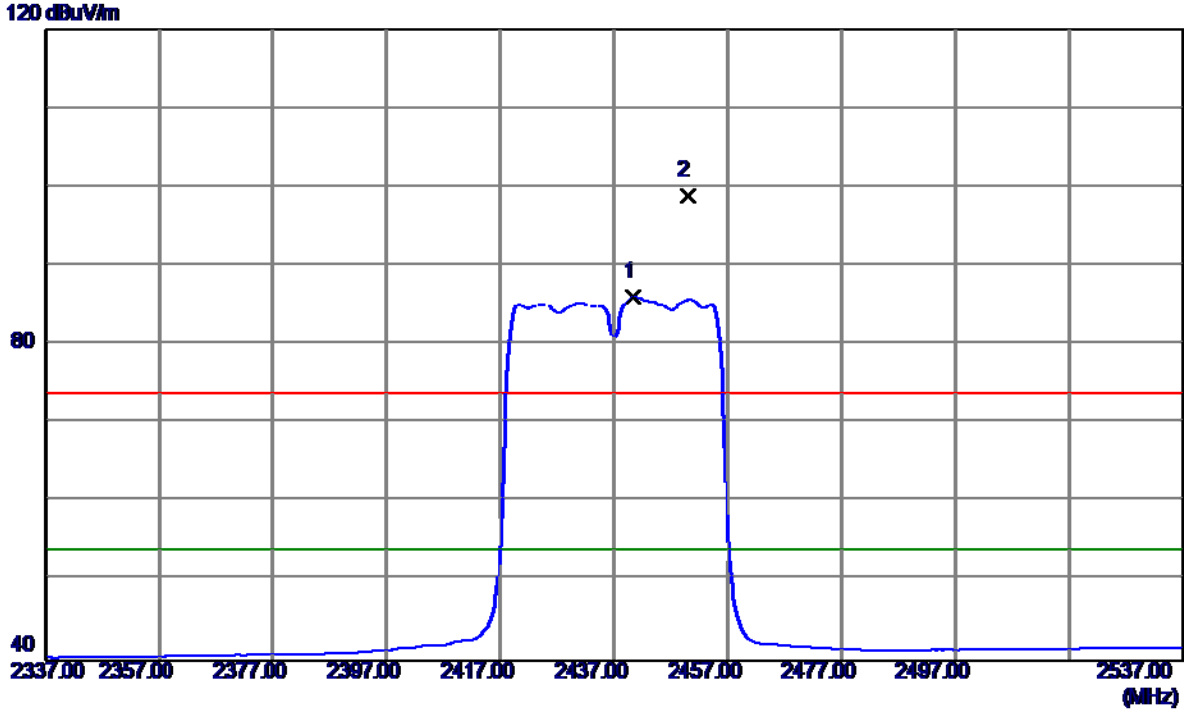

No.	Freq. MHz	Reading Level dBuV/m	Correct Factor dB	Measure ment dBuV/m	Limit dBuV/m	Margin dB	Detector	Comment
1 *	2440.4000	52.81	33.22	86.03	54.00	32.03	AVG	No Limit
2	2450.0000	65.64	33.26	98.90	74.00	24.90	Peak	No Limit

Orthogonal Axis :	X
Test Mode :	TX N-40M MODE 2437MHz

Horizontal

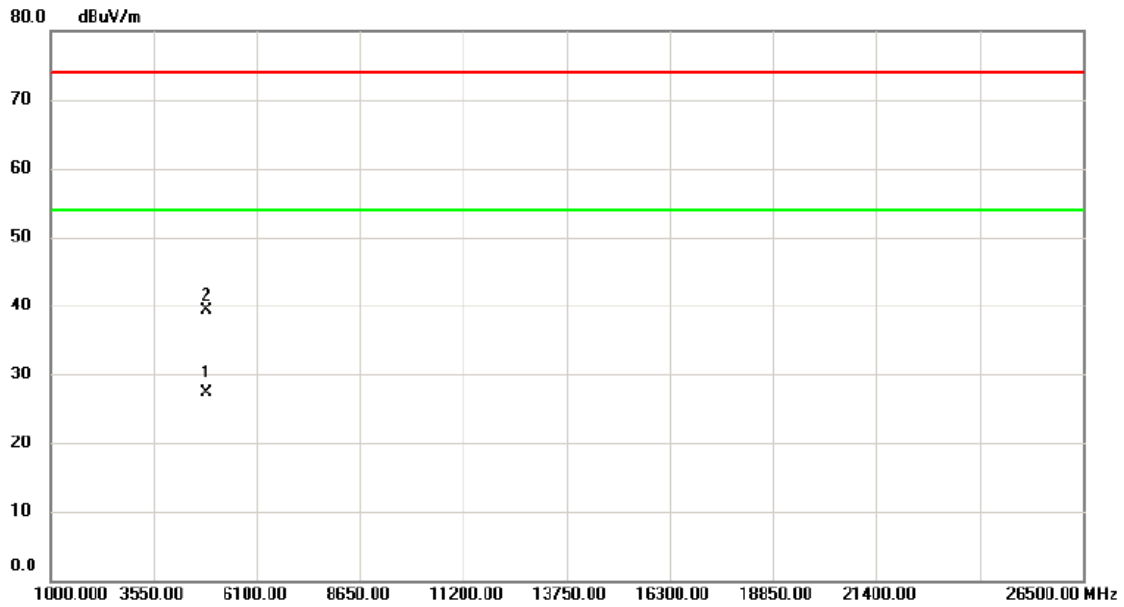

No.	Mk.	Freq. MHz	Reading Level dBuV	Correct Factor dB	Measure- ment dBuV/m	Limit dBuV/m	Margin dB	Detector	Comment
1	*	4874.470	22.32	5.06	27.38	54.00	-26.62	AVG	
2		4875.050	34.29	5.07	39.36	74.00	-34.64	peak	

Orthogonal Axis :	X
Test Mode :	TX N-40M MODE 2452MHz

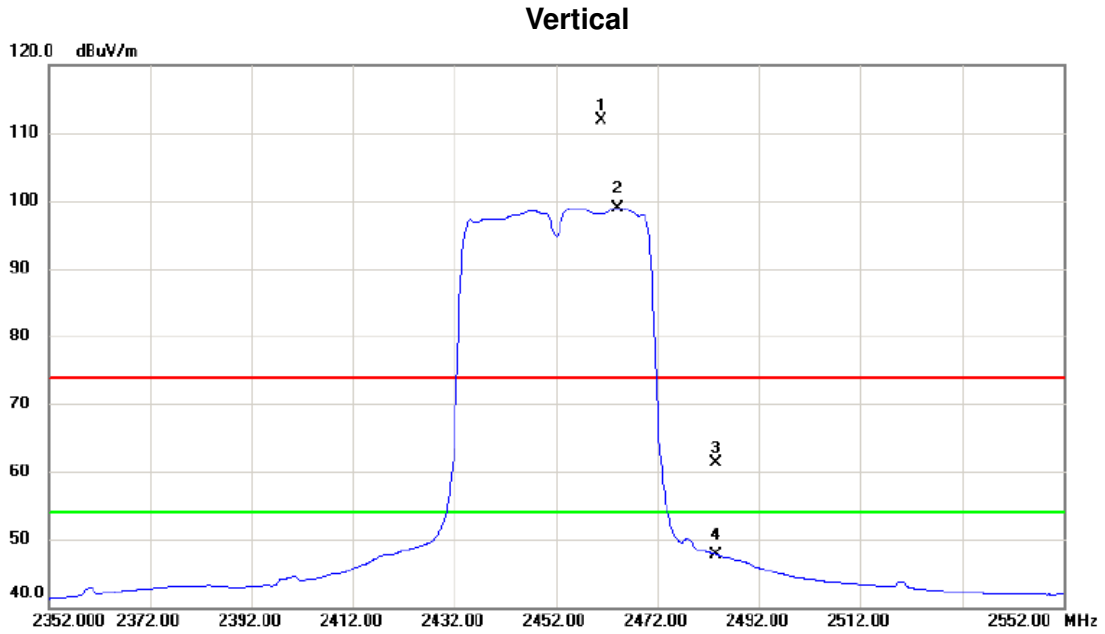

No.	Mk.	Freq. MHz	Reading Level dBuV	Correct Factor dB	Measure- ment dBuV/m	Limit dBuV/m	Margin dB	Detector	Comment
1	X	2461.000	78.65	33.31	111.96	74.00	37.96	peak	No Limit
2	*	2464.200	65.67	33.32	98.99	54.00	44.99	AVG	No Limit
3		2483.500	27.85	33.40	61.25	74.00	-12.75	peak	
4		2483.500	14.38	33.40	47.78	54.00	-6.22	AVG	

Orthogonal Axis :	X
Test Mode :	TX N-40M MODE 2452MHz

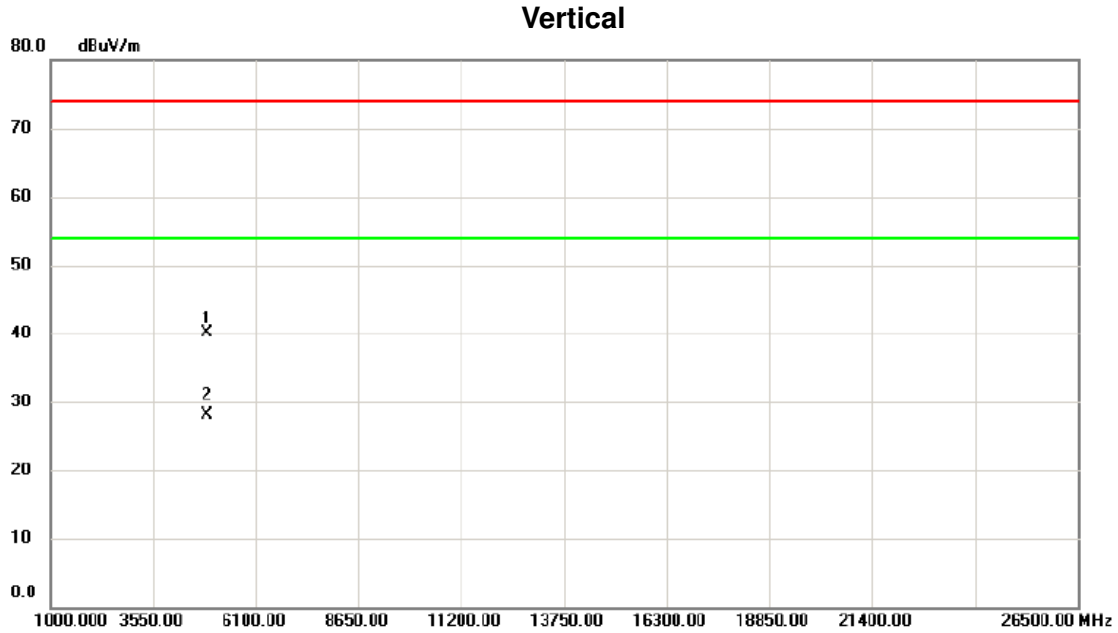

No.	Mk.	Freq. MHz	Reading Level dBuV	Correct Factor dB	Measure- ment dBuV/m	Limit dBuV/m	Margin dB	Detector	Comment
1		4903.840	34.90	5.19	40.09	74.00	-33.91	peak	
2	*	4905.190	22.90	5.20	28.10	54.00	-25.90	AVG	

Orthogonal Axis :	X
Test Mode :	TX N-40M MODE 2452MHz

Horizontal

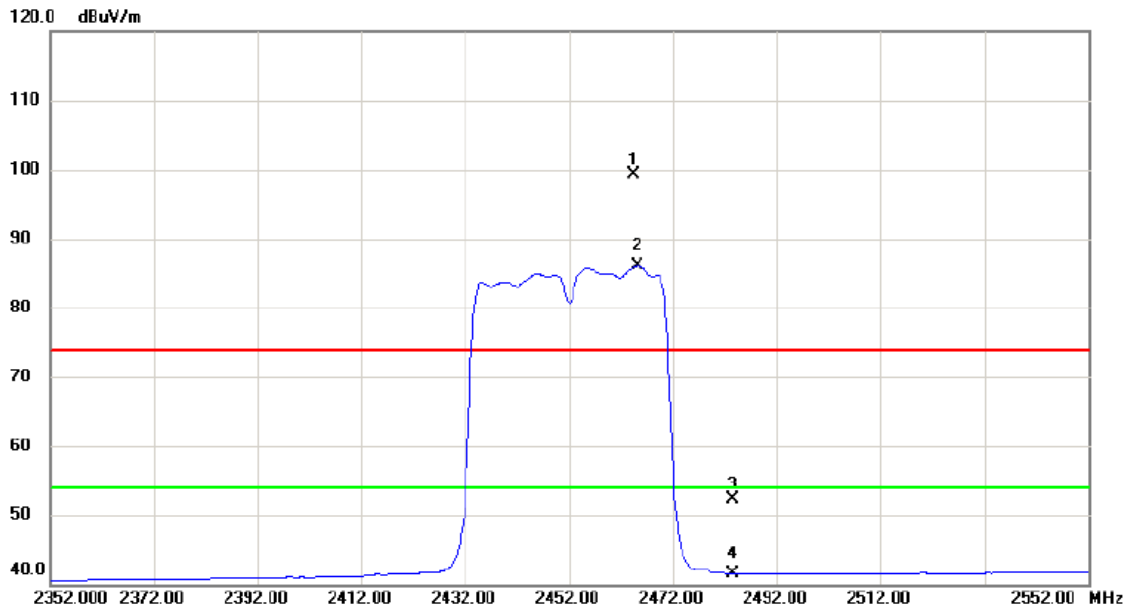

No.	Mk.	Freq. MHz	Reading Level dBuV	Correct Factor dB	Measure- ment dBuV/m	Limit dBuV/m	Margin dB	Detector	Comment
1	X	2464.400	66.00	33.33	99.33	74.00	25.33	peak	No Limit
2	*	2465.200	52.70	33.33	86.03	54.00	32.03	AVG	No Limit
3		2483.500	18.93	33.40	52.33	74.00	-21.67	peak	
4		2483.500	8.14	33.40	41.54	54.00	-12.46	AVG	

Orthogonal Axis :	X
Test Mode :	TX N-40M MODE 2452MHz

Horizontal

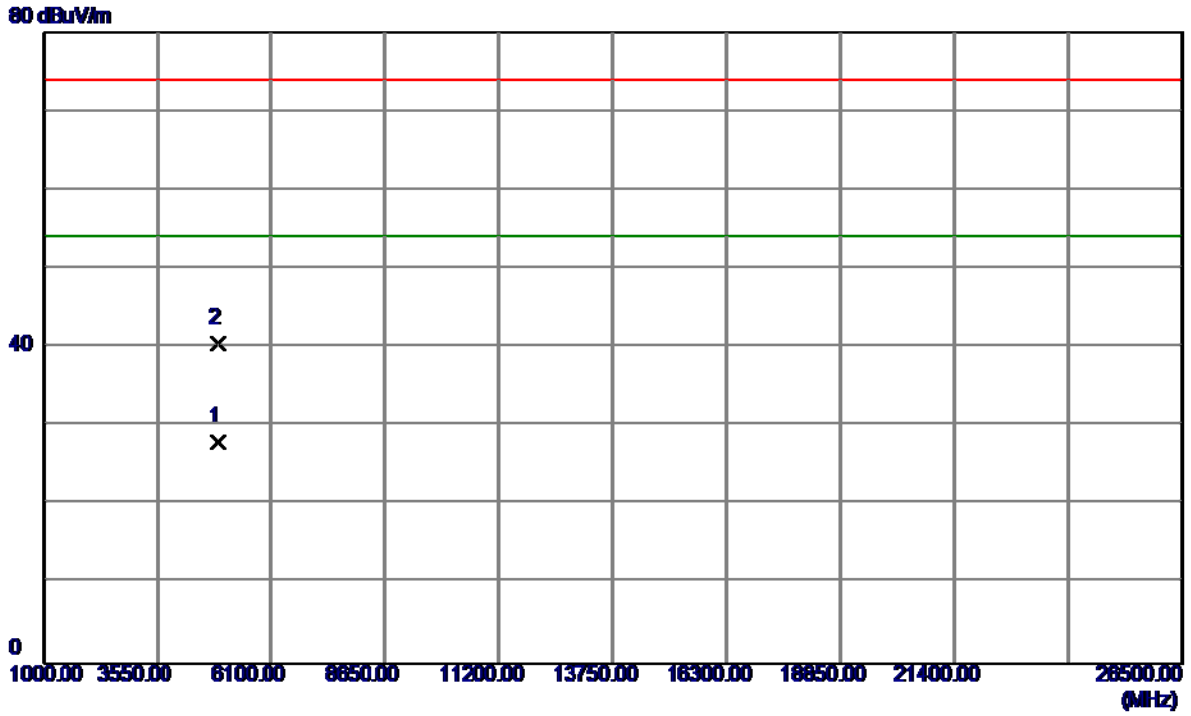

No.	Freq. MHz	Reading Level dBuV/m	Correct Factor dB	Measure ment dBuV/m	Limit dBuV/m	Margin dB	Detector	Comment
1 *	4904.6300	22.83	5.20	28.03	54.00	-25.97	AVG	
2	4905.5200	35.30	5.20	40.50	74.00	-33.50	Peak	

Orthogonal Axis:	X
Test Mode:	2.4GHz+5GHz

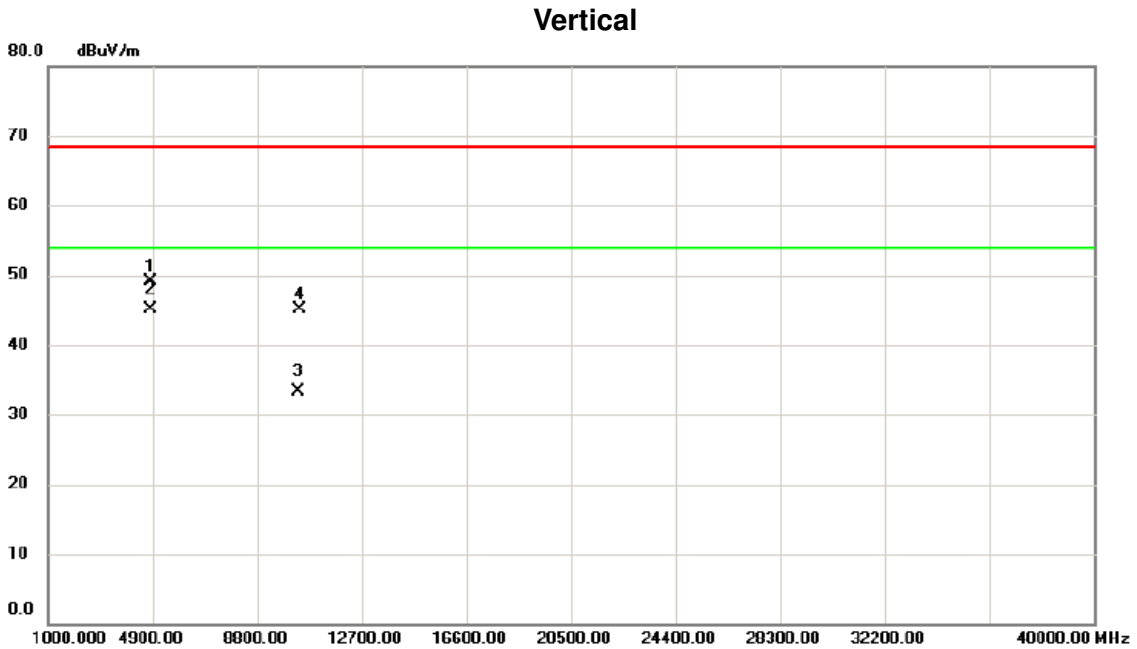

No.	Mk.	Freq. MHz	Reading Level dBuV	Correct Factor dB	Measure- ment dBuV/m	Limit dBuV/m	Margin dB	Detector	Comment
1		4823.930	44.25	4.85	49.10	68.30	-19.20	peak	
2	*	4823.975	40.35	4.85	45.20	54.00	-8.80	AVG	
3		10359.96	18.33	14.96	33.29	54.00	-20.71	AVG	
4		10360.11	30.10	14.96	45.06	68.30	-23.24	peak	

Orthogonal Axis:	X
Test Mode:	2.4GHz+5GHz

Horizontal

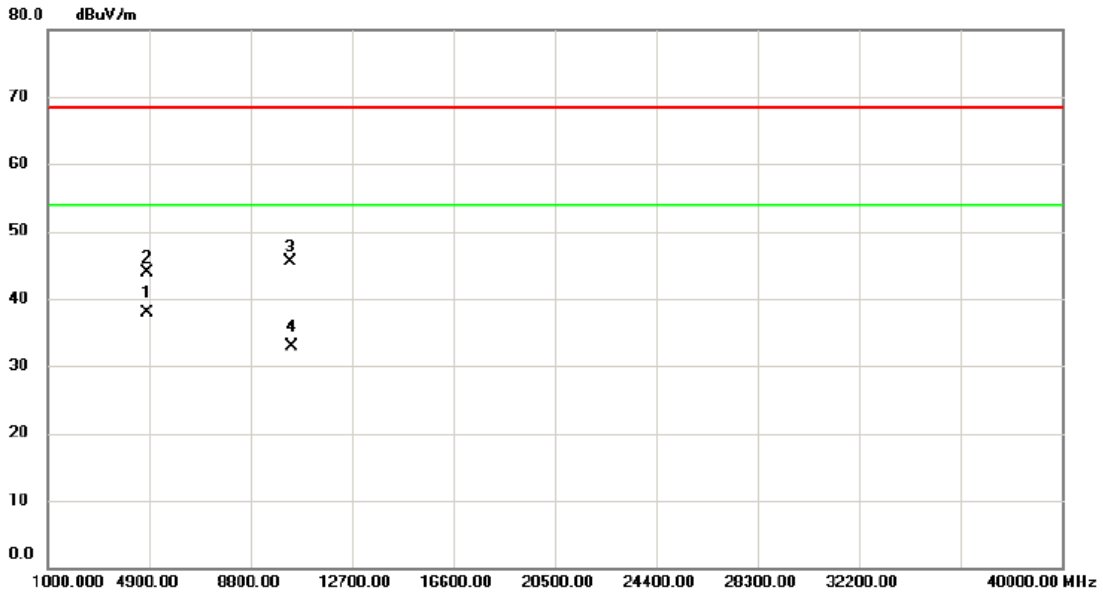

No.	Mk.	Freq. MHz	Reading Level dBuV	Correct Factor dB	Measure- ment dBuV/m	Limit dBuV/m	Margin dB	Detector	Comment
1	*	4823.930	33.04	4.85	37.89	54.00	-16.11	AVG	
2		4823.995	39.07	4.85	43.92	68.30	-24.38	peak	
3		10359.96	30.56	14.96	45.52	68.30	-22.78	peak	
4		10360.05	17.90	14.96	32.86	54.00	-21.14	AVG	

ATTACHMENT E - BANDWIDTH

Test Mode : TX B Mode_CH01/06/11

Frequency (MHz)	6dB Bandwidth (MHz)	99% Occupied BW (MHz)	Min. Limit (kHz)	Test Result
2412	8.03	11.96	500	Complies
2437	10.12	15.84	500	Complies
2462	8.58	11.84	500	Complies

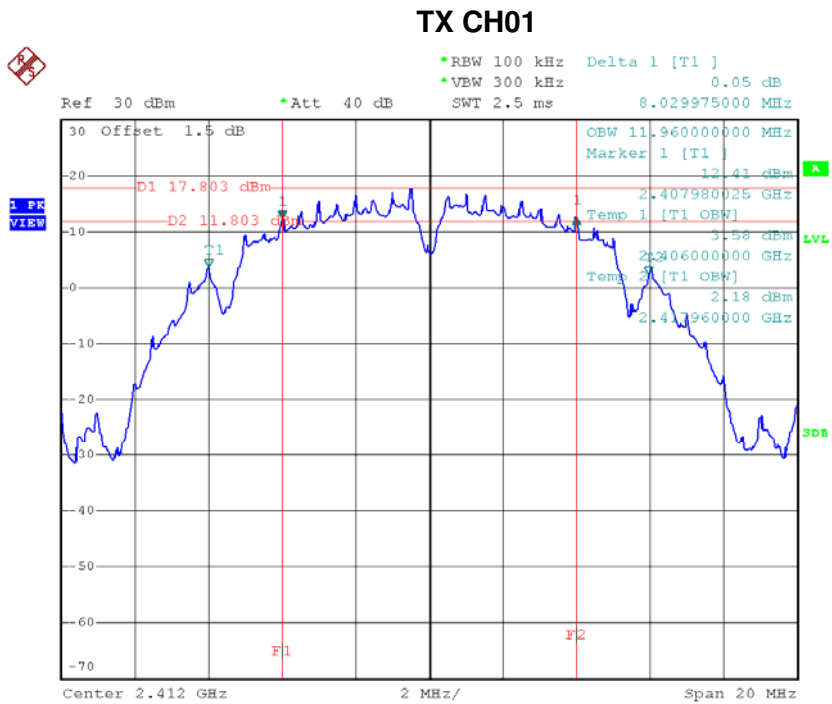

Date: 26.AUG.2016 20:01:18

TX CH06

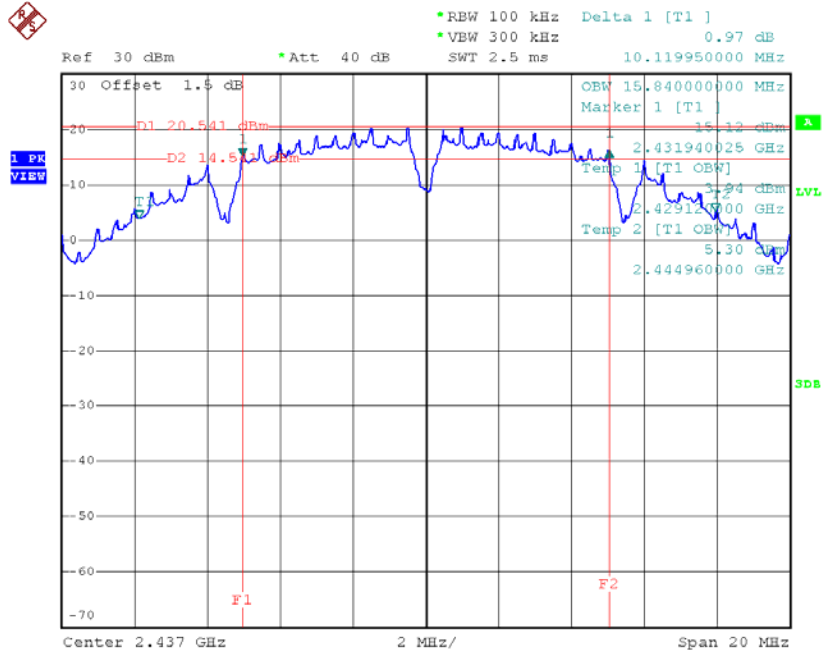

Date: 26.AUG.2016 20:03:11

TX CH11

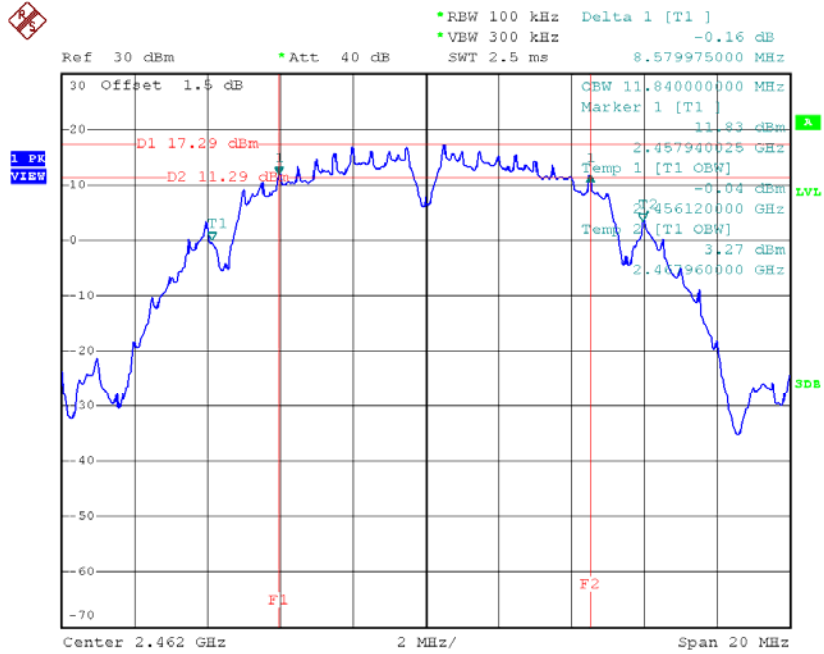

Date: 26.AUG.2016 20:05:18

Test Mode: TX G Mode_CH01/06/11

Frequency (MHz)	6dB Bandwidth (MHz)	99% Occupied BW (MHz)	Min. Limit (kHz)	Test Result
2412	16.39	18.04	500	Complies
2437	16.43	17.92	500	Complies
2462	16.44	17.96	500	Complies

TX CH01

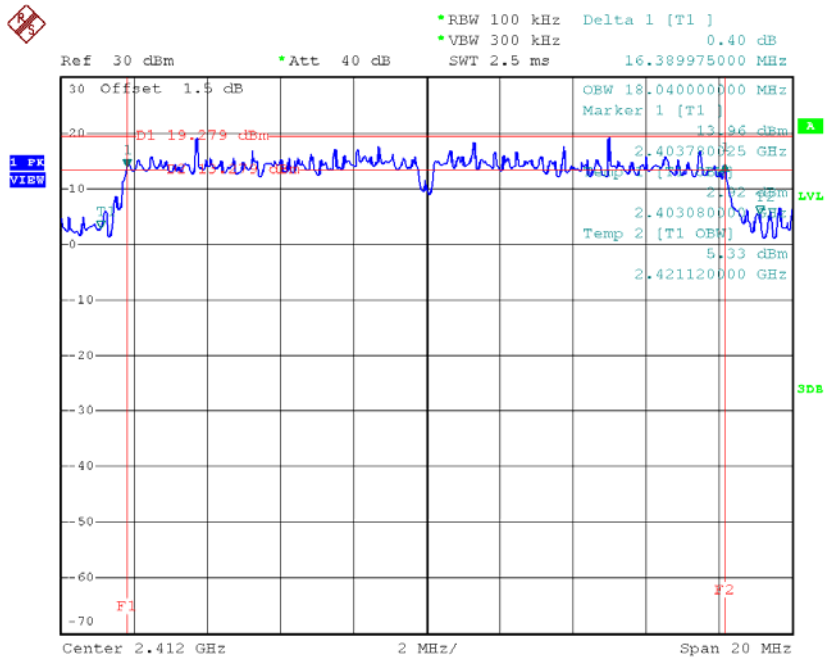

Date: 16.AUG.2016 16:17:45

TX CH06

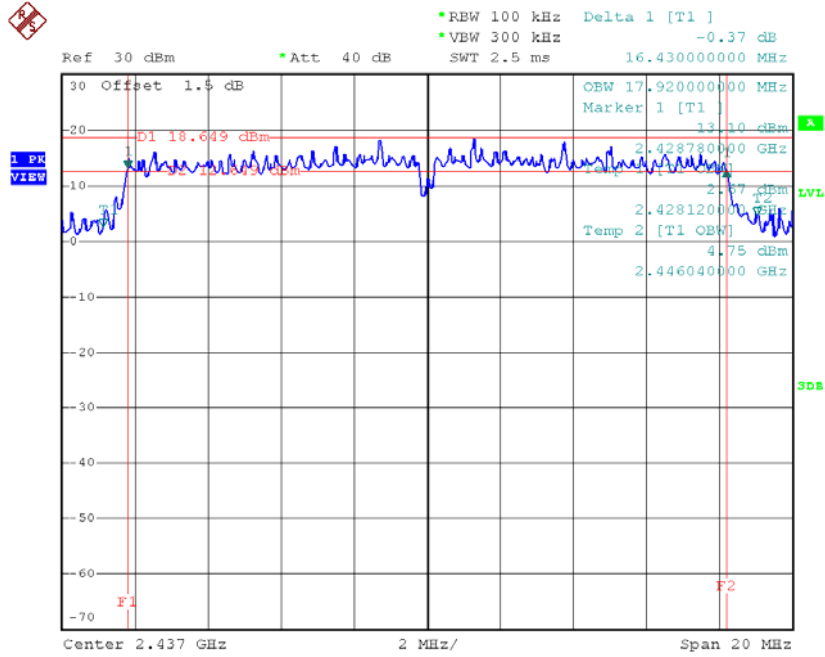

Date: 16.AUG.2016 16:24:23

TX CH11

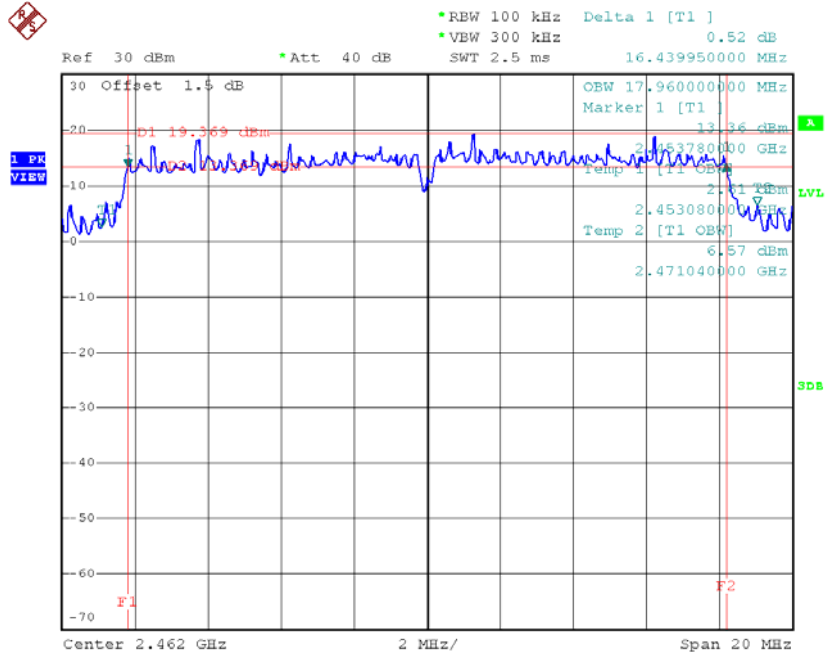

Date: 16.AUG.2016 16:26:53

Test Mode : TX N-20MHz Mode_CH01/06/11

Frequency (MHz)	6dB Bandwidth (MHz)	99% Occupied BW (MHz)	Min. Limit (kHz)	Test Result
2412	17.62	17.68	500	Complies
2437	17.64	17.68	500	Complies
2462	17.62	17.68	500	Complies

TX CH01

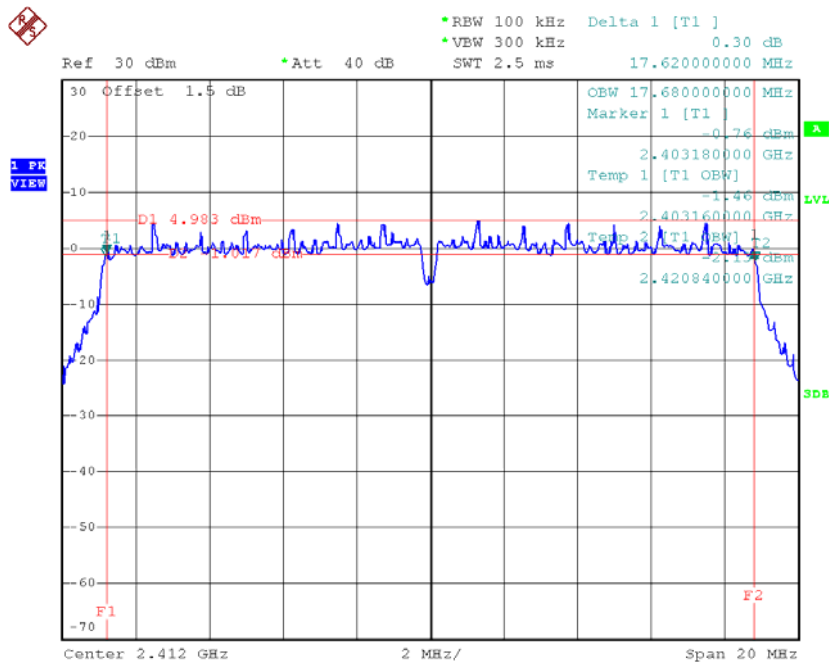

Date: 16.AUG.2016 16:32:59

TX CH06

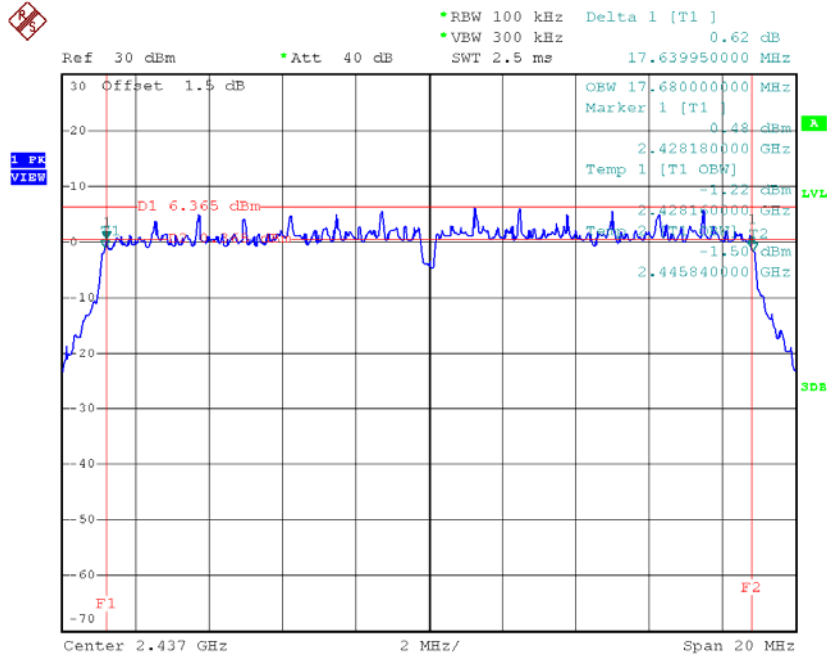

Date: 16.AUG.2016 16:34:21

TX CH11

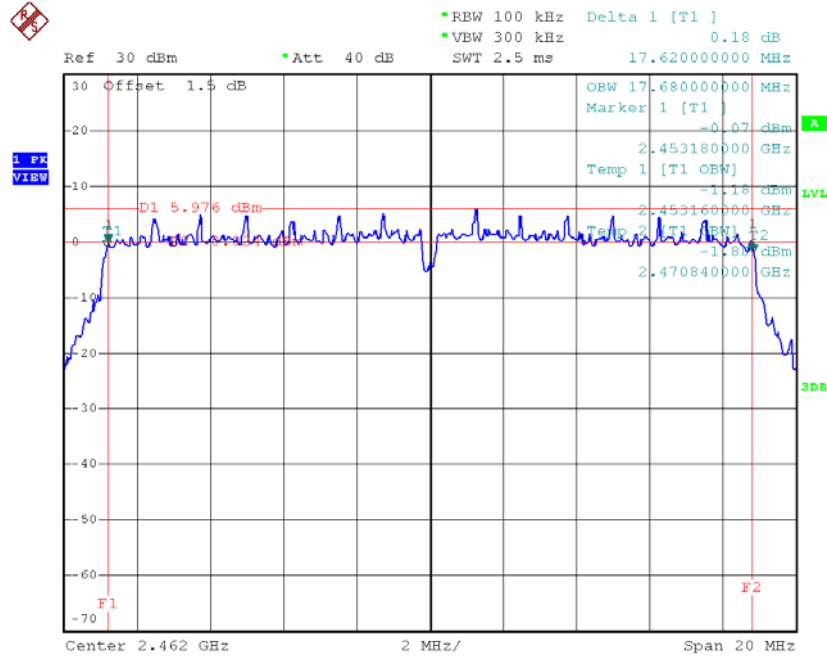

Date: 16.AUG.2016 16:42:28

Test Mode : TX N-40MHz Mode_CH03/06/09

Frequency (MHz)	6dB Bandwidth (MHz)	99% Occupied BW (MHz)	Min. Limit (kHz)	Test Result
2422	36.25	36.24	500	Complies
2437	35.8	36.16	500	Complies
2452	36.2	36.16	500	Complies

TX CH03

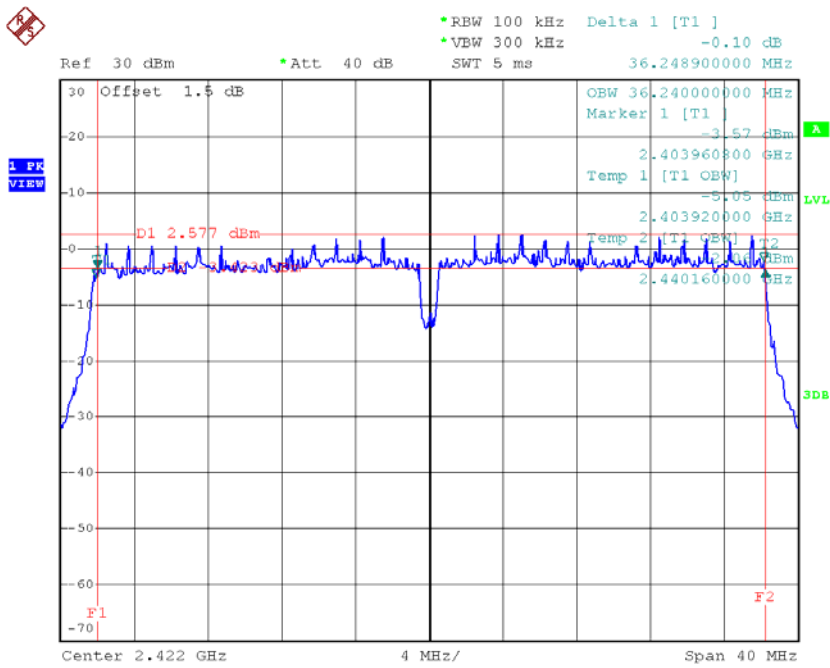

Date: 16.AUG.2016 16:45:46

TX CH06

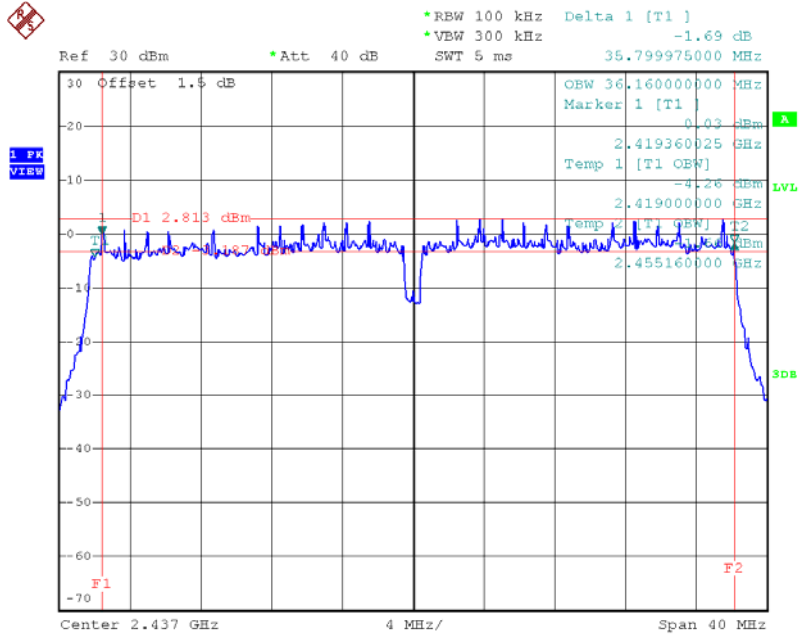

Date: 16.AUG.2016 16:47:19

TX CH09

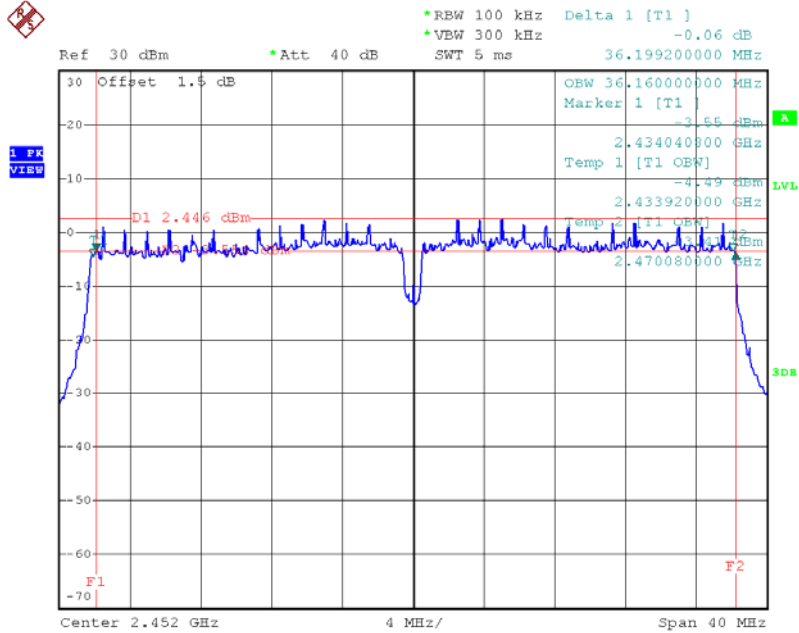

Date: 16.AUG.2016 16:48:32

ATTACHMENT F – MAXIMUM PEAK CONDUCTED OUTPUT POWER

Test Mode :TX B Mode_CH01/06/11					
Frequency (MHz)	Conducted Power (dBm)	Conducted Power (W)	Max. Limit (dBm)	Max. Limit (W)	Result
2412	25.72	0.37	30.00	1.00	Complies
2437	28.12	0.65	30.00	1.00	Complies
2462	26.61	0.46	30.00	1.00	Complies

Test Mode :TX G Mode_CH01/06/11					
Frequency (MHz)	Conducted Power (dBm)	Conducted Power (W)	Max. Limit (dBm)	Max. Limit (W)	Result
2412	26.54	0.45	30.00	1.00	Complies
2437	27.32	0.54	30.00	1.00	Complies
2462	26.58	0.45	30.00	1.00	Complies

Test Mode :TX N20 Mode_CH01/06/11_ANT 1					
Frequency (MHz)	Conducted Power (dBm)	Conducted Power (W)	Max. Limit (dBm)	Max. Limit (W)	Result
2412	22.71	0.1866	30.00	1.00	Complies
2437	22.50	0.1778	30.00	1.00	Complies
2462	22.55	0.1799	30.00	1.00	Complies

Test Mode :TX N20 Mode_CH01/06/11_ANT 2					
Frequency (MHz)	Conducted Power (dBm)	Conducted Power (W)	Max. Limit (dBm)	Max. Limit (W)	Result
2412	22.66	0.1845	30.00	1.00	Complies
2437	22.49	0.1774	30.00	1.00	Complies
2462	22.63	0.1832	30.00	1.00	Complies

Test Mode :TX N20 Mode_CH01/06/11_ANT 3					
Frequency (MHz)	Conducted Power (dBm)	Conducted Power (W)	Max. Limit (dBm)	Max. Limit (W)	Result
2412	22.33	0.1710	30.00	1.00	Complies
2437	22.56	0.1803	30.00	1.00	Complies
2462	22.64	0.1837	30.00	1.00	Complies

Test Mode :TX N20 Mode_CH01/06/11_Total					
Frequency (MHz)	Conducted Power (dBm)	Conducted Power (W)	Max. Limit (dBm)	Max. Limit (W)	Result
2412	27.34	0.5421	28.30	0.676	Complies
2437	27.29	0.5355	28.30	0.676	Complies
2462	27.38	0.5468	28.30	0.676	Complies

Test Mode :TX N40 Mode_CH01/06/11_ANT 1					
Frequency (MHz)	Conducted Power (dBm)	Conducted Power (W)	Max. Limit (dBm)	Max. Limit (W)	Result
2422	22.59	0.1816	30.00	1.00	Complies
2437	22.91	0.1954	30.00	1.00	Complies
2452	21.99	0.1581	30.00	1.00	Complies

Test Mode :TX N40 Mode_CH03/06/09_ANT 2					
Frequency (MHz)	Conducted Power (dBm)	Conducted Power (W)	Max. Limit (dBm)	Max. Limit (W)	Result
2422	21.98	0.1578	30.00	1.00	Complies
2437	21.39	0.1377	30.00	1.00	Complies
2452	21.59	0.1442	30.00	1.00	Complies

Test Mode :TX N40 Mode_CH03/06/09_ANT 3					
Frequency (MHz)	Conducted Power (dBm)	Conducted Power (W)	Max. Limit (dBm)	Max. Limit (W)	Result
2422	23.03	0.2009	30.00	1.00	Complies
2437	22.33	0.1710	30.00	1.00	Complies
2452	22.92	0.1959	30.00	1.00	Complies

Test Mode :TX N40 Mode_CH03/06/09_Total					
Frequency (MHz)	Conducted Power (dBm)	Conducted Power (W)	Max. Limit (dBm)	Max. Limit (W)	Result
2422	27.33	0.5402	28.30	0.676	Complies
2437	27.03	0.5042	28.30	0.676	Complies
2452	26.97	0.4982	28.30	0.676	Complies

ATTACHMENT G - ANTENNA CONDUCTED SPURIOUS EMISSION

Test Mode : TX B Mode

TX B mode CH01

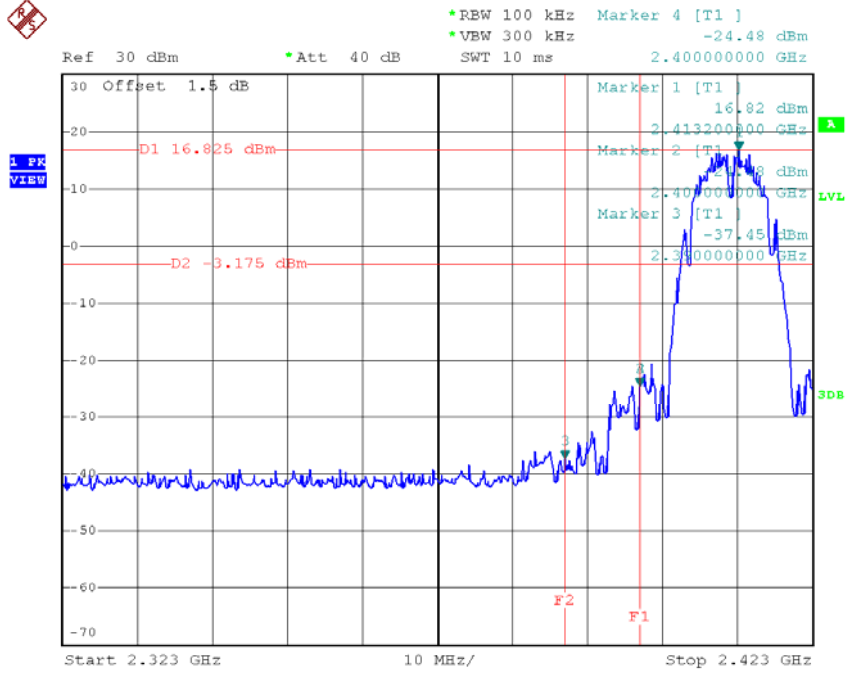

Date: 26.AUG.2016 20:01:57

TX B mode CH11

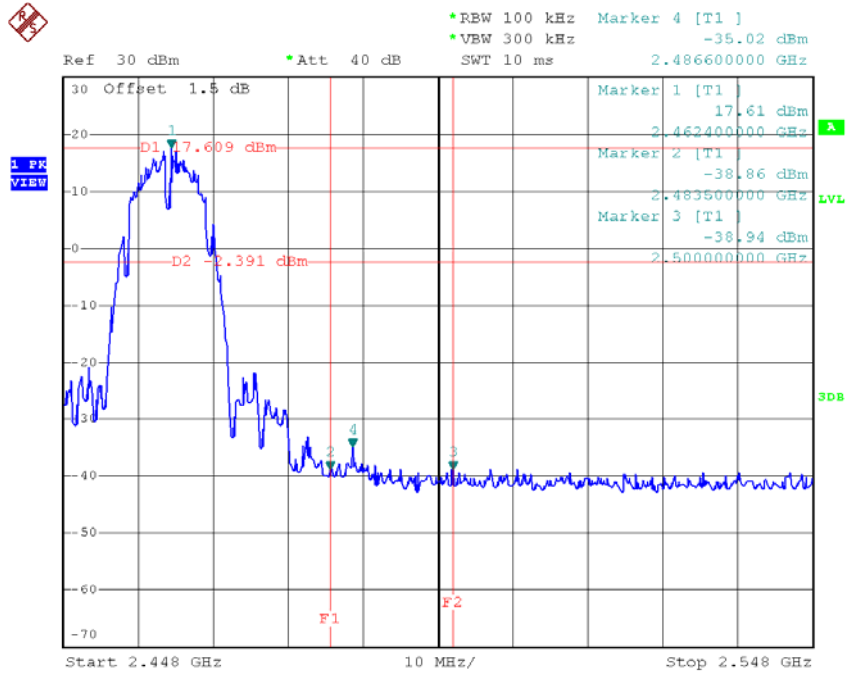

Date: 26.AUG.2016 20:05:57

TX B mode CH01 (10 Harmonic of the frequency)

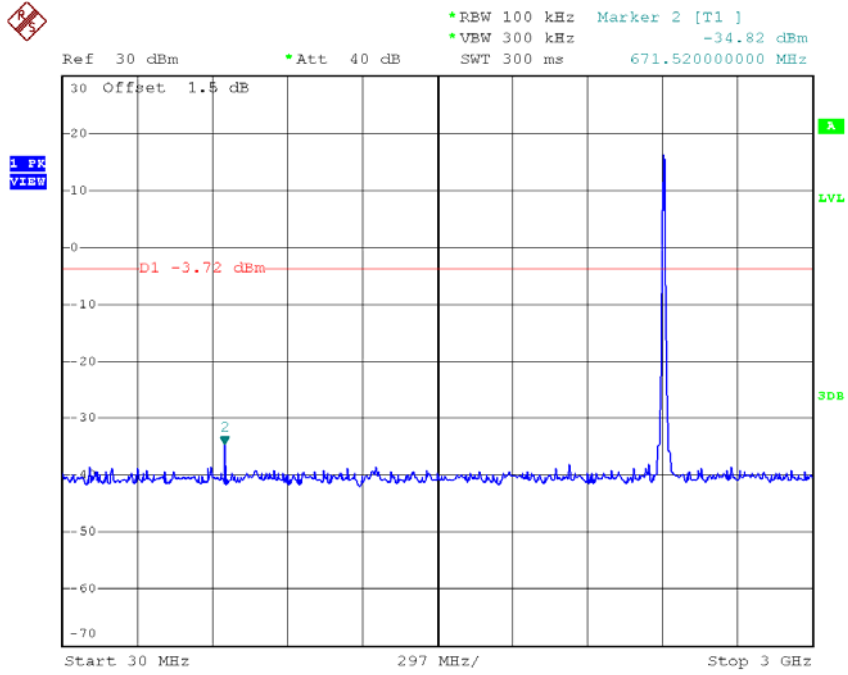

Date: 26.AUG.2016 20:01:32

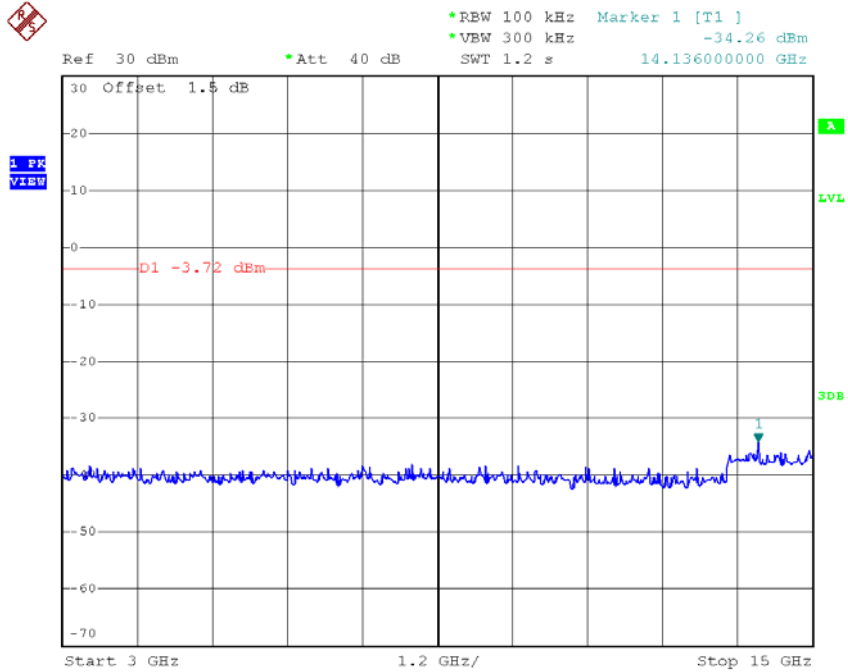

Date: 26.AUG.2016 20:01:41

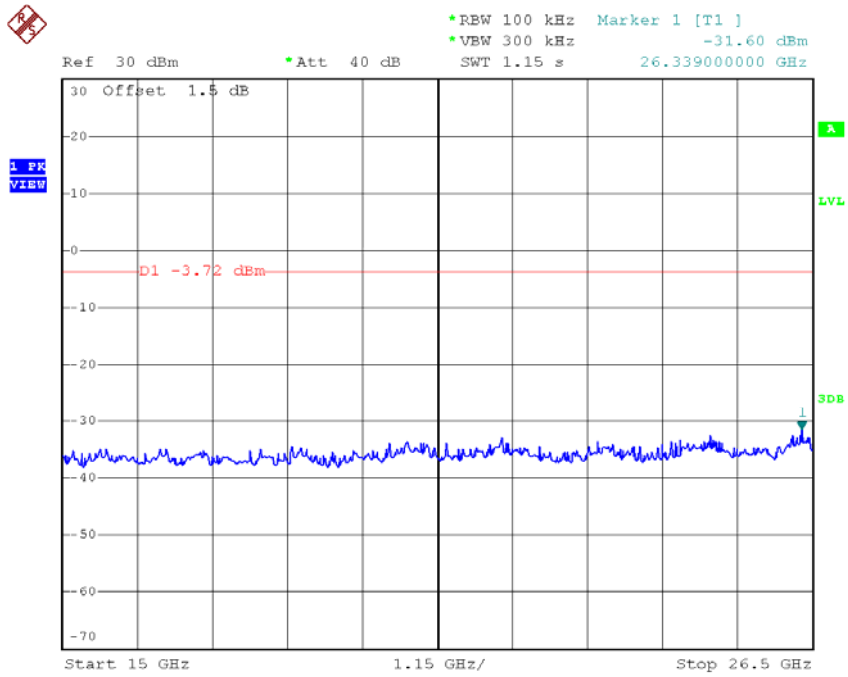

Date: 26.AUG.2016 20:01:50

TX B mode CH06 (10 Harmonic of the frequency)

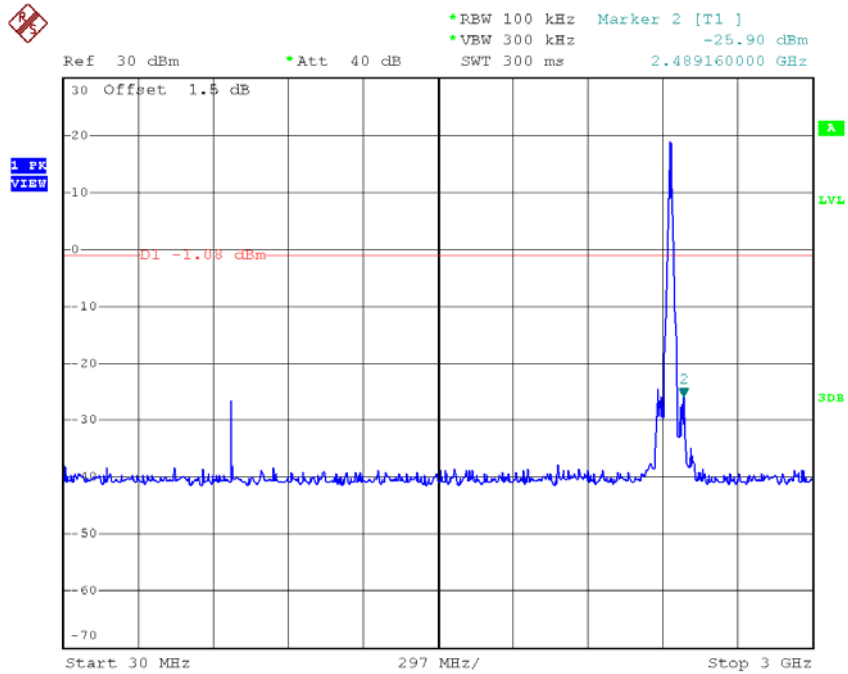

Date: 26.AUG.2016 20:03:25

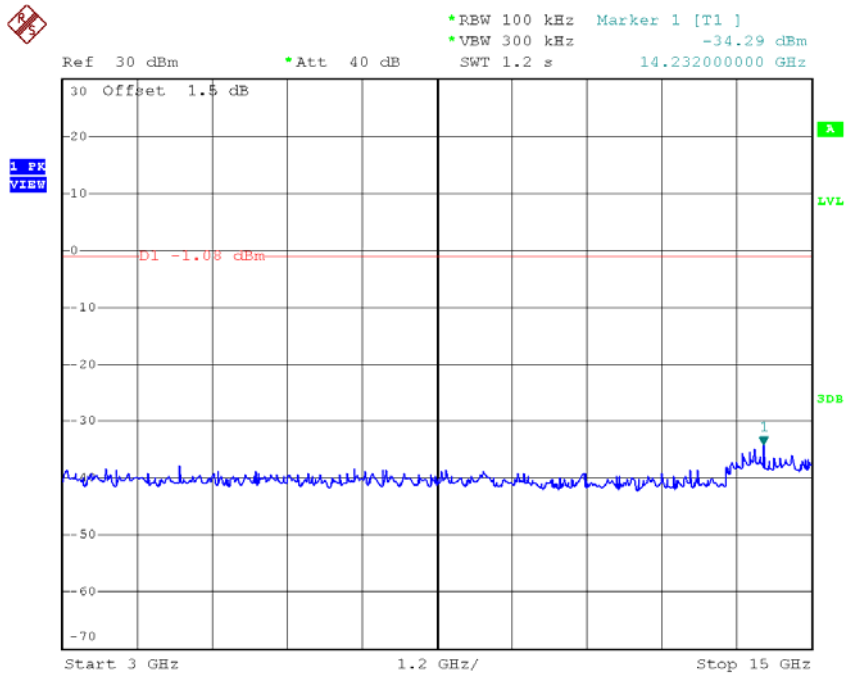

Date: 26.AUG.2016 20:03:33

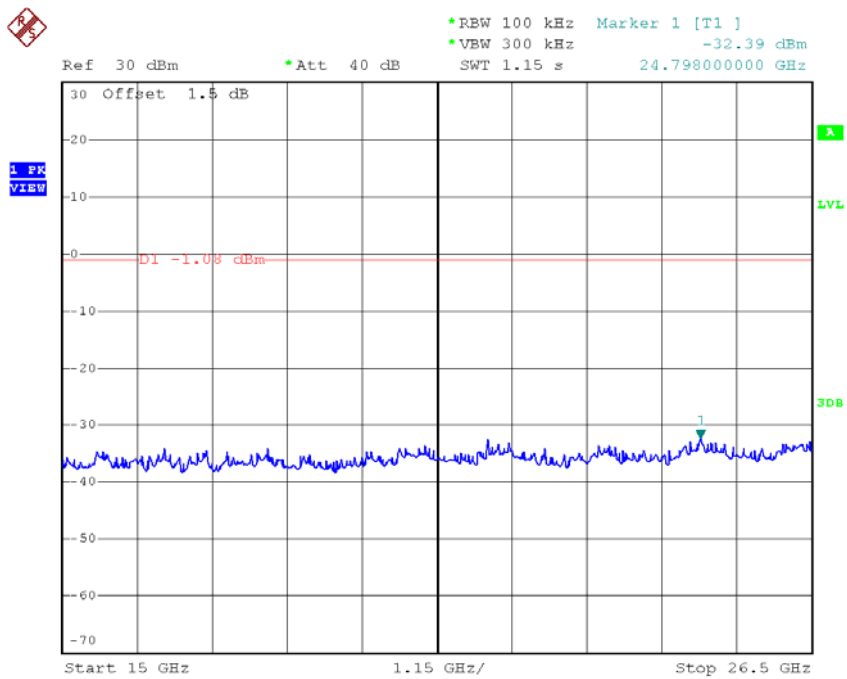

Date: 26.AUG.2016 20:03:42

TX B mode CH11 (10 Harmonic of the frequency)

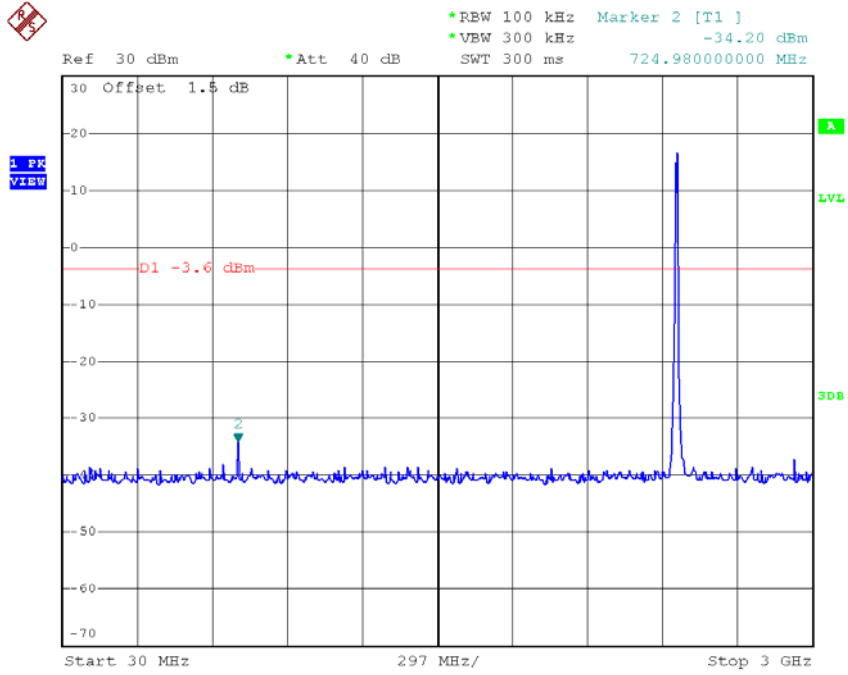

Date: 26.AUG.2016 20:05:32

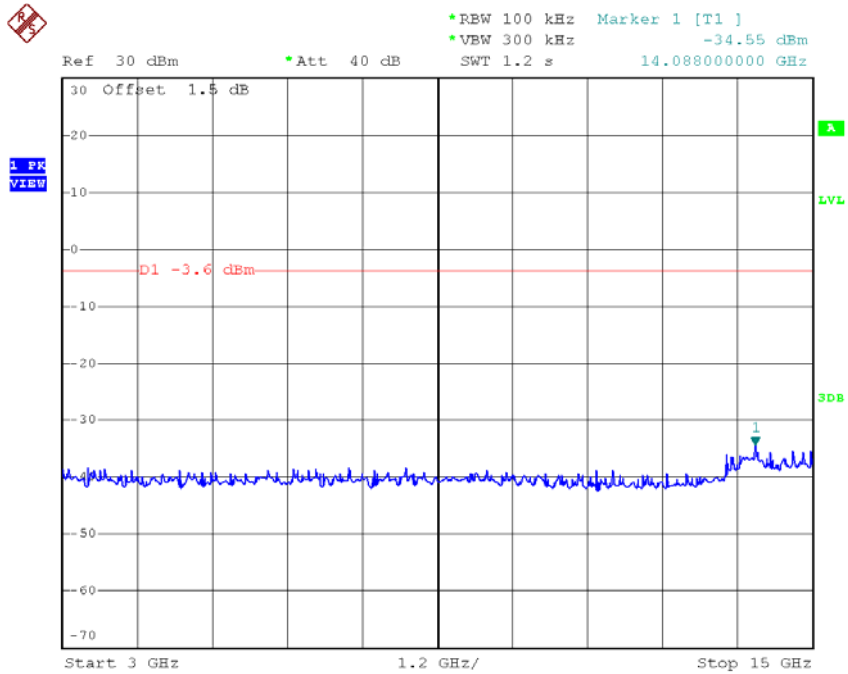

Date: 26.AUG.2016 20:05:41

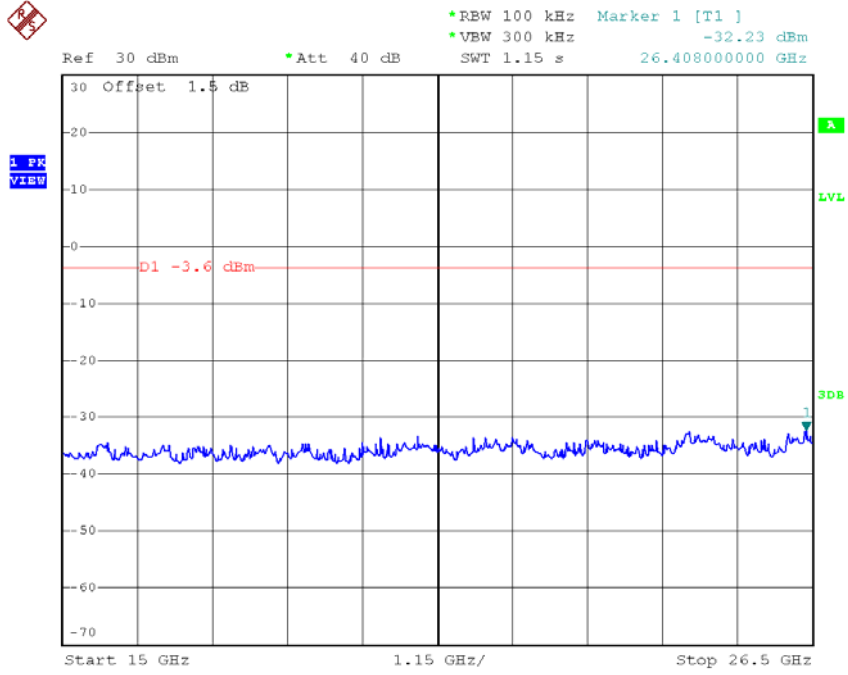

Date: 26.AUG.2016 20:05:49

Test Mode : TX G Mode

TX G mode CH01

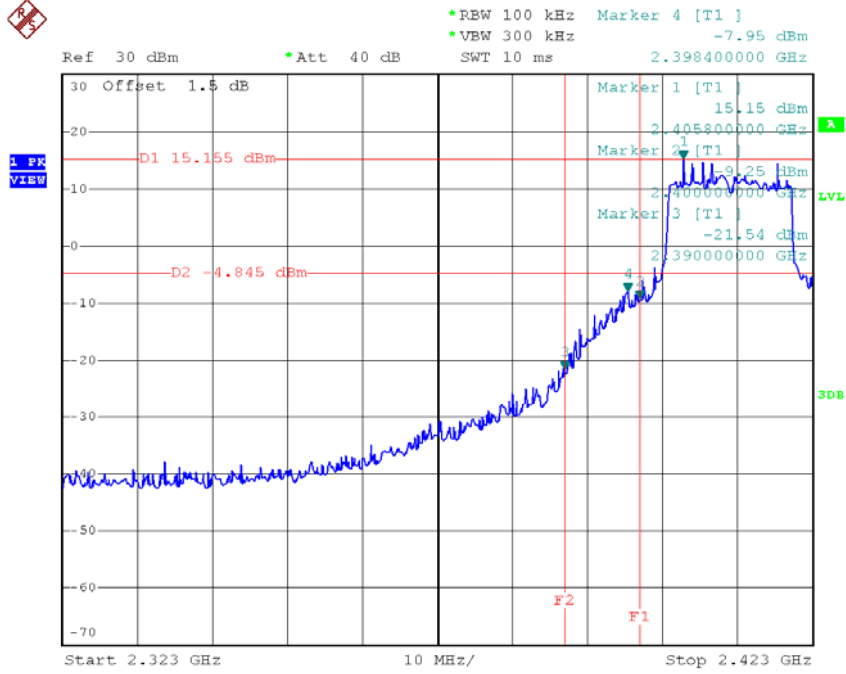

Date: 16.AUG.2016 16:22:35

TX G mode CH11

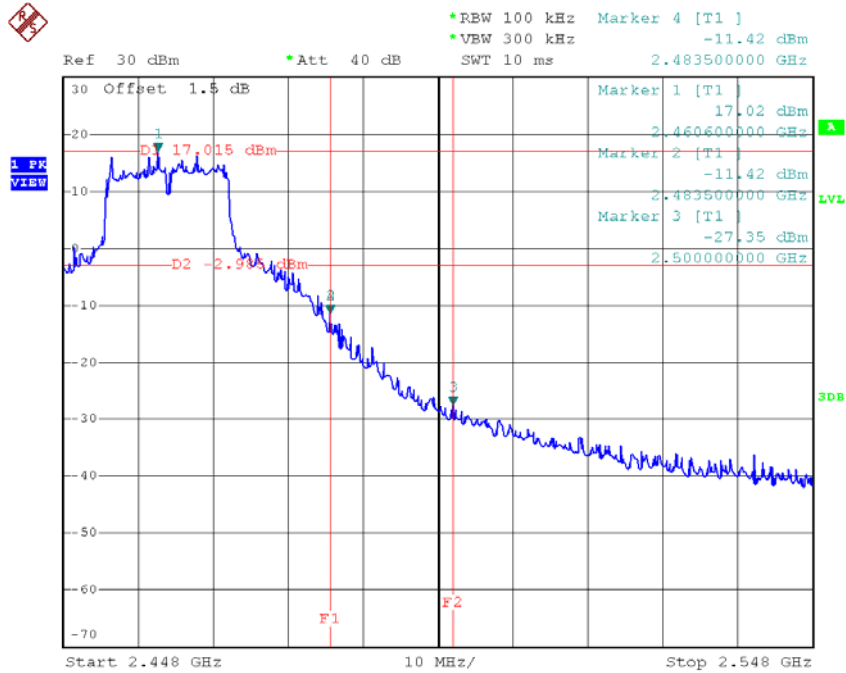

Date: 16.AUG.2016 16:29:57

TX G mode CH01 (10 Harmonic of the frequency)

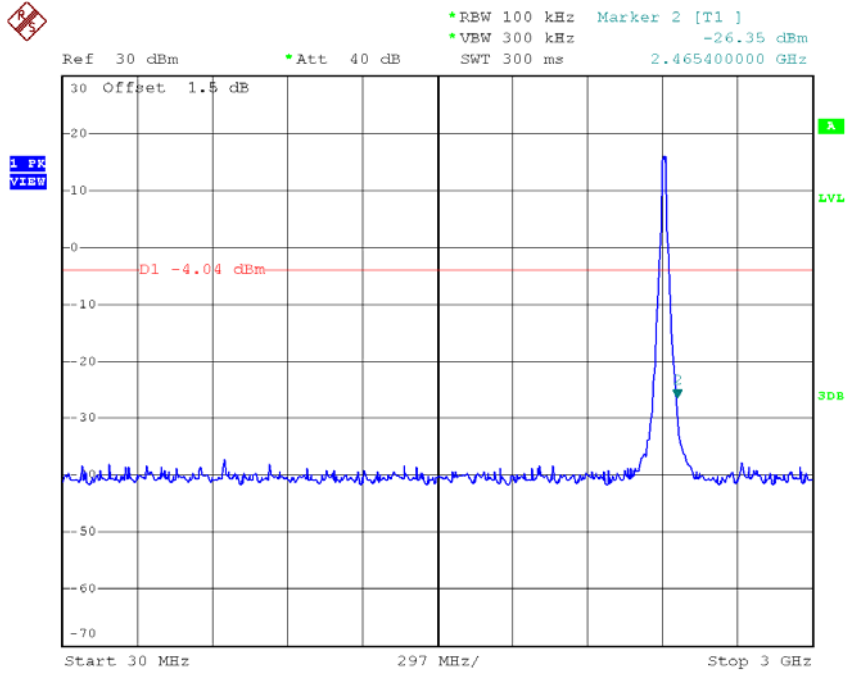

Date: 16.AUG.2016 16:17:59

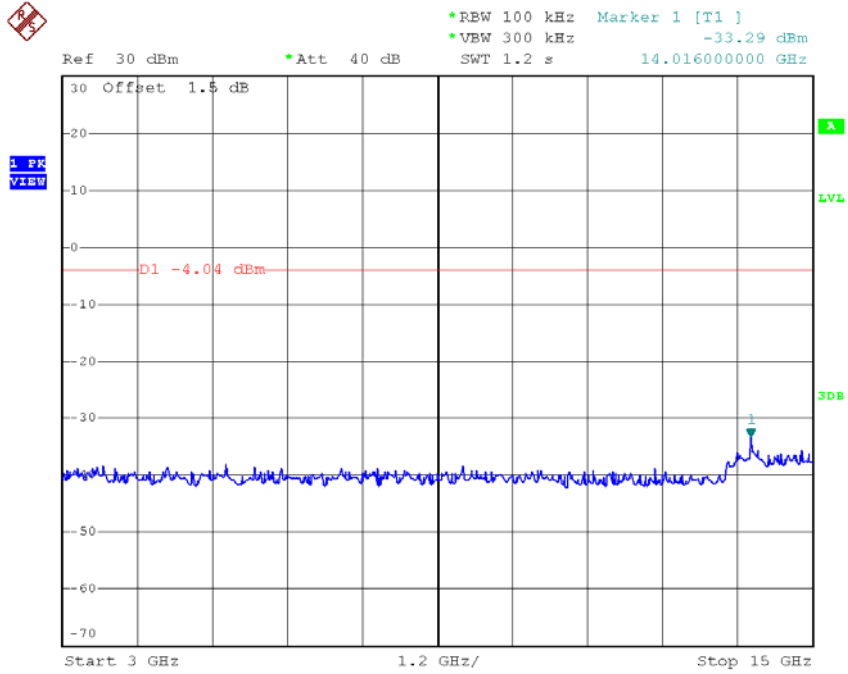

Date: 16.AUG.2016 16:18:07

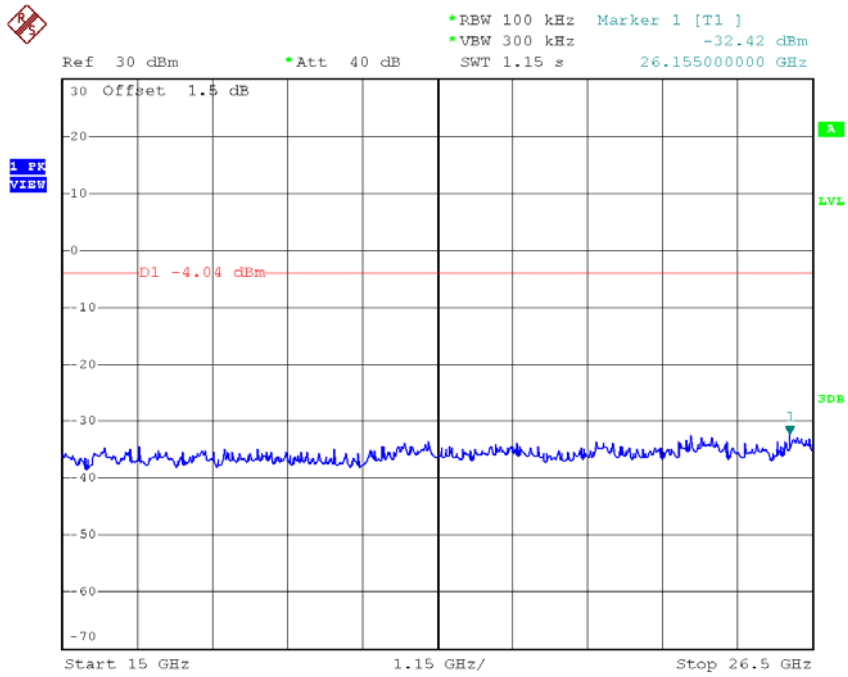

Date: 16.AUG.2016 16:18:15

TX G mode CH06 (10 Harmonic of the frequency)

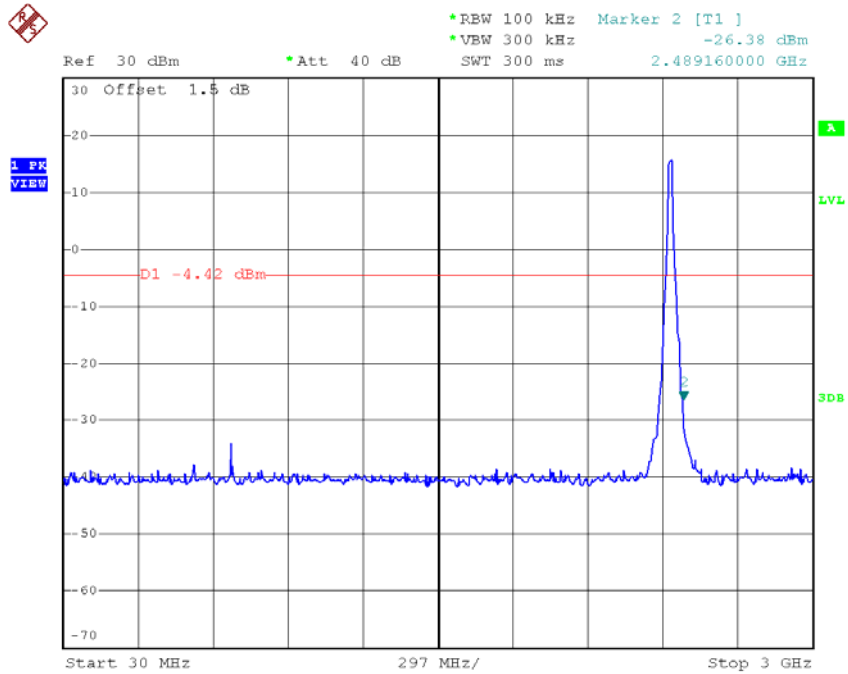

Date: 16.AUG.2016 16:24:37



Ref 30 dBm *Att 40 dB *RBW 100 kHz Marker 1 [T1]
*VBW 300 kHz -34.65 dBm
SWT 1.2 s 14.016000000 GHz

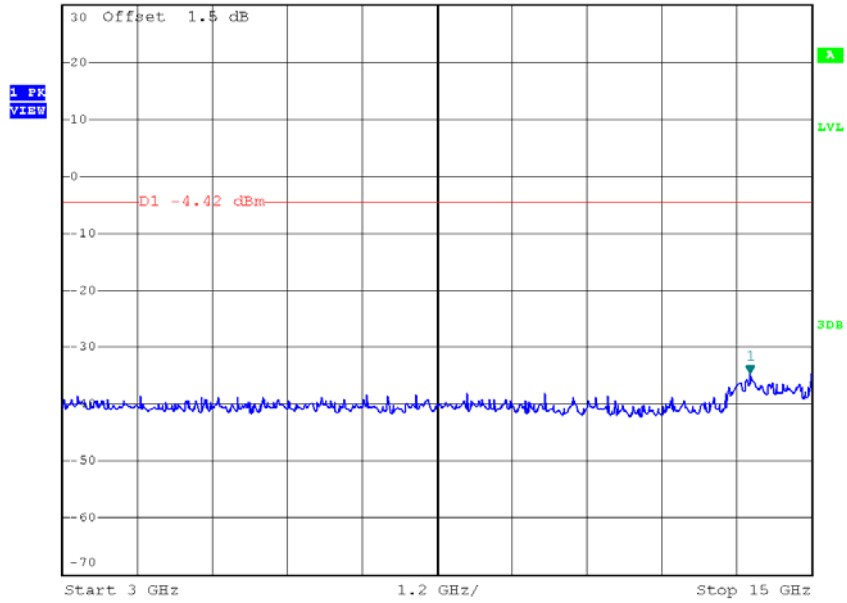

Date: 16.AUG.2016 16:24:45



Ref 30 dBm *Att 40 dB *RBW 100 kHz Marker 1 [T1]
*VBW 300 kHz -32.63 dBm
SWT 1.15 s 26.201000000 GHz

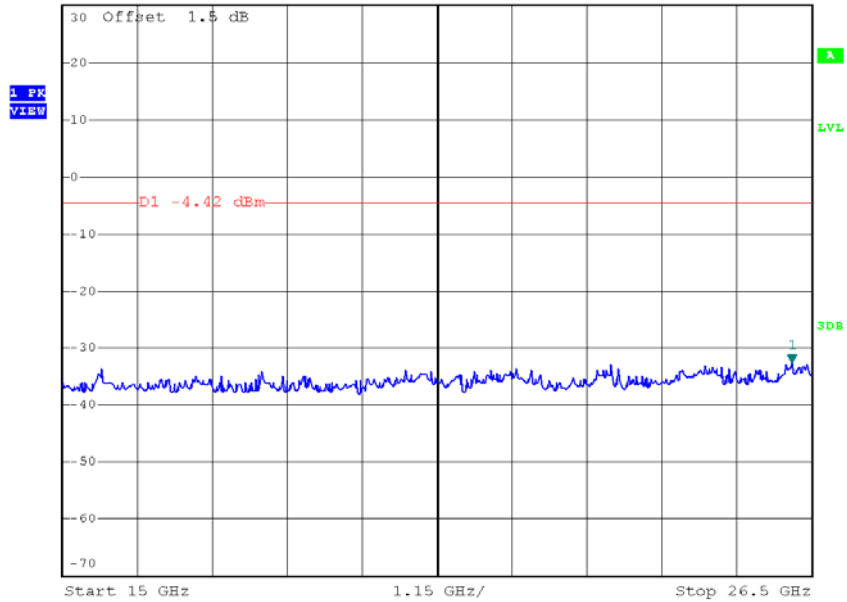

Date: 16.AUG.2016 16:24:54

TX G mode CH11 (10 Harmonic of the frequency)

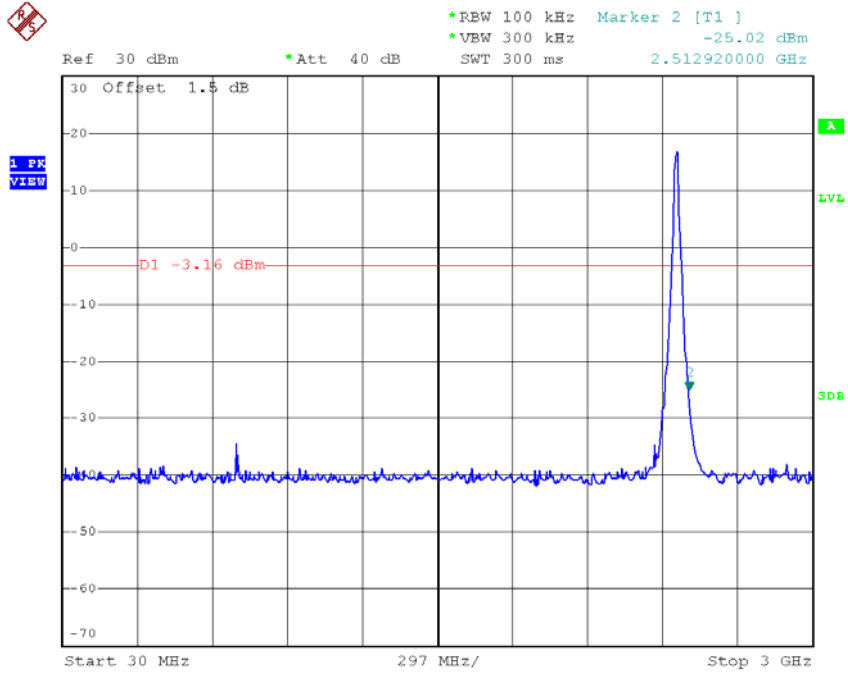

Date: 16.AUG.2016 16:27:07

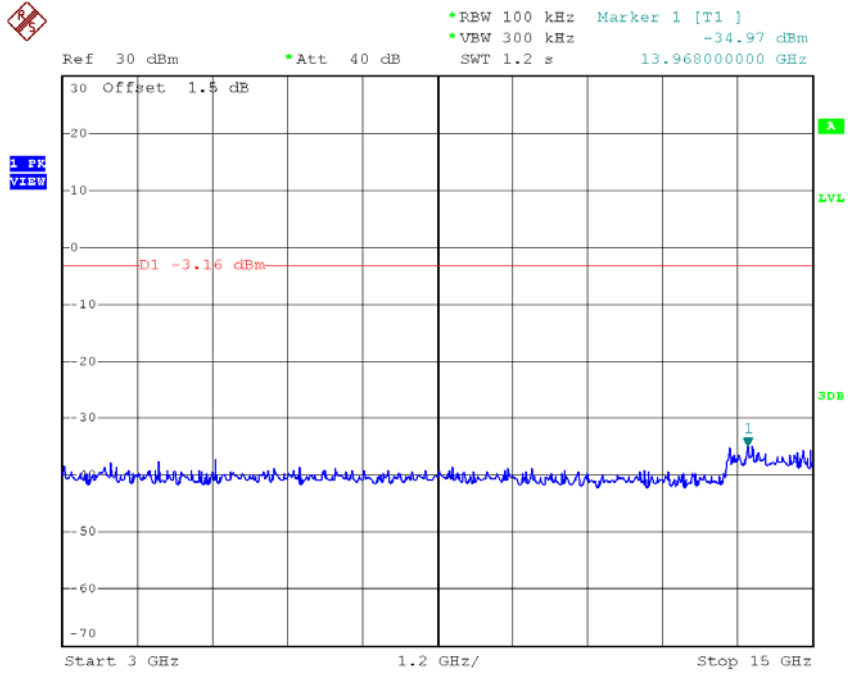

Date: 16.AUG.2016 16:27:16

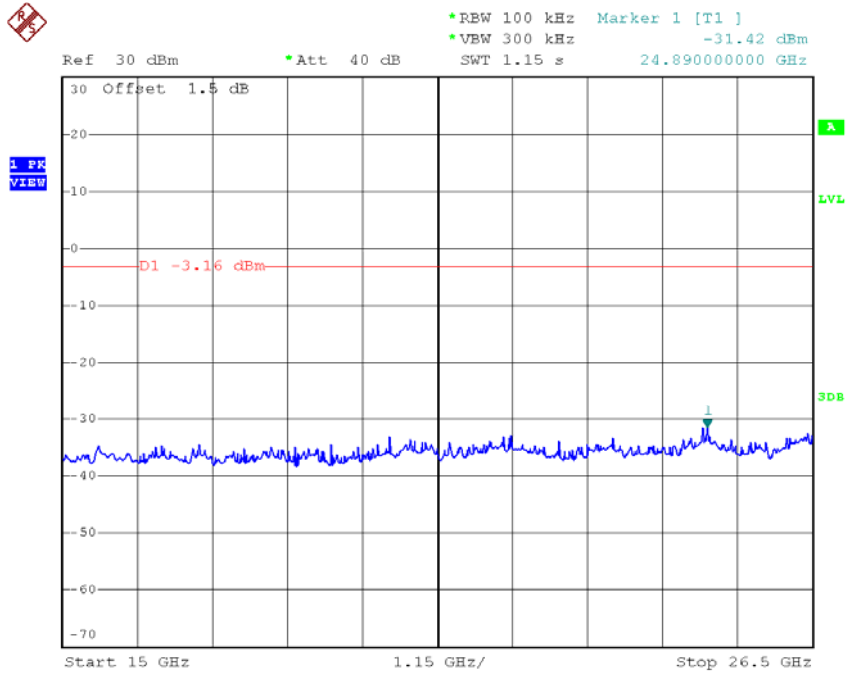

Date: 16.AUG.2016 16:27:24

Test Mode : TX N-20M Mode_ANT 1

TX HT20 mode CH01

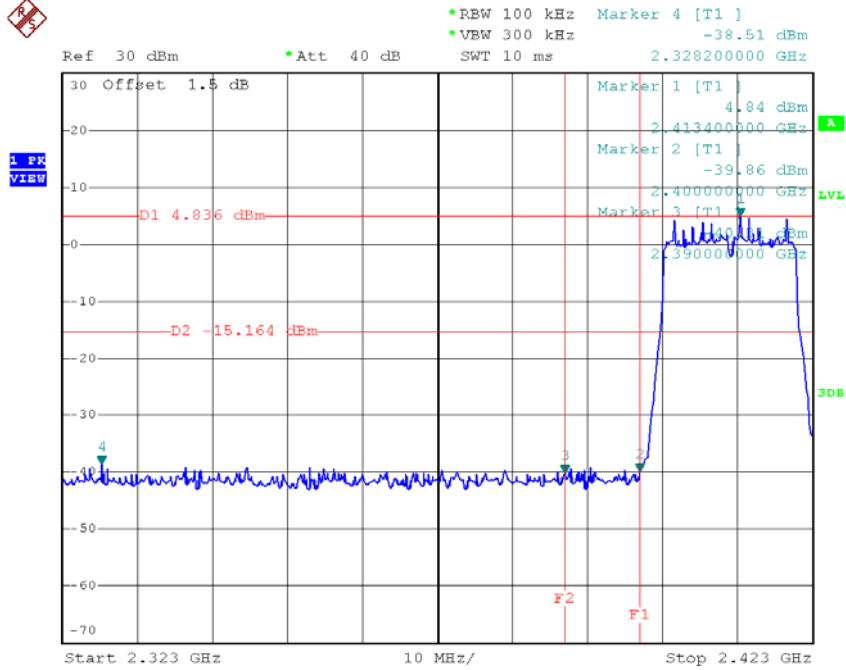

Date: 16.AUG.2016 16:33:38

TX HT20 mode CH11

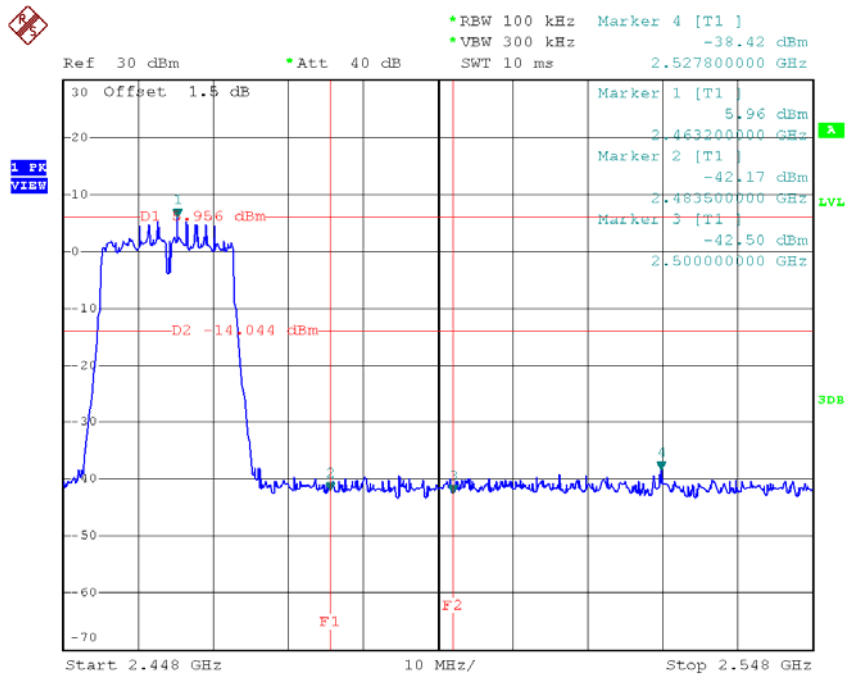

Date: 16.AUG.2016 16:43:07

TX HT20 mode CH01 (10 Harmonic of the frequency)

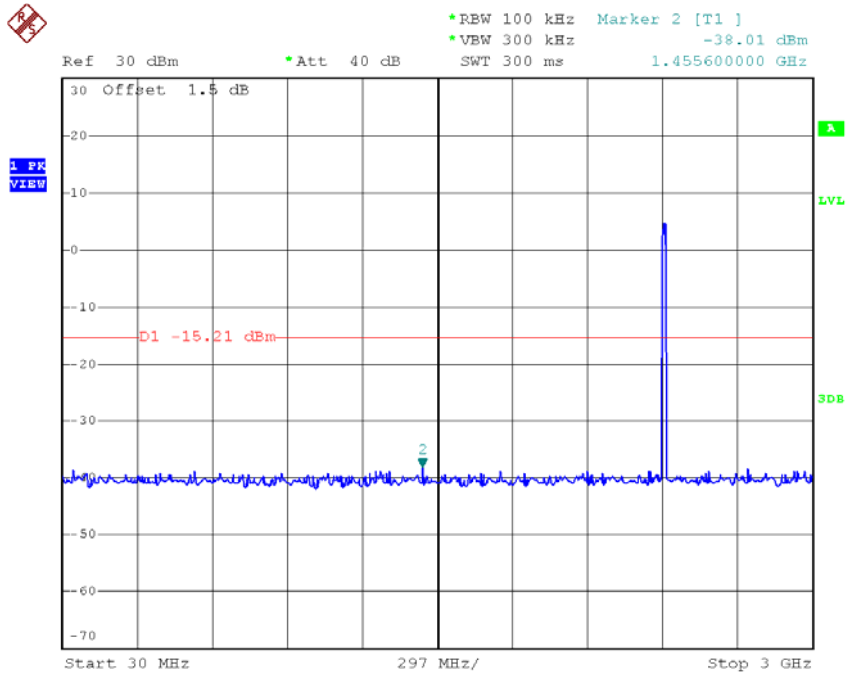

Date: 16.AUG.2016 16:33:13

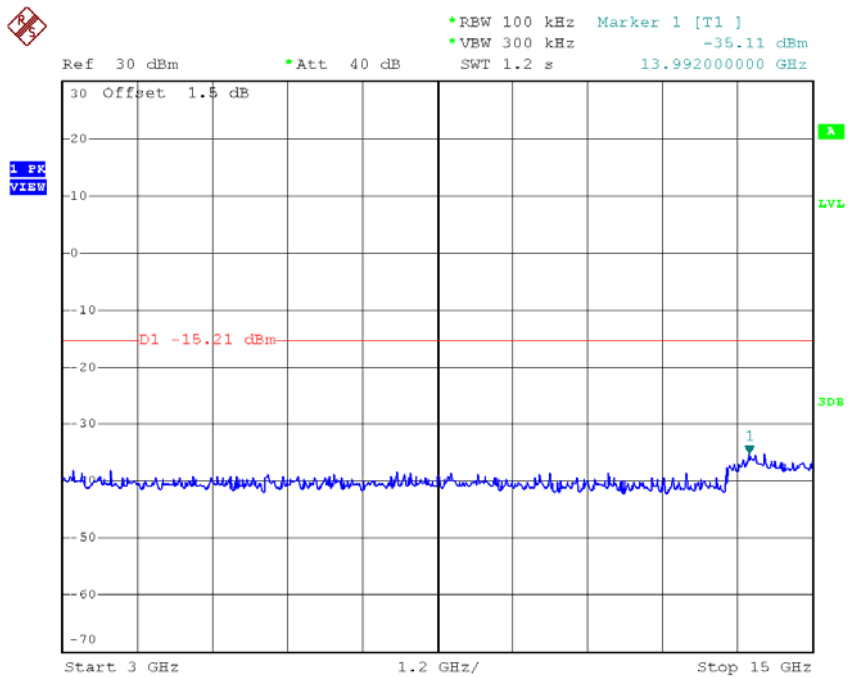

Date: 16.AUG.2016 16:33:22

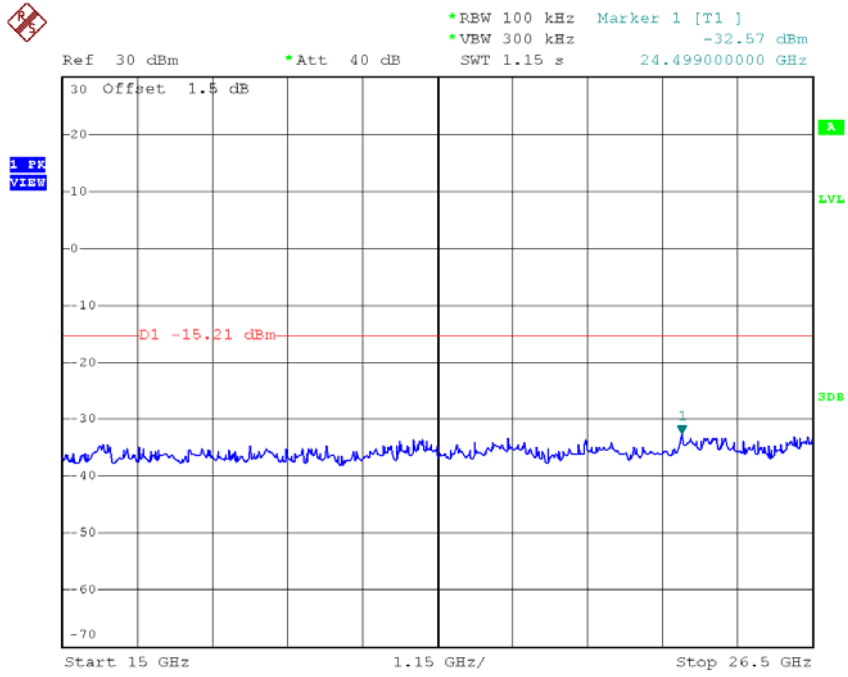

Date: 16.AUG.2016 16:33:30

TX HT20 mode CH06 (10 Harmonic of the frequency)

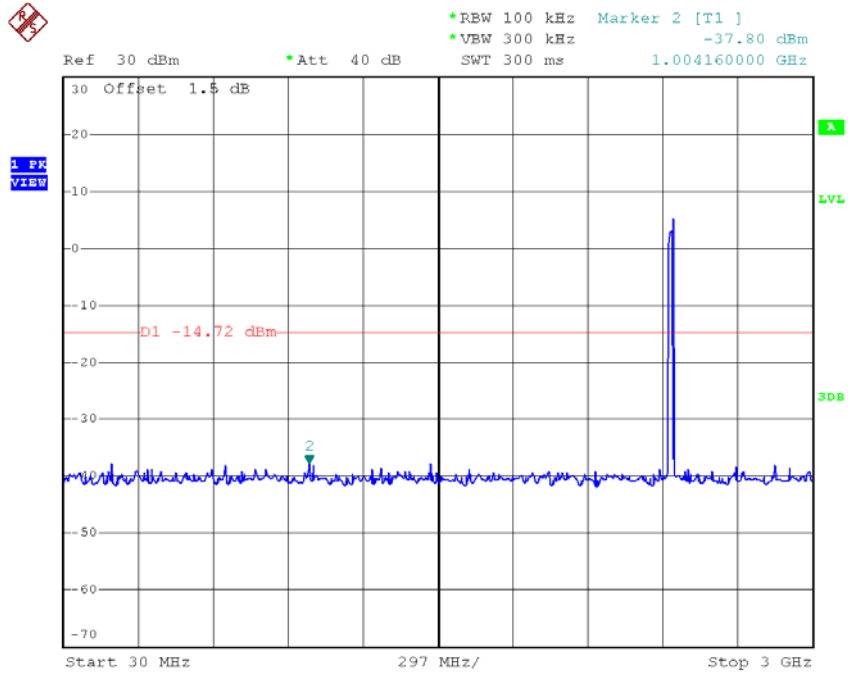

Date: 16.AUG.2016 16:34:35

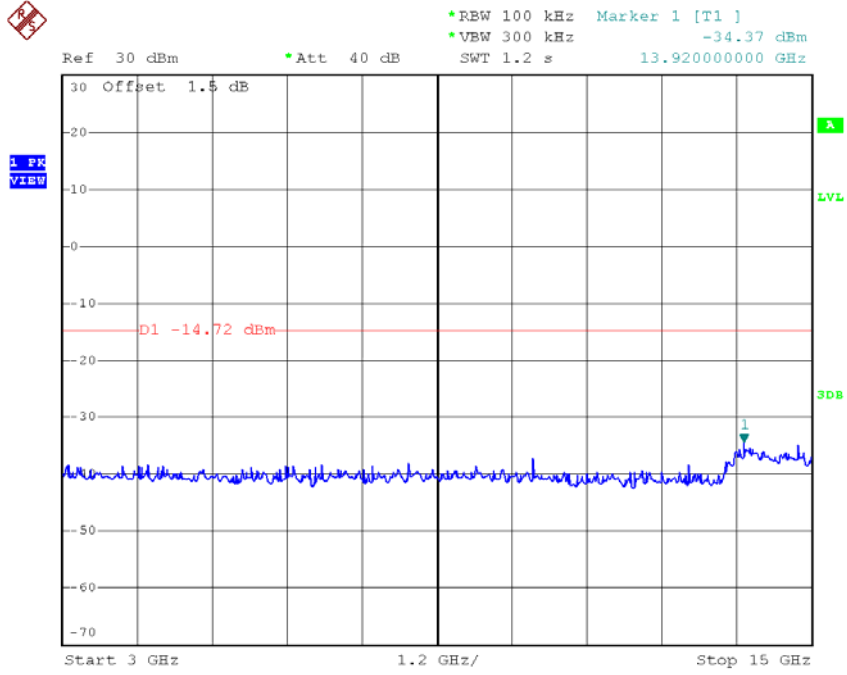

Date: 16.AUG.2016 16:34:44

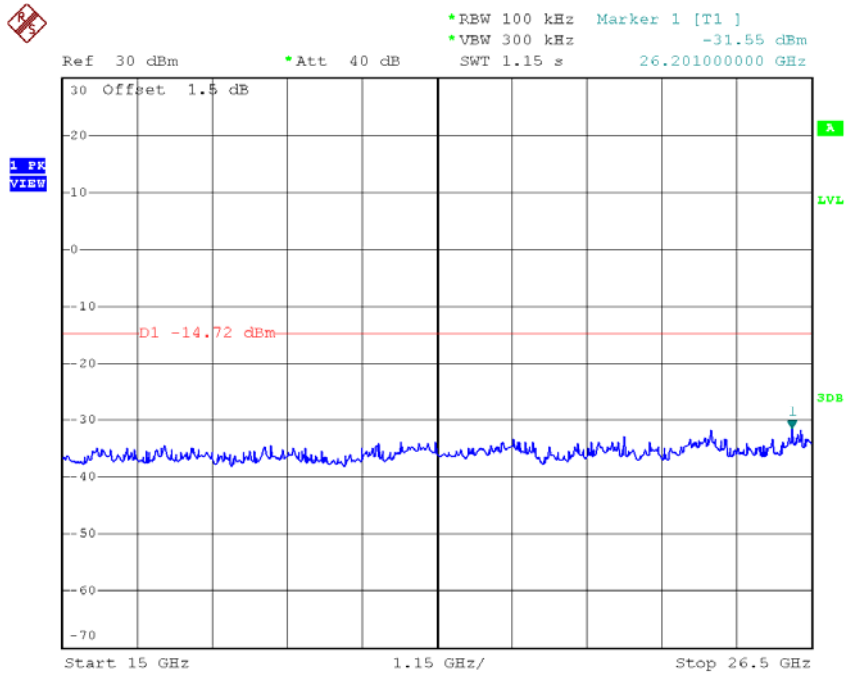

Date: 16.AUG.2016 16:34:52

TX HT20 mode CH11 (10 Harmonic of the frequency)

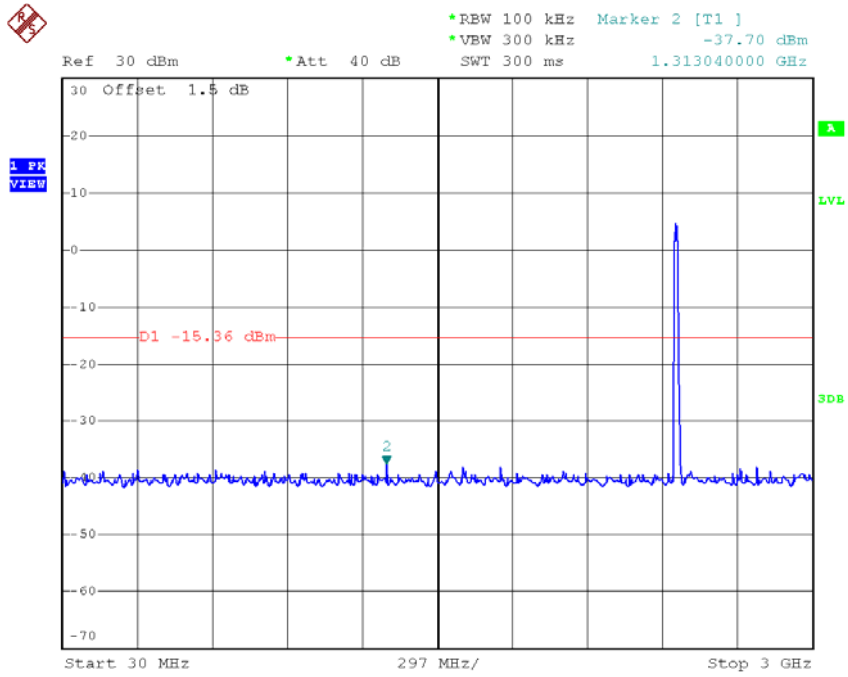

Date: 16.AUG.2016 16:42:42

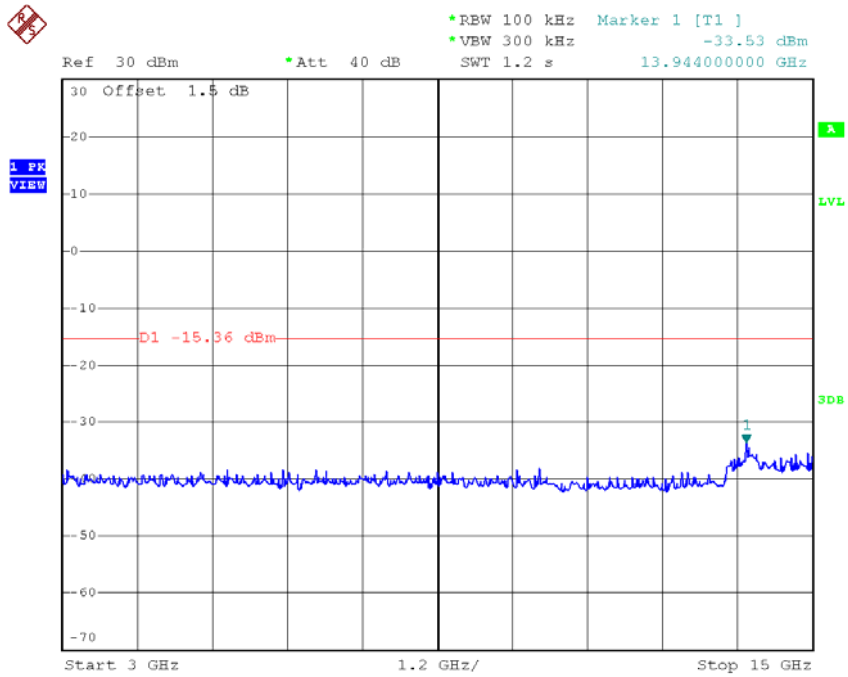

Date: 16.AUG.2016 16:42:51

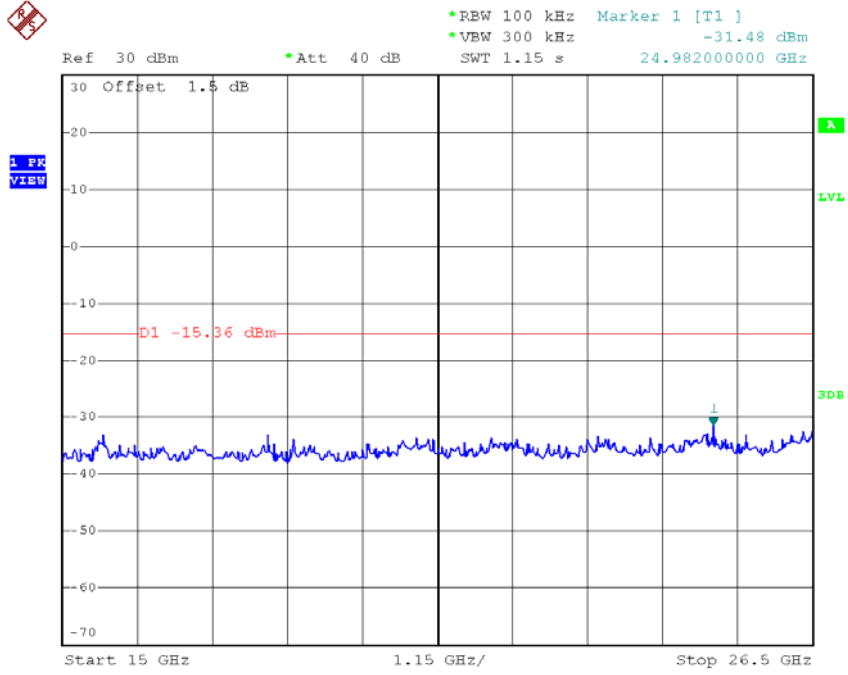

Date: 16.AUG.2016 16:42:59

Test Mode : TX N-20M Mode_ANT 2

TX HT20 mode CH01

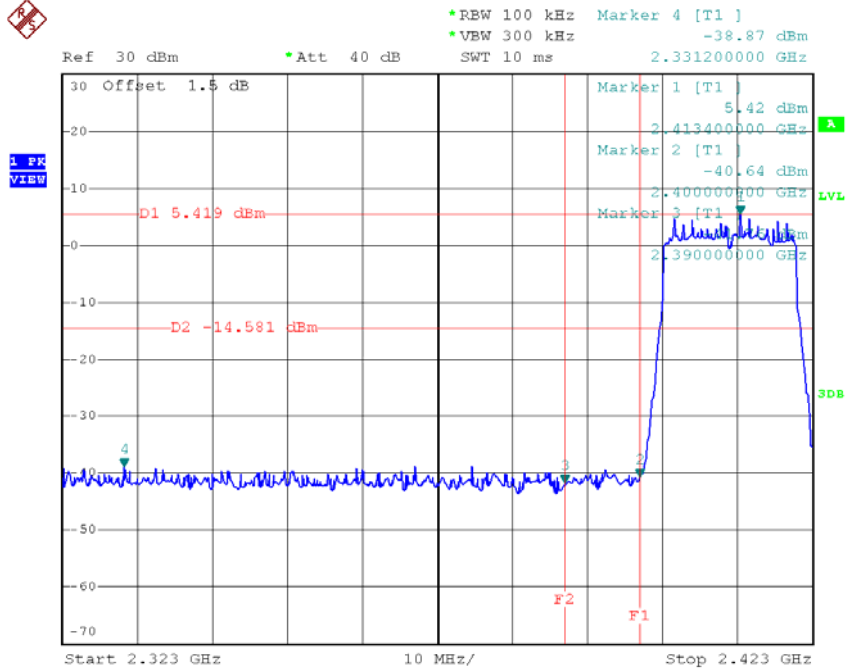

Date: 16.AUG.2016 16:51:05

TX HT20 mode CH11

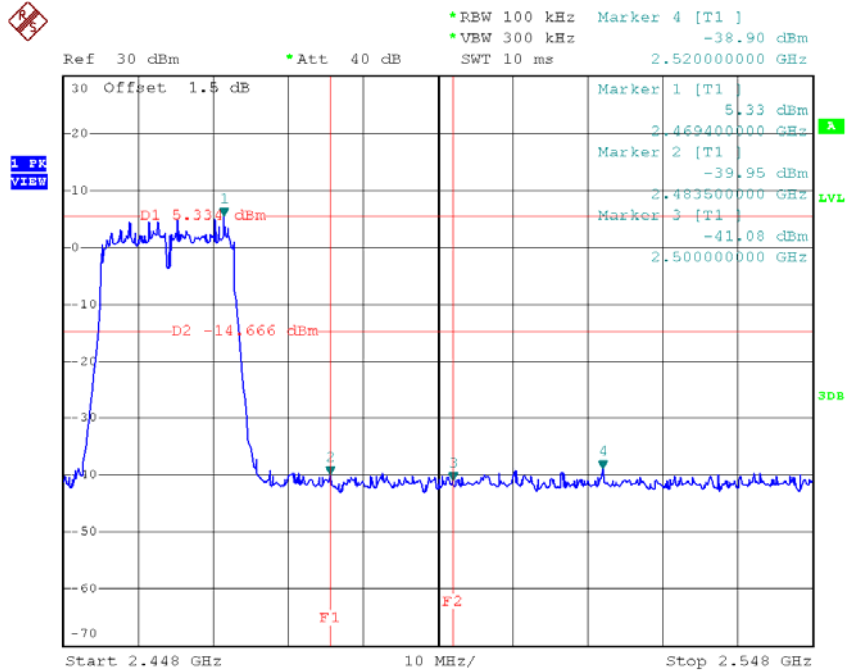

Date: 16.AUG.2016 16:53:29

TX HT20 mode CH01 (10 Harmonic of the frequency)

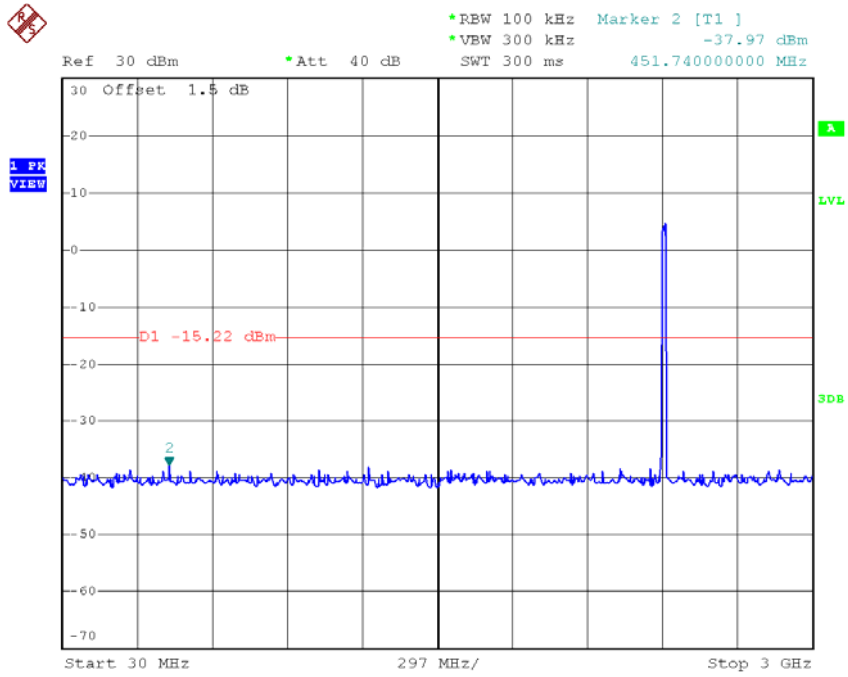

Date: 16.AUG.2016 16:50:41

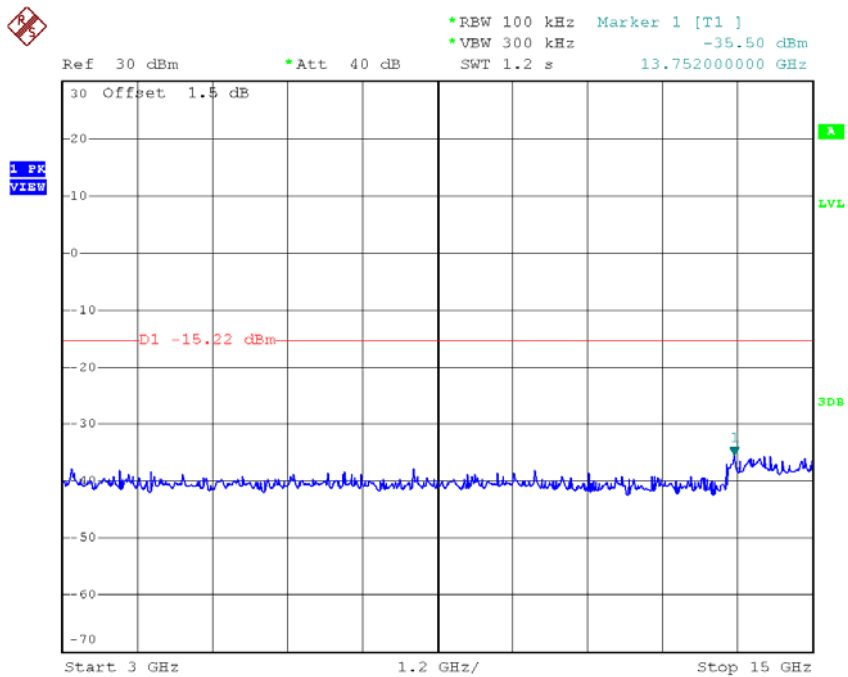

Date: 16.AUG.2016 16:50:50

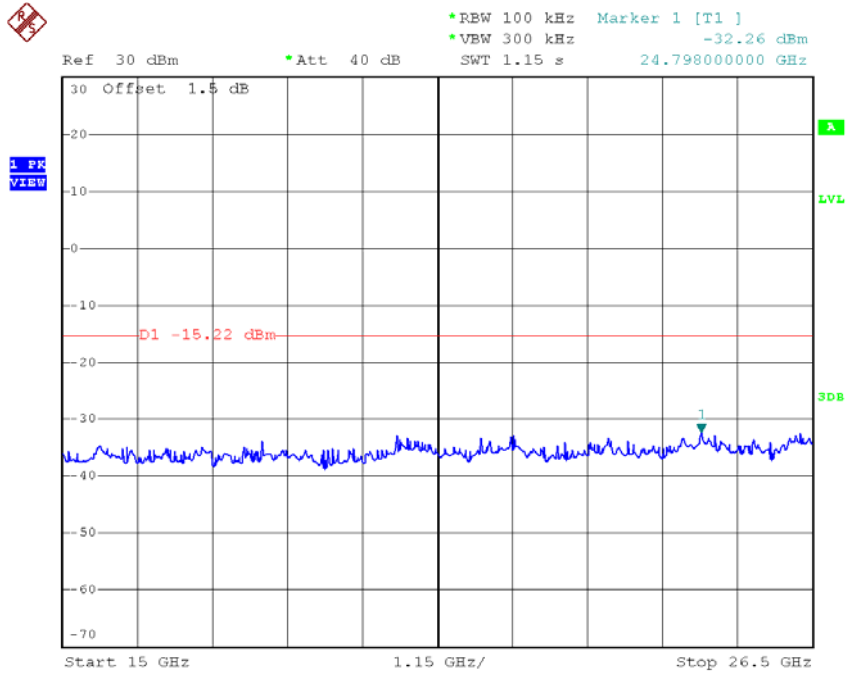

Date: 16.AUG.2016 16:50:58

TX HT20 mode CH06 (10 Harmonic of the frequency)

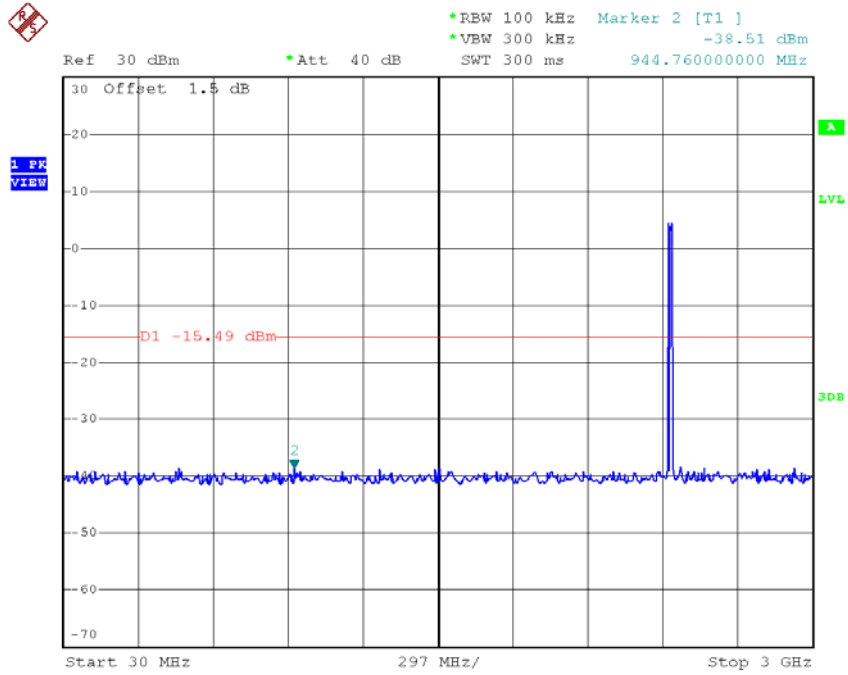

Date: 16.AUG.2016 16:51:57



Ref 30 dBm *Att 40 dB *REW 100 kHz Marker 1 [T1]
 *VBW 300 kHz -34.94 dBm
 SWT 1.2 s 14.040000000 GHz

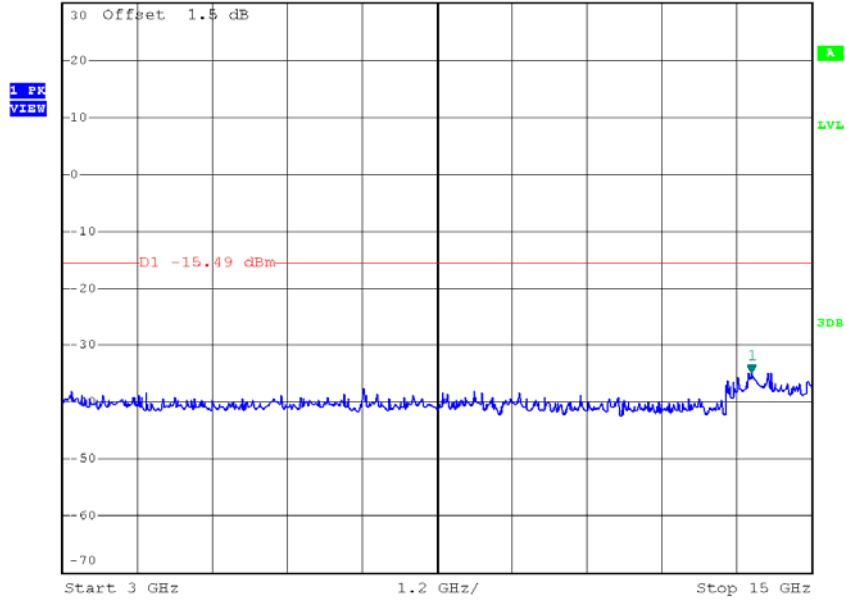

Date: 16.AUG.2016 16:52:06



Ref 30 dBm *Att 40 dB *REW 100 kHz Marker 1 [T1]
 *VBW 300 kHz -31.54 dBm
 SWT 1.15 s 26.431000000 GHz

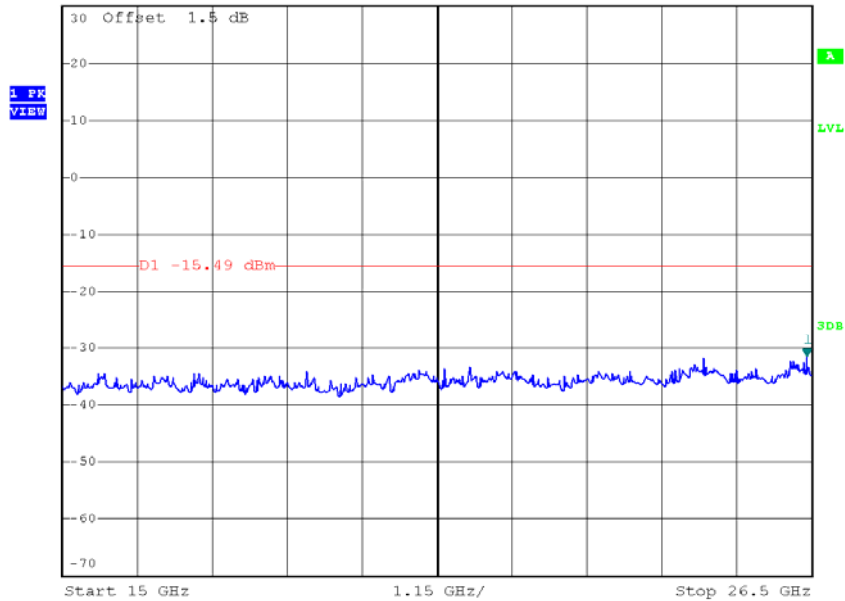

Date: 16.AUG.2016 16:52:14

TX HT20 mode CH11 (10 Harmonic of the frequency)

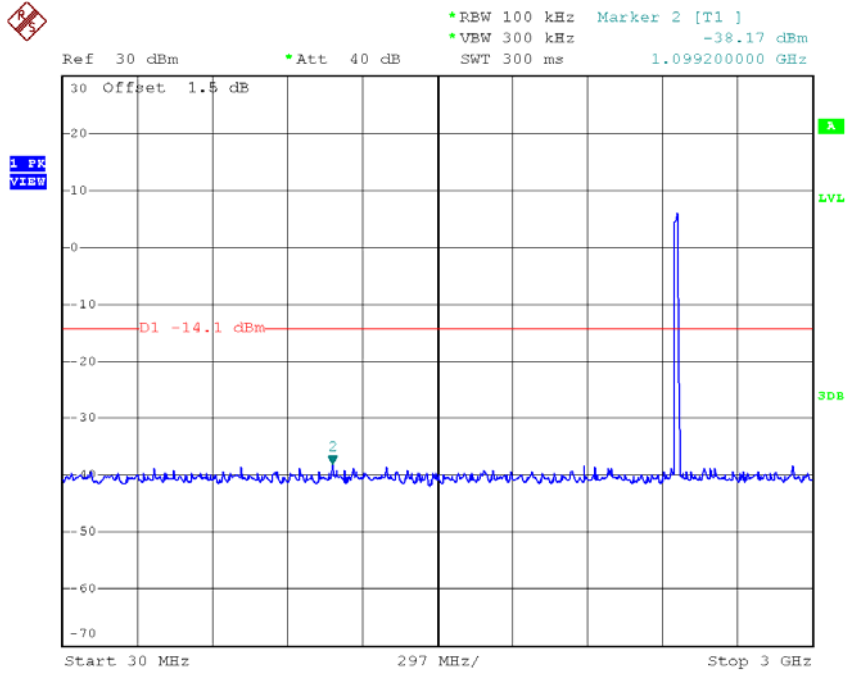

Date: 16.AUG.2016 16:53:04

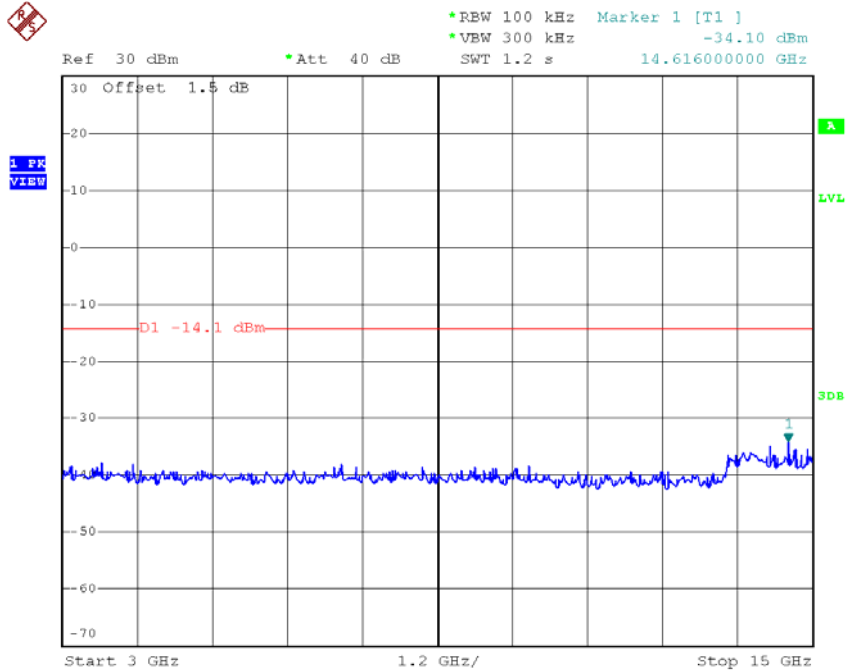

Date: 16.AUG.2016 16:53:13

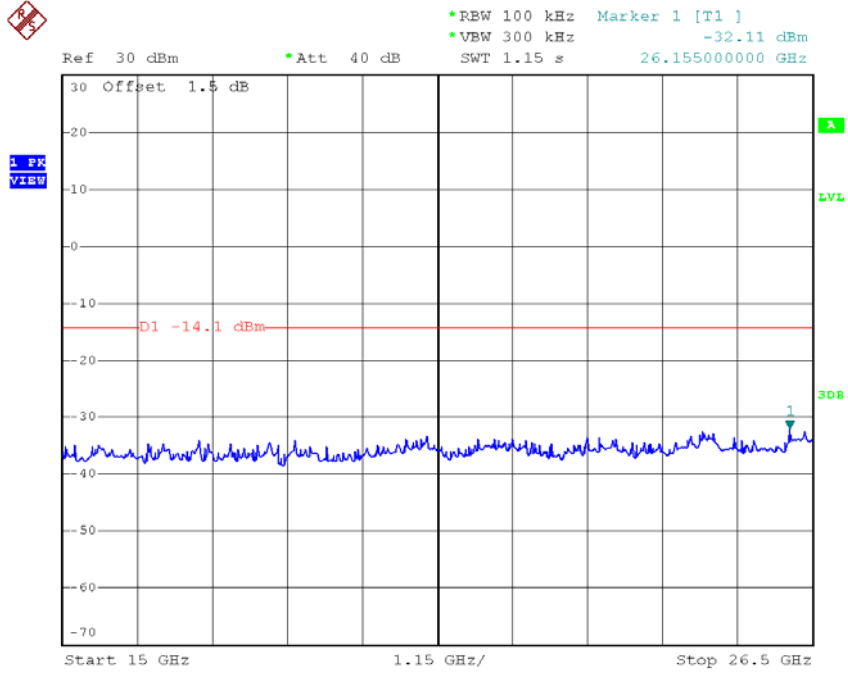

Date: 16.AUG.2016 16:53:21

Test Mode : TX N-20M Mode_ANT 3

TX HT20 mode CH01

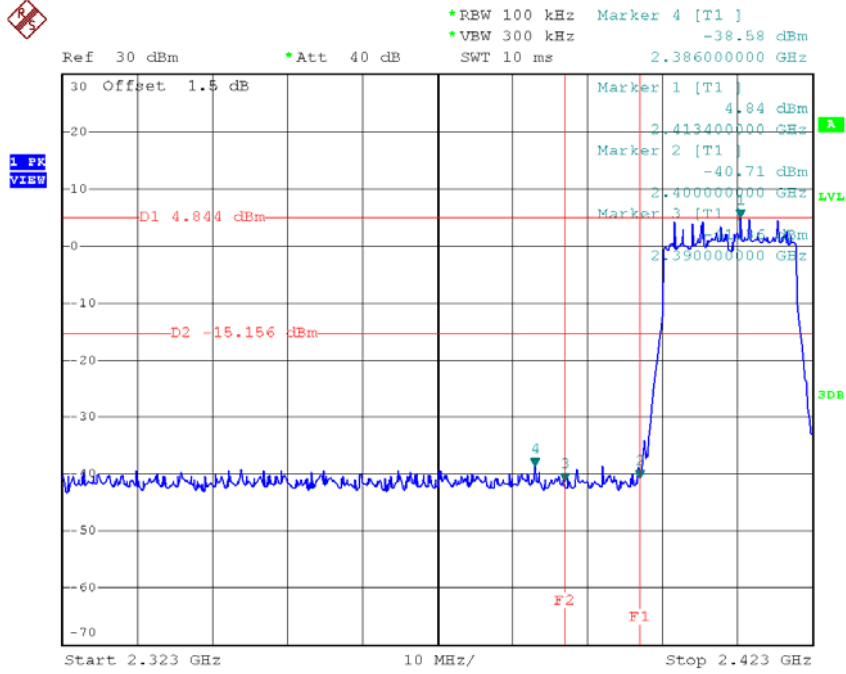

Date: 16.AUG.2016 16:58:48

TX HT20 mode CH11

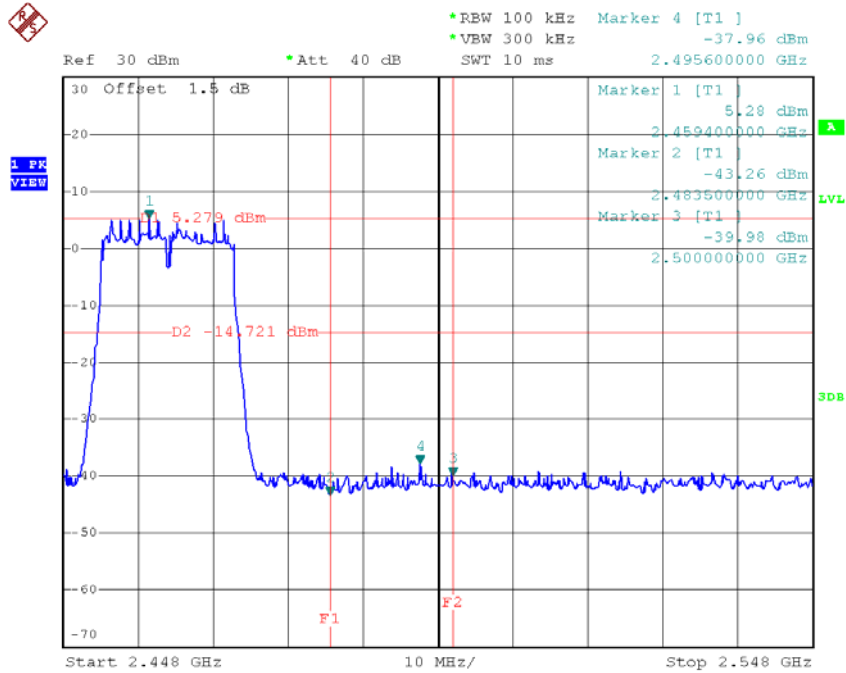

Date: 16.AUG.2016 17:01:40

TX HT20 mode CH01 (10 Harmonic of the frequency)

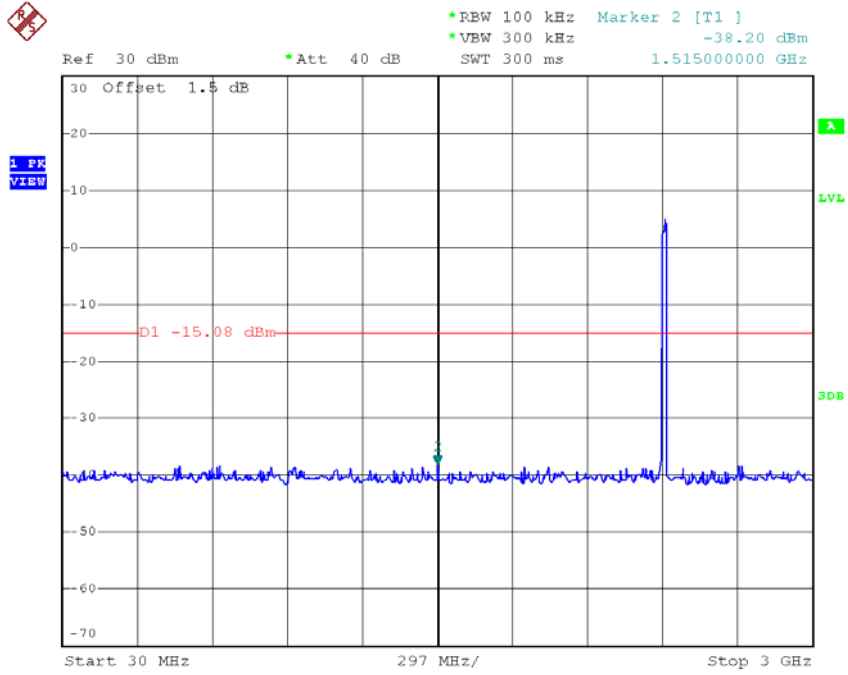

Date: 16.AUG.2016 16:58:24

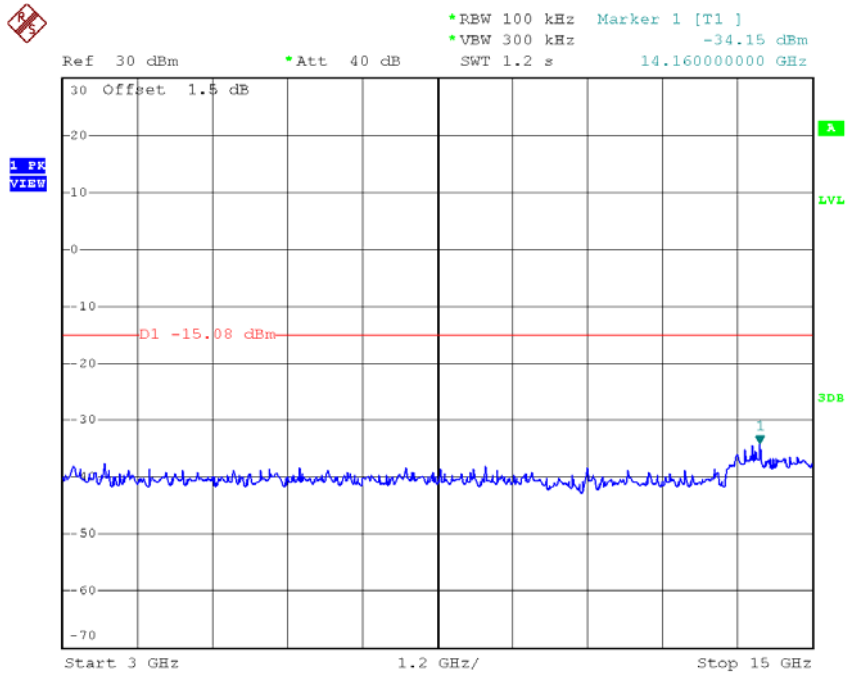

Date: 16.AUG.2016 16:58:32

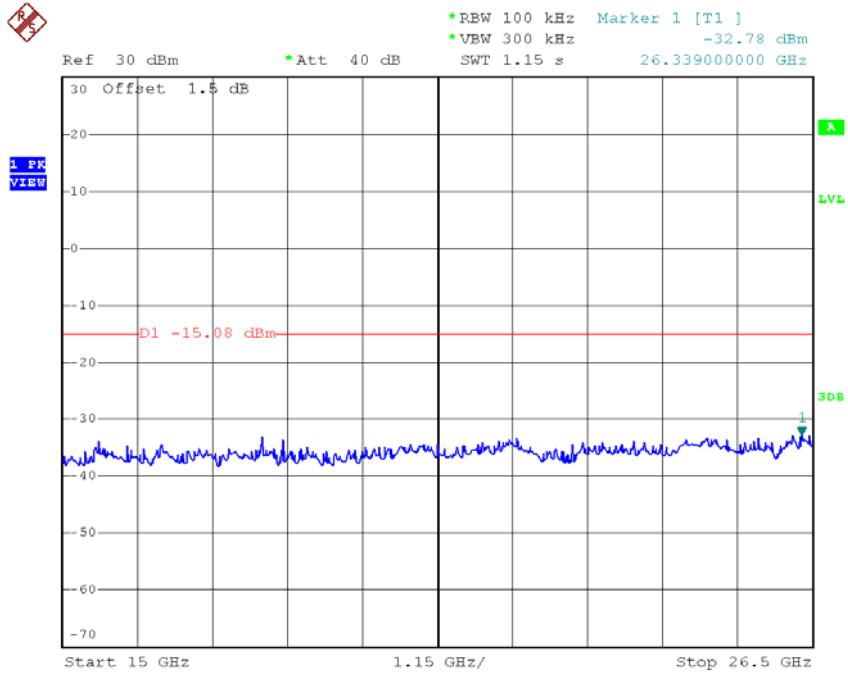

Date: 16.AUG.2016 16:58:40

TX HT20 mode CH06 (10 Harmonic of the frequency)

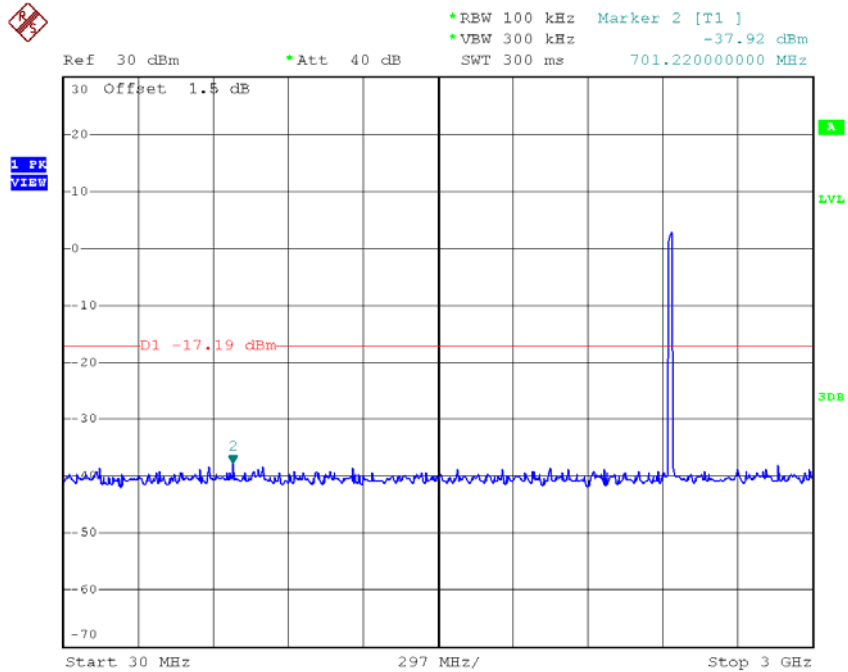

Date: 16.AUG.2016 17:00:10

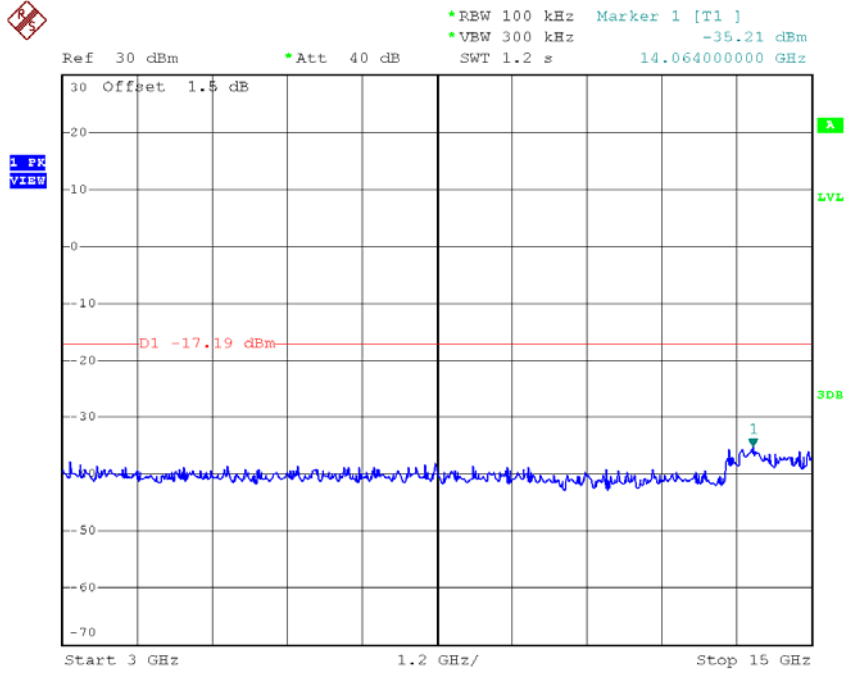

Date: 16.AUG.2016 17:00:19

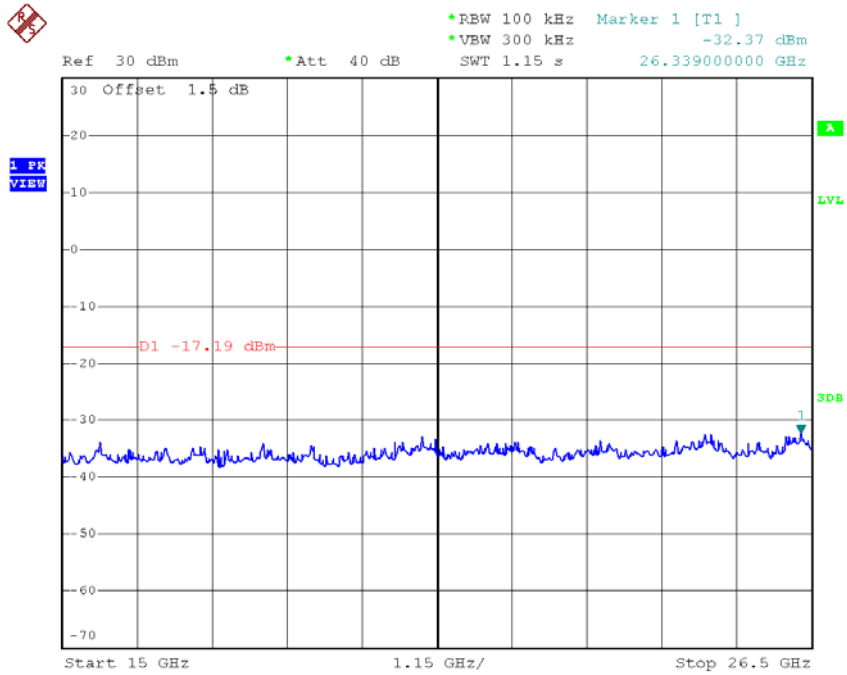

Date: 16.AUG.2016 17:00:27

TX HT20 mode CH11 (10 Harmonic of the frequency)

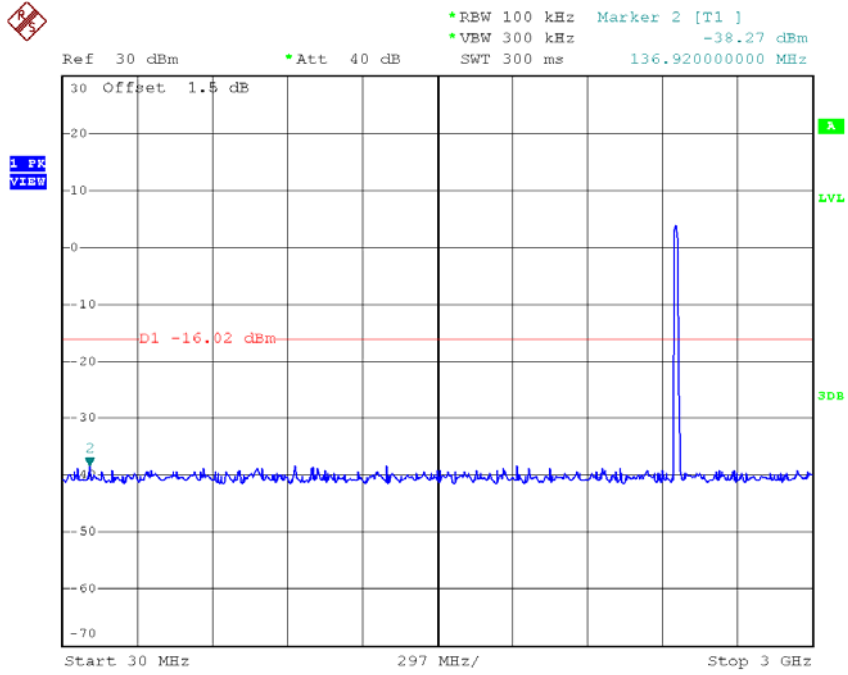

Date: 16.AUG.2016 17:01:16

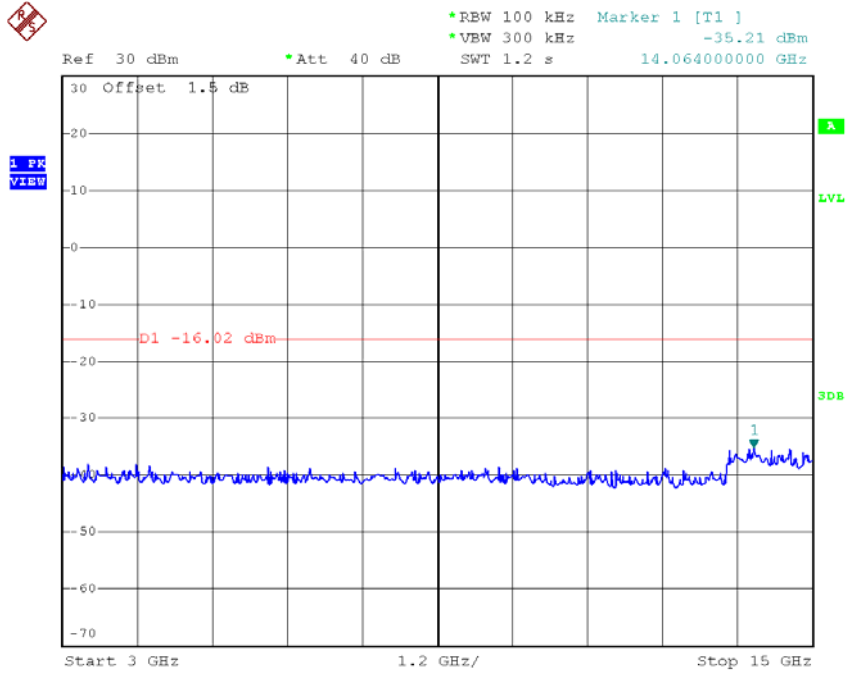

Date: 16.AUG.2016 17:01:24

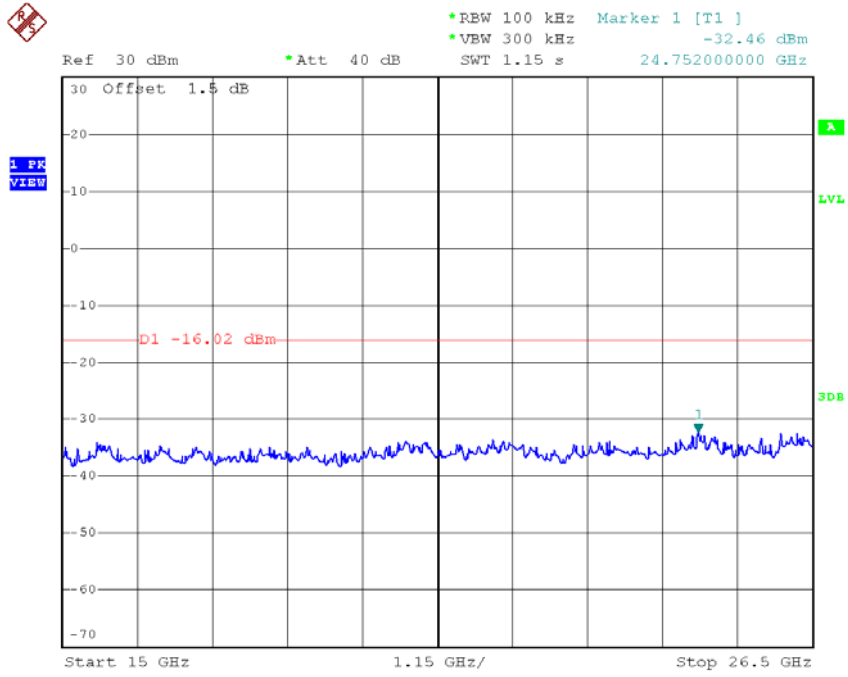

Date: 16.AUG.2016 17:01:33

Test Mode : TX N-40M Mode_ANT 1

TX HT40 mode CH03

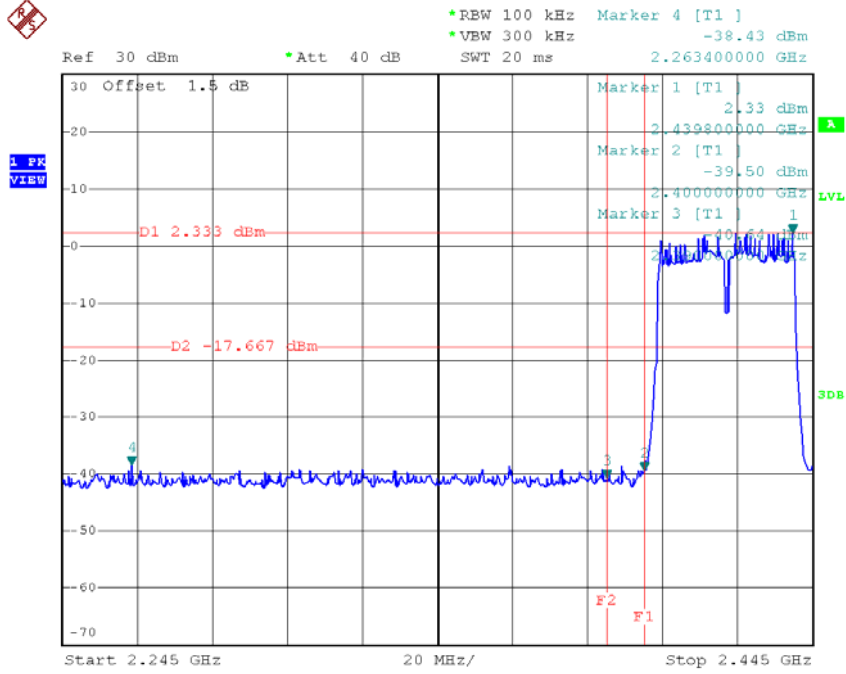

Date: 16.AUG.2016 16:46:24

TX HT40 mode CH09

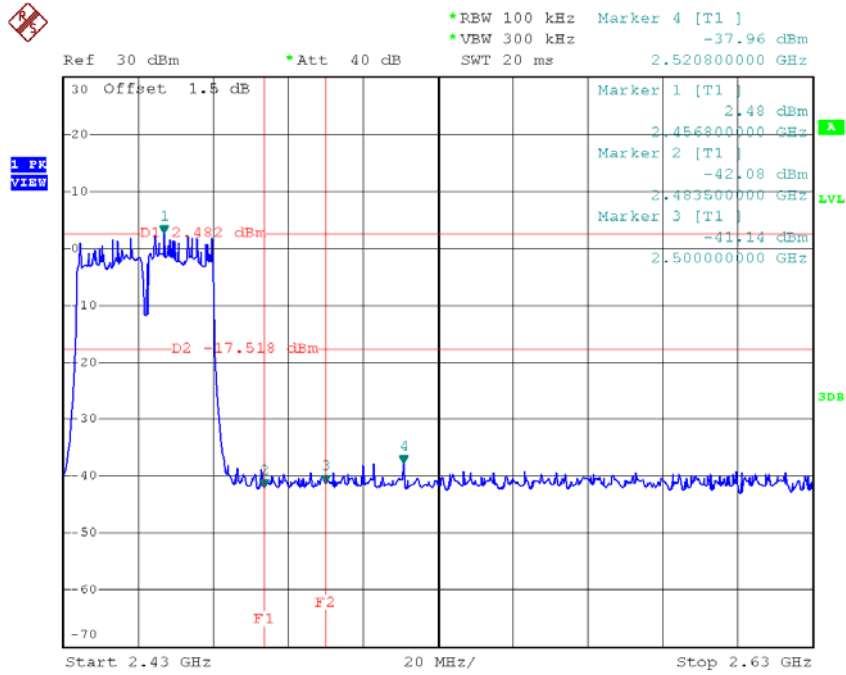

Date: 16.AUG.2016 16:49:10

TX HT40 mode CH03 (10 Harmonic of the frequency)

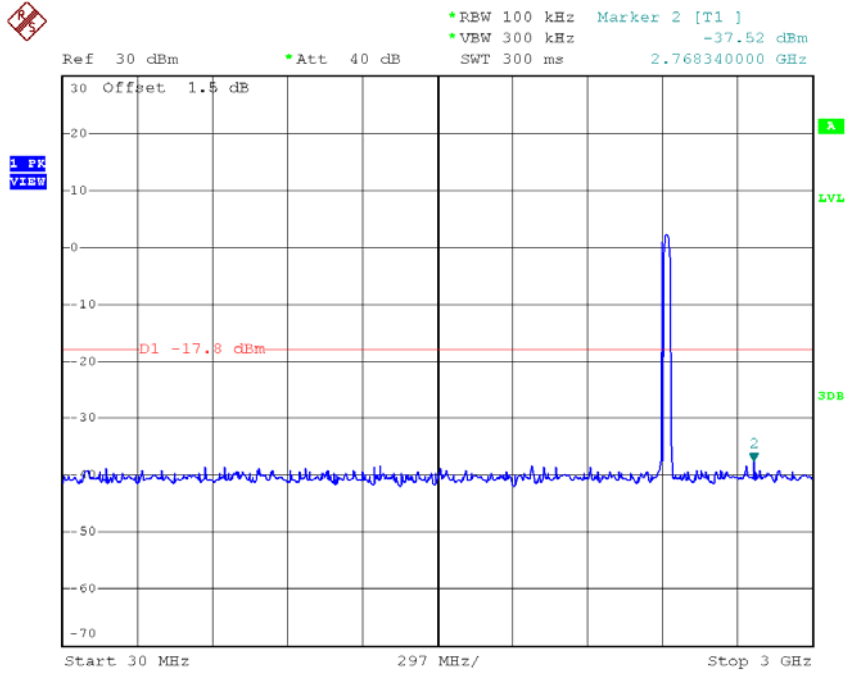

Date: 16.AUG.2016 16:46:00

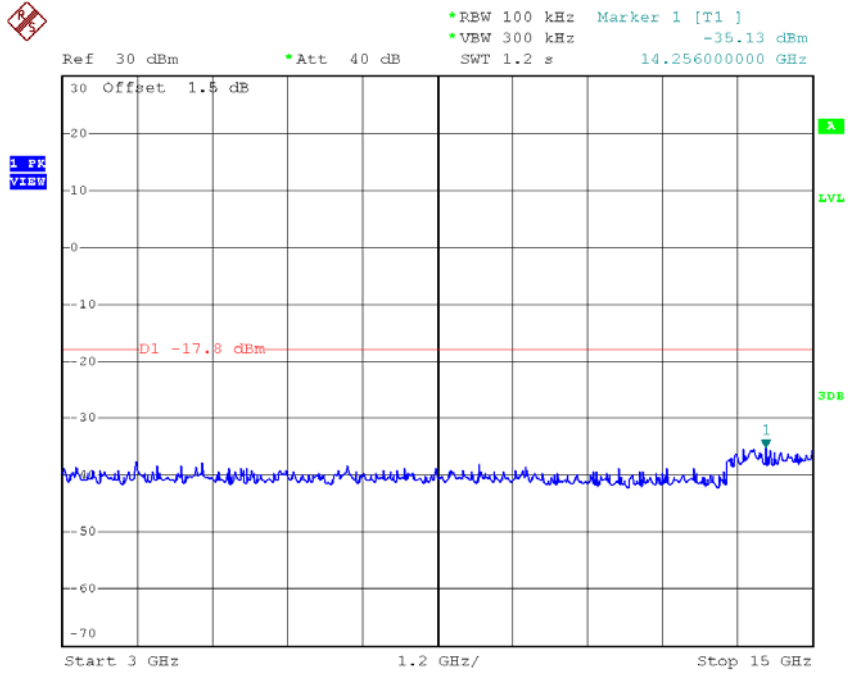

Date: 16.AUG.2016 16:46:08

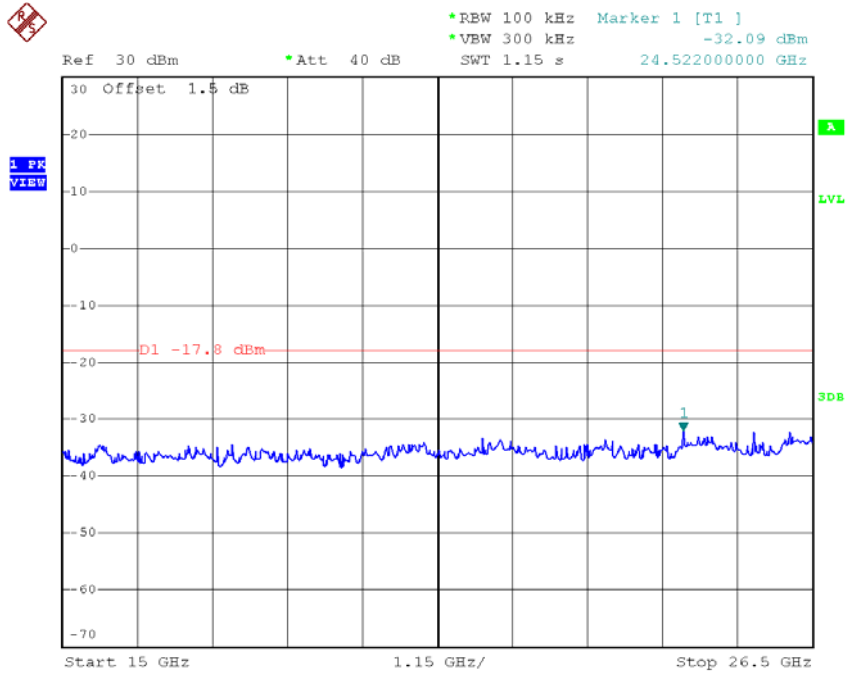

Date: 16.AUG.2016 16:46:17

TX HT40 mode CH06 (10 Harmonic of the frequency)

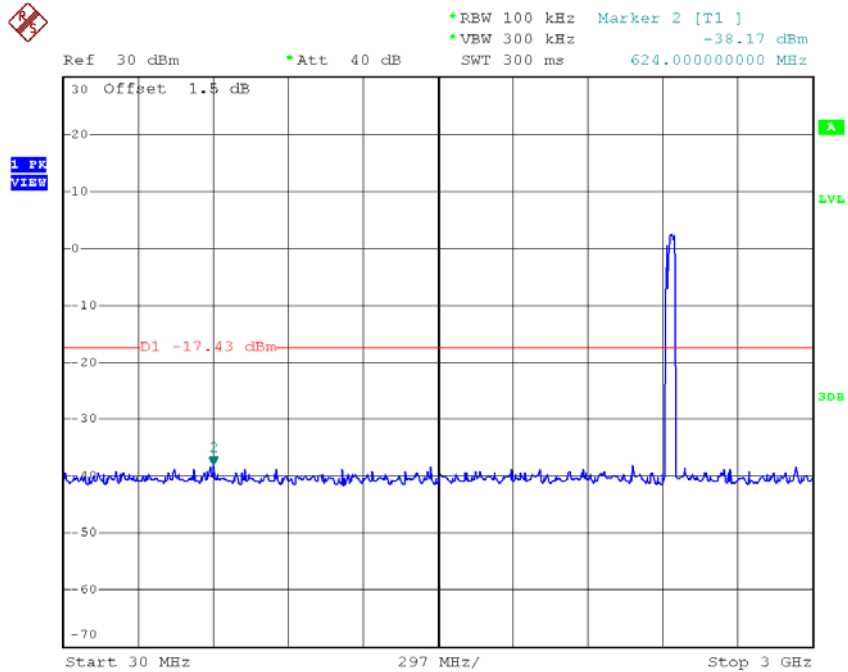

Date: 16.AUG.2016 16:47:33

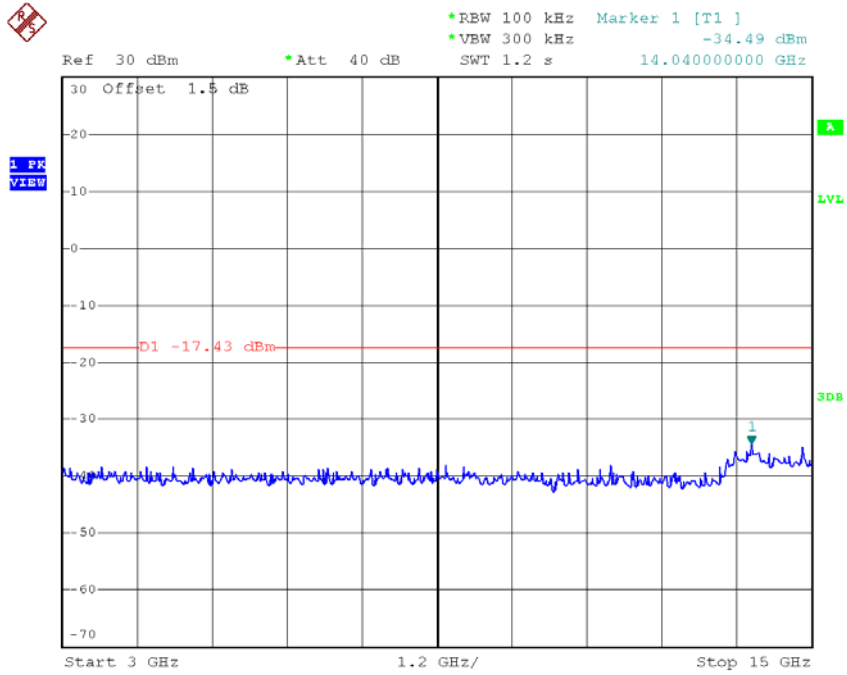

Date: 16.AUG.2016 16:47:41

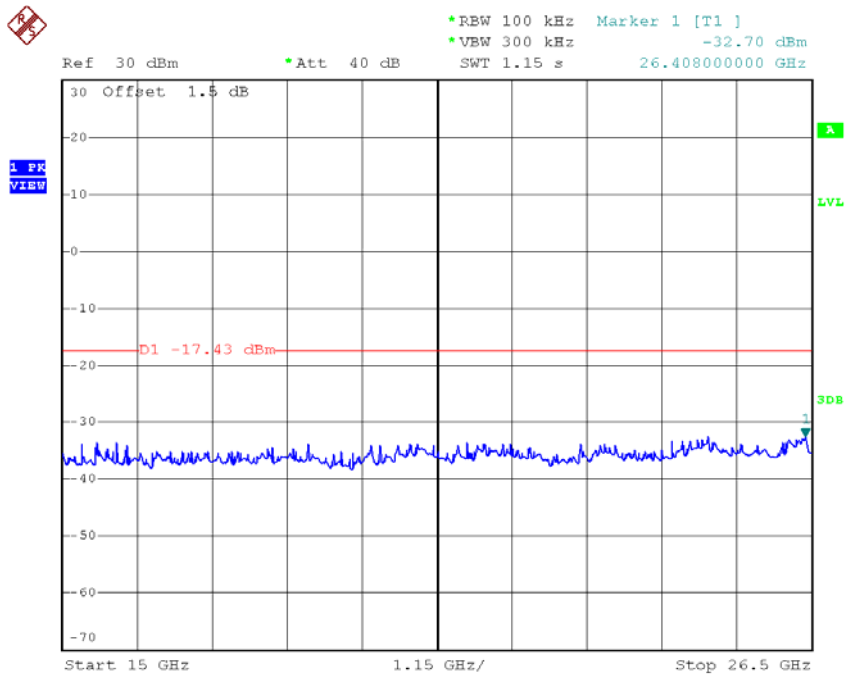

Date: 16.AUG.2016 16:47:49

TX HT40 mode CH09 (10 Harmonic of the frequency)

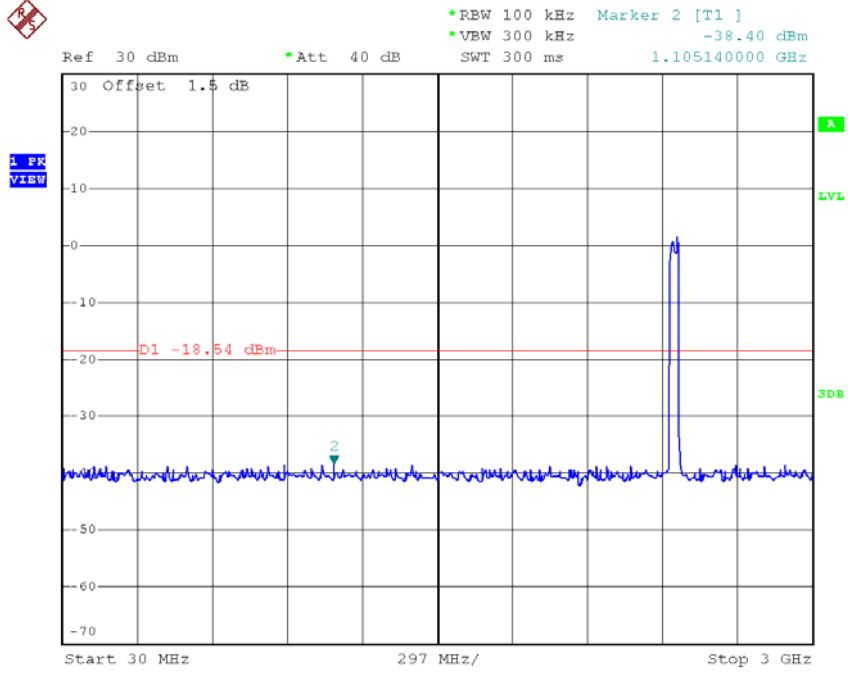

Date: 16.AUG.2016 16:48:45

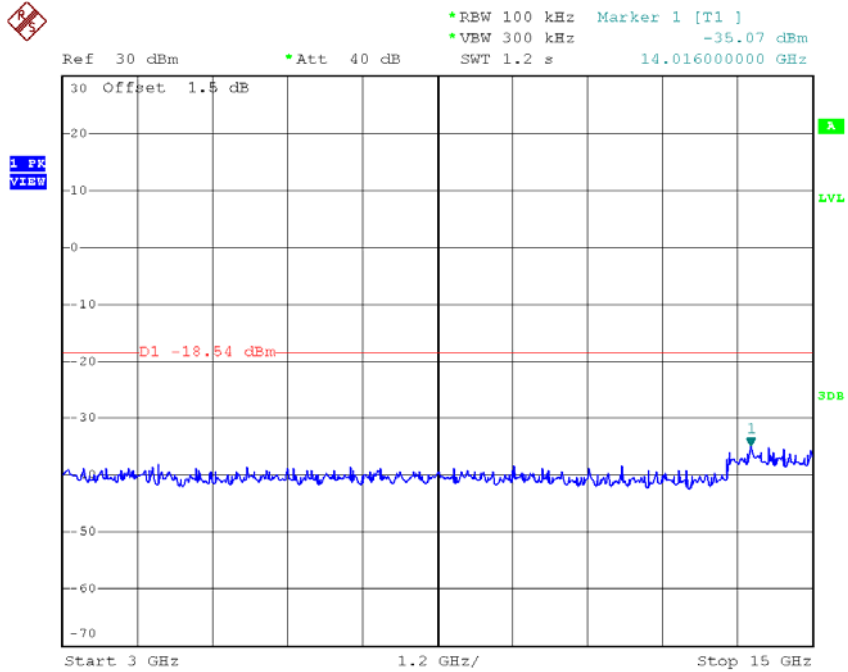

Date: 16.AUG.2016 16:48:54

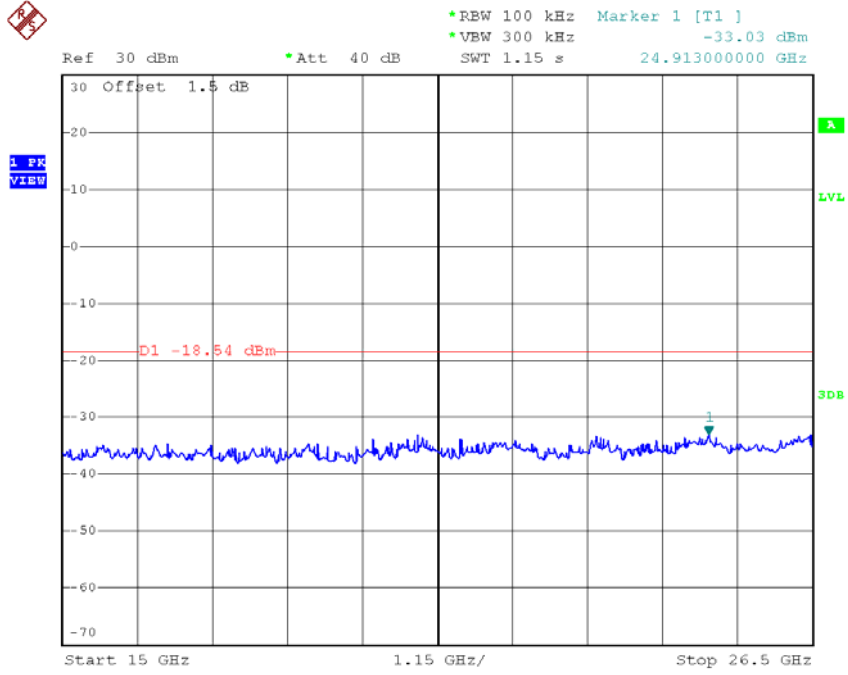

Date: 16.AUG.2016 16:49:02

Test Mode : TX N-40M Mode_ANT 2

TX HT40 mode CH03

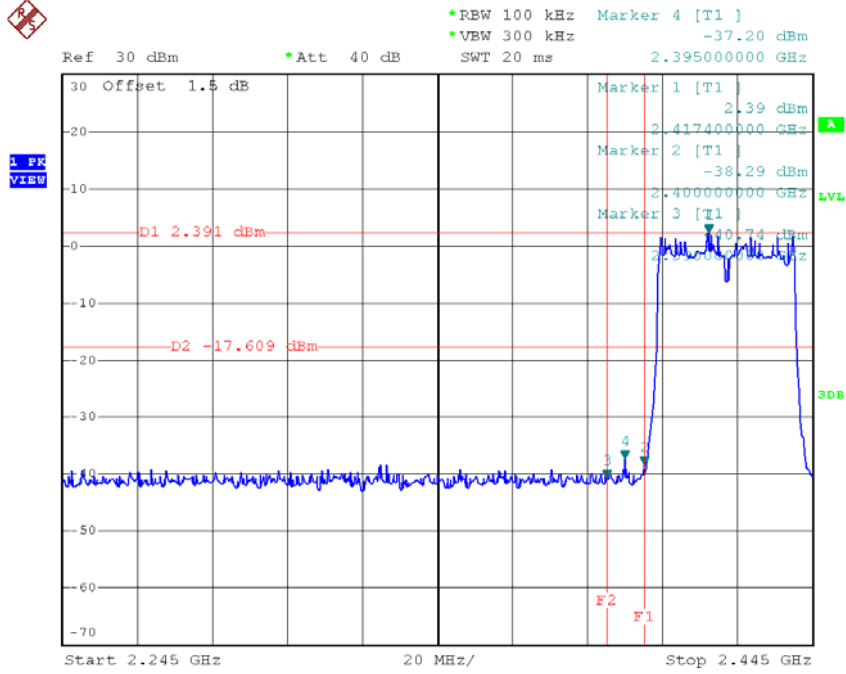

Date: 16.AUG.2016 16:54:49

TX HT40 mode CH09

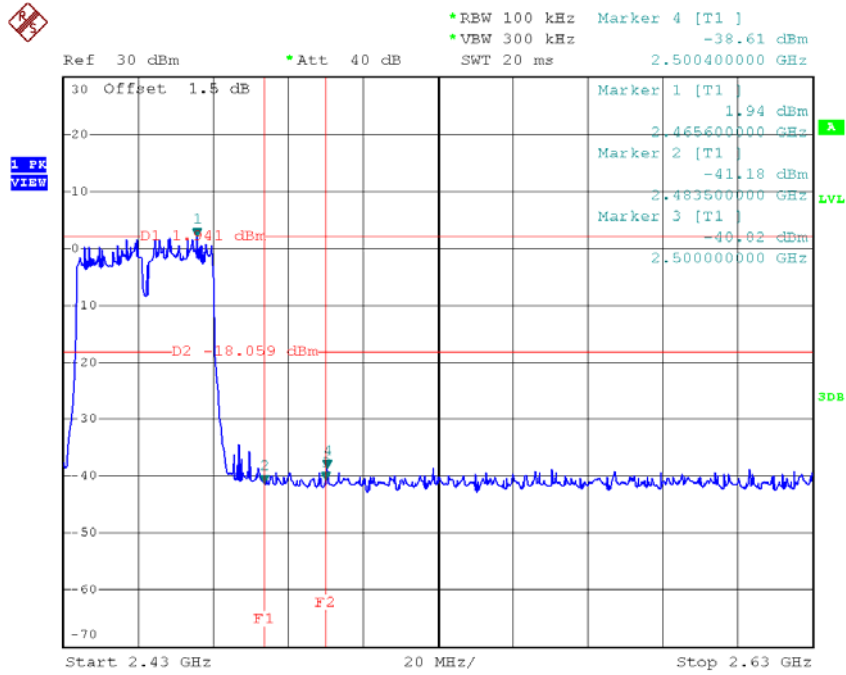

Date: 16.AUG.2016 16:57:18

TX HT40 mode CH03 (10 Harmonic of the frequency)

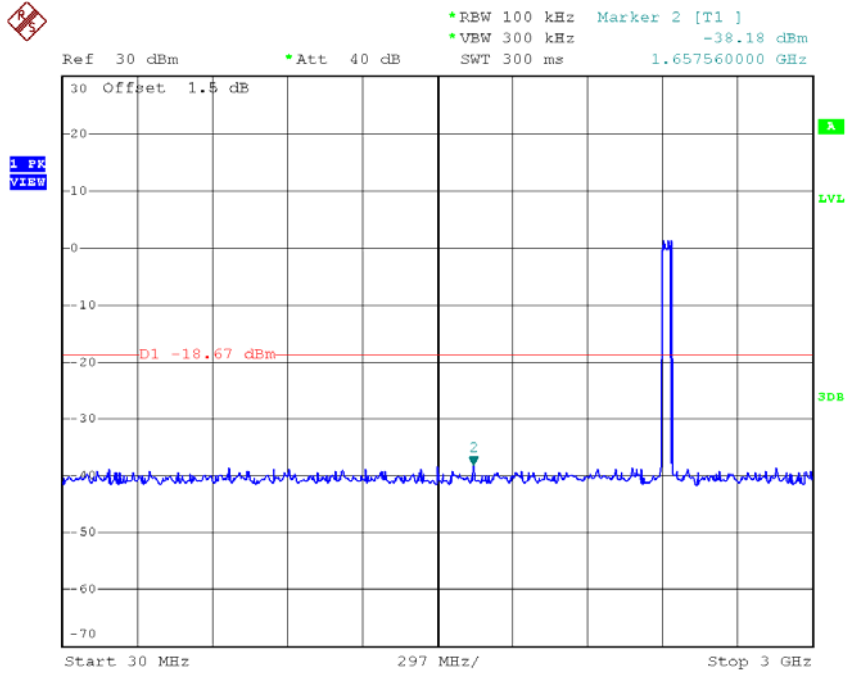

Date: 16.AUG.2016 16:54:25

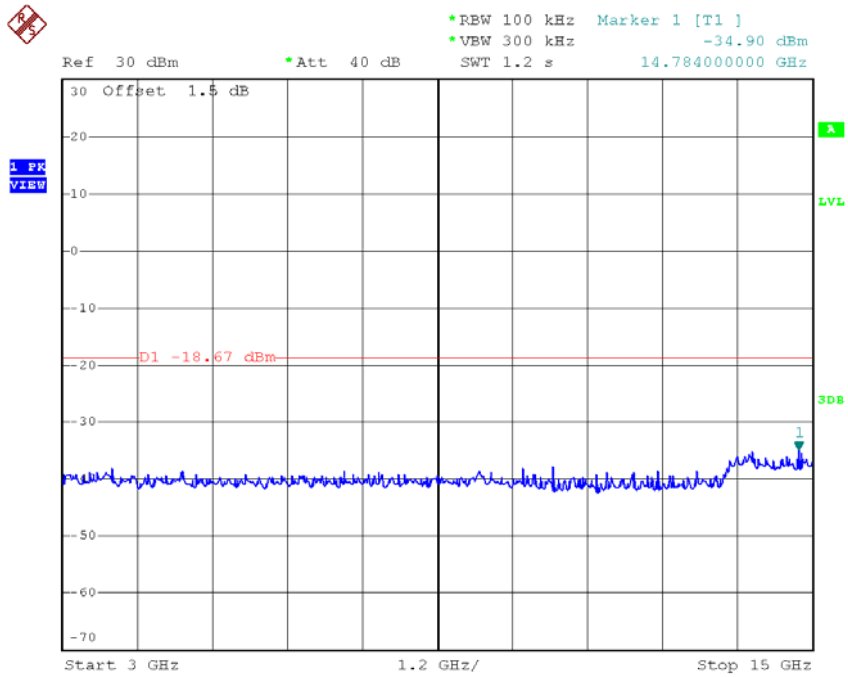

Date: 16.AUG.2016 16:54:33

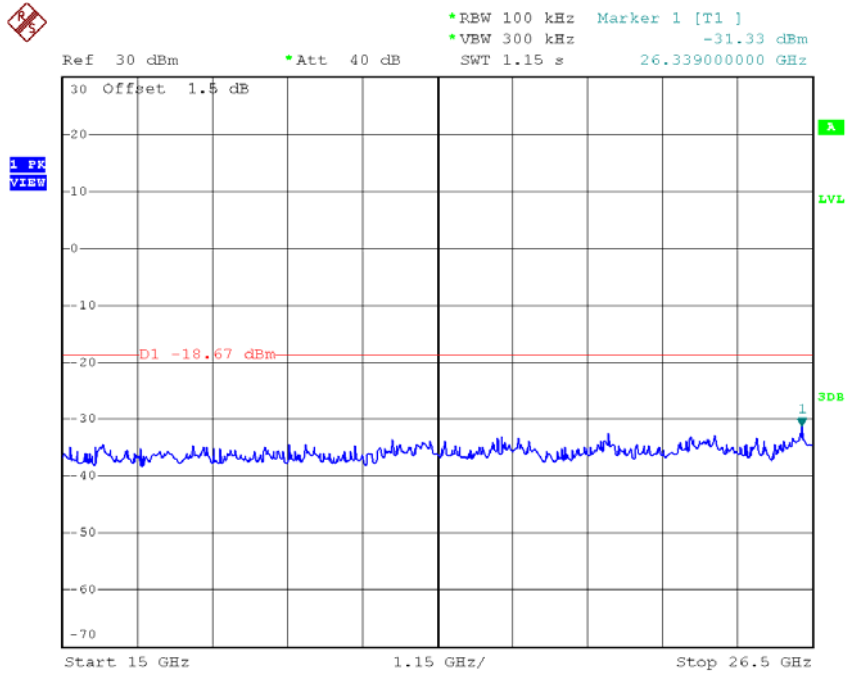

Date: 16.AUG.2016 16:54:42

TX HT40 mode CH06 (10 Harmonic of the frequency)

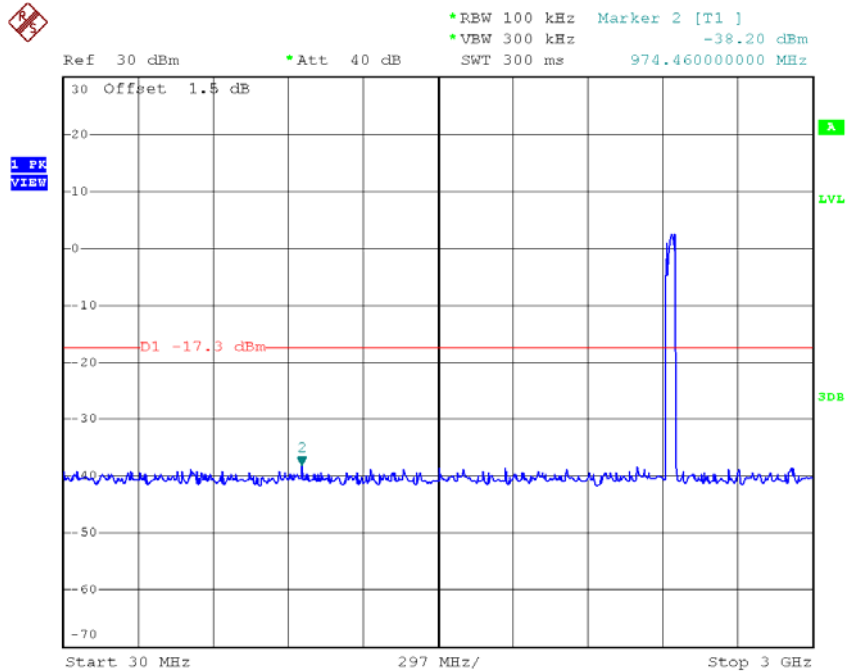

Date: 16.AUG.2016 16:55:44



Ref 30 dBm *Att 40 dB *REW 100 kHz Marker 1 [T1]
 *VBW 300 kHz -34.85 dBm
 SWT 1.2 s 14.256000000 GHz

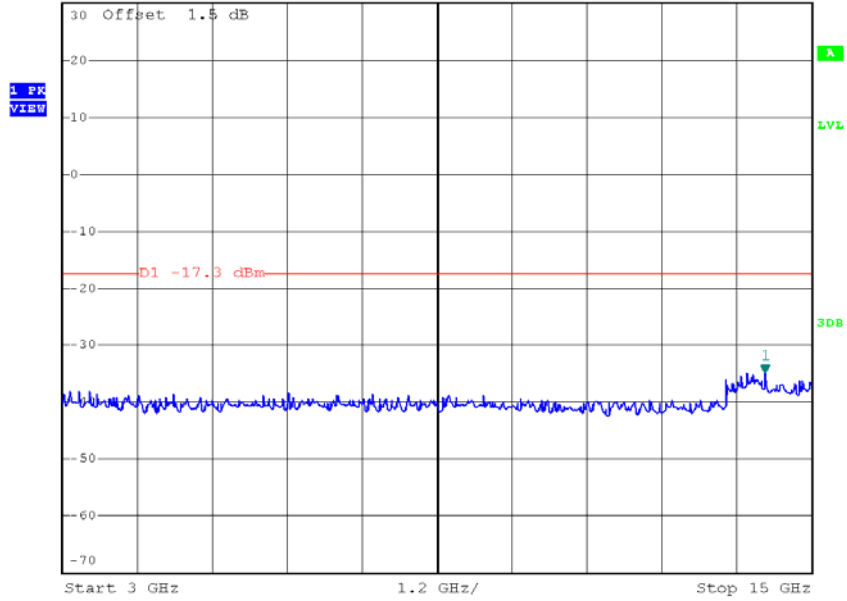

Date: 16.AUG.2016 16:55:53



Ref 30 dBm *Att 40 dB *REW 100 kHz Marker 1 [T1]
 *VBW 300 kHz -31.88 dBm
 SWT 1.15 s 24.752000000 GHz

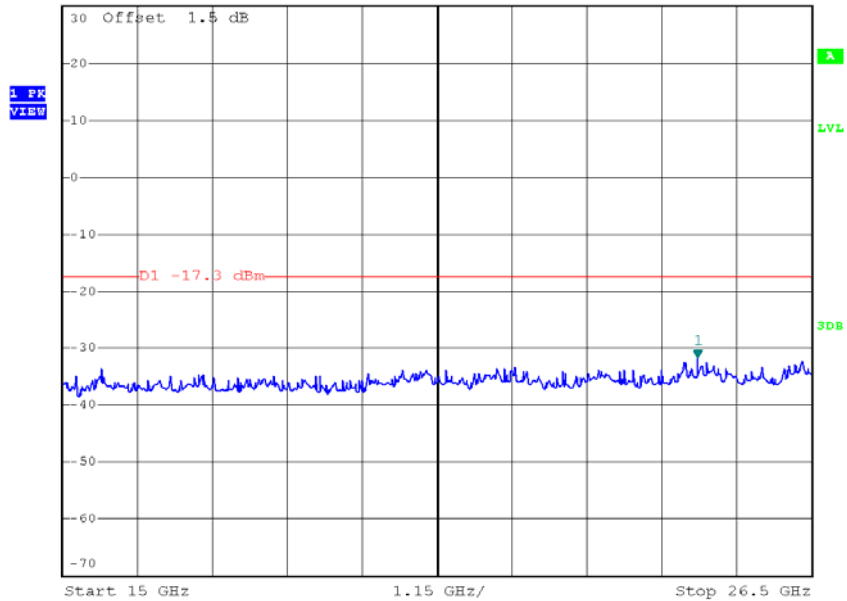

Date: 16.AUG.2016 16:56:01

TX HT40 mode CH09 (10 Harmonic of the frequency)

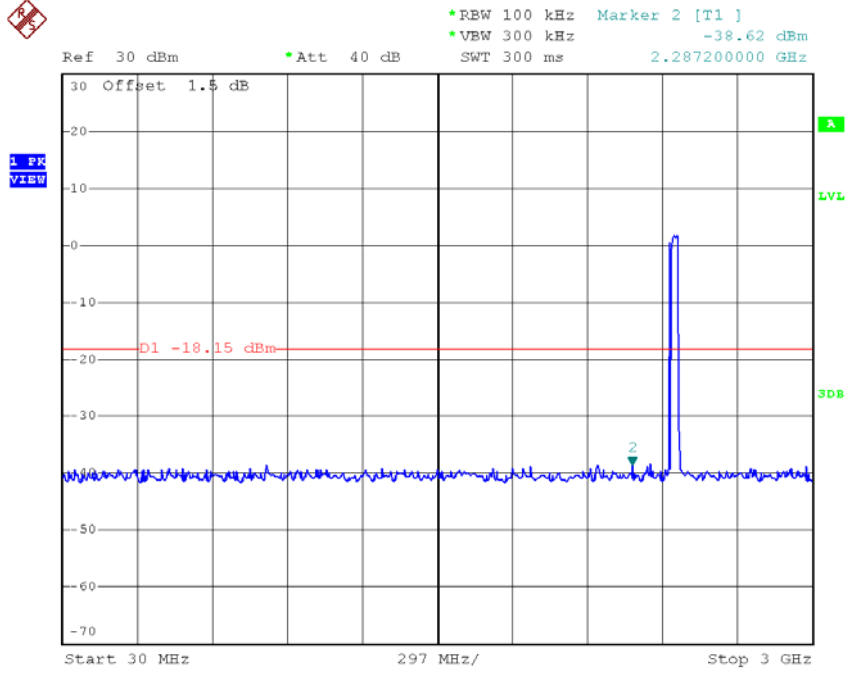

Date: 16.AUG.2016 16:56:53

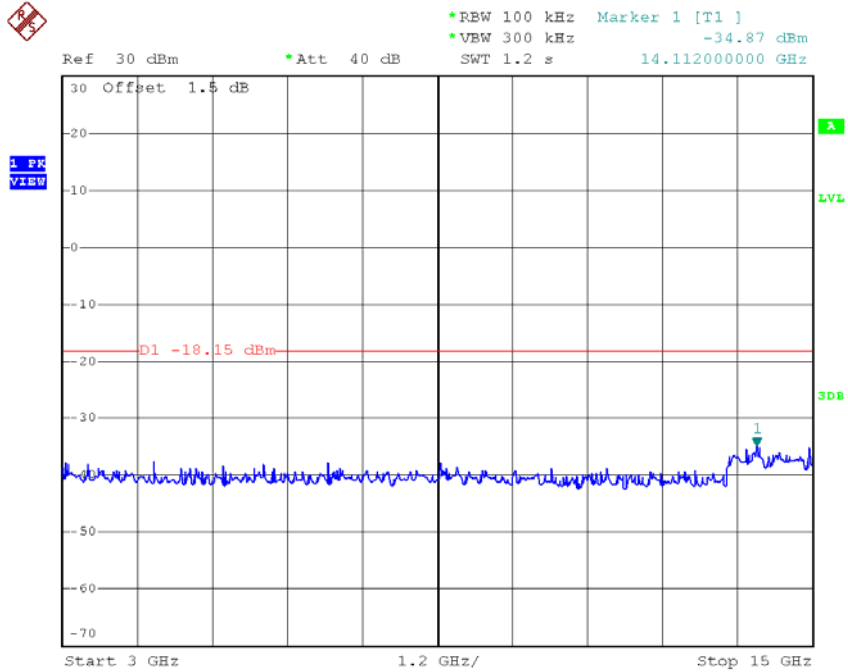

Date: 16.AUG.2016 16:57:01

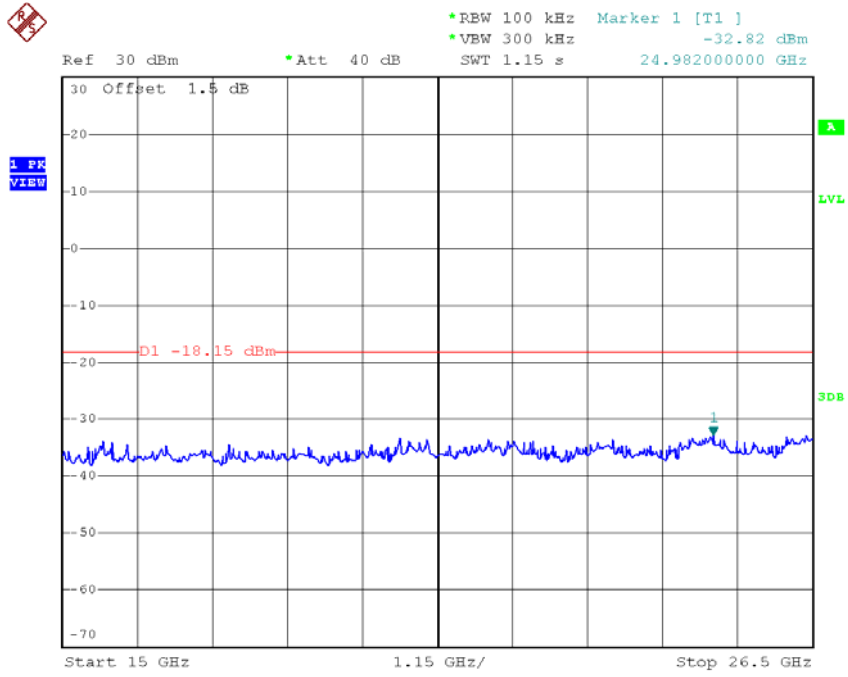

Date: 16.AUG.2016 16:57:10

Test Mode : TX N-40M Mode_ANT 3

TX HT40 mode CH03

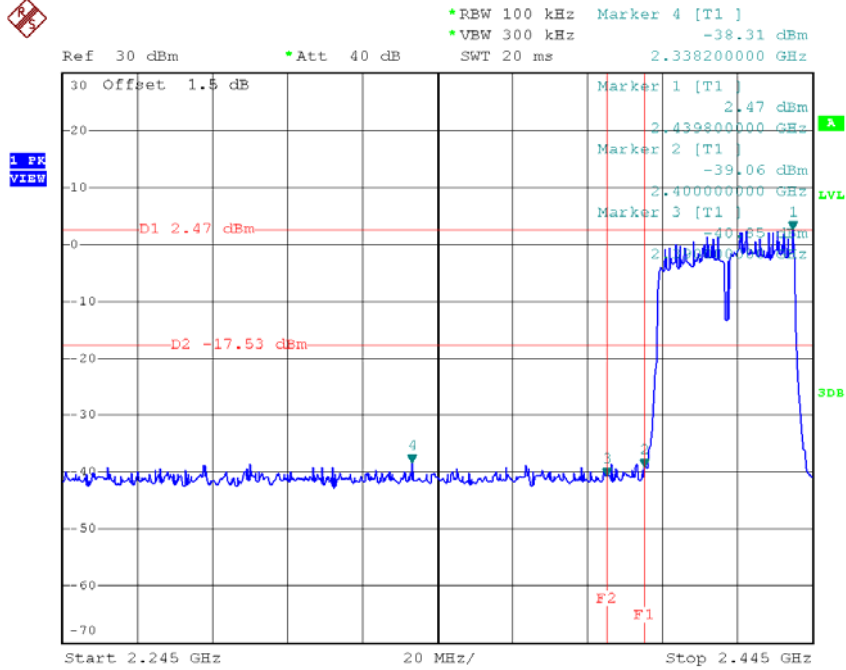

Date: 16.AUG.2016 17:02:58

TX HT40 mode CH09

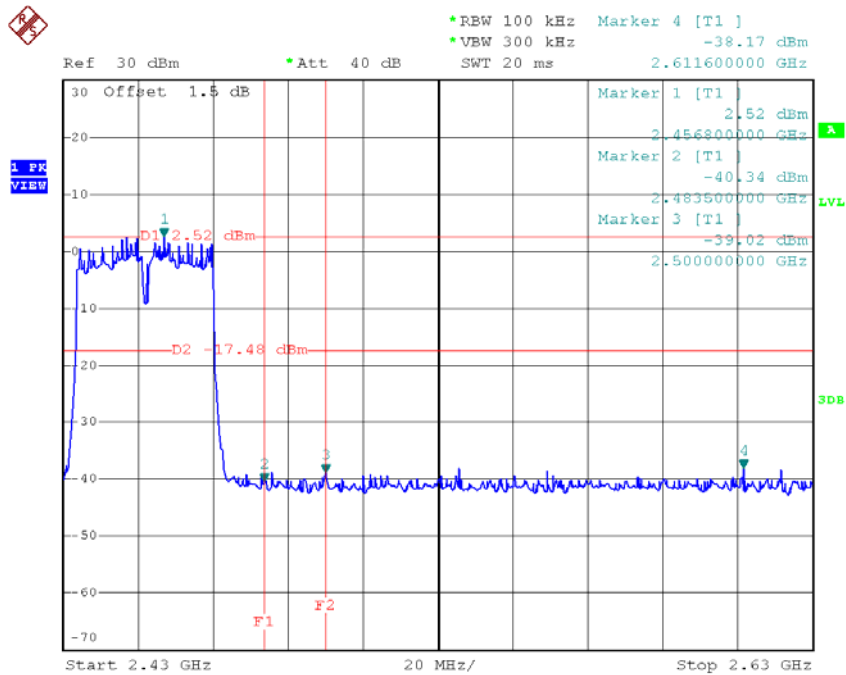

Date: 16.AUG.2016 17:05:38

TX HT40 mode CH03 (10 Harmonic of the frequency)

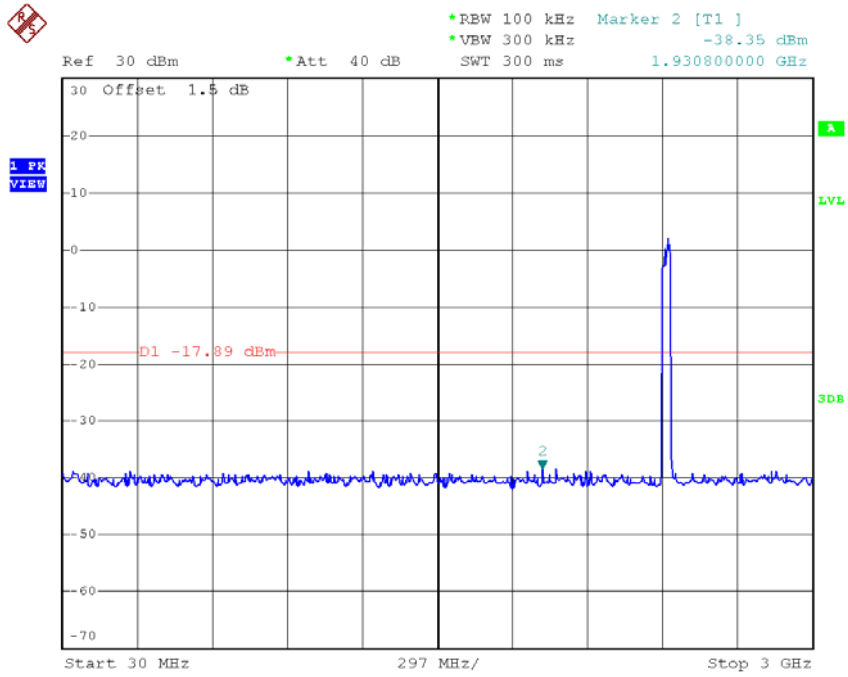

Date: 16.AUG.2016 17:02:33

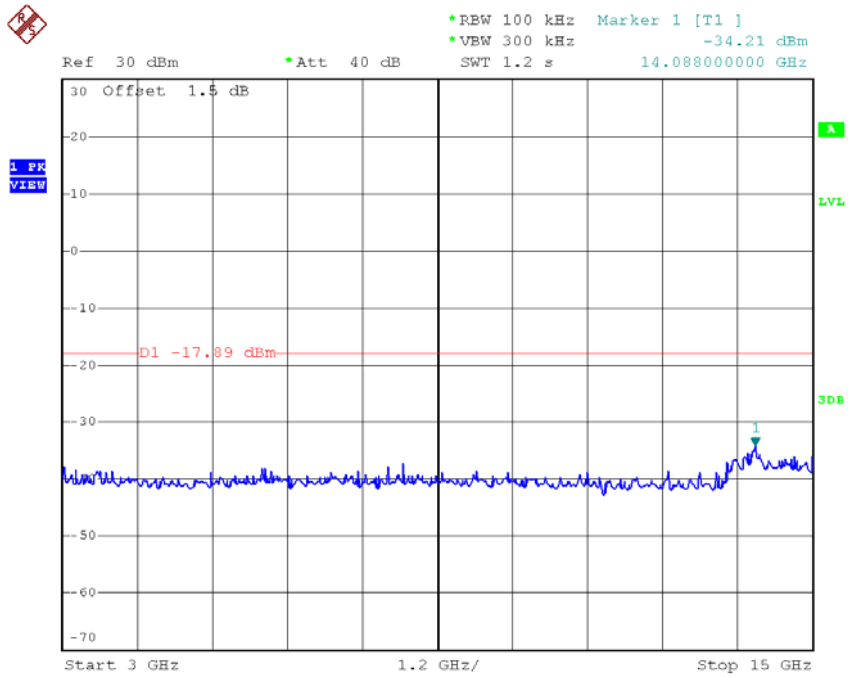

Date: 16.AUG.2016 17:02:42

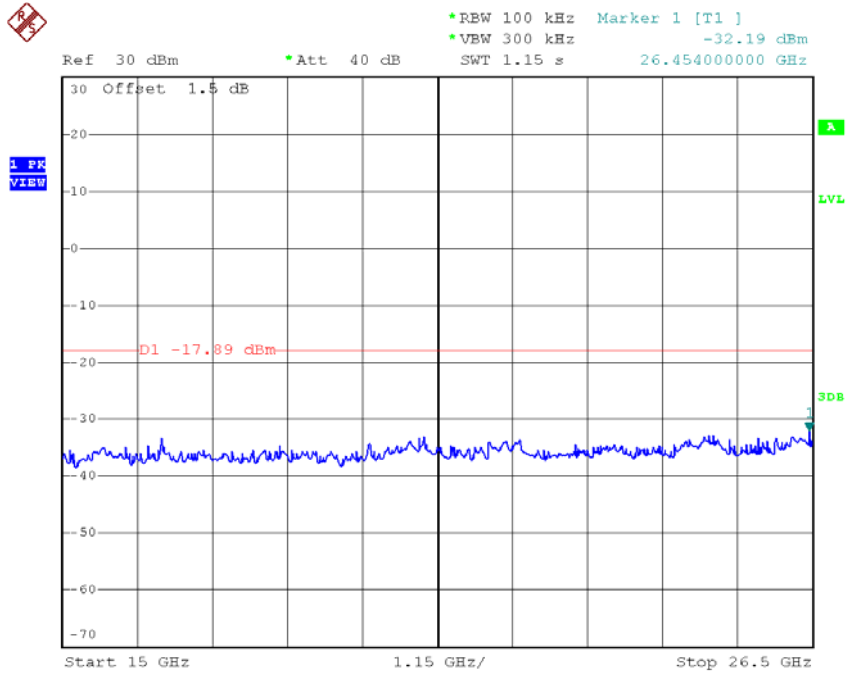

Date: 16.AUG.2016 17:02:50

TX HT40 mode CH06 (10 Harmonic of the frequency)

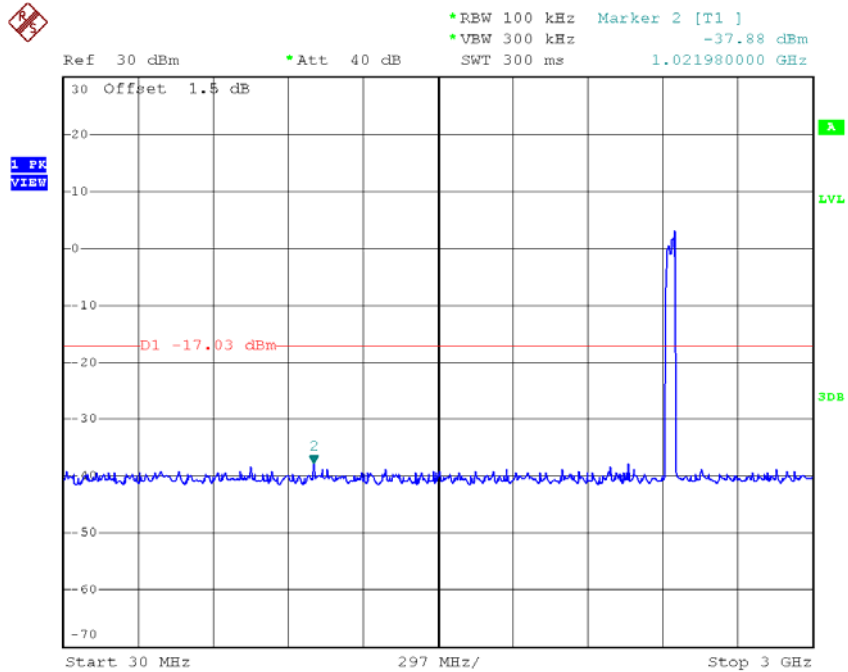

Date: 16.AUG.2016 17:03:59

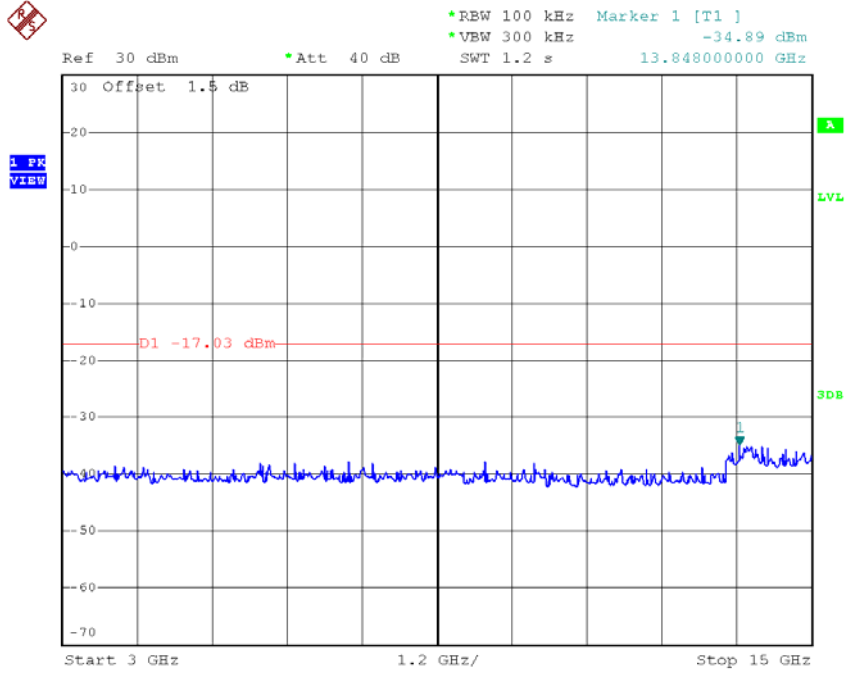

Date: 16.AUG.2016 17:04:07

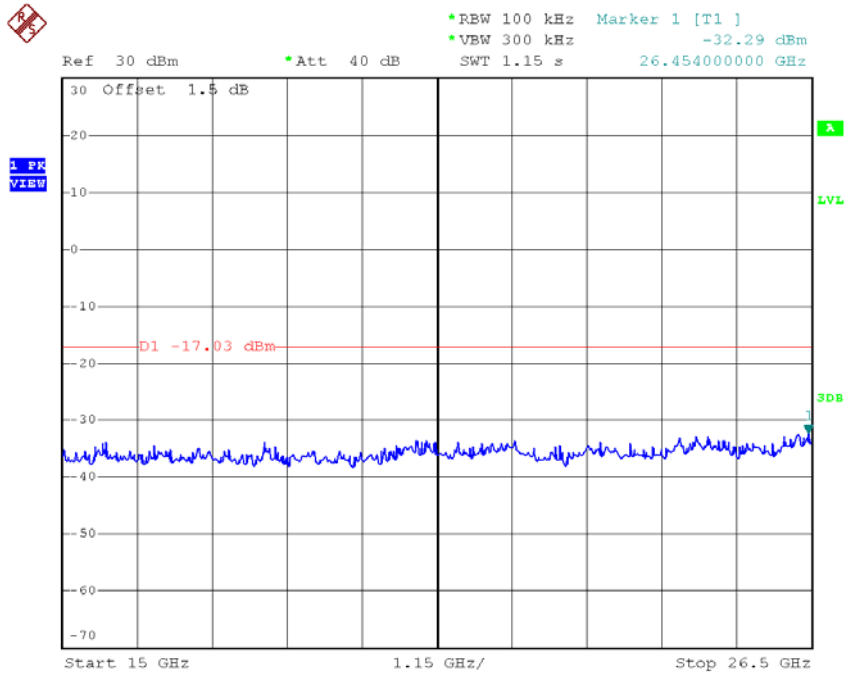

Date: 16.AUG.2016 17:04:16

TX HT40 mode CH09 (10 Harmonic of the frequency)

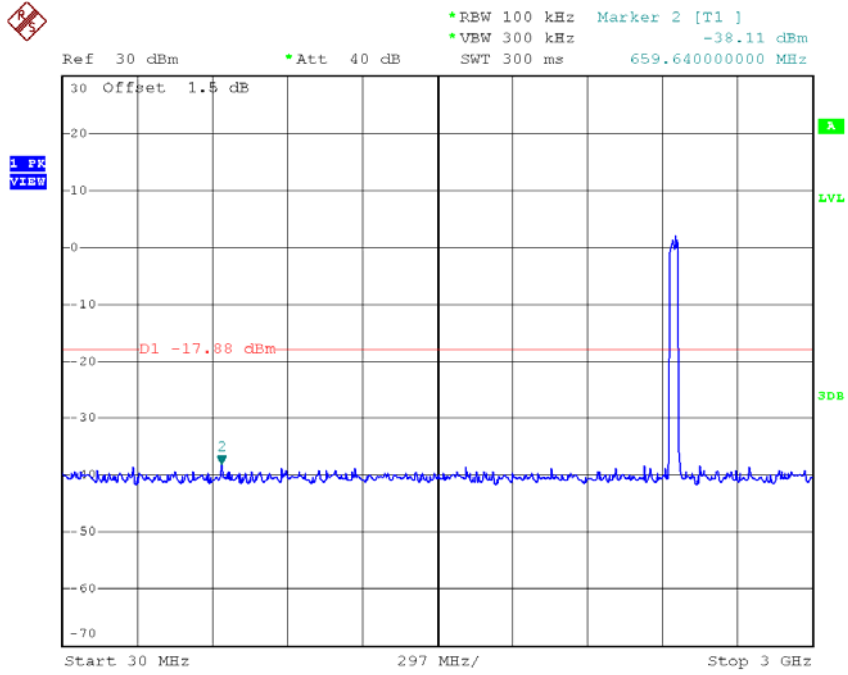

Date: 16.AUG.2016 17:05:14

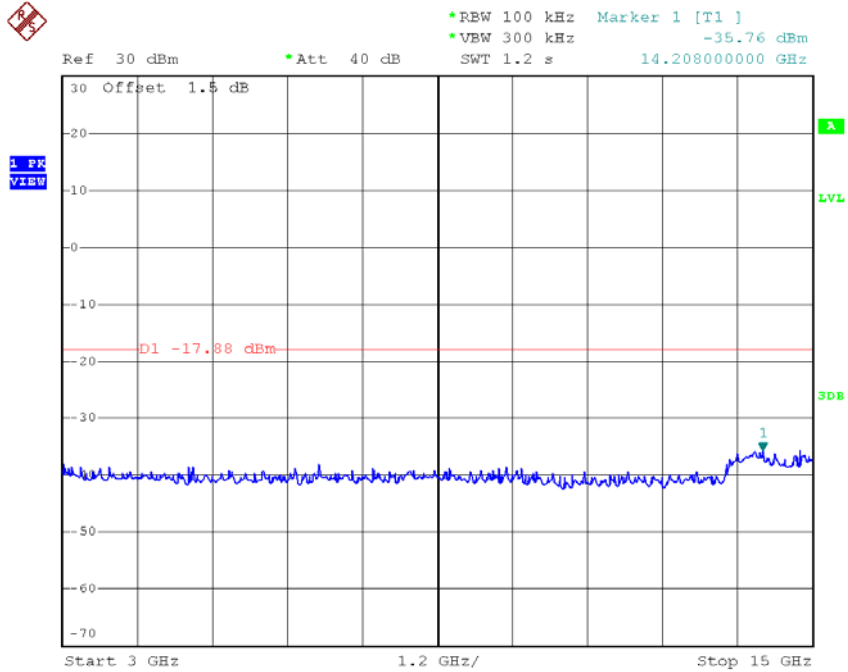

Date: 16.AUG.2016 17:05:22



*REW 100 kHz Marker 1 [T1]
*VBW 300 kHz -32.96 dBm
Ref 30 dBm *Att 40 dB SWT 1.15 s 26.408000000 GHz

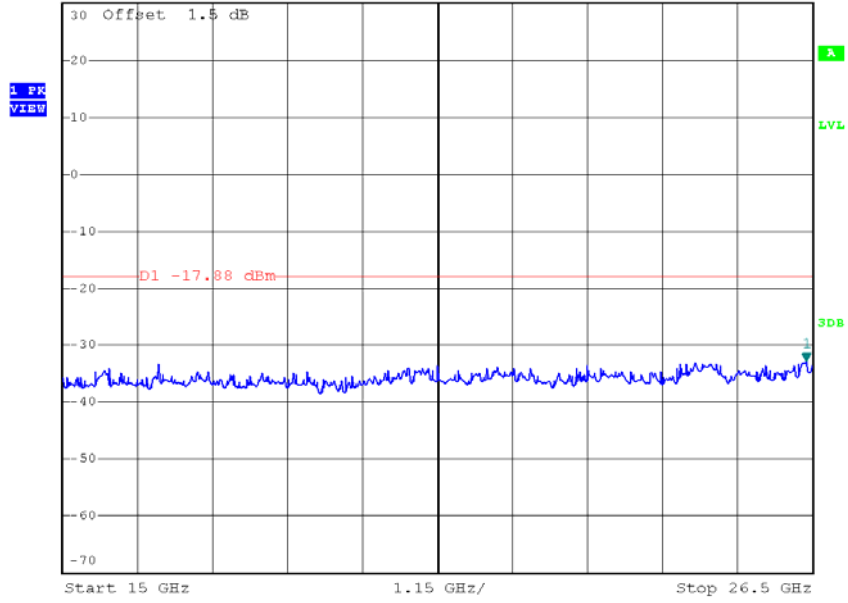

Date: 16.AUG.2016 17:05:30

2.4GHz+5GHz

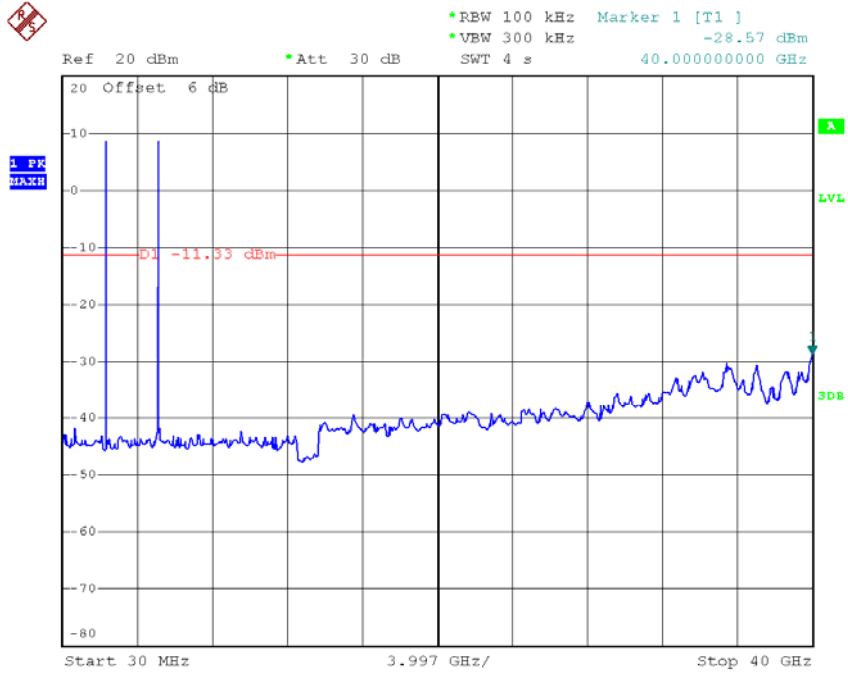

Date: 9.SEP.2016 16:35:44

ATTACHMENT H - POWER SPECTRAL DENSITY

Test Mode :TX B Mode_CH01/06/11

Frequency (MHz)	Power Density (dBm/3kHz)	Power Density (mW/3kHz)	Max. Limit (dBm/3kHz)	Result
2412	2.55	1.7989	8	Complies
2437	6.26	4.2267	8	Complies
2462	3.01	1.9999	8	Complies

TX CH01

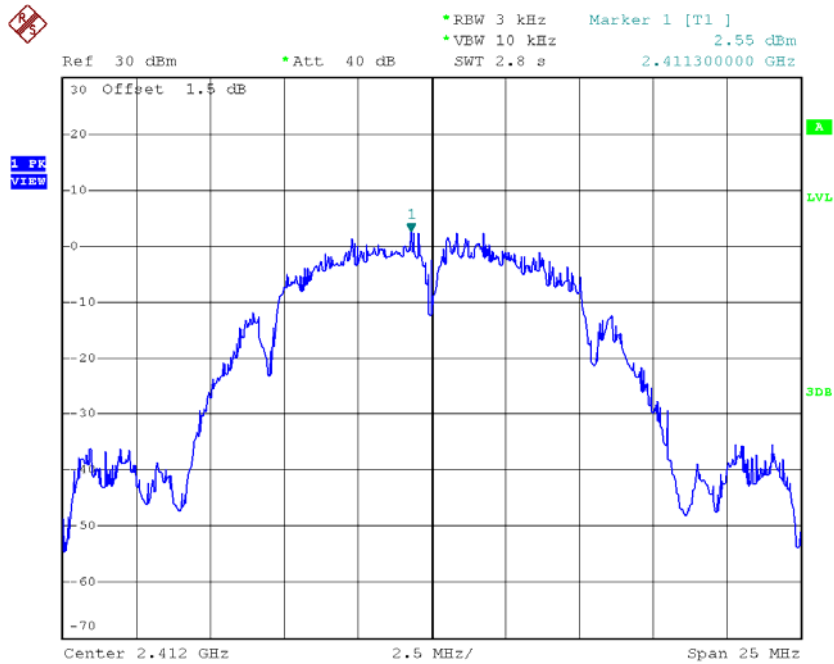

Date: 26.AUG.2016 20:02:07

TX CH06

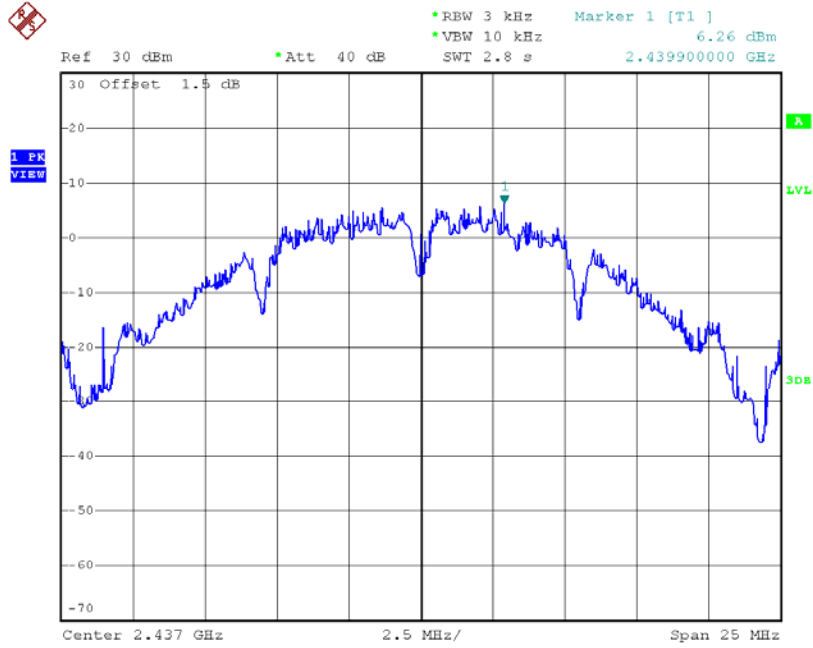

Date: 26.AUG.2016 20:03:51

TX CH11

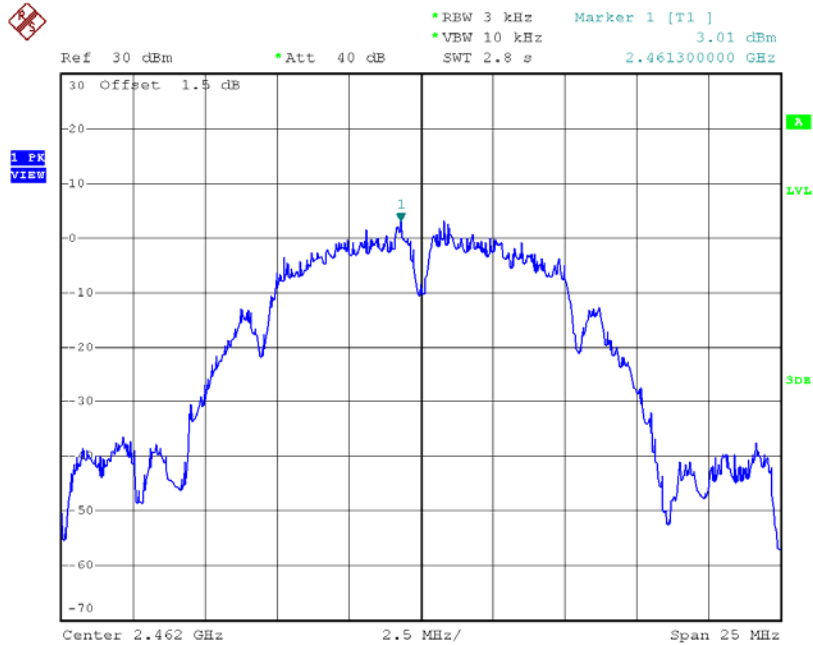

Date: 26.AUG.2016 20:06:06

Test Mode :TX G Mode_CH01/06/11

Frequency (MHz)	Power Density (dBm/3kHz)	Power Density (mW/3kHz)	Max. Limit (dBm/3kHz)	Result
2412	1.61	1.4488	8	Complies
2437	3.41	2.1928	8	Complies
2462	4.63	2.9040	8	Complies

TX CH01

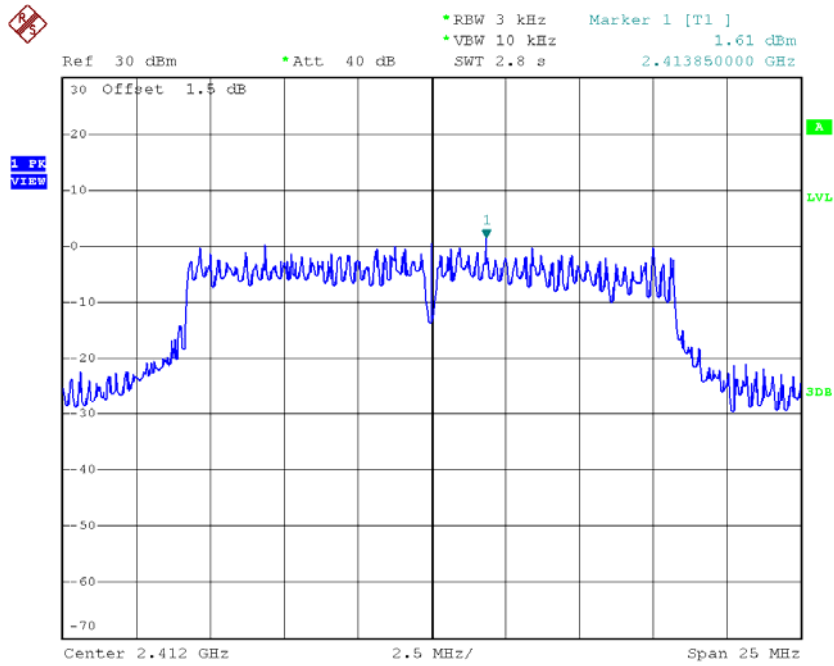

Date: 16.AUG.2016 16:21:49

TX CH06

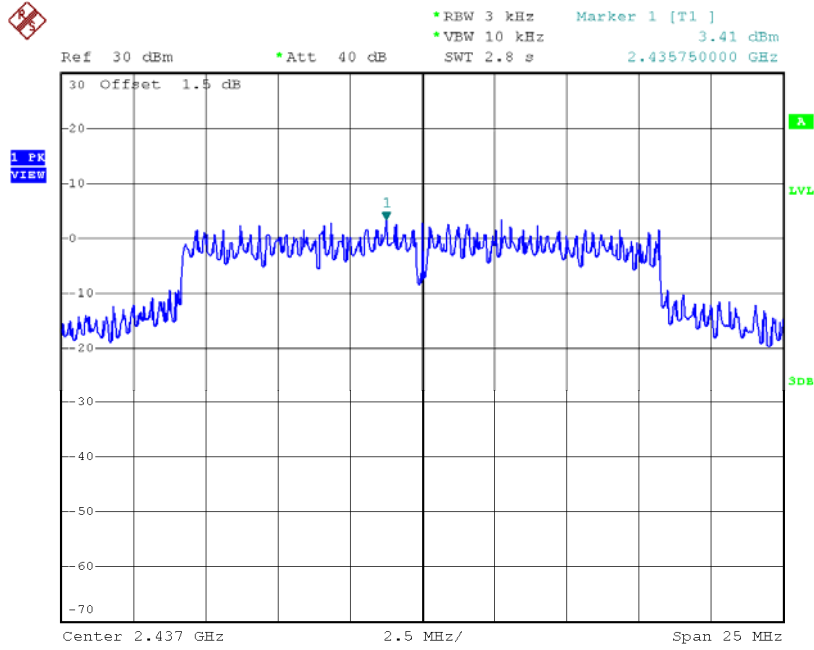

Date: 16.AUG.2016 16:25:03

TX CH11

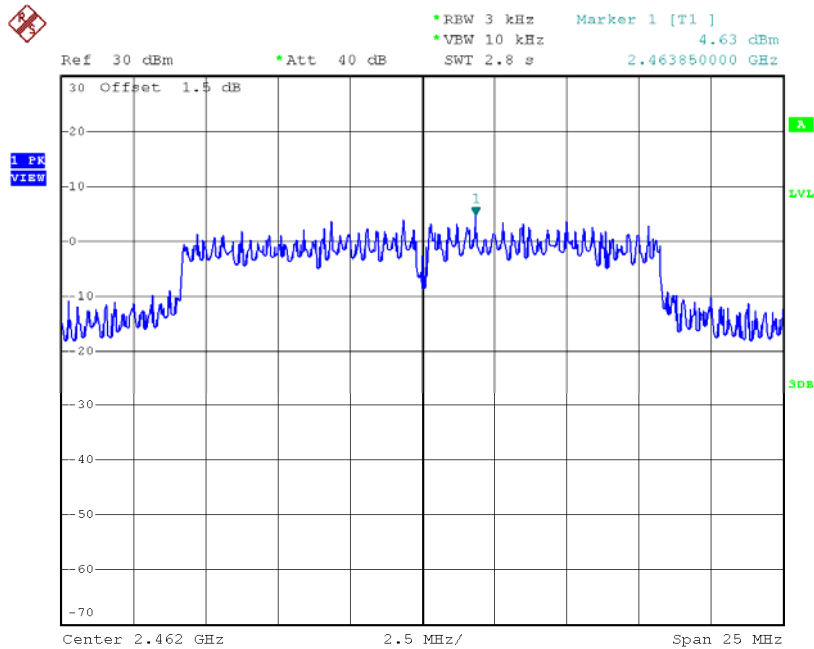

Date: 16.AUG.2016 16:27:41

Test Mode : TX N-20M Mode_CH01/06/11_ANT 1

Frequency (MHz)	Power Density (dBm/3kHz)	Power Density (mW/3kHz)	Max. Limit (dBm/3kHz)	Result
2412	-7.89	0.1626	8	Complies
2437	-9.27	0.1183	8	Complies
2462	-9.56	0.1107	8	Complies

TX CH01

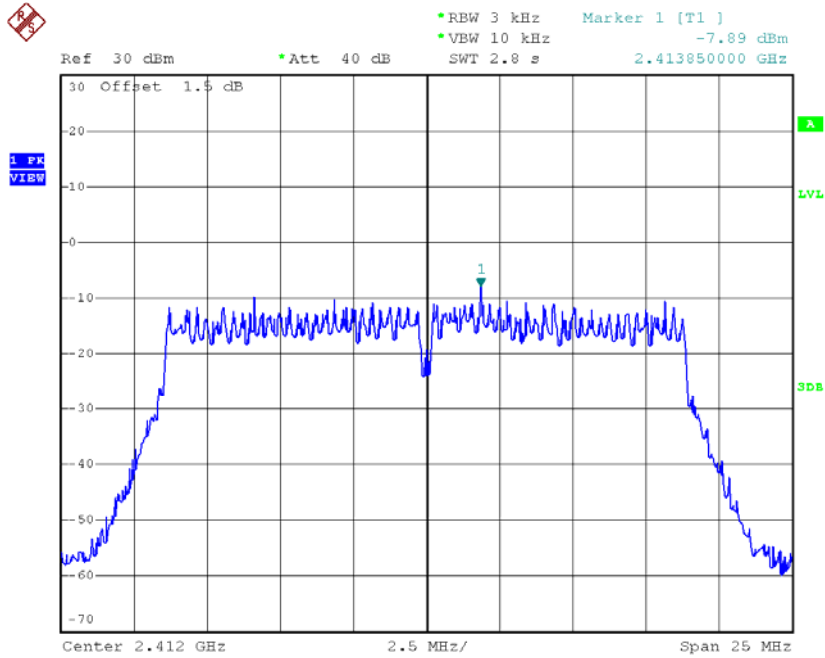

Date: 16.AUG.2016 16:33:47

TX CH06

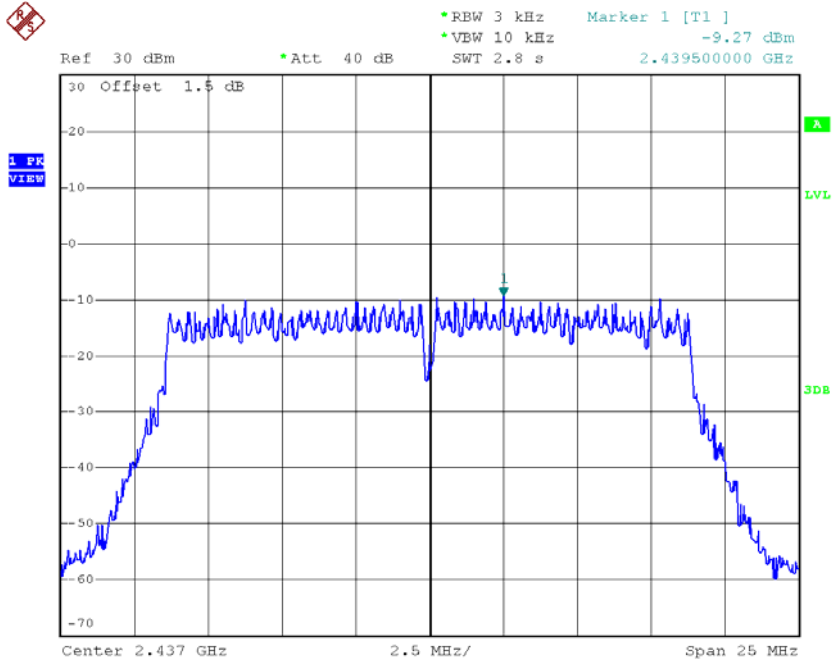

Date: 16.AUG.2016 16:35:01

TX CH11

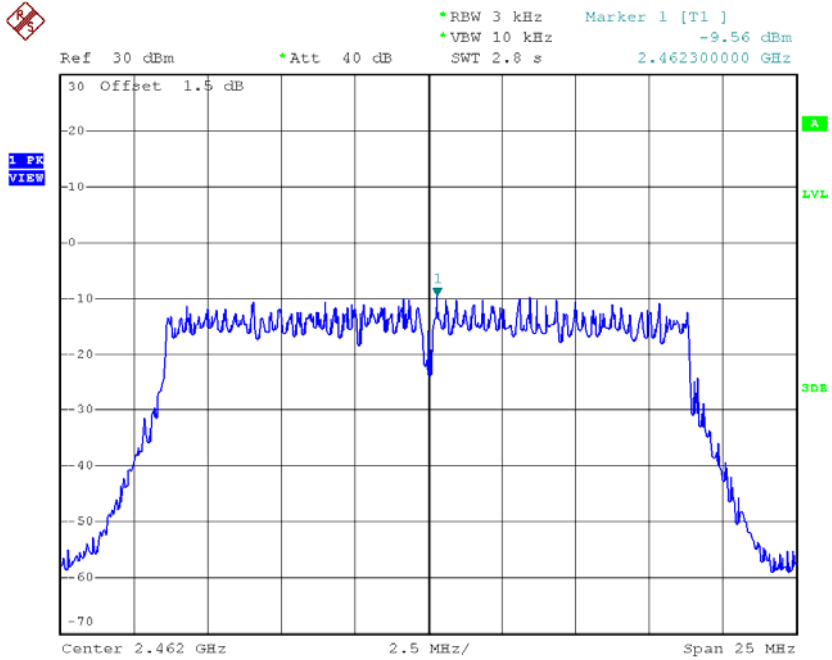

Date: 16.AUG.2016 16:43:16

Test Mode : TX N-20M Mode_CH01/06/11_ANT 2

Frequency (MHz)	Power Density (dBm/3kHz)	Power Density (mW/3kHz)	Max. Limit (dBm/3kHz)	Result
2412	-9.41	0.1146	8	Complies
2437	-10.03	0.0993	8	Complies
2462	-9.17	0.1211	8	Complies

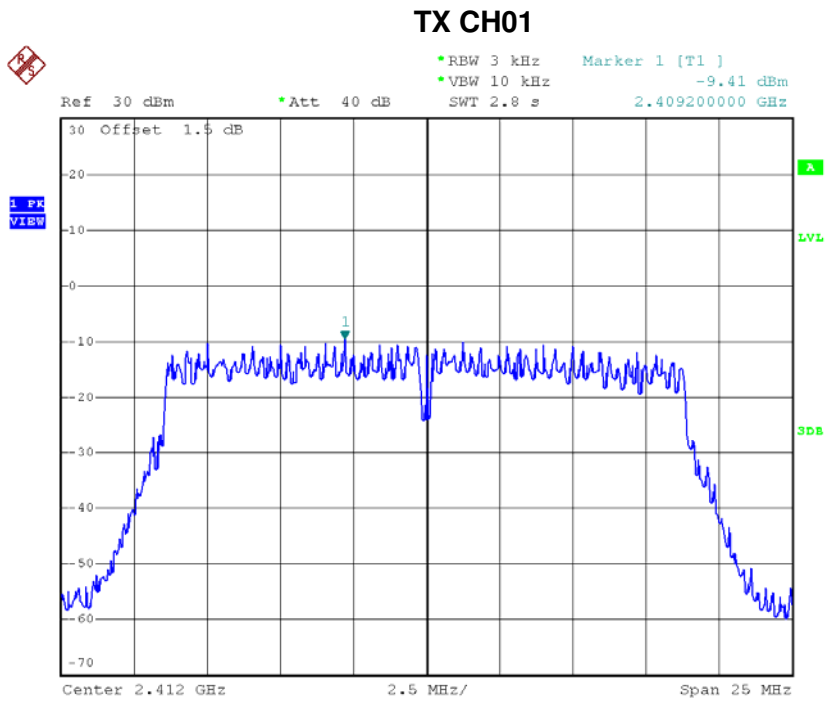

Date: 16.AUG.2016 16:51:15

TX CH06

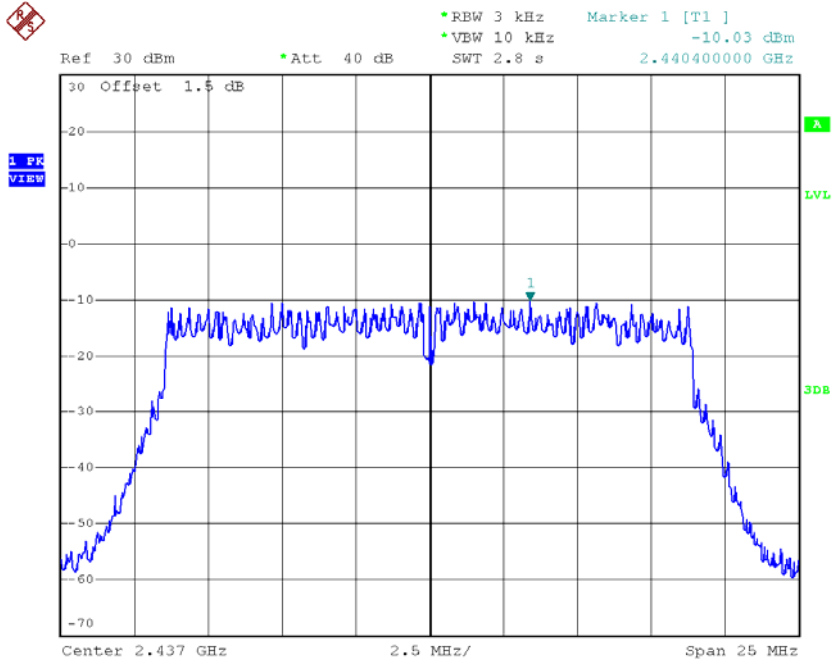

Date: 16.AUG.2016 16:52:23

TX CH11

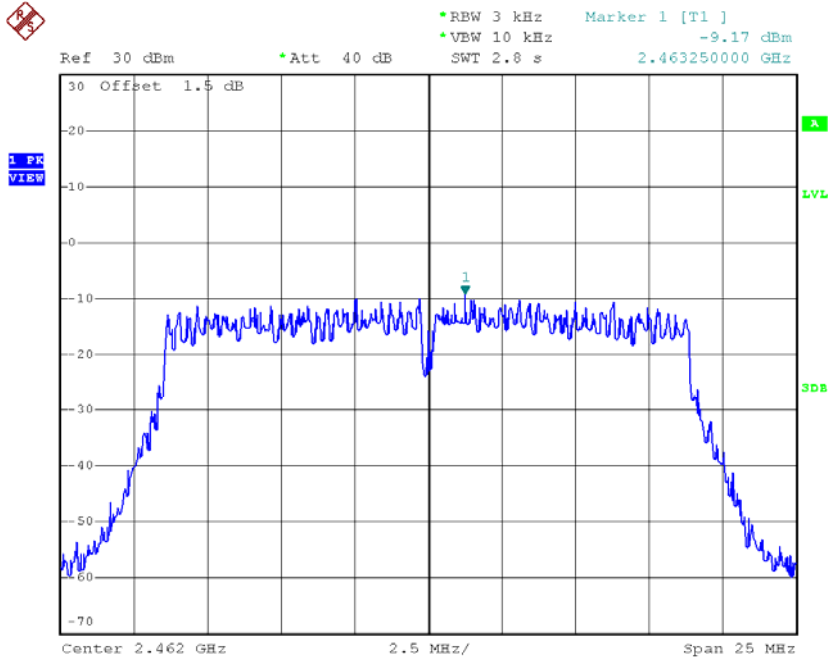

Date: 16.AUG.2016 16:53:38

Test Mode : TX N-20M Mode_CH01/06/11_ANT 3

Frequency (MHz)	Power Density (dBm/3kHz)	Power Density (mW/3kHz)	Max. Limit (dBm/3kHz)	Result
2412	-9.31	0.1172	8	Complies
2437	-8.00	0.1585	8	Complies
2462	-8.72	0.1343	8	Complies

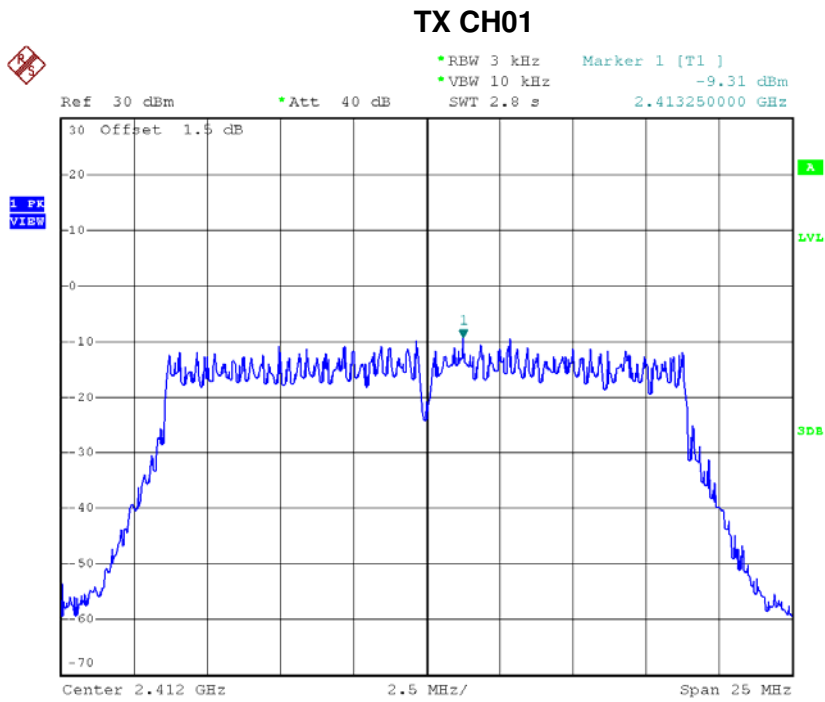

Date: 16.AUG.2016 16:58:57

TX CH06

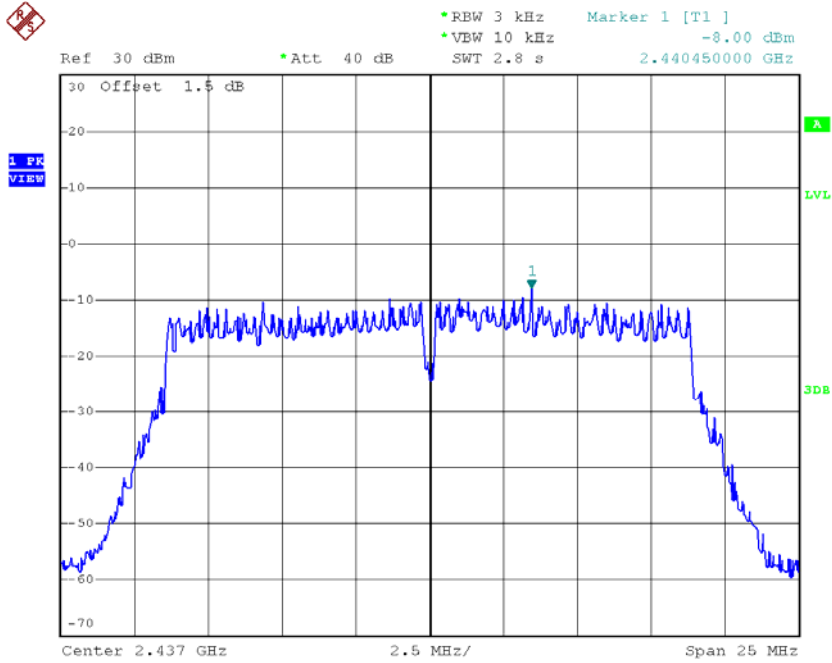

Date: 16.AUG.2016 17:00:36

TX CH11

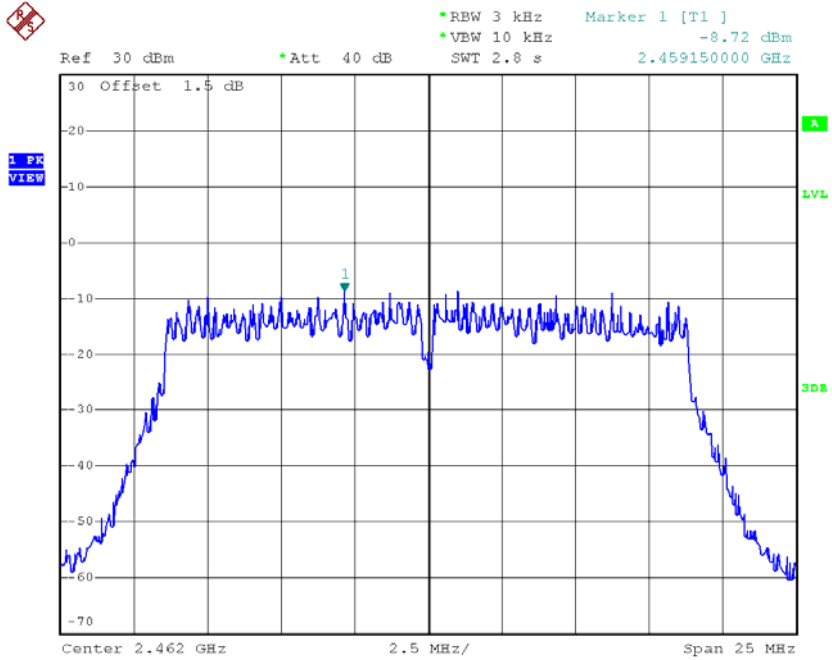

Date: 16.AUG.2016 17:01:50

Test Mode : TX N-20M Mode_CH01/06/11_Total

Frequency (MHz)	Power Density (dBm/3kHz)	Power Density (mW/3kHz)	Max. Limit (dBm/3kHz)	Result
2412	-4.04	0.39	6.30	Complies
2437	-4.25	0.38	6.30	Complies
2462	-4.36	0.37	6.30	Complies

Test Mode : TX N-40M Mode_CH03/06/09_ANT 1

Frequency (MHz)	Power Density (dBm/3kHz)	Power Density (mW/3kHz)	Max. Limit (dBm/3kHz)	Result
2422	-13.10	0.0490	8	Complies
2437	-13.09	0.0491	8	Complies
2452	-13.19	0.0480	8	Complies

TX CH03

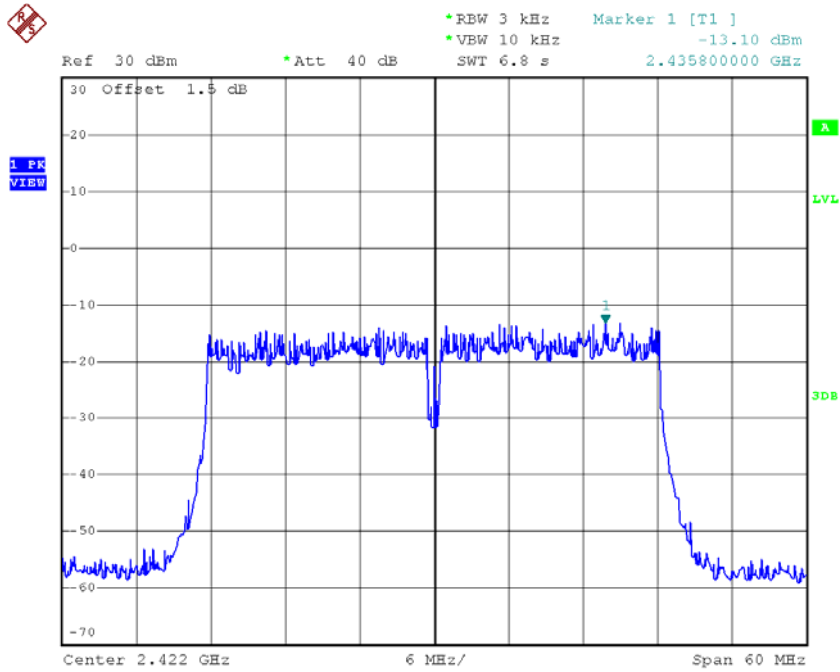

Date: 16.AUG.2016 16:46:37

TX CH06

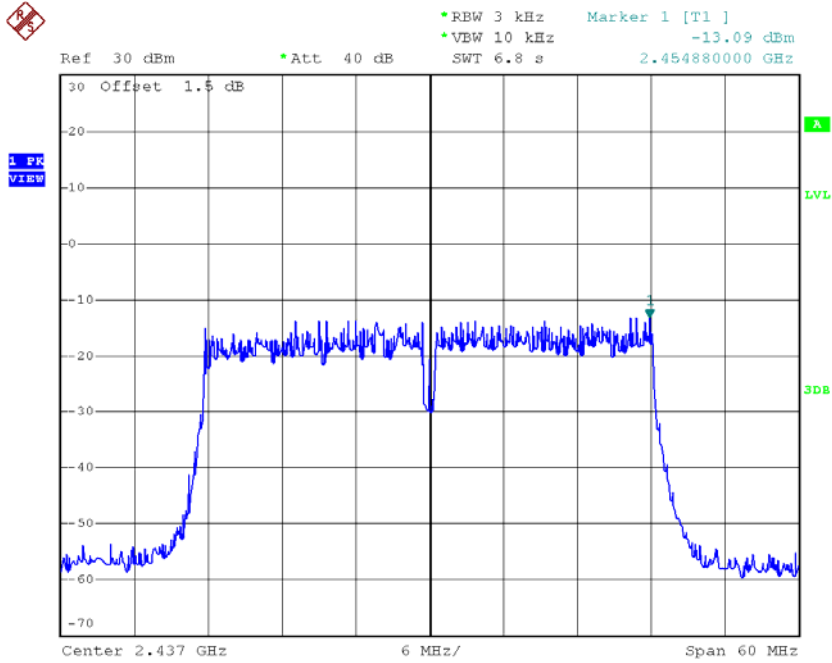

Date: 16.AUG.2016 16:48:02

TX CH09

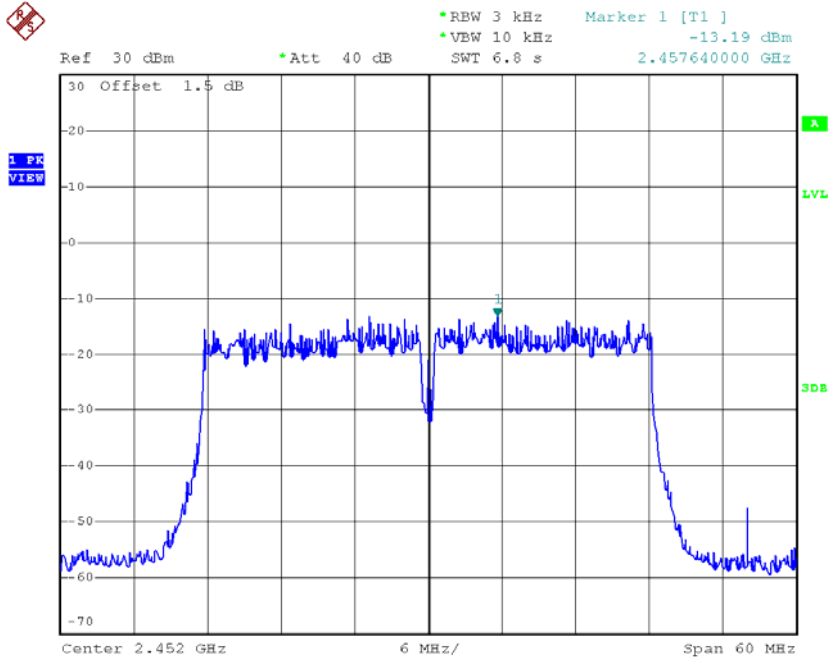

Date: 16.AUG.2016 16:49:22

Test Mode : TX N-40M Mode_CH03/06/09_ANT 2

Frequency (MHz)	Power Density (dBm/3kHz)	Power Density (mW/3kHz)	Max. Limit (dBm/3kHz)	Result
2422	-11.84	0.0655	8	Complies
2437	-12.78	0.0527	8	Complies
2452	-11.39	0.0726	8	Complies

TX CH03

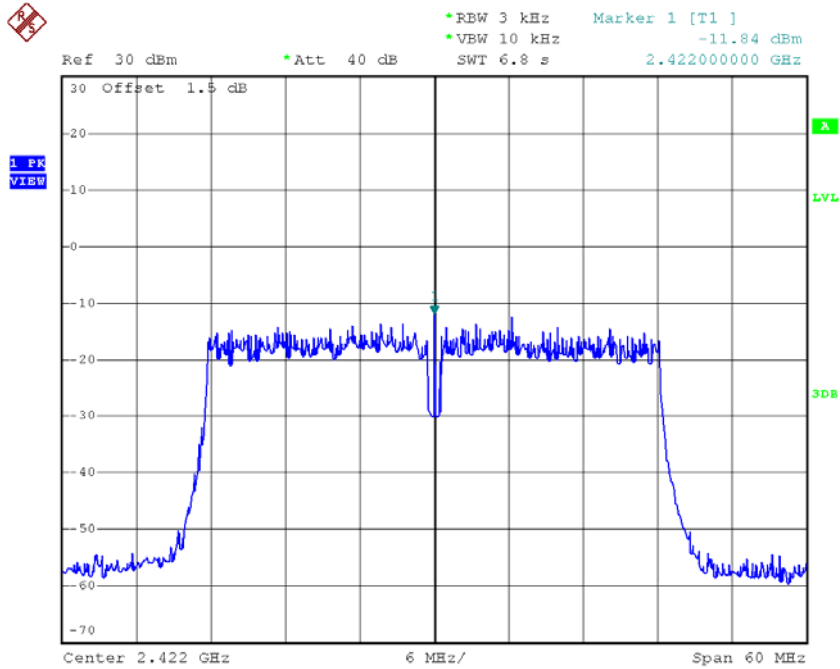

Date: 16.AUG.2016 16:55:01

TX CH06

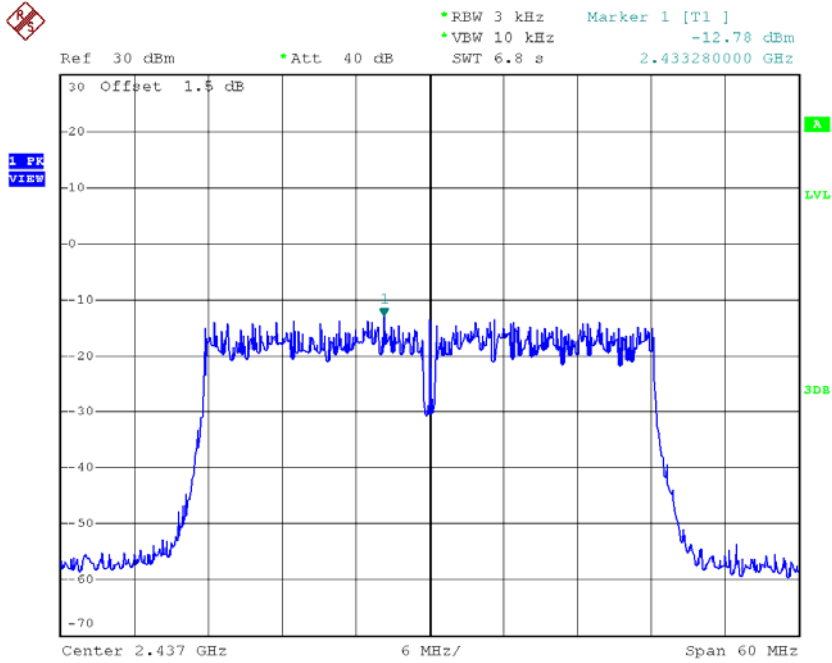

Date: 16.AUG.2016 16:56:13

TX CH09

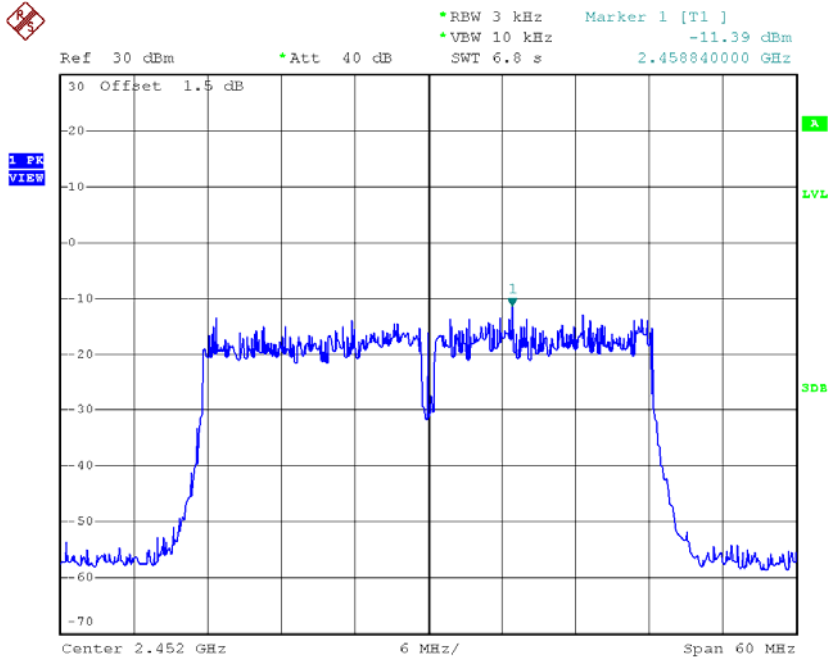

Date: 16.AUG.2016 16:57:30

Test Mode : TX N-40M Mode_CH03/06/09_ANT 3

Frequency (MHz)	Power Density (dBm/3kHz)	Power Density (mW/3kHz)	Max. Limit (dBm/3kHz)	Result
2422	-11.85	0.0653	8	Complies
2437	-12.08	0.0619	8	Complies
2452	-12.52	0.0560	8	Complies

TX CH03

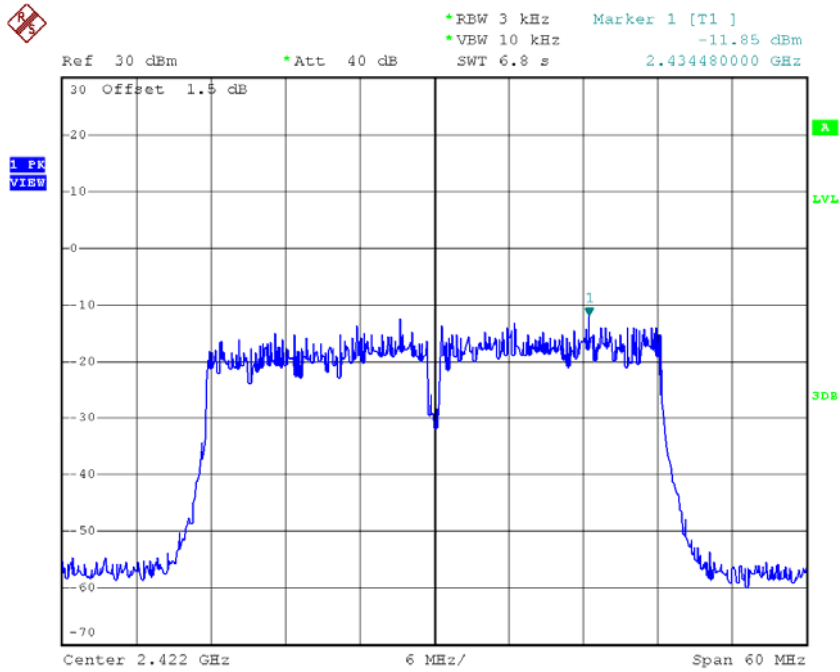

Date: 16.AUG.2016 17:03:10

TX CH06

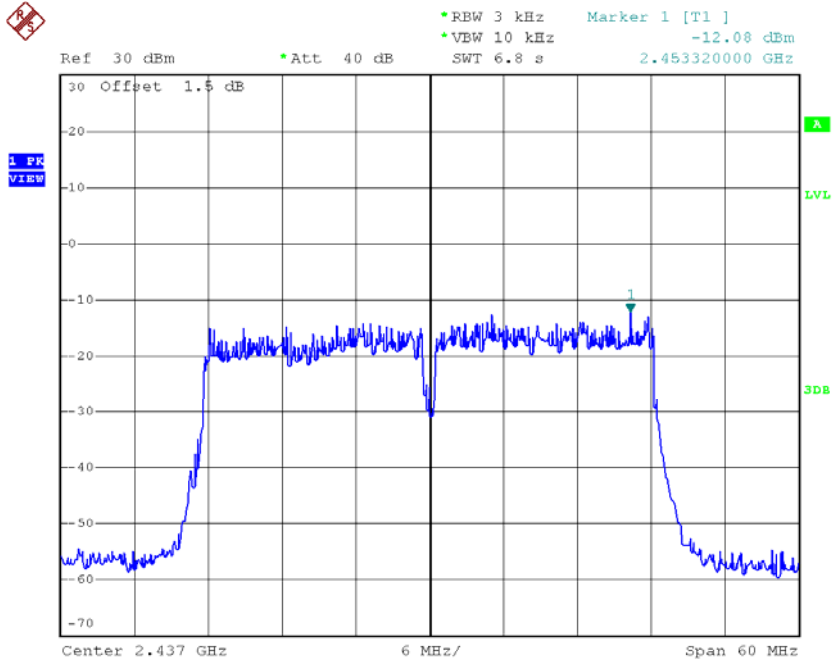

Date: 16.AUG.2016 17:04:28

TX CH09

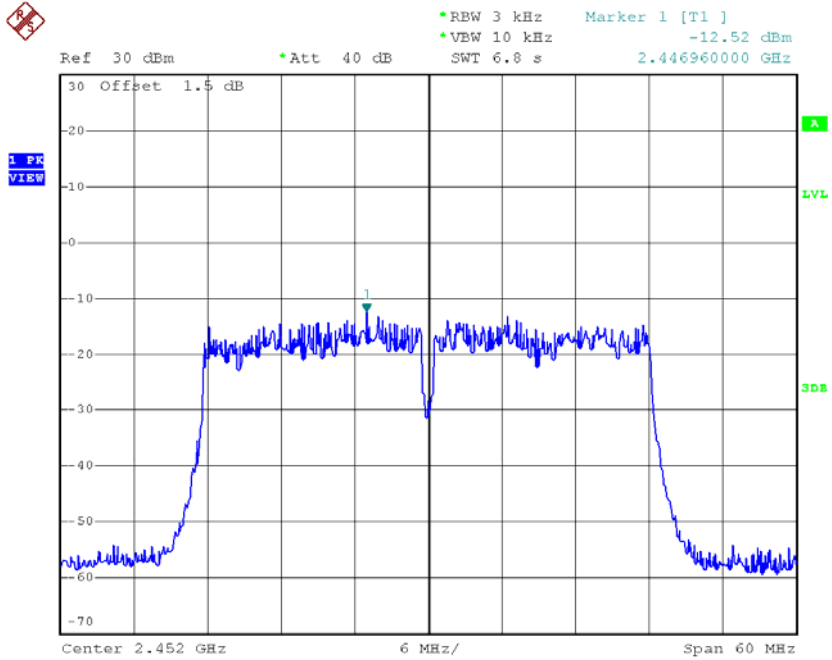

Date: 16.AUG.2016 17:05:50

Test Mode : TX N-40M Mode_CH03/06/09_Total

Frequency (MHz)	Power Density (dBm/3kHz)	Power Density (mW/3kHz)	Max. Limit (dBm/3kHz)	Result
2422	-7.45	0.18	6.30	Complies
2437	-7.86	0.16	6.30	Complies
2452	-7.53	0.18	6.30	Complies