

FCCRadio Test Report

FCC ID: V7TAC18

This report concerns (check one): Original Grant Class I Change Class II Change

Project No. : 1608C055
Equipment : AC1900 Enhanced Smart Dual-band Gigabit WiFi Router
Model Name : AC18
Applicant : SHENZHEN TENDA TECHNOLOGY CO.,LTD
Address : 6-8 Floor, Tower E3, No. 1001, Zhongshanyuan Road, Nanshan District, Shenzhen, China. 518052

Date of Receipt : Aug. 05, 2016
Date of Test : Aug. 05, 2016 ~ Aug. 29, 2016
Issued Date : Aug. 30, 2016
Tested by : BTL Inc.

Testing Engineer : Shawn Xiao
(Shawn Xiao)

Technical Manager : David Mao
(David Mao)

Authorized Signatory : Steven Lu
(Steven Lu)

B T L I N C .

No.3,Jinshagang 1st Road, Shixia,Dalang Town, Dongguan,
Guangdong, China.

TEL: +86-769-8318-3000FAX: +86-769-8319-6000

Declaration

BTL represents to the client that testing is done in accordance with standard procedures as applicable and that test instruments used has been calibrated with standards traceable to international standard(s) and/or national standard(s).

BTL's reports apply only to the specific samples tested under conditions. It is manufacture's responsibility to ensure that additional production units of this model are manufactured with the identical electrical and mechanical components. **BTL** shall have no liability for any declarations, inferences or generalizations drawn by the client or others from **BTL** issued reports.

BTL's report must not be used by the client to claim product certification, approval, or endorsement by NVLAP, NIST, or any agency of the Federal Government.

This report is the confidential property of the client. As a mutual protection to the clients, the public and **BTL-self**, extracts from the test report shall not be reproduced except in full with **BTL's** authorized written approval.

BTL's laboratory quality assurance procedures are in compliance with the **ISO Guide17025** requirements, and accredited by the conformity assessment authorities listed in this test report.

Limitation

For the use of the authority's logo is limited unless the Test Standard(s)/Scope(s)/Item(s) mentioned in this test report is (are) included in the conformity assessment authorities acceptance respective.

Table of Contents	Page
1 . CERTIFICATION	6
2 . SUMMARY OF TEST RESULTS	7
2.1 TEST FACILITY	8
2.2 MEASUREMENT UNCERTAINTY	8
3 . GENERAL INFORMATION	9
3.1 GENERAL DESCRIPTION OF EUT	9
3.2 DESCRIPTION OF TEST MODES	11
3.3 TABLE OF PARAMETERS OF TEST SOFTWARE SETTING	13
3.4 BLOCK DIAGRAM SHOWING THE CONFIGURATION OF SYSTEM TESTED	14
3.5 DESCRIPTION OF SUPPORT UNITS	14
4 . EMC EMISSION TEST	15
4.1 CONDUCTED EMISSION MEASUREMENT	15
4.1.1 POWER LINE CONDUCTED EMISSION	15
4.1.2 TEST PROCEDURE	15
4.1.3 DEVIATIONFROMTESTSTANDARD	15
4.1.4 TESTSETUP	16
4.1.5 EUT OPERATING CONDITIONS	16
4.1.6 EUT TEST CONDITIONS	16
4.1.7 TEST RESULTS	16
4.2 RADIATED EMISSION MEASUREMENT	17
4.2.1 RADIATED EMISSION LIMITS	17
4.2.2 TEST PROCEDURE	18
4.2.3 DEVIATIONFROMTESTSTANDARD	18
4.2.4 TESTSETUP	18
4.2.5 EUT OPERATING CONDITIONS	19
4.2.6 EUT TEST CONDITIONS	19
4.2.7 TEST RESULTS (9K TO 30MHz)	20
4.2.8 TEST RESULTS(BETWEEN30 TO 1000 MHz)	20
4.2.9 TEST RESULTS (ABOVE1000 MHz)	20
5 . 26dB SPECTRUM BANDWIDTH	21
5.1 APPLIED PROCEDURES / LIMIT	21
5.1.1 TEST PROCEDURE	21
5.1.2 DEVIATION FROM STANDARD	21
5.1.3 TEST SETUP	21
5.1.4 EUT OPERATION CONDITIONS	21
5.1.5 EUT TEST CONDITIONS	22
5.1.6 TEST RESULTS	22
6 .MAXIMUM CONDUCTED OUTPUT POWER	23

Table of Contents	Page
6.1 APPLIED PROCEDURES / LIMIT	23
6.1.1 TEST PROCEDURE	23
6.1.2 DEVIATION FROM STANDARD	24
6.1.3 TEST SETUP	24
6.1.4 EUT OPERATION CONDITIONS	24
6.1.5 EUT TEST CONDITIONS	24
6.1.6 TEST RESULTS	24
7 .POWER SPECTRAL DENSITY TEST	25
7.1 APPLIED PROCEDURES / LIMIT	25
7.1.1 TEST PROCEDURE	25
7.1.2 DEVIATION FROM STANDARD	26
7.1.3 TEST SETUP	26
7.1.4 EUT OPERATION CONDITIONS	26
7.1.5 EUT TEST CONDITIONS	26
7.1.6 TEST RESULTS	26
8 . FREQUENCY STABILITY MEASUREMENT	27
8.1 APPLIED PROCEDURES / LIMIT	27
8.1.1 TEST PROCEDURE	27
8.1.2 DEVIATION FROM STANDARD	27
8.1.3 TEST SETUP	28
8.1.4 EUT OPERATION CONDITIONS	28
8.1.5 EUT TEST CONDITIONS	28
8.1.6 TEST RESULTS	28
9 . MEASUREMENT INSTRUMENTS LIST	29
10 .EUT TEST PHOTOS	31
ATTACHMENT A -CONDUCTED EMISSION	35
ATTACHMENT B -RADIATED EMISSION (9KHZ TO 30MHZ)	38
ATTACHMENT C -RADIATED EMISSION (30MHZ TO 1000MHZ)	40
ATTACHMENT D -RADIATED EMISSION (ABOVE 1000MHZ)	53
ATTACHMENT E -BANDWIDTH	172
ATTACHMENT F - MAXIMUM OUTPUT POWER	195
ATTACHMENT G - POWER SPECTRAL DENSITY	209
ATTACHMENT H-FREQUENCY STABILITY	278

REPORT ISSUED HISTORY

Issued No.	Description	Issued Date
BTL-FCCP-2-1608C055	Original Issue.	Aug. 30, 2016

1. CERTIFICATION

Equipment : AC1900 Enhanced Smart Dual-band Gigabit WiFi Router
Brand Name : Tenda
Model Name : AC18
Applicant : SHENZHEN TENDA TECHNOLOGY CO.,LTD
Manufacturer : SHENZHEN TENDA TECHNOLOGY CO.,LTD
Address : 6-8 Floor, Tower E3, No. 1001, Zhongshanyuan Road, Nanshan District,
Shenzhen, China. 518052
Date of Test : Aug. 05, 2016 ~ Aug. 29, 2016
Test Sample : ENGINEERING SAMPLE
Standard(s) : FCC Part15, Subpart E(15.407) / ANSI C63.10-2013

The above equipment has been tested and found compliance with the requirement of the relative standards by BTL Inc.

The test data, data evaluation, and equipment configuration contained in our test report (Ref No. BTL-FCCP-2-1608C055) were obtained utilizing the test procedures, test instruments, test sites that has been accredited by the Authority of TAF according to the ISO-17025 quality assessment standard and technical standard(s).

2. SUMMARY OF TEST RESULTS

Test procedures according to the technical standard(s):

FCC Part15, Subpart E			
Standard(s) Section	Test Item	Judgment	Remark
15.207	AC Power Line Conducted Emissions	PASS	
15.407(a)	26dB Spectrum Bandwidth	PASS	
15.407(a)	Maximum Conducted Output Power	PASS	
15.407(a)	Power Spectral Density	PASS	
15.407(a)	Radiated Emissions	PASS	
15.407(b)	Band Edge Emissions	PASS	
15.407(g)	Frequency Stability	PASS	
15.203	Antenna Requirements	PASS	

NOTE:

(1) "N/A" denotes test is not applicable in this test report.

2.1 TEST FACILITY

The test facilities used to collect the test data in this report is at the location of No.3,Jinshagang 1st Road, Shixia, Dalang Town, Dongguan, Guangdong, China.

BTL's test firm number for FCC: 319330

2.2 MEASUREMENT UNCERTAINTY

Where relevant, the following measurement uncertainty levels have been estimated for tests performed on the EUT as specified in CISPR 16-4-2. The BTL measurement uncertainty is less than the CISPR 16-4-2 U_{CISPR} requirement.

The reported uncertainty of measurement $y \pm U$, where expanded uncertainty U is based on a standard uncertainty multiplied by a coverage factor of $k=2$, providing a level of confidence of approximately 95%.

A. Conducted Measurement:

Test Site	Method	Measurement Frequency Range	U, (dB)
DG-C02	CISPR	150 KHz~30MHz	1.94

B. Radiated Measurement:

Test Site	Method	Measurement Frequency Range	Ant. H / V	U, (dB)
DG-CB03	CISPR	9kHz~30MHz	V	3.79
		9kHz~30MHz	H	3.57
		30MHz~200MHz	V	3.82
		30MHz~200MHz	H	3.60
		200MHz~ 1,000MHz	V	3.86
		200MHz~ 1,000MHz	H	3.94
		1GHz~18GHz	V	3.12
		1GHz~18GHz	H	3.68
		18GHz~40GHz	V	4.15
		18GHz~40GHz	H	4.14

Note: Unless specifically mentioned, the uncertainty of measurement has not been taken into account to declare the compliance or non-compliance to the specification.

3. GENERAL INFORMATION

3.1 GENERAL DESCRIPTION OF EUT

Equipment	AC1900 Enhanced Smart Dual-band Gigabit WiFi Router	
Brand Name	Tenda	
Model Name	AC18	
Mode Different	N/A	
Product Description	Operation Frequency	UNII-1: 5150-5250MHz UNII-3: 5725-5850MHz
	Modulation Type	OFDM
Output Power	Output Power (Max.)for UNII-1	802.11a:19.74dBm 802.11n (20M): 22.27dBm 802.11n (40M): 23.82dBm 802.11ac (20M): 21.52dBm 802.11ac (40M): 22.14dBm 802.11ac (80M): 24.32dBm
	Output Power (Max.)for UNII-3	802.11a:24.71dBm 802.11n (20M): 26.41dBm 802.11n (40M): 27.27dBm 802.11ac (20M): 27.51dBm 802.11ac (40M): 27.19dBm 802.11ac (80M): 27.63dBm
Power Source	DC voltage supplied from AC/DC adapter. Brand Name: SHENZHEN HEWEISHUN NETWORK TECHNOLOGY CO.,LTD. Model Name:BN059-A30012U	
Power Rating	IP: 100-240V~50/60Hz0.9A OP:12V---2.5A	

Note:

1. For a more detailed features description, please refer to the manufacturer's specifications or the User's Manual.

2. Channel List:

UNII-1		UNII-1		UNII-1	
Channel	Frequency (MHz)	Channel	Frequency (MHz)	Channel	Frequency (MHz)
36	5180	38	5190	42	5210
40	5200	46	5230		
44	5220				
48	5240				

UNII-3		UNII-3		UNII-3	
Channel	Frequency (MHz)	Channel	Frequency (MHz)	Channel	Frequency (MHz)
149	5745	151	5755	155	5775
153	5765	159	5795		
157	5785				
161	5805				
165	5825				

3. Antenna Specification:

Ant.	Brand	Model Name	Antenna Type	Connector	Gain(dBi)
1	Tenda	AC18 V1.0	Dipole	N/A	3
2	Tenda	AC18 V1.0	Dipole	N/A	3
3	Tenda	AC18 V1.0	Dipole	N/A	3

Note:

The EUT incorporates a MIMO function. Physically, the EUT provides three completed transmitters and receivers (3T3R), all transmit signals are completely uncorrelated, then, **Direction gain = G_{ANT}** , that is Directional gain=3.

4.

Operating Mode TX Mode	1TX	3TX
802.11a	V (ANT 1)	-
802.11n(20MHz)	-	V (ANT+1 ANT 2+ANT 3)
802.11n(40MHz)	-	V (ANT+1 ANT 2+ANT 3)
802.11ac (20MHz)	-	V (ANT+1 ANT 2+ANT 3)
802.11ac (40MHz)	-	V (ANT+1 ANT 2+ANT 3)
802.11ac (80MHz)	-	V (ANT+1 ANT 2+ANT 3)

3.2 DESCRIPTION OF TEST MODES

To investigate the maximum EMI emission characteristics generates from EUT, the test system was pre-scanning tested base on the consideration of following EUT operation mode or test configuration mode which possible have effect on EMI emission level. Each of these EUT operation mode(s) or test configuration mode(s) mentioned above was evaluated respectively.

Pretest Mode	Description
Mode 1	TX A Mode/ CH36, CH40, CH48 (UNII-1)
Mode 2	TX N20 Mode/ CH36, CH40, CH48 (UNII-1)
Mode 3	TX N40 Mode/ CH38, CH46 (UNII-1)
Mode 4	TX AC20 Mode/ CH36, CH40, CH48 (UNII-1)
Mode 5	TX AC40 Mode/ CH38, CH46 (UNII-1)
Mode 6	TX AC80 Mode / CH42 (UNII-1)
Mode 7	TX A Mode / CH149,CH157,CH165 (UNII-3)
Mode 8	TX N20 Mode / CH149,CH157,CH165 (UNII-3)
Mode 9	TX N40 Mode / CH151,CH159 (UNII-3)
Mode 10	TX AC20 Mode / CH149,CH157,CH165 (UNII-3)
Mode 11	TX AC40 Mode / CH151,CH159 (UNII-3)
Mode 12	TX AC80 Mode / CH155 (UNII-3)
Mode 13	TX Mode

The EUT system operated these modes were found to be the worst case during the pre-scanning test as following:

For Conducted Test	
Final Test Mode	Description
Mode 13	TX Mode

For Radiated Test	
Final Test Mode	Description
Mode 1	TX A Mode/ CH36, CH40, CH48 (UNII-1)
Mode 2	TX N20 Mode/ CH36, CH40, CH48 (UNII-1)
Mode 3	TX N40 Mode/ CH38, CH46 (UNII-1)
Mode 4	TX AC20 Mode/ CH36, CH40, CH48 (UNII-1)
Mode 5	TX AC40 Mode/ CH38, CH46 (UNII-1)
Mode 6	TX AC80 Mode / CH42 (UNII-1)
Mode 7	TX A Mode / CH149,CH157,CH165 (UNII-3)
Mode 8	TX N20 Mode / CH149,CH157,CH165 (UNII-3)
Mode 9	TX N40 Mode / CH151,CH159 (UNII-3)
Mode 10	TX AC20 Mode / CH149,CH157,CH165 (UNII-3)
Mode 11	TX AC40 Mode / CH151,CH159 (UNII-3)
Mode 12	TX AC80 Mode / CH155 (UNII-3)

Note:

(1) For radiated below 1GHz test, the 802.11a mode is found to be the worst case and recorded.

3.3 TABLE OF PARAMETERS OF TEST SOFTWARE SETTING

During testing channel & power controlling software provided by the customer was used to control the operating channel as well as the output power level. The RF output power selection is for the setting of RF output power expected by the customer and is going to be fixed on the firmware of the final end product

UNII-1			
Test Software Version	RT3x7xQA		
Frequency (MHz)	5180	5200	5240
A Mode	74	80	72
N20 Mode	70	65	66
Frequency (MHz)	5190	5230	
N40 Mode	70	80	

UNII-3			
Test Software Version	RT3x7xQA		
Frequency (MHz)	5745	5785	5825
A Mode	96	102	100
N20 Mode	90	80	80
Frequency (MHz)	5755	5795	
N40 Mode	95	95	

UNII-1			
Test Software Version	RT3x7xQA		
Frequency (MHz)	5180	5200	5240
AC20 Mode	66	60	63
Frequency (MHz)	5190	5230	
AC40 Mode	64	72	
Frequency (MHz)	5210		
AC80 Mode	80		

UNII-3			
Test Software Version	RT3x7xQA		
Frequency (MHz)	5745	5785	5825
AC20 Mode	95	80	85
Frequency (MHz)	5755	5795	
AC40 Mode	95	95	
Frequency (MHz)	5775		
AC80 Mode	95		

3.4 BLOCK DIAGRAM SHOWING THE CONFIGURATION OF SYSTEM TESTED

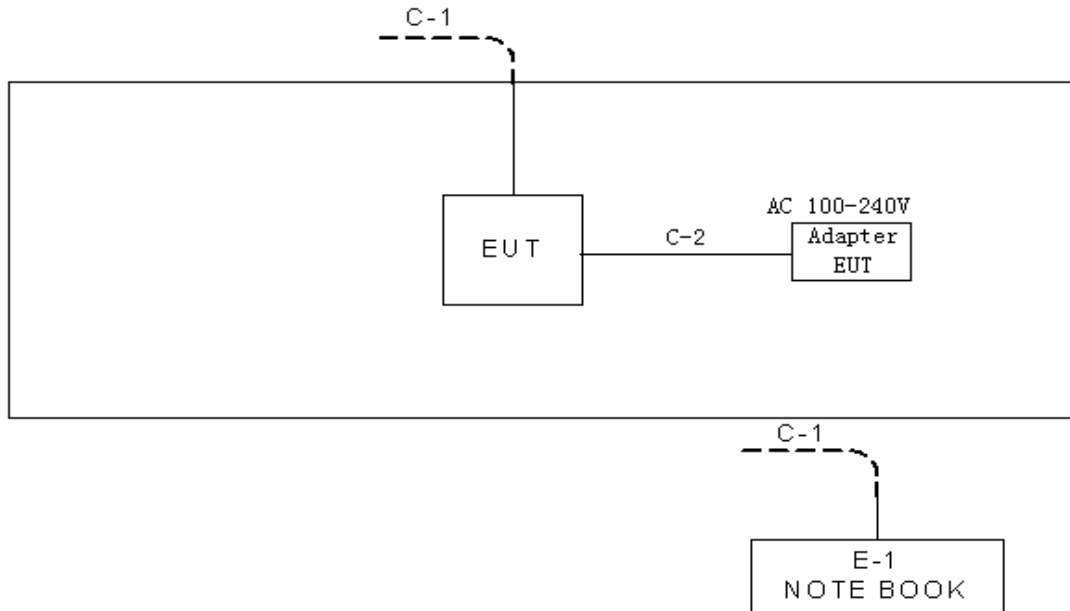

3.5 DESCRIPTION OF SUPPORT UNITS

The EUT has been tested as an independent unit together with other necessary accessories or support units. The following support units or accessories were used to form a representative test configuration during the tests.

Item	Equipment	Mfr/Brand	Model/Type No.	FCC ID	Series No.
E-1	NOTEBOOK	Dell	DCSM 745	DOC	G7K832X

Item	Shielded Type	Ferrite Core	Length	Note
C-1	NO	NO	10m	RJ45 Cable
C-2	NO	NO	1.2m	Power Cable

4. EMC EMISSION TEST

4.1 CONDUCTED EMISSION MEASUREMENT

4.1.1 POWER LINE CONDUCTED EMISSION (Frequency Range 150kHz-30MHz)

FREQUENCY (MHz)	Class A (dBuV)		Class B (dBuV)	
	Quasi-peak	Average	Quasi-peak	Average
0.15 -0.5	79.00	66.00	66 - 56 *	56 - 46 *
0.50 -5.0	73.00	60.00	56.00	46.00
5.0 -30.0	73.00	60.00	60.00	50.00

Note:

- (1) The tighter limit applies at the band edges.
- (2) The limit of " * " marked band means the limitation decreases linearly with the logarithm of the frequency in the range.

4.1.2 TEST PROCEDURE

- a. The EUT was placed 0.8 meters from the horizontal ground plane with EUT being connected to the power mains through a line impedance stabilization network (LISN). All other support equipments powered from additional LISN(s). The LISN provide 50 Ohm/ 50uH of coupling impedance for the measuring instrument.
- b. Interconnecting cables that hang closer than 40 cm to the groundplane shall be folded back and forth in the center forming a bundle 30 to 40 cm long.
- c. I/O cables that are not connected to a peripheral shall be bundled in the center. The end of the cable may be terminated, if required, using the correct terminating impedance. The overall length shall not exceed 1 m.
- d. LISN at least 80 cm from nearest part of EUT chassis.
- e. For the actual test configuration, please refer to the related Item –EUT Test Photos.

4.1.3 DEVIATION FROM TEST STANDARD

No deviation

4.1.4 TESTSETUP

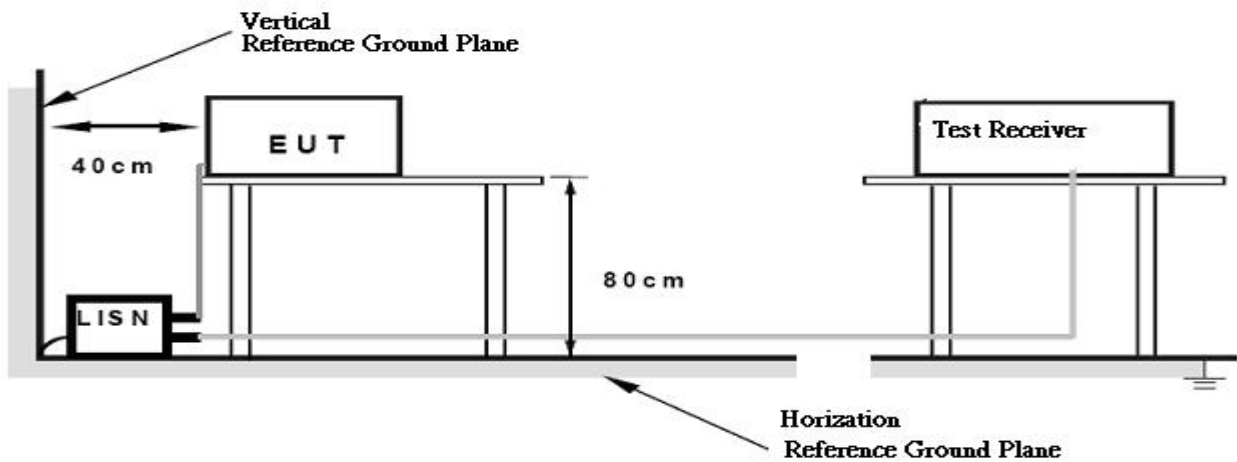

4.1.5 EUT OPERATING CONDITIONS

The EUT was configured for testing in a typical fashion (as a customer would normally use it). The EUT has been programmed to continuously transmit during test. This operating condition was tested and used to collect the included data.

The EUT was programmed to be in continuously transmitting/TX Mode mode.

4.1.6 EUT TEST CONDITIONS

Temperature: 25°C Relative Humidity: 53% Test Voltage: AC 120V/60Hz

4.1.7 TEST RESULTS

Please refer to the Attachment A.

Remark:

- (1) All readings are QP Mode value unless otherwise stated AVG in column of 『Note』. If the QP Mode Measured value compliance with the QP Limits and lower than AVG Limits, the EUT shall be deemed to meet both QP & AVG Limits and then only QP Mode was measured, but AVG Mode didn't perform. In this case, a “*” marked in AVG Mode column of Interference Voltage Measured.
- (2) Measuring frequency range from 150kHz to 30MHz.

4.2 RADIATED EMISSION MEASUREMENT

4.2.1 RADIATED EMISSION LIMITS

20dBc in any 100 kHz bandwidth outside the operating frequency band. In case the emission fall within the restricted band specified on 15.205(a), then the 15.209(a) limit in the table below has to be followed.

Frequencies (MHz)	Field Strength (microrvolts/meter)	Measurement Distance (meters)
0.009~0.490	2400/F(kHz)	300
0.490~1.705	24000/F(kHz)	30
1.705~30.0	30	30
30~88	100	3
88~216	150	3
216~960	200	3
Above 960	500	3

Note:

- (1) The limit for radiated test was performed according to FCC PART 15C.
- (2) The tighter limit applies at the band edges.

LIMITS OF UNWANTED EMISSION OUT OF THE RESTRICTED BANDS

Frequencies (MHz)	EIRP Limit (dBm)	Equivalent Field Strength at 3m (dBμV/m) E[dBuV/m]=EIRP[dBm]+95.3
5150-5250	-27	68.3
5250-5350	-27	68.3
5470-5725	-27	68.3
5725-5850	-27(Note 2)	68.3
	10(Note 2)	105.3
	15.6(Note 2)	110.9(=95.3+15.6)
	27(Note 2)	122.3(=95.3+27)

Note:

1. The following formula is used to convert the equipment isotropic radiated power (eirp) to

field strength: $E = \frac{1000000\sqrt{30P}}{3} \mu\text{V/m}$, where P is the eirp (Watts)

2. According to FCC 16-24, All emissions shall be limited to a level of -27 dBm/MHz at 75 MHz or more above or below the band edge increasing linearly to 10 dBm/MHz at 25 MHz above or below the band edge, and from 25MHz above or below the band edge increasing linearly to a level of 15.6 dBm/MHz at 5 MHz above or below the band edge, and from 5 MHz above or below the band edge increasing linearly to a level of 27dBm/MHz at the band edge.

4.2.2 TEST PROCEDURE

- a. The measuring distance of at 3 m shall be used for measurements. The EUT was placed on the top of a rotating table 0.8 meter above the ground at a 3 meter semi-anechoic chamber. The table was rotated 360 degrees to determine the position of the highest radiation.(below 1GHz)
- b. The measuring distance of at 3 m shall be used for measurements. The EUT was placed on the top of a rotating table 1.5 meter above the ground at a 3 meter semi-anechoic chamber. The table was rotated 360 degrees to determine the position of the highest radiation.(above 1GHz)
- c. The height of the equipment or of the substitution antenna shall be 0.8m or 1.5m; the height of the test antenna shall vary between 1 m to 4 m. Both horizontal and vertical polarizations of the antenna are set to make the measurement.
- d. For each suspected emission, the EUT was arranged to its worst case and then the antenna was tuned to heights find the maximum reading (used Bore sight function).
- e. The receiver system was set to peak and average detect function and specified bandwidth with maximum hold mode when the test frequency is above 1GHz.
- f. The initial step in collecting conducted emission data is a receiver peak detector mode pre-scanning the measurement frequency range. Significant peaks are then marked and then Quasi Peak detector mode re-measured.
- g. All readings are Peak unless otherwise stated QP in column of Note. Peak denotes that the Peak reading compliance with the QP Limits and then QP Mode measurement didn't perform. (below 1GHz)
- h. All readings are Peak Mode value unless otherwise stated AVG in column of Note. If the Peak Mode Measured value compliance with the Peak Limits and lower than AVG Limits, the EUT shall be deemed to meet both Peak & AVG Limits and then only Peak Mode was measured, but AVG Mode didn't perform. (above 1GHz)
- i. For the actual test configuration, please refer to the related Item –EUT Test Photos.

4.2.3 DEVIATIONFROMTESTSTANDARD

No deviation

4.2.4 TESTSETUP

(A)Radiated Emission Test Set-Up Frequency Below 1GHz

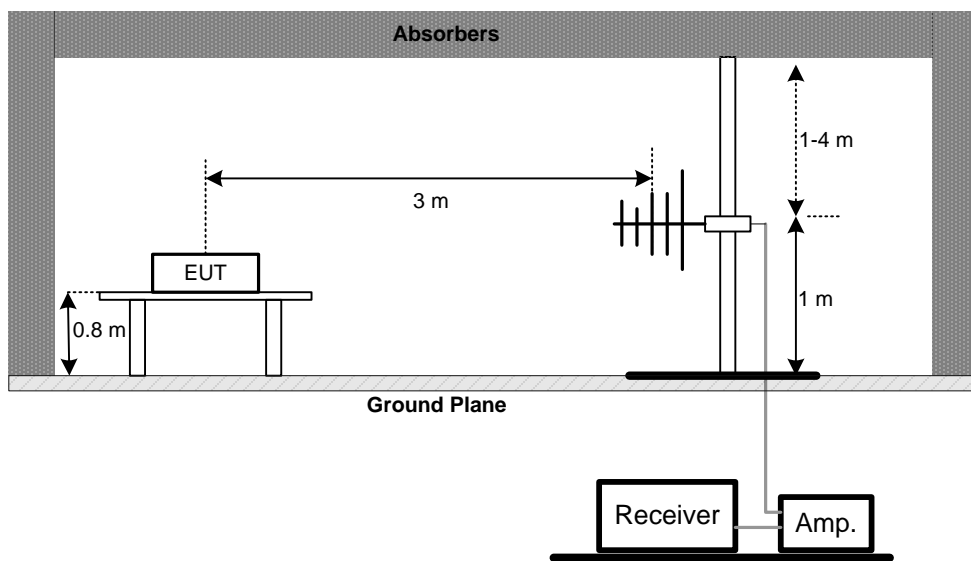

(B) Radiated Emission Test Set-Up Frequency Above 1 GHz

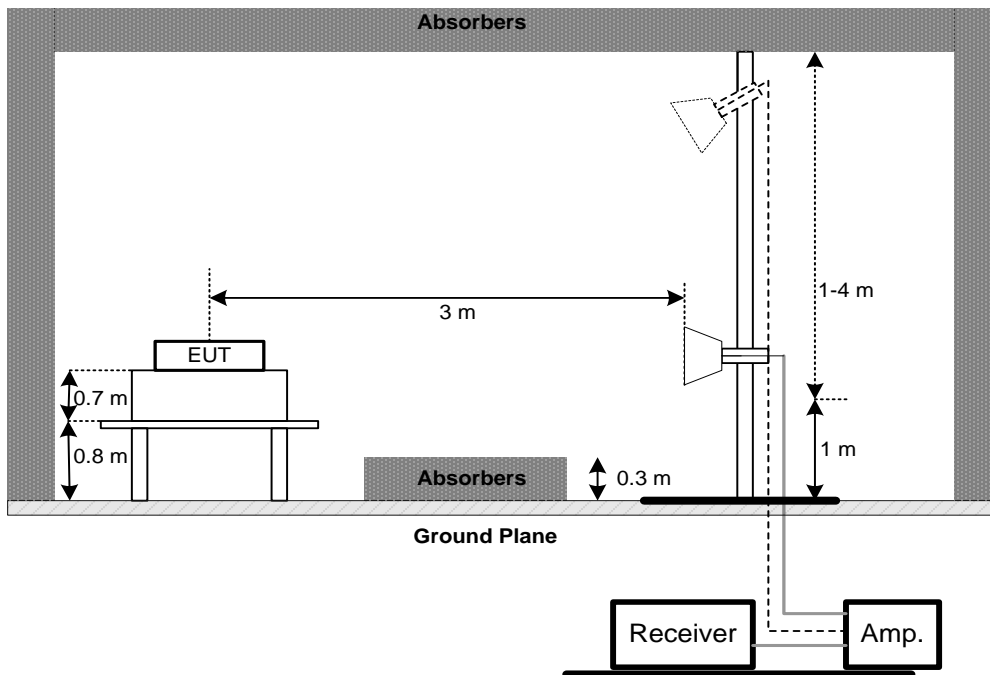

(C) Radiated emissions below 30MHz

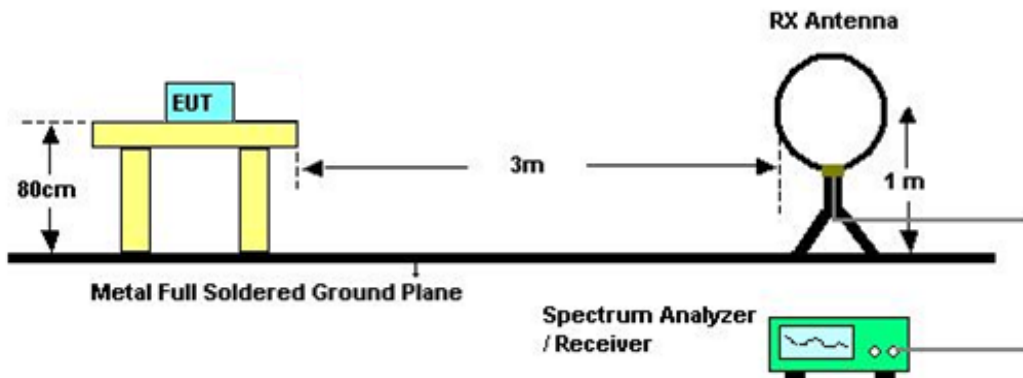

4.2.5 EUT OPERATING CONDITIONS

The EUT tested system was configured as the statements of 4.1.5 unless otherwise a special operating condition is specified in the follows during the testing.

4.2.6 EUT TEST CONDITIONS

Temperature: 25°C Relative Humidity: 60% Test Voltage: AC 120V/60Hz

4.2.7 TEST RESULTS (9K TO 30MHz)

Please refer to the Attachment B

Remark:

- (1) The amplitude of spurious emissions which are attenuated by more than 20 dB below the permissible value has no need to be reported.
- (2) Distance extrapolation factor = $40 \log(\text{specific distance} / \text{test distance})$ (dB);
- (3) Limit line = specific limits (dBuV) + distance extrapolation factor.

4.2.8 TEST RESULTS(BETWEEN30 TO 1000 MHz)

Please refer to the Attachment C.

Remark:

- (1) Reading in which marked as QP or Peak means measurements by using are Quasi-Peak Mode or Peak Modewith Detector BW=120kHz ; SPA setting in RBW=120kHz, VBW =120kHz, Swp. Time = 0.3 sec./MHz ◦
- (2) All readings are Peak unless otherwise stated QP in column of 『Note』 . Peak denotes that the Peak reading compliance with the QP Limits and then QP Mode measurement didn't perform ◦
- (3) Measuring frequency range from 30MHz to 1000MHz ◦
- (4) If the peak scan value lower limit more than 20dB, then this signal data does not show in table ◦

4.2.9 TEST RESULTS (ABOVE1000 MHz)

Please refer to the Attachment D.

Remark:

- (1) Spectrum Setting: 30MHz – 1000MHz , RBW= 100kHz, VBW=100kHz, Sweep time = 200 ms. 1GHz- 40GHz, RBW= 1MHz, VBW= 1MHz, Sweep time = Auto
- (2) All readings are Peak unless otherwise stated AV in column of 『Note』 . Peak denotes that the Peak reading compliance with the AV Limits and then AV Mode measurement didn't perform.
- (3) Radiated emissions measured in frequency range above 1000MHz were made with an instrument using Peak detector mode and AV detector mode of the emission ◦
- (4) Data of measurement within this frequency range shown “ * ” in the table above means the reading of emissions are attenuated more than 20dB below the permissible limits or the field strength is too small to be measured.
- (5) A preamp and high pass filter were used for this test in order to provide sufficient measurement sensitivity.
- (6) EUT Orthogonal Axes:
“X” - denotes Laid on Table ; “Y” - denotes Vertical Stand ; “Z” - denotes Side Stand
- (7) During the measurements above 1GHz it is taken care of that the EUT is always within the 3dB cone of radiation BW of the used antenna.
- (8) No limit:This is fundamental signal, the judgment is not applicable.
For fundamental signal judgment was referred to Peak output test.

5. 26dB SPECTRUM BANDWIDTH

5.1 APPLIED PROCEDURES / LIMIT

FCC Part15, Subpart E			
Test Item	Limit	Frequency Range (MHz)	Result
Bandwidth	26 dB Bandwidth	5150-5250	PASS
	Minimum 500kHz 6dB Bandwidth	5725-5850	PASS

5.1.1 TEST PROCEDURE

a. The EUT was directly connected to the spectrum analyzer and antenna output port as show in the block diagram below,

b.

Spectrum Parameters	Setting
Attenuation	Auto
Span Frequency	> 26dB Bandwidth
RBW	300 kHz
VBW	1000 kHz
Detector	Peak
Trace	Max Hold
Sweep Time	Auto

c. Measured the spectrum width with power higher than 26dB below carrier

5.1.2 DEVIATION FROM STANDARD

No deviation.

5.1.3 TEST SETUP

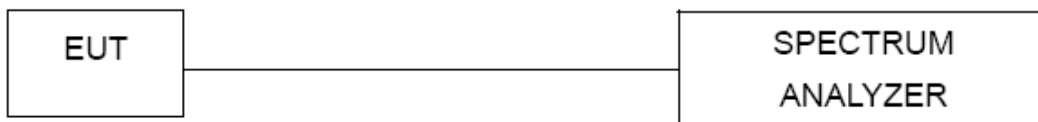

5.1.4 EUT OPERATION CONDITIONS

The EUT tested system was configured as the statements of 4.1.5 unless otherwise a special operating condition is specified in the follows during the testing.

5.1.5 EUT TEST CONDITIONS

Temperature: 25°C Relative Humidity: 60% Test Voltage: AC 120V/60Hz

5.1.6 TEST RESULTS

Please refer to the Attachment E.

6. MAXIMUM CONDUCTED OUTPUT POWER

6.1 APPLIED PROCEDURES / LIMIT

FCC Part15, Subpart E			
Test Item	Limit	Frequency Range (MHz)	Result
Conducted Output Power	Fixed:1 Watt (30dBm) Mobile and portable: 250mW (24dBm)	5150-5250	PASS
	1 Watt (30dBm)	5725-5850	PASS
Note: The maximum e.i.r.p at anyelevation angle above 30 degrees as measured from the horizon must not exceed 125mW(21dBm)			

6.1.1 TEST PROCEDURE

- a. The EUT was directly connected to the power meter and antenna output port as show in the block diagram below,

b.

Spectrum Parameter	Setting
Attenuation	Auto
Span Frequency	Encompass the entire emissions bandwidth (EBW) ofthe signal
RBW	= 1MHz.
VBW	≥ 3MHz.
Detector	RMS
Trace	Max Hold
Sweep Time	auto

- c. Test was performed in accordance with method of KDB 789033 D02.

6.1.2 DEVIATION FROM STANDARD

No deviation.

6.1.3 TEST SETUP



6.1.4 EUT OPERATION CONDITIONS

The EUT tested system was configured as the statements of 4.1.5 unless otherwise a special operating condition is specified in the follows during the testing.

6.1.5 EUT TEST CONDITIONS

Temperature: 25°C Relative Humidity: 60% Test Voltage: AC 120V/60Hz

6.1.6 TEST RESULTS

Please refer to the Attachment F.

7. POWER SPECTRAL DENSITY TEST

7.1 APPLIED PROCEDURES / LIMIT

FCC Part15, Subpart E			
Test Item	Limit	Frequency Range (MHz)	Result
Power Spectral Density	Other then Mobile and portable:17dBm/MHz Mobile and portable:11dBm/MHz	5150-5250	PASS
	30dBm/500kHz	5725-5850	PASS

7.1.1 TEST PROCEDURE

a. The EUT was directly connected to the spectrum analyzer and antenna output port as show in the block diagram below,

b.

Spectrum Parameter	Setting
Attenuation	Auto
Span Frequency	Encompass the entire emissions bandwidth (EBW) ofthe signal
RBW	= 1MHz.
VBW	≥ 3MHz.
Detector	RMS
Trace average	100 trace
Sweep Time	Auto

Note:

- 1.For UNII-3, according to KDB publication 789033 D02 General UNII Test Procedures New Rules v01r02, section II.F.5., it is acceptable to set RBW at 1MHz and VBW at 3MHz if the spectrum analyzer does not have 500kHz RBW.
- 2.The value measured with RBW=1MHz is to be added with $10\log(500\text{kHz}/1\text{MHz})$ which is -3dB. For example, if the measured value is +10dBm using RBW=1MHz (that is +10dBm/MHz), then the converted value will be +7dBm/500kHz.

7.1.2 DEVIATION FROM STANDARD

No deviation.

7.1.3 TEST SETUP

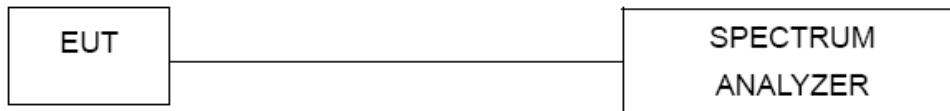

7.1.4 EUT OPERATION CONDITIONS

The EUT tested system was configured as the statements of 4.1.5 unless otherwise a special operating condition is specified in the follows during the testing.

7.1.5 EUT TEST CONDITIONS

Temperature: 25°C Relative Humidity: 60% Test Voltage: AC 120V/60Hz

7.1.6 TEST RESULTS

Please refer to the Attachment G.

8. FREQUENCY STABILITY MEASUREMENT

8.1 APPLIED PROCEDURES / LIMIT

FCC Part15, Subpart E			
Test Item	Limit	Frequency Range (MHz)	Result
Frequency Stability	Specified in the user's manual	5150-5250	PASS
		5725-5850	PASS

8.1.1 TEST PROCEDURE

a. The EUT was directly connected to the spectrum analyzer and antenna output port as show in the block diagram below,

b.

Spectrum Parameter	Setting
Attenuation	Auto
Span Frequency	Entire absence of modulation emissions bandwidth
RBW	10 kHz
VBW	10kHz
Sweep Time	Auto

c. The test extreme voltage is to change the primary supply voltage from 85 to 115 percent of the nominal value.

d. User manual temperature is 0°C~40°C.

8.1.2 DEVIATION FROM STANDARD

No deviation.

8.1.3 TEST SETUP

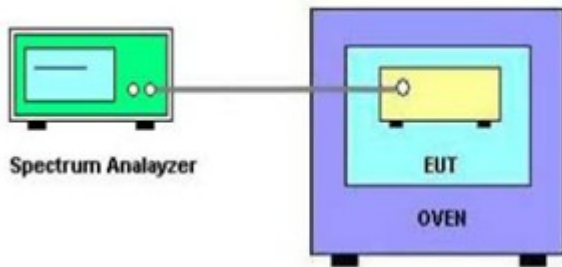

8.1.4 EUT OPERATION CONDITIONS

The EUT tested system was configured as the statements of 4.1.5 unless otherwise a special operating condition is specified in the follows during the testing.

8.1.5 EUT TEST CONDITIONS

Temperature: 25°C Relative Humidity: 55% Test Voltage: AC 120V/60Hz

8.1.6 TEST RESULTS

Please refer to the Attachment H.

9. MEASUREMENT INSTRUMENTS LIST

Conducted Emission Measurement					
Item	Kind of Equipment	Manufacturer	Type No.	Serial No.	Calibrated until
1	LISN	EMCO	3816/2	0052765	Mar. 27, 2017
2	LISN	R&S	ENV216	101447	Mar. 27, 2017
3	Test Cable	emci	RG223(9KHz-30 MHz)	C_17	Mar. 10, 2017
4	EMI Test Receiver	R&S	ESCI	100382	Mar. 27, 2017
5	50Ω Terminator	SHX	TF2-3G-A	08122901	Mar. 27, 2017
6	Measurement Software	Farad	EZ-EMC Ver.NB-03A1-01	N/A	N/A

Radiated Emission Measurement					
Item	Kind of Equipment	Manufacturer	Type No.	Serial No.	Calibrated until
1	Antenna	Schwarzbeck	VULB9160	9160-3232	Mar. 27, 2017
2	Amplifier	HP	8447D	2944A09673	Nov. 09, 2016
3	Receiver	AGILENT	N9038A	MY52130039	Oct. 11, 2016
4	Test Cable	emci	LMR-400(30MHz-1GHz)	C-01	Jun. 26, 2017
5	Control	CT	SC100	N/A	N/A
6	Position Control	MF	MF-7802	MF780208416	N/A
7	Antenna	ETS	3115	00075789	Mar. 27, 2017
8	Amplifier	Agilent	8449B	3008A02274	Nov. 01, 2016
9	Receiver	AGILENT	N9038A	MY52130039	Oct. 11, 2016
10	Test Cable	emci	EMC104-SM-S M-10000(1GHz-26.5GHz)	C-68	Jun. 26, 2017
11	Controller	CT	SC100	N/A	N/A
12	Broad-Band Horn Antenna	Schwarzbeck	BBHA 9170	9170319	Apr. 23, 2017
13	Microwave Pre-amplifier With Adaptor	EMC INSTRUMENT	EMC2654045	980039 & HA01	Mar. 27, 2017
14	Active Loop Antenna	R&S	HFH2-Z2	830749/020	Sep. 07, 2016
15	Measurement Software	Farad	EZ-EMC Ver.NB-03A1-01	N/A	N/A

Spectrum Bandwidth Measurement					
Item	Kind of Equipment	Manufacturer	Type No.	Serial No.	Calibrated until
1	Spectrum Analyzer	R&S	FSP 40	100185	Oct. 11, 2016

Maximum Conducted Output Power Measurement					
Item	Kind of Equipment	Manufacturer	Type No.	Serial No.	Calibrated until
1	P-series Power meter	Agilent	N1911A	MY45100473	Oct. 26, 2016
2	Wireband Power sensor	Agilent	N1921A	MY51100041	Oct. 26, 2016

Power Spectral Density Measurement					
Item	Kind of Equipment	Manufacturer	Type No.	Serial No.	Calibrated until
1	Spectrum Analyzer	R&S	FSP 40	100185	Oct. 11, 2016

Frequency Stability Measurement					
Item	Kind of Equipment	Manufacturer	Type No.	Serial No.	Calibrated until
1	Spectrum Analyzer	R&S	FSP 40	100185	Oct. 11, 2016
2	Precision Oven Tester	HOLINK	H-T-1F-D	BA03101701	May 22, 2017

Remark: "N/A" denotes no model name, serial no. or calibration specified.
 All calibration period of equipment list is one year.

10.EUT TEST PHOTOS

Conducted Measurement Photos



Radiated Measurement Photos

9kHz to 30MHz

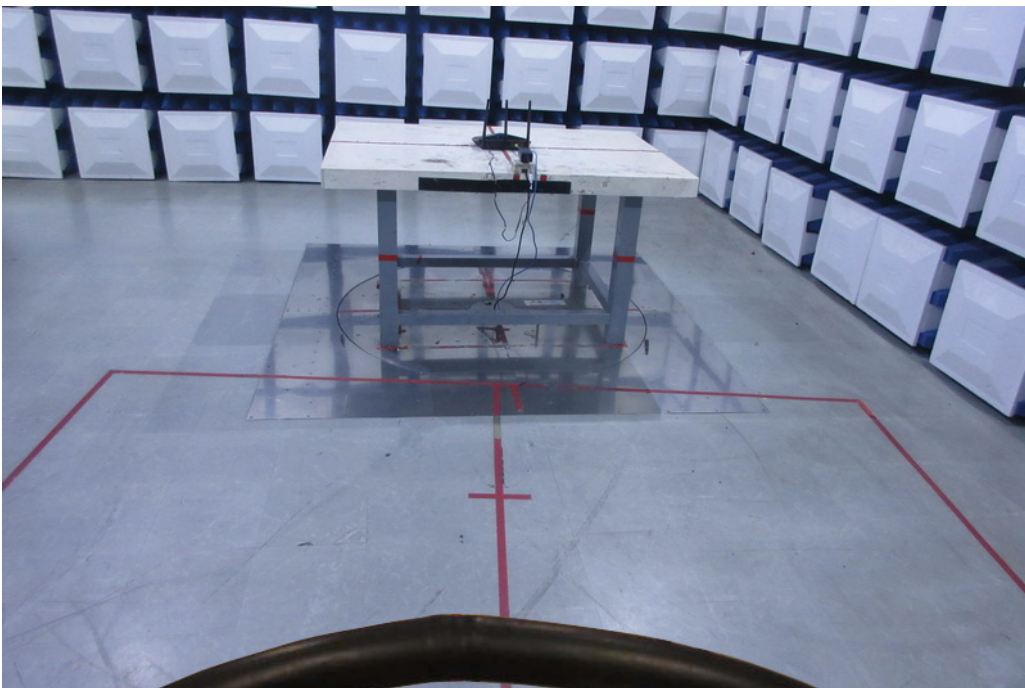
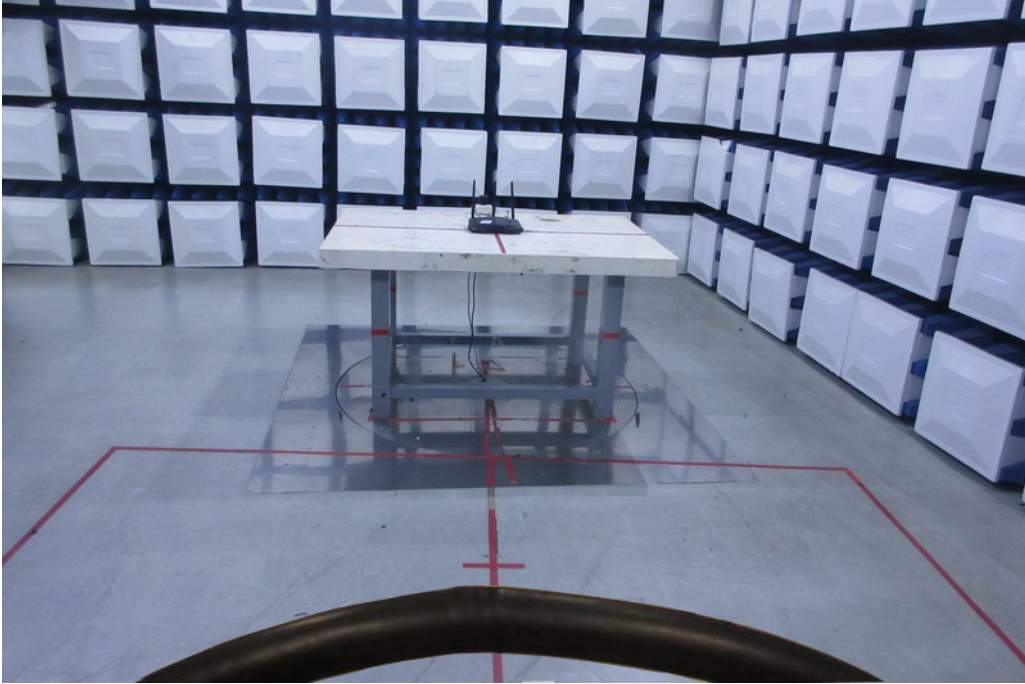

Radiated Measurement Photos

30MHz to 1000MHz

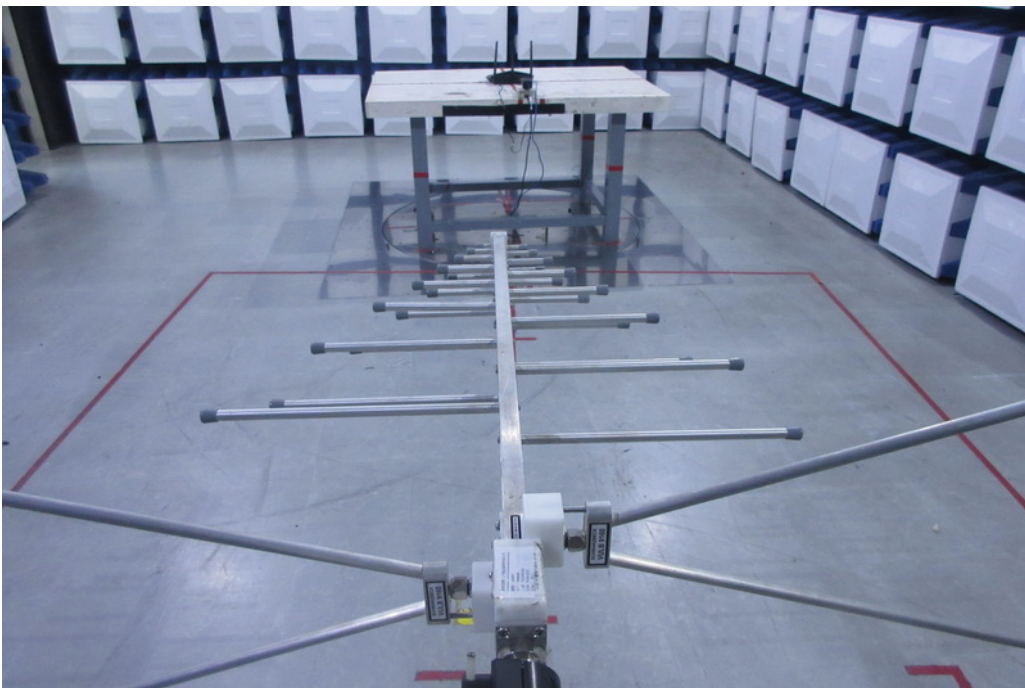

Radiated Measurement Photos

Above 1000MHz

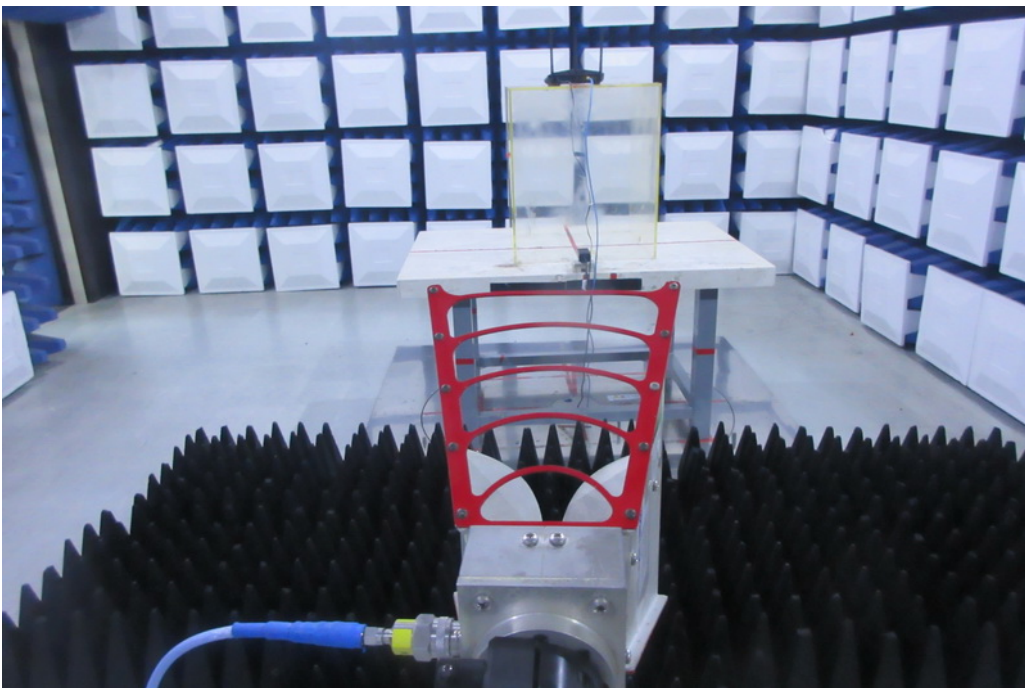
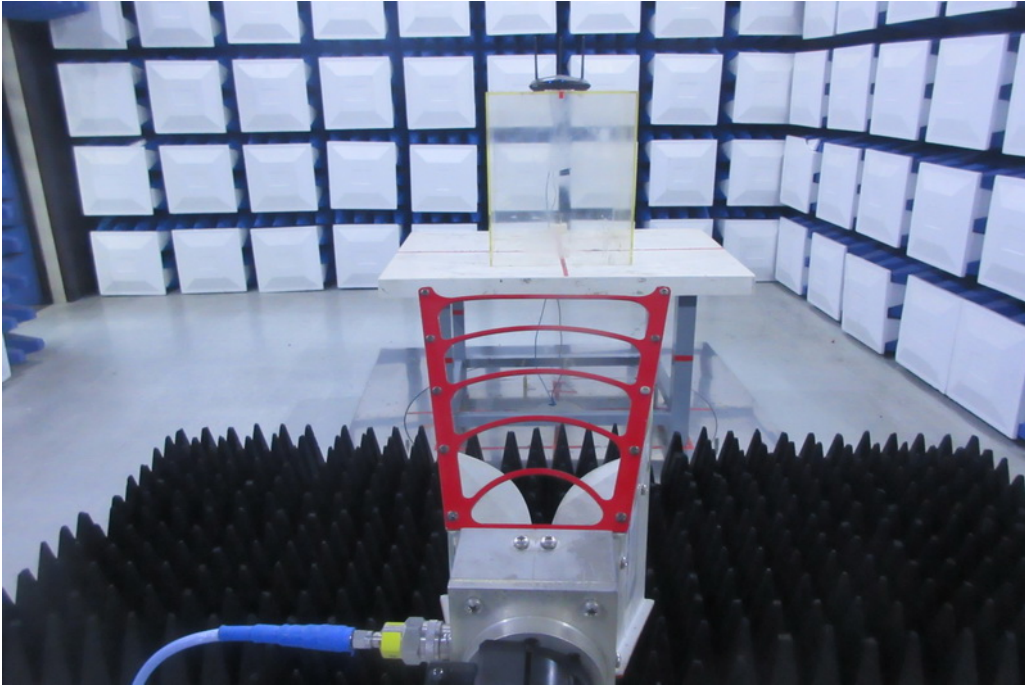

ATTACHMENT A -CONDUCTED EMISSION

Test Mode: TX Mode

Line

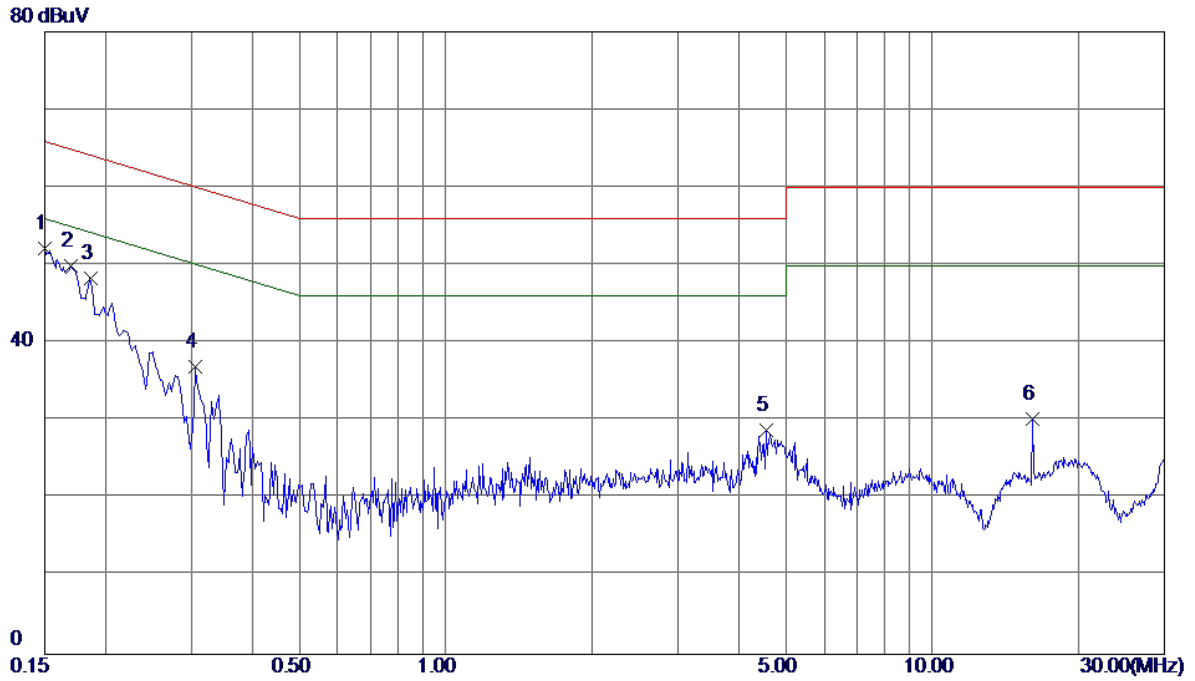

No.	Freq. MHz	Reading Level dBuV	Correct Factor dB	Measure ment dBuV	Limit dBuV	Margin dB	Detector	Comment
1 *	0.1500	42.70	9.52	52.22	66.00	-13.78	Peak	
2	0.1700	40.33	9.52	49.85	64.96	-15.11	Peak	
3	0.1860	38.77	9.53	48.30	64.21	-15.91	Peak	
4	0.3060	27.41	9.53	36.94	60.08	-23.14	Peak	
5	4.5620	18.66	10.08	28.74	56.00	-27.26	Peak	
6	16.1020	19.87	10.37	30.24	60.00	-29.76	Peak	

Note : The test result has included the cable loss.

Test Mode: TX Mode

Neutral

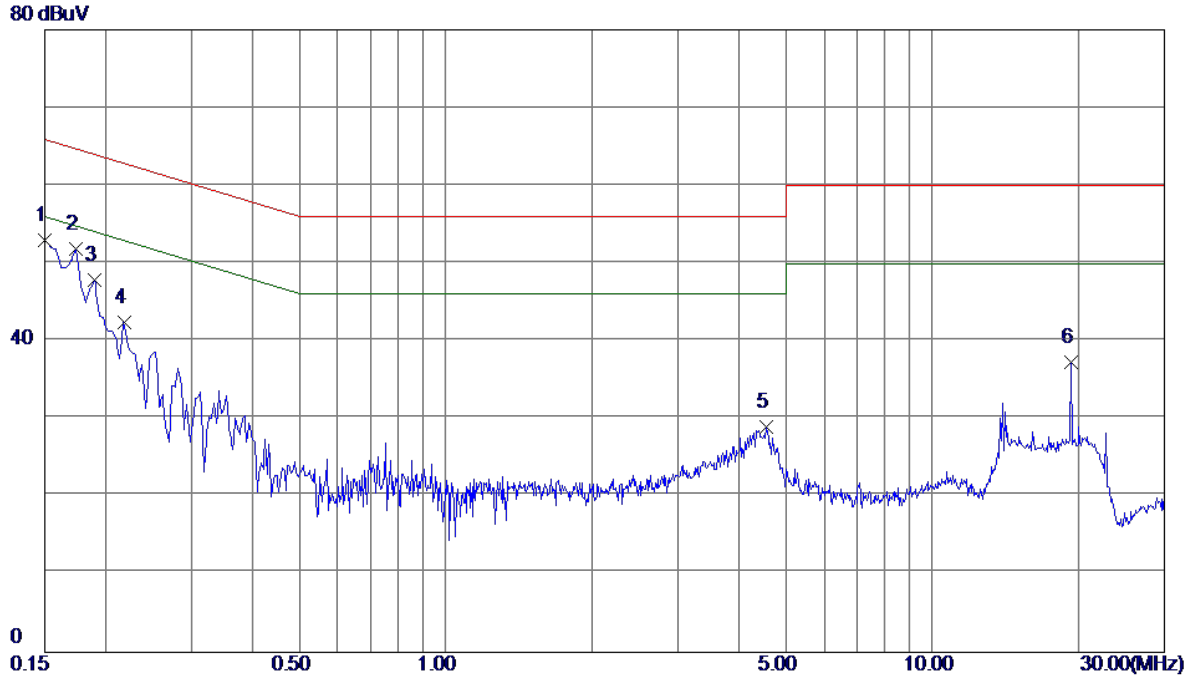

No.	Freq. MHz	Reading Level dBuV	Correct Factor dB	Measure ment dBuV	Limit dBuV	Margin dB	Detector	Comment
1	0.1500	43.43	9.52	52.95	66.00	-13.05	Peak	
2 *	0.1740	42.33	9.44	51.77	64.77	-13.00	Peak	
3	0.1900	38.41	9.49	47.90	64.04	-16.14	Peak	
4	0.2180	32.93	9.53	42.46	62.89	-20.43	Peak	
5	4.5660	19.03	9.95	28.98	56.00	-27.02	Peak	
6	19.2660	26.82	10.48	37.30	60.00	-22.70	Peak	

Note : The test result has included the cable loss.

ATTACHMENT B -RADIATED EMISSION (9KHZ TO 30MHZ)

Test Mode:	TX Mode
------------	---------

Frequency (MHz)	Ant 0°/90°	Read level dBuV/m	Factor (dB)	Measured(FS) (dBuV/m)	Limit (dBuV/m)	Margin (dB)	Note
0.0095	0°	13.41	24.9650	38.3750	128.0498	-89.6748	AVG
0.0095	0°	14.28	24.9650	39.2450	148.0498	-108.8048	PEAK
0.0276	0°	6.73	23.8187	30.5487	118.7860	-88.2374	AVG
0.0276	0°	8.12	23.8187	31.9387	138.7860	-106.8474	PEAK
0.0357	0°	3.17	23.3057	26.4757	116.5509	-90.0752	AVG
0.0357	0°	5.58	23.3057	28.8857	136.5509	-107.6652	PEAK
0.0566	0°	1.16	22.2680	23.4280	112.5479	-89.1199	AVG
0.0566	0°	2.53	22.2680	24.7980	132.5479	-107.7499	PEAK
0.5034	0°	19.36	19.8109	39.1709	73.5660	-34.3951	QP
1.9529	0°	23.71	19.5047	43.2147	69.5400	-26.3253	QP

Frequency (MHz)	Ant 0°/90°	Read level dBuV/m	Factor (dB)	Measured(FS) (dBuV/m)	Limit (dBuV/m)	Margin (dB)	Note
0.0119	90°	13.16	24.3000	37.4600	126.0933	-88.6333	AVG
0.0119	90°	14.89	24.3000	39.1900	146.0933	-106.9033	PEAK
0.0241	90°	7.28	24.0403	31.3203	119.9639	-88.6436	AVG
0.0241	90°	8.94	24.0403	32.9803	139.9639	-106.9836	PEAK
0.0437	90°	5.23	22.7990	28.0290	114.7946	-86.7656	AVG
0.047	90°	6.19	22.7990	28.9890	134.7946	-105.8056	PEAK
0.0554	90°	1.54	22.2920	23.8320	112.7340	-88.9020	AVG
0.0554	90°	2.86	22.2920	25.1520	132.7340	-107.5820	PEAK
0.6211	90°	22.17	20.1875	42.3575	71.7410	-29.3835	QP
2.0559	90°	24.56	19.4665	44.0265	69.5400	-25.5135	QP

ATTACHMENT C -RADIATED EMISSION (30MHZ TO 1000MHZ)

Test Mode: UNII-1/TX A Mode 5180MHz

Vertical

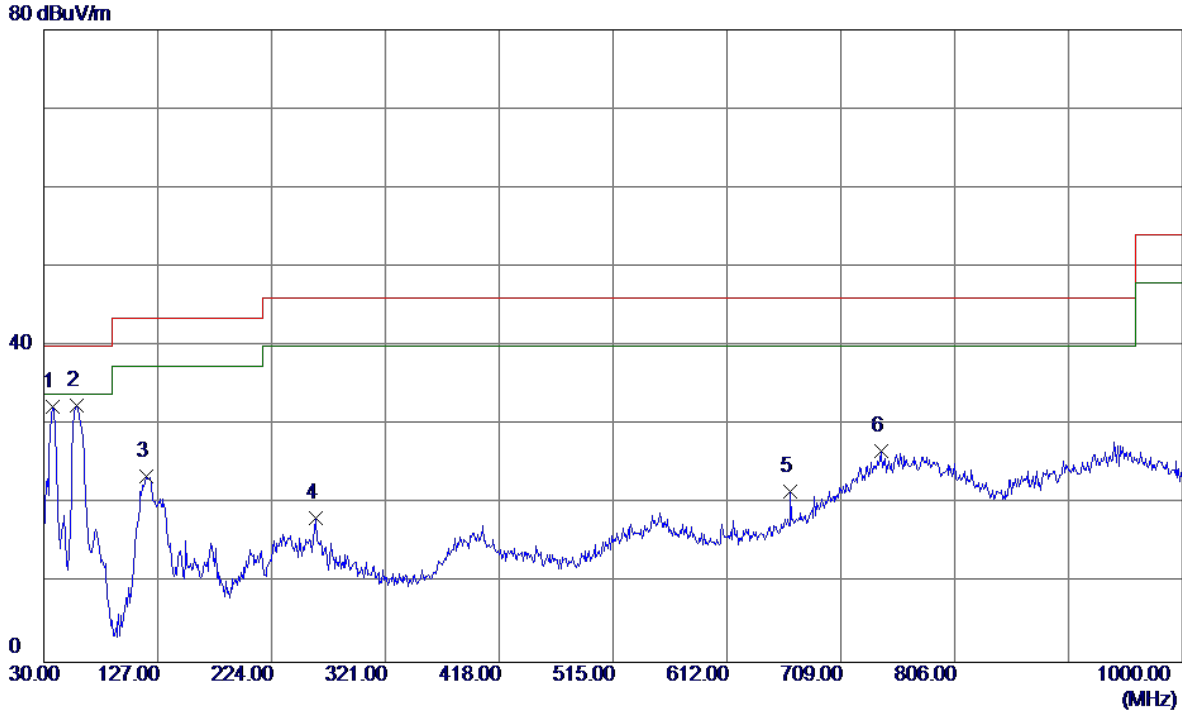

No.	Freq. MHz	Reading Level dBuV/m	Correct Factor dB	Measure ment dBuV/m	Limit dBuV/m	Margin dB	Detector	Comment
1	37.7599	53.26	-20.92	32.34	40.00	-7.66	Peak	
2 *	58.1300	53.74	-21.29	32.45	40.00	-7.55	Peak	
3	117.3000	44.72	-21.19	23.53	43.50	-19.97	Peak	
4	261.8299	33.94	-15.77	18.17	46.00	-27.83	Peak	
5	666.3200	33.05	-11.50	21.55	46.00	-24.45	Peak	
6	742.9500	30.82	-4.13	26.69	46.00	-19.31	Peak	

Test Mode: UNII-1/TX A Mode 5180MHz

Horizontal

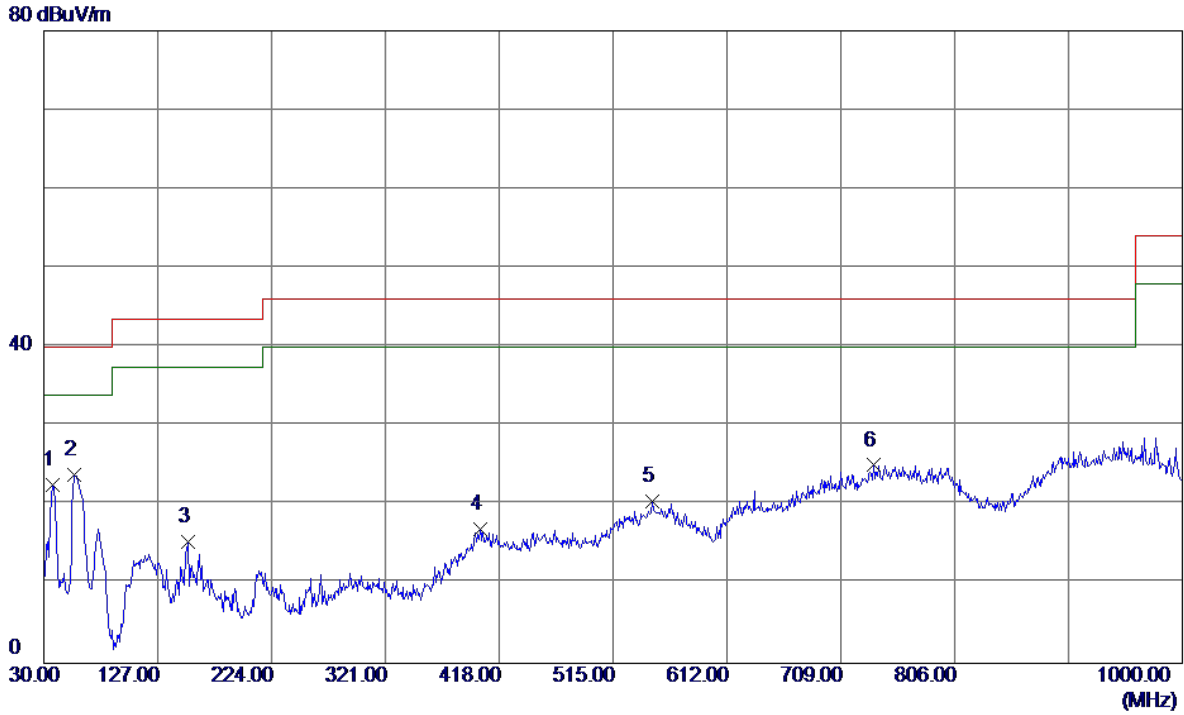

No.	Freq. MHz	Reading Level dBuV/m	Correct Factor dB	Measure ment dBuV/m	Limit dBuV/m	Margin dB	Detector	Comment
1	37.7599	43.20	-20.69	22.51	40.00	-17.49	Peak	
2 *	56.1900	44.53	-20.70	23.83	40.00	-16.17	Peak	
3	153.1900	37.68	-22.30	15.38	43.50	-28.12	Peak	
4	401.5100	29.78	-12.77	17.01	46.00	-28.99	Peak	
5	547.9800	29.47	-8.97	20.50	46.00	-25.50	Peak	
6	737.1300	30.42	-5.38	25.04	46.00	-20.96	Peak	

Test Mode: UNII-1/TX A Mode 5200MHz

Vertical

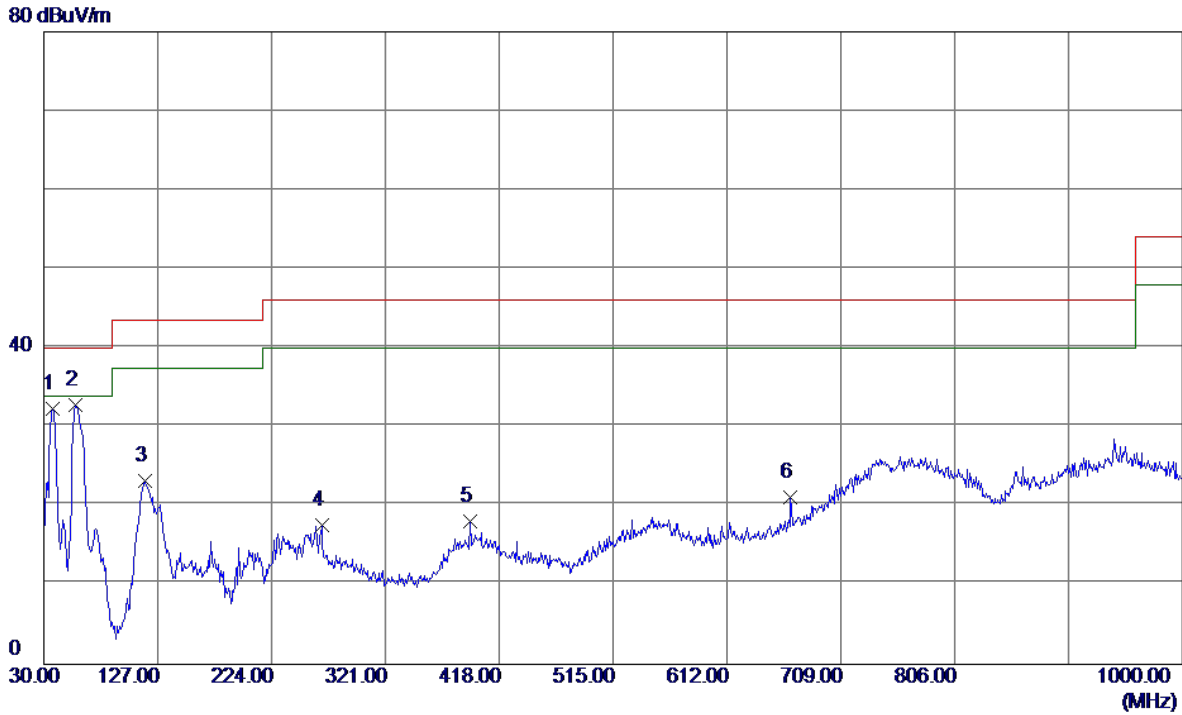

No.	Freq. MHz	Reading Level dBuV/m	Correct Factor dB	Measure ment dBuV/m	Limit dBuV/m	Margin dB	Detector	Comment
1	37.7599	53.19	-20.92	32.27	40.00	-7.73	Peak	
2 *	57.1600	53.71	-20.95	32.76	40.00	-7.24	Peak	
3	116.3300	44.83	-21.58	23.25	43.50	-20.25	Peak	
4	266.6800	33.44	-15.87	17.57	46.00	-28.43	Peak	
5	392.7800	30.70	-12.65	18.05	46.00	-27.95	Peak	
6	666.3200	32.61	-11.50	21.11	46.00	-24.89	Peak	

Test Mode: UNII-1/TX A Mode 5200MHz

Horizontal

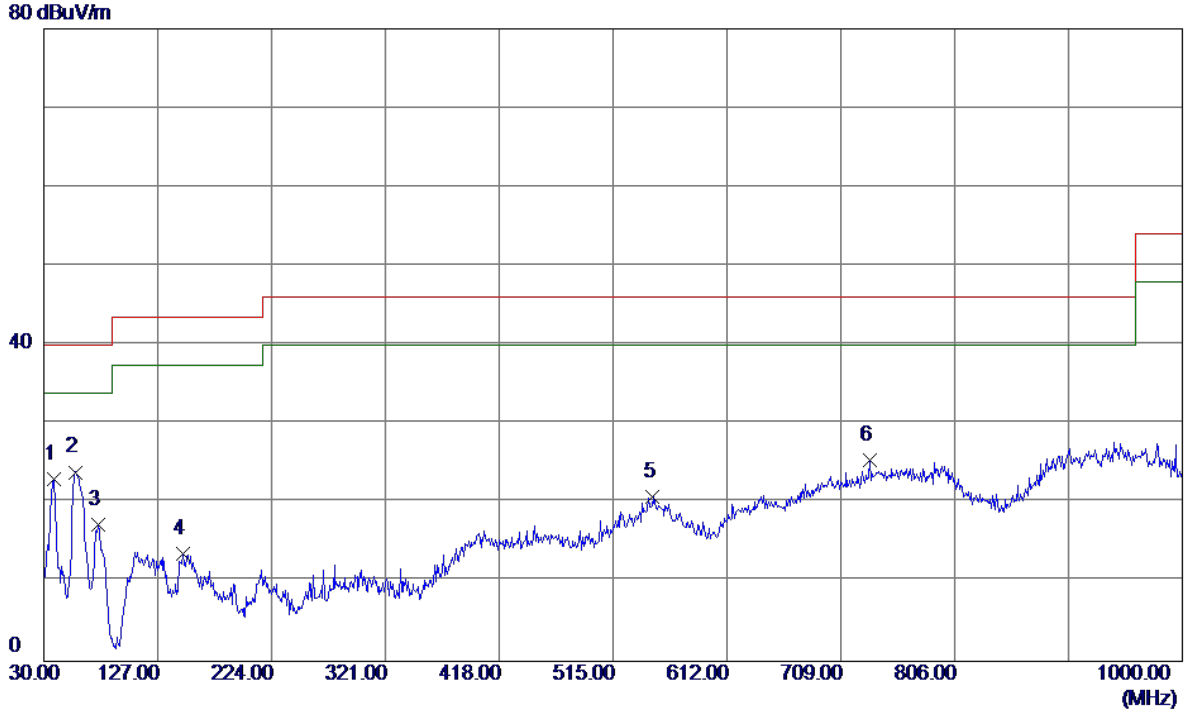

No.	Freq. MHz	Reading Level dBuV/m	Correct Factor dB	Measure ment dBuV/m	Limit dBuV/m	Margin dB	Detector	Comment
1	38.7300	43.66	-20.66	23.00	40.00	-17.00	Peak	
2 *	57.1600	44.95	-21.03	23.92	40.00	-16.08	Peak	
3	76.5600	43.16	-25.87	17.29	40.00	-22.71	Peak	
4	148.3400	36.82	-23.24	13.58	43.50	-29.92	Peak	
5	548.9500	29.71	-8.88	20.83	46.00	-25.17	Peak	
6	734.2199	31.05	-5.59	25.46	46.00	-20.54	Peak	

Test Mode: UNII-1/TX A Mode 5240MHz

Vertical

80 dBuV/m

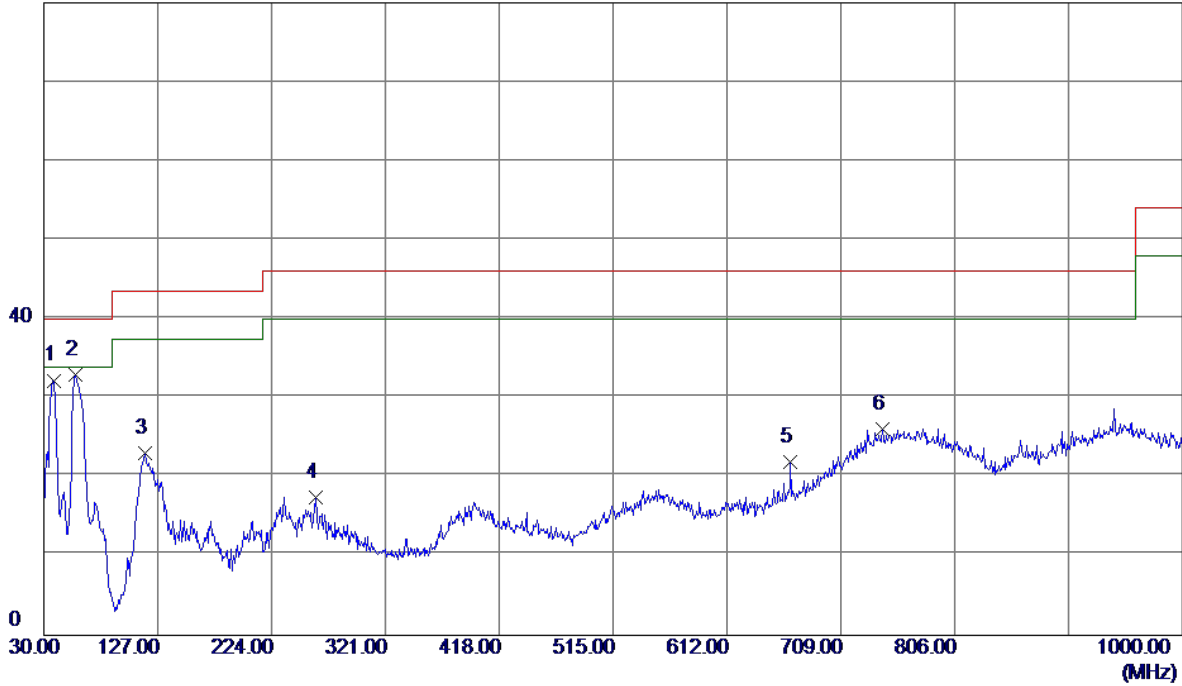

No.	Freq. MHz	Reading Level dBuV/m	Correct Factor dB	Measure ment dBuV/m	Limit dBuV/m	Margin dB	Detector	Comment
1	38.7300	53.04	-20.80	32.24	40.00	-7.76	Peak	
2 *	57.1600	53.96	-20.95	33.01	40.00	-6.99	Peak	
3	116.3300	44.64	-21.58	23.06	43.50	-20.44	Peak	
4	261.8299	33.18	-15.77	17.41	46.00	-28.59	Peak	
5	666.3200	33.38	-11.50	21.88	46.00	-24.12	Peak	
6	744.8900	30.29	-4.15	26.14	46.00	-19.86	Peak	

Test Mode: UNII-1/TX A Mode 5240MHz

Horizontal

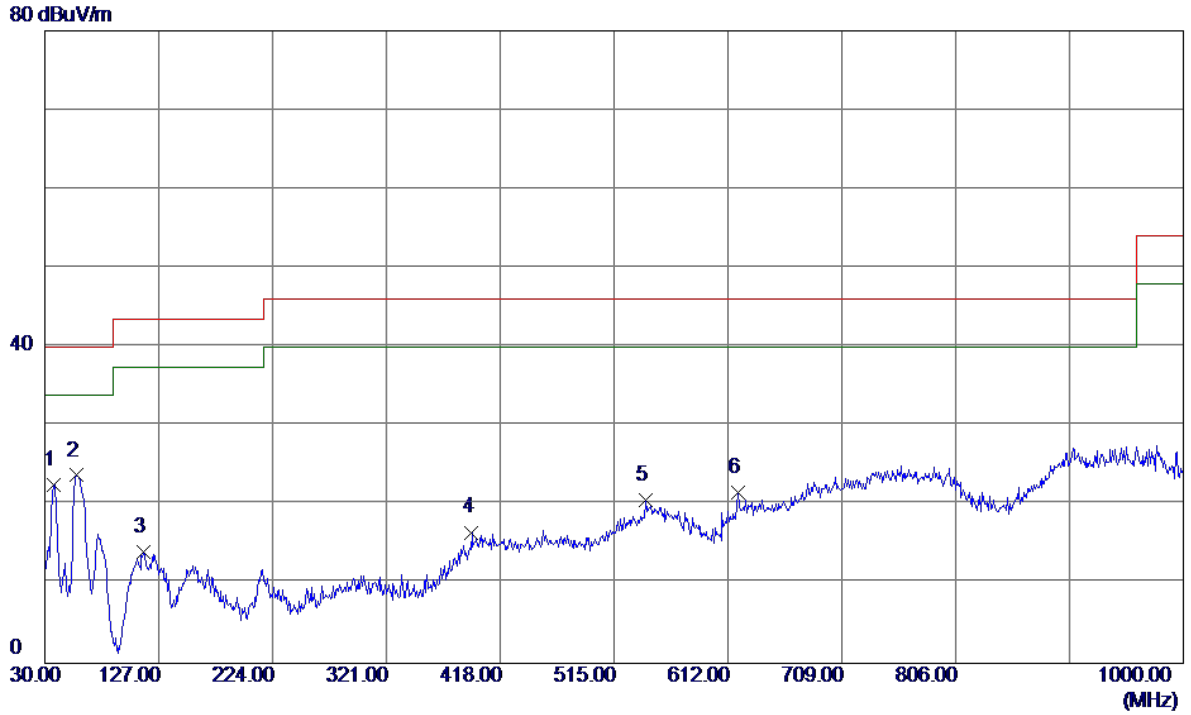

No.	Freq. MHz	Reading Level dBuV/m	Correct Factor dB	Measure ment dBuV/m	Limit dBuV/m	Margin dB	Detector	Comment
1	37.7599	43.31	-20.69	22.62	40.00	-17.38	Peak	
2 *	57.1600	44.79	-21.03	23.76	40.00	-16.24	Peak	
3	114.3900	38.13	-24.01	14.12	43.50	-29.38	Peak	
4	393.7500	30.16	-13.60	16.56	46.00	-29.44	Peak	
5	542.1599	30.15	-9.53	20.62	46.00	-25.38	Peak	
6	620.7300	31.72	-10.10	21.62	46.00	-24.38	Peak	

Test Mode: UNII-3/TX A Mode 5745MHz

Vertical

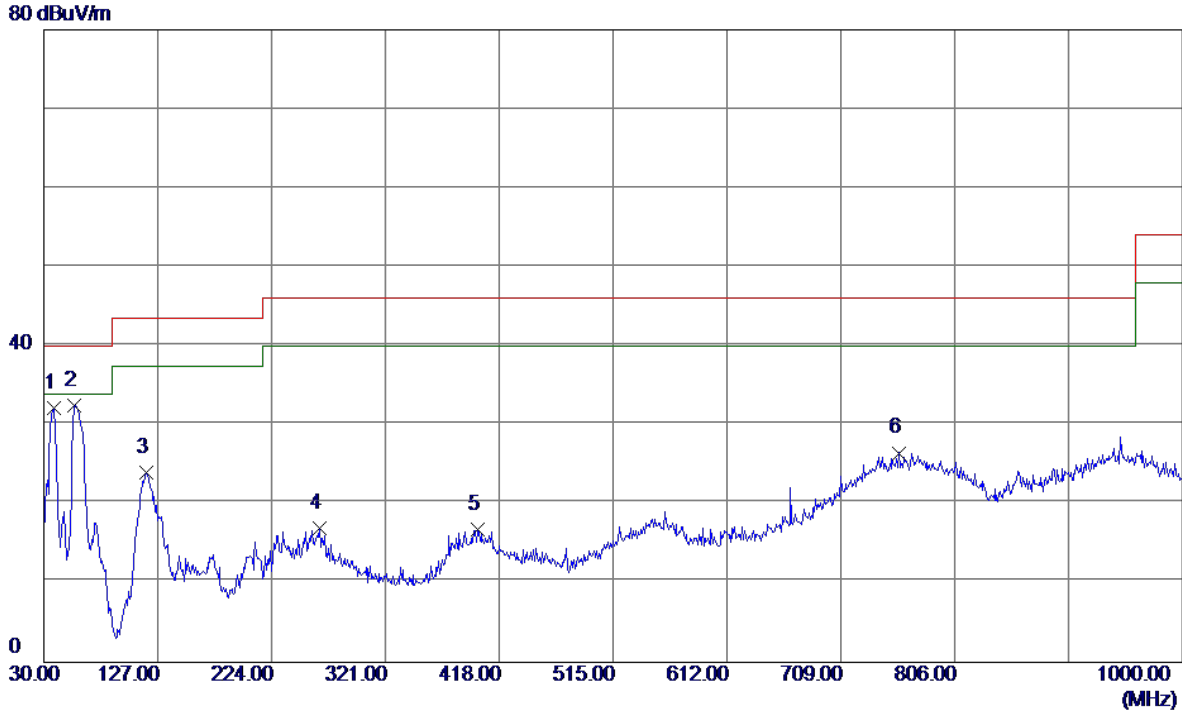

No.	Freq. MHz	Reading Level dBuV/m	Correct Factor dB	Measure ment dBuV/m	Limit dBuV/m	Margin dB	Detector	Comment
1	38.7300	52.98	-20.80	32.18	40.00	-7.82	Peak	
2 *	56.1900	53.01	-20.55	32.46	40.00	-7.54	Peak	
3	117.3000	45.15	-21.19	23.96	43.50	-19.54	Peak	
4	264.7400	32.74	-15.83	16.91	46.00	-29.09	Peak	
5	399.5700	29.16	-12.31	16.85	46.00	-29.15	Peak	
6	758.4699	30.47	-3.99	26.48	46.00	-19.52	Peak	

Test Mode: UNII-3/TX A Mode 5745MHz

Horizontal

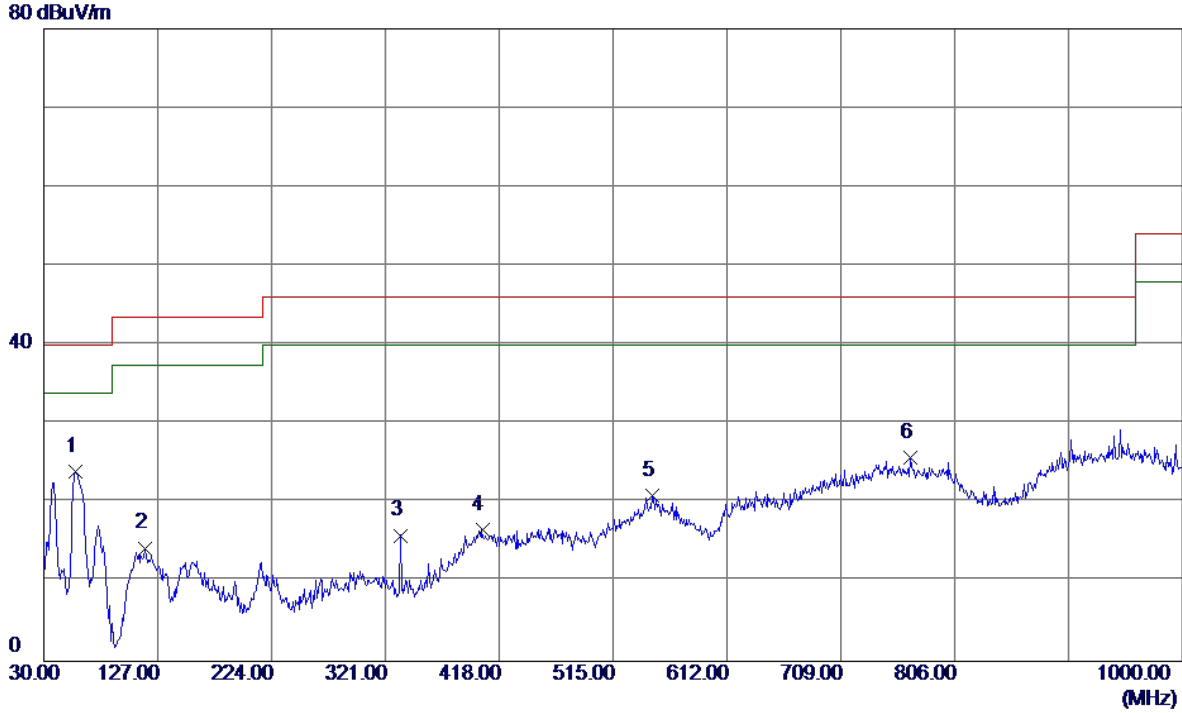

No.	Freq. MHz	Reading Level dBuV/m	Correct Factor dB	Measure ment dBuV/m	Limit dBuV/m	Margin dB	Detector	Comment
1 *	57.1600	45.06	-21.03	24.03	40.00	-15.97	Peak	
2	116.3300	38.19	-23.87	14.32	43.50	-29.18	Peak	
3	333.6099	34.90	-18.98	15.92	46.00	-30.08	Peak	
4	403.4500	29.48	-12.81	16.67	46.00	-29.33	Peak	
5	547.9800	29.87	-8.97	20.90	46.00	-25.10	Peak	
6	768.1700	31.02	-5.32	25.70	46.00	-20.30	Peak	

Test Mode: UNII-3/TX A Mode 5785MHz

Vertical

80 dBuV/m

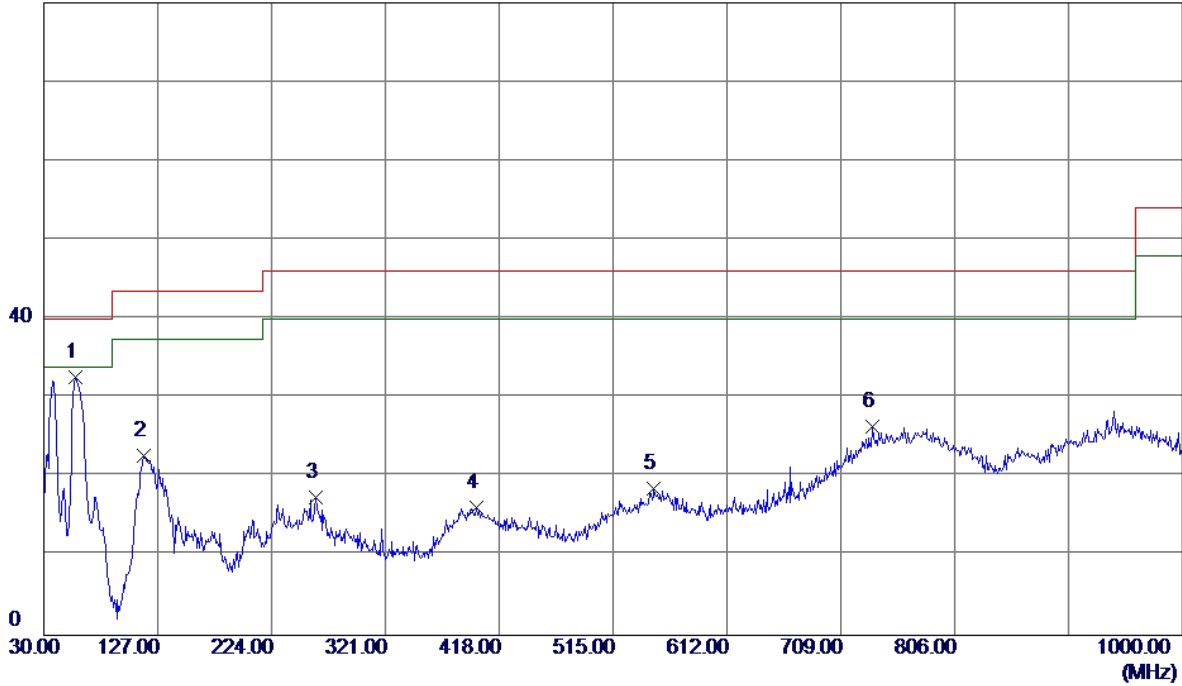

No.	Freq. MHz	Reading Level dBuV/m	Correct Factor dB	Measure ment dBuV/m	Limit dBuV/m	Margin dB	Detector	Comment
1 *	57.1600	53.64	-20.95	32.69	40.00	-7.31	Peak	
2	115.3600	44.66	-21.96	22.70	43.50	-20.80	Peak	
3	261.8299	33.25	-15.77	17.48	46.00	-28.52	Peak	
4	398.6000	28.53	-12.36	16.17	46.00	-29.83	Peak	
5	549.9200	29.07	-10.58	18.49	46.00	-27.51	Peak	
6	736.1599	30.97	-4.52	26.45	46.00	-19.55	Peak	

Test Mode: UNII-3/TX A Mode 5785MHz

Horizontal

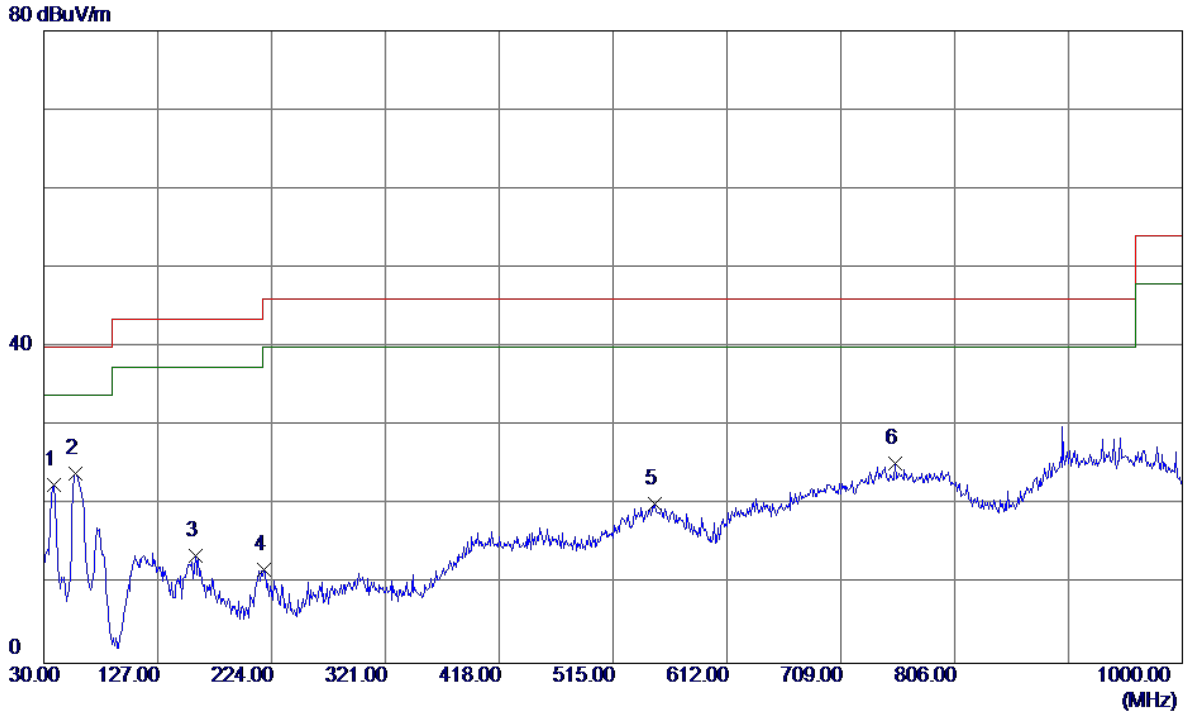

No.	Freq. MHz	Reading Level dBuV/m	Correct Factor dB	Measure ment dBuV/m	Limit dBuV/m	Margin dB	Detector	Comment
1	38.7300	43.17	-20.66	22.51	40.00	-17.49	Peak	
2 *	57.1600	44.96	-21.03	23.93	40.00	-16.07	Peak	
3	159.0100	34.74	-21.19	13.55	43.50	-29.95	Peak	
4	217.2100	33.46	-21.65	11.81	46.00	-34.19	Peak	
5	550.8900	29.06	-8.83	20.23	46.00	-25.77	Peak	
6	755.5600	30.54	-5.28	25.26	46.00	-20.74	Peak	

Test Mode: UNII-3/TX A Mode 5825MHz

Vertical

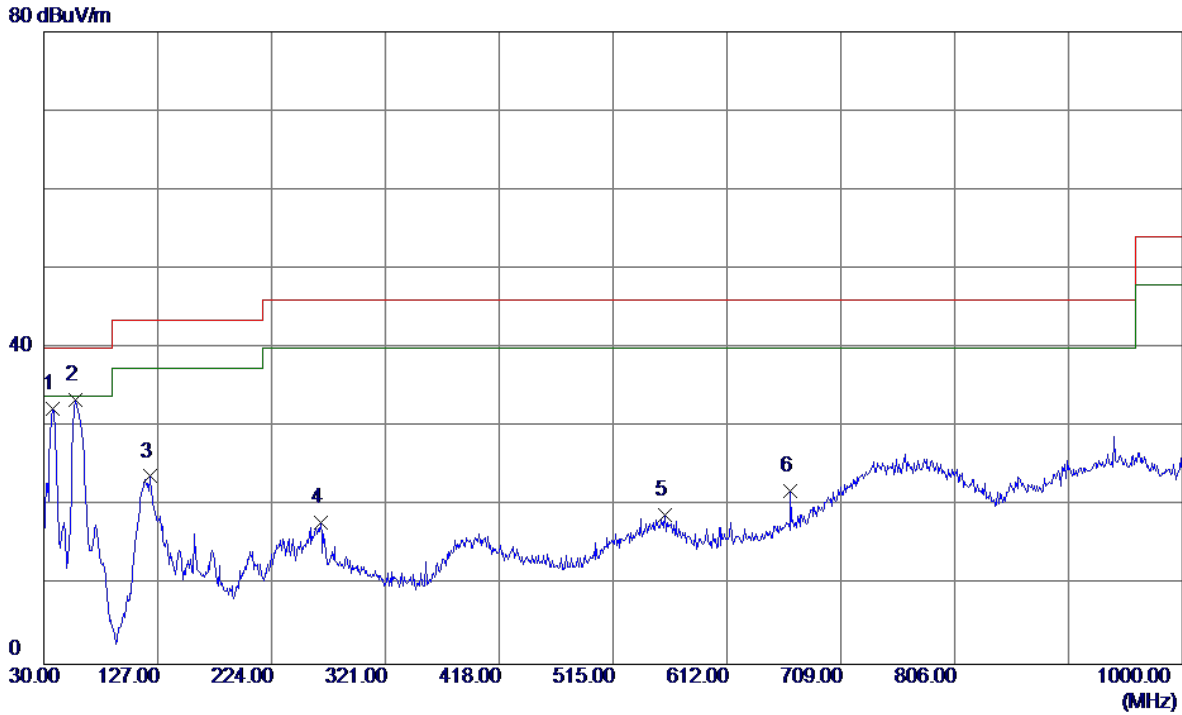

No.	Freq. MHz	Reading Level dBuV/m	Correct Factor dB	Measure ment dBuV/m	Limit dBuV/m	Margin dB	Detector	Comment
1	37.7599	53.28	-20.92	32.36	40.00	-7.64	Peak	
2 *	57.1600	54.34	-20.95	33.39	40.00	-6.61	Peak	
3	120.2100	43.86	-20.10	23.76	43.50	-19.74	Peak	
4	265.7100	33.80	-15.85	17.95	46.00	-28.05	Peak	
5	559.6200	29.87	-11.02	18.85	46.00	-27.15	Peak	
6	666.3200	33.35	-11.50	21.85	46.00	-24.15	Peak	

Test Mode: UNII-3/TX A Mode 5825MHz

Horizontal

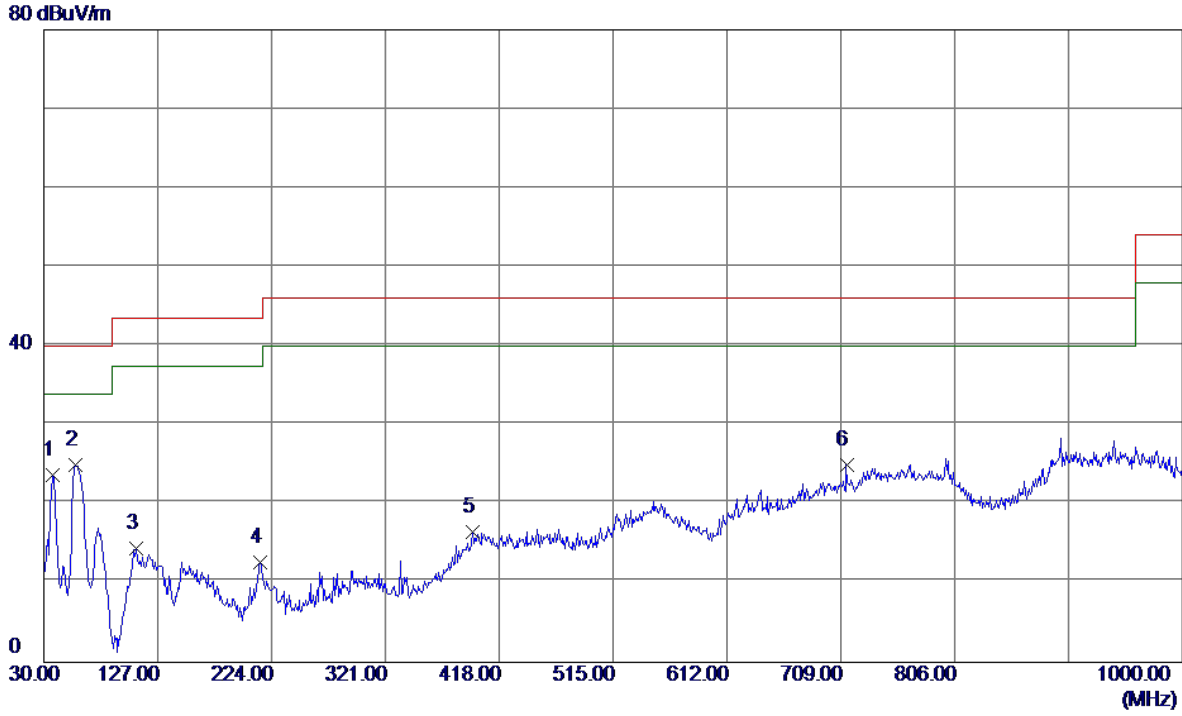

No.	Freq. MHz	Reading Level dBuV/m	Correct Factor dB	Measure ment dBuV/m	Limit dBuV/m	Margin dB	Detector	Comment
1	37.7599	44.39	-20.69	23.70	40.00	-16.30	Peak	
2 *	57.1600	46.02	-21.03	24.99	40.00	-15.01	Peak	
3	108.5700	38.72	-24.37	14.35	43.50	-29.15	Peak	
4	214.3000	34.59	-21.88	12.71	43.50	-30.79	Peak	
5	395.6900	29.86	-13.33	16.53	46.00	-29.47	Peak	
6	713.8500	31.63	-6.62	25.01	46.00	-20.99	Peak	

ATTACHMENT D -RADIATED EMISSION (ABOVE 1000MHZ)

Orthogonal Axis:	X
Test Mode:	UNII-1/ TX A Mode 5180MHz

Vertical

115 dBuV/m

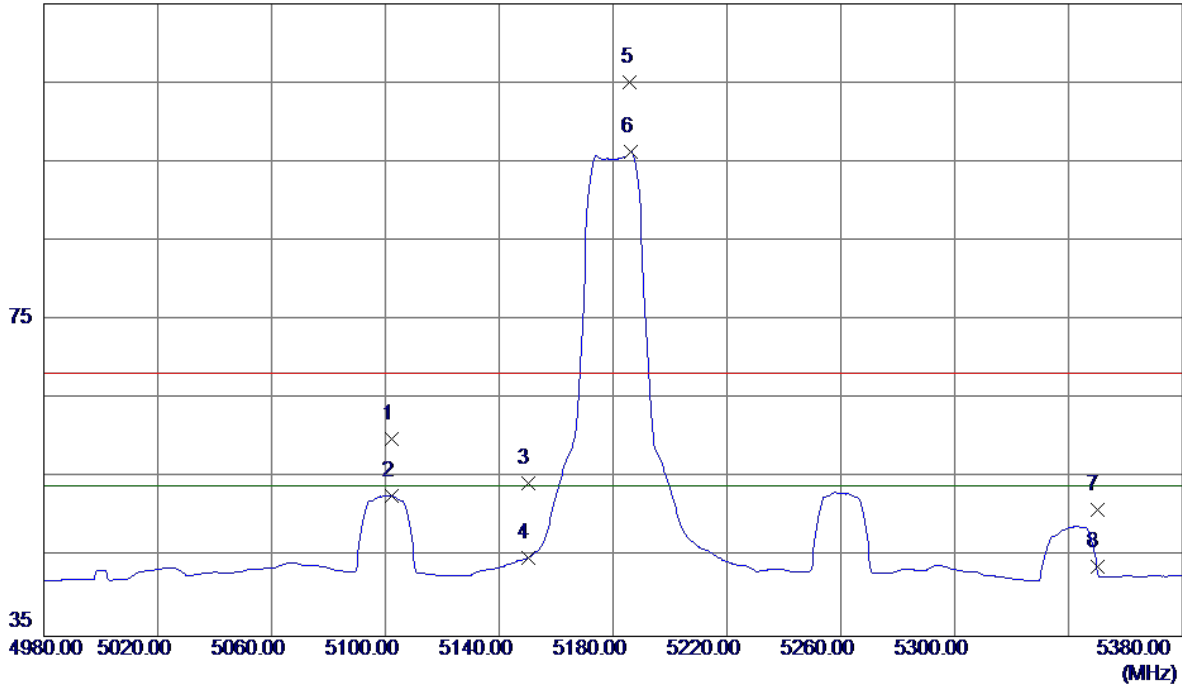

No.	Freq. MHz	Reading Level dBuV/m	Correct Factor dB	Measure ment dBuV/m	Limit dBuV/m	Margin dB	Detector	Comment
1	5102.4000	19.50	40.47	59.97	68.30	-8.33	Peak	
2	5102.4000	12.33	40.47	52.80	54.00	-1.20	AVG	
3	5150.0000	13.71	40.62	54.33	68.30	-13.97	Peak	
4	5150.0000	4.25	40.62	44.87	54.00	-9.13	AVG	
5	5186.0000	64.42	40.74	105.16	68.30	36.86	Peak	No Limit
6 *	5186.4000	55.58	40.75	96.33	54.00	42.33	AVG	No Limit
7	5350.0000	9.70	41.28	50.98	68.30	-17.32	Peak	
8	5350.0000	2.49	41.28	43.77	54.00	-10.23	AVG	

Orthogonal Axis:	X
Test Mode:	UNII-1/ TX A Mode 5180MHz

Vertical

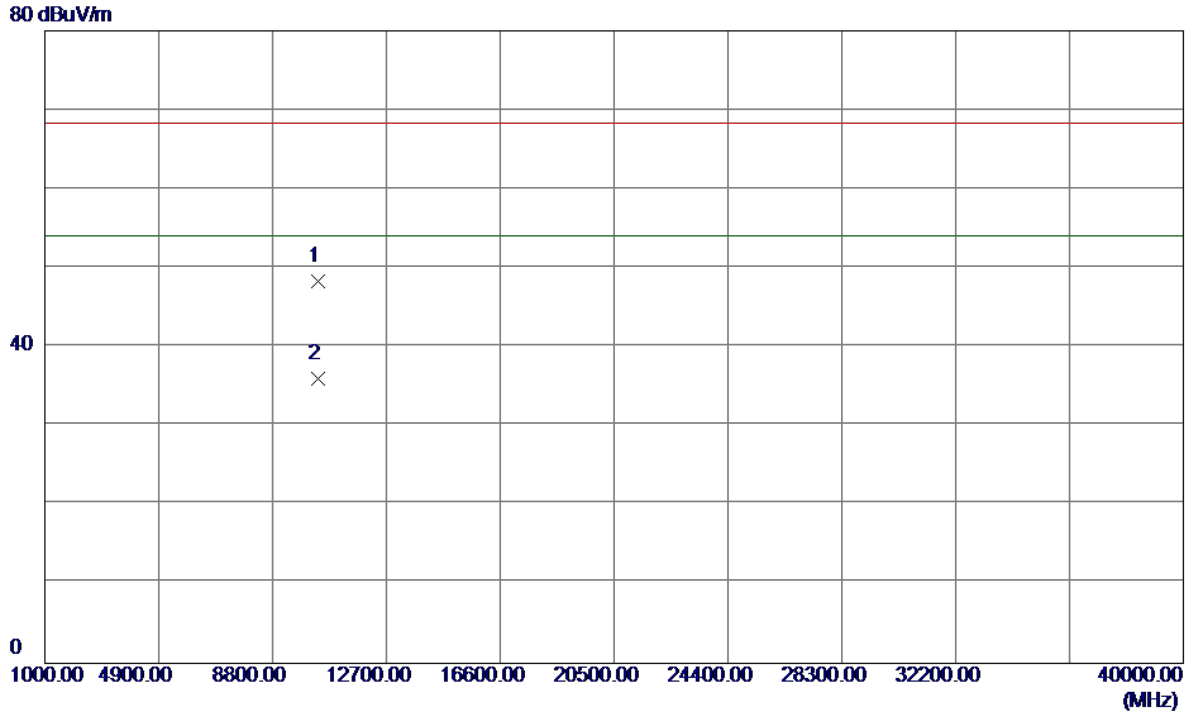

No.	Freq. MHz	Reading Level dBuV/m	Correct Factor dB	Measure ment dBuV/m	Limit dBuV/m	Margin dB	Detector	Comment
1	10356.0000	33.33	14.95	48.28	68.30	-20.02	Peak	
2 *	10361.9000	21.10	14.97	36.07	54.00	-17.93	AVG	

Orthogonal Axis:	X
Test Mode:	UNII-1/ TX A Mode 5180MHz

Horizontal

115 dBuV/m

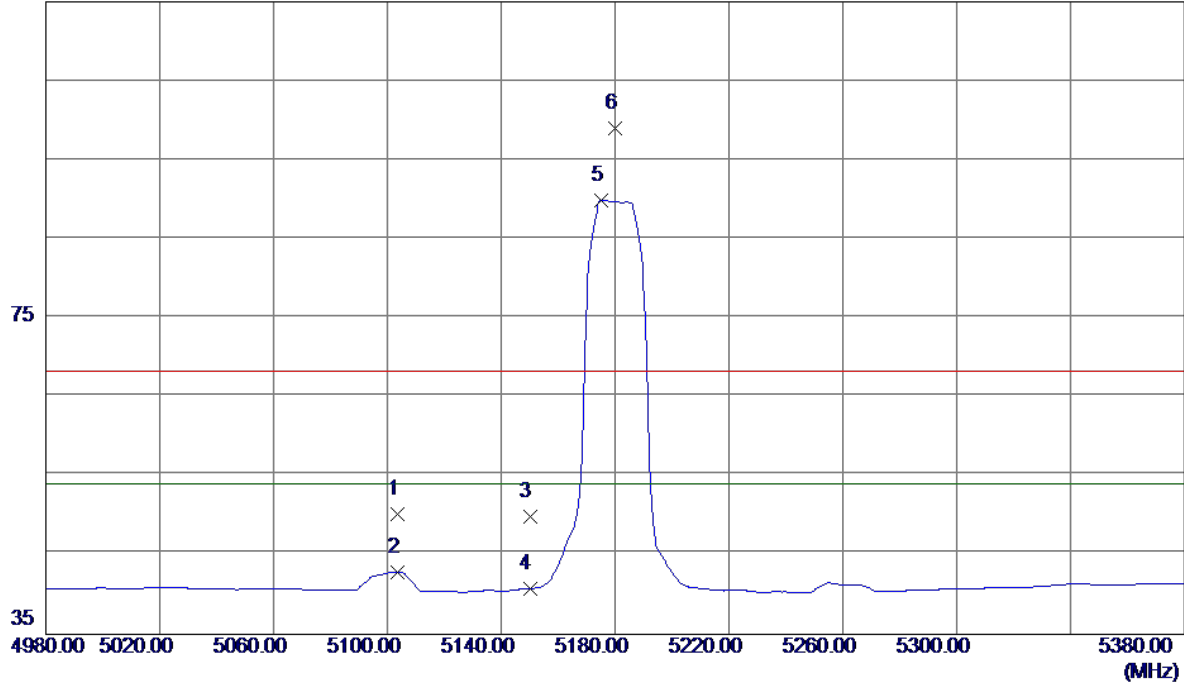

No.	Freq. MHz	Reading Level dBuV/m	Correct Factor dB	Measure ment dBuV/m	Limit dBuV/m	Margin dB	Detector	Comment
1	5103.6000	9.68	40.47	50.15	68.30	-18.15	Peak	
2	5103.6000	2.38	40.47	42.85	54.00	-11.15	AVG	
3	5150.0000	9.28	40.62	49.90	68.30	-18.40	Peak	
4	5150.0000	0.15	40.62	40.77	54.00	-13.23	AVG	
5 *	5175.2000	49.18	40.71	89.89	54.00	35.89	AVG	No Limit
6	5180.0000	58.22	40.72	98.94	68.30	30.64	Peak	No Limit

Orthogonal Axis:	X
Test Mode:	UNII-1/ TX A Mode 5180MHz

Horizontal

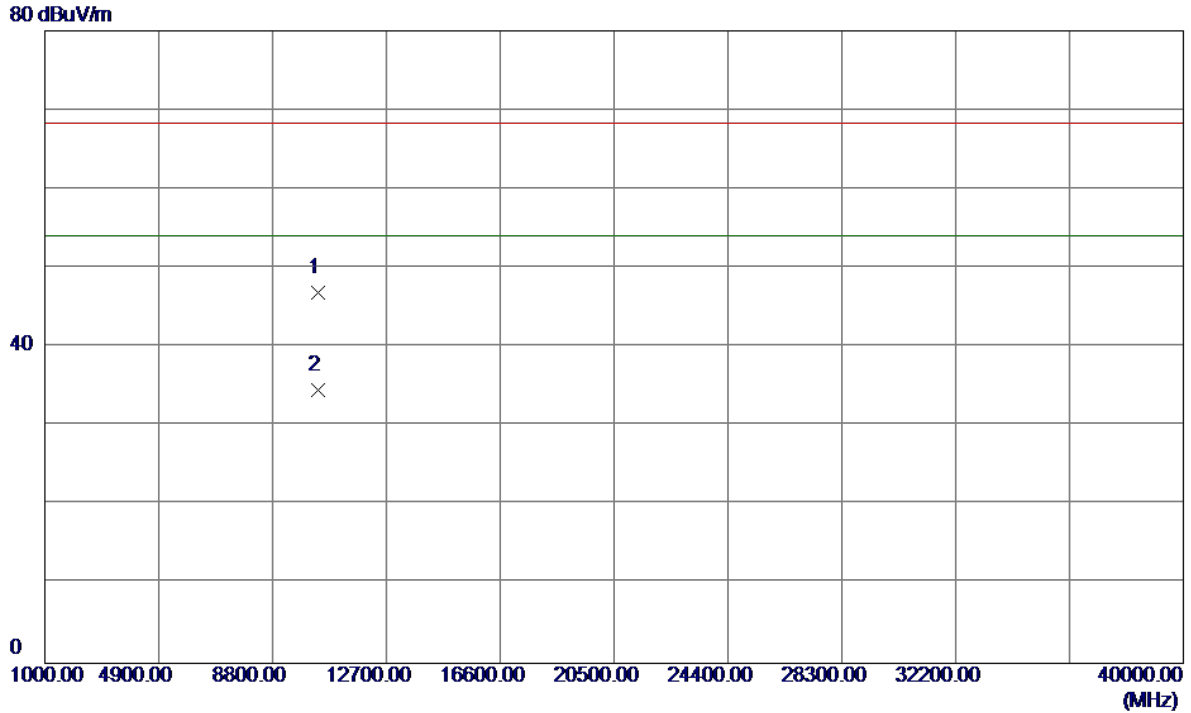

No.	Freq. MHz	Reading Level dBuV/m	Correct Factor dB	Measure ment dBuV/m	Limit dBuV/m	Margin dB	Detector	Comment
1	10359.6000	31.92	14.96	46.88	68.30	-21.42	Peak	
2 *	10362.1000	19.60	14.97	34.57	54.00	-19.43	AVG	

Orthogonal Axis:	X
Test Mode:	UNII-1/ TX A Mode 5200MHz

Vertical

115 dBuV/m

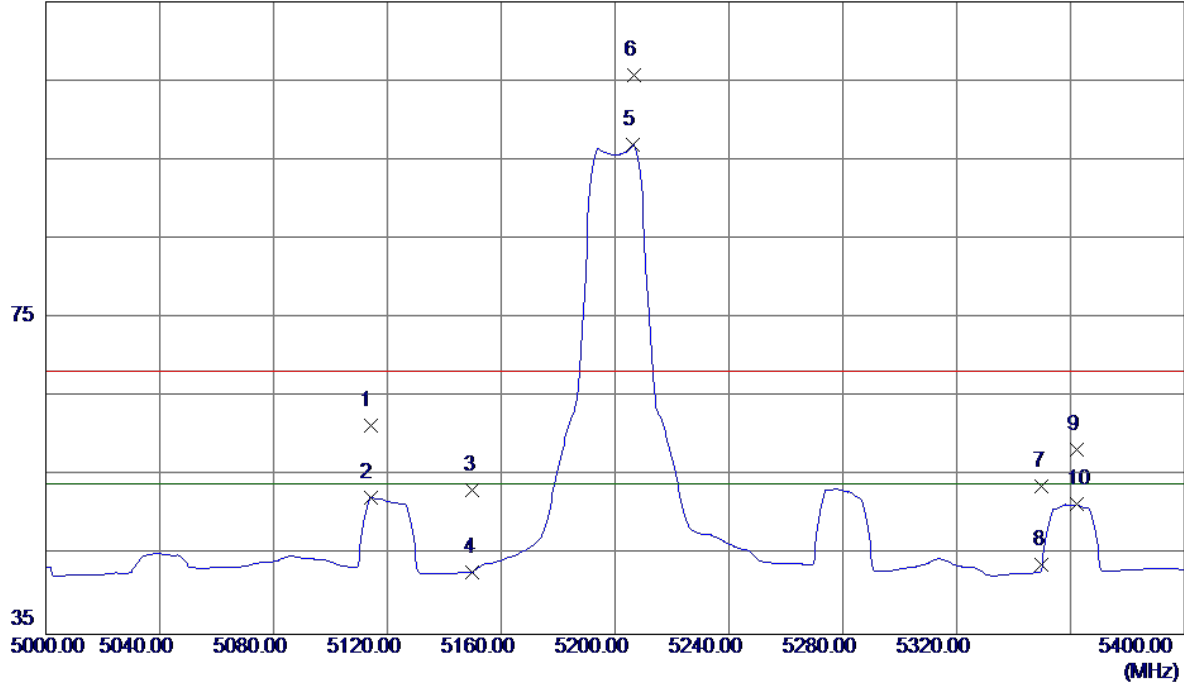

No.	Freq. MHz	Reading Level dBuV/m	Correct Factor dB	Measure ment dBuV/m	Limit dBuV/m	Margin dB	Detector	Comment
1	5114.0000	20.96	40.51	61.47	68.30	-6.83	Peak	
2	5114.0000	11.75	40.51	52.26	54.00	-1.74	AVG	
3	5150.0000	12.58	40.62	53.20	68.30	-15.10	Peak	
4	5150.0000	2.28	40.62	42.90	54.00	-11.10	AVG	
5 *	5206.4000	56.10	40.81	96.91	54.00	42.91	AVG	No Limit
6	5206.8000	64.90	40.81	105.71	68.30	37.41	Peak	No Limit
7	5350.0000	12.38	41.28	53.66	68.30	-14.64	Peak	
8	5350.0000	2.50	41.28	43.78	54.00	-10.22	AVG	
9	5362.4000	16.98	41.33	58.31	68.30	-9.99	Peak	
10	5362.4000	10.08	41.33	51.41	54.00	-2.59	AVG	

Orthogonal Axis:	X
Test Mode:	UNII-1/ TX A Mode 5200MHz

Vertical

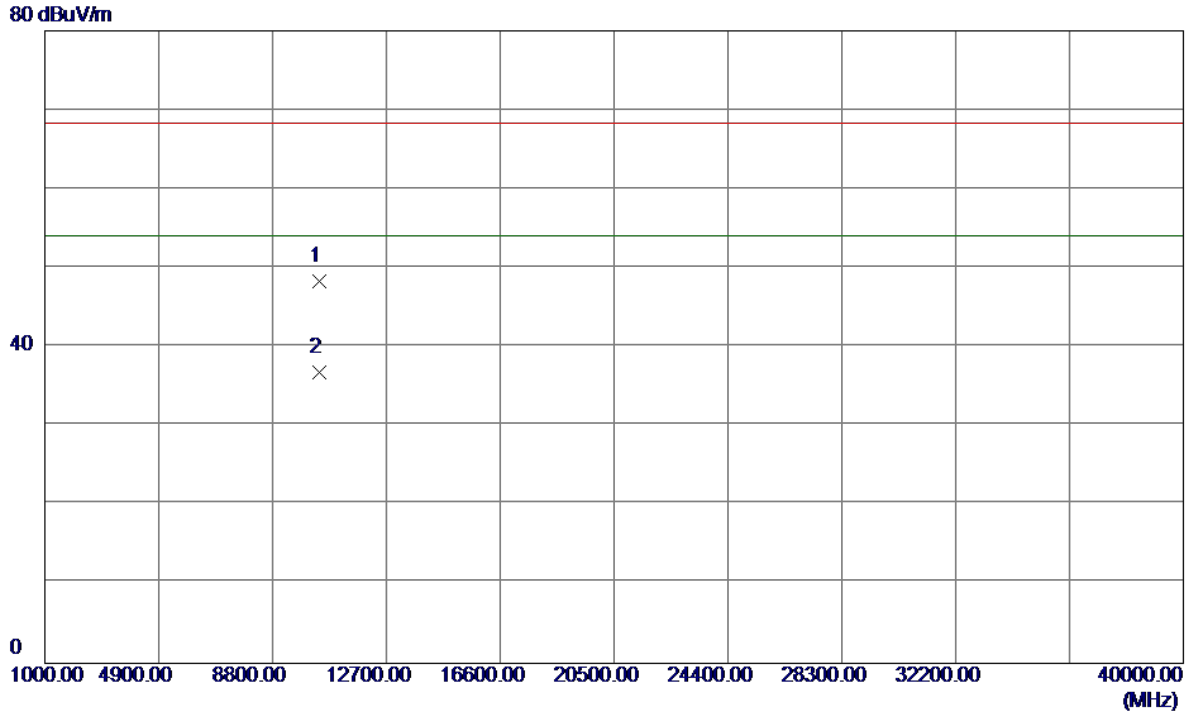

No.	Freq. MHz	Reading Level dBuV/m	Correct Factor dB	Measure ment dBuV/m	Limit dBuV/m	Margin dB	Detector	Comment
1	10395.1000	33.28	15.04	48.32	68.30	-19.98	Peak	
2 *	10402.1000	21.71	15.06	36.77	54.00	-17.23	AVG	

Orthogonal Axis:	X
Test Mode:	UNII-1/ TX A Mode 5200MHz

Horizontal

115 dBuV/m

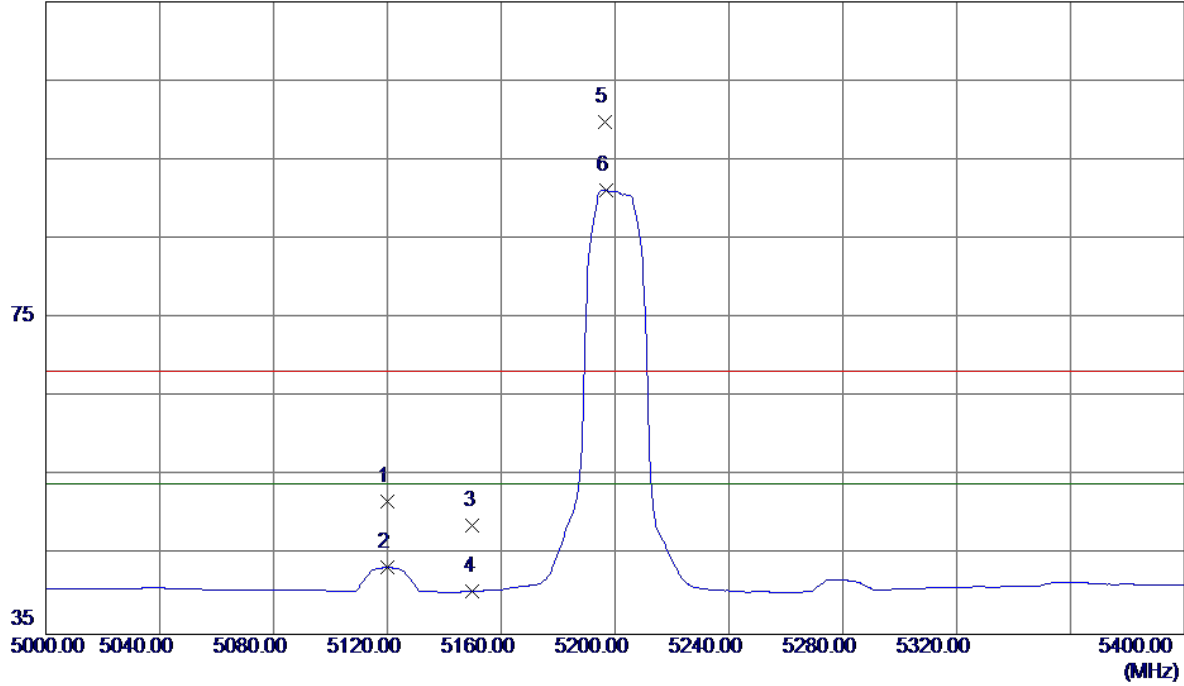

No.	Freq. MHz	Reading Level dBuV/m	Correct Factor dB	Measure ment dBuV/m	Limit dBuV/m	Margin dB	Detector	Comment
1	5120.0000	11.28	40.53	51.81	68.30	-16.49	Peak	
2	5120.0000	2.98	40.53	43.51	54.00	-10.49	AVG	
3	5150.0000	8.16	40.62	48.78	68.30	-19.52	Peak	
4	5150.0000	-0.22	40.62	40.40	54.00	-13.60	AVG	
5	5196.4000	58.98	40.78	99.76	68.30	31.46	Peak	No Limit
6 *	5196.8000	50.39	40.78	91.17	54.00	37.17	AVG	No Limit

Orthogonal Axis:	X
Test Mode:	UNII-1/ TX A Mode 5200MHz

Horizontal

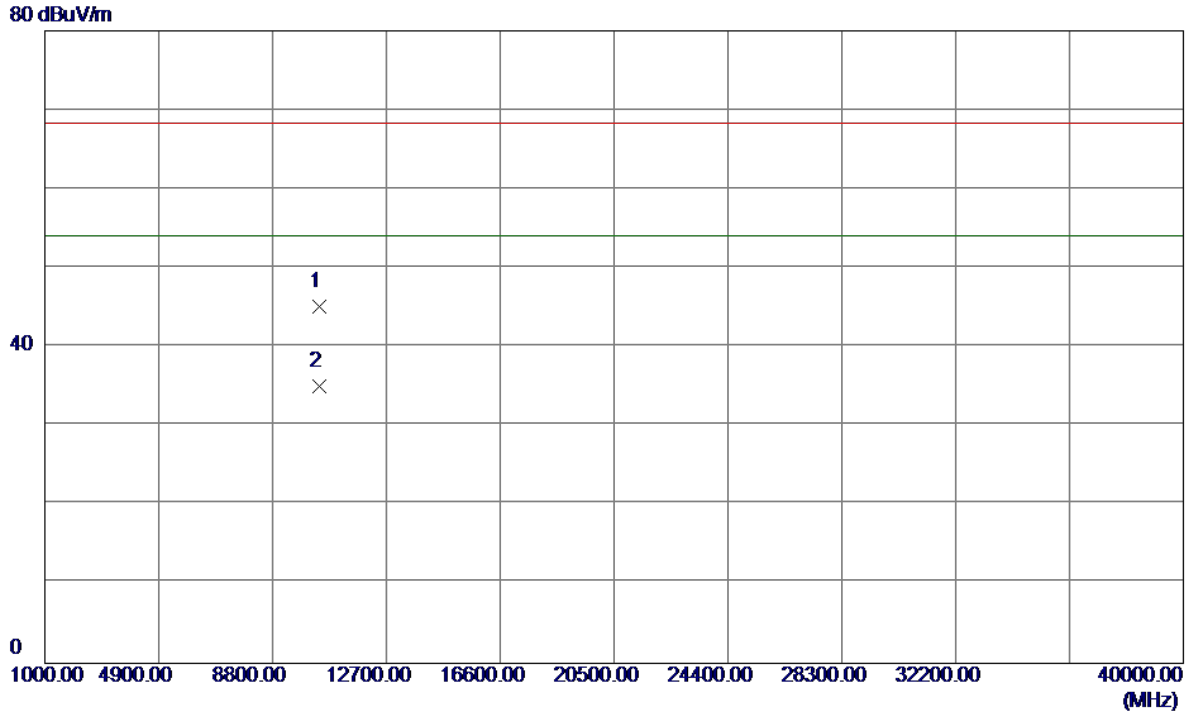

No.	Freq. MHz	Reading Level dBuV/m	Correct Factor dB	Measure ment dBuV/m	Limit dBuV/m	Margin dB	Detector	Comment
1	10397.0000	30.02	15.05	45.07	68.30	-23.23	Peak	
2 *	10399.7000	19.91	15.06	34.97	54.00	-19.03	AVG	

Orthogonal Axis:	X
Test Mode:	UNII-1/ TX A Mode 5240MHz

Vertical

115 dBuV/m

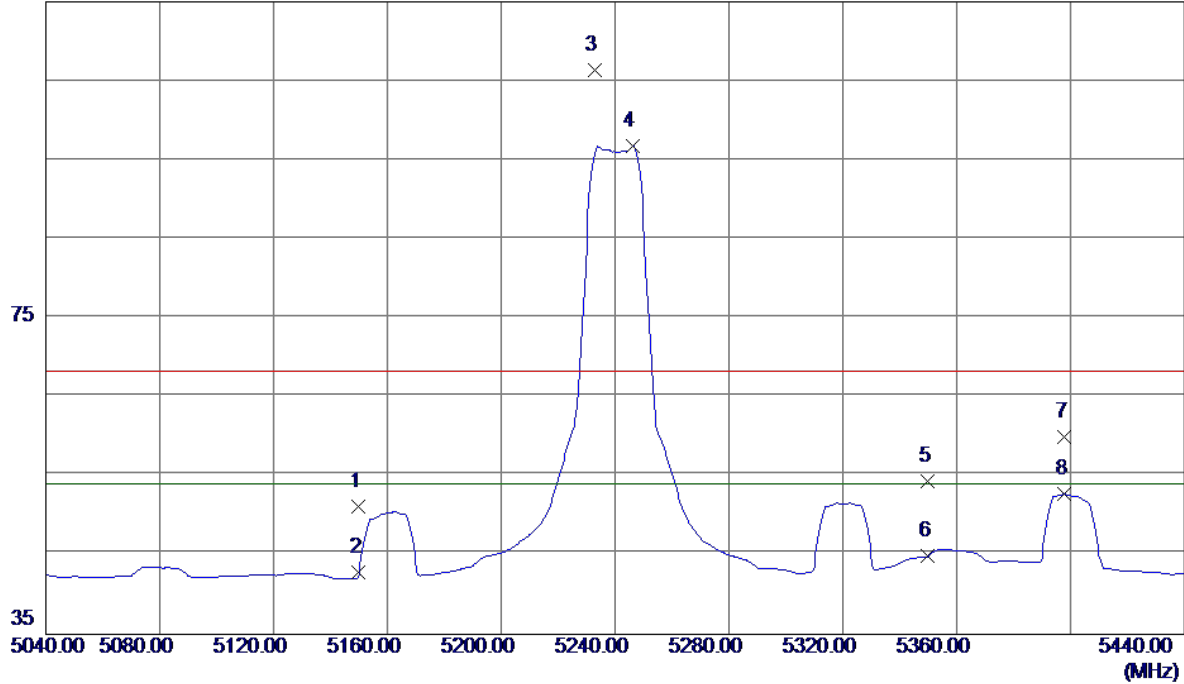

No.	Freq. MHz	Reading Level dBuV/m	Correct Factor dB	Measure ment dBuV/m	Limit dBuV/m	Margin dB	Detector	Comment
1	5150.0000	10.60	40.62	51.22	68.30	-17.08	Peak	
2	5150.0000	2.18	40.62	42.80	54.00	-11.20	AVG	
3	5232.8000	65.50	40.90	106.40	68.30	38.10	Peak	No Limit
4 *	5246.4000	55.86	40.94	96.80	54.00	42.80	AVG	No Limit
5	5350.0000	13.02	41.28	54.30	68.30	-14.00	Peak	
6	5350.0000	3.61	41.28	44.89	54.00	-9.11	AVG	
7	5398.0000	18.53	41.44	59.97	68.30	-8.33	Peak	
8	5398.0000	11.33	41.44	52.77	54.00	-1.23	AVG	

Orthogonal Axis:	X
Test Mode:	UNII-1/ TX A Mode 5240MHz

Vertical

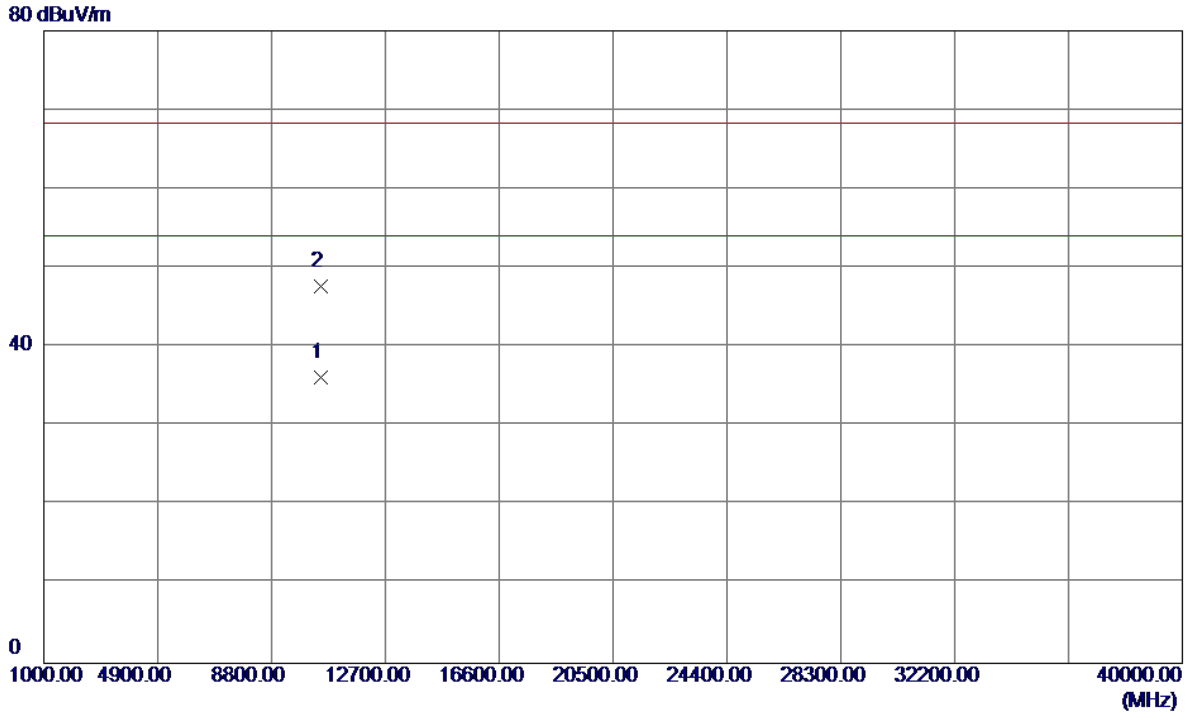

No.	Freq. MHz	Reading Level dBuV/m	Correct Factor dB	Measure ment dBuV/m	Limit dBuV/m	Margin dB	Detector	Comment
1 *	10482.1000	20.98	15.25	36.23	54.00	-17.77	AVG	
2	10484.1000	32.36	15.25	47.61	68.30	-20.69	Peak	

Orthogonal Axis:	X
Test Mode:	UNII-1/ TX A Mode 5240MHz

Horizontal

115 dBuV/m

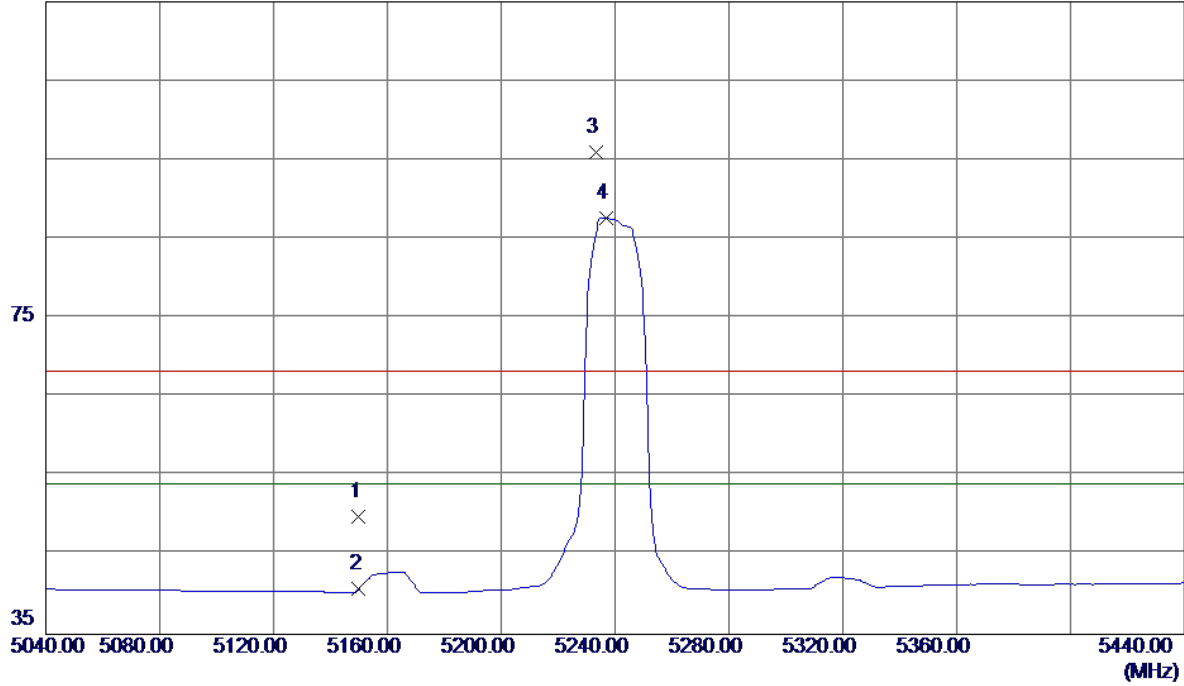

No.	Freq. MHz	Reading Level dBuV/m	Correct Factor dB	Measure ment dBuV/m	Limit dBuV/m	Margin dB	Detector	Comment
1	5150.0000	9.27	40.62	49.89	68.30	-18.41	Peak	
2	5150.0000	0.11	40.62	40.73	54.00	-13.27	AVG	
3	5233.2000	55.05	40.90	95.95	68.30	27.65	Peak	No Limit
4 *	5236.8000	46.79	40.91	87.70	54.00	33.70	AVG	No Limit

Orthogonal Axis:	X
Test Mode:	UNII-1/ TX A Mode 5240MHz

Horizontal

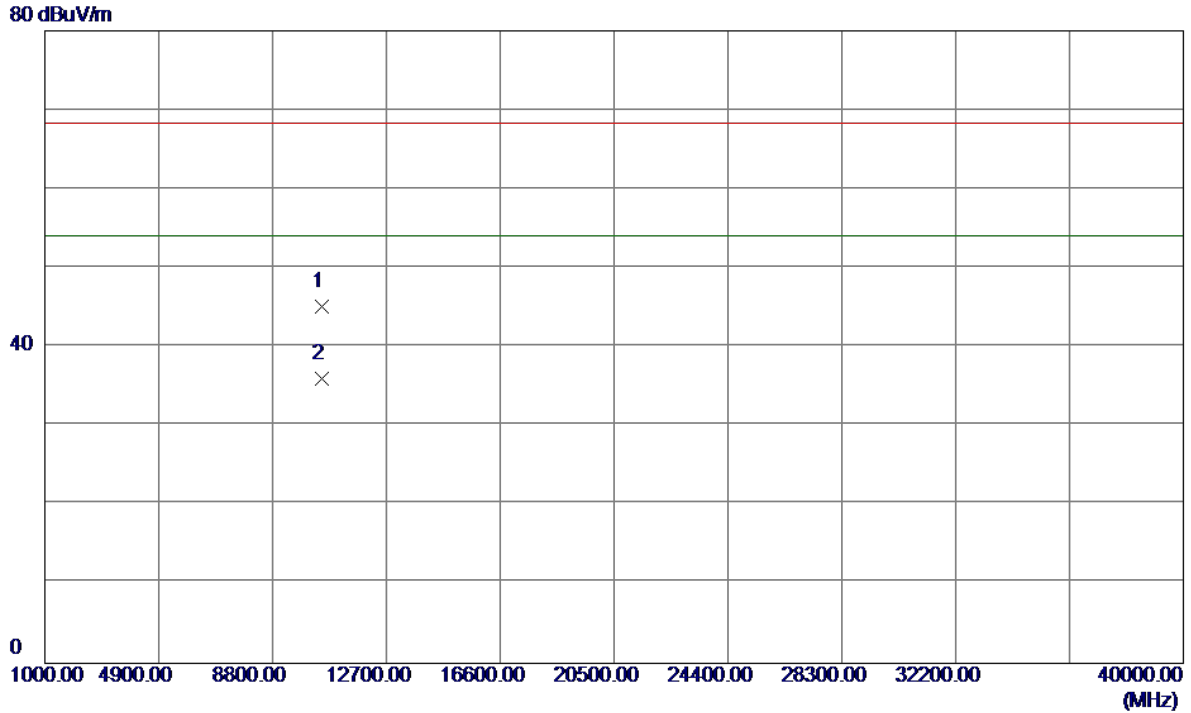

No.	Freq. MHz	Reading Level dBuV/m	Correct Factor dB	Measure ment dBuV/m	Limit dBuV/m	Margin dB	Detector	Comment
1	10480.9000	29.89	15.25	45.14	68.30	-23.16	Peak	
2 *	10483.0000	20.74	15.25	35.99	54.00	-18.01	AVG	

Orthogonal Axis:	X
Test Mode:	UNII-1/ TX N20 Mode 5180MHz

Vertical

115 dBuV/m

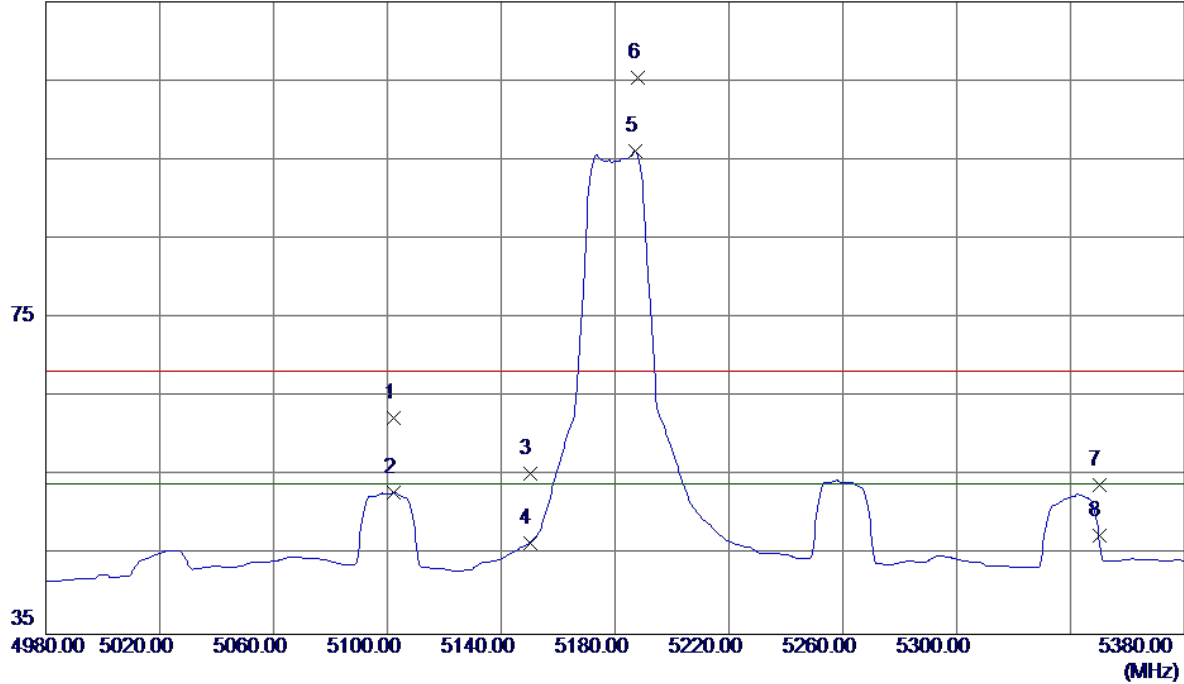

No.	Freq. MHz	Reading Level dBuV/m	Correct Factor dB	Measure ment dBuV/m	Limit dBuV/m	Margin dB	Detector	Comment
1	5102.4000	21.83	40.47	62.30	68.30	-6.00	Peak	
2	5102.4000	12.48	40.47	52.95	54.00	-1.05	AVG	
3	5150.0000	14.71	40.62	55.33	68.30	-12.97	Peak	
4	5150.0000	5.96	40.62	46.58	54.00	-7.42	AVG	
5 *	5187.2000	55.36	40.75	96.11	54.00	42.11	AVG	No Limit
6	5188.0000	64.58	40.75	105.33	68.30	37.03	Peak	No Limit
7	5350.0000	12.63	41.28	53.91	68.30	-14.39	Peak	
8	5350.0000	6.19	41.28	47.47	54.00	-6.53	AVG	

Orthogonal Axis:	X
Test Mode:	UNII-1/ TX N20 Mode 5180MHz

Vertical

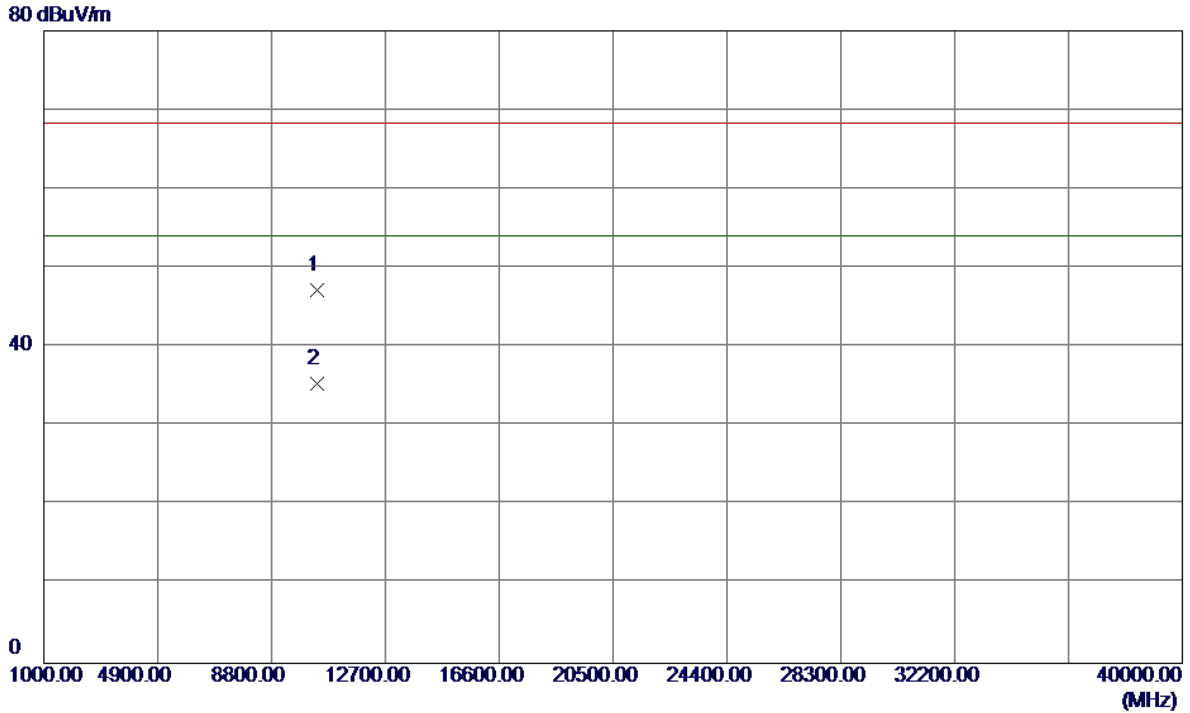

No.	Freq. MHz	Reading Level dBuV/m	Correct Factor dB	Measure ment dBuV/m	Limit dBuV/m	Margin dB	Detector	Comment
1	10359.4000	32.25	14.96	47.21	68.30	-21.09	Peak	
2 *	10360.4000	20.39	14.96	35.35	54.00	-18.65	AVG	

Orthogonal Axis:	X
Test Mode:	UNII-1/ TX N20 Mode 5180MHz

Horizontal

115 dBuV/m

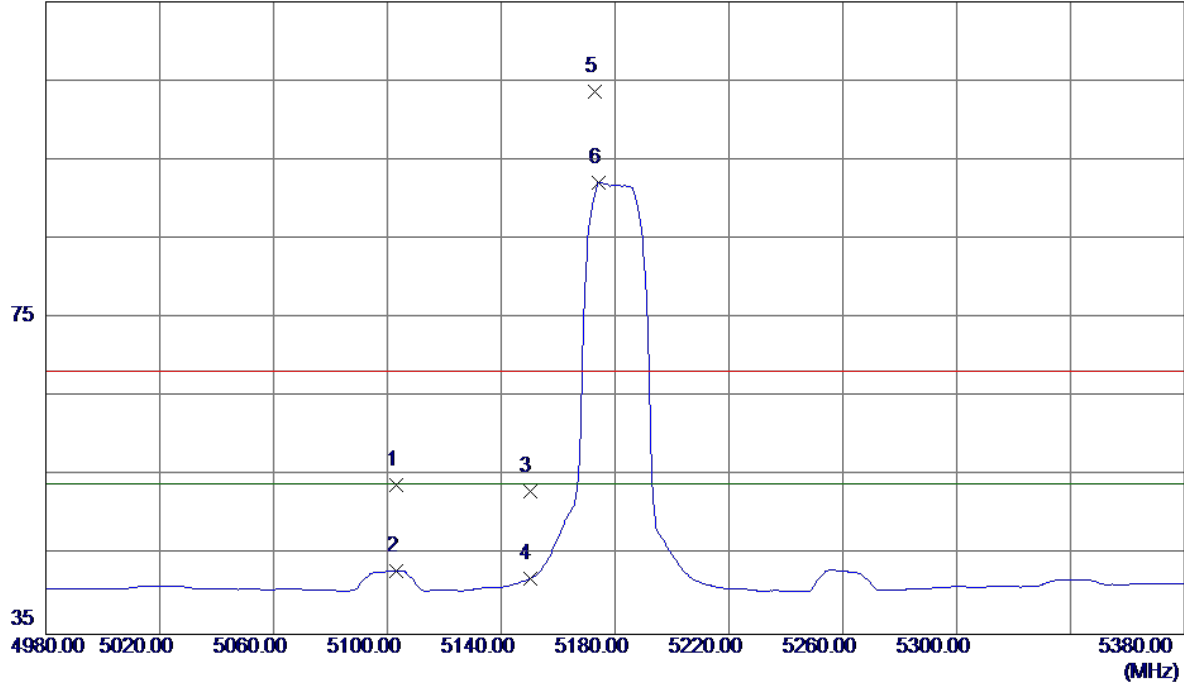

No.	Freq. MHz	Reading Level dBuV/m	Correct Factor dB	Measure ment dBuV/m	Limit dBuV/m	Margin dB	Detector	Comment
1	5103.2000	13.43	40.47	53.90	68.30	-14.40	Peak	
2	5103.2000	2.57	40.47	43.04	54.00	-10.96	AVG	
3	5150.0000	12.53	40.62	53.15	68.30	-15.15	Peak	
4	5150.0000	1.40	40.62	42.02	54.00	-11.98	AVG	
5	5172.8000	63.01	40.70	103.71	68.30	35.41	Peak	No Limit
6 *	5174.4000	51.45	40.71	92.16	54.00	38.16	AVG	No Limit

Orthogonal Axis:	X
Test Mode:	UNII-1/ TX N20 Mode 5180MHz

Horizontal

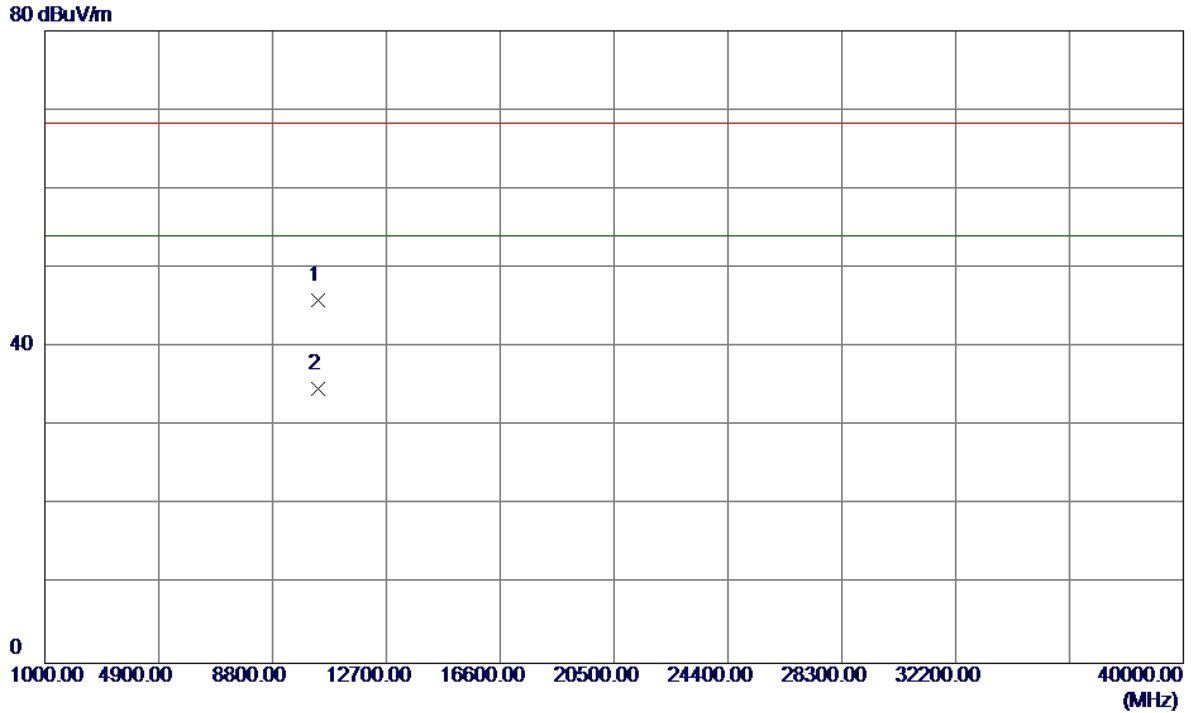

No.	Freq. MHz	Reading Level dBuV/m	Correct Factor dB	Measure ment dBuV/m	Limit dBuV/m	Margin dB	Detector	Comment
1	10360.5000	30.88	14.96	45.84	68.30	-22.46	Peak	
2 *	10360.7000	19.83	14.96	34.79	54.00	-19.21	AVG	

Orthogonal Axis:	X
Test Mode:	UNII-1/ TX N20 Mode 5200MHz

Vertical

115 dBuV/m

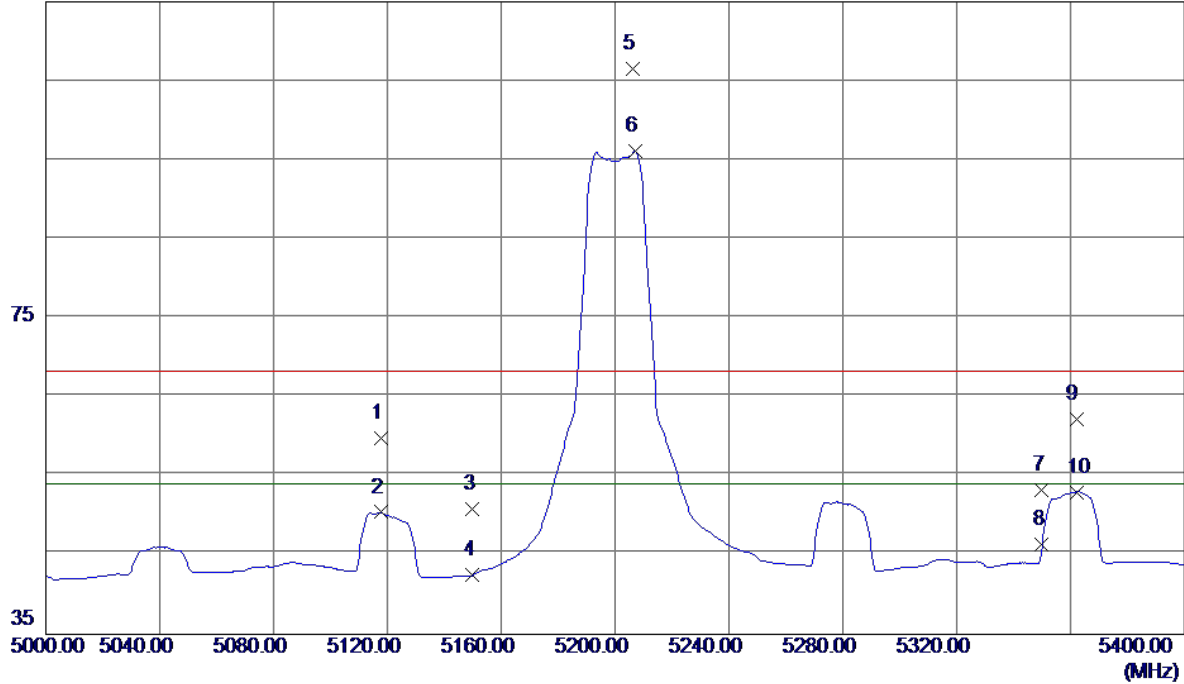

No.	Freq. MHz	Reading Level dBuV/m	Correct Factor dB	Measure ment dBuV/m	Limit dBuV/m	Margin dB	Detector	Comment
1	5117.6000	19.32	40.52	59.84	68.30	-8.46	Peak	
2	5117.6000	9.92	40.52	50.44	54.00	-3.56	AVG	
3	5150.0000	10.19	40.62	50.81	68.30	-17.49	Peak	
4	5150.0000	1.84	40.62	42.46	54.00	-11.54	AVG	
5	5206.4000	65.66	40.81	106.47	68.30	38.17	Peak	No Limit
6 *	5207.2000	55.32	40.81	96.13	54.00	42.13	AVG	No Limit
7	5350.0000	11.97	41.28	53.25	68.30	-15.05	Peak	
8	5350.0000	5.08	41.28	46.36	54.00	-7.64	AVG	
9	5362.0000	20.86	41.32	62.18	68.30	-6.12	Peak	
10	5362.4000	11.64	41.33	52.97	54.00	-1.03	AVG	

Orthogonal Axis:	X
Test Mode:	UNII-1/ TX N20 Mode 5200MHz

Vertical

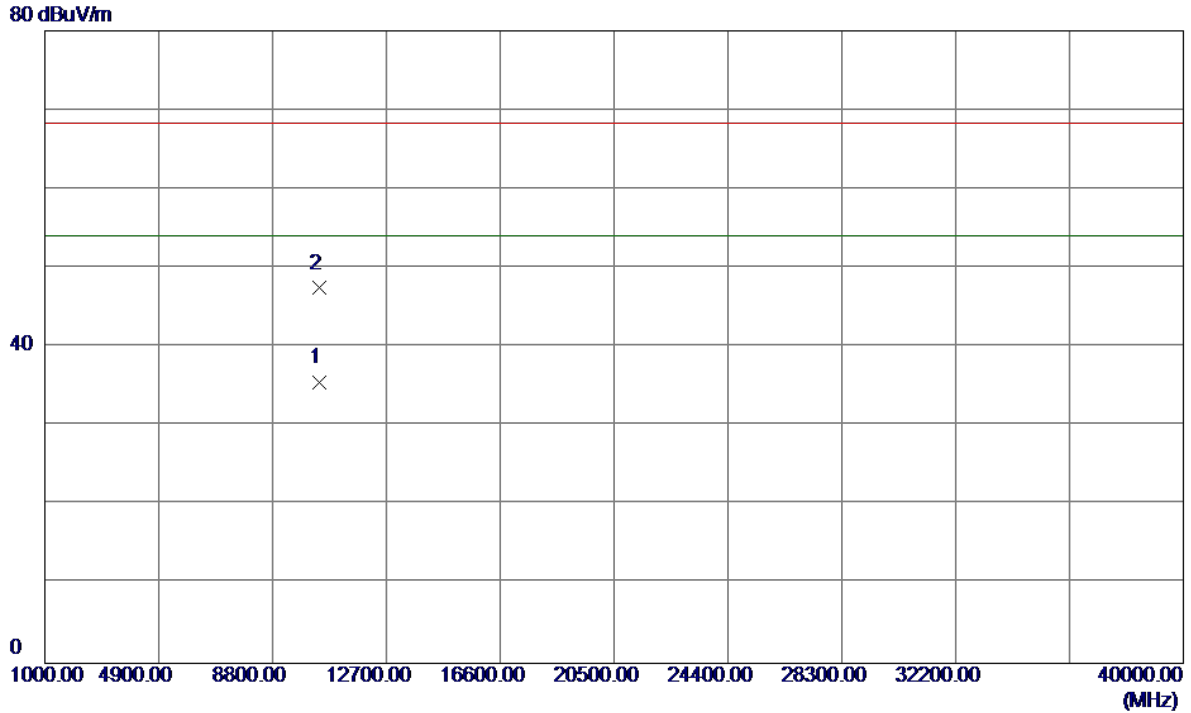

No.	Freq. MHz	Reading Level dBuV/m	Correct Factor dB	Measure ment dBuV/m	Limit dBuV/m	Margin dB	Detector	Comment
1 *	10399.9000	20.46	15.06	35.52	54.00	-18.48	AVG	
2	10402.4000	32.38	15.06	47.44	68.30	-20.86	Peak	

Orthogonal Axis:	X
Test Mode:	UNII-1/ TX N20 Mode 5200MHz

Horizontal

115 dBuV/m

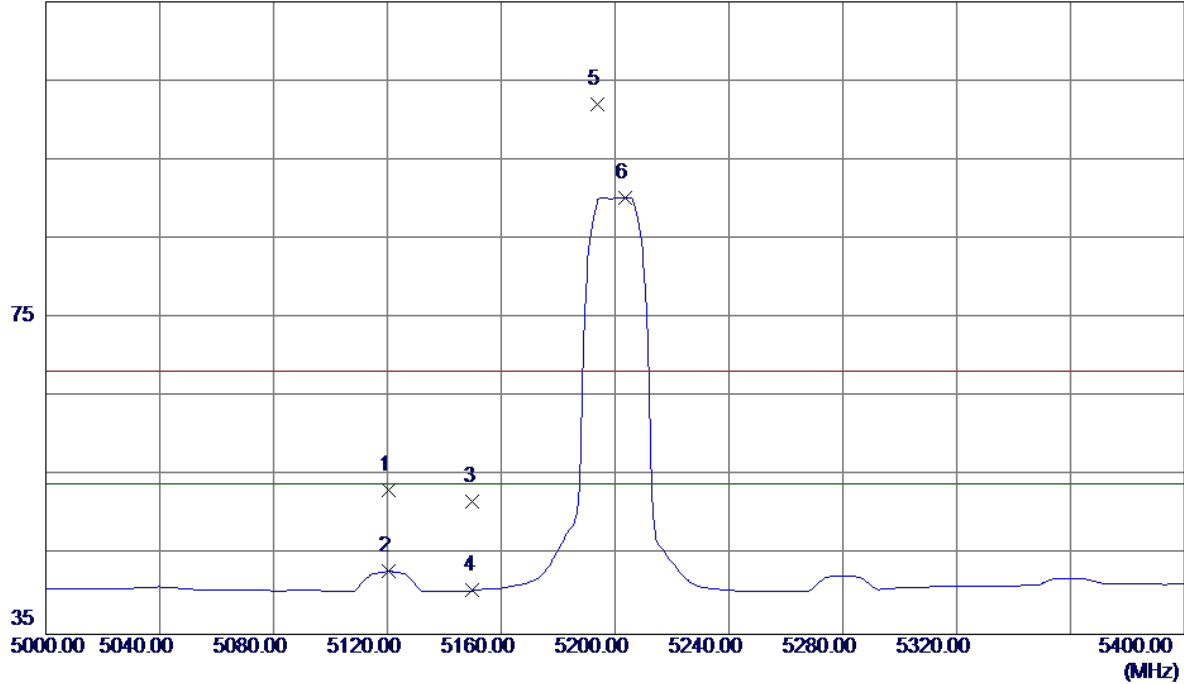

No.	Freq. MHz	Reading Level dBuV/m	Correct Factor dB	Measure ment dBuV/m	Limit dBuV/m	Margin dB	Detector	Comment
1	5120.4000	12.75	40.53	53.28	68.30	-15.02	Peak	
2	5120.4000	2.43	40.53	42.96	54.00	-11.04	AVG	
3	5150.0000	11.20	40.62	51.82	68.30	-16.48	Peak	
4	5150.0000	-0.08	40.62	40.54	54.00	-13.46	AVG	
5	5193.6000	61.21	40.77	101.98	68.30	33.68	Peak	No Limit
6 *	5203.6000	49.44	40.80	90.24	54.00	36.24	AVG	No Limit

Orthogonal Axis:	X
Test Mode:	UNII-1/ TX N20 Mode 5200MHz

Horizontal

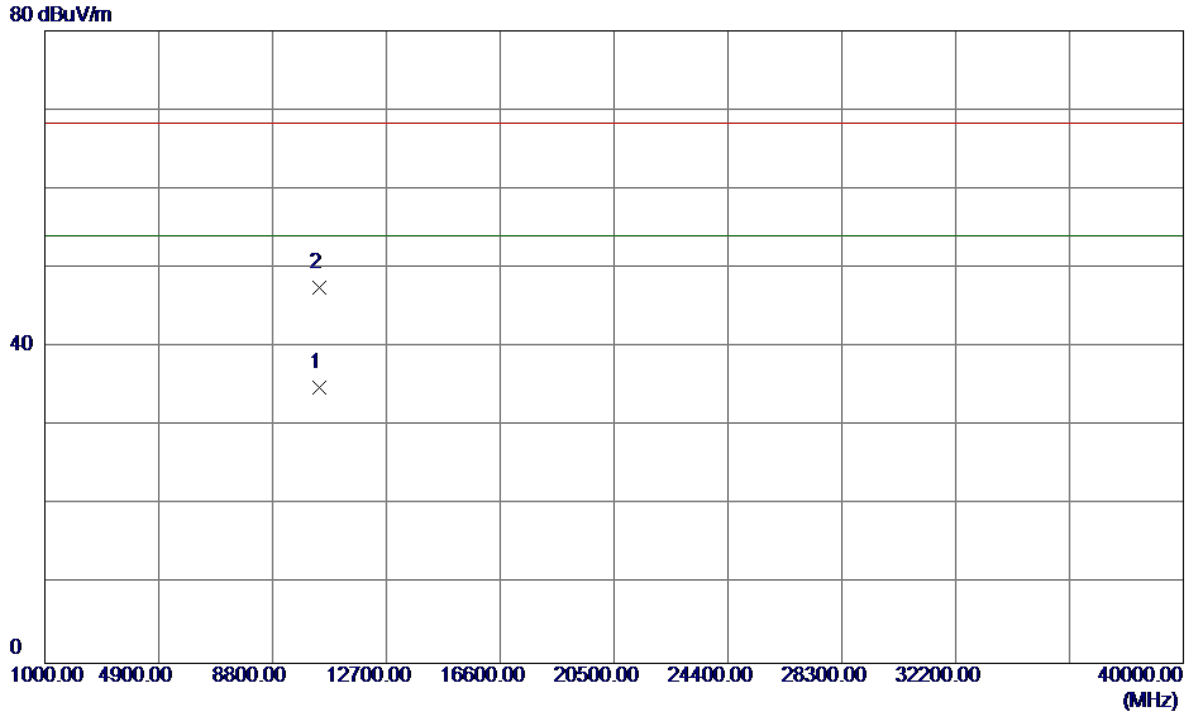

No.	Freq. MHz	Reading Level dBuV/m	Correct Factor dB	Measure ment dBuV/m	Limit dBuV/m	Margin dB	Detector	Comment
1 *	10398.6000	19.86	15.05	34.91	54.00	-19.09	AVG	
2	10399.6000	32.47	15.06	47.53	68.30	-20.77	Peak	

Orthogonal Axis:	X
Test Mode:	UNII-1/ TX N20 Mode 5240MHz

Vertical

115 dBuV/m

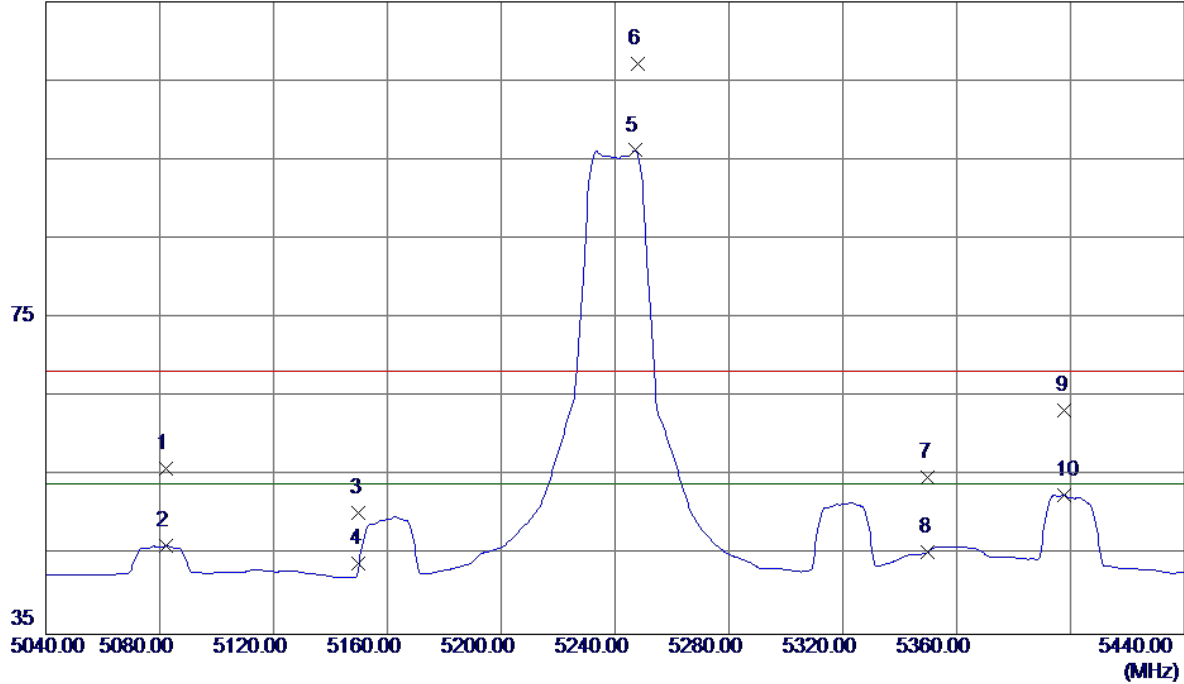

No.	Freq. MHz	Reading Level dBuV/m	Correct Factor dB	Measure ment dBuV/m	Limit dBuV/m	Margin dB	Detector	Comment
1	5082.4000	15.49	40.40	55.89	68.30	-12.41	Peak	
2	5082.4000	5.78	40.40	46.18	54.00	-7.82	AVG	
3	5150.0000	9.72	40.62	50.34	68.30	-17.96	Peak	
4	5150.0000	3.32	40.62	43.94	54.00	-10.06	AVG	
5 *	5247.2000	55.25	40.95	96.20	54.00	42.20	AVG	No Limit
6	5248.0000	66.15	40.95	107.10	68.30	38.80	Peak	No Limit
7	5350.0000	13.51	41.28	54.79	68.30	-13.51	Peak	
8	5350.0000	4.16	41.28	45.44	54.00	-8.56	AVG	
9	5398.0000	21.83	41.44	63.27	68.30	-5.03	Peak	
10	5398.0000	11.16	41.44	52.60	54.00	-1.40	AVG	

Orthogonal Axis:	X
Test Mode:	UNII-1/ TX N20 Mode 5240MHz

Vertical

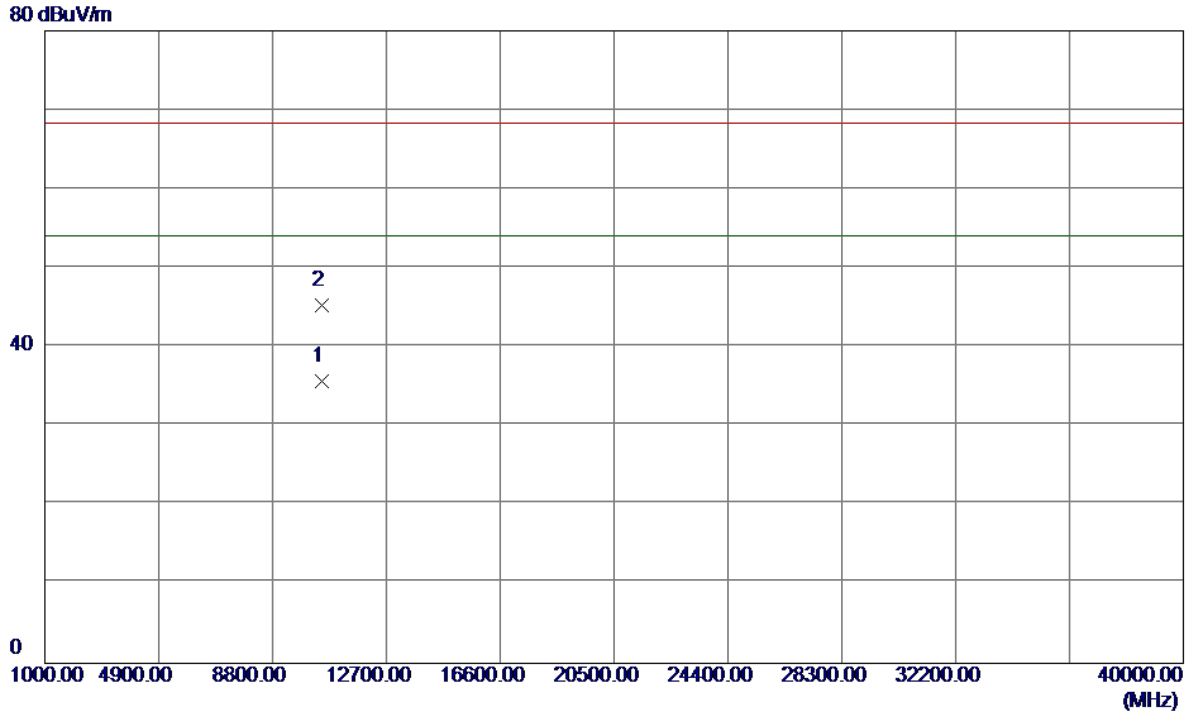

No.	Freq. MHz	Reading Level dBuV/m	Correct Factor dB	Measure ment dBuV/m	Limit dBuV/m	Margin dB	Detector	Comment
1 *	10481.6000	20.42	15.25	35.67	54.00	-18.33	AVG	
2	10482.1000	29.97	15.25	45.22	68.30	-23.08	Peak	

Orthogonal Axis:	X
Test Mode:	UNII-1/ TX N20 Mode 5240MHz

Horizontal

115 dBuV/m

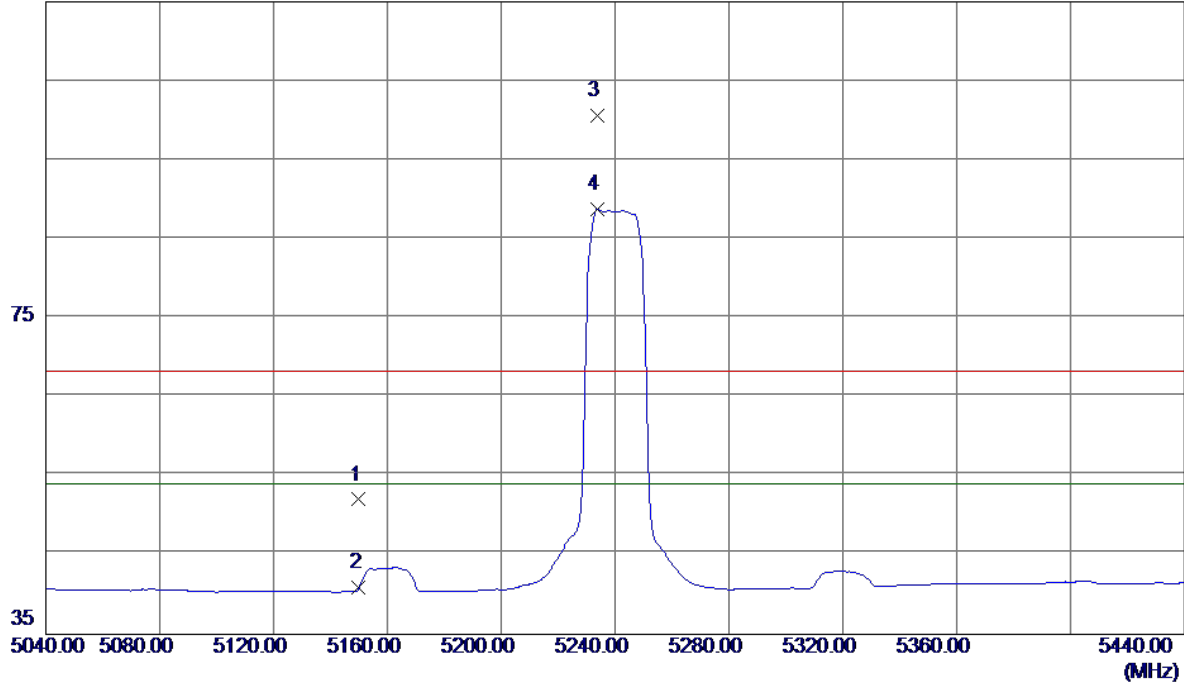

No.	Freq. MHz	Reading Level dBuV/m	Correct Factor dB	Measure ment dBuV/m	Limit dBuV/m	Margin dB	Detector	Comment
1	5150.0000	11.42	40.62	52.04	68.30	-16.26	Peak	
2	5150.0000	0.37	40.62	40.99	54.00	-13.01	AVG	
3	5233.6000	59.76	40.90	100.66	68.30	32.36	Peak	No Limit
4 *	5233.6000	47.88	40.90	88.78	54.00	34.78	AVG	No Limit

Orthogonal Axis:	X
Test Mode:	UNII-1/ TX N20 Mode 5240MHz

Horizontal

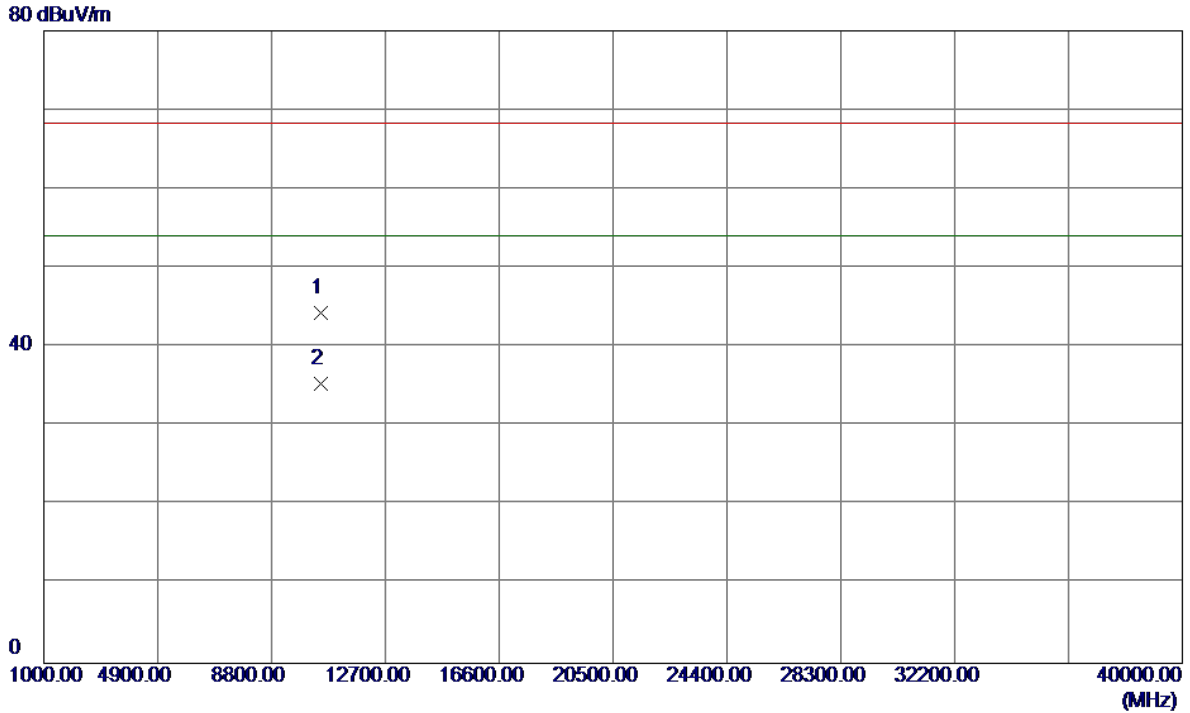

No.	Freq. MHz	Reading Level dBuV/m	Correct Factor dB	Measure ment dBuV/m	Limit dBuV/m	Margin dB	Detector	Comment
1	10479.1000	29.14	15.24	44.38	68.30	-23.92	Peak	
2 *	10482.9000	20.07	15.25	35.32	54.00	-18.68	AVG	

Orthogonal Axis:	X
Test Mode:	UNII-1/ TX N40 Mode 5190MHz

Vertical

115 dBuV/m

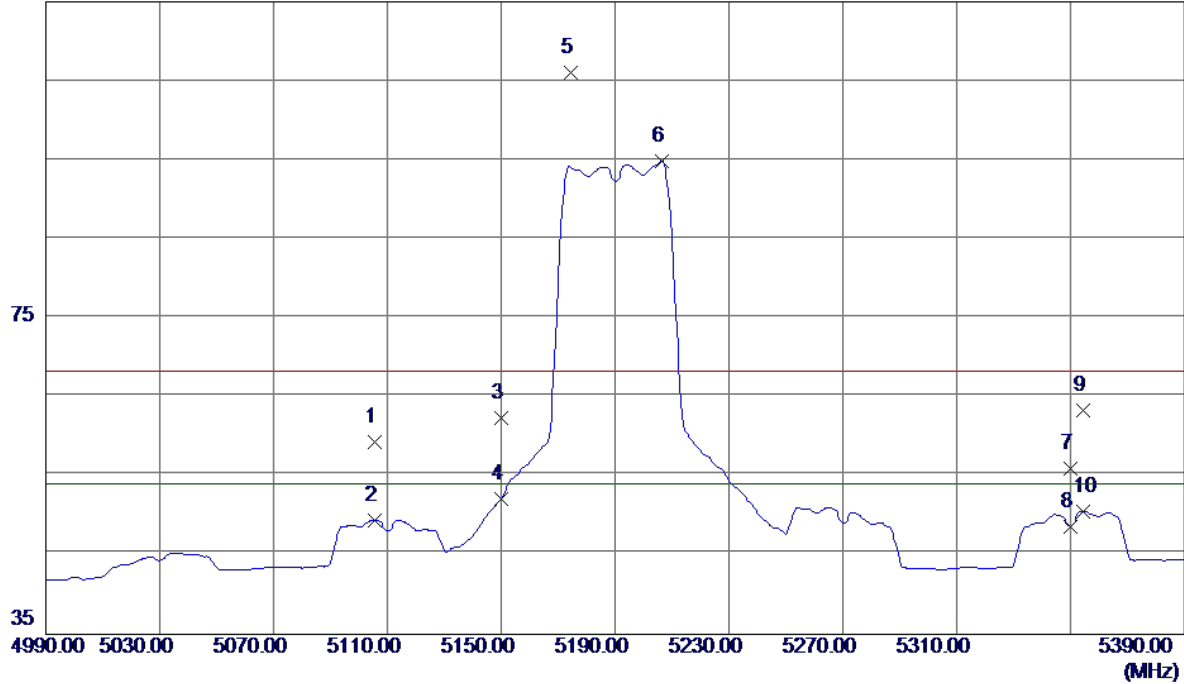

No.	Freq. MHz	Reading Level dBuV/m	Correct Factor dB	Measure ment dBuV/m	Limit dBuV/m	Margin dB	Detector	Comment
1	5105.6000	18.90	40.48	59.38	68.30	-8.92	Peak	
2	5105.6000	8.93	40.48	49.41	54.00	-4.59	AVG	
3	5150.0000	21.75	40.62	62.37	68.30	-5.93	Peak	
4	5150.0000	11.51	40.62	52.13	54.00	-1.87	AVG	
5	5174.4000	65.32	40.71	106.03	68.30	37.73	Peak	No Limit
6 *	5206.4000	54.03	40.81	94.84	54.00	40.84	AVG	No Limit
7	5350.0000	14.63	41.28	55.91	68.30	-12.39	Peak	
8	5350.0000	7.38	41.28	48.66	54.00	-5.34	AVG	
9	5354.4000	22.05	41.30	63.35	68.30	-4.95	Peak	
10	5354.4000	9.29	41.30	50.59	54.00	-3.41	AVG	

Orthogonal Axis:	X
Test Mode:	UNII-1/ TX N40 Mode 5190MHz

Vertical

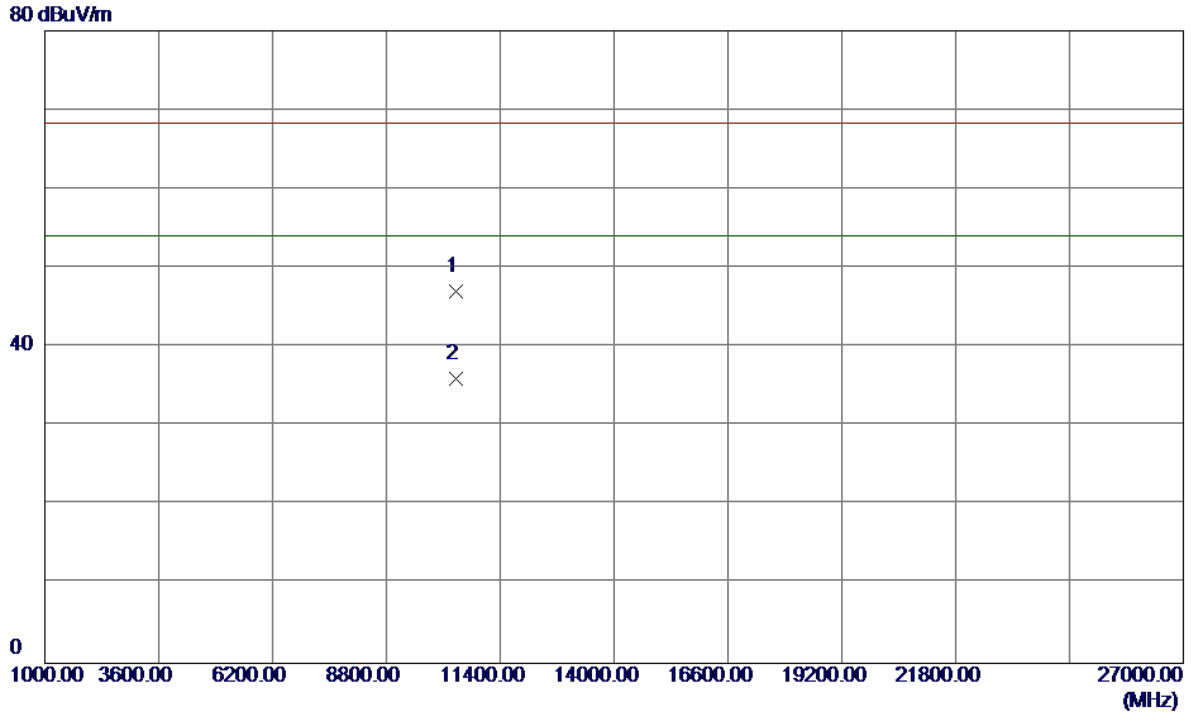

No.	Freq. MHz	Reading Level dBuV/m	Correct Factor dB	Measure ment dBuV/m	Limit dBuV/m	Margin dB	Detector	Comment
1	10378.5000	31.99	15.01	47.00	68.30	-21.30	Peak	
2 *	10378.9000	21.00	15.01	36.01	54.00	-17.99	AVG	

Orthogonal Axis:	X
Test Mode:	UNII-1/ TX N40 Mode 5190MHz

Horizontal

115 dBuV/m

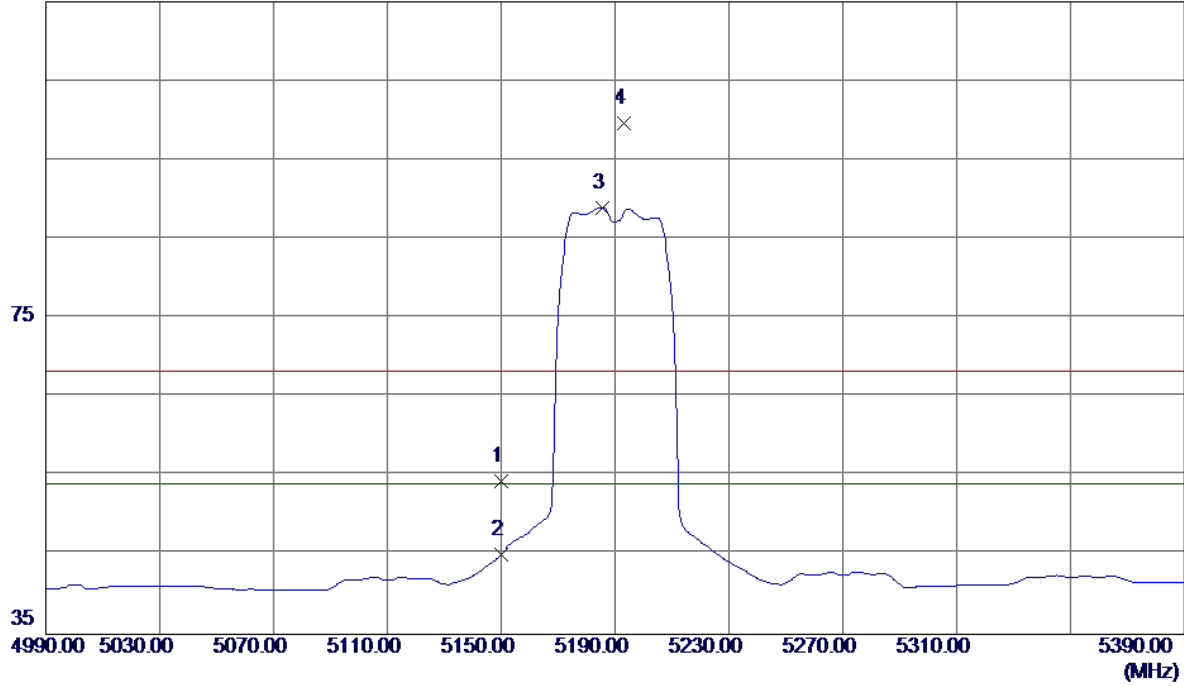

No.	Freq. MHz	Reading Level dBuV/m	Correct Factor dB	Measure ment dBuV/m	Limit dBuV/m	Margin dB	Detector	Comment
1	5150.0000	13.79	40.62	54.41	68.30	-13.89	Peak	
2	5150.0000	4.52	40.62	45.14	54.00	-8.86	AVG	
3 *	5185.6000	48.17	40.74	88.91	54.00	34.91	AVG	No Limit
4	5193.2000	58.85	40.77	99.62	68.30	31.32	Peak	No Limit

Orthogonal Axis:	X
Test Mode:	UNII-1/ TX N40 Mode 5190MHz

Horizontal

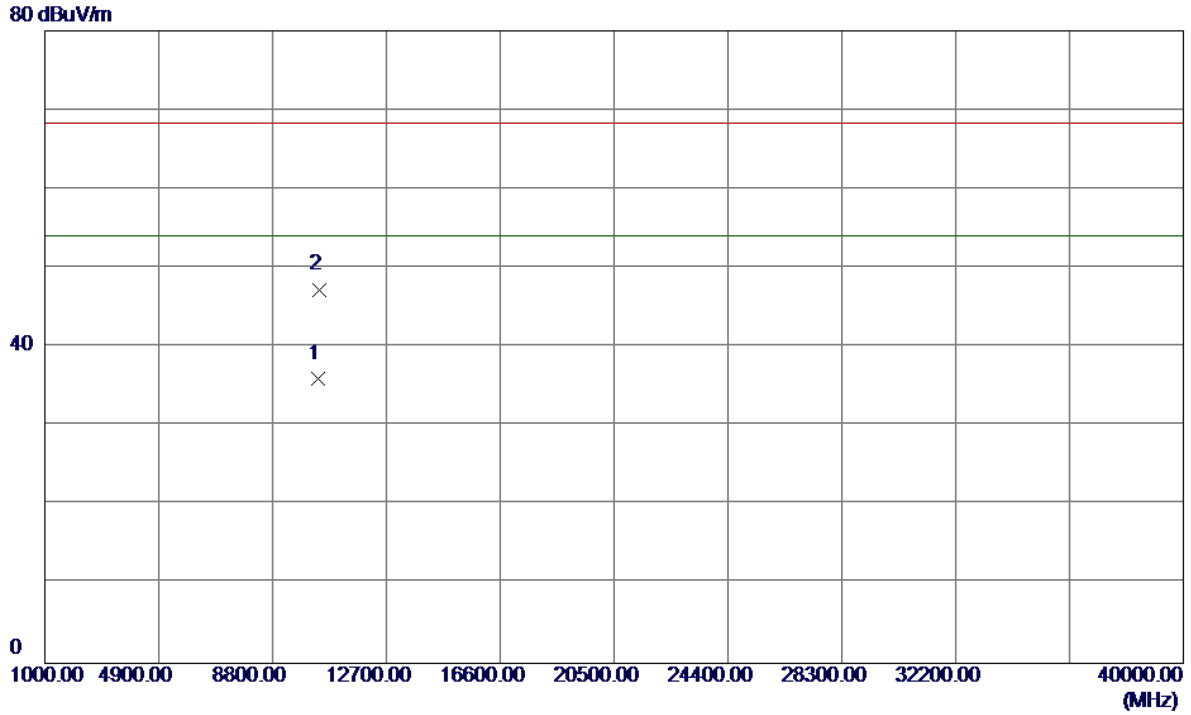

No.	Freq. MHz	Reading Level dBuV/m	Correct Factor dB	Measure ment dBuV/m	Limit dBuV/m	Margin dB	Detector	Comment
1 *	10378.8000	20.95	15.01	35.96	54.00	-18.04	AVG	
2	10381.9000	32.27	15.01	47.28	68.30	-21.02	Peak	

Orthogonal Axis:	X
Test Mode:	UNII-1/ TX N40 Mode 5230MHz

Vertical

115 dBuV/m

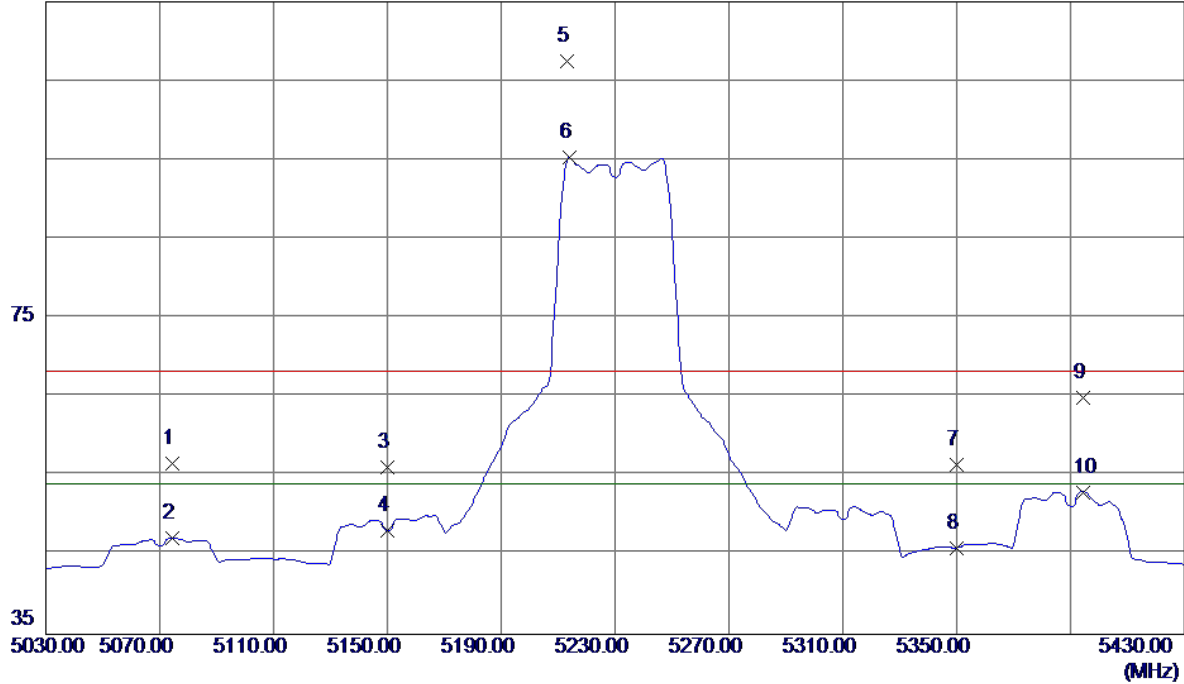

No.	Freq. MHz	Reading Level dBuV/m	Correct Factor dB	Measure ment dBuV/m	Limit dBuV/m	Margin dB	Detector	Comment
1	5074.4000	16.26	40.38	56.64	68.30	-11.66	Peak	
2	5074.4000	6.84	40.38	47.22	54.00	-6.78	AVG	
3	5150.0000	15.53	40.62	56.15	68.30	-12.15	Peak	
4	5150.0000	7.45	40.62	48.07	54.00	-5.93	AVG	
5	5213.2000	66.64	40.83	107.47	68.30	39.17	Peak	No Limit
6 *	5214.0000	54.44	40.84	95.28	54.00	41.28	AVG	No Limit
7	5350.0000	15.12	41.28	56.40	68.30	-11.90	Peak	
8	5350.0000	4.66	41.28	45.94	54.00	-8.06	AVG	
9	5394.4000	23.45	41.43	64.88	68.30	-3.42	Peak	
10	5394.4000	11.52	41.43	52.95	54.00	-1.05	AVG	

Orthogonal Axis:	X
Test Mode:	UNII-1/ TX N40 Mode 5230MHz

Vertical

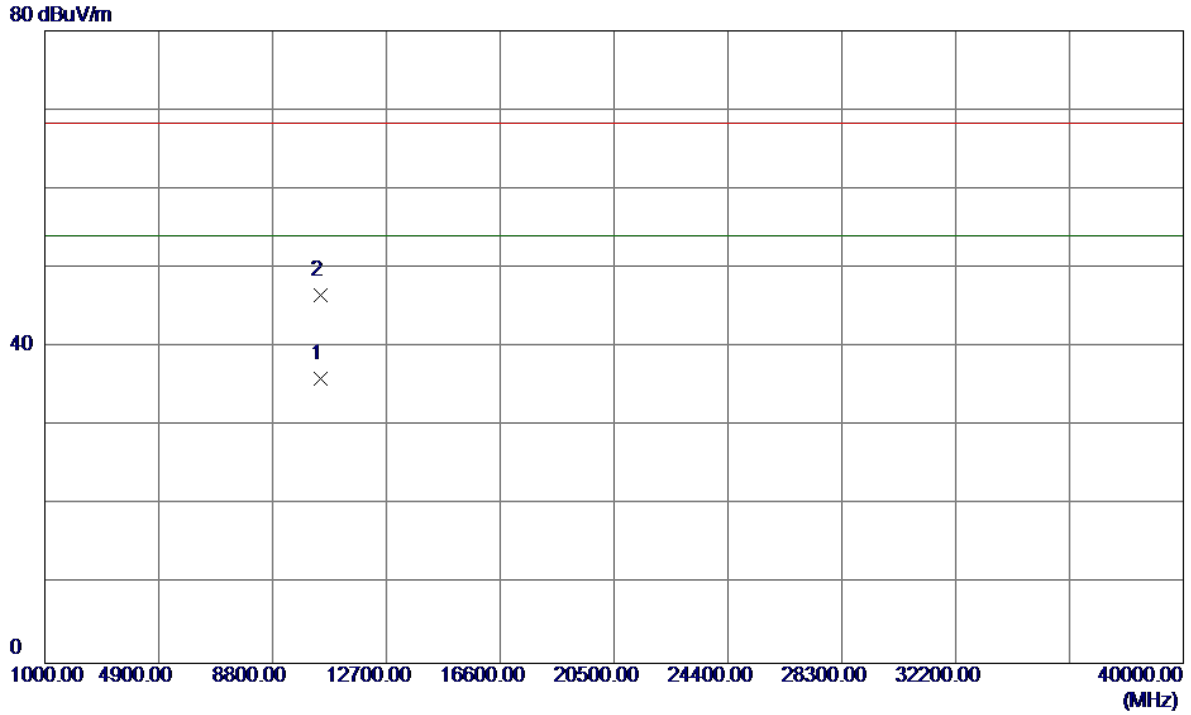

No.	Freq. MHz	Reading Level dBuV/m	Correct Factor dB	Measure ment dBuV/m	Limit dBuV/m	Margin dB	Detector	Comment
1 *	10458.4000	20.79	15.19	35.98	54.00	-18.02	AVG	
2	10459.5000	31.29	15.20	46.49	68.30	-21.81	Peak	

Orthogonal Axis:	X
Test Mode:	UNII-1/ TX N40 Mode 5230MHz

Horizontal

115 dBuV/m

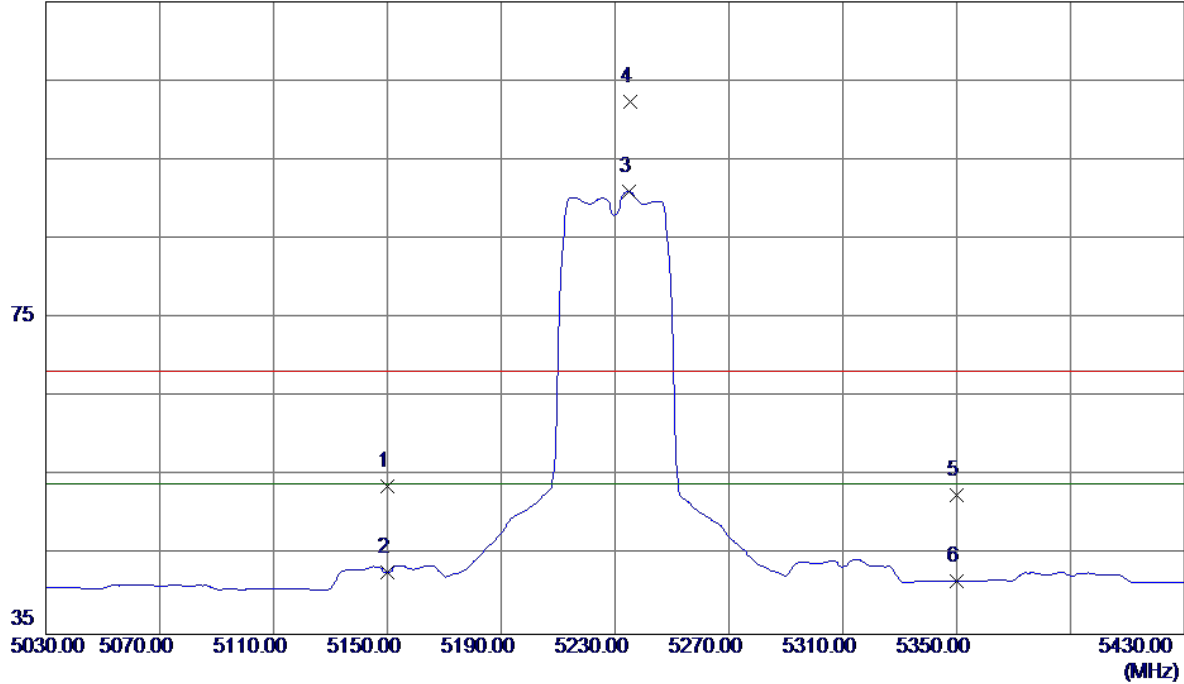

No.	Freq. MHz	Reading Level dBuV/m	Correct Factor dB	Measure ment dBuV/m	Limit dBuV/m	Margin dB	Detector	Comment
1	5150.0000	13.09	40.62	53.71	68.30	-14.59	Peak	
2	5150.0000	2.18	40.62	42.80	54.00	-11.20	AVG	
3 *	5234.8000	50.08	40.90	90.98	54.00	36.98	AVG	No Limit
4	5235.2000	61.38	40.91	102.29	68.30	33.99	Peak	No Limit
5	5350.0000	11.37	41.28	52.65	68.30	-15.65	Peak	
6	5350.0000	0.40	41.28	41.68	54.00	-12.32	AVG	

Orthogonal Axis:	X
Test Mode:	UNII-1/ TX N40 Mode 5230MHz

Horizontal

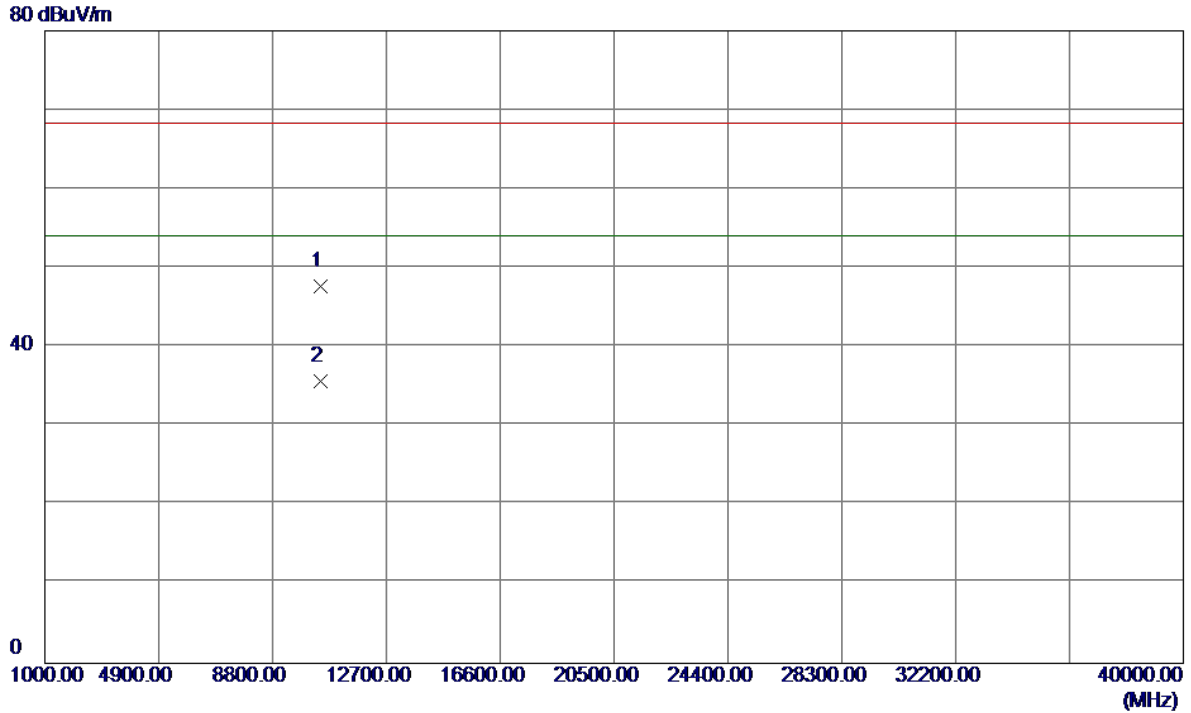

No.	Freq. MHz	Reading Level dBuV/m	Correct Factor dB	Measure ment dBuV/m	Limit dBuV/m	Margin dB	Detector	Comment
1	10458.2500	32.44	15.19	47.63	68.30	-20.67	Peak	
2 *	10460.9500	20.42	15.20	35.62	54.00	-18.38	AVG	

Orthogonal Axis:	X
Test Mode:	UNII-3/TX A Mode 5745MHz

Vertical

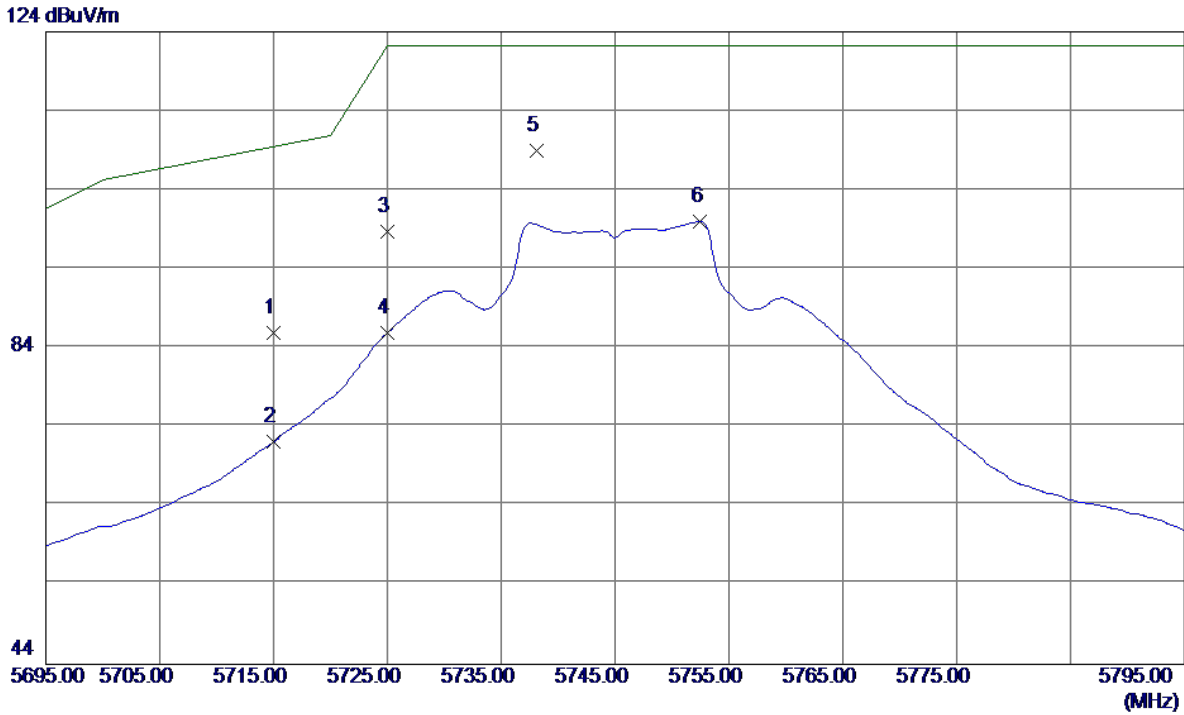

No.	Freq. MHz	Reading Level dBuV/m	Correct Factor dB	Measure ment dBuV/m	Limit dBuV/m	Margin dB	Detector	Comment
1	5715.0000	43.37	42.55	85.92	109.50	-23.58	Peak	
2	5715.0000	29.54	42.55	72.09	109.50	-37.41	AVG	
3	5725.0000	56.09	42.58	98.67	122.30	-23.63	Peak	
4	5725.0000	43.33	42.58	85.91	122.30	-36.39	AVG	
5 *	5738.1000	66.37	42.63	109.00	122.30	-13.30	Peak	
6	5752.5000	57.37	42.68	100.05	122.30	-22.25	AVG	

Orthogonal Axis:	X
Test Mode:	UNII-3/TX A Mode 5745MHz

Vertical

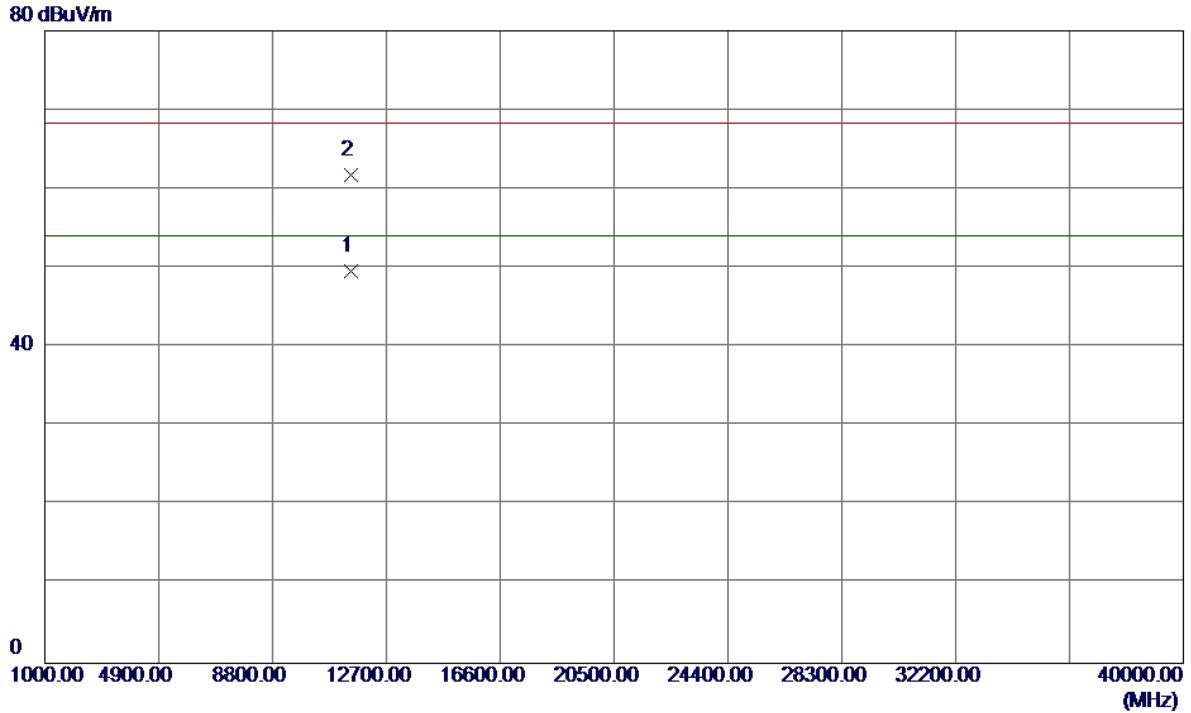

No.	Freq. MHz	Reading Level dBuV/m	Correct Factor dB	Measure ment dBuV/m	Limit dBuV/m	Margin dB	Detector	Comment
1 *	11489.8000	34.07	15.49	49.56	54.00	-4.44	AVG	
2	11494.2000	46.22	15.49	61.71	68.30	-6.59	Peak	

Orthogonal Axis:	X
Test Mode:	UNII-3/TX A Mode 5745MHz

Horizontal

124 dBuV/m

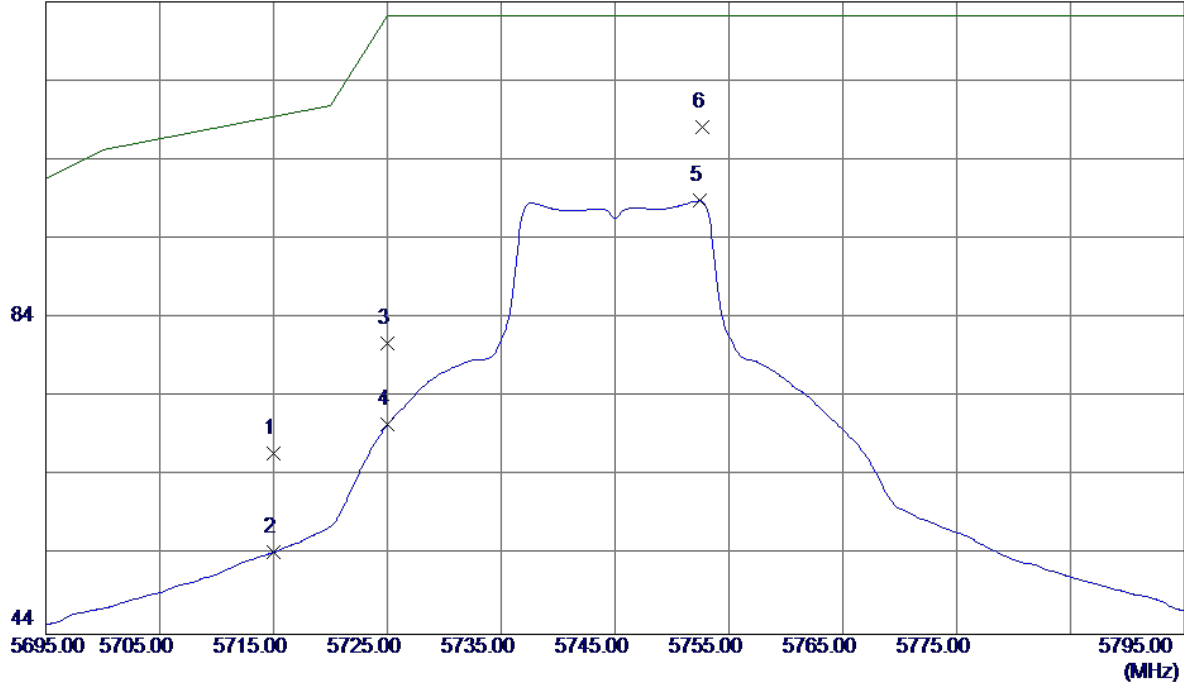

No.	Freq. MHz	Reading Level dBuV/m	Correct Factor dB	Measure ment dBuV/m	Limit dBuV/m	Margin dB	Detector	Comment
1	5715.0000	24.38	42.55	66.93	109.50	-42.57	Peak	
2	5715.0000	11.83	42.55	54.38	109.50	-55.12	AVG	
3	5725.0000	38.18	42.58	80.76	122.30	-41.54	Peak	
4	5725.0000	27.92	42.58	70.50	122.30	-51.80	AVG	
5	5752.4000	56.13	42.68	98.81	122.30	-23.49	AVG	
6 *	5752.7000	65.47	42.68	108.15	122.30	-14.15	Peak	

Orthogonal Axis:	X
Test Mode:	UNII-3/TX A Mode 5745MHz

Horizontal

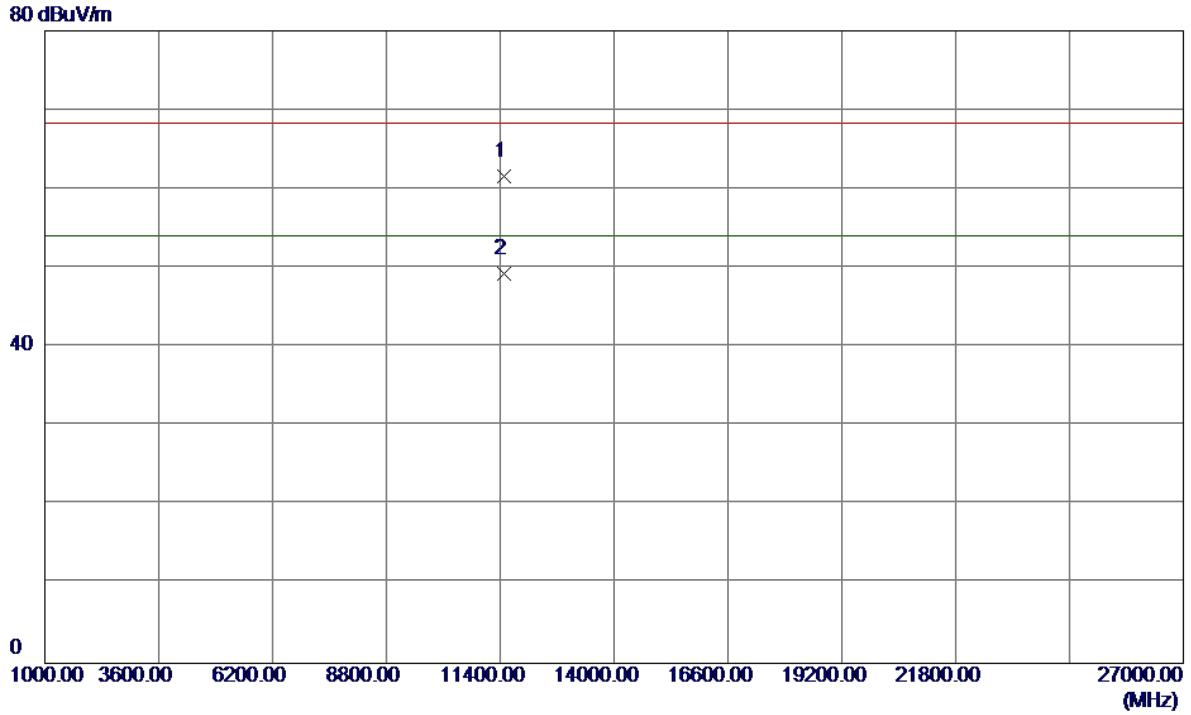

No.	Freq. MHz	Reading Level dBuV/m	Correct Factor dB	Measure ment dBuV/m	Limit dBuV/m	Margin dB	Detector	Comment
1	11489.5500	46.12	15.49	61.61	68.30	-6.69	Peak	
2 *	11489.7500	33.80	15.49	49.29	54.00	-4.71	AVG	

Orthogonal Axis:	X
Test Mode:	UNII-3/TX A Mode 5785MHz

Vertical

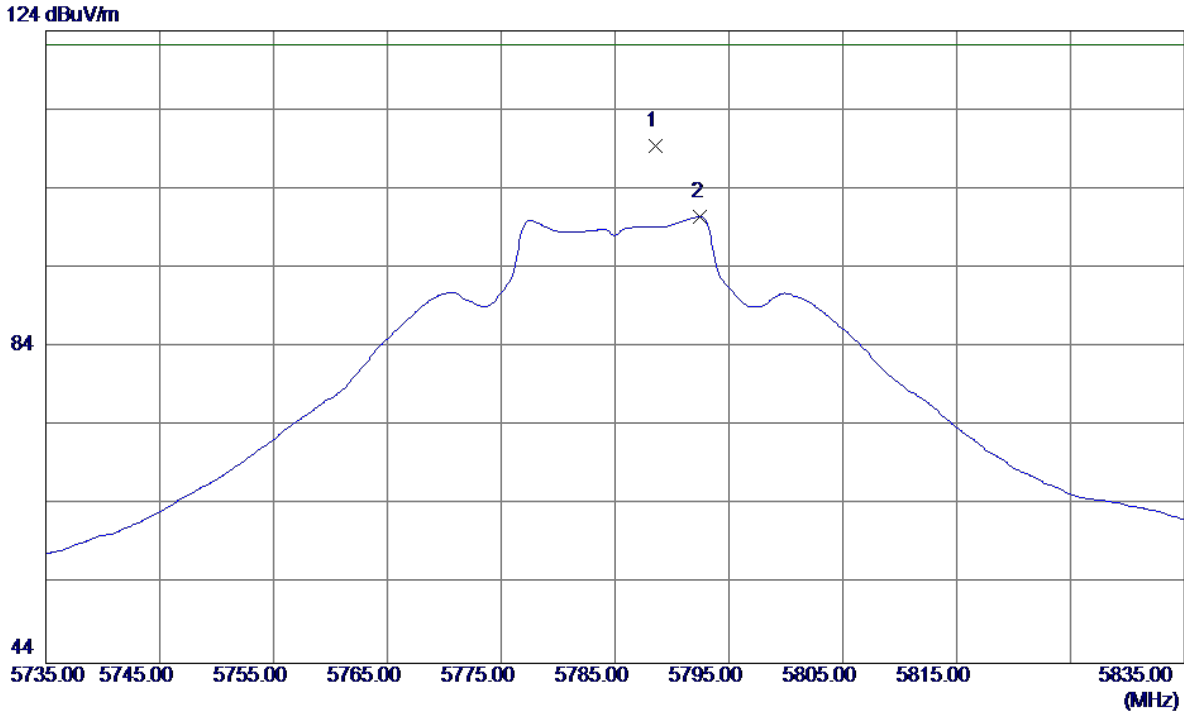

No.	Freq. MHz	Reading Level dBuV/m	Correct Factor dB	Measure ment dBuV/m	Limit dBuV/m	Margin dB	Detector	Comment
1 *	5788.6000	66.57	42.81	109.38	122.30	-12.92	Peak	
2	5792.5000	57.70	42.82	100.52	122.30	-21.78	AVG	

Orthogonal Axis:	X
Test Mode:	UNII-3/TX A Mode 5785MHz

Vertical

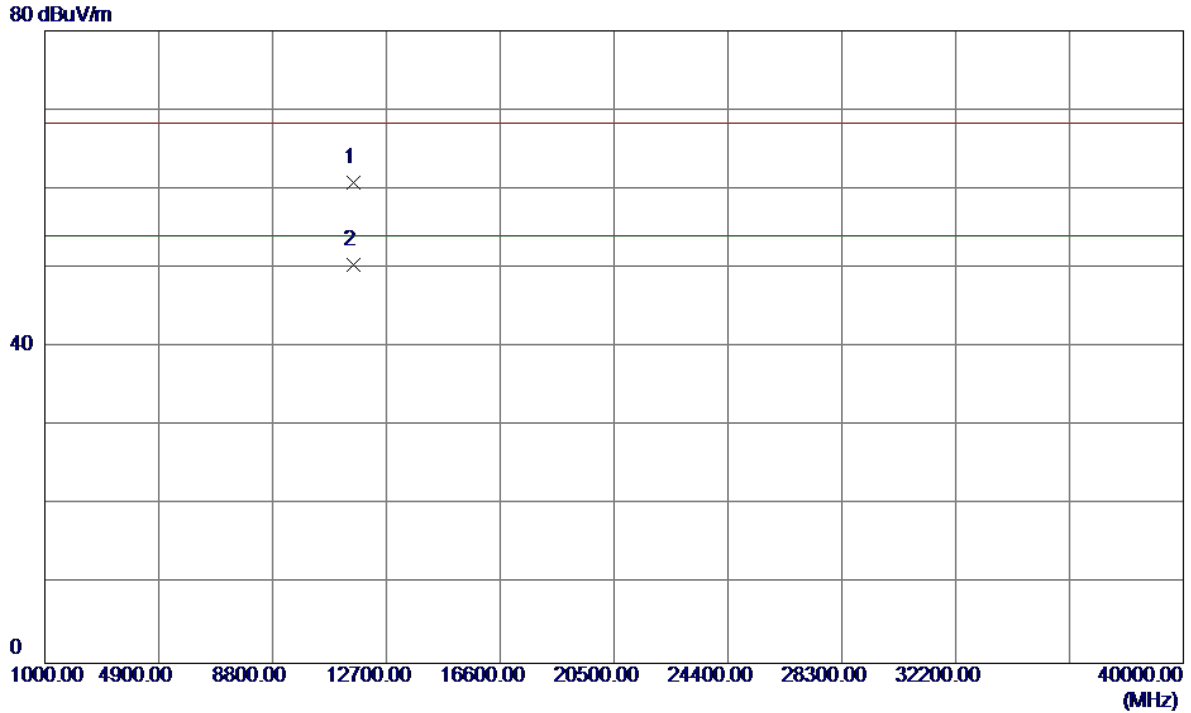

No.	Freq. MHz	Reading Level dBuV/m	Correct Factor dB	Measure ment dBuV/m	Limit dBuV/m	Margin dB	Detector	Comment
1	11569.0000	45.27	15.48	60.75	68.30	-7.55	Peak	
2 *	11569.8000	34.96	15.48	50.44	54.00	-3.56	AVG	

Orthogonal Axis:	X
Test Mode:	UNII-3/TX A Mode 5785MHz

Horizontal

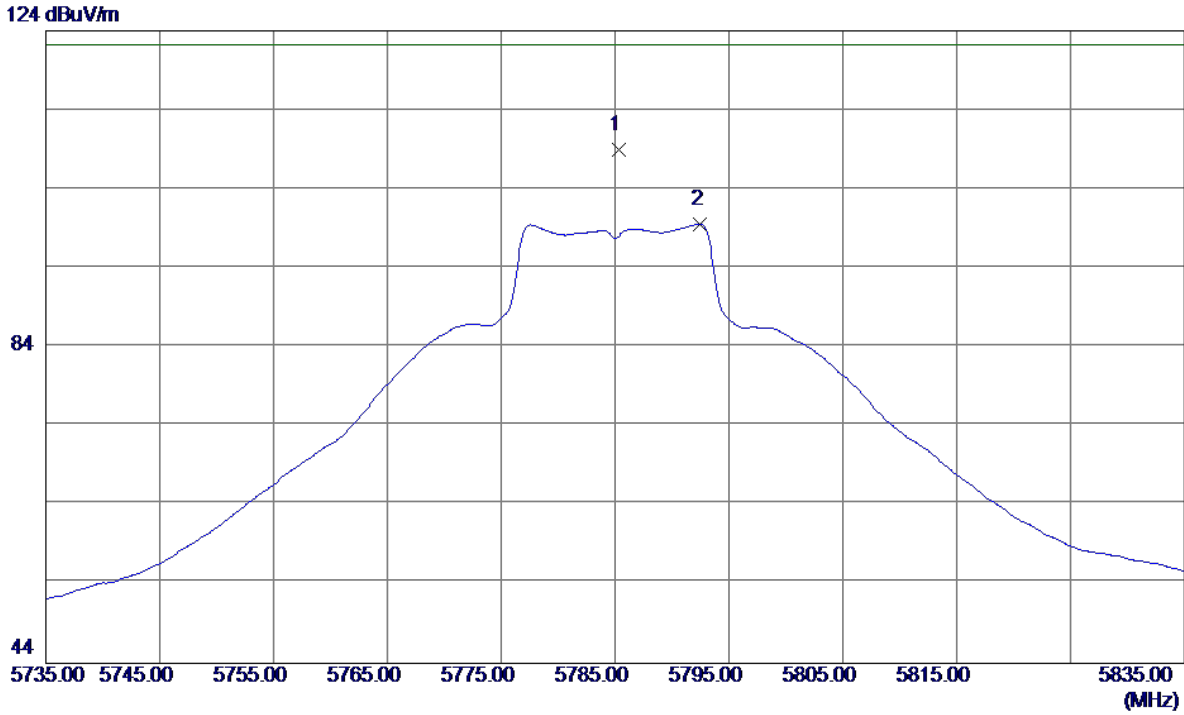

No.	Freq. MHz	Reading Level dBuV/m	Correct Factor dB	Measure ment dBuV/m	Limit dBuV/m	Margin dB	Detector	Comment
1 *	5785.3000	66.12	42.80	108.92	122.30	-13.38	Peak	
2	5792.5000	56.75	42.82	99.57	122.30	-22.73	AVG	

Orthogonal Axis:	X
Test Mode:	UNII-3/TX A Mode 5785MHz

Horizontal

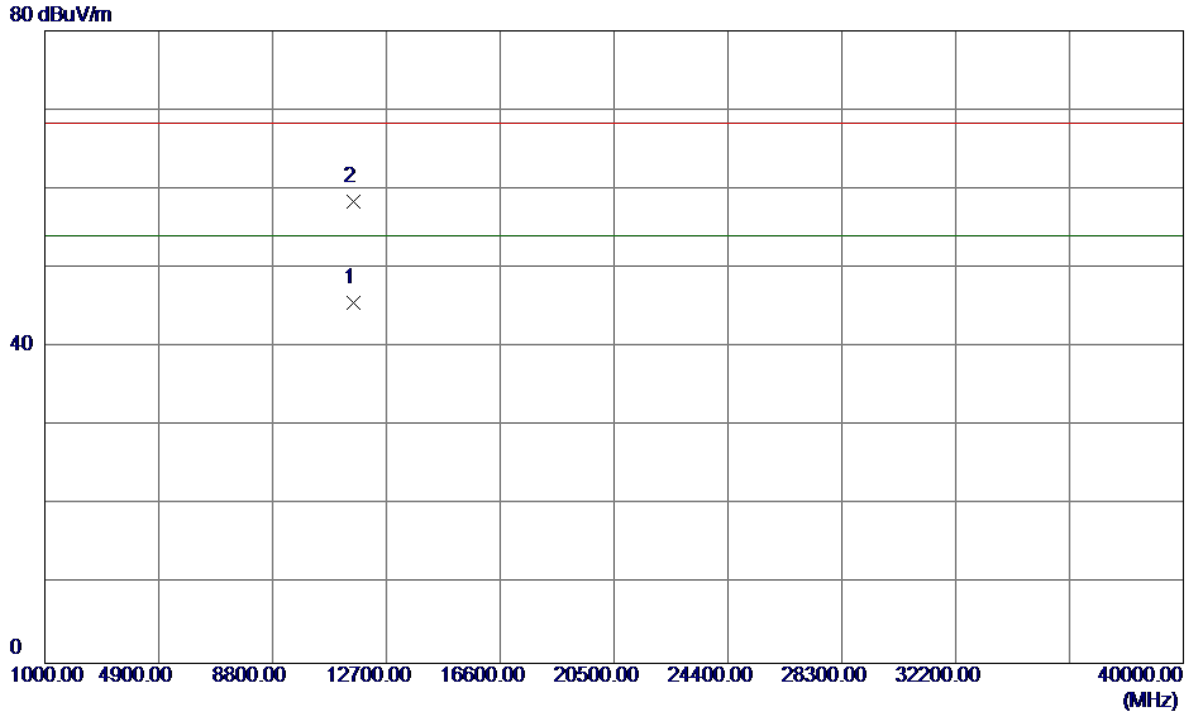

No.	Freq. MHz	Reading Level dBuV/m	Correct Factor dB	Measure ment dBuV/m	Limit dBuV/m	Margin dB	Detector	Comment
1 *	11569.9000	30.09	15.48	45.57	54.00	-8.43	AVG	
2	11570.3000	42.95	15.48	58.43	68.30	-9.87	Peak	

Orthogonal Axis:	X
Test Mode:	UNII-3/TX A Mode 5825MHz

Vertical

124 dBuV/m

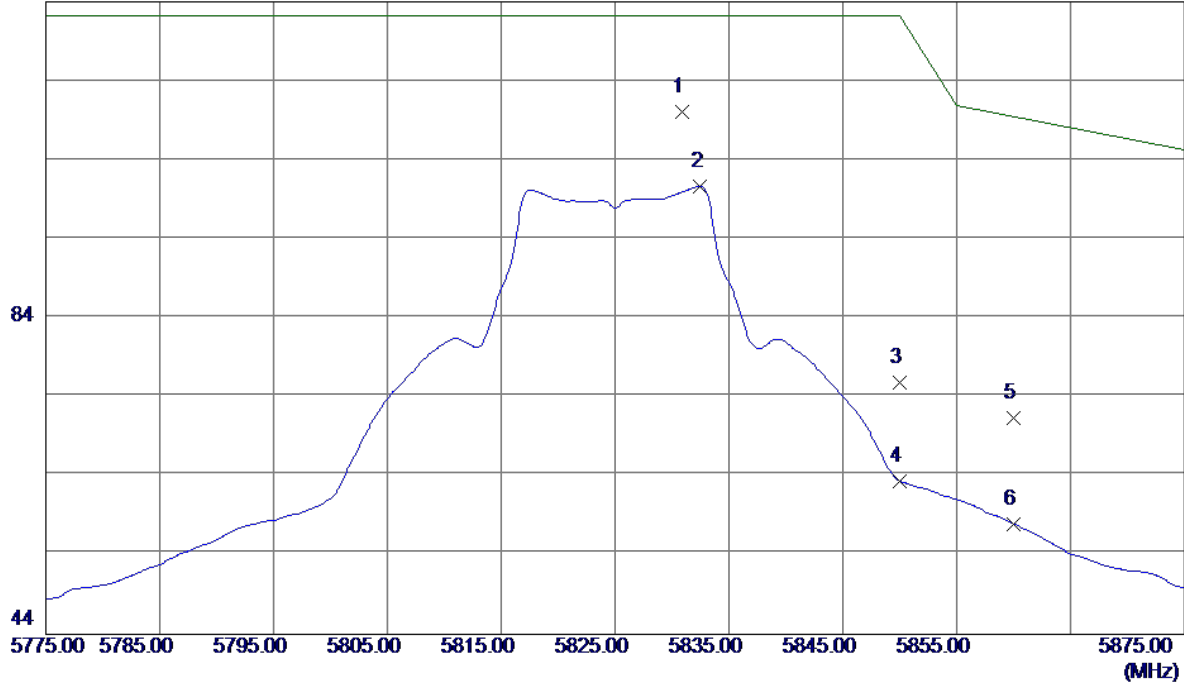

No.	Freq. MHz	Reading Level dBuV/m	Correct Factor dB	Measure ment dBuV/m	Limit dBuV/m	Margin dB	Detector	Comment
1 *	5830.9000	67.10	42.96	110.06	122.30	-12.24	Peak	
2	5832.5000	57.74	42.96	100.70	122.30	-21.60	AVG	
3	5850.0000	32.84	43.03	75.87	122.30	-46.43	Peak	
4	5850.0000	20.37	43.03	63.40	122.30	-58.90	AVG	
5	5860.0000	28.25	43.06	71.31	109.50	-38.19	Peak	
6	5860.0000	14.93	43.06	57.99	109.50	-51.51	AVG	

Orthogonal Axis:	X
Test Mode:	UNII-3/TX A Mode 5825MHz

Vertical

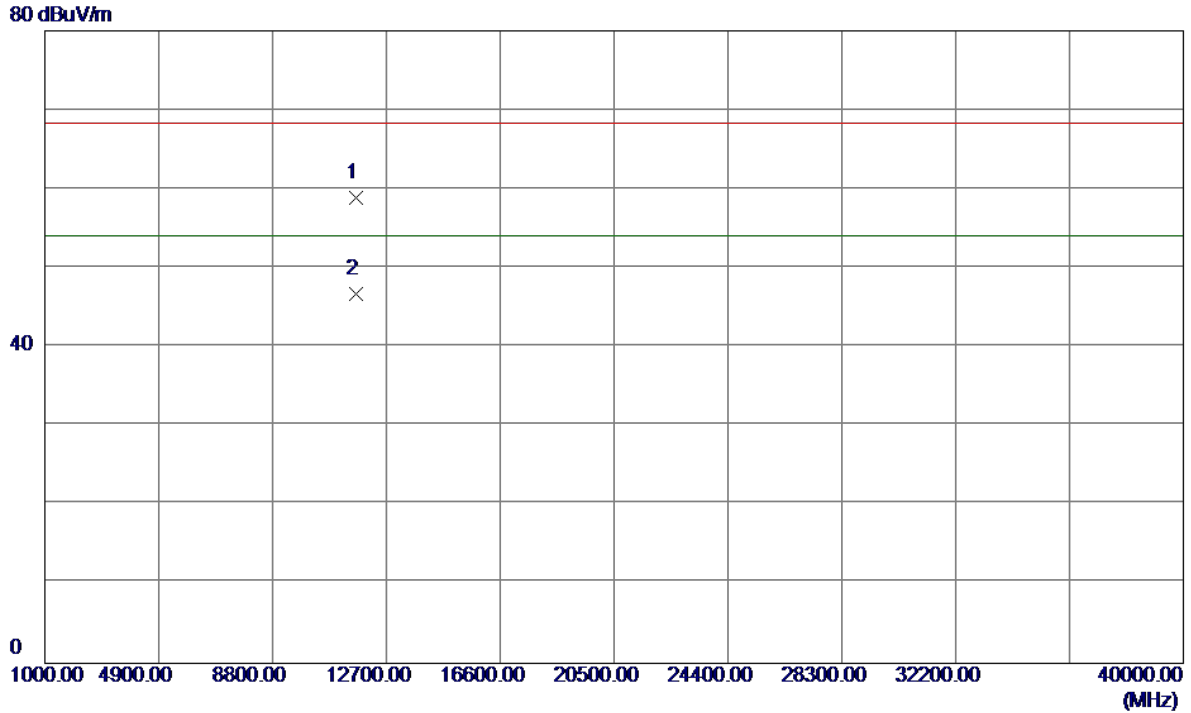

No.	Freq. MHz	Reading Level dBuV/m	Correct Factor dB	Measure ment dBuV/m	Limit dBuV/m	Margin dB	Detector	Comment
1	11649.4000	43.39	15.48	58.87	68.30	-9.43	Peak	
2 *	11649.6000	31.31	15.48	46.79	54.00	-7.21	AVG	

Orthogonal Axis:	X
Test Mode:	UNII-3/TX A Mode 5825MHz

Horizontal

124 dBuV/m

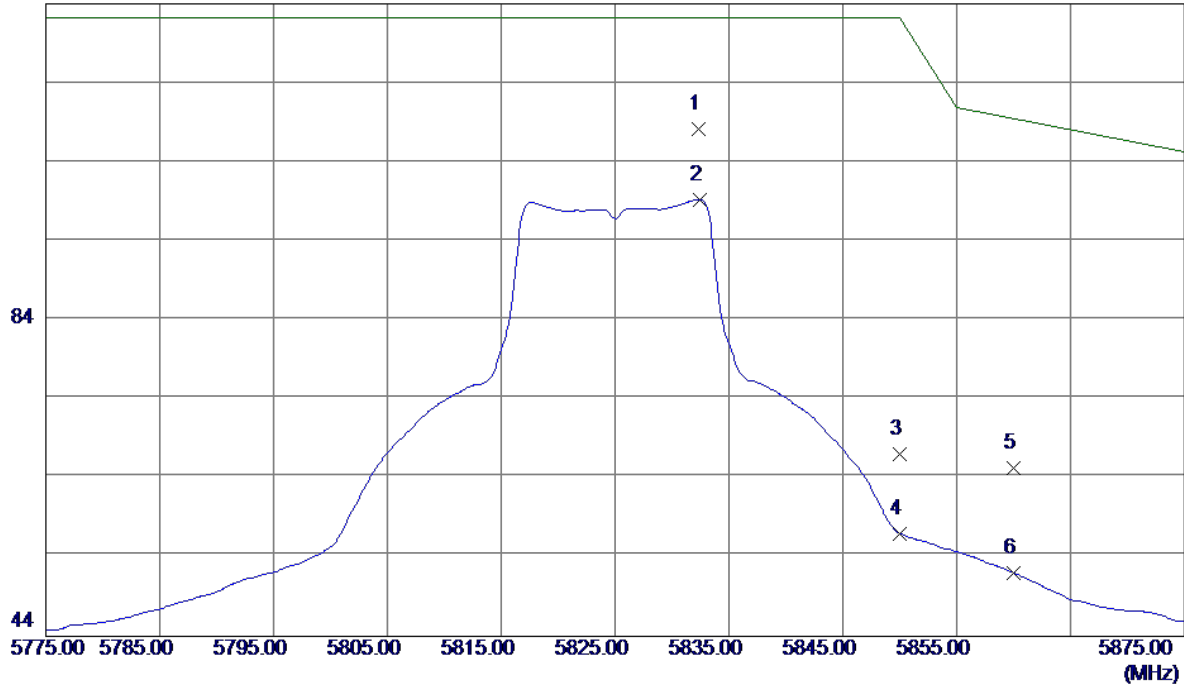

No.	Freq. MHz	Reading Level dBuV/m	Correct Factor dB	Measure ment dBuV/m	Limit dBuV/m	Margin dB	Detector	Comment
1 *	5832.3000	65.20	42.96	108.16	122.30	-14.14	Peak	
2	5832.4000	56.29	42.96	99.25	122.30	-23.05	AVG	
3	5850.0000	24.07	43.03	67.10	122.30	-55.20	Peak	
4	5850.0000	14.00	43.03	57.03	122.30	-65.27	AVG	
5	5860.0000	22.24	43.06	65.30	109.50	-44.20	Peak	
6	5860.0000	8.96	43.06	52.02	109.50	-57.48	AVG	

Orthogonal Axis:	X
Test Mode:	UNII-3/TX A Mode 5825MHz

Horizontal

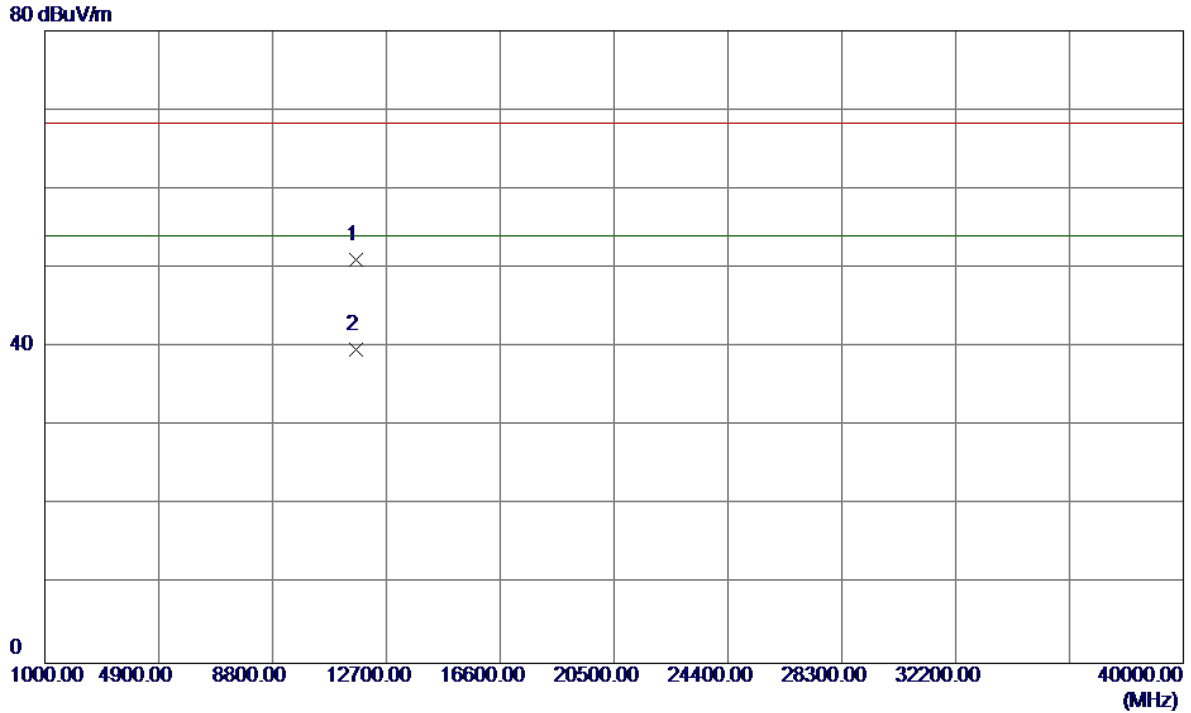

No.	Freq. MHz	Reading Level dBuV/m	Correct Factor dB	Measure ment dBuV/m	Limit dBuV/m	Margin dB	Detector	Comment
1	11649.9000	35.61	15.48	51.09	68.30	-17.21	Peak	
2 *	11650.0500	24.26	15.48	39.74	54.00	-14.26	AVG	

Orthogonal Axis:	X
Test Mode:	UNII-3/TX N20 Mode 5745MHz

Vertical

124 dBuV/m

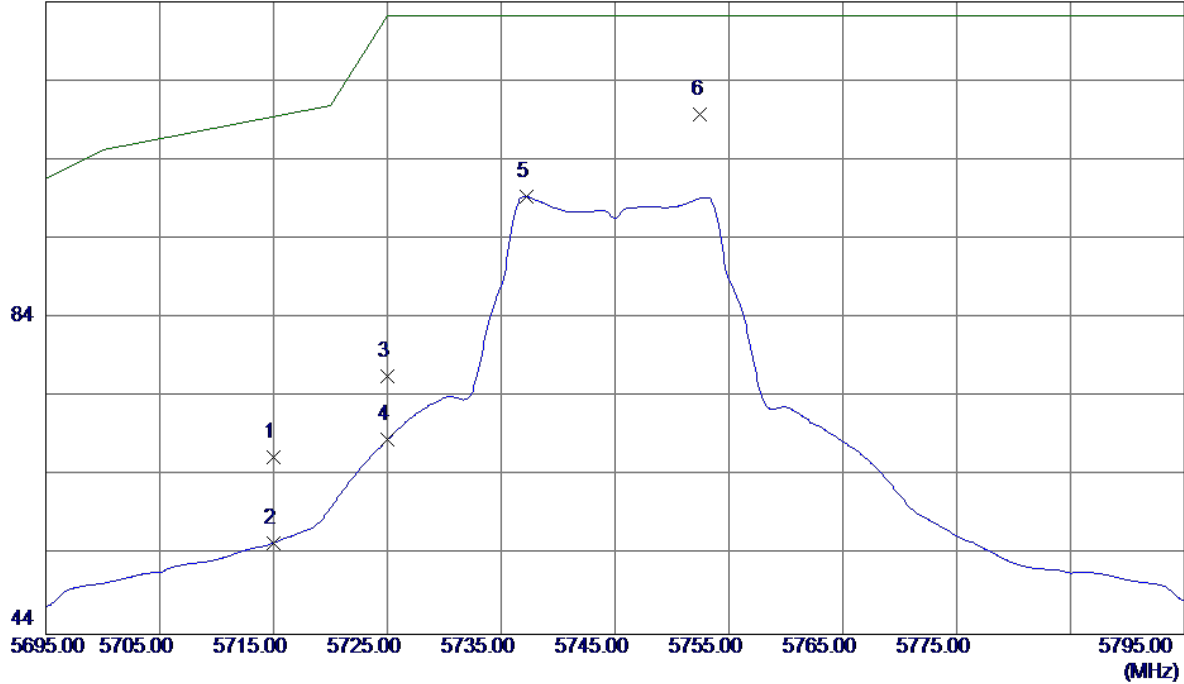

No.	Freq. MHz	Reading Level dBuV/m	Correct Factor dB	Measure ment dBuV/m	Limit dBuV/m	Margin dB	Detector	Comment
1	5715.0000	23.81	42.55	66.36	109.50	-43.14	Peak	
2	5715.0000	13.04	42.55	55.59	109.50	-53.91	AVG	
3	5725.0000	34.05	42.58	76.63	122.30	-45.67	Peak	
4	5725.0000	26.01	42.58	68.59	122.30	-53.71	AVG	
5	5737.2000	56.72	42.62	99.34	122.30	-22.96	AVG	
6 *	5752.5000	67.03	42.68	109.71	122.30	-12.59	Peak	

Orthogonal Axis:	X
Test Mode:	UNII-3/TX N20 Mode 5745MHz

Vertical

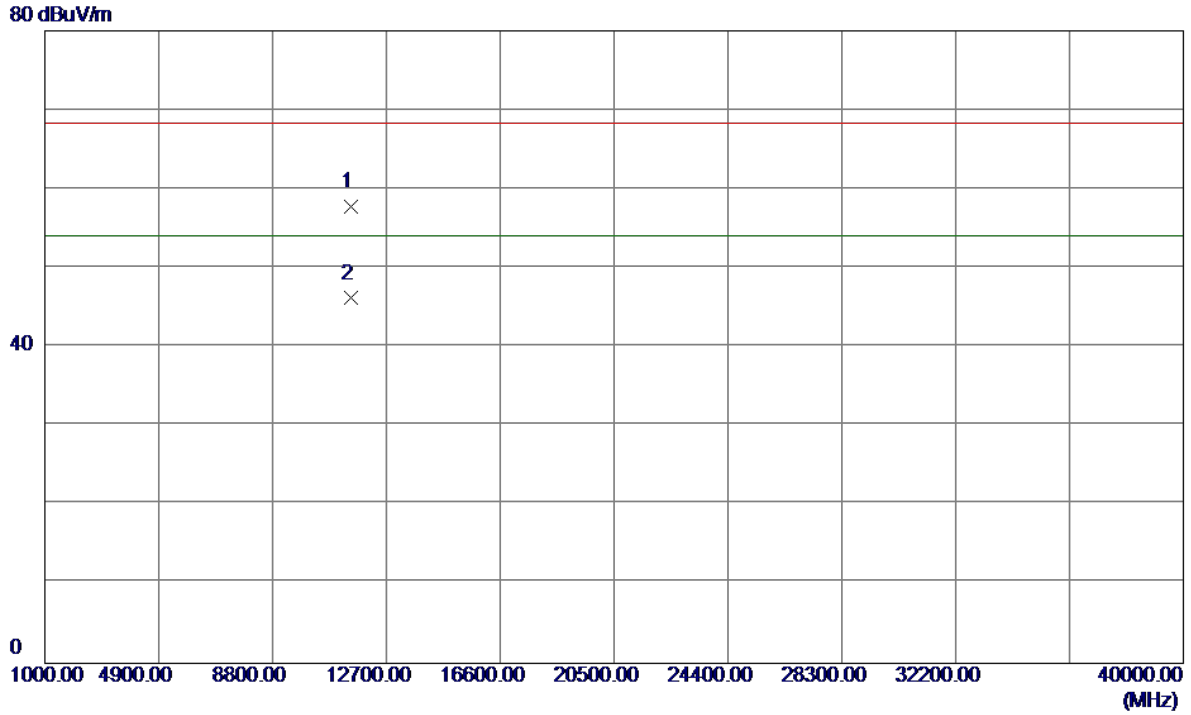

No.	Freq. MHz	Reading Level dBuV/m	Correct Factor dB	Measure ment dBuV/m	Limit dBuV/m	Margin dB	Detector	Comment
1	11489.4000	42.22	15.49	57.71	68.30	-10.59	Peak	
2 *	11489.6000	30.67	15.49	46.16	54.00	-7.84	AVG	

Orthogonal Axis:	X
Test Mode:	UNII-3/TX N20 Mode 5745MHz

Horizontal

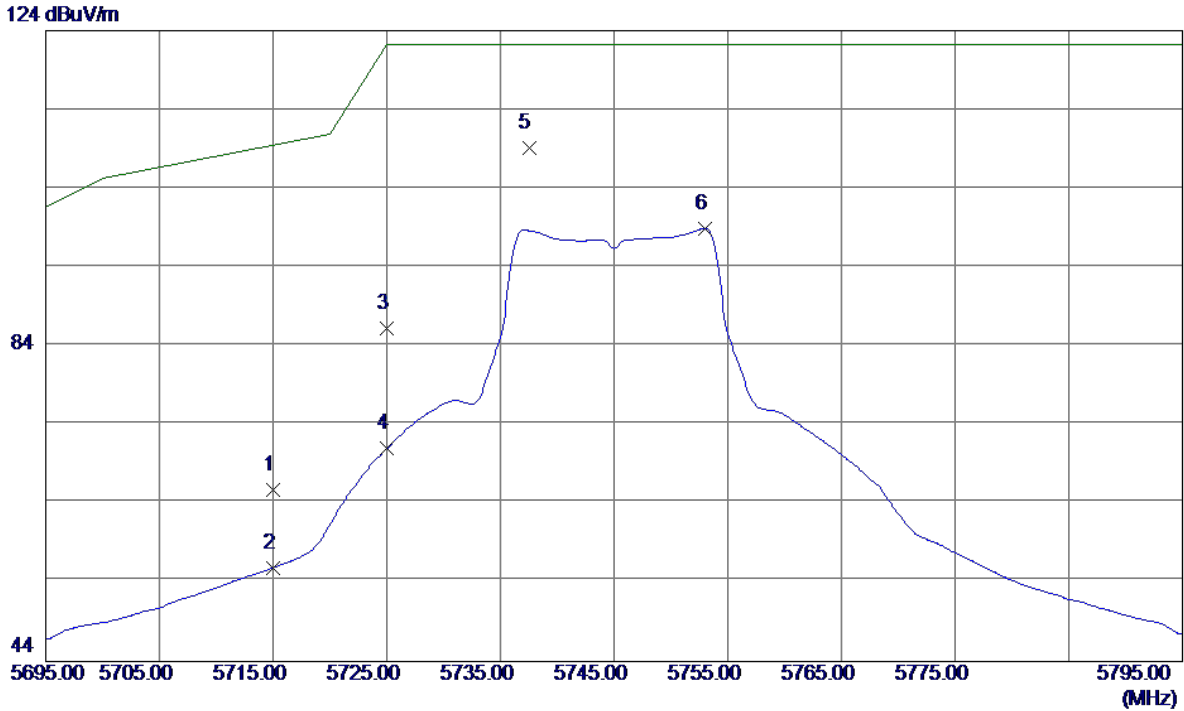

No.	Freq. MHz	Reading Level dBuV/m	Correct Factor dB	Measure ment dBuV/m	Limit dBuV/m	Margin dB	Detector	Comment
1	5715.0000	23.18	42.55	65.73	109.50	-43.77	Peak	
2	5715.0000	13.35	42.55	55.90	109.50	-53.60	AVG	
3	5725.0000	43.67	42.58	86.25	122.30	-36.05	Peak	
4	5725.0000	28.39	42.58	70.97	122.30	-51.33	AVG	
5 *	5737.5000	66.48	42.63	109.11	122.30	-13.19	Peak	
6	5753.0000	56.22	42.68	98.90	122.30	-23.40	AVG	

Orthogonal Axis:	X
Test Mode:	UNII-3/TX N20 Mode 5745MHz

Horizontal

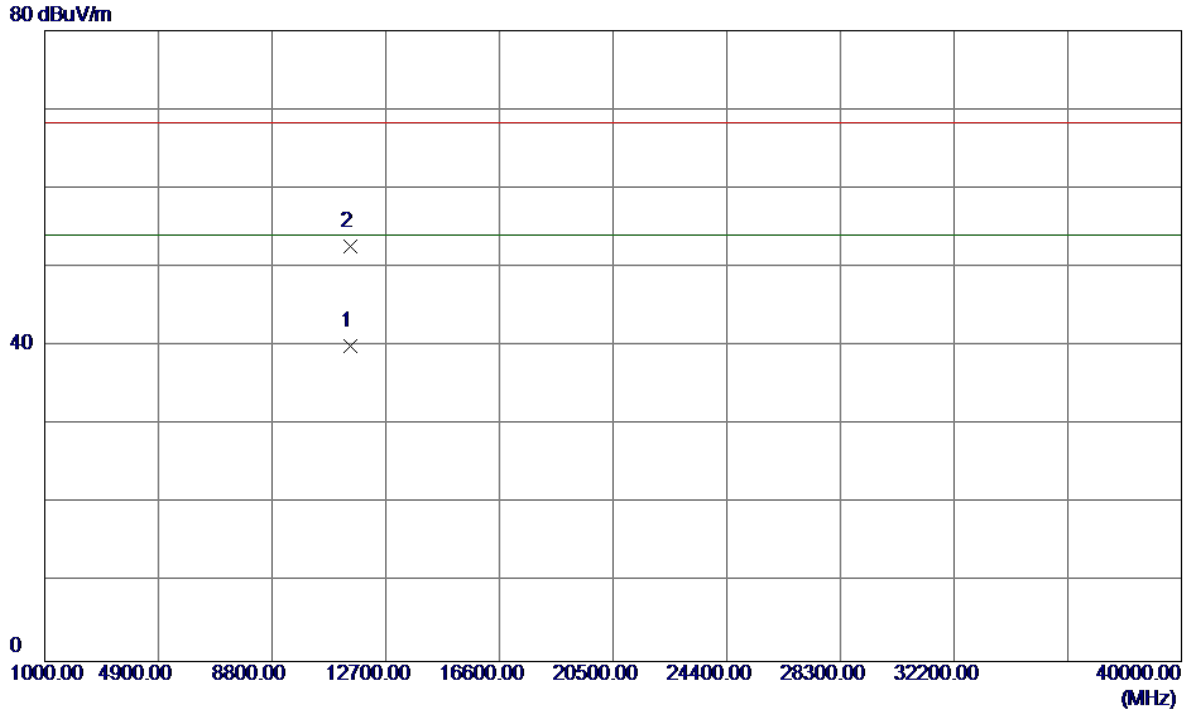

No.	Freq. MHz	Reading Level dBuV/m	Correct Factor dB	Measure ment dBuV/m	Limit dBuV/m	Margin dB	Detector	Comment
1 *	11489.4500	24.54	15.49	40.03	54.00	-13.97	AVG	
2	11490.2000	37.10	15.49	52.59	68.30	-15.71	Peak	

Orthogonal Axis:	X
Test Mode:	UNII-3/TX N20 Mode 5785MHz

Vertical

124 dBuV/m

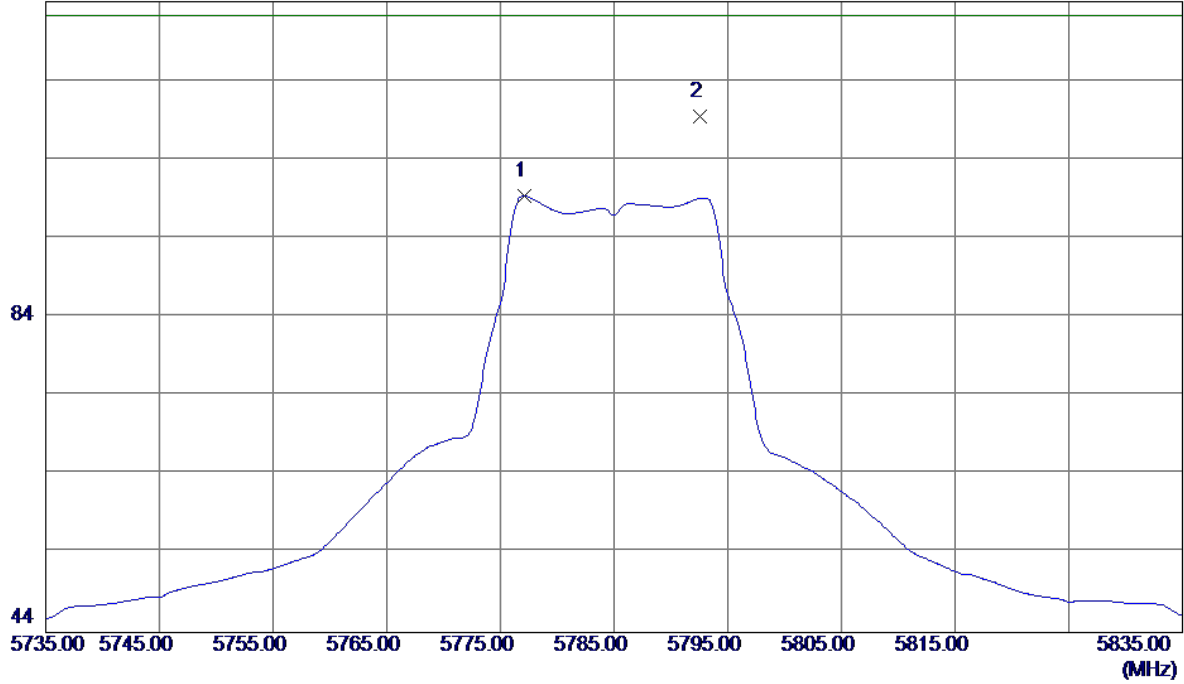

No.	Freq. MHz	Reading Level dBuV/m	Correct Factor dB	Measure ment dBuV/m	Limit dBuV/m	Margin dB	Detector	Comment
1	5777.1000	56.56	42.77	99.33	122.30	-22.97	AVG	
2 *	5792.6000	66.68	42.82	109.50	122.30	-12.80	Peak	

Orthogonal Axis:	X
Test Mode:	UNII-3/TX N20 Mode 5785MHz

Vertical

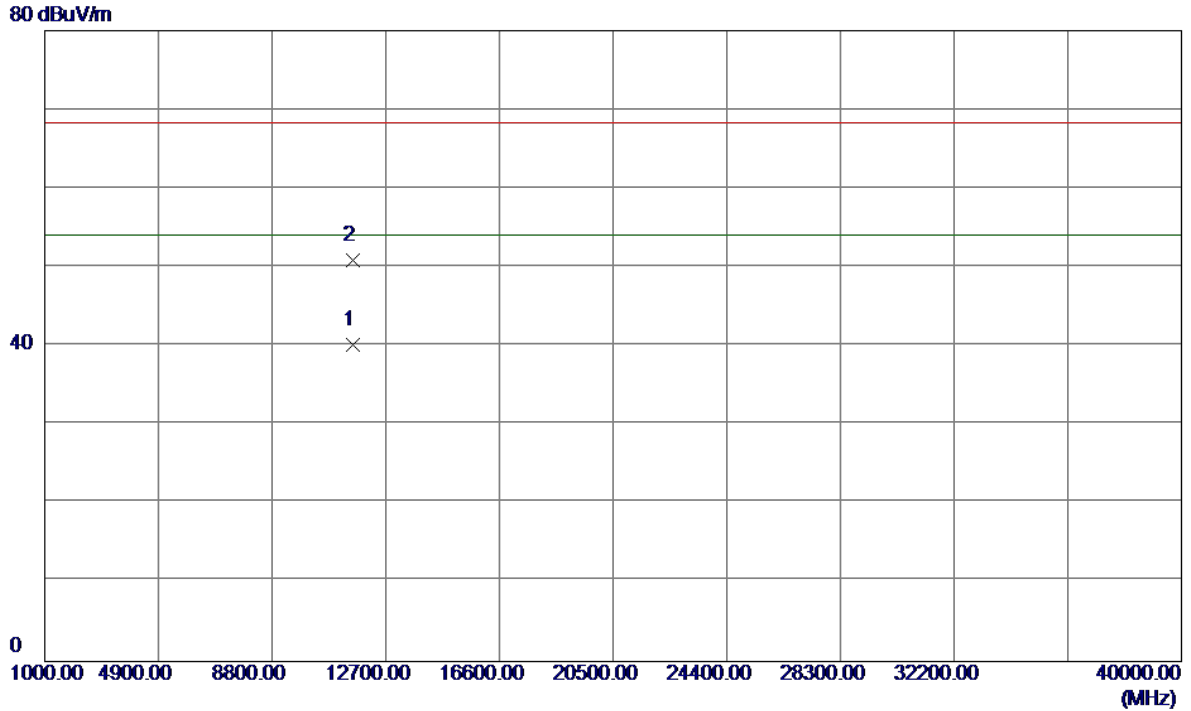

No.	Freq. MHz	Reading Level dBuV/m	Correct Factor dB	Measure ment dBuV/m	Limit dBuV/m	Margin dB	Detector	Comment
1 *	11569.8000	24.62	15.48	40.10	54.00	-13.90	AVG	
2	11571.8000	35.33	15.48	50.81	68.30	-17.49	Peak	

Orthogonal Axis:	X
Test Mode:	UNII-3/TX N20 Mode 5785MHz

Horizontal

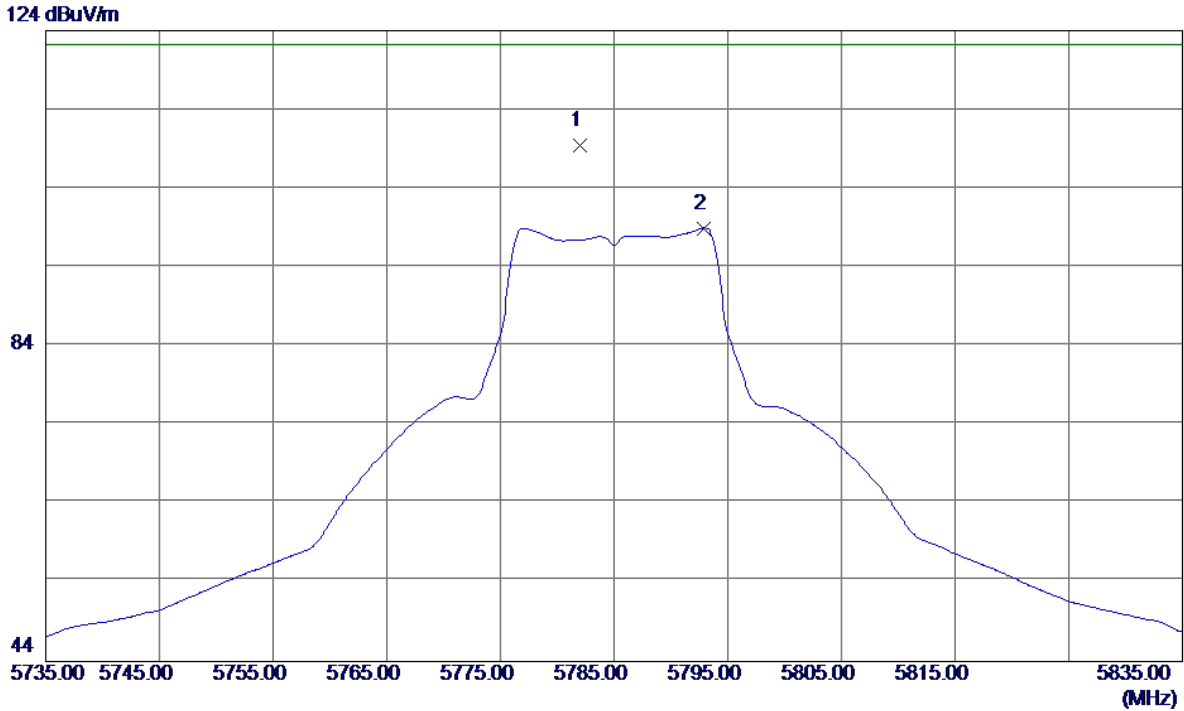

No.	Freq. MHz	Reading Level dBuV/m	Correct Factor dB	Measure ment dBuV/m	Limit dBuV/m	Margin dB	Detector	Comment
1 *	5782.0000	66.68	42.78	109.46	122.30	-12.84	Peak	
2	5792.9000	56.14	42.82	98.96	122.30	-23.34	AVG	

Orthogonal Axis:	X
Test Mode:	UNII-3/TX N20 Mode 5785MHz

Horizontal

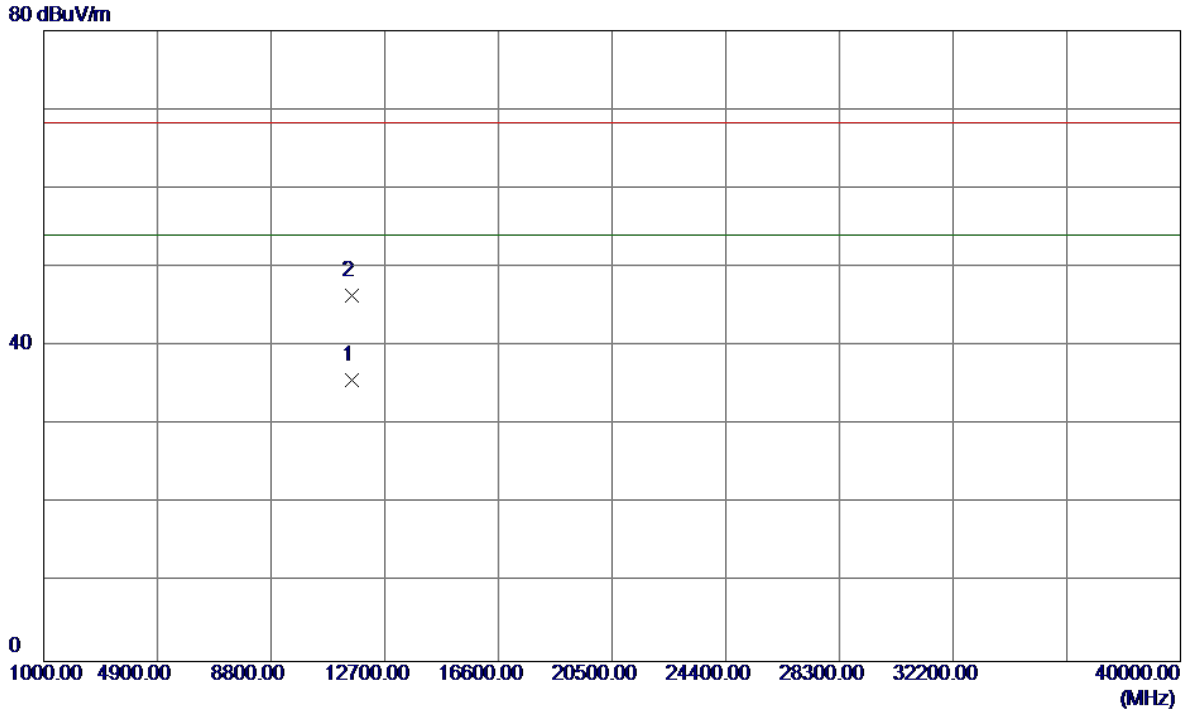

No.	Freq. MHz	Reading Level dBuV/m	Correct Factor dB	Measure ment dBuV/m	Limit dBuV/m	Margin dB	Detector	Comment
1 *	11568.7000	20.20	15.48	35.68	54.00	-18.32	AVG	
2	11570.3000	30.93	15.48	46.41	68.30	-21.89	Peak	

Orthogonal Axis:	X
Test Mode:	UNII-3/TX N20 Mode 5825MHz

Vertical

124 dBuV/m

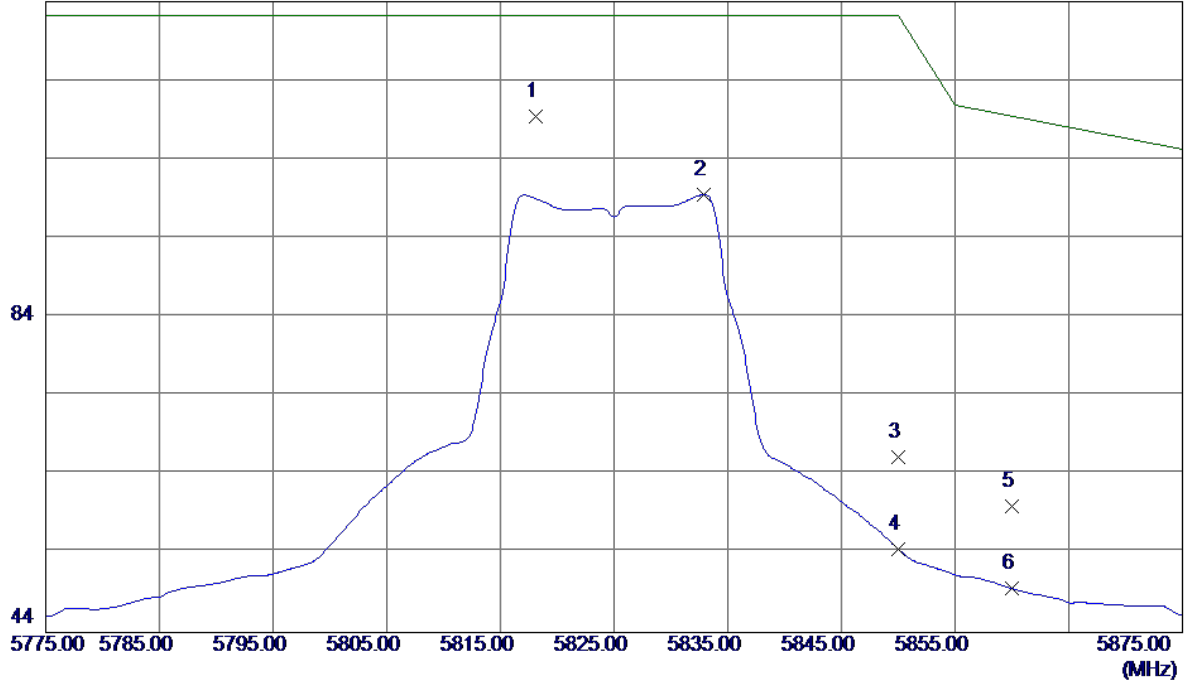

No.	Freq. MHz	Reading Level dBuV/m	Correct Factor dB	Measure ment dBuV/m	Limit dBuV/m	Margin dB	Detector	Comment
1 *	5818.1000	66.50	42.91	109.41	122.30	-12.89	Peak	
2	5832.9000	56.53	42.96	99.49	122.30	-22.81	AVG	
3	5850.0000	23.28	43.03	66.31	122.30	-55.99	Peak	
4	5850.0000	11.56	43.03	54.59	122.30	-67.71	AVG	
5	5860.0000	16.87	43.06	59.93	109.50	-49.57	Peak	
6	5860.0000	6.51	43.06	49.57	109.50	-59.93	AVG	

Orthogonal Axis:	X
Test Mode:	UNII-3/TX N20 Mode 5825MHz

Vertical

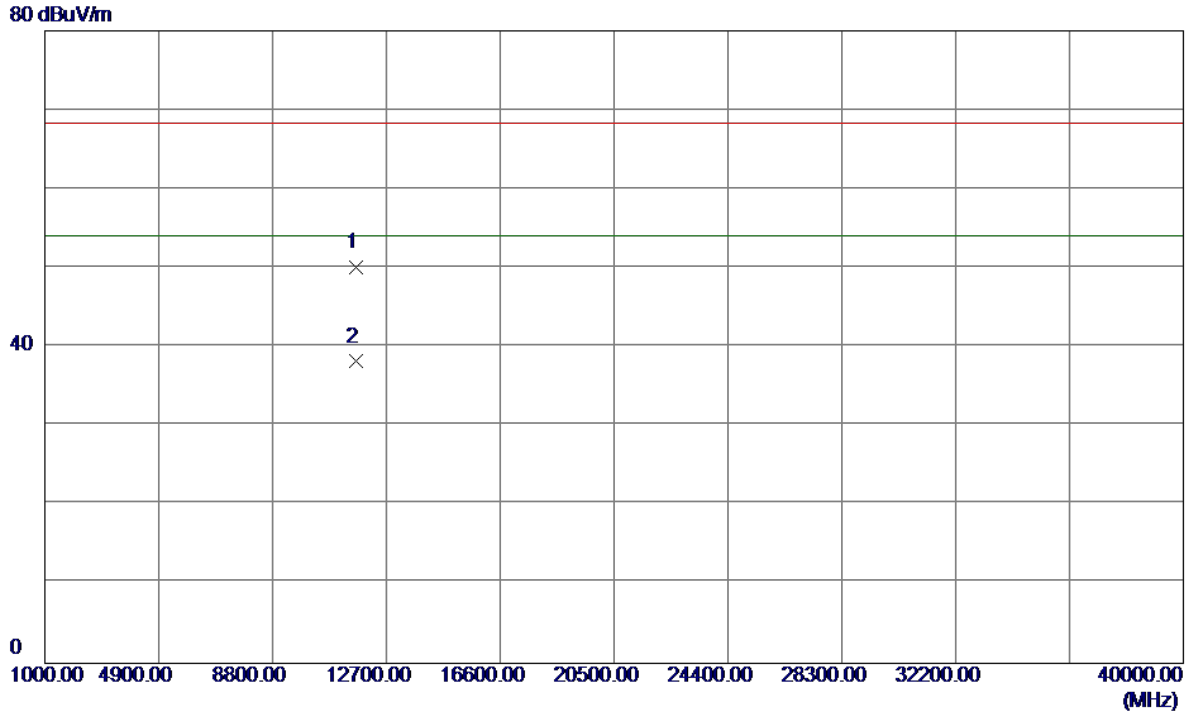

No.	Freq. MHz	Reading Level dBuV/m	Correct Factor dB	Measure ment dBuV/m	Limit dBuV/m	Margin dB	Detector	Comment
1	11648.8000	34.58	15.48	50.06	68.30	-18.24	Peak	
2 *	11649.8000	22.68	15.48	38.16	54.00	-15.84	AVG	

Orthogonal Axis:	X
Test Mode:	UNII-3/TX N20 Mode 5825MHz

Horizontal

124 dBuV/m

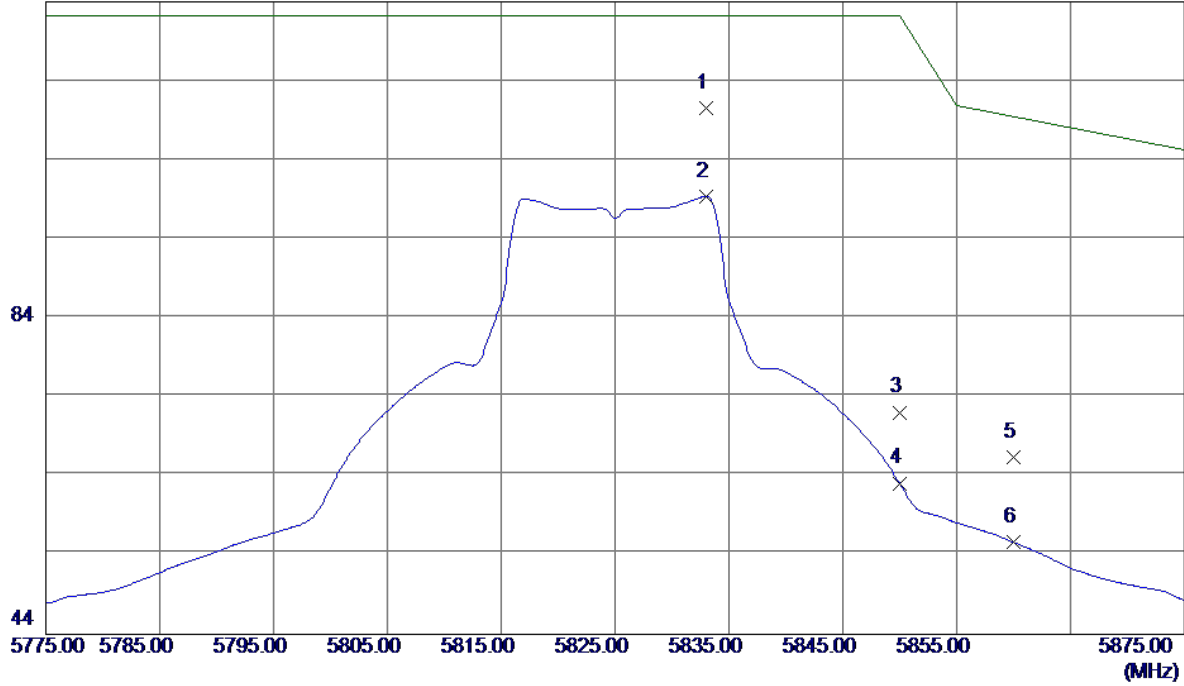

No.	Freq. MHz	Reading Level dBuV/m	Correct Factor dB	Measure ment dBuV/m	Limit dBuV/m	Margin dB	Detector	Comment
1 *	5833.0000	67.51	42.97	110.48	122.30	-11.82	Peak	
2	5833.0000	56.41	42.97	99.38	122.30	-22.92	AVG	
3	5850.0000	29.05	43.03	72.08	122.30	-50.22	Peak	
4	5850.0000	20.09	43.03	63.12	122.30	-59.18	AVG	
5	5860.0000	23.28	43.06	66.34	109.50	-43.16	Peak	
6	5860.0000	12.59	43.06	55.65	109.50	-53.85	AVG	

Orthogonal Axis:	X
Test Mode:	UNII-3/TX N20 Mode 5825MHz

Horizontal

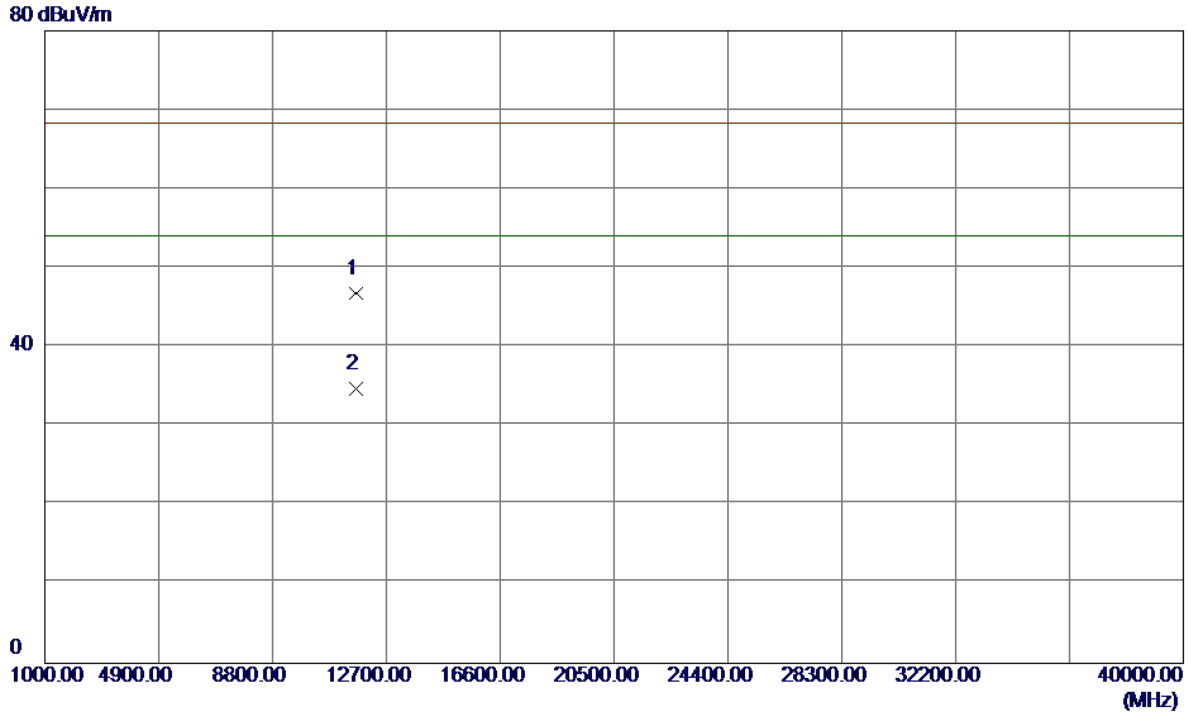

No.	Freq. MHz	Reading Level dBuV/m	Correct Factor dB	Measure ment dBuV/m	Limit dBuV/m	Margin dB	Detector	Comment
1	11649.5000	31.32	15.48	46.80	68.30	-21.50	Peak	
2 *	11650.8000	19.27	15.48	34.75	54.00	-19.25	AVG	

Orthogonal Axis:	X
Test Mode:	UNII-3/TX N40 Mode 5755MHz

Vertical

124 dBuV/m

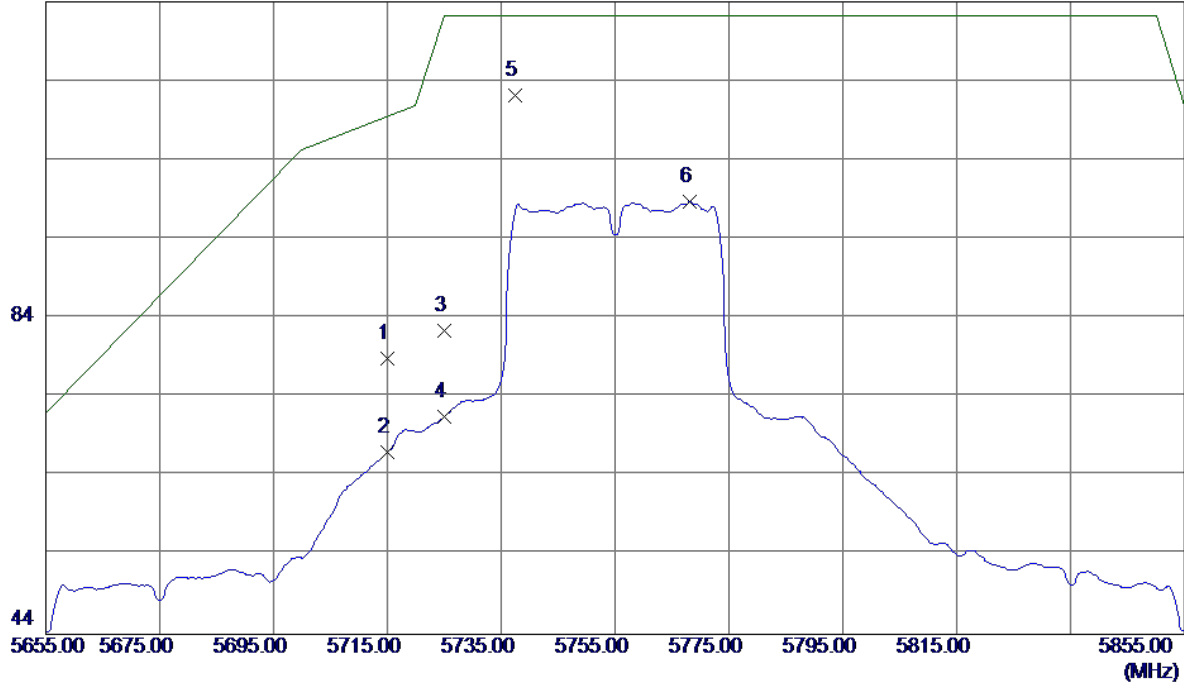

No.	Freq. MHz	Reading Level dBuV/m	Correct Factor dB	Measure ment dBuV/m	Limit dBuV/m	Margin dB	Detector	Comment
1	5715.0000	36.36	42.55	78.91	109.50	-30.59	Peak	
2	5715.0000	24.43	42.55	66.98	109.50	-42.52	AVG	
3	5725.0000	39.82	42.58	82.40	122.30	-39.90	Peak	
4	5725.0000	28.88	42.58	71.46	122.30	-50.84	AVG	
5 *	5737.4000	69.51	42.62	112.13	122.30	-10.17	Peak	
6	5768.2000	55.94	42.73	98.67	122.30	-23.63	AVG	

Orthogonal Axis:	X
Test Mode:	UNII-3/TX N40 Mode 5755MHz

Vertical

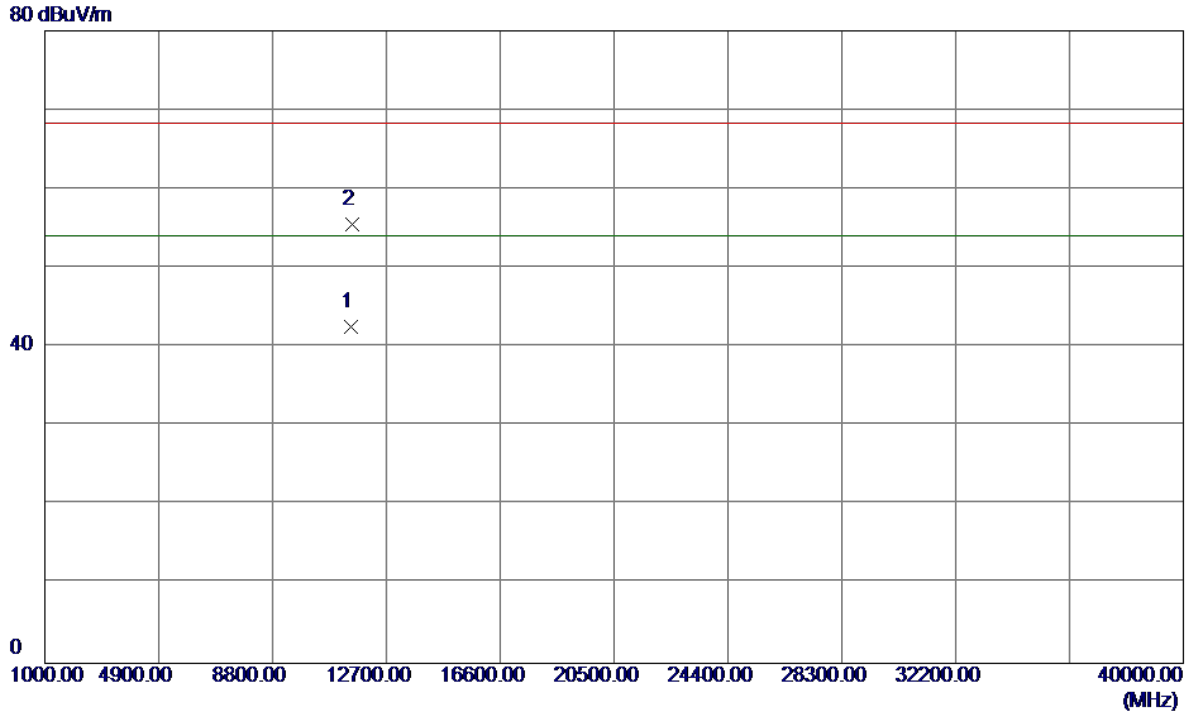

No.	Freq. MHz	Reading Level dBuV/m	Correct Factor dB	Measure ment dBuV/m	Limit dBuV/m	Margin dB	Detector	Comment
1 *	11508.2000	27.10	15.48	42.58	54.00	-11.42	AVG	
2	11509.8000	39.97	15.48	55.45	68.30	-12.85	Peak	

Orthogonal Axis:	X
Test Mode:	UNII-3/TX N40 Mode 5755MHz

Horizontal

124 dBuV/m

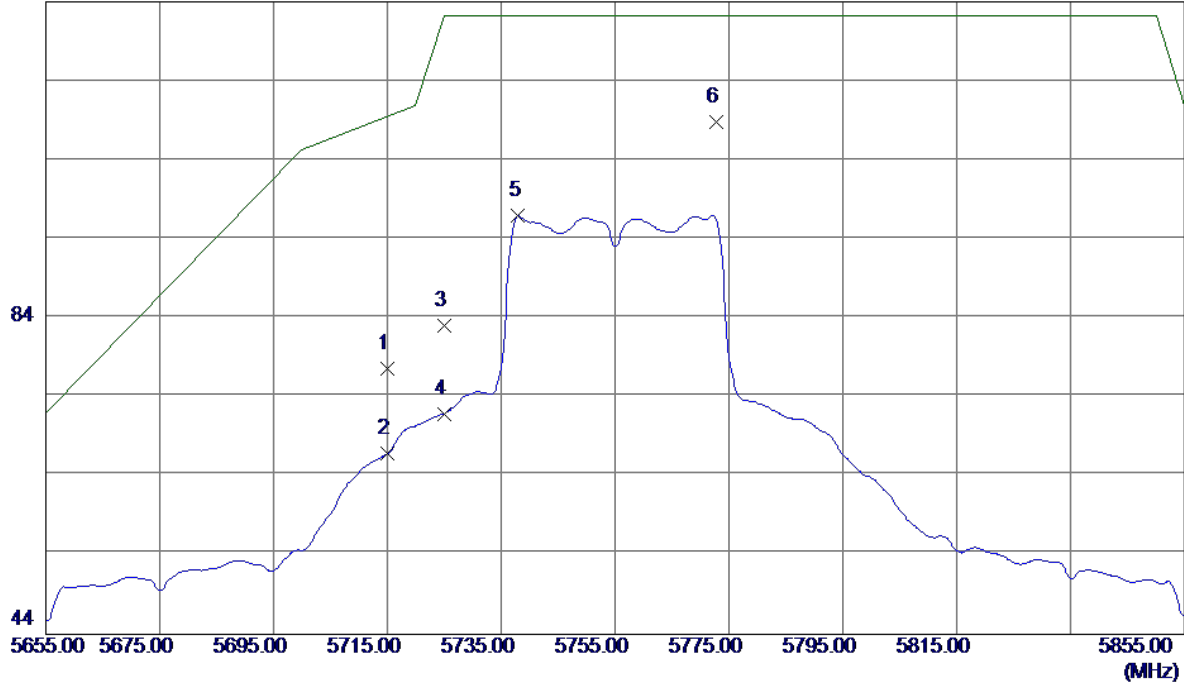

No.	Freq. MHz	Reading Level dBuV/m	Correct Factor dB	Measure ment dBuV/m	Limit dBuV/m	Margin dB	Detector	Comment
1	5715.0000	35.05	42.55	77.60	109.50	-31.90	Peak	
2	5715.0000	24.30	42.55	66.85	109.50	-42.65	AVG	
3	5725.0000	40.50	42.58	83.08	122.30	-39.22	Peak	
4	5725.0000	29.33	42.58	71.91	122.30	-50.39	AVG	
5	5738.0000	54.35	42.63	96.98	122.30	-25.32	AVG	
6 *	5772.8000	66.08	42.75	108.83	122.30	-13.47	Peak	

Orthogonal Axis:	X
Test Mode:	UNII-3/TX N40 Mode 5755MHz

Horizontal

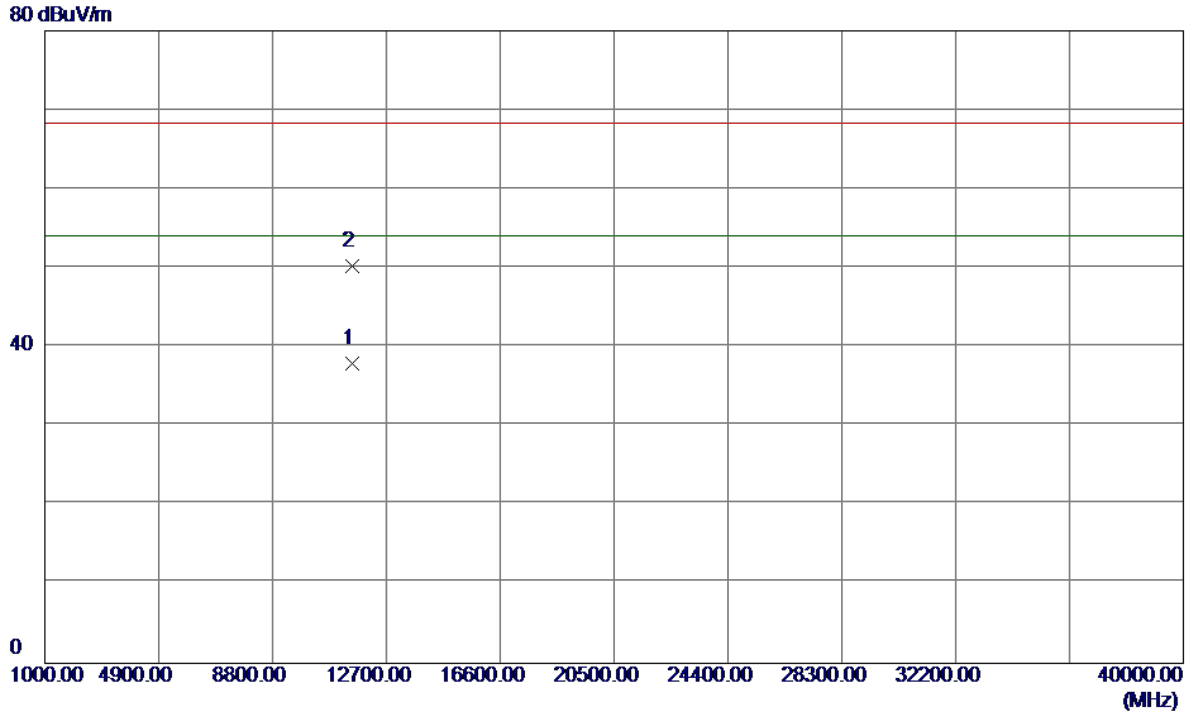

No.	Freq. MHz	Reading Level dBuV/m	Correct Factor dB	Measure ment dBuV/m	Limit dBuV/m	Margin dB	Detector	Comment
1 *	11508.9000	22.39	15.48	37.87	54.00	-16.13	AVG	
2	11509.9000	34.71	15.48	50.19	68.30	-18.11	Peak	

Orthogonal Axis:	X
Test Mode:	UNII-3/TX N40 Mode 5795MHz

Vertical

124 dBuV/m

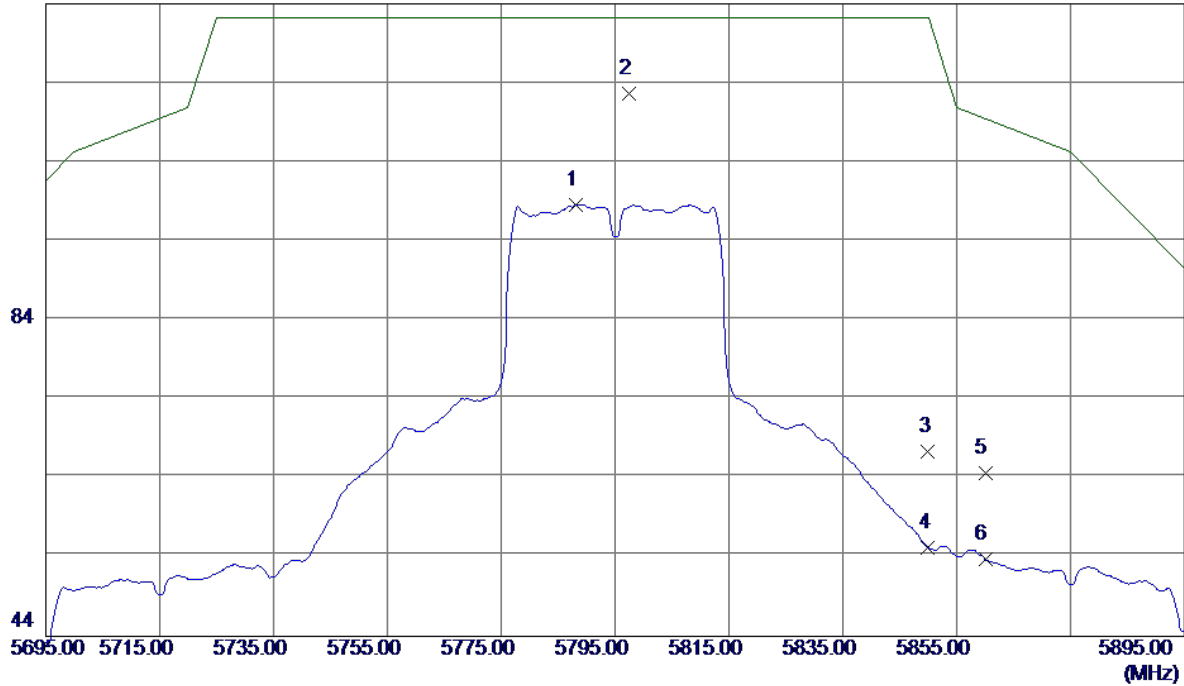

No.	Freq. MHz	Reading Level dBuV/m	Correct Factor dB	Measure ment dBuV/m	Limit dBuV/m	Margin dB	Detector	Comment
1	5788.2000	55.77	42.81	98.58	122.30	-23.72	AVG	
2 *	5797.4000	69.73	42.84	112.57	122.30	-9.73	Peak	
3	5850.0000	24.32	43.03	67.35	122.30	-54.95	Peak	
4	5850.0000	12.23	43.03	55.26	122.30	-67.04	AVG	
5	5860.0000	21.59	43.06	64.65	109.50	-44.85	Peak	
6	5860.0000	10.74	43.06	53.80	109.50	-55.70	AVG	

Orthogonal Axis:	X
Test Mode:	UNII-3/TX N40 Mode 5795MHz

Vertical

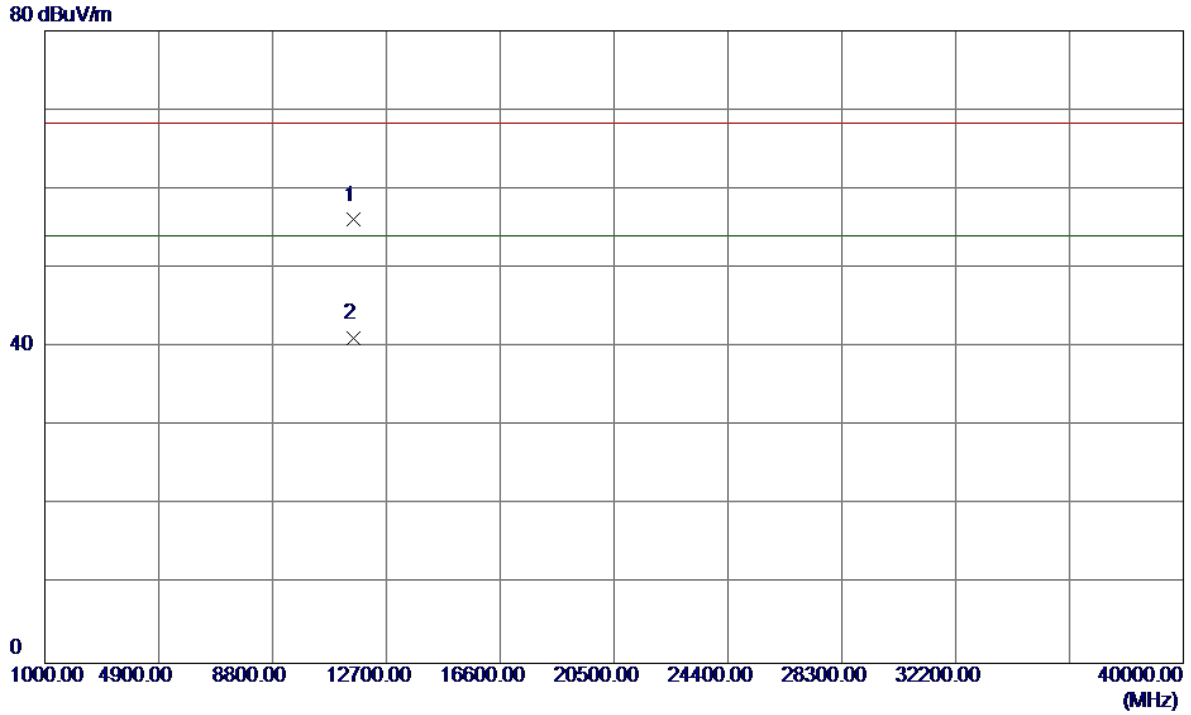

No.	Freq. MHz	Reading Level dBuV/m	Correct Factor dB	Measure ment dBuV/m	Limit dBuV/m	Margin dB	Detector	Comment
1 *	11588.8000	40.60	15.48	56.08	68.30	-12.22	Peak	
2	11589.6000	25.61	15.48	41.09	54.00	-12.91	AVG	

Orthogonal Axis:	X
Test Mode:	UNII-3/TX N40 Mode 5795MHz

Horizontal

124 dBuV/m

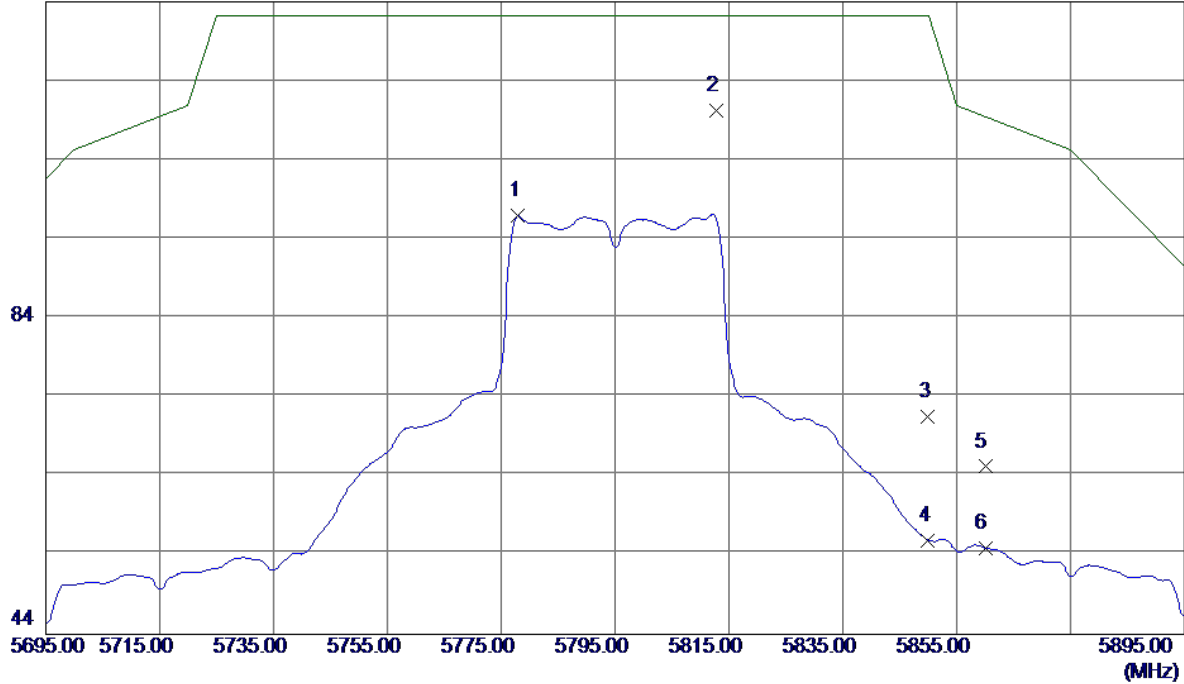

No.	Freq. MHz	Reading Level dBuV/m	Correct Factor dB	Measure ment dBuV/m	Limit dBuV/m	Margin dB	Detector	Comment
1	5778.0000	54.26	42.77	97.03	122.30	-25.27	AVG	
2 *	5812.8000	67.40	42.89	110.29	122.30	-12.01	Peak	
3	5850.0000	28.47	43.03	71.50	122.30	-50.80	Peak	
4	5850.0000	12.80	43.03	55.83	122.30	-66.47	AVG	
5	5860.0000	22.14	43.06	65.20	109.50	-44.30	Peak	
6	5860.0000	11.88	43.06	54.94	109.50	-54.56	AVG	

Orthogonal Axis:	X
Test Mode:	UNII-3/TX N40 Mode 5795MHz

Horizontal

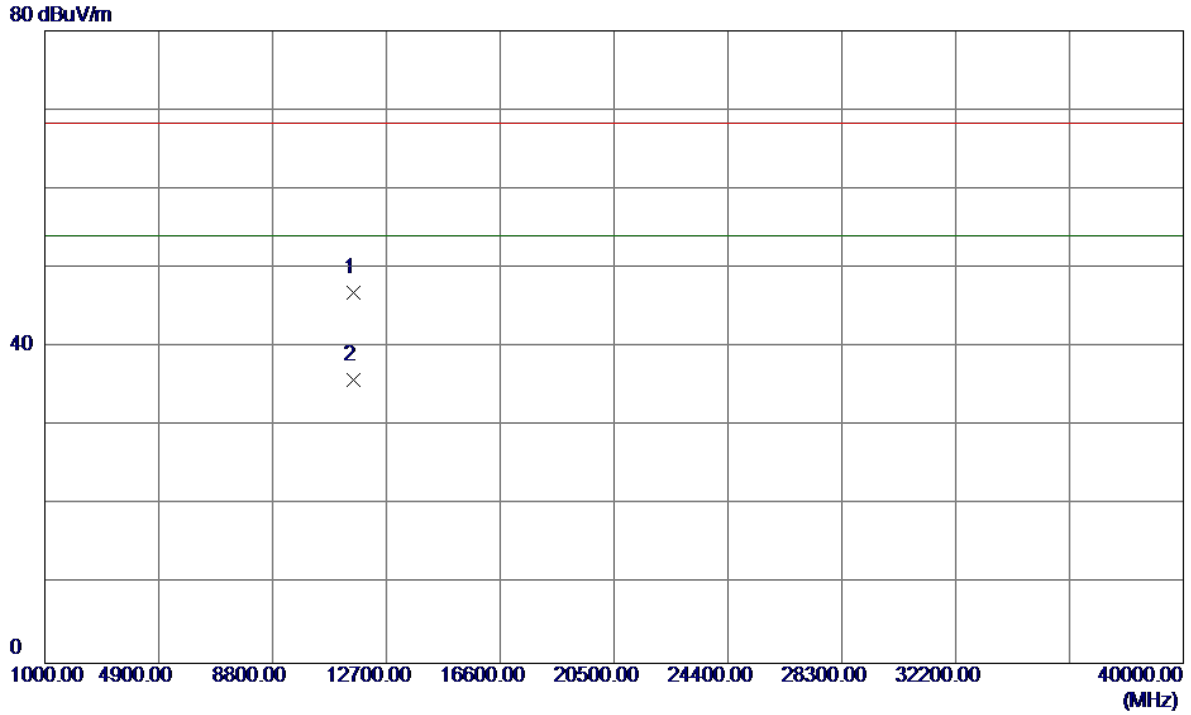

No.	Freq. MHz	Reading Level dBuV/m	Correct Factor dB	Measure ment dBuV/m	Limit dBuV/m	Margin dB	Detector	Comment
1	11588.8000	31.46	15.48	46.94	68.30	-21.36	Peak	
2 *	11590.0000	20.39	15.48	35.87	54.00	-18.13	AVG	

Orthogonal Axis:	X
Test Mode:	UNII-1/ TX AC20 Mode 5180MHz

Vertical

115 dBuV/m

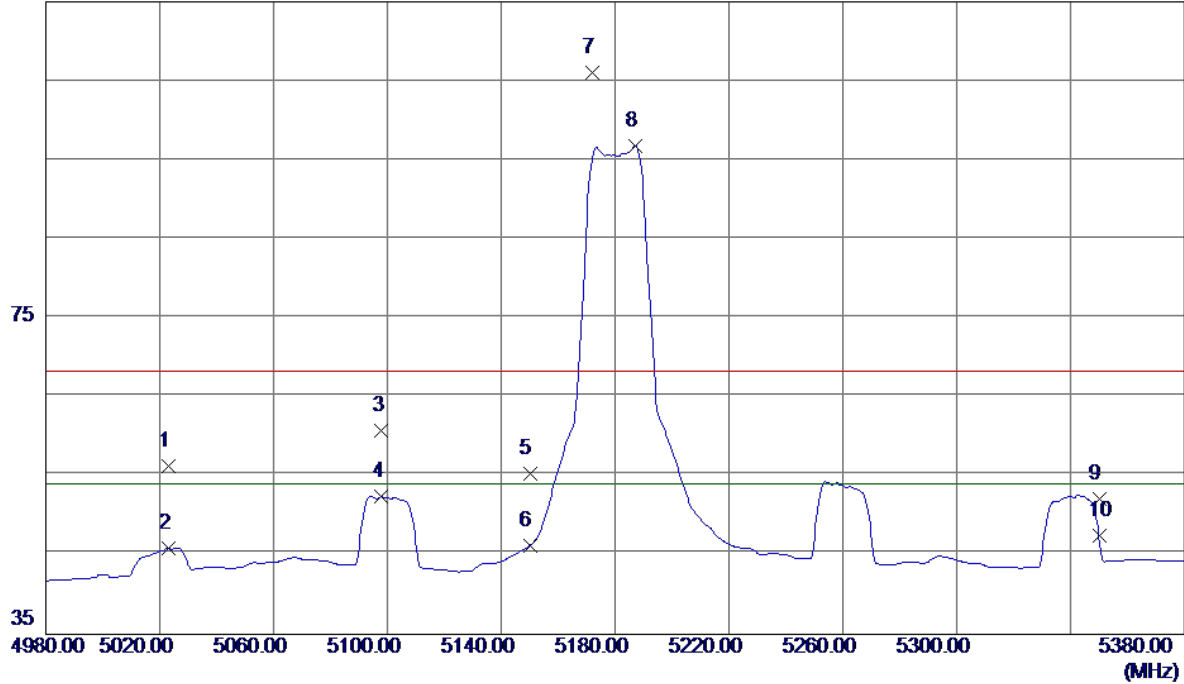

No.	Freq. MHz	Reading Level dBuV/m	Correct Factor dB	Measure ment dBuV/m	Limit dBuV/m	Margin dB	Detector	Comment
1	5023.2000	16.06	40.21	56.27	68.30	-12.03	Peak	
2	5023.2000	5.62	40.21	45.83	54.00	-8.17	AVG	
3	5098.0000	20.35	40.45	60.80	68.30	-7.50	Peak	
4	5098.0000	11.96	40.45	52.41	54.00	-1.59	AVG	
5	5150.0000	14.67	40.62	55.29	68.30	-13.01	Peak	
6	5150.0000	5.56	40.62	46.18	54.00	-7.82	AVG	
7	5172.0000	65.27	40.70	105.97	68.30	37.67	Peak	No Limit
8 *	5187.2000	56.08	40.75	96.83	54.00	42.83	AVG	No Limit
9	5350.0000	10.79	41.28	52.07	68.30	-16.23	Peak	
10	5350.0000	6.19	41.28	47.47	54.00	-6.53	AVG	

Orthogonal Axis:	X
Test Mode:	UNII-1/ TX AC20 Mode 5180MHz

Vertical

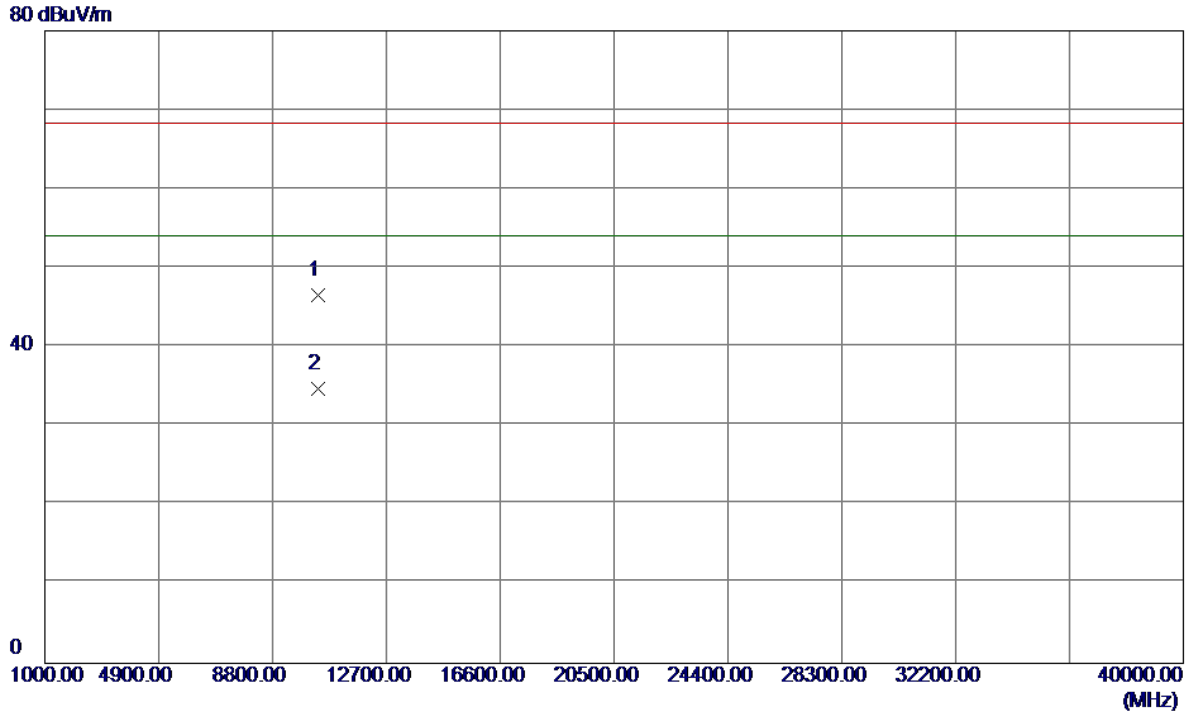

No.	Freq. MHz	Reading Level dBuV/m	Correct Factor dB	Measure ment dBuV/m	Limit dBuV/m	Margin dB	Detector	Comment
1	10357.2000	31.54	14.96	46.50	68.30	-21.80	Peak	
2 *	10360.5000	19.69	14.96	34.65	54.00	-19.35	AVG	

Orthogonal Axis:	X
Test Mode:	UNII-1/ TX AC20 Mode 5180MHz

Horizontal

115 dBuV/m

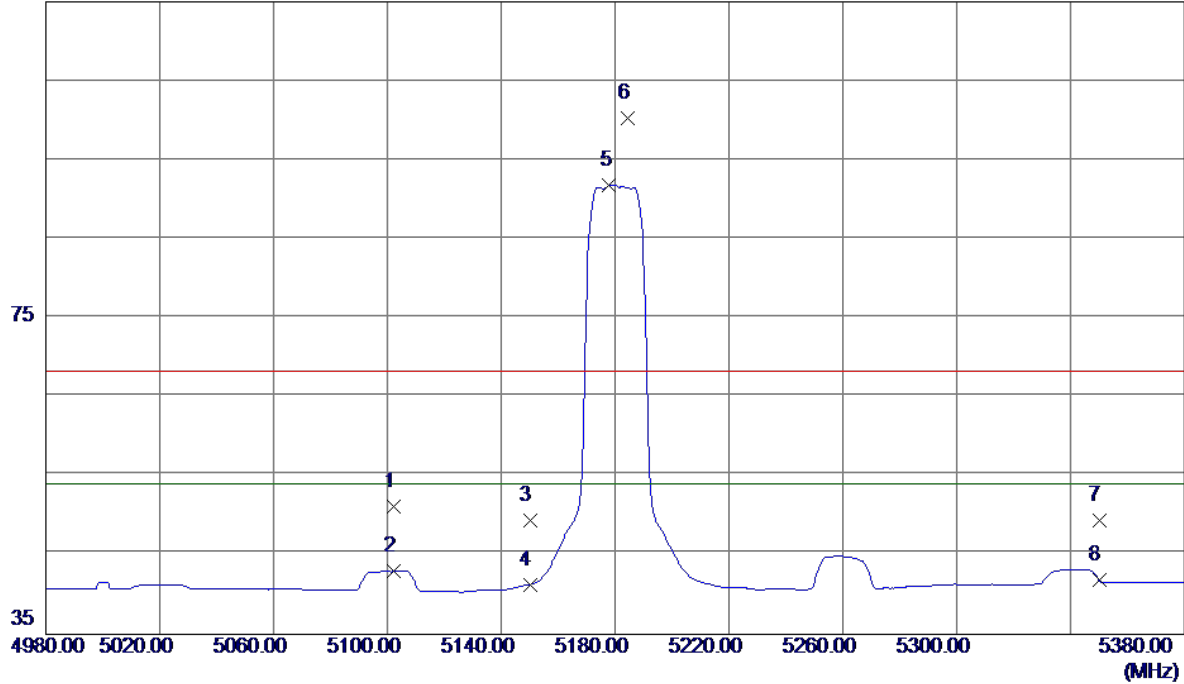

No.	Freq. MHz	Reading Level dBuV/m	Correct Factor dB	Measure ment dBuV/m	Limit dBuV/m	Margin dB	Detector	Comment
1	5102.4000	10.64	40.47	51.11	68.30	-17.19	Peak	
2	5102.4000	2.57	40.47	43.04	54.00	-10.96	AVG	
3	5150.0000	8.77	40.62	49.39	68.30	-18.91	Peak	
4	5150.0000	0.65	40.62	41.27	54.00	-12.73	AVG	
5 *	5178.0000	51.11	40.72	91.83	54.00	37.83	AVG	No Limit
6	5184.4000	59.52	40.74	100.26	68.30	31.96	Peak	No Limit
7	5350.0000	8.16	41.28	49.44	68.30	-18.86	Peak	
8	5350.0000	0.66	41.28	41.94	54.00	-12.06	AVG	

Orthogonal Axis:	X
Test Mode:	UNII-1/ TX AC20 Mode 5180MHz

Horizontal

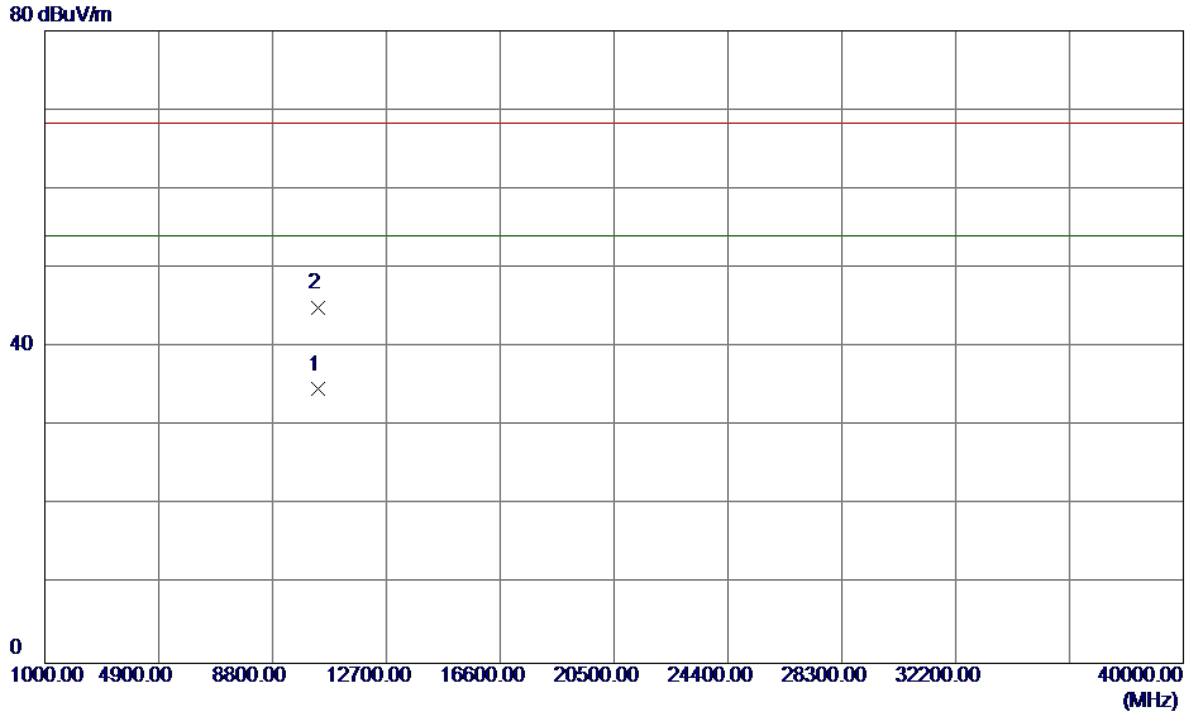

No.	Freq. MHz	Reading Level dBuV/m	Correct Factor dB	Measure ment dBuV/m	Limit dBuV/m	Margin dB	Detector	Comment
1 *	10359.8000	19.68	14.96	34.64	54.00	-19.36	AVG	
2	10360.4000	29.99	14.96	44.95	68.30	-23.35	Peak	

Orthogonal Axis:	X
Test Mode:	UNII-1/ TX AC20 Mode 5200MHz

Vertical

115 dBuV/m

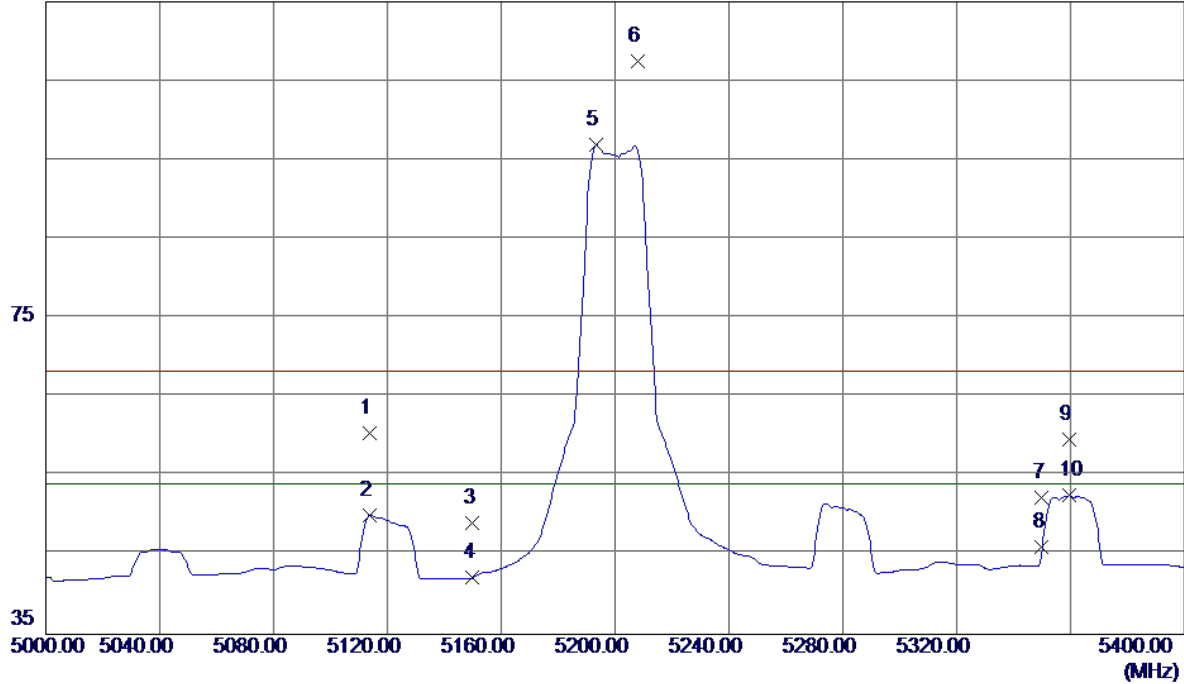

No.	Freq. MHz	Reading Level dBuV/m	Correct Factor dB	Measure ment dBuV/m	Limit dBuV/m	Margin dB	Detector	Comment
1	5113.6000	19.96	40.50	60.46	68.30	-7.84	Peak	
2	5113.6000	9.53	40.50	50.03	54.00	-3.97	AVG	
3	5150.0000	8.48	40.62	49.10	68.30	-19.20	Peak	
4	5150.0000	1.51	40.62	42.13	54.00	-11.87	AVG	
5 *	5193.2000	56.10	40.77	96.87	54.00	42.87	AVG	No Limit
6	5208.0000	66.65	40.82	107.47	68.30	39.17	Peak	No Limit
7	5350.0000	11.02	41.28	52.30	68.30	-16.00	Peak	
8	5350.0000	4.72	41.28	46.00	54.00	-8.00	AVG	
9	5359.6000	18.27	41.32	59.59	68.30	-8.71	Peak	
10	5359.6000	11.21	41.32	52.53	54.00	-1.47	AVG	

Orthogonal Axis:	X
Test Mode:	UNII-1/ TX AC20 Mode 5200MHz

Vertical

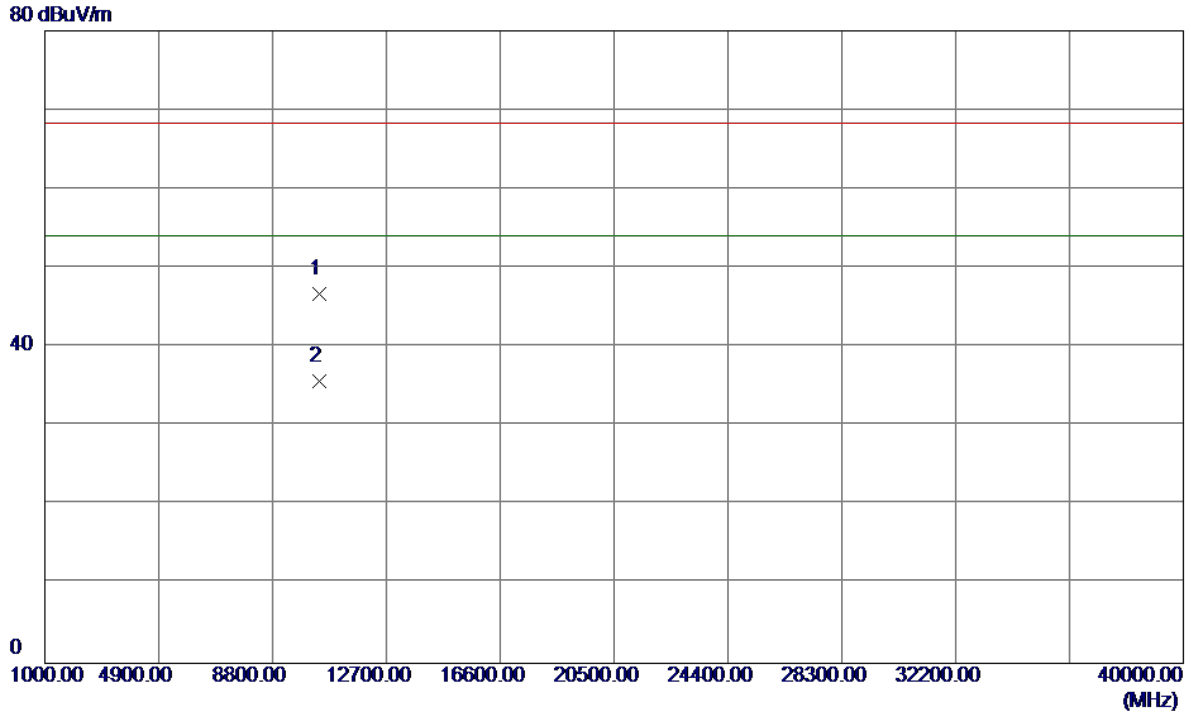

No.	Freq. MHz	Reading Level dBuV/m	Correct Factor dB	Measure ment dBuV/m	Limit dBuV/m	Margin dB	Detector	Comment
1	10398.9000	31.61	15.05	46.66	68.30	-21.64	Peak	
2 *	10400.7000	20.57	15.06	35.63	54.00	-18.37	AVG	

Orthogonal Axis:	X
Test Mode:	UNII-1/ TX AC20 Mode 5200MHz

Horizontal

115 dBuV/m

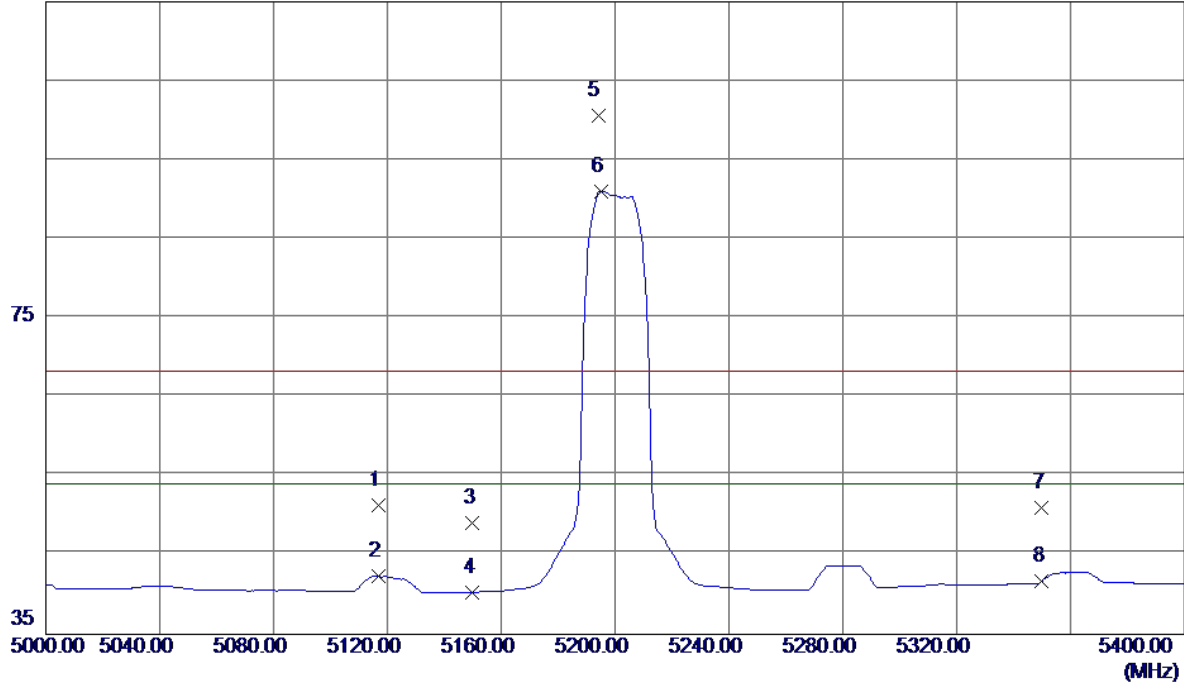

No.	Freq. MHz	Reading Level dBuV/m	Correct Factor dB	Measure ment dBuV/m	Limit dBuV/m	Margin dB	Detector	Comment
1	5116.8000	10.81	40.52	51.33	68.30	-16.97	Peak	
2	5116.8000	1.79	40.52	42.31	54.00	-11.69	AVG	
3	5150.0000	8.44	40.62	49.06	68.30	-19.24	Peak	
4	5150.0000	-0.29	40.62	40.33	54.00	-13.67	AVG	
5	5194.0000	59.88	40.77	100.65	68.30	32.35	Peak	No Limit
6 *	5195.2000	50.21	40.77	90.98	54.00	36.98	AVG	No Limit
7	5350.0000	9.76	41.28	51.04	68.30	-17.26	Peak	
8	5350.0000	0.47	41.28	41.75	54.00	-12.25	AVG	

Orthogonal Axis:	X
Test Mode:	UNII-1/ TX AC20 Mode 5200MHz

Horizontal

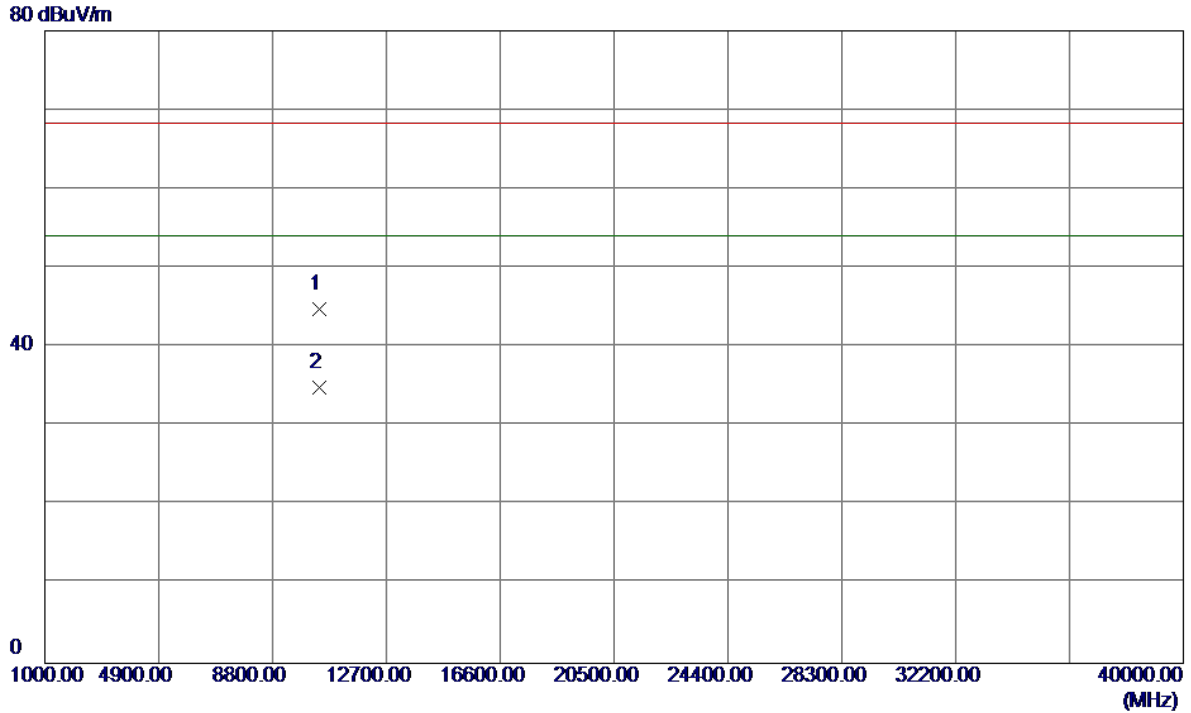

No.	Freq. MHz	Reading Level dBuV/m	Correct Factor dB	Measure ment dBuV/m	Limit dBuV/m	Margin dB	Detector	Comment
1	10399.6000	29.68	15.06	44.74	68.30	-23.56	Peak	
2 *	10402.0000	19.89	15.06	34.95	54.00	-19.05	AVG	

Orthogonal Axis:	X
Test Mode:	UNII-1/ TX AC20 Mode 5240MHz

Vertical

115 dBuV/m

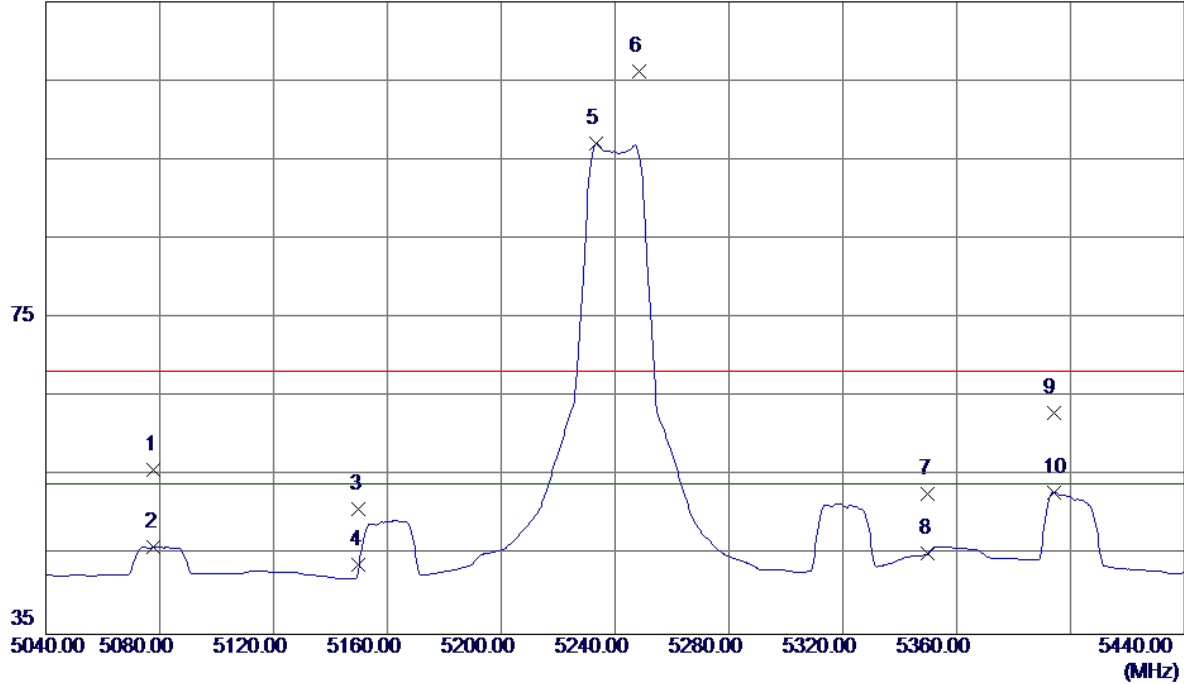

No.	Freq. MHz	Reading Level dBuV/m	Correct Factor dB	Measure ment dBuV/m	Limit dBuV/m	Margin dB	Detector	Comment
1	5078.0000	15.40	40.39	55.79	68.30	-12.51	Peak	
2	5078.0000	5.69	40.39	46.08	54.00	-7.92	AVG	
3	5150.0000	10.21	40.62	50.83	68.30	-17.47	Peak	
4	5150.0000	3.15	40.62	43.77	54.00	-10.23	AVG	
5 *	5233.2000	56.20	40.90	97.10	54.00	43.10	AVG	No Limit
6	5248.4000	65.20	40.95	106.15	68.30	37.85	Peak	No Limit
7	5350.0000	11.47	41.28	52.75	68.30	-15.55	Peak	
8	5350.0000	3.97	41.28	45.25	54.00	-8.75	AVG	
9	5394.0000	21.64	41.43	63.07	68.30	-5.23	Peak	
10	5394.0000	11.52	41.43	52.95	54.00	-1.05	AVG	

Orthogonal Axis:	X
Test Mode:	UNII-1/ TX AC20 Mode 5240MHz

Vertical

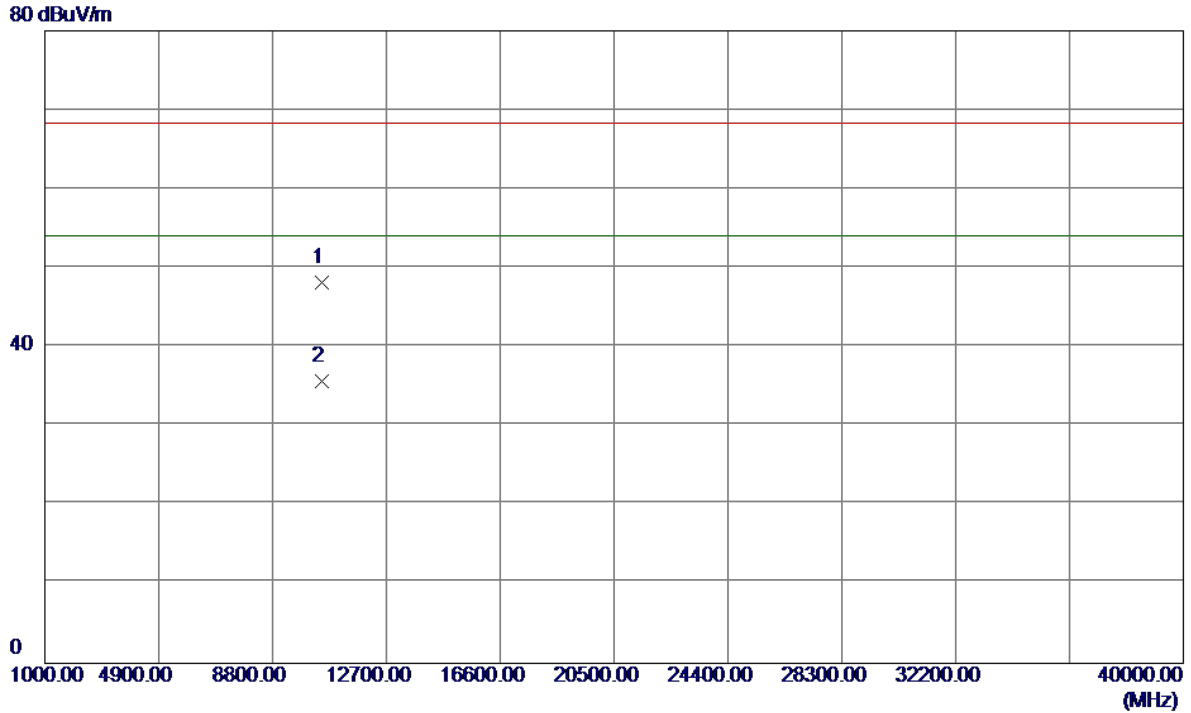

No.	Freq. MHz	Reading Level dBuV/m	Correct Factor dB	Measure ment dBuV/m	Limit dBuV/m	Margin dB	Detector	Comment
1	10481.1000	32.90	15.25	48.15	68.30	-20.15	Peak	
2 *	10481.3000	20.42	15.25	35.67	54.00	-18.33	AVG	

Orthogonal Axis:	X
Test Mode:	UNII-1/ TX AC20 Mode 5240MHz

Horizontal

115 dBuV/m

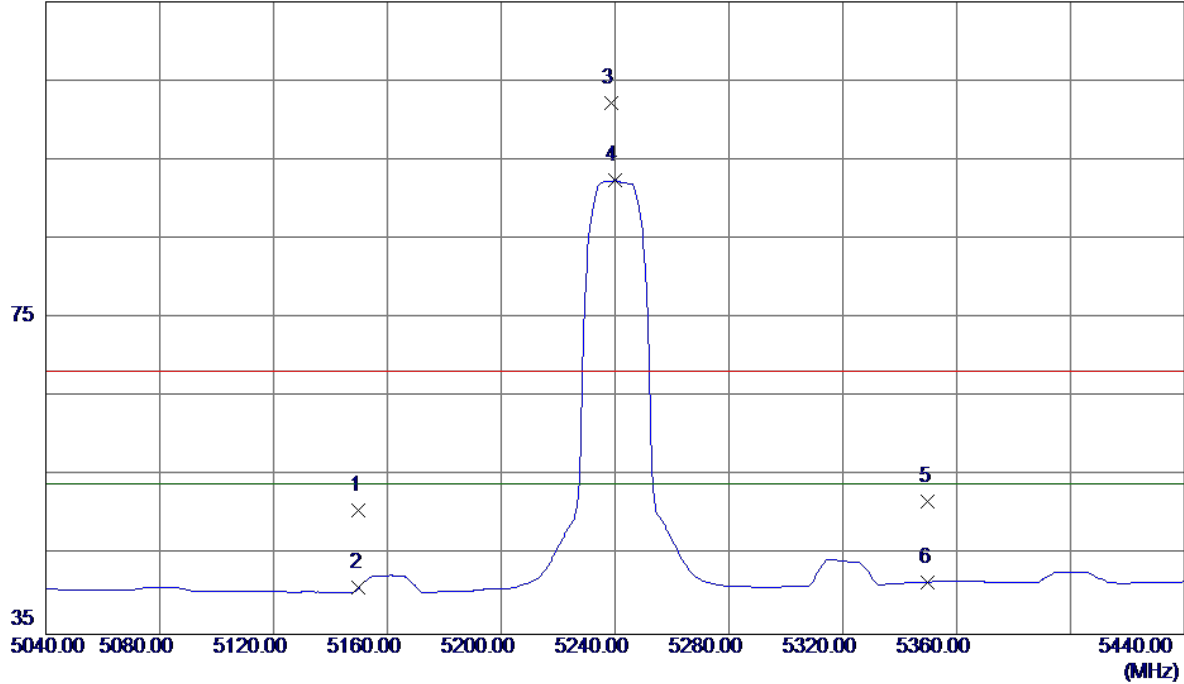

No.	Freq. MHz	Reading Level dBuV/m	Correct Factor dB	Measure ment dBuV/m	Limit dBuV/m	Margin dB	Detector	Comment
1	5150.0000	10.14	40.62	50.76	68.30	-17.54	Peak	
2	5150.0000	0.28	40.62	40.90	54.00	-13.10	AVG	
3	5238.8000	61.29	40.92	102.21	68.30	33.91	Peak	No Limit
4 *	5240.0000	51.46	40.92	92.38	54.00	38.38	AVG	No Limit
5	5350.0000	10.58	41.28	51.86	68.30	-16.44	Peak	
6	5350.0000	0.29	41.28	41.57	54.00	-12.43	AVG	

Orthogonal Axis:	X
Test Mode:	UNII-1/ TX AC20 Mode 5240MHz

Horizontal

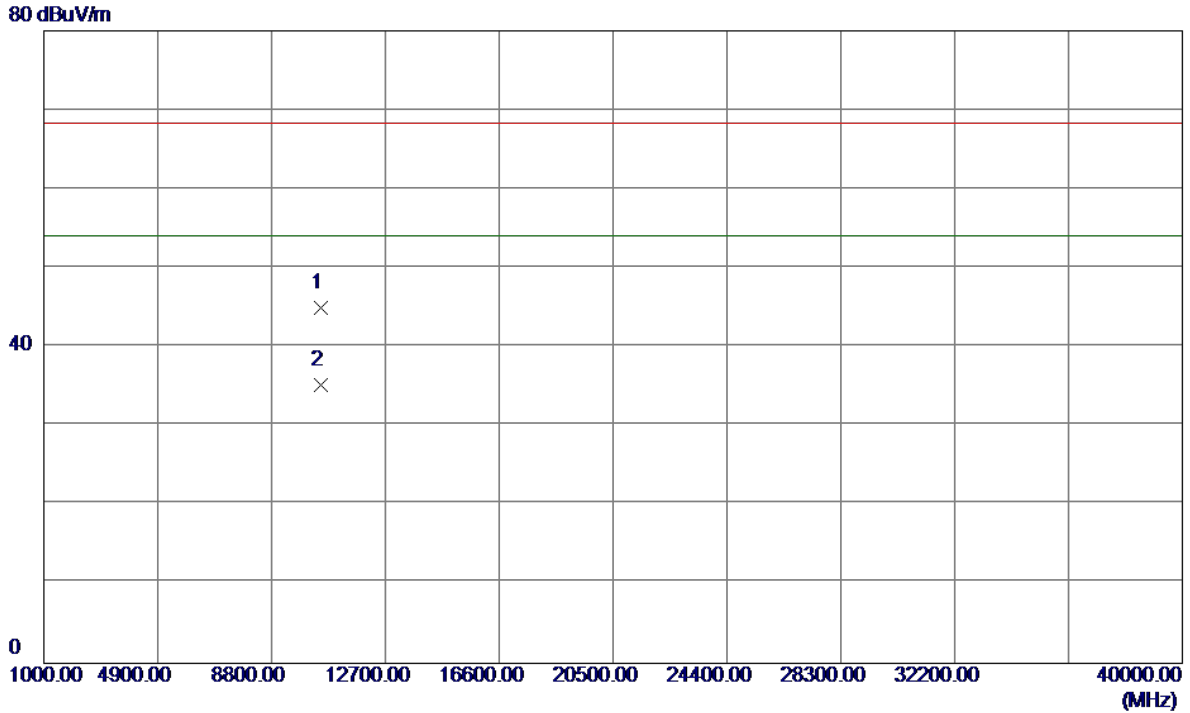

No.	Freq. MHz	Reading Level dBuV/m	Correct Factor dB	Measure ment dBuV/m	Limit dBuV/m	Margin dB	Detector	Comment
1	10480.5000	29.78	15.24	45.02	68.30	-23.28	Peak	
2 *	10481.9000	19.96	15.25	35.21	54.00	-18.79	AVG	

Orthogonal Axis:	X
Test Mode:	UNII-1/ TX AC40 Mode 5190MHz

Vertical

115 dBuV/m

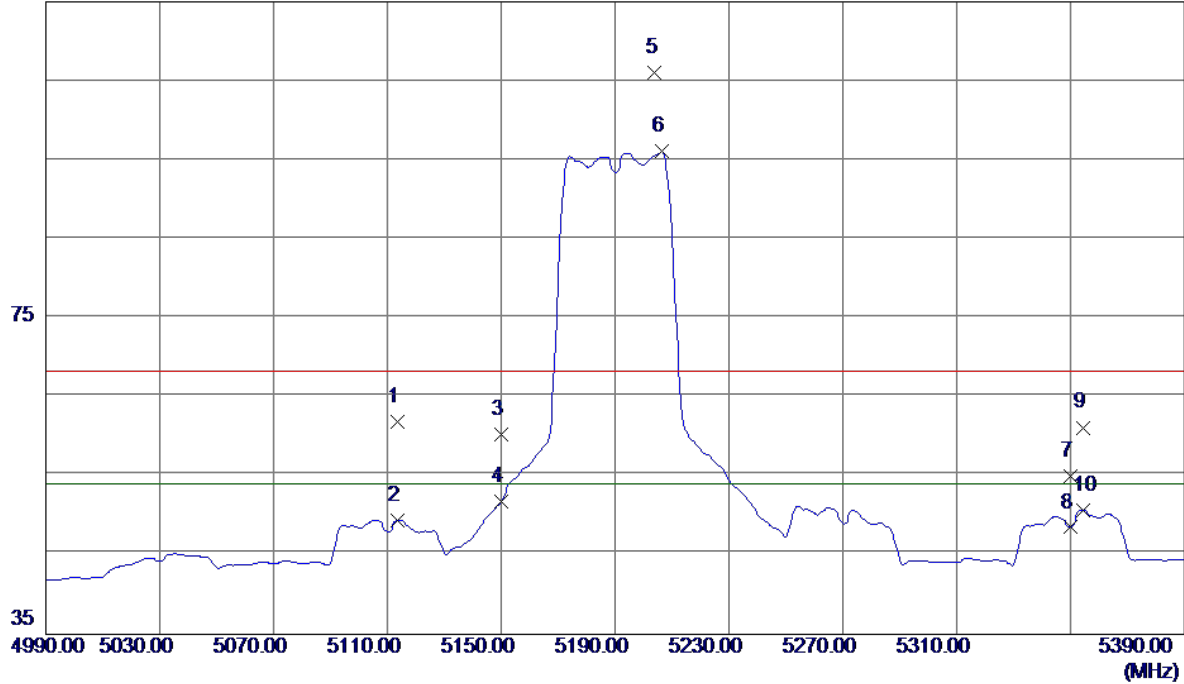

No.	Freq. MHz	Reading Level dBuV/m	Correct Factor dB	Measure ment dBuV/m	Limit dBuV/m	Margin dB	Detector	Comment
1	5113.6000	21.37	40.50	61.87	68.30	-6.43	Peak	
2	5113.6000	8.90	40.50	49.40	54.00	-4.60	AVG	
3	5150.0000	19.66	40.62	60.28	68.30	-8.02	Peak	
4	5150.0000	11.19	40.62	51.81	54.00	-2.19	AVG	
5	5204.0000	65.22	40.80	106.02	68.30	37.72	Peak	No Limit
6 *	5206.4000	55.25	40.81	96.06	54.00	42.06	AVG	No Limit
7	5350.0000	13.65	41.28	54.93	68.30	-13.37	Peak	
8	5350.0000	7.24	41.28	48.52	54.00	-5.48	AVG	
9	5354.4000	19.86	41.30	61.16	68.30	-7.14	Peak	
10	5354.4000	9.45	41.30	50.75	54.00	-3.25	AVG	

Orthogonal Axis:	X
Test Mode:	UNII-1/ TX AC40 Mode 5190MHz

Vertical

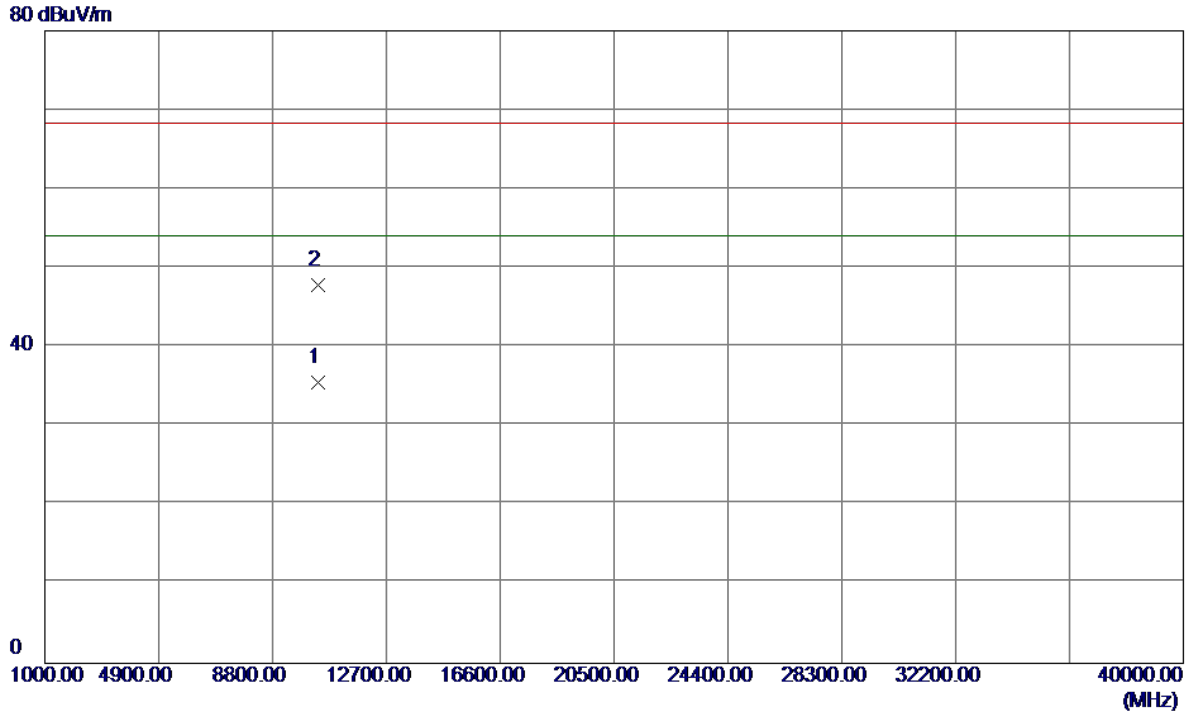

No.	Freq. MHz	Reading Level dBuV/m	Correct Factor dB	Measure ment dBuV/m	Limit dBuV/m	Margin dB	Detector	Comment
1 *	10378.7600	20.58	15.01	35.59	54.00	-18.41	AVG	
2	10379.0599	32.91	15.01	47.92	68.30	-20.38	Peak	

Orthogonal Axis:	X
Test Mode:	UNII-1/ TX AC40 Mode 5190MHz

Horizontal

115 dBuV/m

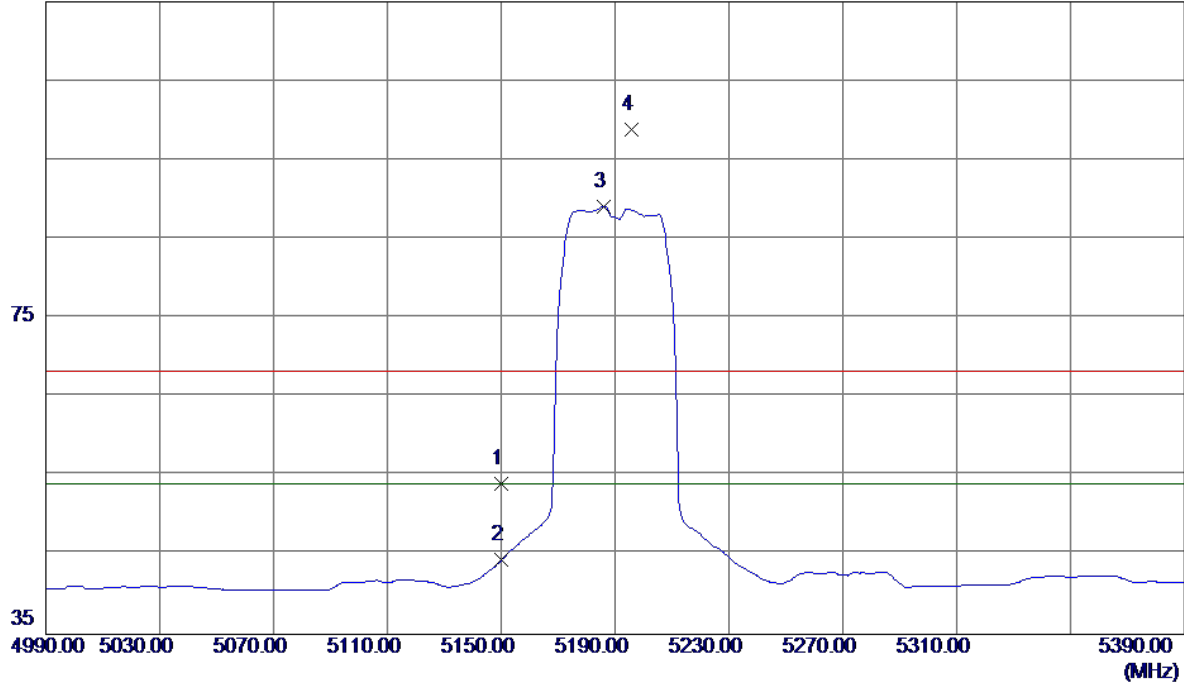

No.	Freq. MHz	Reading Level dBuV/m	Correct Factor dB	Measure ment dBuV/m	Limit dBuV/m	Margin dB	Detector	Comment
1	5150.0000	13.49	40.62	54.11	68.30	-14.19	Peak	
2	5150.0000	3.75	40.62	44.37	54.00	-9.63	AVG	
3 *	5186.0000	48.40	40.74	89.14	54.00	35.14	AVG	No Limit
4	5195.6000	58.08	40.78	98.86	68.30	30.56	Peak	No Limit

Orthogonal Axis:	X
Test Mode:	UNII-1/ TX AC40 Mode 5190MHz

Horizontal

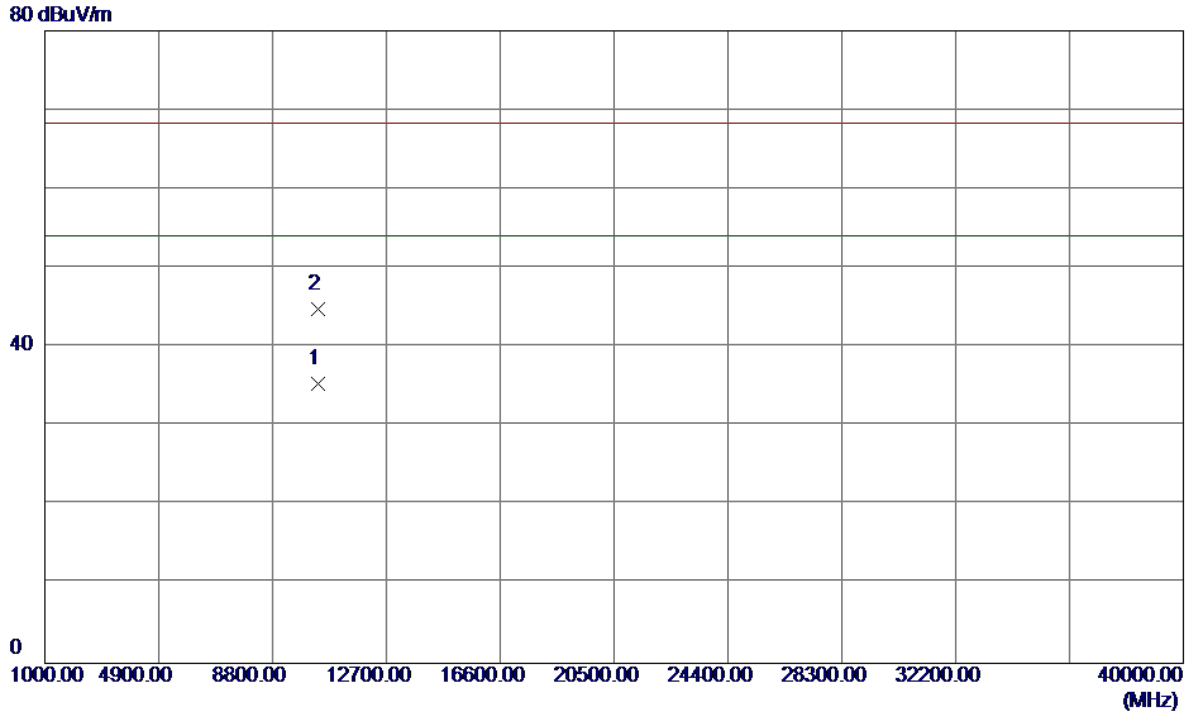

No.	Freq. MHz	Reading Level dBuV/m	Correct Factor dB	Measure ment dBuV/m	Limit dBuV/m	Margin dB	Detector	Comment
1 *	10378.6400	20.36	15.01	35.37	54.00	-18.63	AVG	
2	10380.0000	29.77	15.01	44.78	68.30	-23.52	Peak	

Orthogonal Axis:	X
Test Mode:	UNII-1/ TX AC40 Mode 5230MHz

Vertical

115 dBuV/m

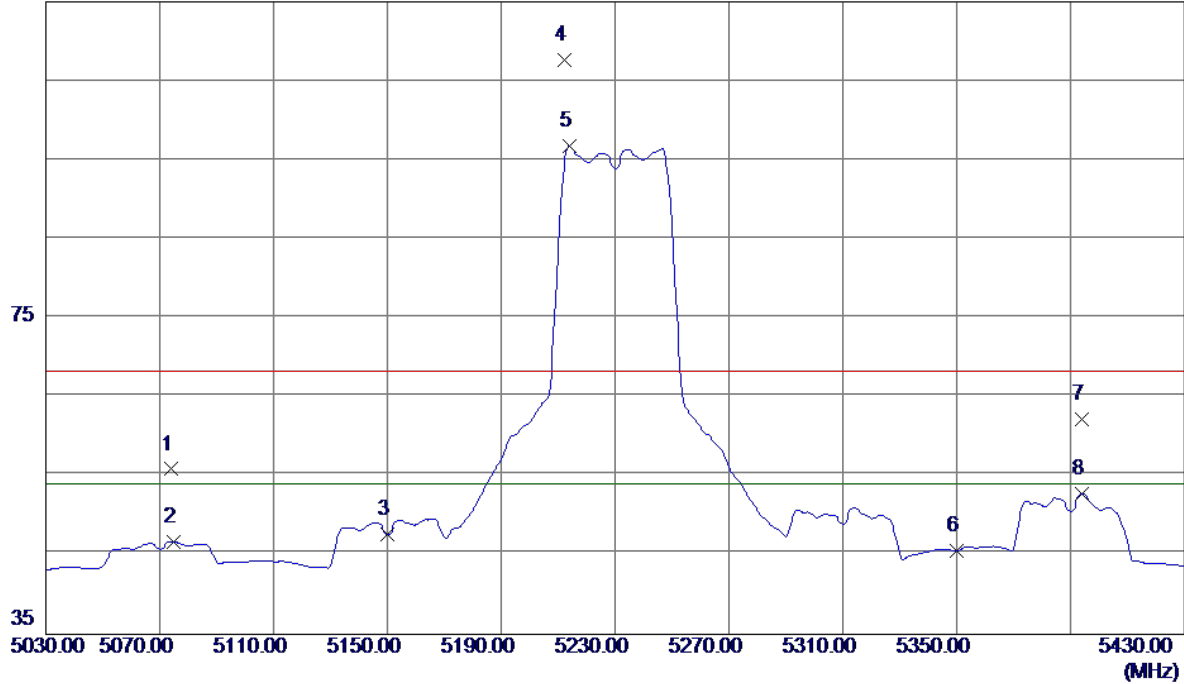

No.	Freq. MHz	Reading Level dBuV/m	Correct Factor dB	Measure ment dBuV/m	Limit dBuV/m	Margin dB	Detector	Comment
1	5074.0000	15.51	40.37	55.88	68.30	-12.42	Peak	
2	5074.8000	6.36	40.38	46.74	54.00	-7.26	AVG	
3	5150.0000	7.00	40.62	47.62	54.00	-6.38	AVG	
4	5212.4000	66.81	40.83	107.64	68.30	39.34	Peak	No Limit
5 *	5214.0000	55.94	40.84	96.78	54.00	42.78	AVG	No Limit
6	5350.0000	4.29	41.28	45.57	54.00	-8.43	AVG	
7	5394.0000	20.72	41.43	62.15	68.30	-6.15	Peak	
8	5394.0000	11.30	41.43	52.73	54.00	-1.27	AVG	

Orthogonal Axis:	X
Test Mode:	UNII-1/ TX AC40 Mode 5230MHz

Vertical

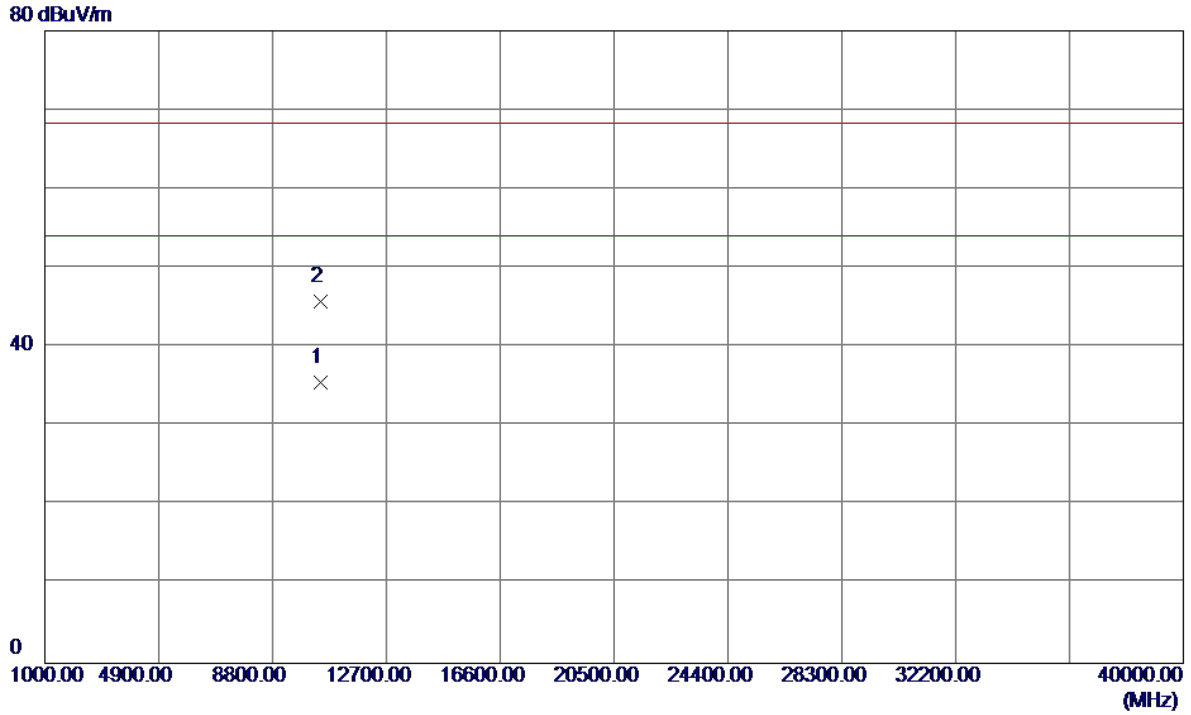

No.	Freq. MHz	Reading Level dBuV/m	Correct Factor dB	Measure ment dBuV/m	Limit dBuV/m	Margin dB	Detector	Comment
1 *	10459.2200	20.35	15.19	35.54	54.00	-18.46	AVG	
2	10459.9000	30.60	15.20	45.80	68.30	-22.50	Peak	

Orthogonal Axis:	X
Test Mode:	UNII-1/ TX AC40 Mode 5230MHz

Horizontal

115 dBuV/m

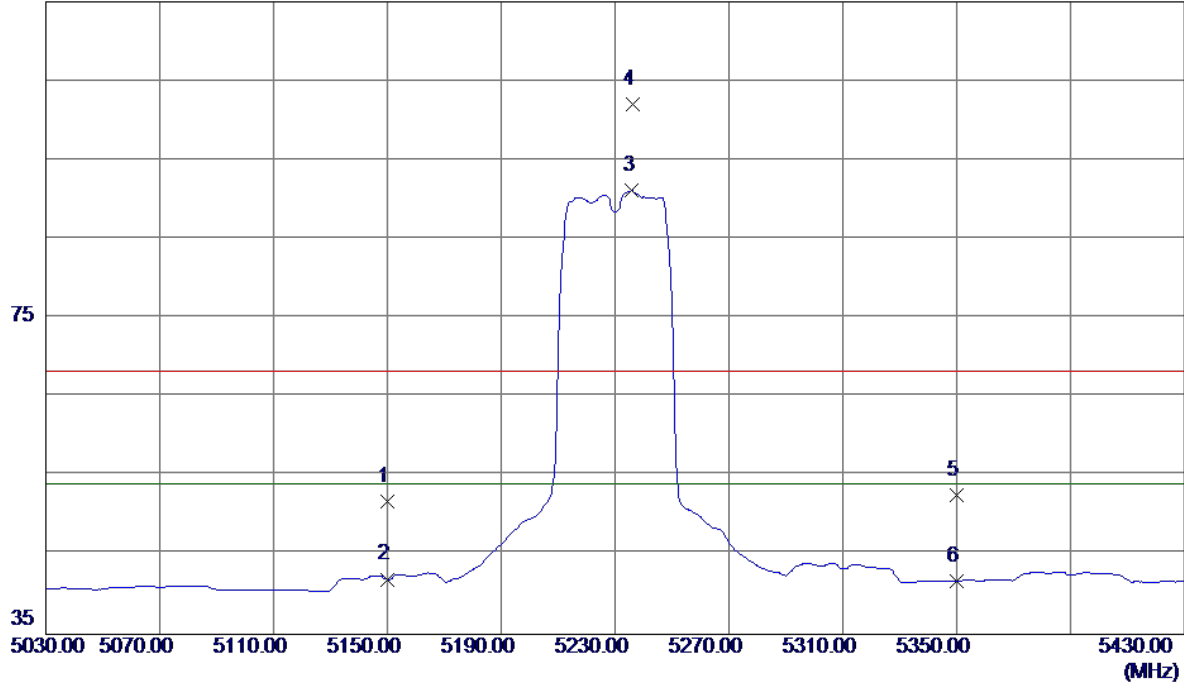

No.	Freq. MHz	Reading Level dBuV/m	Correct Factor dB	Measure ment dBuV/m	Limit dBuV/m	Margin dB	Detector	Comment
1	5150.0000	11.19	40.62	51.81	68.30	-16.49	Peak	
2	5150.0000	1.34	40.62	41.96	54.00	-12.04	AVG	
3 *	5236.0000	50.26	40.91	91.17	54.00	37.17	AVG	No Limit
4	5236.4000	61.19	40.91	102.10	68.30	33.80	Peak	No Limit
5	5350.0000	11.26	41.28	52.54	68.30	-15.76	Peak	
6	5350.0000	0.44	41.28	41.72	54.00	-12.28	AVG	

Orthogonal Axis:	X
Test Mode:	UNII-1/ TX AC40 Mode 5230MHz

Horizontal

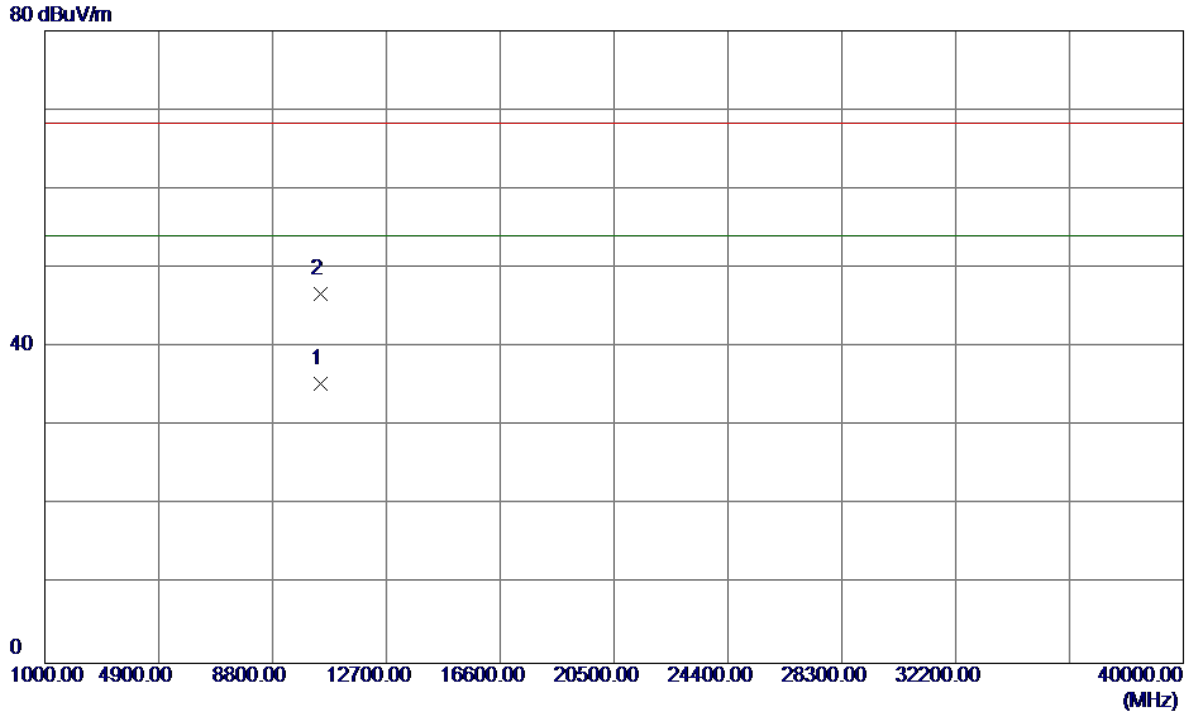

No.	Freq. MHz	Reading Level dBuV/m	Correct Factor dB	Measure ment dBuV/m	Limit dBuV/m	Margin dB	Detector	Comment
1 *	10459.8600	20.13	15.20	35.33	54.00	-18.67	AVG	
2	10459.9400	31.45	15.20	46.65	68.30	-21.65	Peak	

Orthogonal Axis:	X
Test Mode:	UNII-1/ TX AC80 Mode 5210MHz

Vertical

115 dBuV/m

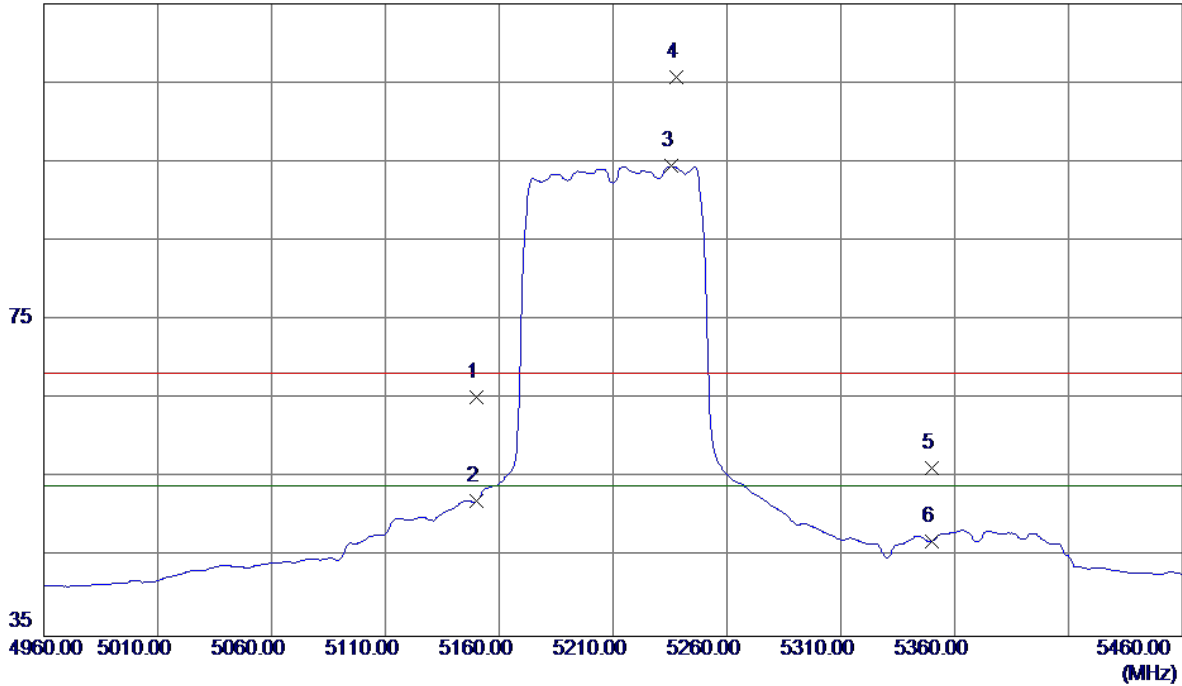

No.	Freq. MHz	Reading Level dBuV/m	Correct Factor dB	Measure ment dBuV/m	Limit dBuV/m	Margin dB	Detector	Comment
1	5150.0000	24.66	40.62	65.28	68.30	-3.02	Peak	
2	5150.0000	11.53	40.62	52.15	54.00	-1.85	AVG	
3 *	5235.5000	53.54	40.91	94.45	54.00	40.45	AVG	No Limit
4	5238.0000	64.78	40.92	105.70	68.30	37.40	Peak	No Limit
5	5350.0000	14.96	41.28	56.24	68.30	-12.06	Peak	
6	5350.0000	5.78	41.28	47.06	54.00	-6.94	AVG	

Orthogonal Axis:	X
Test Mode:	UNII-1/ TX AC80 Mode 5210MHz

Vertical

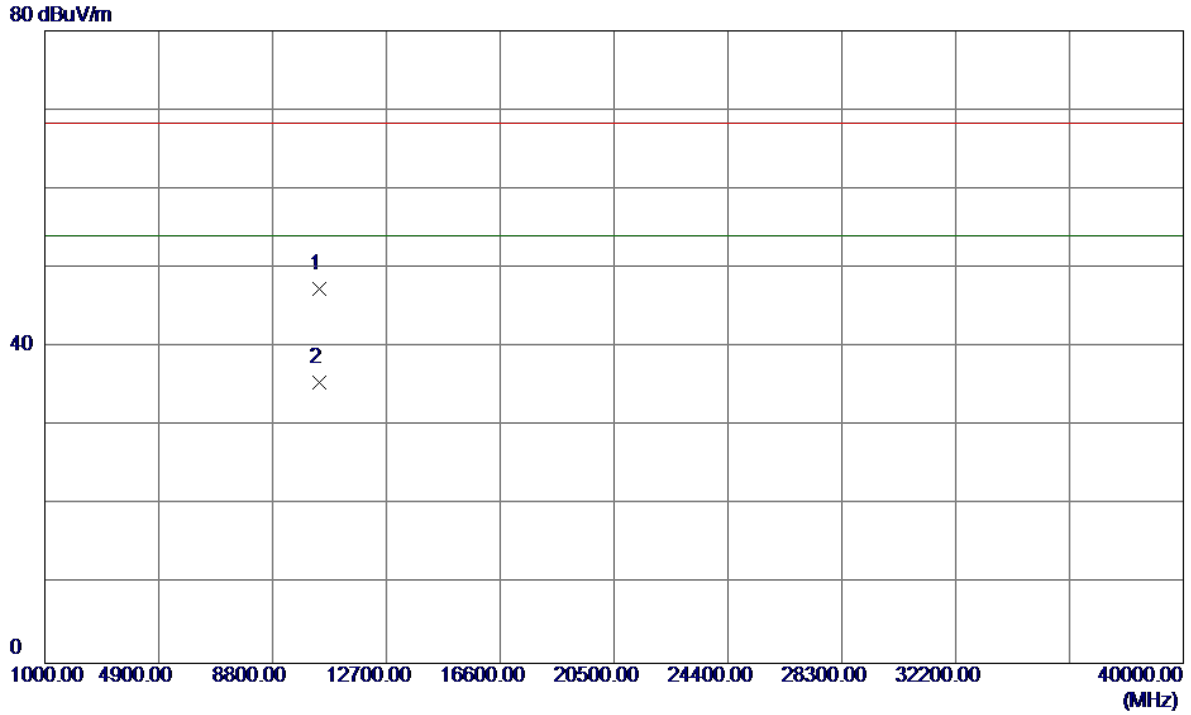

No.	Freq. MHz	Reading Level dBuV/m	Correct Factor dB	Measure ment dBuV/m	Limit dBuV/m	Margin dB	Detector	Comment
1	10419.3400	32.29	15.10	47.39	68.30	-20.91	Peak	
2 *	10419.8000	20.41	15.10	35.51	54.00	-18.49	AVG	

Orthogonal Axis:	X
Test Mode:	UNII-1/ TX AC80 Mode 5210MHz

Horizontal

115 dBuV/m

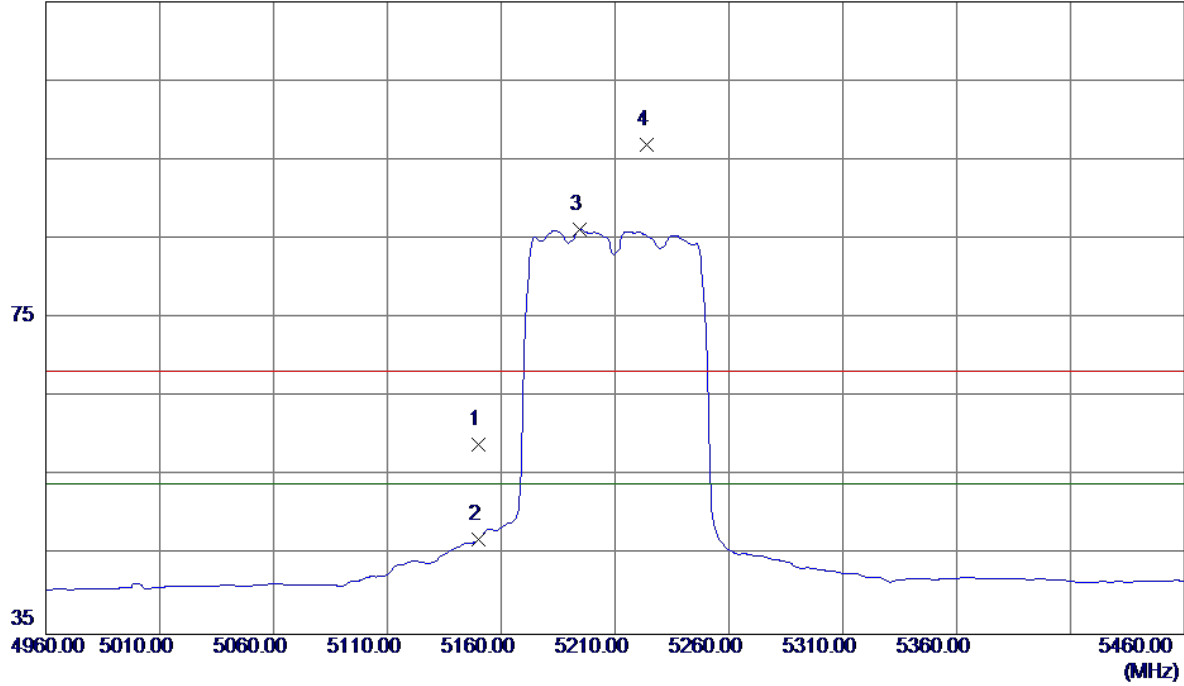

No.	Freq. MHz	Reading Level dBuV/m	Correct Factor dB	Measure ment dBuV/m	Limit dBuV/m	Margin dB	Detector	Comment
1	5150.0000	18.38	40.62	59.00	68.30	-9.30	Peak	
2	5150.0000	6.36	40.62	46.98	54.00	-7.02	AVG	
3 *	5194.5000	45.39	40.77	86.16	54.00	32.16	AVG	No Limit
4	5224.0000	55.99	40.87	96.86	68.30	28.56	Peak	No Limit

Orthogonal Axis:	X
Test Mode:	UNII-1/ TX AC80 Mode 5210MHz

Horizontal

80 dBuV/m

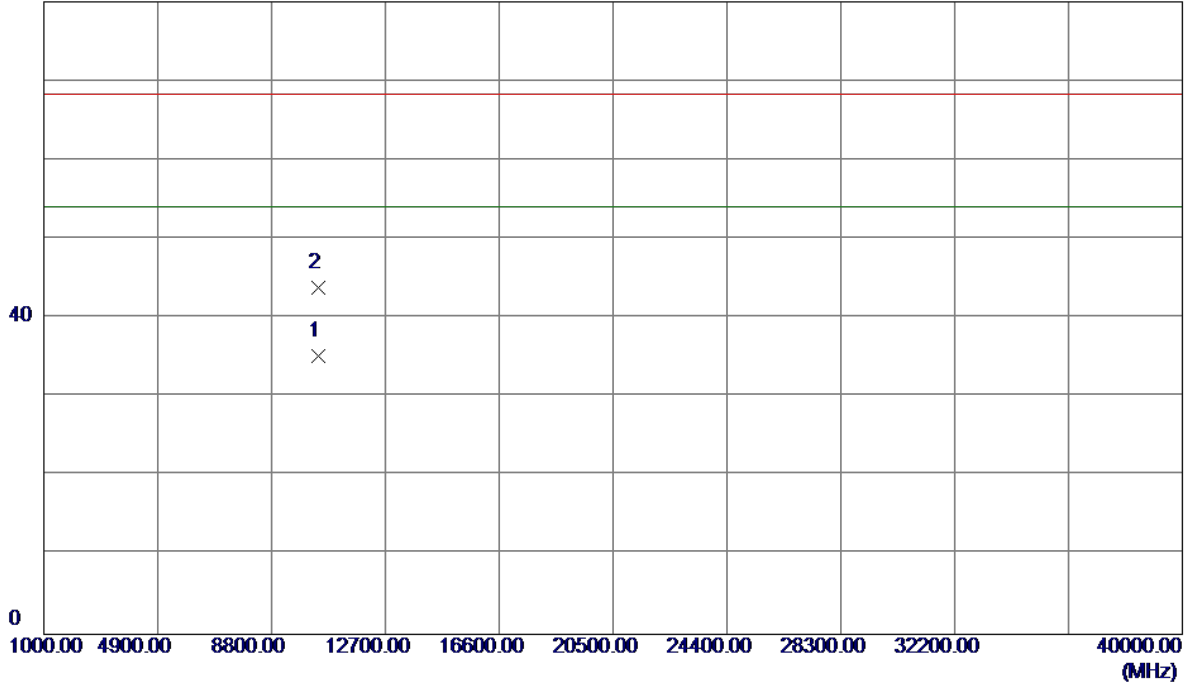

No.	Freq. MHz	Reading Level dBuV/m	Correct Factor dB	Measure ment dBuV/m	Limit dBuV/m	Margin dB	Detector	Comment
1 *	10419.8200	20.04	15.10	35.14	54.00	-18.86	AVG	
2	10420.1200	28.79	15.10	43.89	68.30	-24.41	Peak	

Orthogonal Axis:	X
Test Mode:	UNII-3/TX AC20 Mode 5745MHz

Vertical

124 dBuV/m

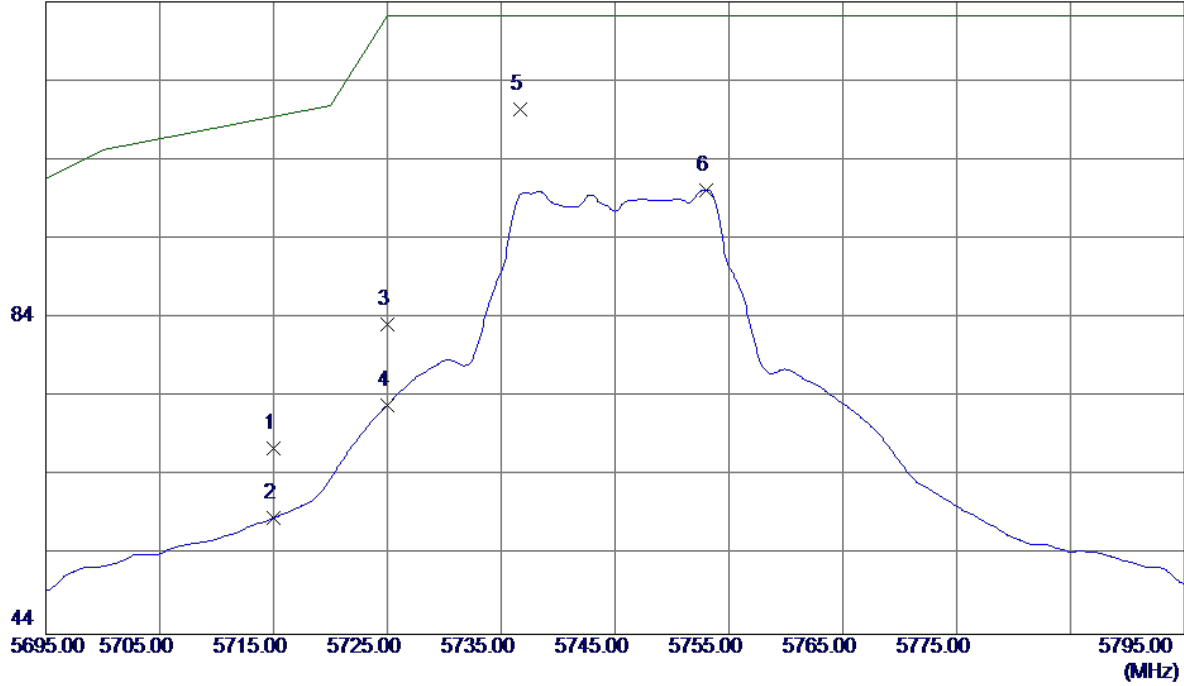

No.	Freq. MHz	Reading Level dBuV/m	Correct Factor dB	Measure ment dBuV/m	Limit dBuV/m	Margin dB	Detector	Comment
1	5715.0000	25.04	42.55	67.59	109.50	-41.91	Peak	
2	5715.0000	16.15	42.55	58.70	109.50	-50.80	AVG	
3	5725.0000	40.60	42.58	83.18	122.30	-39.12	Peak	
4	5725.0000	30.44	42.58	73.02	122.30	-49.28	AVG	
5 *	5736.7000	67.71	42.62	110.33	122.30	-11.97	Peak	
6	5753.0000	57.55	42.68	100.23	122.30	-22.07	AVG	

Orthogonal Axis:	X
Test Mode:	UNII-3/TX AC20 Mode 5745MHz

Vertical

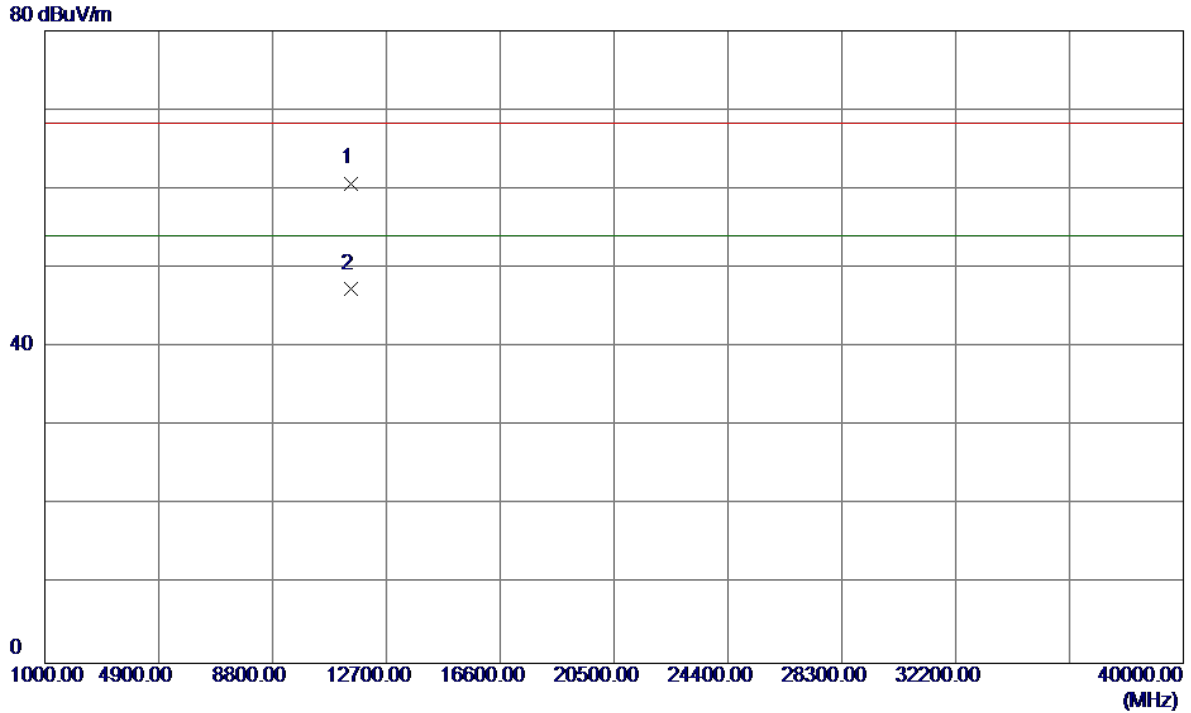

No.	Freq. MHz	Reading Level dBuV/m	Correct Factor dB	Measure ment dBuV/m	Limit dBuV/m	Margin dB	Detector	Comment
1	11488.8000	45.23	15.49	60.72	68.30	-7.58	Peak	
2 *	11490.0000	31.81	15.49	47.30	54.00	-6.70	AVG	

Orthogonal Axis:	X
Test Mode:	UNII-3/TX AC20 Mode 5745MHz

Horizontal

124 dBuV/m

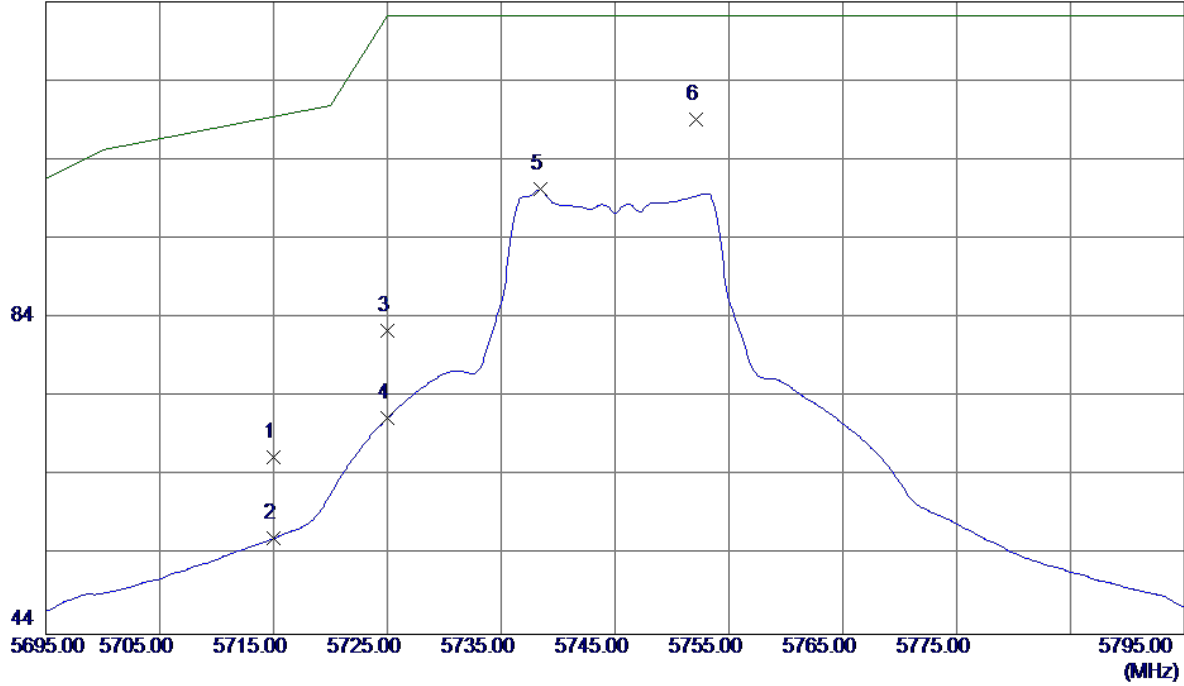

No.	Freq. MHz	Reading Level dBuV/m	Correct Factor dB	Measure ment dBuV/m	Limit dBuV/m	Margin dB	Detector	Comment
1	5715.0000	23.90	42.55	66.45	109.50	-43.05	Peak	
2	5715.0000	13.56	42.55	56.11	109.50	-53.39	AVG	
3	5725.0000	39.77	42.58	82.35	122.30	-39.95	Peak	
4	5725.0000	28.71	42.58	71.29	122.30	-51.01	AVG	
5	5738.4000	57.62	42.63	100.25	122.30	-22.05	AVG	
6 *	5752.1000	66.36	42.68	109.04	122.30	-13.26	Peak	

Orthogonal Axis:	X
Test Mode:	UNII-3/TX AC20 Mode 5745MHz

Horizontal

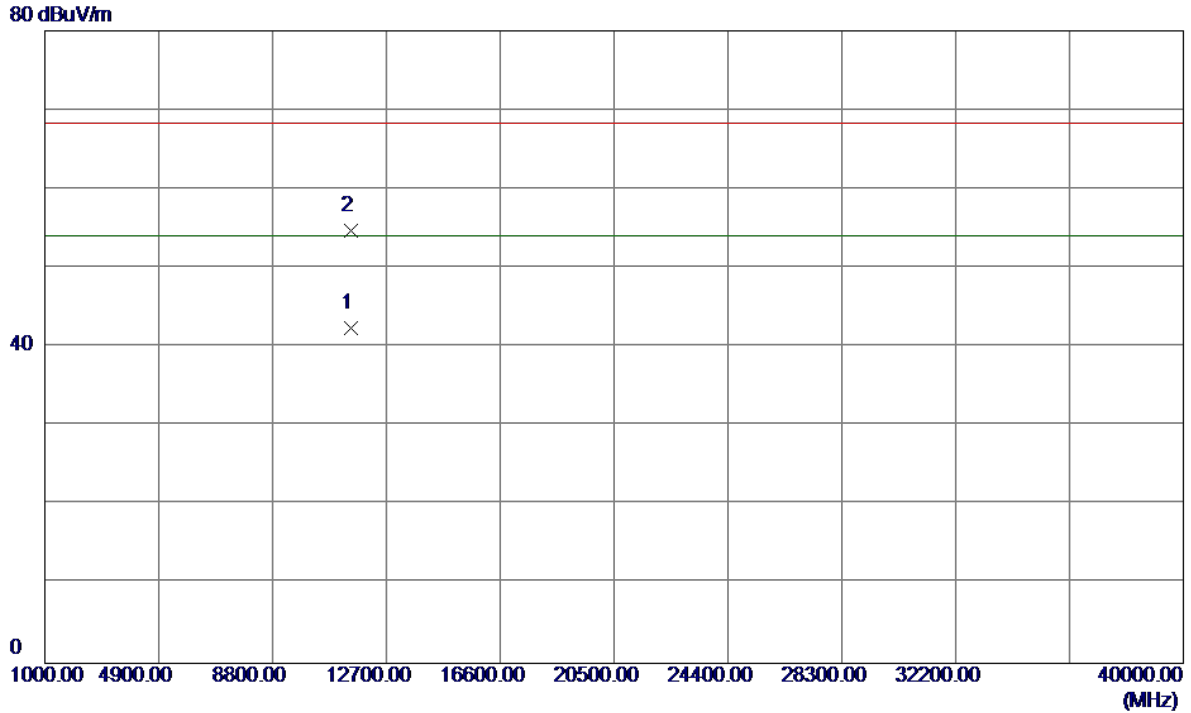

No.	Freq. MHz	Reading Level dBuV/m	Correct Factor dB	Measure ment dBuV/m	Limit dBuV/m	Margin dB	Detector	Comment
1 *	11488.8000	26.95	15.49	42.44	54.00	-11.56	AVG	
2	11489.1000	39.18	15.49	54.67	68.30	-13.63	Peak	

Orthogonal Axis:	X
Test Mode:	UNII-3/TX AC20 Mode 5785MHz

Vertical

124 dBuV/m

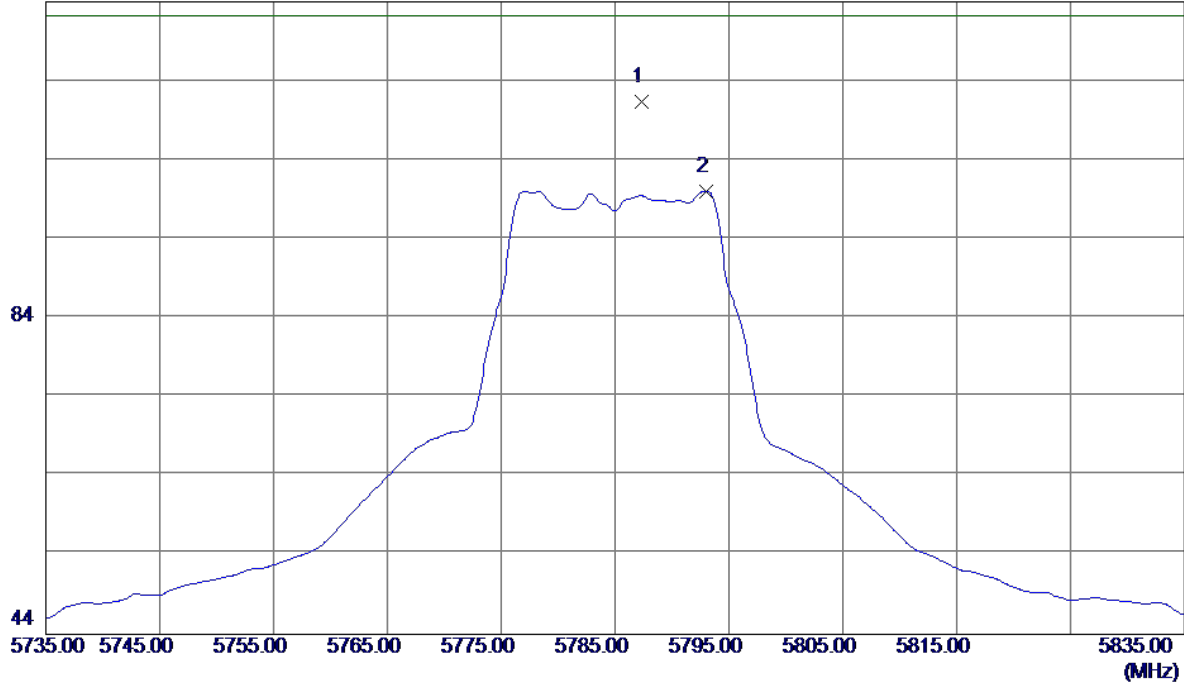

No.	Freq. MHz	Reading Level dBuV/m	Correct Factor dB	Measure ment dBuV/m	Limit dBuV/m	Margin dB	Detector	Comment
1 *	5787.3000	68.60	42.80	111.40	122.30	-10.90	Peak	
2	5793.0000	57.20	42.82	100.02	122.30	-22.28	AVG	

Orthogonal Axis:	X
Test Mode:	UNII-3/TX AC20 Mode 5785MHz

Vertical

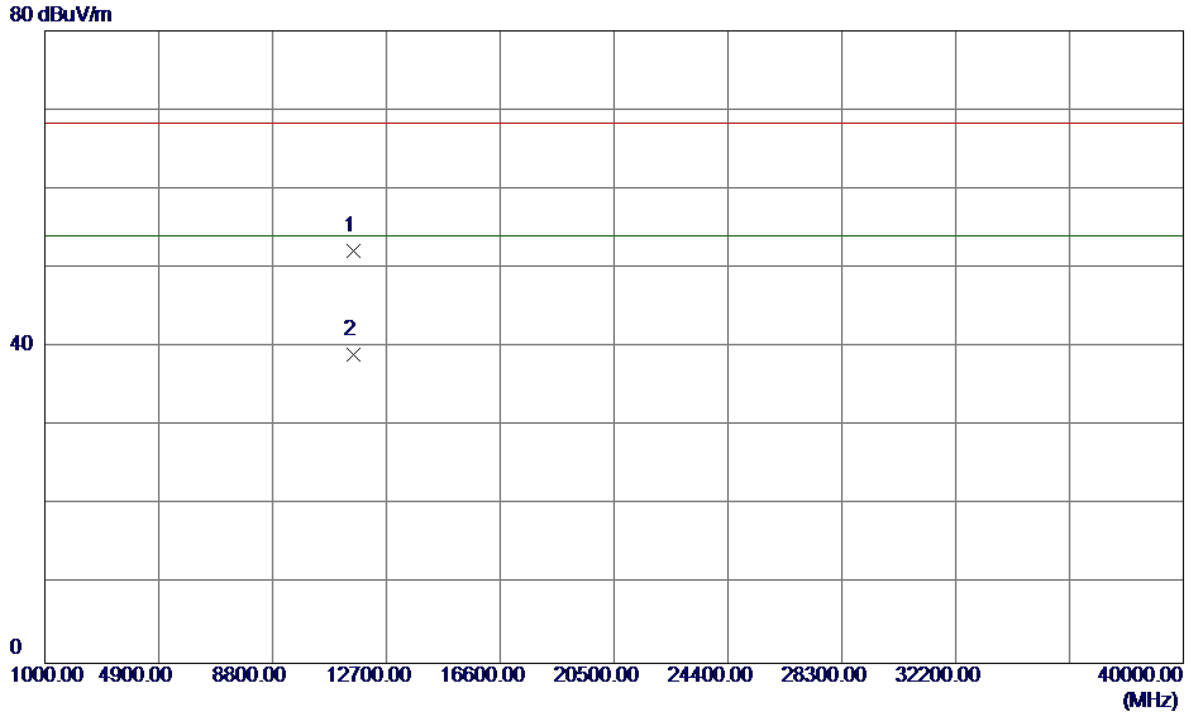

No.	Freq. MHz	Reading Level dBuV/m	Correct Factor dB	Measure ment dBuV/m	Limit dBuV/m	Margin dB	Detector	Comment
1	11568.8000	36.73	15.48	52.21	68.30	-16.09	Peak	
2 *	11569.0000	23.59	15.48	39.07	54.00	-14.93	AVG	

Orthogonal Axis:	X
Test Mode:	UNII-3/TX AC20 Mode 5785MHz

Horizontal

124 dBuV/m

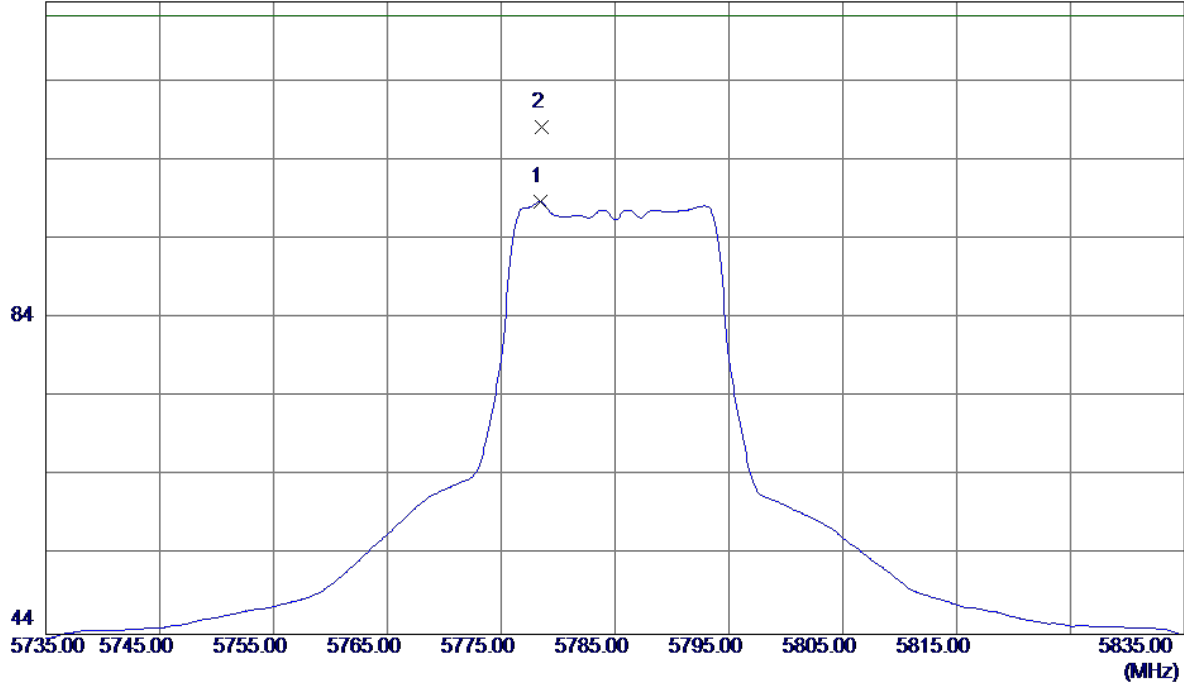

No.	Freq. MHz	Reading Level dBuV/m	Correct Factor dB	Measure ment dBuV/m	Limit dBuV/m	Margin dB	Detector	Comment
1	5778.4000	55.98	42.77	98.75	122.30	-23.55	AVG	
2 *	5778.6000	65.37	42.77	108.14	122.30	-14.16	Peak	

Orthogonal Axis:	X
Test Mode:	UNII-3/TX AC20 Mode 5785MHz

Horizontal

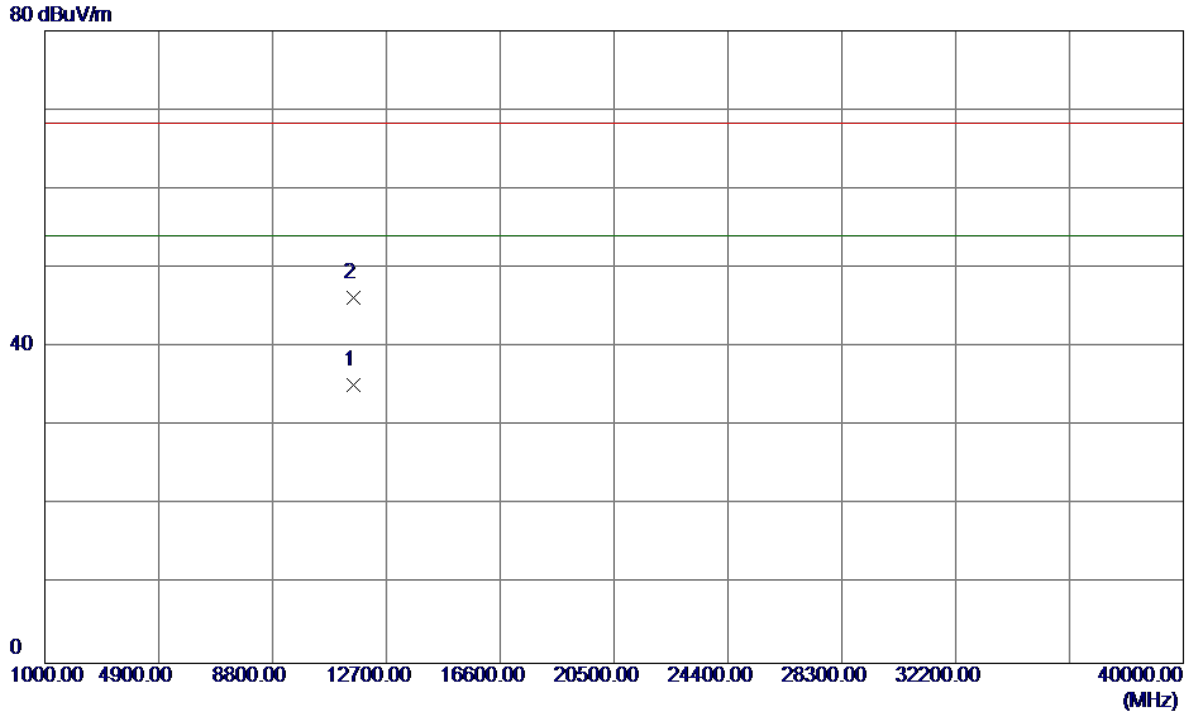

No.	Freq. MHz	Reading Level dBuV/m	Correct Factor dB	Measure ment dBuV/m	Limit dBuV/m	Margin dB	Detector	Comment
1 *	11569.7000	19.68	15.48	35.16	54.00	-18.84	AVG	
2	11570.0000	30.80	15.48	46.28	68.30	-22.02	Peak	

Orthogonal Axis:	X
Test Mode:	UNII-3/TX AC20 Mode 5825MHz

Vertical

124 dBuV/m

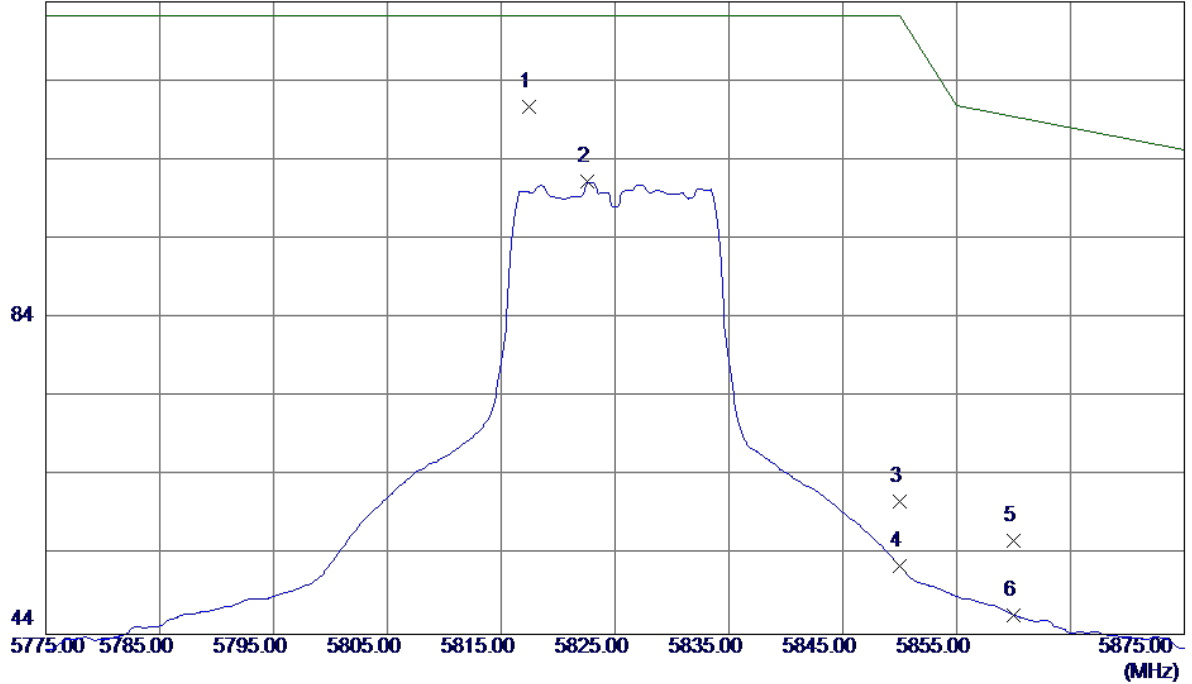

No.	Freq. MHz	Reading Level dBuV/m	Correct Factor dB	Measure ment dBuV/m	Limit dBuV/m	Margin dB	Detector	Comment
1 *	5817.4000	67.89	42.91	110.80	122.30	-11.50	Peak	
2	5822.6000	58.27	42.93	101.20	122.30	-21.10	AVG	
3	5850.0000	17.80	43.03	60.83	122.30	-61.47	Peak	
4	5850.0000	9.62	43.03	52.65	122.30	-69.65	AVG	
5	5860.0000	12.83	43.06	55.89	109.50	-53.61	Peak	
6	5860.0000	3.41	43.06	46.47	109.50	-63.03	AVG	

Orthogonal Axis:	X
Test Mode:	UNII-3/TX AC20 Mode 5825MHz

Vertical

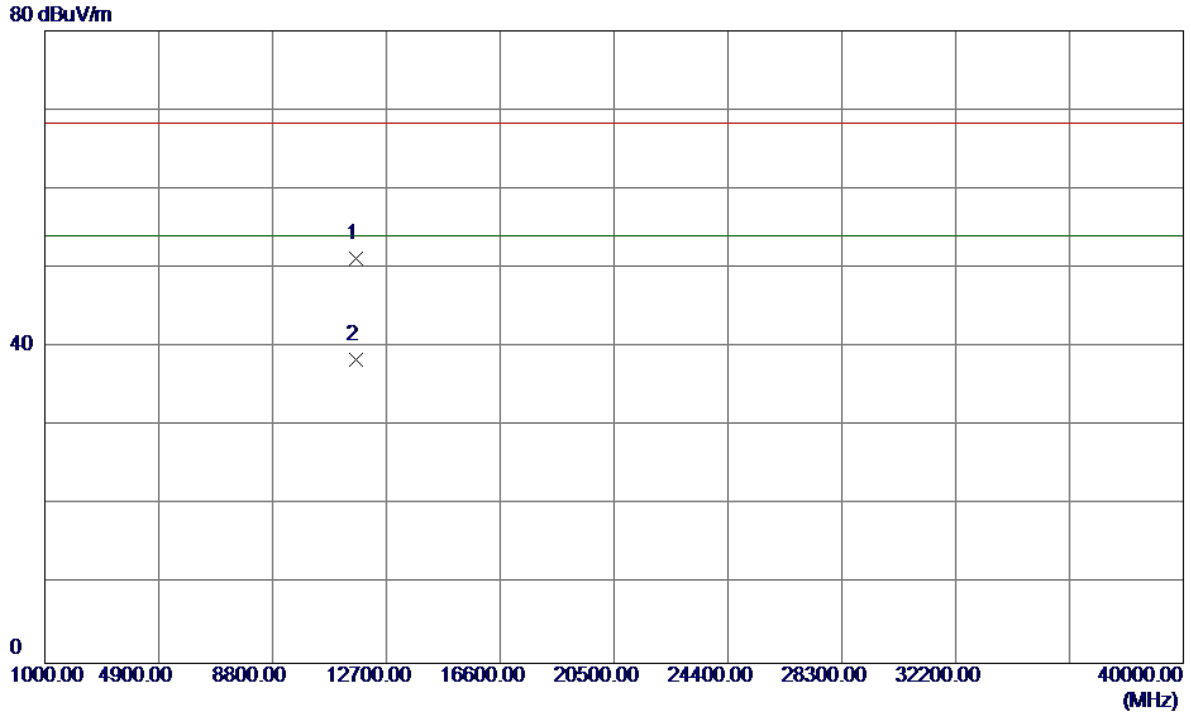

No.	Freq. MHz	Reading Level dBuV/m	Correct Factor dB	Measure ment dBuV/m	Limit dBuV/m	Margin dB	Detector	Comment
1	11649.0000	35.71	15.48	51.19	68.30	-17.11	Peak	
2 *	11649.0000	22.99	15.48	38.47	54.00	-15.53	AVG	

Orthogonal Axis:	X
Test Mode:	UNII-3/TX AC20 Mode 5825MHz

Horizontal

124 dBuV/m

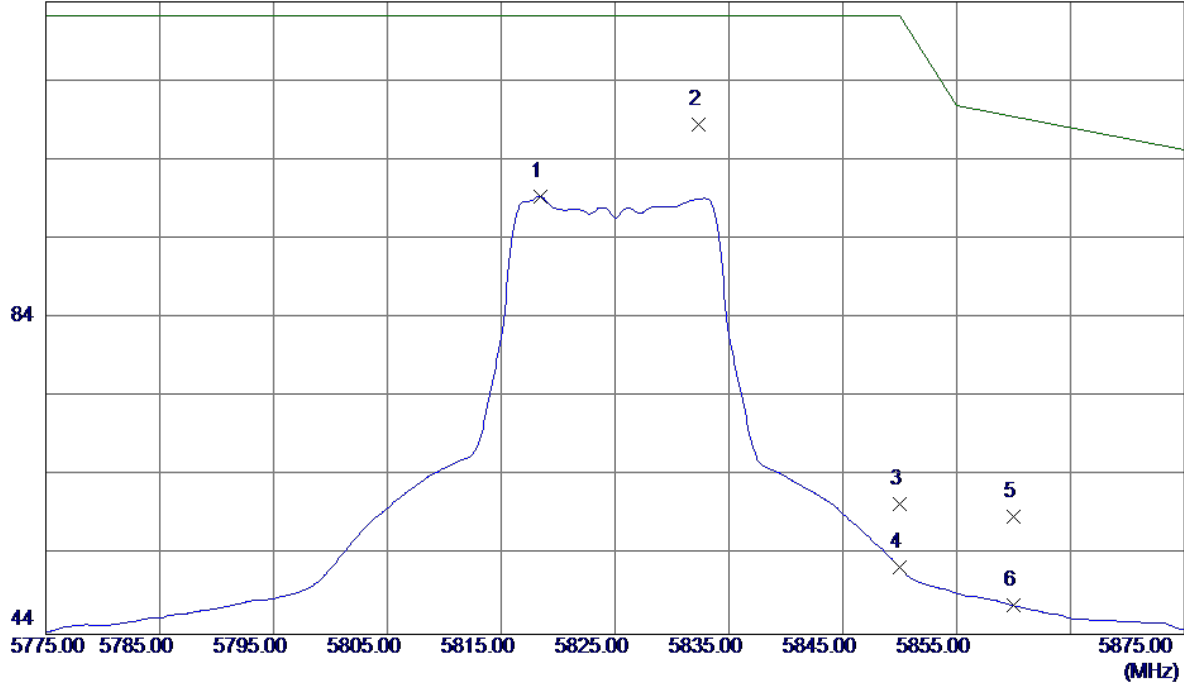

No.	Freq. MHz	Reading Level dBuV/m	Correct Factor dB	Measure ment dBuV/m	Limit dBuV/m	Margin dB	Detector	Comment
1	5818.4000	56.52	42.91	99.43	122.30	-22.87	AVG	
2 *	5832.3000	65.46	42.96	108.42	122.30	-13.88	Peak	
3	5850.0000	17.52	43.03	60.55	122.30	-61.75	Peak	
4	5850.0000	9.42	43.03	52.45	122.30	-69.85	AVG	
5	5860.0000	15.85	43.06	58.91	109.50	-50.59	Peak	
6	5860.0000	4.57	43.06	47.63	109.50	-61.87	AVG	

Orthogonal Axis:	X
Test Mode:	UNII-3/TX AC20 Mode 5825MHz

Horizontal

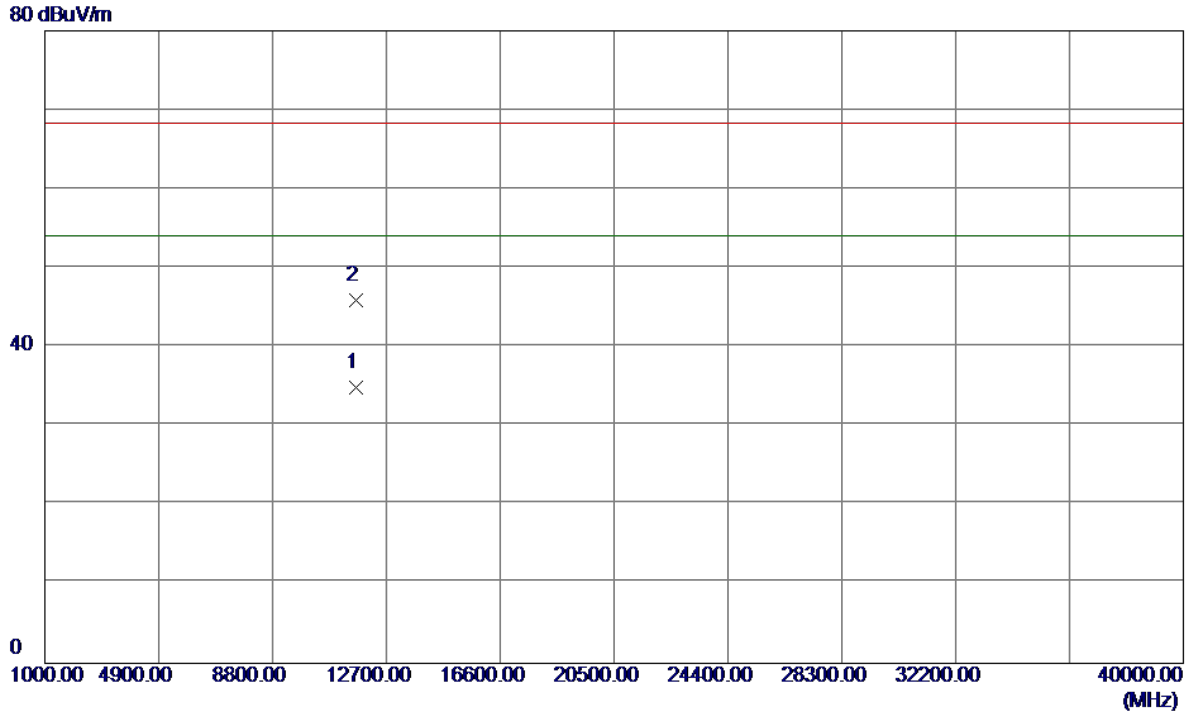

No.	Freq. MHz	Reading Level dBuV/m	Correct Factor dB	Measure ment dBuV/m	Limit dBuV/m	Margin dB	Detector	Comment
1 *	11650.1000	19.47	15.48	34.95	54.00	-19.05	AVG	
2	11650.9000	30.51	15.48	45.99	68.30	-22.31	Peak	

Orthogonal Axis:	X
Test Mode:	UNII-3/TX AC40 Mode 5755MHz

Vertical

124 dBuV/m

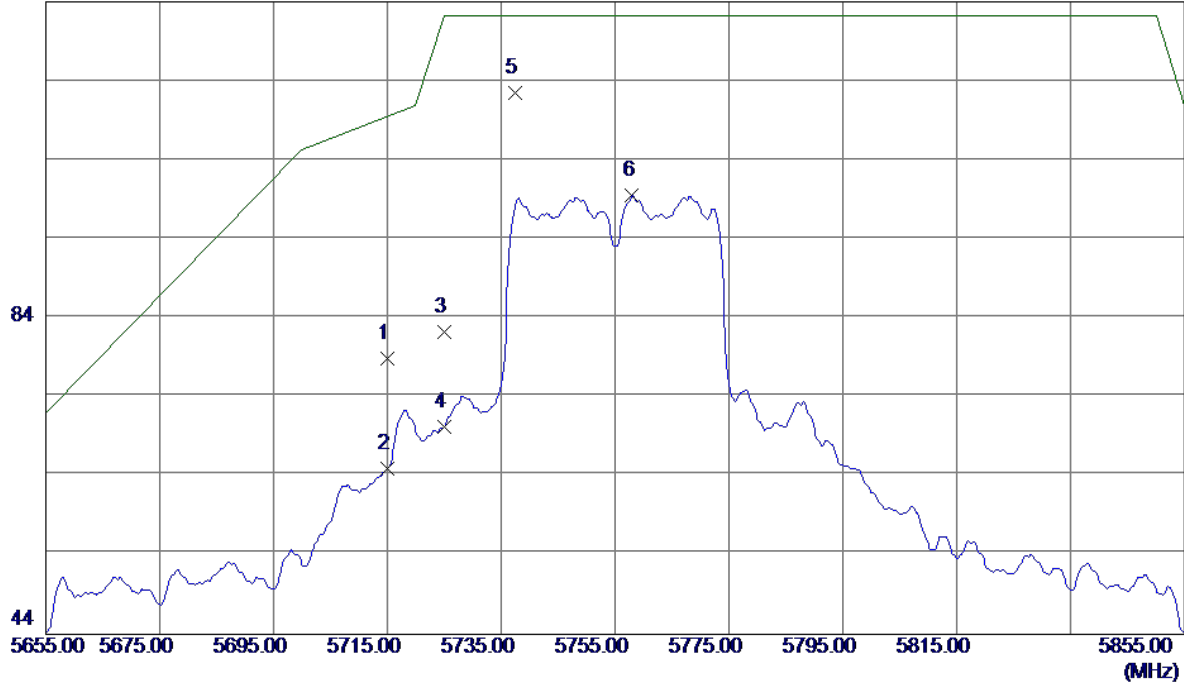

No.	Freq. MHz	Reading Level dBuV/m	Correct Factor dB	Measure ment dBuV/m	Limit dBuV/m	Margin dB	Detector	Comment
1	5715.0000	36.28	42.55	78.83	109.50	-30.67	Peak	
2	5715.0000	22.34	42.55	64.89	109.50	-44.61	AVG	
3	5725.0000	39.69	42.58	82.27	122.30	-40.03	Peak	
4	5725.0000	27.67	42.58	70.25	122.30	-52.05	AVG	
5 *	5737.4000	69.83	42.62	112.45	122.30	-9.85	Peak	
6	5758.0000	56.77	42.70	99.47	122.30	-22.83	AVG	

Orthogonal Axis:	X
Test Mode:	UNII-3/TX AC40 Mode 5755MHz

Vertical

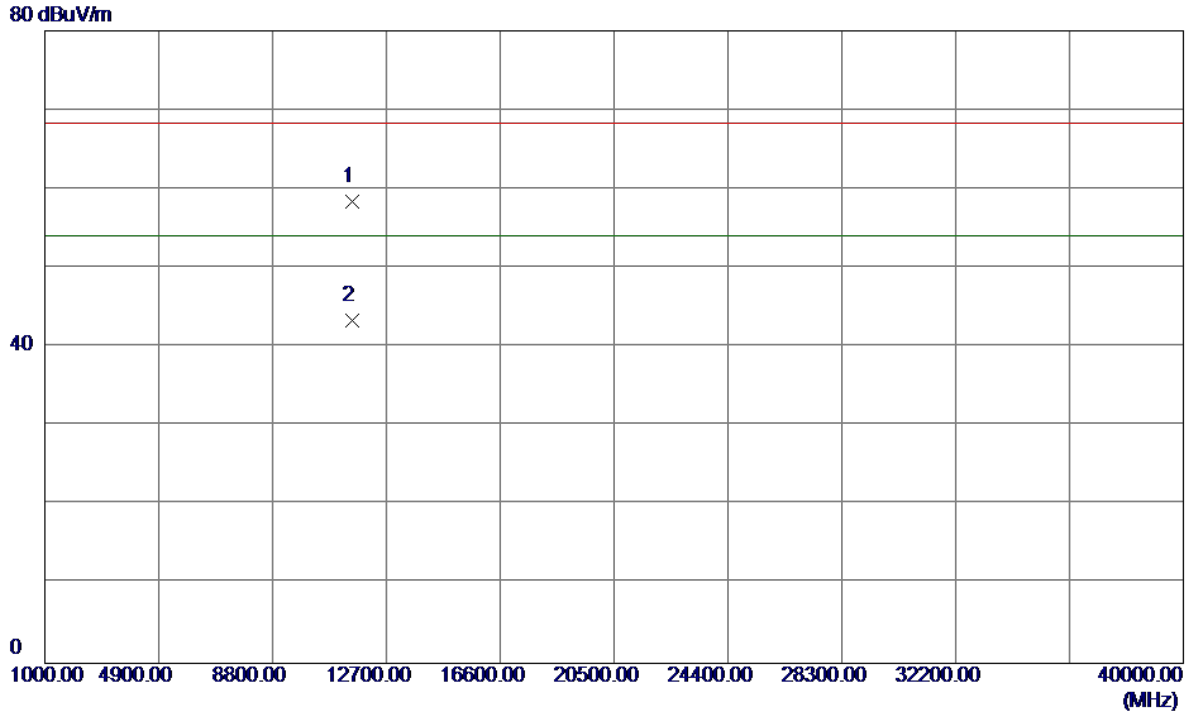

No.	Freq. MHz	Reading Level dBuV/m	Correct Factor dB	Measure ment dBuV/m	Limit dBuV/m	Margin dB	Detector	Comment
1 *	11508.8000	42.91	15.48	58.39	68.30	-9.91	Peak	
2	11509.2000	27.89	15.48	43.37	54.00	-10.63	AVG	

Orthogonal Axis:	X
Test Mode:	UNII-3/TX AC40 Mode 5755MHz

Horizontal

124 dBuV/m

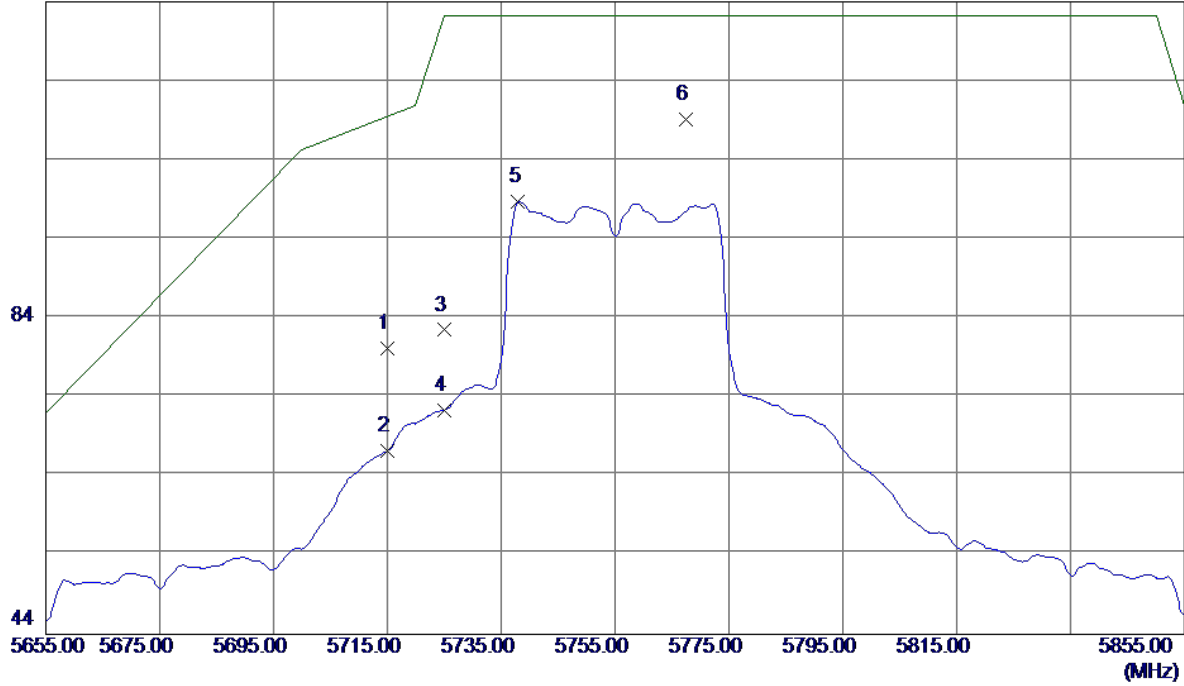

No.	Freq. MHz	Reading Level dBuV/m	Correct Factor dB	Measure ment dBuV/m	Limit dBuV/m	Margin dB	Detector	Comment
1	5715.0000	37.59	42.55	80.14	109.50	-29.36	Peak	
2	5715.0000	24.64	42.55	67.19	109.50	-42.31	AVG	
3	5725.0000	39.90	42.58	82.48	122.30	-39.82	Peak	
4	5725.0000	29.75	42.58	72.33	122.30	-49.97	AVG	
5	5738.0000	56.17	42.63	98.80	122.30	-23.50	AVG	
6 *	5767.4000	66.36	42.73	109.09	122.30	-13.21	Peak	

Orthogonal Axis:	X
Test Mode:	UNII-3/TX AC40 Mode 5755MHz

Horizontal

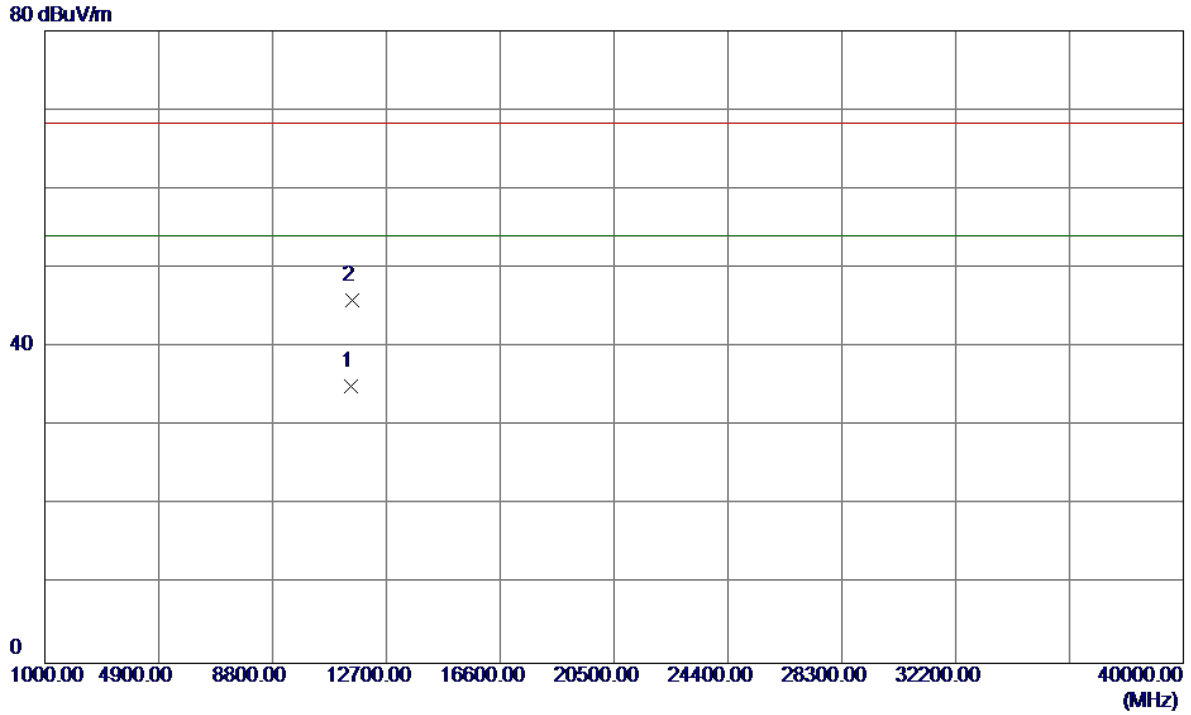

No.	Freq. MHz	Reading Level dBuV/m	Correct Factor dB	Measure ment dBuV/m	Limit dBuV/m	Margin dB	Detector	Comment
1 *	11508.0000	19.59	15.48	35.07	54.00	-18.93	AVG	
2	11511.4000	30.40	15.48	45.88	68.30	-22.42	Peak	

Orthogonal Axis:	X
Test Mode:	UNII-3/TX AC40 Mode 5795MHz

Vertical

124 dBuV/m

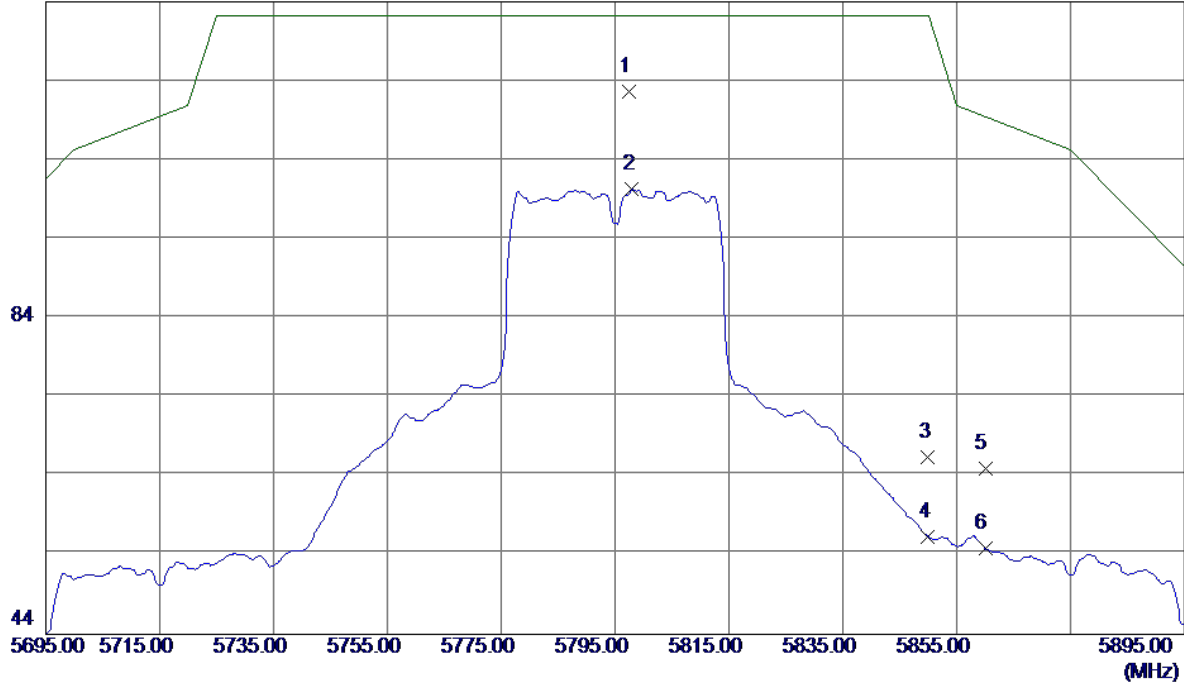

No.	Freq. MHz	Reading Level dBuV/m	Correct Factor dB	Measure ment dBuV/m	Limit dBuV/m	Margin dB	Detector	Comment
1 *	5797.4000	69.76	42.84	112.60	122.30	-9.70	Peak	
2	5798.0000	57.41	42.84	100.25	122.30	-22.05	AVG	
3	5850.0000	23.32	43.03	66.35	122.30	-55.95	Peak	
4	5850.0000	13.26	43.03	56.29	122.30	-66.01	AVG	
5	5860.0000	21.97	43.06	65.03	109.50	-44.47	Peak	
6	5860.0000	11.78	43.06	54.84	109.50	-54.66	AVG	

Orthogonal Axis:	X
Test Mode:	UNII-3/TX AC40 Mode 5795MHz

Vertical

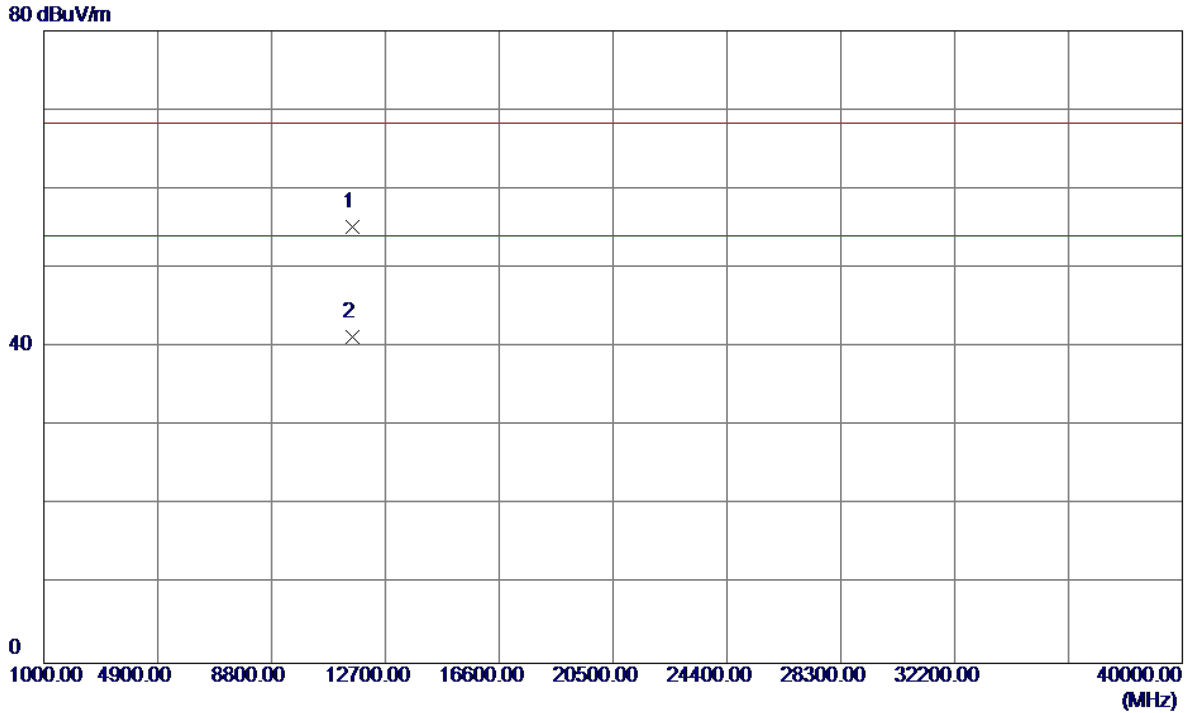

No.	Freq. MHz	Reading Level dBuV/m	Correct Factor dB	Measure ment dBuV/m	Limit dBuV/m	Margin dB	Detector	Comment
1	11589.0000	39.76	15.48	55.24	68.30	-13.06	Peak	
2 *	11589.8000	25.79	15.48	41.27	54.00	-12.73	AVG	

Orthogonal Axis:	X
Test Mode:	UNII-3/TX AC40 Mode 5795MHz

Horizontal

124 dBuV/m

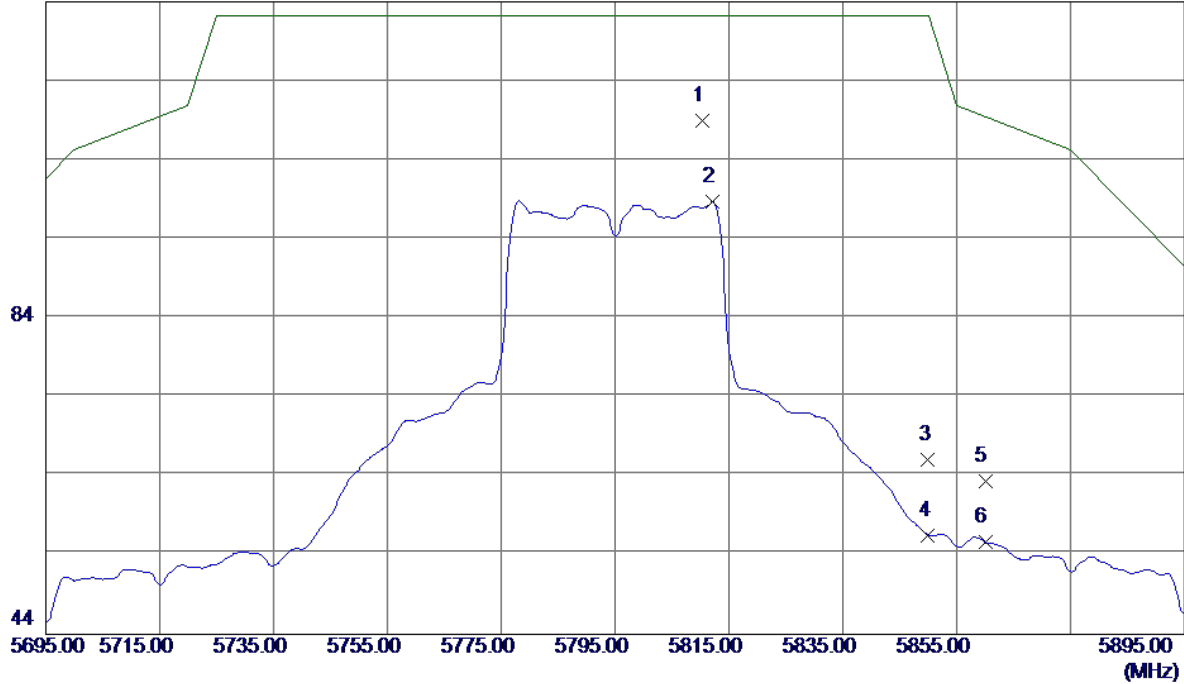

No.	Freq. MHz	Reading Level dBuV/m	Correct Factor dB	Measure ment dBuV/m	Limit dBuV/m	Margin dB	Detector	Comment
1 *	5810.4000	66.02	42.88	108.90	122.30	-13.40	Peak	
2	5812.2000	55.79	42.89	98.68	122.30	-23.62	AVG	
3	5850.0000	23.00	43.03	66.03	122.30	-56.27	Peak	
4	5850.0000	13.50	43.03	56.53	122.30	-65.77	AVG	
5	5860.0000	20.31	43.06	63.37	109.50	-46.13	Peak	
6	5860.0000	12.58	43.06	55.64	109.50	-53.86	AVG	

Orthogonal Axis:	X
Test Mode:	UNII-3/TX AC40 Mode 5795MHz

Horizontal

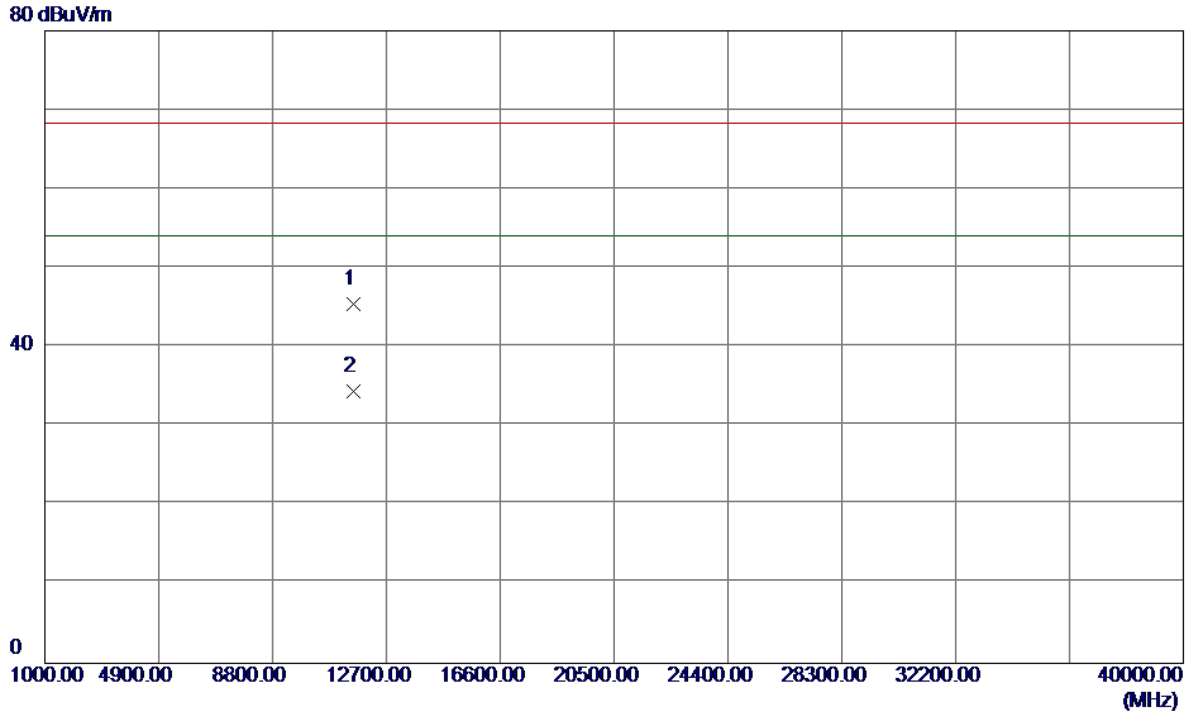

No.	Freq. MHz	Reading Level dBuV/m	Correct Factor dB	Measure ment dBuV/m	Limit dBuV/m	Margin dB	Detector	Comment
1	11588.6000	29.97	15.48	45.45	68.30	-22.85	Peak	
2 *	11590.2000	18.91	15.48	34.39	54.00	-19.61	AVG	

Orthogonal Axis:	X
Test Mode:	UNII-3/TX AC80 Mode 5775MHz

Vertical

124 dBuV/m

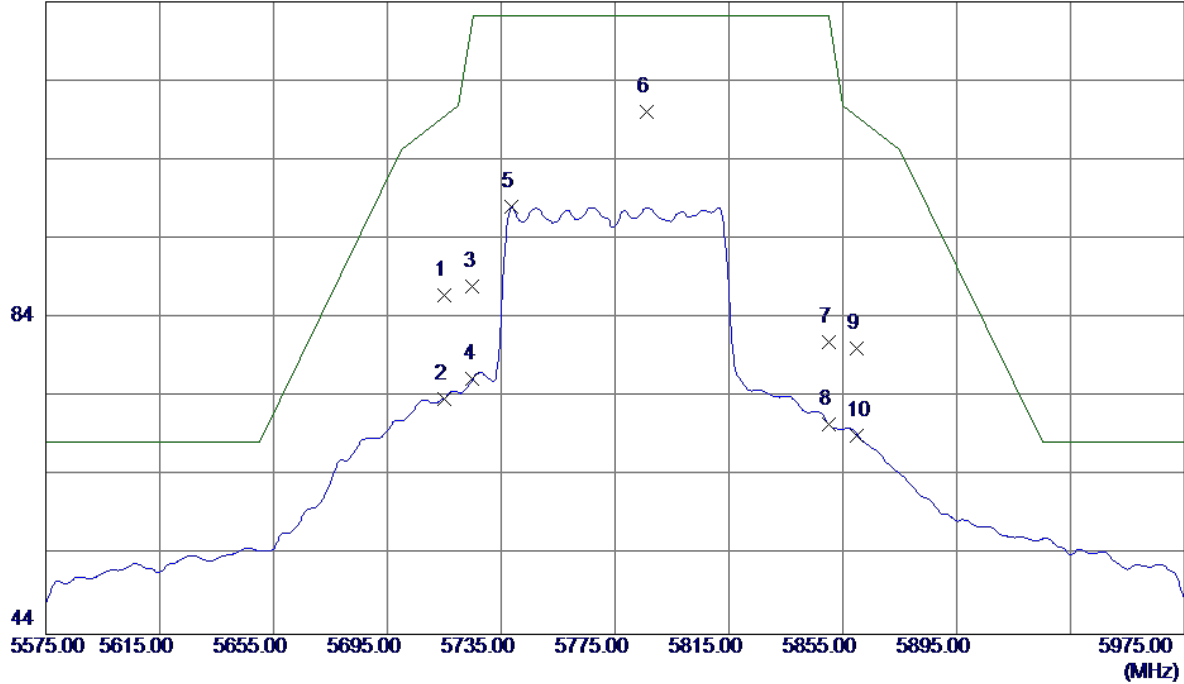

No.	Freq. MHz	Reading Level dBuV/m	Correct Factor dB	Measure ment dBuV/m	Limit dBuV/m	Margin dB	Detector	Comment
1	5715.0000	44.31	42.55	86.86	109.50	-22.64	Peak	
2	5715.0000	31.27	42.55	73.82	109.50	-35.68	AVG	
3	5725.0000	45.48	42.58	88.06	122.30	-34.24	Peak	
4	5725.0000	33.78	42.58	76.36	122.30	-45.94	AVG	
5	5738.6000	55.39	42.63	98.02	122.30	-24.28	AVG	
6 *	5786.2000	67.27	42.80	110.07	122.30	-12.23	Peak	
7	5850.0000	37.97	43.03	81.00	122.30	-41.30	Peak	
8	5850.0000	27.50	43.03	70.53	122.30	-51.77	AVG	
9	5860.0000	37.17	43.06	80.23	109.50	-29.27	Peak	
10	5860.0000	26.11	43.06	69.17	109.50	-40.33	AVG	

Orthogonal Axis:	X
Test Mode:	UNII-3/TX AC80 Mode 5775MHz

Vertical

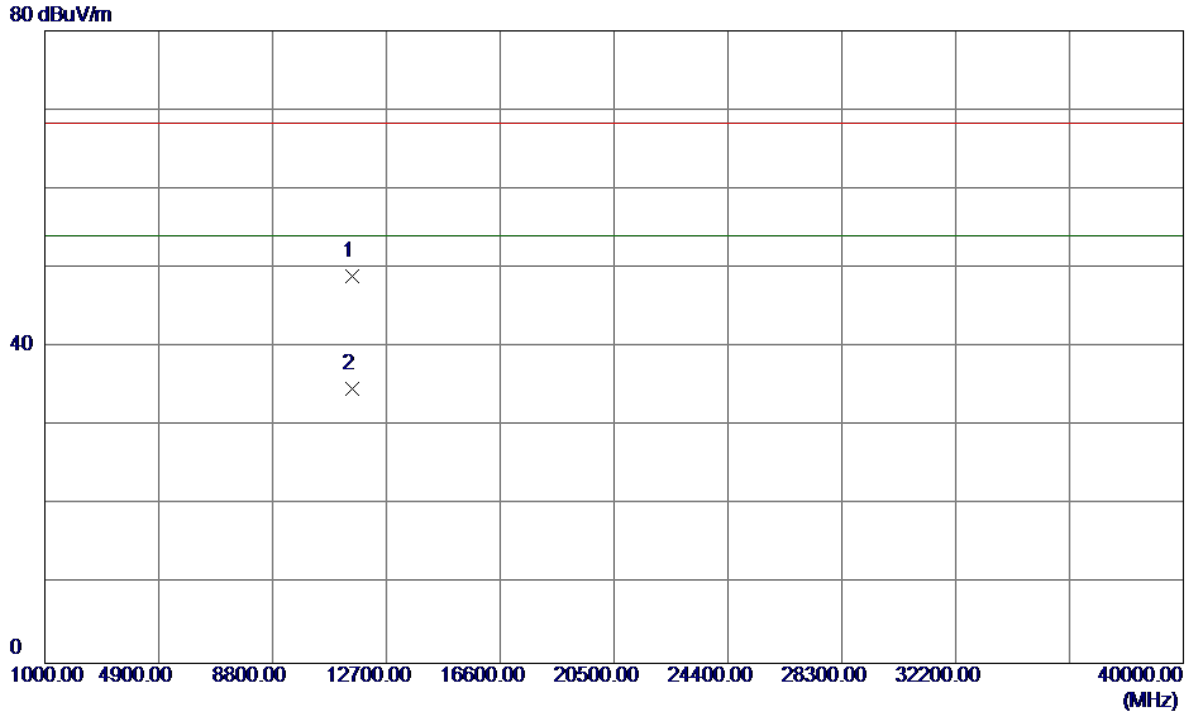

No.	Freq. MHz	Reading Level dBuV/m	Correct Factor dB	Measure ment dBuV/m	Limit dBuV/m	Margin dB	Detector	Comment
1	11547.6000	33.42	15.48	48.90	68.30	-19.40	Peak	
2 *	11550.8000	19.22	15.48	34.70	54.00	-19.30	AVG	

Orthogonal Axis:	X
Test Mode:	UNII-3/TX AC80 Mode 5775MHz

Horizontal

124 dBuV/m

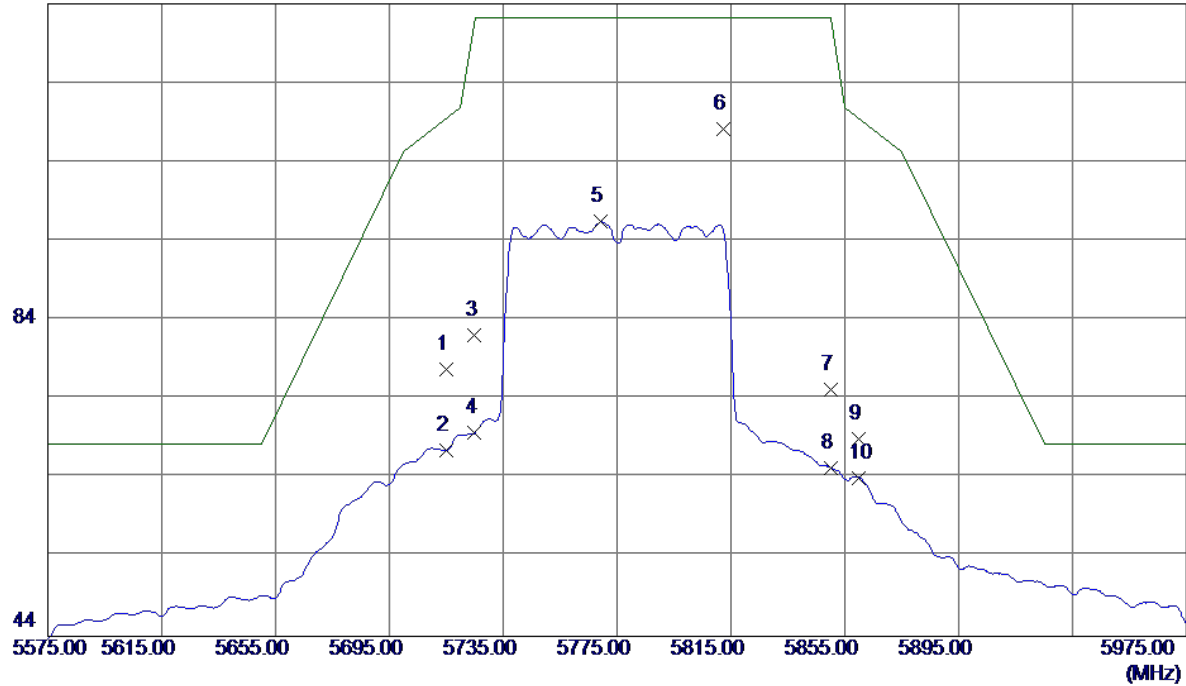

No.	Freq. MHz	Reading Level dBuV/m	Correct Factor dB	Measure ment dBuV/m	Limit dBuV/m	Margin dB	Detector	Comment
1	5715.0000	35.17	42.55	77.72	109.50	-31.78	Peak	
2	5715.0000	24.90	42.55	67.45	109.50	-42.05	AVG	
3	5725.0000	39.46	42.58	82.04	122.30	-40.26	Peak	
4	5725.0000	27.19	42.58	69.77	122.30	-52.53	AVG	
5	5769.4000	53.66	42.74	96.40	122.30	-25.90	AVG	
6 *	5812.2000	65.29	42.89	108.18	122.30	-14.12	Peak	
7	5850.0000	32.18	43.03	75.21	122.30	-47.09	Peak	
8	5850.0000	22.30	43.03	65.33	122.30	-56.97	AVG	
9	5860.0000	25.85	43.06	68.91	109.50	-40.59	Peak	
10	5860.0000	21.01	43.06	64.07	109.50	-45.43	AVG	

Orthogonal Axis:	X
Test Mode:	UNII-3/TX AC80 Mode 5775MHz

Horizontal

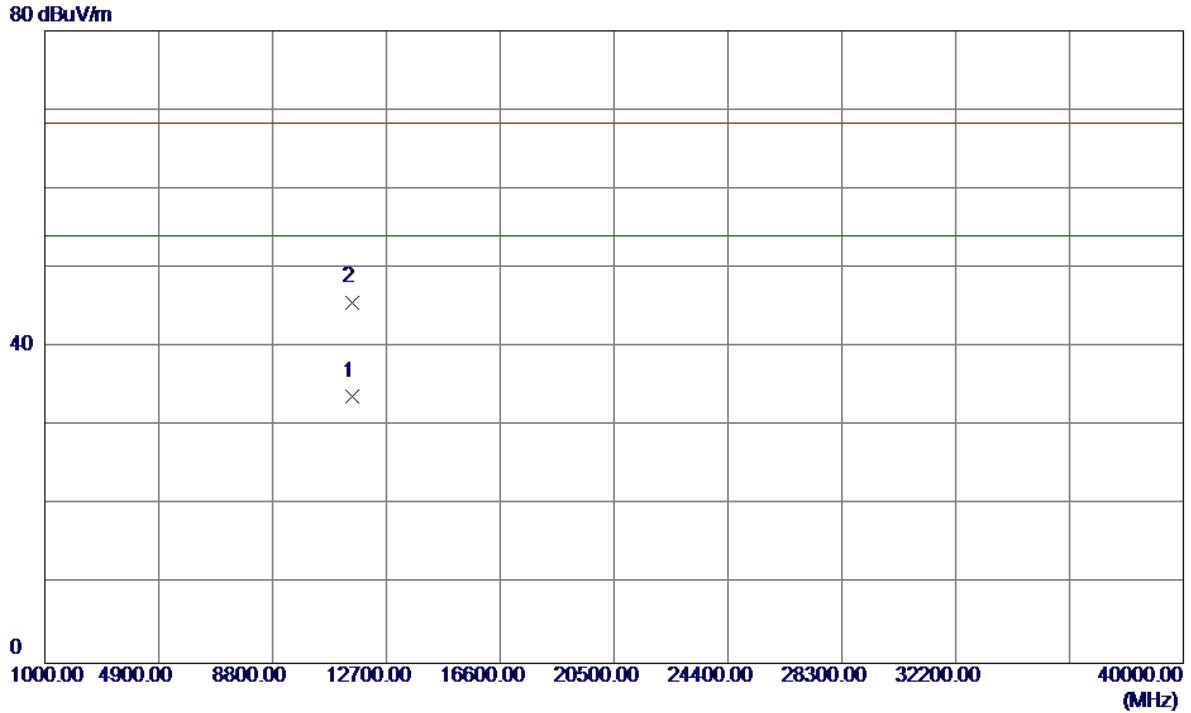

No.	Freq. MHz	Reading Level dBuV/m	Correct Factor dB	Measure ment dBuV/m	Limit dBuV/m	Margin dB	Detector	Comment
1 *	11548.6000	18.31	15.48	33.79	54.00	-20.21	AVG	
2	11549.4000	30.20	15.48	45.68	68.30	-22.62	Peak	

TX A Mode_DUTY CYCLE

Duty cycle: TX DUTYMHZ

$$\text{Duty cycle} = T_{\text{ON}} / T_{\text{Total}}$$

T_{ON} :2.06msec

T_{Total} :2.17msec

Duty cycle: 94.93%

$$\text{Duty Factor} = 10 \log(1/\text{Duty cycle})$$

Duty Factor =0.23

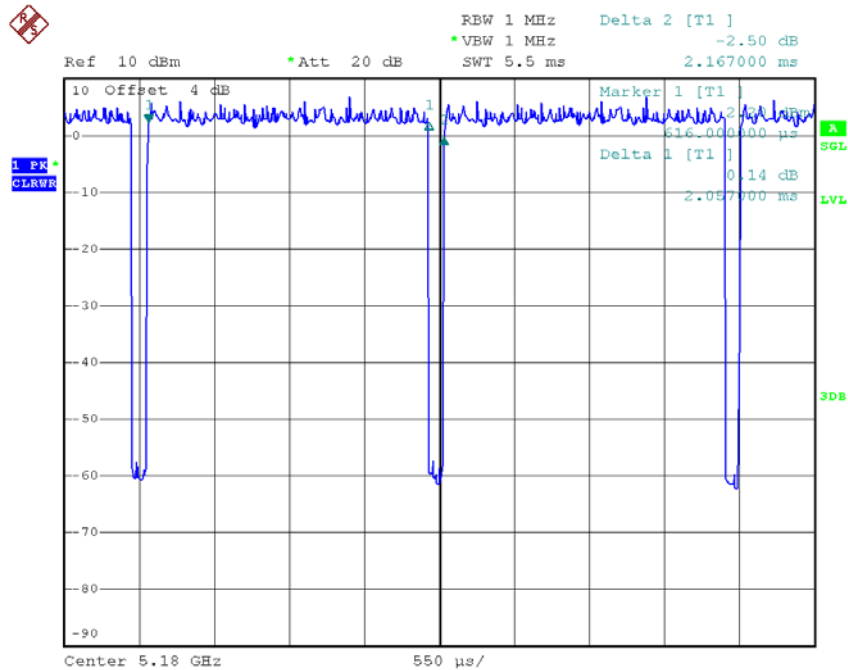

Date: 16.AUG.2016 17:21:49

Note: The EUT was programmed to be in continuously transmitting mode and the transmit duty cycle is not less than 98 %, so, the output power and power density should be calculated as
 Output Power = Measured power + Duty factor
 Power Spectral Density = Measured density + Duty factor

TX N20 Mode_DUTY CYCLE

Duty cycle: TX DUTYMHZ

Duty cycle = T_{ON} / T_{Total}

T_{ON} :1.92msec

T_{Total} :2.02msec

Duty cycle: 95.05%

Duty Factor= $10 \log(1/\text{Duty cycle})$

Duty Factor =0.22

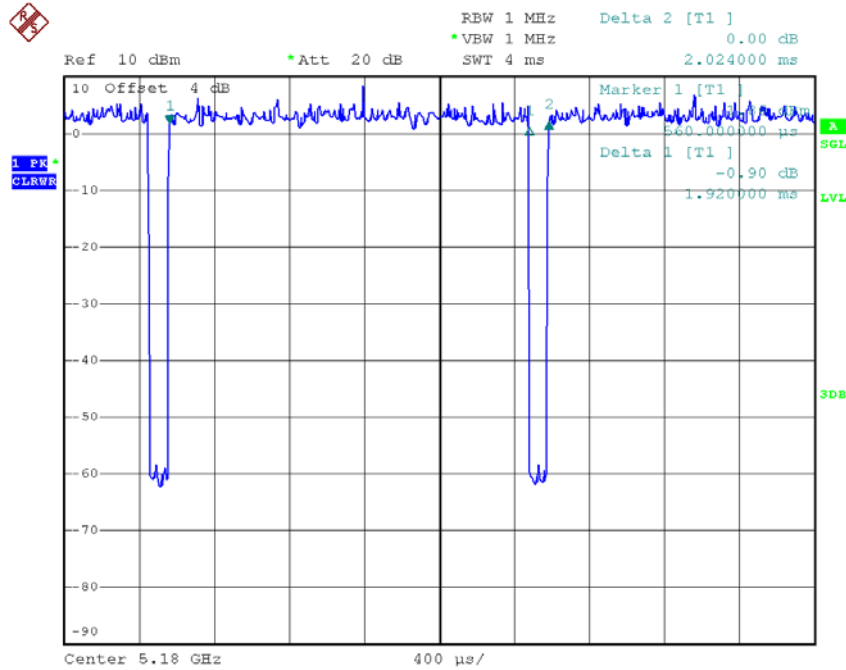

Date: 16.AUG.2016 17:22:05

Note: The EUT was programmed to be in countinously transmitting mode and the transmit duty cycle is not less than 98 %, so, the output power and power density should be cacluated as
 asOutput Power = Measured power + Ducus factor
 Power Spectral Density = Measured density + Duty factor

TX N40 Mode_DUTY CYCLE

Duty cycle: TX DUTYMHZ

Duty cycle = T_{ON} / T_{Total}

T_{ON} :0.92msec

T_{Total} :1.05msec

Duty cycle: 87.62%

Duty Factor= $10 \log(1/Duty \text{ cycle})$

Duty Factor =0.57

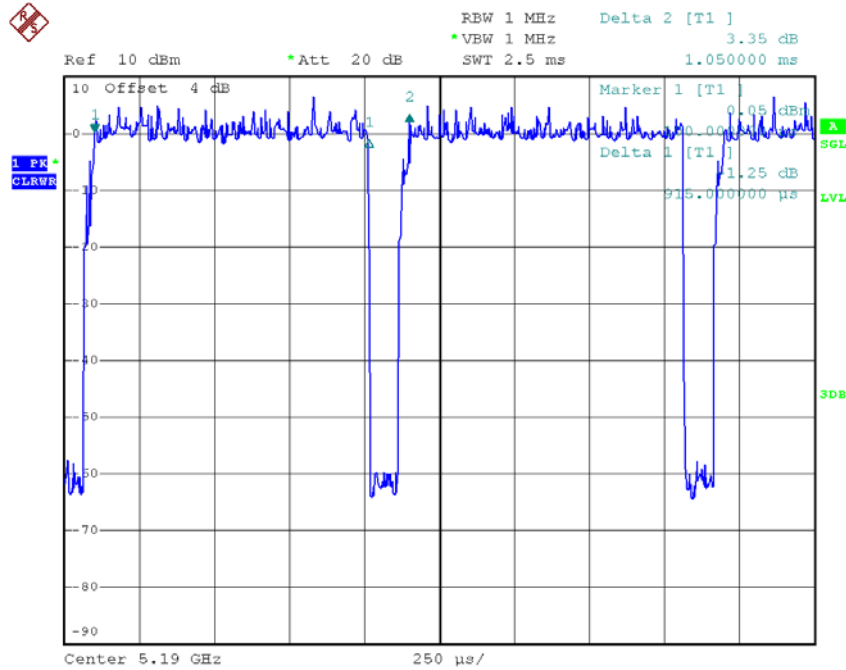

Date: 16.AUG.2016 17:30:02

Note: The EUT was programmed to be in countinously transmitting mode and the transmit duty cycle is not less than 98 %, so, the output power and power density should be cacluated as
 asOutput Power = Measured power + Ducus factor
 Power Spectral Density = Measured density + Duty factor

TX AC20 Mode_DUTY CYCLE

Duty cycle: TX DUTYMHZ

$$\text{Duty cycle} = T_{\text{ON}} / T_{\text{Total}}$$

T_{ON} :1.93msec

T_{Total} :1.97msec

Duty cycle: 97.97%

Duty Factor= $10 \log(1/\text{Duty cycle})$

Duty Factor =0.09

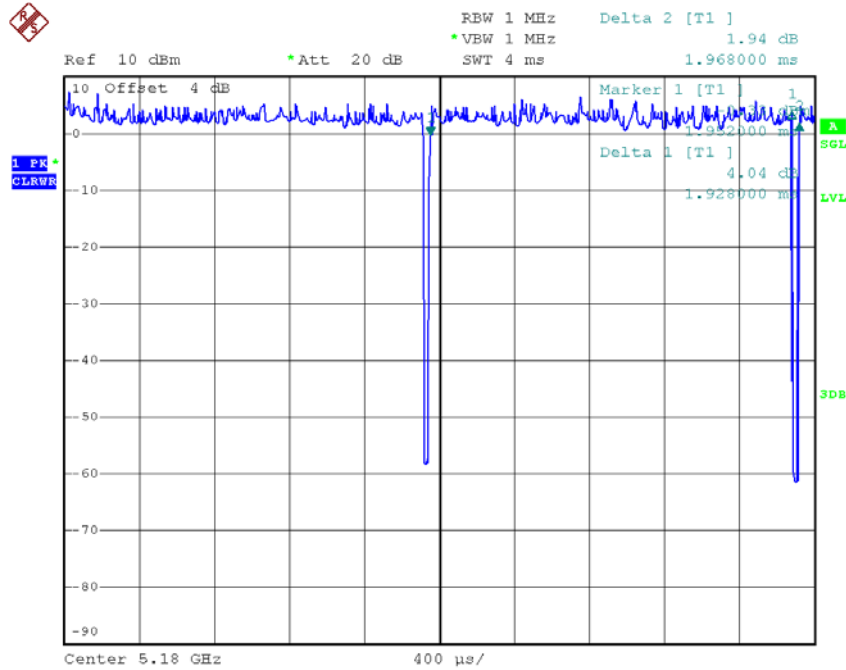

Date: 16.AUG.2016 17:25:03

Note: The EUT was programmed to be in continuously transmitting mode and the transmit duty cycle is not less than 98 %, so, the output power and power density should be calculated as
 Output Power = Measured power + Duty factor
 Power Spectral Density = Measured density + Duty factor

TX AC40 Mode_DUTY CYCLE

Duty cycle: TX DUTYMHZ

$$\text{Duty cycle} = T_{\text{ON}} / T_{\text{Total}}$$

T_{ON} :0.94msec

T_{Total} :0.98msec

Duty cycle: 95.92%

$$\text{Duty Factor} = 10 \log(1/\text{Duty cycle})$$

Duty Factor =0.18

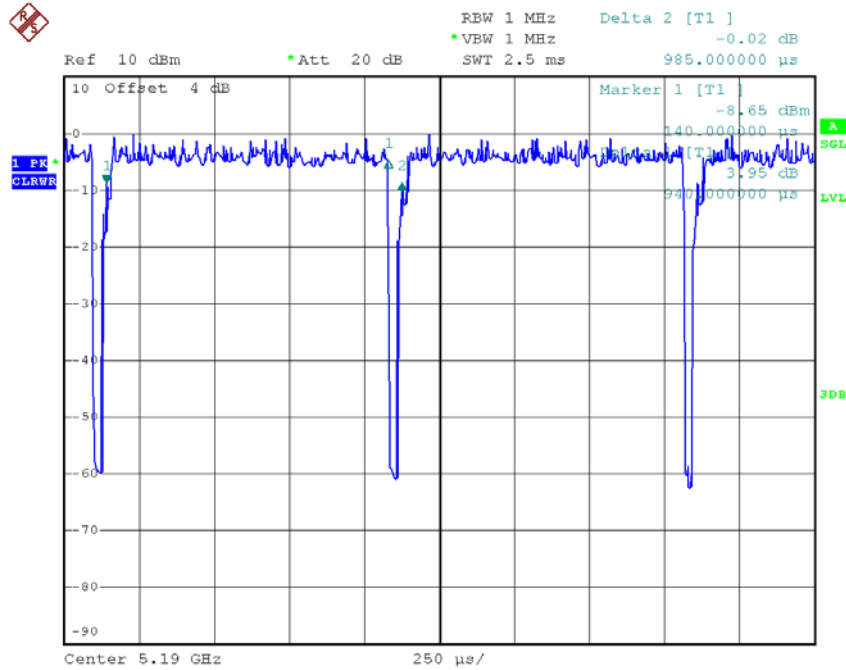

Date: 16.AUG.2016 17:28:09

Note: The EUT was programmed to be in countinously transmitting mode and the transmit duty cycle is not less than 98 %, so, the output power and power density should be cacluated as
 asOutput Power = Measured power + Ducus factor
 Power Spectral Density = Measured density + Duty factor

TX AC80 Mode_DUTY CYCLE

Duty cycle: TX DUTYMHZ

Duty cycle = T_{ON} / T_{Total}

T_{ON} :0.43msec

T_{Total} :0.49msec

Duty cycle: 87.76%

Duty Factor= $10 \log(1/\text{Duty cycle})$

Duty Factor =0.57

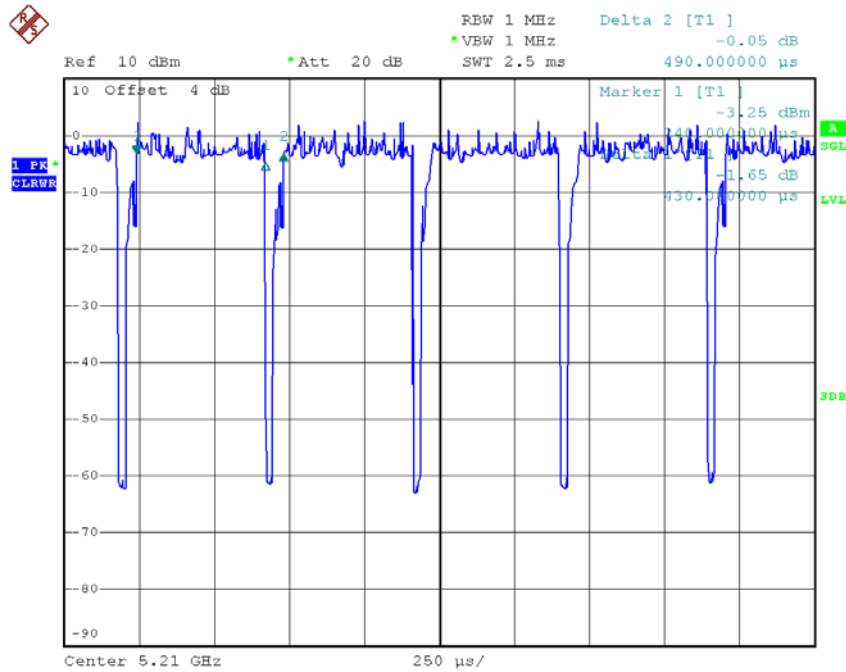

Date: 16.AUG.2016 17:29:19

Note: The EUT was programmed to be in countinously transmitting mode and the transmit duty cycle is not less than 98 %, so, the output power and power density should be cacluated as
 asOutput Power = Measured power + Ducus factor
 Power Spectral Density = Measured density + Duty factor

ATTACHMENT E -BANDWIDTH

Test Mode: UNII-1/TX A Mode_CH36/CH40/CH48

Channel	Frequency (MHz)	26dB Bandwidth (MHz)	99% Occupied Bandwidth (MHz)
CH36	5180	41.75	26.10
CH40	5200	41.55	25.40
CH48	5240	36.65	22.30

TX CH36

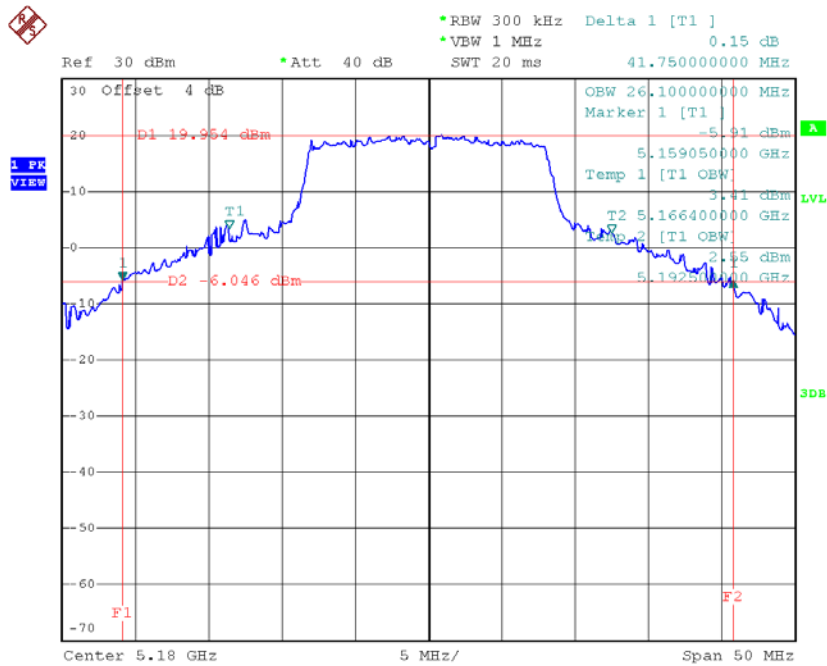

Date: 16.AUG.2016 17:42:27

TX CH40

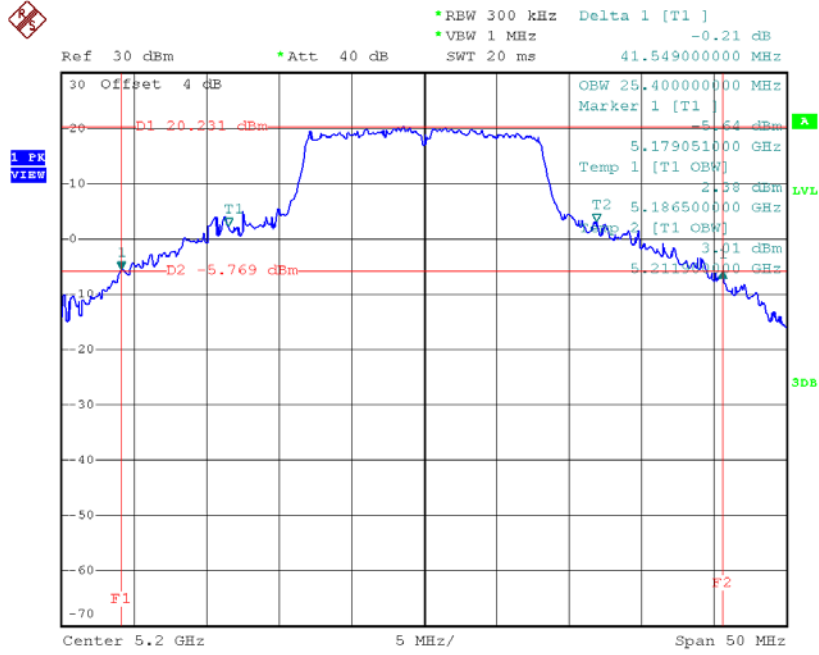

Date: 16.AUG.2016 17:43:44

TX CH48

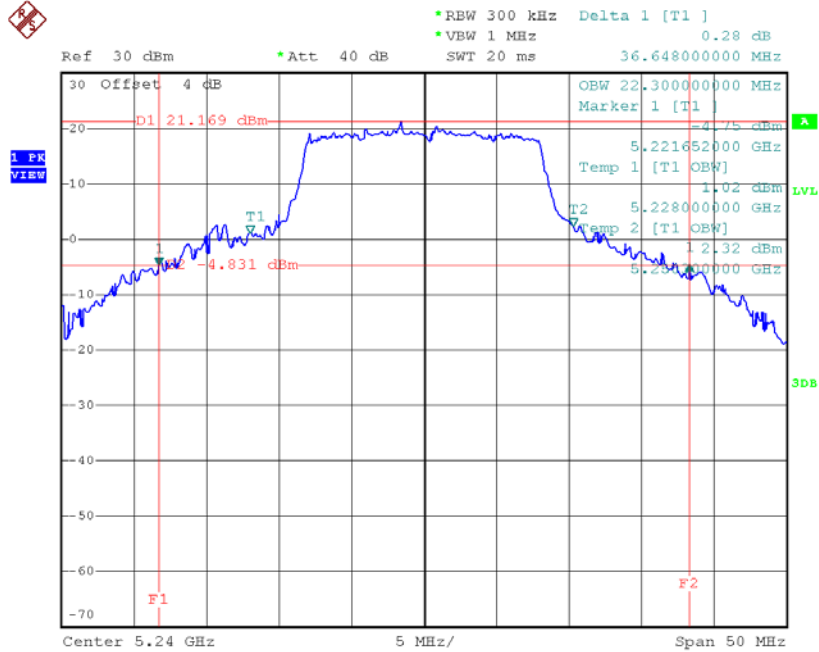

Date: 16.AUG.2016 17:44:30

Test Mode: UNII-1/TXN20 Mode_CH36/CH40/CH48

Channel	Frequency (MHz)	26dB Bandwidth (MHz)	99% Occupied Bandwidth (MHz)
CH36	5180	21.71	18.00
CH40	5200	30.60	18.10
CH48	5240	23.95	18.10

TX CH36

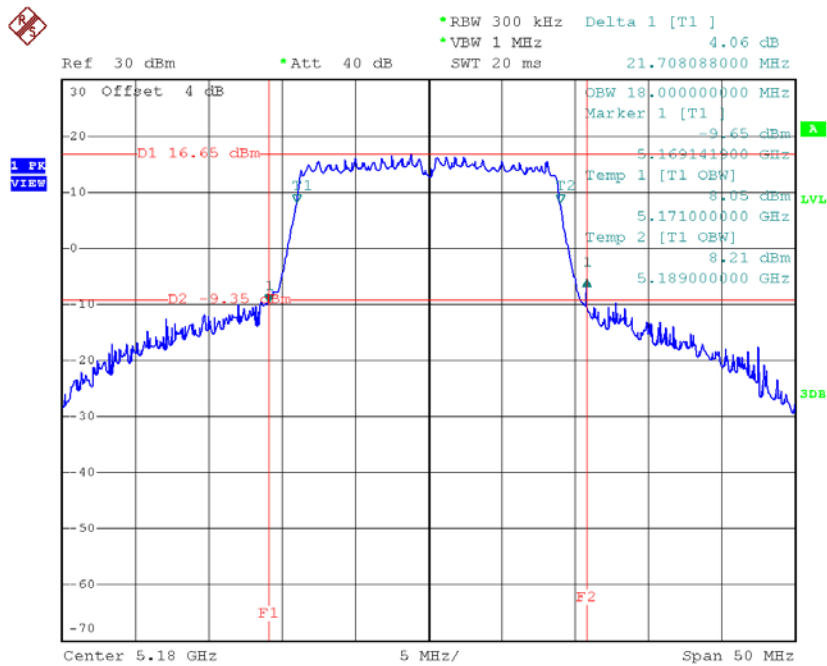

Date: 16.AUG.2016 19:17:39

TX CH40

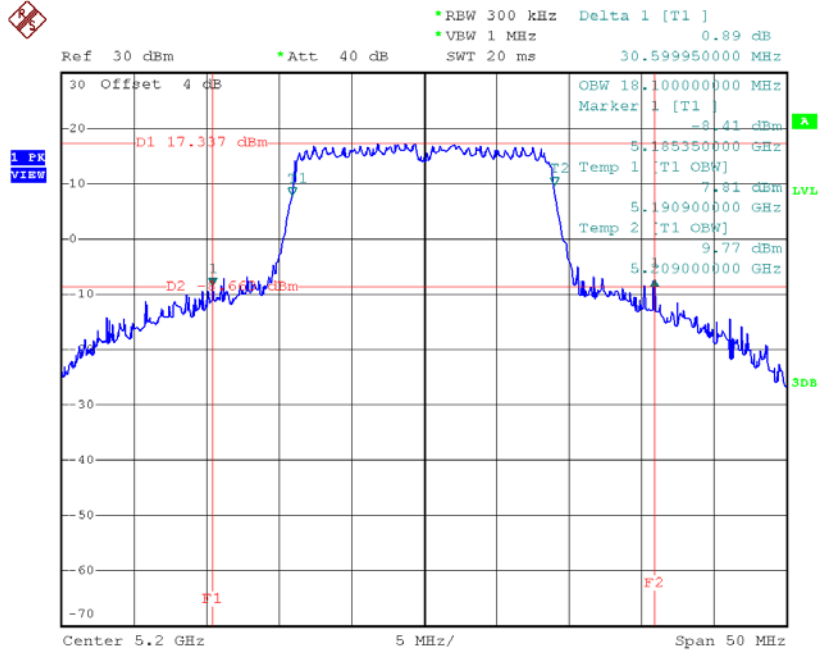

Date: 16.AUG.2016 19:18:34

TX CH48

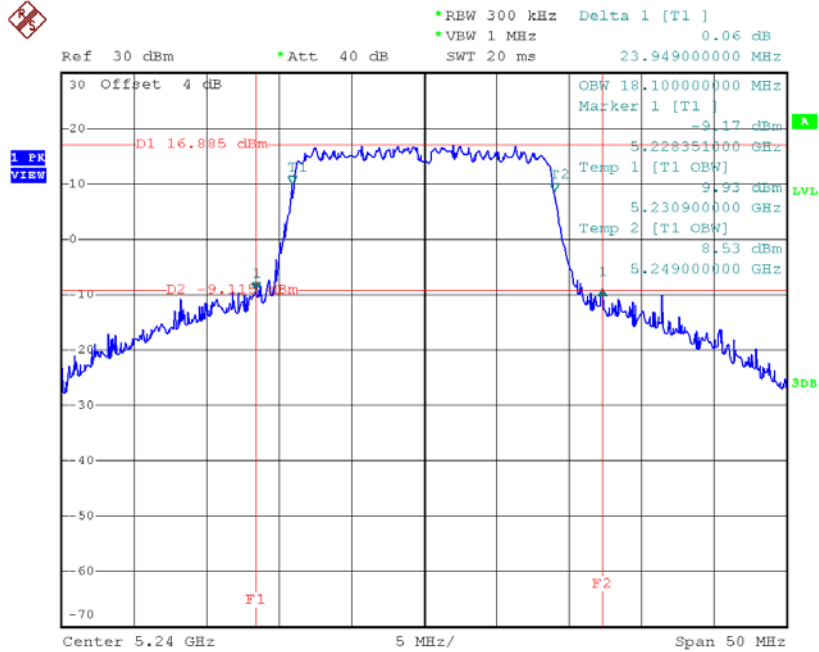

Date: 16.AUG.2016 19:19:24

Test Mode: UNII-1/TX N40 Mode_CH38/CH46

Channel	Frequency (MHz)	26dB Bandwidth (MHz)	99% Occupied Bandwidth (MHz)
CH38	5190	75.30	36.80
CH46	5230	65.80	36.40

TX CH38

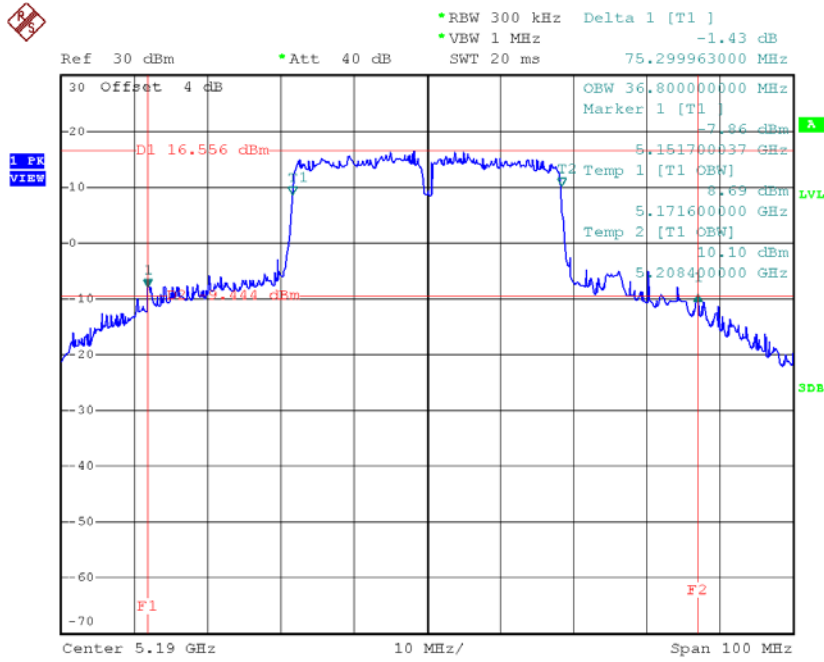

Date: 16.AUG.2016 20:39:05

TX CH46

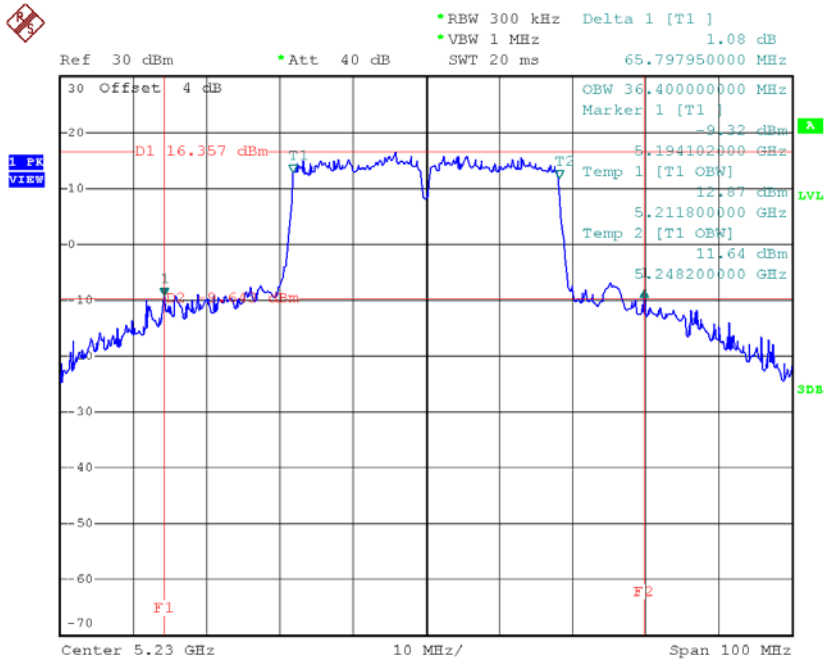

Date: 16.AUG.2016 20:39:53

Test Mode: UNII-3/ TX A Mode_CH149/CH157/CH165

Channel	Frequency (MHz)	6dB Bandwidth (MHz)	99% Occupied Bandwidth (MHz)	Limit (kHz)
CH149	5745	16.39	29.60	>=500
CH157	5785	16.45	30.40	>=500
CH165	5825	16.45	31.70	>=500

TX CH 149

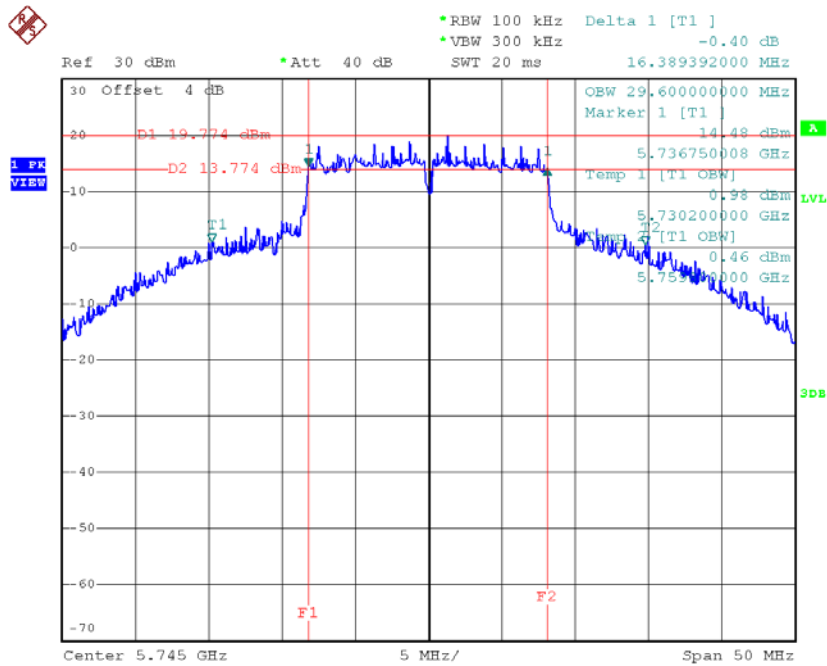

Date: 16.AUG.2016 17:46:22

TX CH 157

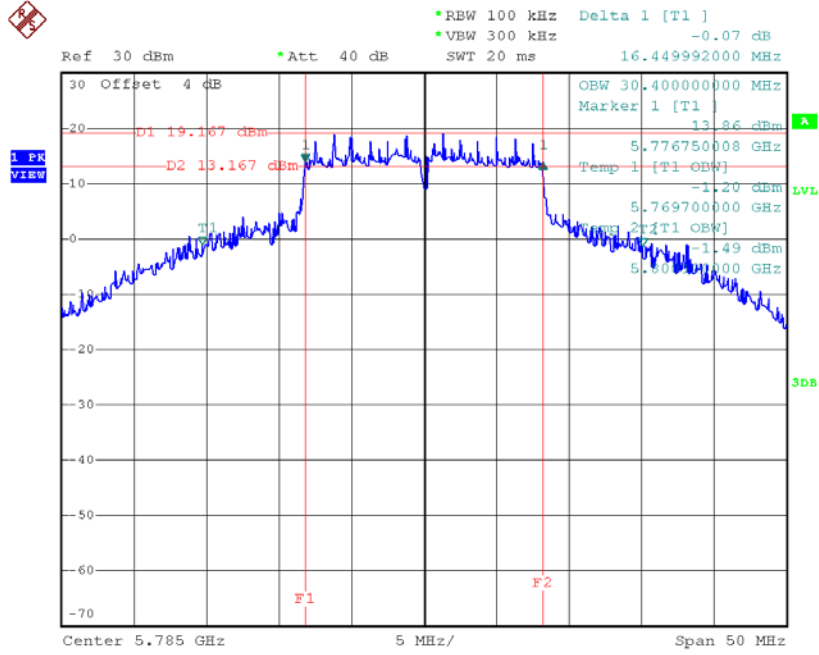

Date: 16.AUG.2016 17:47:08

TX CH 165

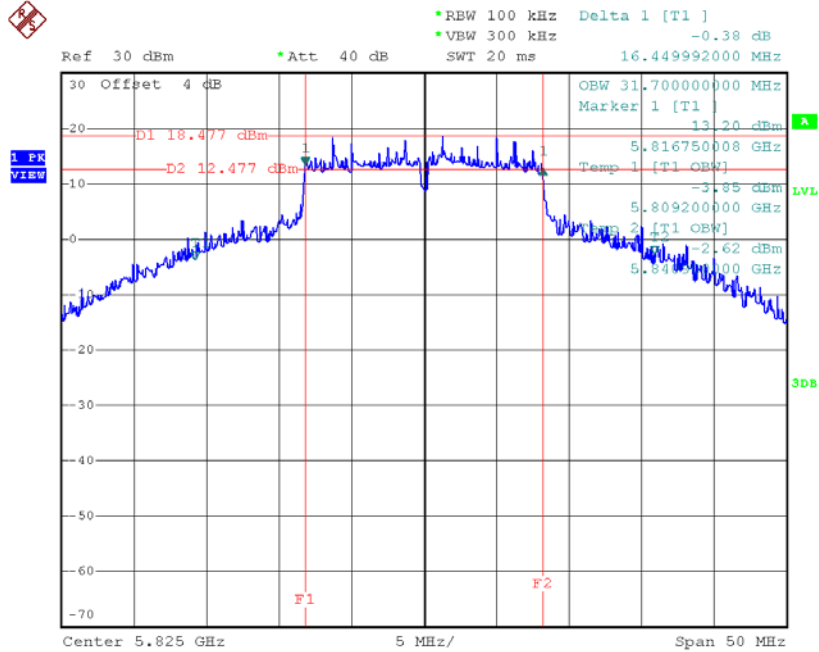

Date: 16.AUG.2016 17:47:50

Test Mode: UNII-3/ TX N20 Mode_CH149/CH157/CH165

Channel	Frequency (MHz)	6dB Bandwidth (MHz)	99% Occupied Bandwidth (MHz)	Limit (kHz)
CH149	5745	17.65	17.80	>=500
CH157	5785	17.65	17.80	>=500
CH165	5825	17.65	17.80	>=500

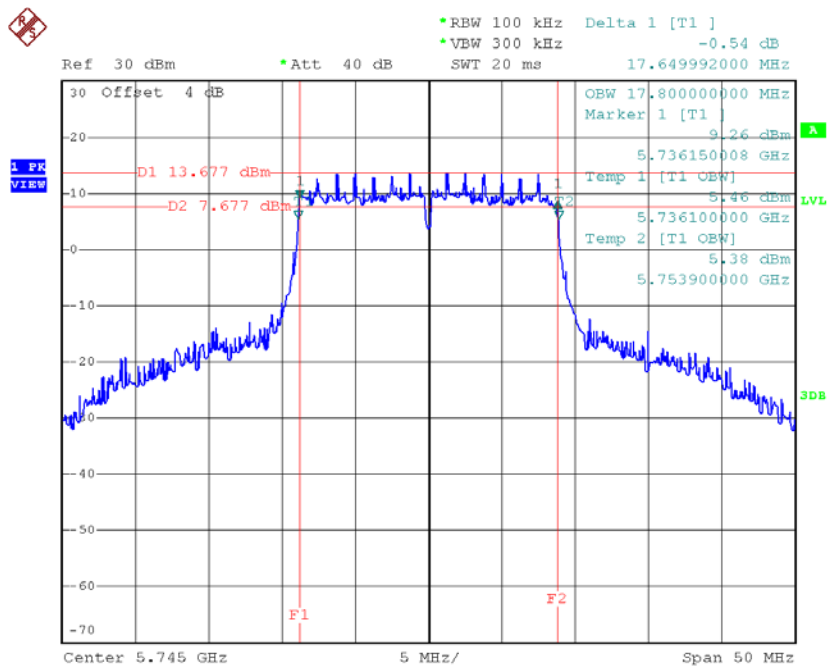
TX CH 149

Date: 16.AUG.2016 19:20:19