

Measurement of Antenna for AC10 Project

Manufacture: SHENZHEN TENDA TECHNOLOGY CO.,LTD.

1. Antenna Appearance:

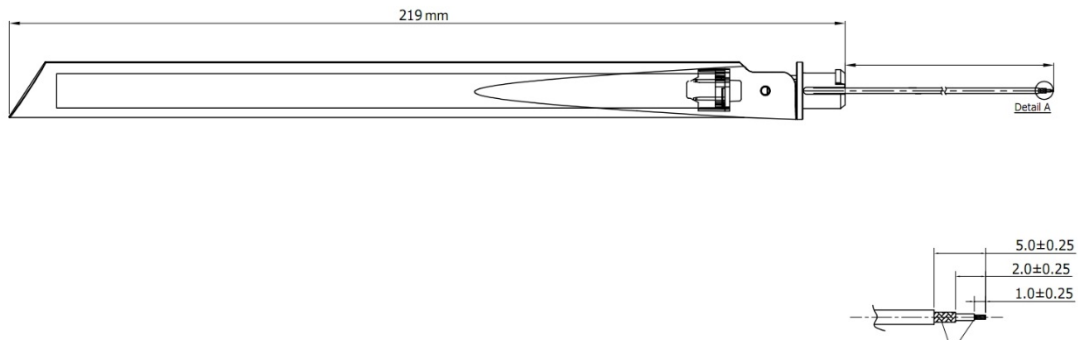

For 2.4GHz

2. Measurement of Reflection Coefficients and Isolation

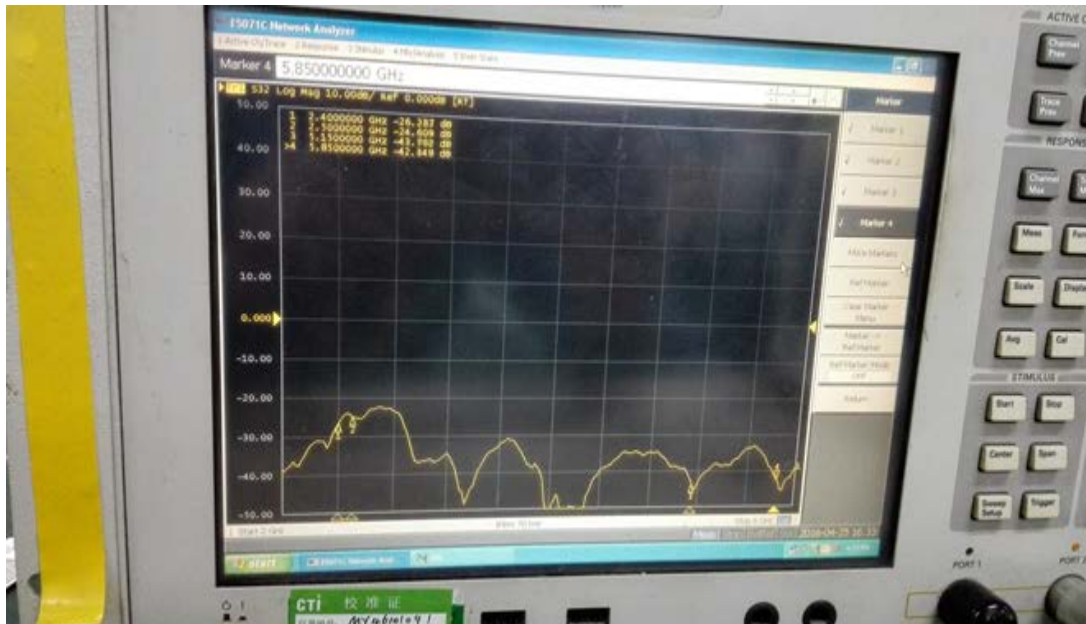

II Radiation Patterns and Gain

1. Measurement (**Balun**)

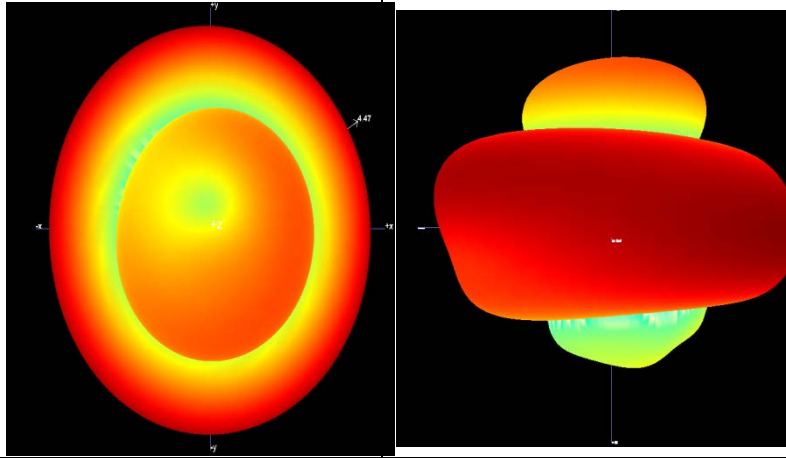
Dual-band antenna		
Operating Frequency band: 2.41-2.49G Hz/	Gain	5 dBi
	Efficiency	70- 98%
3D radiation patterns	2450 MHz	

EUT		
note		
Frequency	E Total. dB(dB)	Efficiency()
2400MHz	4.49	70%
2410MHz	4.56	73%
2420MHz	4.75	78%
2430MHz	5	82%
2440MHz	4.70	84%
2450MHz	4.47	85%
2460MHz	4.58	87%
2470MHz	5	92%
2480MHz	5	92%
2490MHz	5	92%
2500MHz	5	94%
	XOY PLANE	XOZ PLANE

SHENZHEN TENDA TECHNOLOGY CO.,LTD.

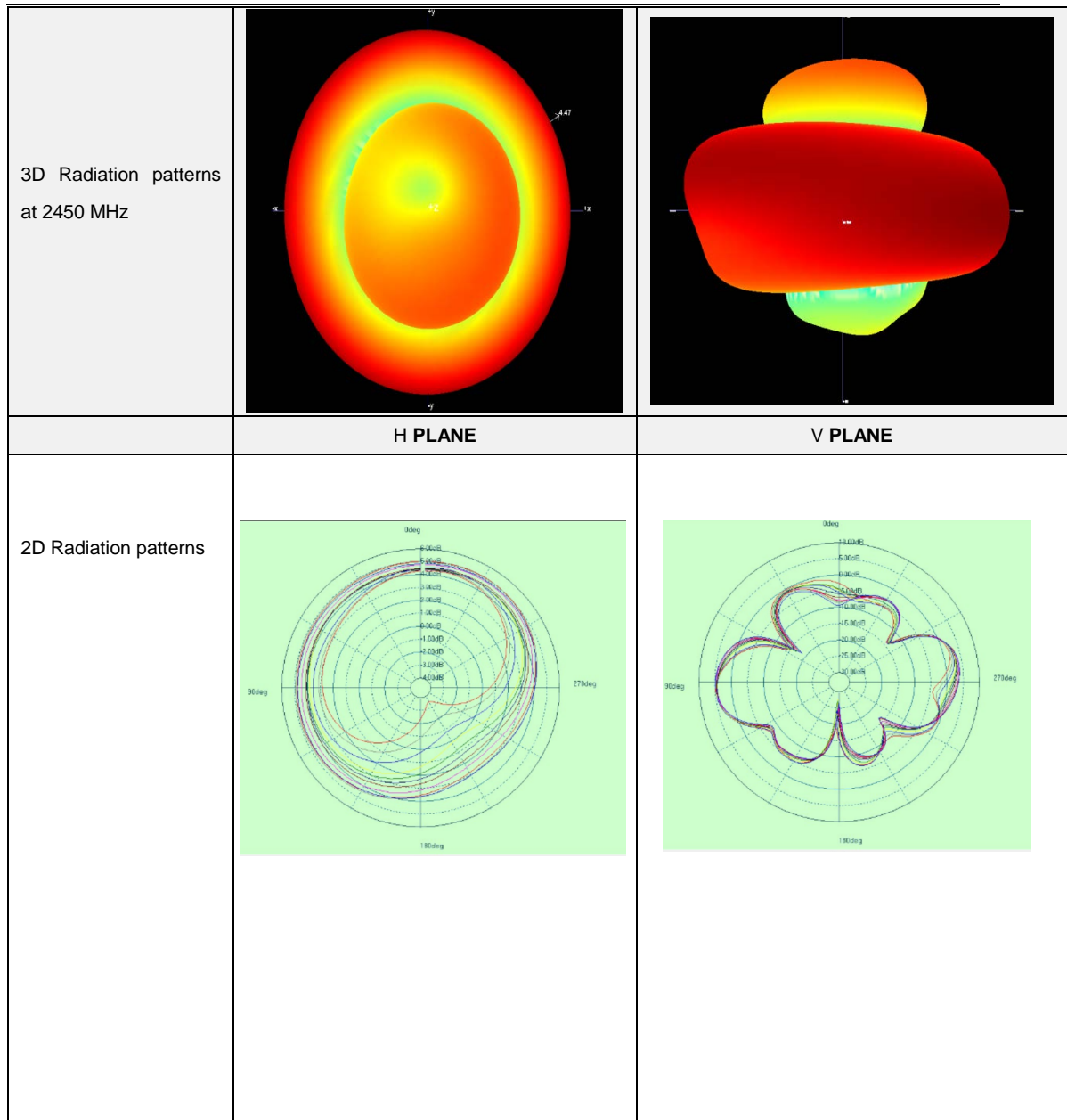

For 5GHz

2.Measurement of Reflection Coefficients and Isolation

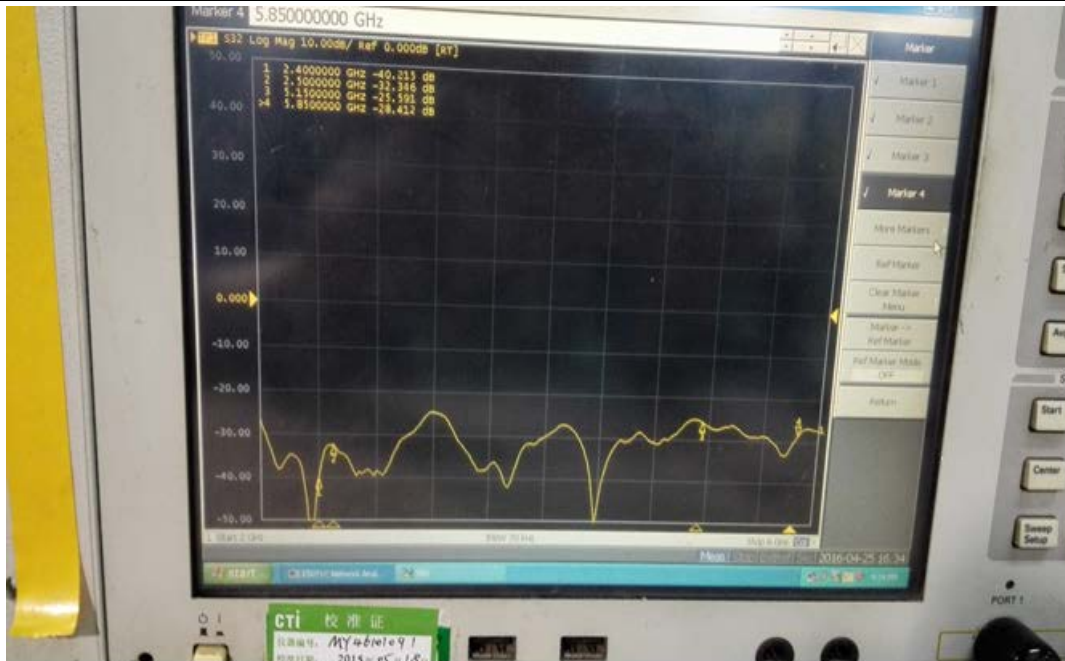

II Radiation Patterns and Gain

1. Measurement (Balun)

Dual-band antenna		
Operating Frequency band: 5.15-5.85G Hz/	Gain	5 dBi
	Efficiency	74- 78%
3D radiation patterns	5150 MHz	

SHENZHEN TENDA TECHNOLOGY CO.,LTD.

--	--

Frequency	E Total. dB(dBi)	Efficiency()
5150MHz	5	77%
5200MHz	5	79%
5250MHz	5	79%
5700MHz	5	76%
5750MHz	5	77%
5800MHz	5	74%
5850MHz	5	77%
5900MHz	5	74%

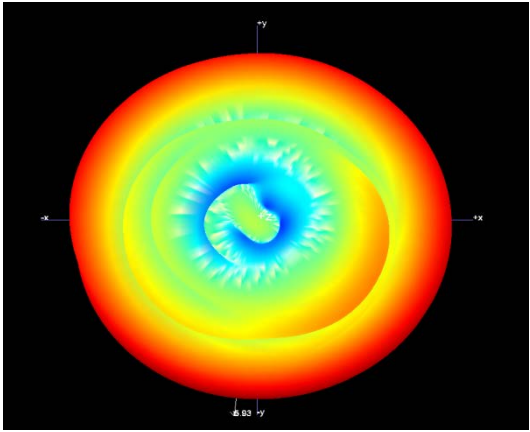
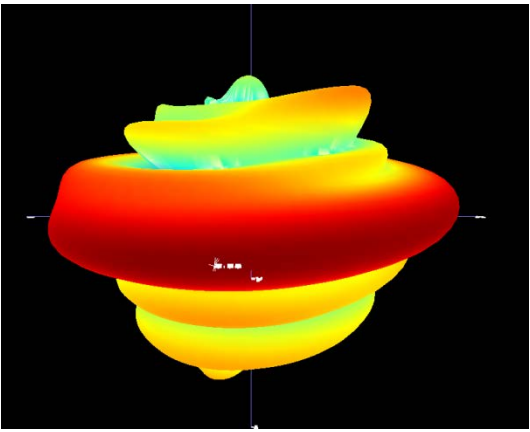
	XOY_PLANE	XOZ PLANE
3D Radiation patterns at 5150 MHz		
2D Radiation patterns	