

APPLICATION FOR CERTIFICATION

On Behalf of

Texas Instruments Incorporated
TI-Nspire Navigator Access Point

Model No. : TINAVAP2
Brand : TEXAS INSTRUMENTS
FCC ID : V7R-TINAVAP2

Prepared for

Texas Instruments Incorporated
12500 TI Boulevard Dallas, TX 75243-4136 USA

Prepared by

Audix Technology (Wujiang) Co., Ltd. EMC Dept.
No. 1289 Jiangxing East Road, the Part of Wujiang Economic Development Zone
Jiangsu China 215200

Tel : +86-512-63403993

Fax :+86-512-63403339

Report Number : ACWE-F1112002

Date of Test : Dec.07~10, 2011

Date of Report : Dec.15, 2011

TABLE OF CONTENTS

Description	Page
TEST REPORT CERTIFICATION	4
1. SUMMARY OF MEASUREMENTS AND RESULTS	4
2. GENERAL INFORMATION.....	5
2.1. Description of Device (EUT).....	5
2.2. UUT's Configuration.....	5
2.3. Description Test Configuration	6
2.4. Product Description and Features	6
2.5. Operating Condition of EUT	6
2.6. Tested Supporting System Details.....	6
2.7. Description of Test Facility	8
2.8. Measurement Uncertainty	8
3. CONDUCTED EMISSION MEASUREMENT	9
3.1. Test Equipment.....	9
3.2. Block Diagram of Test Setup.....	9
3.3. Power line Conducted Emission Limit	9
3.4. Test Procedure	10
3.5. Conducted Emission Measurement Results.....	10
4. RADIATED EMISSION MEASUREMENT.....	15
4.1. Test Equipment.....	15
4.2. Block Diagram of Test Setup.....	16
4.3. Radiated Emission Limits.....	17
4.4. Test Procedure	18
4.5. Measurement Results.....	19
4.6. Restricted Bands Measurement Results.....	29
4.7. Spurious Emission Measurement Results in Band Edge Emission (FCC Part 15, 15.205).....	35
5. 6 DB BANDWIDTH MEASUREMENT	59
5.1. Test Equipment.....	59
5.2. Block Diagram of Test Setup.....	59
5.3. Specification Limits (§15.247(a)(2))	59
5.4. Test Results.....	59
6. MAXIMUM PEAK OUTPUT POWER MEASUREMENT.....	65
6.1. Test Equipment.....	65
6.2. Block Diagram of Test Setup.....	65
6.3. Specification Limits (§15.247(b)(3)).....	65
6.4. Test Results.....	65
7. BAND EDGES MEASUREMENT	68
7.1. Test Equipment.....	68
7.2. Block Diagram of Test Setup.....	68
7.3. Specification Limits (§15.247(d)).....	68
7.4. Test Results.....	68
8. POWER SPECTRAL DENSITY MEASUREMENT.....	72
8.1. Test Equipment.....	72
8.2. Block Diagram of Test Setup.....	72
8.3. Specification Limits (§15.247(e)).....	72
8.4. Test Results.....	72
9. EMISSION LIMITATIONS MEASUREMENT.....	78
9.1. Test Equipment.....	78
9.2. Block Diagram of Test Setup.....	78
9.3. Specification Limits (§15.247(d)).....	78
9.4. Test Results.....	79
10. DEVIATION TO TEST SPECIFICATIONS	85

TEST REPORT CERTIFICATION

Applicant : Texas Instruments Incorporated
 Manufacturer : Inventec Appliances(Pudong) Corporation
 EUT Description : TI-Nspire Navigator Access Point
 FCC ID : V7R-TINAVAP2
 (A) Model No. : TINAVAP2
 (B) Brand : TEXAS INSTRUMENTS
 (C) Power Supply : DC 5V (Via Laptop)
 (D) Test Voltage : DC 5V

Applicable Standards:

FCC RULES AND REGULATIONS PART 15 SUBPART C, Oct. 2010
ANSI C63.10-2009

The device described above was tested by Audix Technology (Wujiang) Co., Ltd. EMC Dept. to determine the maximum emission levels emanating from the device. The maximum emission levels were compared to the FCC Part 15 subpart C section 15.207, 15.205, 15.209&15.247 limits.

The measurement results are contained in this test report and Audix Technology (Wujiang) Co., Ltd. EMC Dept. is assumed full responsibility for the accuracy and completeness of these measurements. Also, this report shows that the EUT to be technically compliant with the FCC limits.

This report applies to above tested sample only. This report shall not be reproduced in part without written approval of Audix Technology (Wujiang) Co., Ltd. EMC Dept.

Date of Test: Dec.07~10, 2011

Date of Report: Dec.15, 2011

Prepared by :

 (Candy Tang/Senior Assistant)

Reviewer :

 (Kin Lin/Deputy Manager)

Approved & Authorized Signer :

 (Allen Wang/Senior Manager)

1. SUMMARY OF MEASUREMENTS AND RESULTS

The EUT have been tested according to the applicable standards as referenced below.

Description of Test Item	Standard	Results
CONDUCTED EMISSION	FCC 47 CFR Part 15 Subpart C/ Section 15.207 ANSI C63.10	PASS
RADIATED EMISSION	FCC 47 CFR Part 15 Subpart C/ Section 15.209& Section 15.205 ANSI C63.10	PASS
6 dB BANDWIDTH	FCC 47 CFR Part 15 Subpart C/ Section 15.247(a)(2) ANSI C63.10	PASS
MAXIMUM PEAK OUTPUT POWER	FCC 47 CFR Part 15 Subpart C/ Section 15.247(b)(3) ANSI C63.10	PASS
BAND EDGES	FCC 47 CFR Part 15 Subpart C/ Section 15.247(d) ANSI C63.10	PASS
POWER SPECTRAL DENSITY	FCC 47 CFR Part 15 Subpart C/ Section 15.247(e) ANSI C63.10	PASS
EMISSION LIMITATIONS	FCC 47 CFR Part 15 Subpart C/ Section 15.247(d) ANSI C63.10	PASS

Note: The EUT was pre-tested in three orthogonal planes for radiated measurements, the worst emission level was found in lying mode. Therefore only the test data of the mode were recorded in this report individually.

2. GENERAL INFORMATION

2.1. Description of Device (EUT)

Description	:	TI-Nspire Navigator Access Point
Model No.	:	TINAVAP2
FCC ID	:	V7R-TINAVAP2
Brand	:	TEXAS INSTRUMENTS
Applicant	:	Texas Instruments Incorporated 12500 TI Boulevard Dallas, TX 75243-4136 USA
Manufacturer	:	Inventec Appliances(Pudong) Corporation No. 789 Pu Xing Road, Shanghai, PRC
Radio Technology	:	DSSS & OFDM
Antenna Gain	:	3.4dBi
Type of Network		IEEE 802.11b/g/n HT20
Fundamental Range	:	2400 MHz -2483.5MHz
Tested Frequency	:	2412MHz (Channel 1) 2437MHz (Channel 6) 2462MHz (Channel 11)
Date of Receipt of Sample	:	Dec.05, 2011
Date of Test	:	Dec.07~10, 2011

2.2. UUT's Configuration

Test UUT	:	UUT×1
I/O Ports	:	I/O port×1

2.3. Description Test Configuration

Test Configuration according TEXAS INSTRUMENTS Education Technology for TI-Nspire Navigator Access Point EMC Test Plan (EMCTP 061507)

Configuration: UUT+ Laptop (On battery)

Note: For RF test, there is an additional Mini USB Port have been welded on the UUT, the Mini USB Port just for RF control.

2.4. Product Description and Features

The TI-Navigator Access Point is a moderately complex electronic product containing processor, memory, power and radio IC’s and numerous miscellaneous discrete electronic components, and a circuit board. The Navigator Access Point interfaces with computer via high speed USB and bridges between the PC and a WIFI access point radio. The TI-Navigator Access Point is the UUT. The Access Point will come with both a short(12”) and a long (60”) Standard A to Micro B cable.

Crystal and Oscillators

26MHz (Oscillator for USB and ARM)

40MHz (Crystal for radio)

32.768kHz (Oscillator for ARM)

USB Controller

60MHz (Clock)

30MHz (Data and control signals)

480MHz (Internal PLL to generate data)

Power Supply

2.25MHz (TPS62240, TPS62410)

ARM Processor

600MHz (ARM Core)

Memory

166MHz (DDR Memory)

Radio

2.4GHz

2.5. Operating Condition of EUT

2.5.1. Set up the EUT as test setup diagram.

2.5.2. For conducted or Radiated emission measurement, setup the EUT as the test configurations; turn on all the equipment, Drive the test software “TI-Nspire™ CAS Navigator™ Teacher Software 3.0.1.1753”, let EUT operate normal activity.

2.5.3. For other measurement items, keep the EUT be powered by the battery, Drive the test software “TI-Nspire™ CAS Navigator™ Teacher Software 3.0.1.1753”, let the EUT operate wireless TX activity under measurement.

2.6. Tested Supporting System Details

2.6.1. TI-nspire CX CAS (NSC)

Manufacturer	:	TI
Brand	:	TEXAS INSTRUMENTS

2.6.2. TI-Navigator Cradle

Manufacturer	:	TI
Brand	:	TEXAS INSTRUMENTS
Model No.	:	TINAVWC2

2.6.3. Laptop Computer

Manufacturer	:	DELL
Model Number	:	PP26L
Serial Number	:	JX193A01
FCC ID	:	FCC By DoC
Power Cord	:	Unshielded, Detachable, 1.5 m
AC Adapter	:	M/N: LA65NS1-00 Brand: DELL Input: AC 100-240V, 50-60Hz, 1.5A Output: DC 19.5V,3.34A DC Cord: Unshielded, Undetachable, 2.0m, 1 ferrite core.

2.7. Description of Test Facility

Name of Firm : **Audix Technology (Wujiang) Co., Ltd. EMC Dept.**

Site Location : No. 1289 Jiangxing East Road, the Eastern Part of Wujiang Economic Development Zone Jiangsu China 215200

Test Facilities : **No.1 10m semi-anechoic chamber**
 Date of Validity: Aug. 20, 2012
 FCC Registration No.: 252588

No.1 3m semi-anechoic chamber
 Date of Validity: Aug. 20, 2012
 FCC Registration No.: 897661

NVLAP Lab Code : 200786-0
 (NVLAP is a NATA accredited body under Mutual Recognition Agreement)
 Valid until on Sep.30, 2012

DAR-Registration No. : DAT-P-264/07-00
 Valid until on Dec.14, 2012

2.8. Measurement Uncertainty

Test Item	Range Frequency	Uncertainty
Conducted Disturbance Measurement	0.15MHz ~ 30MHz	± 2.84dB
Radiated Disturbance Measurement (At 10m Chamber)	30MHz ~ 1000MHz	± 3.26dB (Horizontal)
		± 3.49dB (Vertical)
Radiated Disturbance Measurement (At 10m Chamber)	Above 1GHz	± 4.66dB

Remark: Uncertainty = $ku_c(y)$

Test Item	Uncertainty
6 dB Bandwidth	± 2.8×10 ⁻⁶ MHz
Maximum Peak Output Power	± 0.33dB
Band Edges	± 0.208dB
Power Spectral Density	± 0.34dB
Emission Limitations	± 0.208dB
Temperature	±0.416°C
Humidity	±3.16%

Remark: Uncertainty = $ku_c(y)$

3. CONDUCTED EMISSION MEASUREMENT

3.1. Test Equipment

Item	Type	Manufacturer	Model No.	Serial No.	Last Cal.	Next Cal.
1.	Test Receiver	R & S	ESCI	100352	2011-01-04	2012-01-03
2.	A.M.N	R & S	ESH2-Z5	100153	2011-03-25	2012-03-23
3.	L.I.S.N.	Kyoritsu	KNW-407	8-1793-4	2011-08-06	2012-08-05
4.	Pulse Limiter	R&S	ESH3-Z2	100605	2011-08-06	2012-08-05
5.	50Ω Coaxial Switch	Anritsu	MP59B	6200547934	2011-08-14	2012-08-13
6.	50ohm Terminator	Tektronis	MS4630B	001-con	2011-03-25	2012-03-24
7.	RF Cable	Harbour Industries	RG400	002	2011-03-24	2012-03-23

3.2. Block Diagram of Test Setup

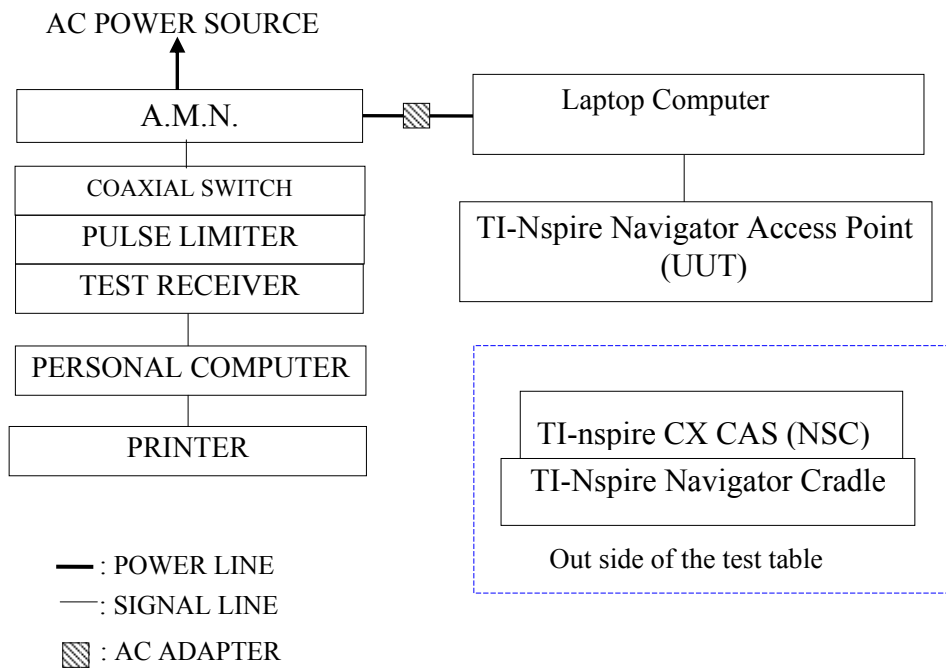

3.3. Power line Conducted Emission Limit

3.3.1. Power line Conducted Emission Limit (FCC Part15 Subpart C, section 15.207)

Frequency	Maximum RF Line Voltage	
	Quasi-Peak Level	Average Level
150kHz ~ 500kHz	66 ~ 56 dBμV	56 ~ 46 dBμV
500kHz ~ 5MHz	56 dBμV	46 dBμV
5MHz ~ 30MHz	60 dBμV	50 dBμV

Remark1: If the average limit is met when using a Quasi-Peak detector, the EUT shall be deemed to meet both limits and measurement with the average detector is unnecessary.

2: The lower limit applies at the band edges.

3.4. Test Procedure

The measuring process is according to ANSI C63.10 and laboratory internal procedure TKC-301-015. (For FCC Part15 Subpart C)

In the conducted emission measurement, the EUT and all peripheral devices were set up on a non-metallic table which was 0.8 meters height above the ground plane, and 0.4 meters far away from the vertical plane. The EUT (installed in PC system) was powered by AC mains through Artificial Mains Network (A.M.N), other peripheral devices were powered by AC mains through the second Line Impedance Stabilization Network (L.I.S.N). For the measurement, the A.M.N measuring port was terminated by a 50Ω measuring equipment and the second L.I.S.N measuring port was terminated by a 50Ω resistive load. All measurements were done on the phase and neutral line of the EUT’s power cord. All cables or wires placement were verified to find out the maximum emission.

The bandwidth of measuring receiver was set at 9 kHz.

The required frequency band (0.15 MHz ~ 30 MHz) was pre-scanned with peak detector, the final measurement was measured with quasi-peak detector and average detector. (If the average limit is met when using a quasi-peak detector, the average detector is necessary).

The emission level is calculated automatically by the test system which uses the following equation:

$$\text{Emission level (dB}\mu\text{V)} = \text{Meter-Reading (dB}\mu\text{V)} + \text{A.M.N factor (dB)} + \text{Cable loss (dB)}$$

(Cable loss include pulse limiter loss)

3.5. Conducted Emission Measurement Results

3.5.1. Conducted Emission Measurement Results (For FCC Part15 Subpart C)

PASSED.

(All the emissions not reported below are too low against the prescribed limits.)

EUT was performed during this section testing and all the test results are attached in next pages.

Test Date : Dec.08, 2011 Temperature : 21.5°C Humidity : 42%

Mode	Test Condition	USB Cable	Reference Test Data No.	
			Neutral	Line
1	Test Configuration 1	60 inch	※# 18	# 17
2		12 inch	# 19	# 20

NOTE 1- ‘※’ means the worst test mode.

NOTE 2- The worst emission is detected at 0.50 MHz with emission level of 32.88 dB (μV) and with AV detector (Limit is 46.03 dB (μV)), when the Neutral of the EUT is connected to AMN.



Audix Technology (Wu Jiang) Co.,Ltd
 No.1289,Jiang Xing East Road,The Eastern Part of WuJiang
 Economic Development Zone,JiangSu,China
 Tel : (0512) 63403993 Fax: (0512) 63403339

Data: 18

File: F:\2011Test Data\Report\G1112001-G1112050\G1112004.EM6 (20)

Date: 2011-12-08

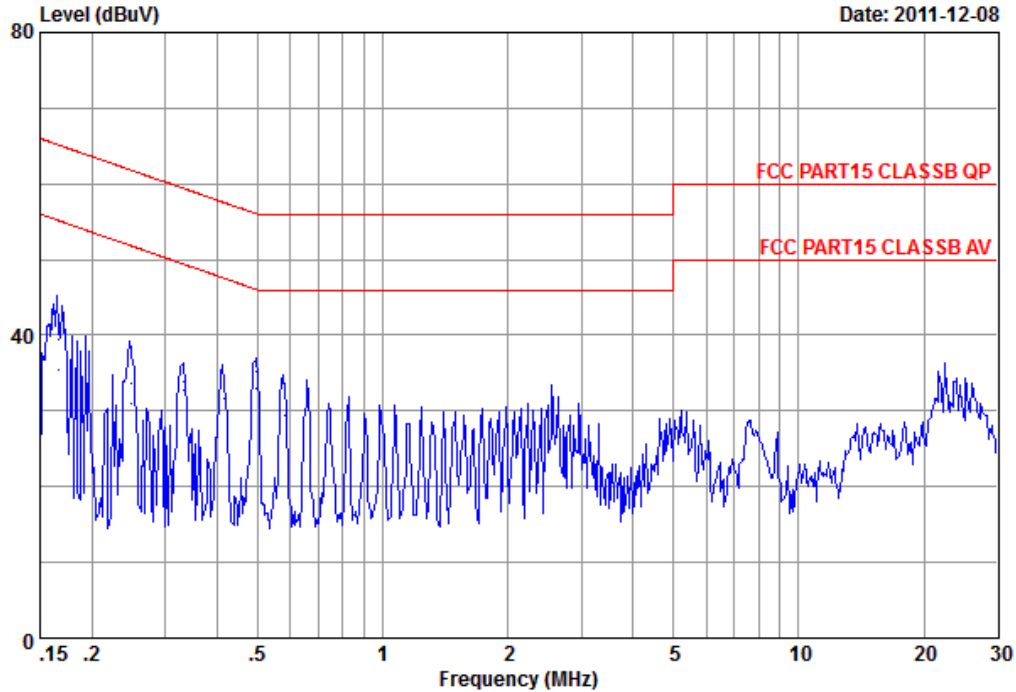

Site no. : NO.1 Conducted Shielding Enclosure Data no. : 18
 AMN/LISN : NNLK8129-N-1108 Phase : NEUTRAL
 Limit : FCC PART15 CLASSB QP
 Env. / Ins. : 21.5°C&42%/ESCI Engineer : Sam.Z
 EUT : TI-Nspire Navigator Access Point
 M/N : TINAVAP2
 Power Rating : 120Vac/60Hz
 Test mode : Test Configuration 1
 Memo : 60'' USB Cable

Freq (MHz)	AMN Factor (dB)	Cable Loss (dB)	Reading (dBuV)	Emission Level (dBuV)	Limits (dBuV)	Margin (dB)	Remark
1	0.17	0.20	9.88	29.39	39.47	65.11	25.64 QP
2	0.17	0.20	9.88	25.29	35.37	55.11	19.74 Average
3	0.25	0.18	9.88	23.60	33.66	61.79	28.13 QP
4	0.25	0.18	9.88	21.00	31.06	51.79	20.73 Average
5	0.33	0.20	9.88	23.79	33.87	59.38	25.51 QP
6	0.33	0.20	9.88	22.69	32.77	49.38	16.61 Average
7	0.41	0.21	9.87	24.30	34.38	57.57	23.19 QP
8	0.41	0.21	9.87	21.60	31.68	47.57	15.89 Average
9	0.50	0.22	9.86	25.10	35.18	56.03	20.85 QP
10	0.50	0.22	9.86	22.80	32.88	46.03	13.15 Average
11	0.58	0.19	9.85	23.50	33.54	56.00	22.46 QP
12	0.58	0.19	9.85	19.30	29.34	46.00	16.66 Average

Note: 1. Emission Level= AMN Factor + Cabel Loss + Reading.
 2. If the average Limit is met when using a quasi-peak detector, the EUT shall be deemed to meet both limits and measurement with average detector is unnecessary.



Audix Technology (Wu Jiang) Co.,Ltd
 No.1289,Jiang Xing East Road,The Eastern Part of WuJiang
 Economic Development Zone,JiangSu,China
 Tel : (0512) 63403993 Fax: (0512) 63403339

Data: 17 File: F:\2011Test Data\Report\G1112001-G1112050\G1112004.EM6 (20) Date: 2011-12-08

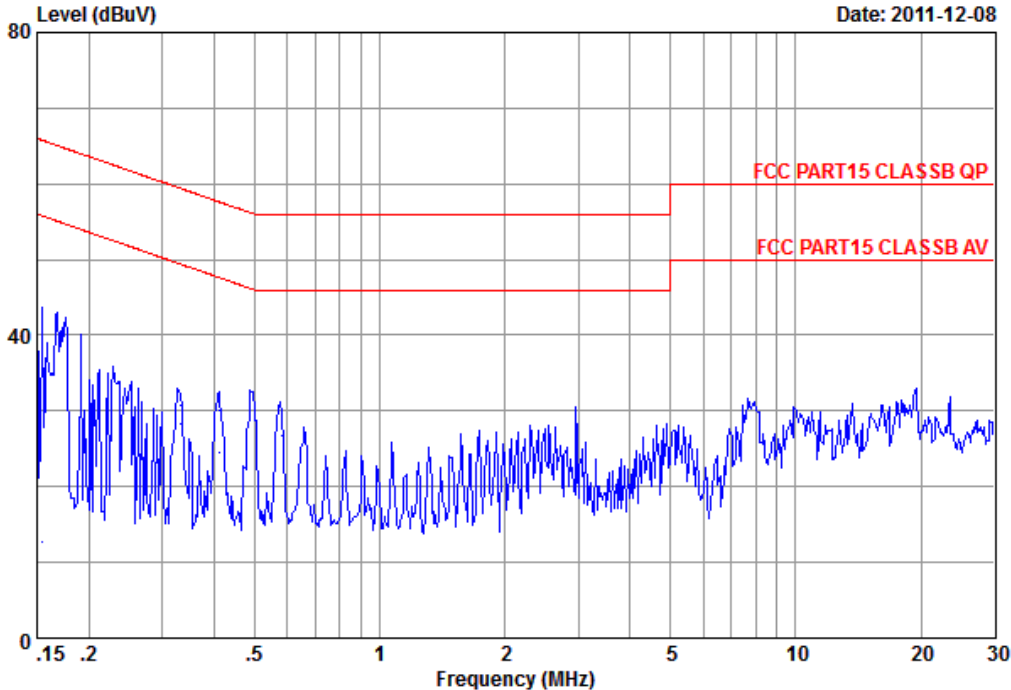

Site no. : NO.1 Conducted Shielding Enclosure Data no. : 17
 AMN/LISN : NNLK8129-I1-1108 Phase : LINE
 Limit : FCC PART15 CLASSB QP
 Env. / Ins. : 21.5°C&42%/ESCI Engineer : Sam.Z
 EUT : TI-Nspire Navigator Access Point
 M/N : TINAVAP2
 Power Rating : 120Vac/60Hz
 Test mode : Test Configuration 1
 Memo : 60'' USB Cable

1	2	3	4	5	6	7	8	9	10	11	12
Freq (MHz)	AMN Factor (dB)	Cable Loss (dB)	Reading (dBuV)	Emission Level (dBuV)	Limits (dBuV)	Margin (dB)	Remark				
0.15	0.24	9.88	26.60	36.72	65.78	29.06	QP				
0.15	0.24	9.88	2.50	12.62	55.78	43.16	Average				
0.33	0.13	9.88	20.80	30.81	59.43	28.62	QP				
0.33	0.13	9.88	18.20	28.21	49.43	21.22	Average				
0.41	0.12	9.87	20.00	29.99	57.61	27.62	QP				
0.41	0.12	9.87	14.50	24.49	47.61	23.12	Average				
0.50	0.11	9.86	20.60	30.57	56.02	25.45	QP				
0.50	0.11	9.86	18.70	28.67	46.02	17.35	Average				
0.58	0.14	9.85	19.00	28.99	56.00	27.01	QP				
0.58	0.14	9.85	16.80	26.79	46.00	19.21	Average				
2.98	0.21	9.93	15.89	26.03	56.00	29.97	QP				
2.98	0.21	9.93	14.59	24.73	46.00	21.27	Average				

Note: 1.Emission Level= AMN Factor + Cabel Loss + Reading.
 2.If the average Limit is met when using a quasi-peak detector,the EUT shall be deemed to meet both limits and measurement with average detector is unnecessary.



Audix Technology (Wu Jiang) Co.,Ltd
 No.1289,Jiang Xing East Road,The Eastern Part of WuJiang
 Economic Development Zone,JiangSu,China
 Tel : (0512) 63403993 Fax: (0512) 63403339

Data: 19

File: F:\2011Test Data\Report\G1112001-G1112050\G1112004.EM6 (20)

Date: 2011-12-08

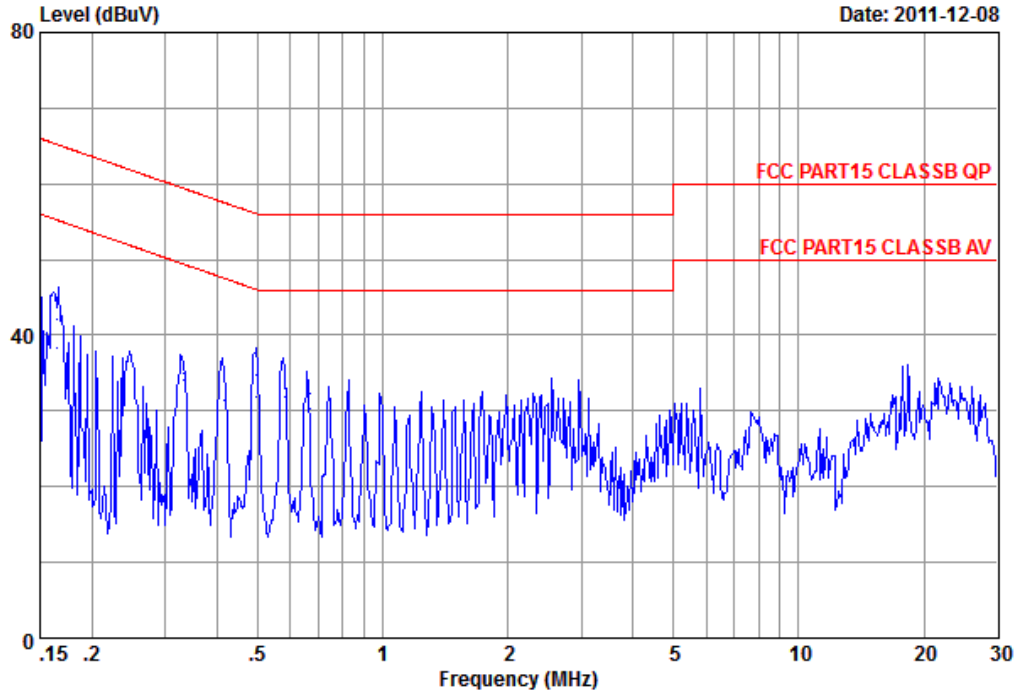

Site no. : NO.1 Conducted Shielding Enclosure Data no. : 19
 AMN/LISN : NNLK8129-N-1108 Phase : NEUTRAL
 Limit : FCC PART15 CLASSB QP
 Env. / Ins. : 21.5°C&42%/ESCI Engineer : Sam.Z
 EUT : TI-Nspire Navigator Access Point
 M/N : TINAVAP2
 Power Rating : 120Vac/60Hz
 Test mode : Test Configuration 1
 Memo : 12'' USB Cable

Line	Freq (MHz)	AMN Factor (dB)	Cable Loss (dB)	Reading (dBuV)	Emission Level (dBuV)	Limits (dBuV)	Margin (dB)	Remark
1	0.17	0.20	9.88	32.10	42.18	65.21	23.03	QP
2	0.17	0.20	9.88	28.30	38.38	55.21	16.83	Average
3	0.33	0.20	9.88	24.99	35.07	59.43	24.36	QP
4	0.33	0.20	9.88	23.99	34.07	49.43	15.36	Average
5	0.41	0.21	9.87	24.50	34.58	57.57	22.99	QP
6	0.41	0.21	9.87	21.40	31.48	47.57	16.09	Average
7	0.50	0.22	9.86	24.70	34.78	56.03	21.25	QP
8	0.50	0.22	9.86	21.70	31.78	46.03	14.25	Average
9	0.58	0.19	9.85	22.90	32.94	56.00	23.06	QP
10	0.58	0.19	9.85	21.90	31.94	46.00	14.06	Average
11	0.67	0.16	9.85	22.40	32.41	56.00	23.59	QP
12	0.67	0.16	9.85	20.20	30.21	46.00	15.79	Average

Note: 1. Emission Level= AMN Factor + Cabel Loss + Reading.
 2. If the average Limit is met when using a quasi-peak detector, the EUT shall be deemed to meet both limits and measurement with average detector is unnecessary.



Audix Technology (Wu Jiang) Co.,Ltd
 No.1289,Jiang Xing East Road,The Eastern Part of WuJiang
 Economic Development Zone,JiangSu,China
 Tel : (0512) 63403993 Fax: (0512) 63403339

Data: 20

File: F:\2011Test Data\Report\G1112001-G1112050\G1112004.EM6 (20)

Date: 2011-12-08

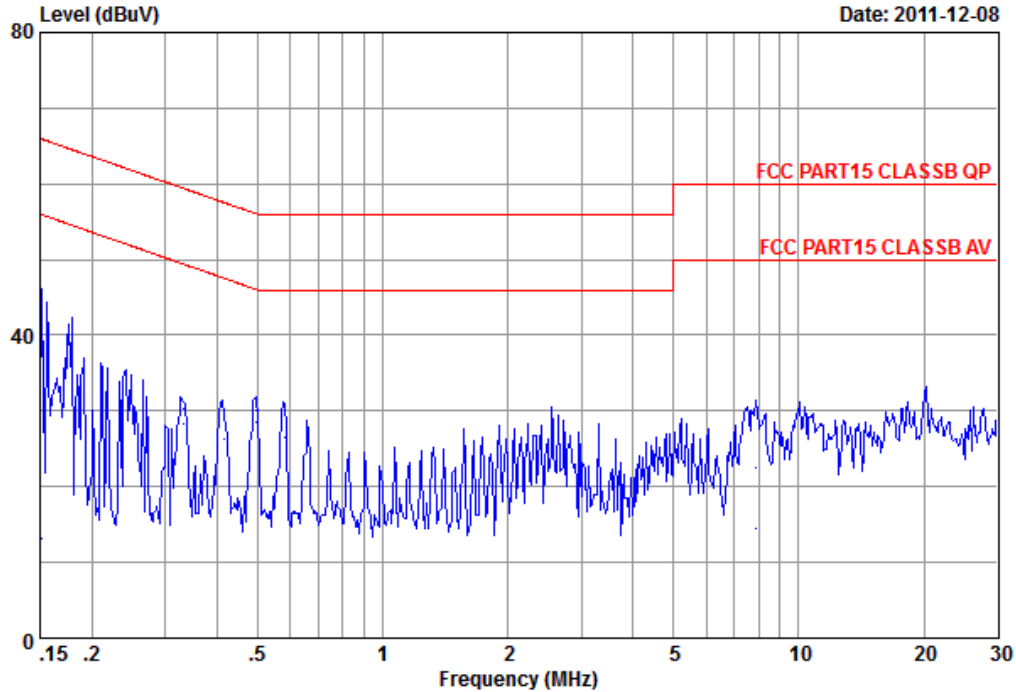

Site no. : NO.1 Conducted Shielding Enclosure Data no. : 20
 AMN/LISN : NNLK8129-L1-1108 Phase : LINE
 Limit : FCC PART15 CLASSB QP
 Env. / Ins. : 21.5*C&42%/ESCI Engineer : Sam.Z
 EUT : TI-Nspire Navigator Access Point
 M/N : TINAVAP2
 Power Rating : 120Vac/60Hz
 Test mode : Test Configuration 1
 Memo : 12'' USB Cable

Freq (MHz)	AMN Factor (dB)	Cable Loss (dB)	Reading (dBuV)	Emission Level (dBuV)	Limits (dBuV)	Margin (dB)	Remark
1	0.15	0.25	9.88	28.40	38.53	65.94	27.41 QP
2	0.15	0.25	9.88	3.00	13.13	55.94	42.81 Average
3	0.33	0.13	9.88	20.30	30.31	59.43	29.12 QP
4	0.33	0.13	9.88	18.20	28.21	49.43	21.22 Average
5	0.41	0.12	9.87	20.00	29.99	57.57	27.58 QP
6	0.41	0.12	9.87	16.20	26.19	47.57	21.38 Average
7	0.50	0.11	9.86	20.10	30.07	56.05	25.98 QP
8	0.50	0.11	9.86	18.50	28.47	46.05	17.58 Average
9	0.58	0.14	9.85	19.40	29.39	56.00	26.61 QP
10	0.58	0.14	9.85	16.60	26.59	46.00	19.41 Average
11	7.86	0.25	9.98	12.20	22.43	60.00	37.57 QP
12	7.86	0.25	9.98	4.30	14.53	50.00	35.47 Average

Note: 1. Emission Level= AMN Factor + Cabel Loss + Reading.
 2. If the average Limit is met when using a quasi-peak detector, the EUT shall be deemed to meet both limits and measurement with average detector is unnecessary.

4. RADIATED EMISSION MEASUREMENT

4.1. Test Equipment

The following test equipment was used during the radiated emission measurement:

At 10m Semi-Anechoic Chamber (For 30MHz~1000MHz) (For FCC Part15 Subpart C)

Item	Type	Manufacturer	Model No.	Serial No.	Last Cal.	Next Cal.
1	Spectrum Analyzer	Agilent	E7405A	MY45107028	2011-03-25	2012-03-24
2	Spectrum Analyzer	Agilent	E7405A	MY45107030	2011-03-25	2012-03-24
3	Pre-Amplifier	Agilent	8447D	2944A10923	2011-07-19	2012-07-18
4	Pre-Amplifier	Agilent	8447D	2944A10922	2011-08-14	2012-08-13
5	Bi-log Antenna (Horizontal)	Schaffner	CBL6112D	22253	2011-05-06	2012-05-05
6	Bi-log Antenna (Vertical)	Schaffner	CBL6112D	22250	2011-06-08	2012-06-07
7	Test Receiver	R&S	ESCI	100351	2011-01-05	2012-01-04
8	50Ω Coaxial Switch # 1	ANRITSU	MP59B	6200547935	2011-08-14	2012-08-13
9	50Ω Coaxial Switch # 2	ANRITSU	MP59B	6200547937	2011-08-14	2012-08-13
10	50Ω Coaxial Switch # 3	ANRITSU	MP59B	6200547938	2011-08-14	2012-08-13
11	RF Cable	Yuhang	CSYH	001	2011-08-14	2012-08-13
12	RF Cable	Yuhang	CSYH	002	2011-08-14	2012-08-13
13	RF Cable	Yuhang	CSYH	003	2011-08-14	2012-08-13
14	RF Cable	Yuhang	CSYH	004	2011-08-14	2012-08-13
15	RF Cable	Yuhang	CSYH	005	2011-03-24	2012-08-23
16	RF Cable	Yuhang	CSYH	006	2011-03-24	2012-08-23
17	RF Cable	Yuhang	CSYH	008	2011-03-24	2012-08-23
18	RF Cable	Yuhang	CSYH	009	2011-03-24	2012-08-23

At 3m Semi-Anechoic Chamber (For Above 1GHz) (For FCC Part15 Subpart C)

Item	Type	Manufacturer	Model No.	Serial No.	Last Cal.	Next Cal.
1.	Preamplifier	Agilent	8449B	2944A10921	2011-08-13	2012-08-12
2.	Spectrum Analyzer	Agilent	E4447A	MY45300136	2010-12-30	2011-12-29
3.	Bi-log Antenna	Schaffner	CBL6112D	22250	2011-06-08	2012-06-07
4.	Test Receiver	R&S	ESCI	100361	2011-01-05	2012-01-04
5.	50Ω Coaxial Switch	Anritsu	MP59B	6200547935	2011-08-13	2012-08-12
6.	RF Cable #1	Yuhang CSYH	cable-3m	001 (Length: 0.5m)	2011-08-13	2012-08-12
7.	RF Cable #2	Yuhang CSYH	cable-3m	002 (Length: 0.5m)	2011-08-13	2012-08-12
8.	RF Cable #3	Yuhang CSYH	cable-3m	003 (Length: 3.0m)	2011-08-13	2012-08-12

4.2. Block Diagram of Test Setup

4.2.1. Block Diagram of Test Setup between EUT and simulators

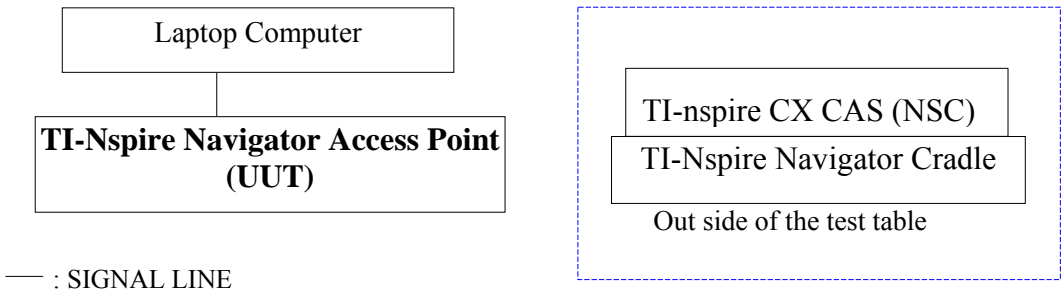

4.2.2. No. 1 10m Semi-Anechoic Chamber Setup Diagram (Test distance:10m) for 30-1000MHz

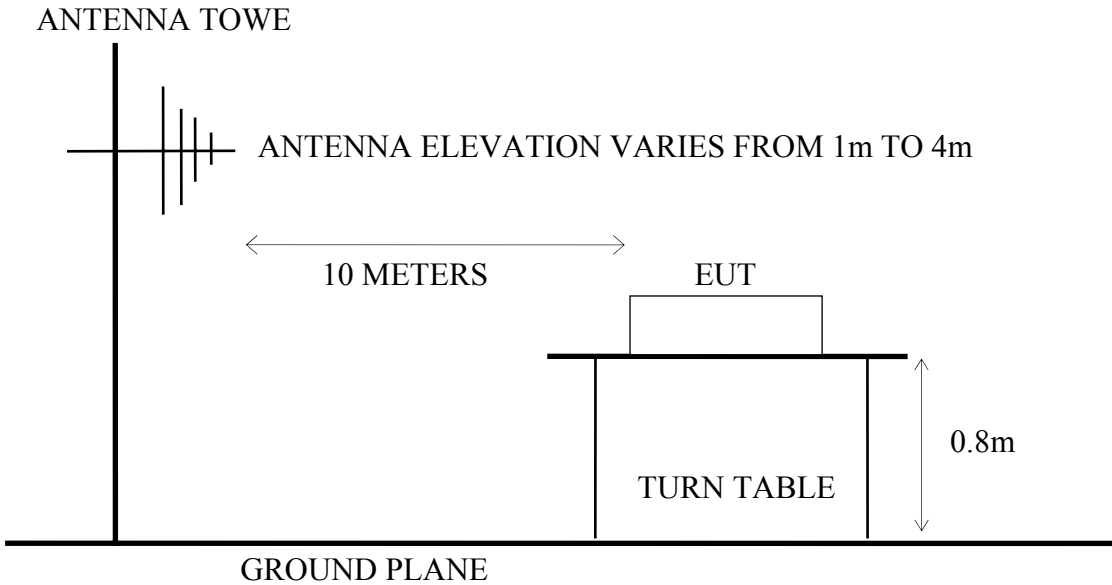

4.2.3. No. 1 10m Semi-Anechoic Chamber Setup Diagram (Test distance: 3m) for above 1GHz

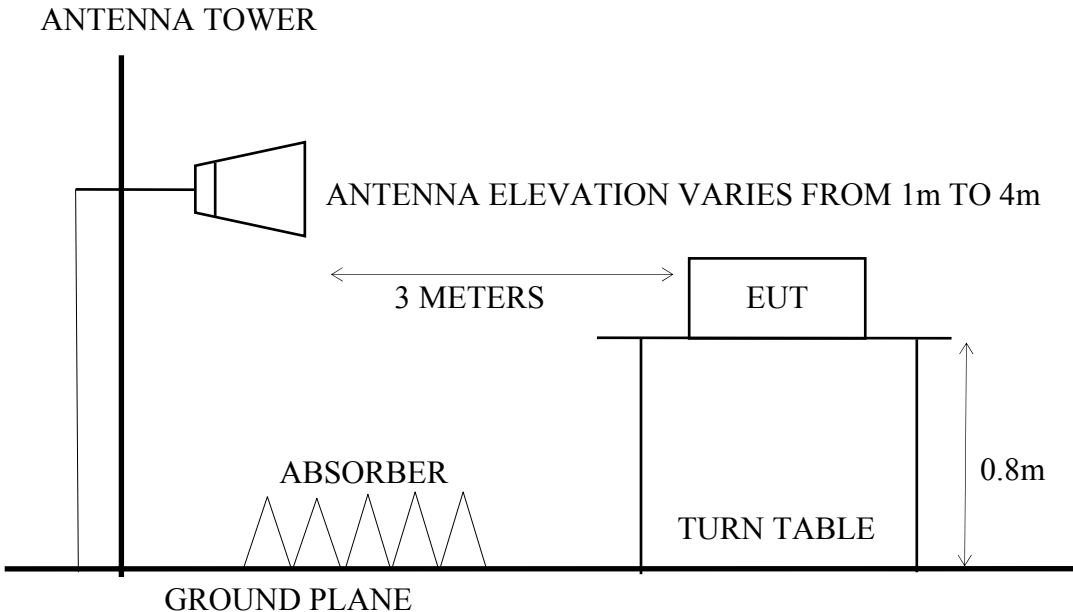

4.2.4. No. 1 3m Semi-Anechoic Chamber Setup Diagram (Test distance:10m) for 30-1000MHz

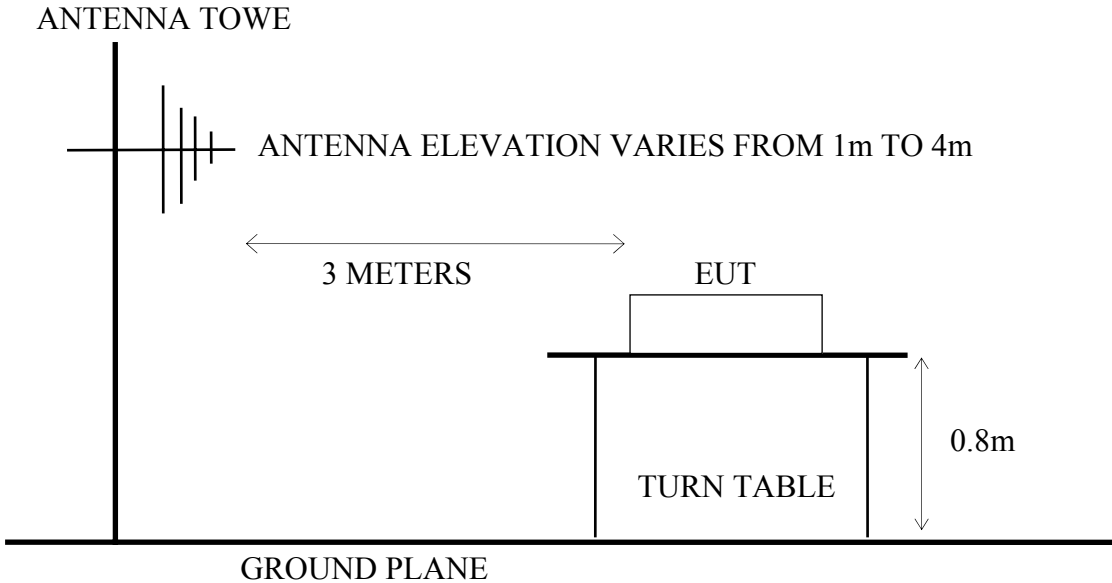

4.2.5. No. 1 3m Semi-Anechoic Chamber Setup Diagram (Test distance: 3m) for above 1GHz

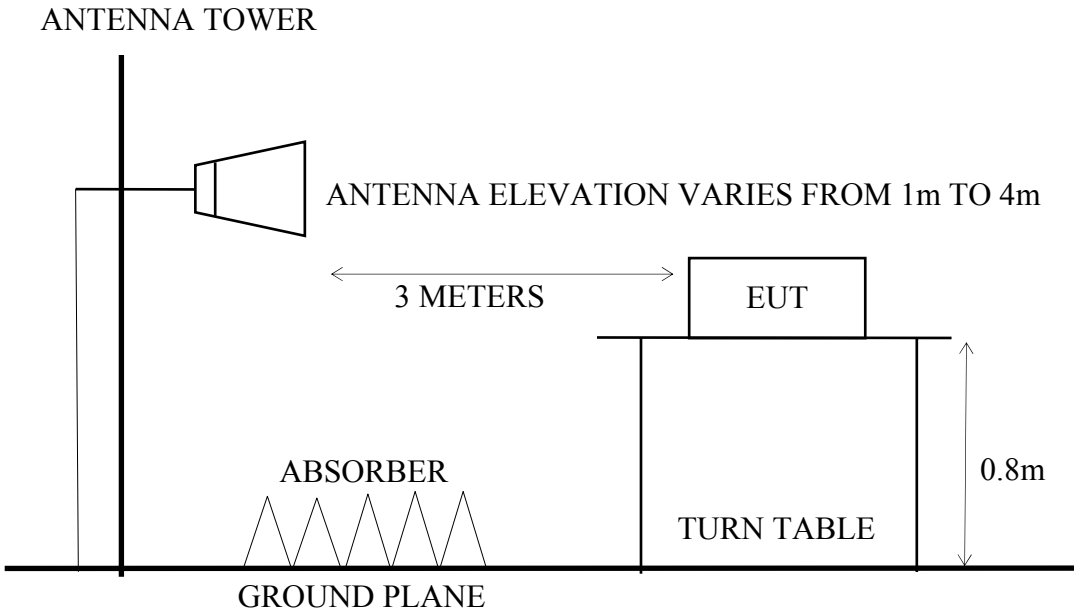

4.3. Radiated Emission Limits

4.3.1. Radiated Emission Limits (FCC Part15 C, section 15.209,CISPR22)

Frequency MHz	Distance Meters	Field Strengths Limits
		dBµV/m
30 ~ 230	10	30.0
230 ~ 1000	10	37.0
Above 1000	3	74.0 dBµV/m (Peak) 54.0 dBµV/m (Average)

Remark : (1) Emission level (dBµV/m) = 20 log Emission level (µV/m)
 (2)The tighter limit applies at the edge between two frequency bands.

4.4. Test Procedure

The measuring process is according to ANSI C63.10 and laboratory internal procedure TKC-301-024. (For FCC Part15 Subpart C)

In the radiated disturbance measurement, the EUT and all simulators were set up on a non-metallic turn table which was 0.8 meters above the ground plane. Measurement distance between EUT and receiving antennas was set at 10 meters at 30MHz~1000MHz and 3 meters at above 1GHz. The specified distance is the distance between the antennas and the closest periphery of EUT. During the radiated measurement, the EUT was rotated 360° and receiving antennas were moved from 1 ~ 4 meters for finding maximum emission. Two receiving antennas were used for both horizontal and vertical polarization detection for 30MHz~1GHz, One receiving antennas was used for both horizontal and vertical polarization detection for above 1GHz (the absorbing material was added when testing of above 1GHz was done). All cables or wires placement were verified to find out the maximum emission.

The bandwidth of measuring receiver (or spectrum analyzer) was set to:

RBW (120 kHz), VBW (300 kHz) for QP detector below 1GHz
 RBW (1 MHz), VBW (1MHz) for Peak detector above 1GHz
 RBW (1 MHz), VBW (10 Hz) for Average detector above 1GHz

The required frequency band was pre-scanned with peak detector; all final measurements were measured with quasi-peak detector below 1GHz, measured with average detector and peak detector above 1GHz.

The required frequency band (30 MHz ~ 12000 MHz) was pre-scanned with peak detector; all final measurements were measured with quasi-peak detector below 1GHz, measured with average detector and peak detector above 1GHz., if necessary which is against note 1 of section 8.3.1.2 of ANSI C63.4-2003 standard.

The emission level is calculated automatically by the test system which uses the following equation :

1. For 30-1000MHz measurement:

$$\text{Emission Level (dB}\mu\text{V/m)} = \text{Meter-Reading (dB}\mu\text{V)} + \text{Antenna Factor (dB/m)} + \text{Cable Loss (dB)}$$
2. For Above 1GHz measurement:

$$\text{Emission Level (dB}\mu\text{V/m)} = \text{Meter-Reading (dB}\mu\text{V)} + \text{Antenna Factor (dB/m)} + \text{Cable Loss (dB)} - \text{Pre-amplifier factor (dB}\mu\text{V)}$$

4.5. Measurement Results

PASSED

(All the emissions not reported below are too low against the prescribed limits.)

4.5.1. For 30MHz~1GHz (For FCC Part15 Subpart B)

Test Date : Dec.07, 2011 Temperature : 20°C Humidity : 55%

The details of test modes and reference test data are as follows :

Item	Test Condition	USB Cable	Reference Test Data No.	
			Horizontal	Vertical
1	Test Configuration 1	12 inch	# 5	# 6
2		60 inch	# 7	# 8

4.5.2. For Above 1GHz (For FCC Part15 Subpart B)

Item	Test Condition	USB Cable	Reference Test Data No.	
			Horizontal	Vertical
1	Test Configuration 1	12 inch	# 7	# 8
2		60 inch	# 5	# 6

4.5.3. For Restricted Bands:

The EUT was tested in restricted bands and all the test results are listed in section 4.6.

(The restricted bands defined in part 15.205(a))

No.	Test Mode and Frequency		
1.	Transmitting	802.11b	2412MHz (Channel 1)
2.			2437MHz (Channel 6)
3.			2462MHz (Channel 11)
4.		802.11g	2412MHz (Channel 1)
5.			2437MHz (Channel 6)
6.			2462MHz (Channel 11)
7.		802.11n	2412MHz (Channel 1)
8.			2437MHz (Channel 6)
9.			2462MHz (Channel 11)

4.5.4. For Band Edge Emission

The EUT was tested in restricted bands and all the test results are listed in section 4.7. The restricted bands defined in part 15.205(a))

No.	Test Mode and Frequency		Reference Test Data No.		
			Horizontal	Vertical	
1.	Transmitting	802.11b	2412MHz (Channel 1)	# 17 , # 19	# 18 , # 20
2.			2462MHz (Channel 11)	# 21 , # 23	# 22 , # 24
3.		802.11g	2412MHz (Channel 1)	# 9 , # 11	# 10, # 12
4.			2462MHz (Channel 11)	# 14 , # 15	# 13 , # 16
5.		802.11n	2412MHz (Channel 1)	# 1 , # 3	# 2, # 4
6.			2462MHz (Channel 11)	# 5 , # 7	# 6, # 8

4.5.5. Radiated Emission Measurement Results (For FCC Part15 Subpart B&C)



Audix Technology (Wujiang) Co., Ltd.
 No.1289, Jiang Xing East Road, Eastern Part of Wujiang
 Economic Development Zone, JiangSu, China
 Tel:0512-63403993 Fax:0512-63403339

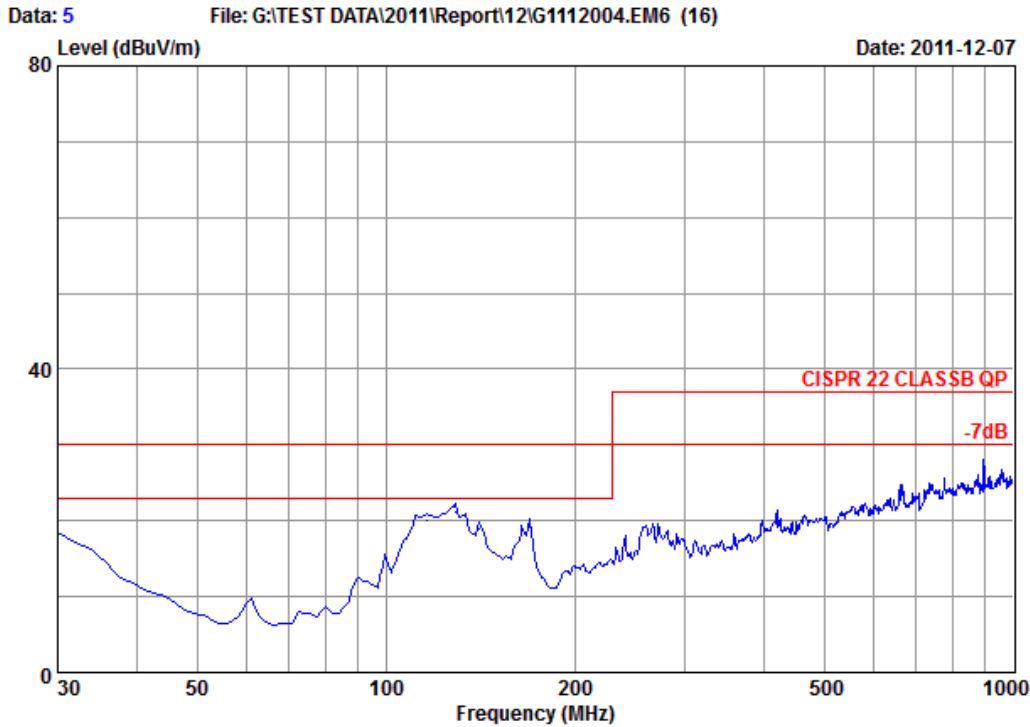

Site No. : NO.1 10m Semi-Anechoic Chamber Data NO. : 5
 Dis./Ant. : 10m . 6112D(22253)-1105 Ant.pol : HORIZONTAL
 Limit : CISPR 22 CLASS B QP
 Env./Ins. : 20*C 55%/ESCI Engineer : Andy
 EUT : TI-Nspire Navigator Access Point
 M/N : TINAVAP2
 Power Rating : DC 5V Via Laptop
 Test Mode : Test Configuration 1
 Memo : 12" USB Cable

	Freq. (MHz)	Ant. Factor (dB/m)	Cable Loss (dB)	Reading (dBuV)	Emission Level (dBuV/m)	Limits (dBuV/m)	Margin (dB)	Remark
1	116.33	12.57	1.35	6.06	19.98	30.00	10.02	QP
2	128.94	12.87	1.53	6.82	21.22	30.00	8.78	QP
3	140.58	12.00	1.68	5.17	18.85	30.00	11.15	QP
4	169.68	9.90	1.74	7.63	19.27	30.00	10.73	QP
5	271.53	12.65	2.23	3.75	18.63	37.00	18.37	QP
6	897.18	20.42	4.35	2.22	26.99	37.00	10.01	QP

Remarks: 1. Emission Level= Antenna factor + Cable loss + Reading
 2. The emission level that are 20dB below the official limit are not reported



Audix Technology(Wujiang)Co.,Ltd.
 No.1289,Jiang Xing East Road,Eastern Part of WuJiang
 Economic Development Zone,JiangSu,China
 Tel:0512-63403993 Fax:0512-63403339

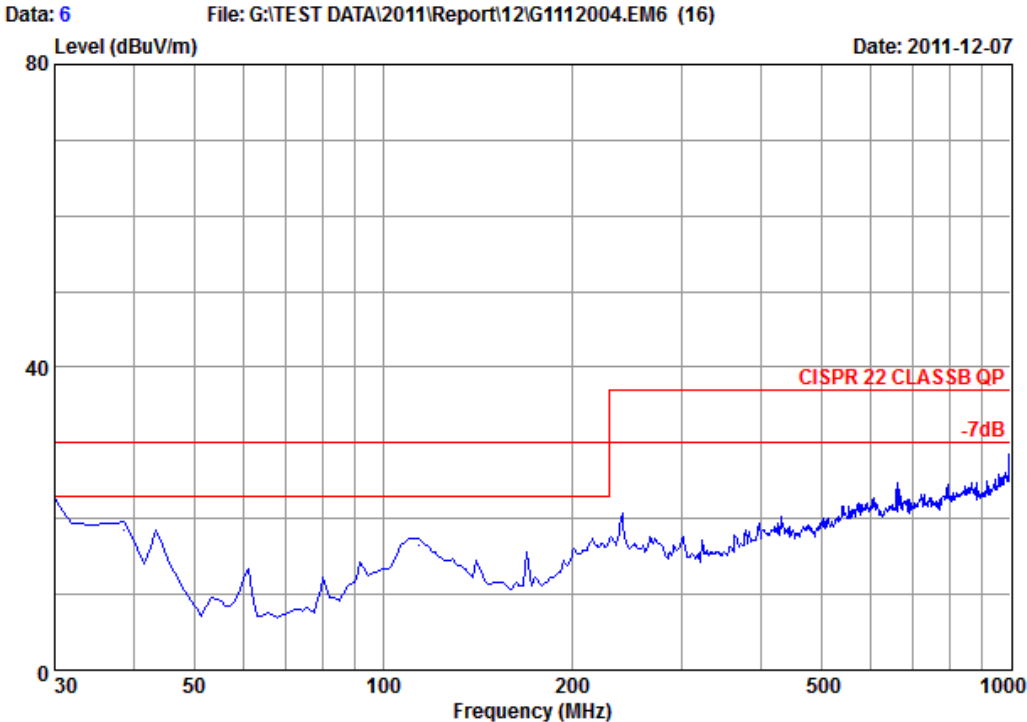

Site No. : NO.1 10m Semi-Anechoic Chamber Data NO. : 6
 Dis./Ant. : 10m . 6112D(22250)-1106 Ant.pol : VERTICAL
 Limit : CISPR 22 CLASS B QP
 Env./Ins. : 20*C 55%/ESCI Engineer : Andy
 EUT : TI-Nspire Navigator Access Point
 M/N : TINAVAP2
 Power Rating : DC 5V Via Laptop
 Test Mode : Test Configuration 1
 Memo : 12" USB Cable

	Freq. (MHz)	Ant. Factor (dB/m)	Cable Loss (dB)	Reading (dBuV)	Emission Level (dBuV/m)	Limits (dBuV/m)	Margin (dB)	Remark
1	30.00	20.30	0.65	0.69	21.64	30.00	8.36	QP
2	38.73	15.60	0.61	2.39	18.60	30.00	11.40	QP
3	114.39	12.30	1.12	3.04	16.46	30.00	13.54	QP
4	240.49	11.30	1.57	6.88	19.75	37.00	17.25	QP
5	659.53	19.20	2.86	1.57	23.63	37.00	13.37	QP
6	994.18	21.78	3.71	1.95	27.44	37.00	9.56	QP

Remarks: 1.Emission Level= Antenna factor + Cable loss + Reading
 2.The emission level that are 20dB below the official limit are not reported



Audix Technology(Wujiang)Co.,Ltd.
 No.1289,Jiang Xing East Road,Eastern Part of WuJiang
 Economic Development Zone,JiangSu,China
 Tel:0512-63403993 Fax:0512-63403339

Data: 7 File: G:\TEST DATA\2011\Report\12\G1112004.EM6 (16)

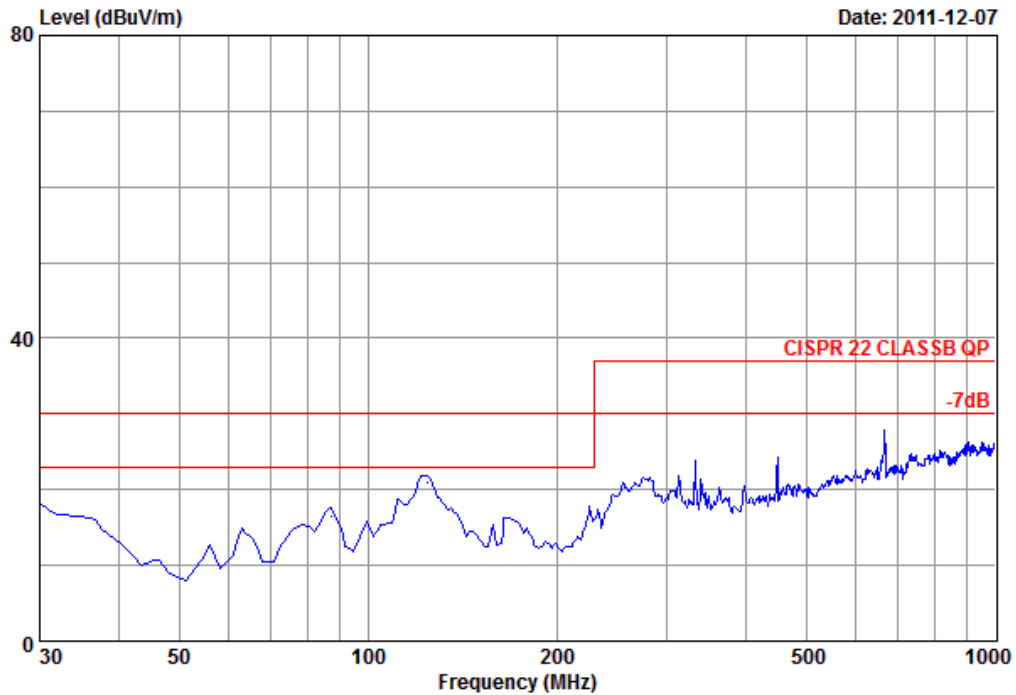

Site No. : NO.1 10m Semi-Anechoic Chamber Data NO. : 7
 Dis./Ant. : 10m . 6112D(22253)-1105 Ant.pol : HORIZONTAL
 Limit : CISPR 22 CLASSB QP
 Env./Ins. : 20*C 55%/ESCI Engineer : Andy
 EUT : TI-Nspire Navigator Access Point
 M/N : TINAVAP2
 Power Rating : DC 5V Via Laptop
 Test Mode : Test Configuration 1
 Memo : 60" USB Cable

	Freq. (MHz)	Ant. Factor (dB/m)	Cable Loss (dB)	Reading (dBuV)	Emission Level (dBuV/m)	Limits (dBuV/m)	Margin (dB)	Remark
1	87.23	8.60	1.18	6.82	16.60	30.00	13.40	QP
2	124.09	12.80	1.44	6.67	20.91	30.00	9.09	QP
3	274.44	12.70	2.30	6.64	21.64	37.00	15.36	QP
4	332.64	14.26	2.49	5.16	21.91	37.00	15.09	QP
5	449.04	16.20	2.83	4.20	23.23	37.00	13.77	QP
6	664.38	19.44	3.87	3.45	26.76	37.00	10.24	QP

Remarks: 1.Emission Level= Antenna factor + Cable loss + Reading
 2.The emission level that are 20dB below the official limit are not reported



Audix Technology(Wujiang)Co.,Ltd.
 No.1289,Jiang Xing East Road,Eastern Part of WuJiang
 Economic Development Zone,JiangSu,China
 Tel:0512-63403993 Fax:0512-63403339

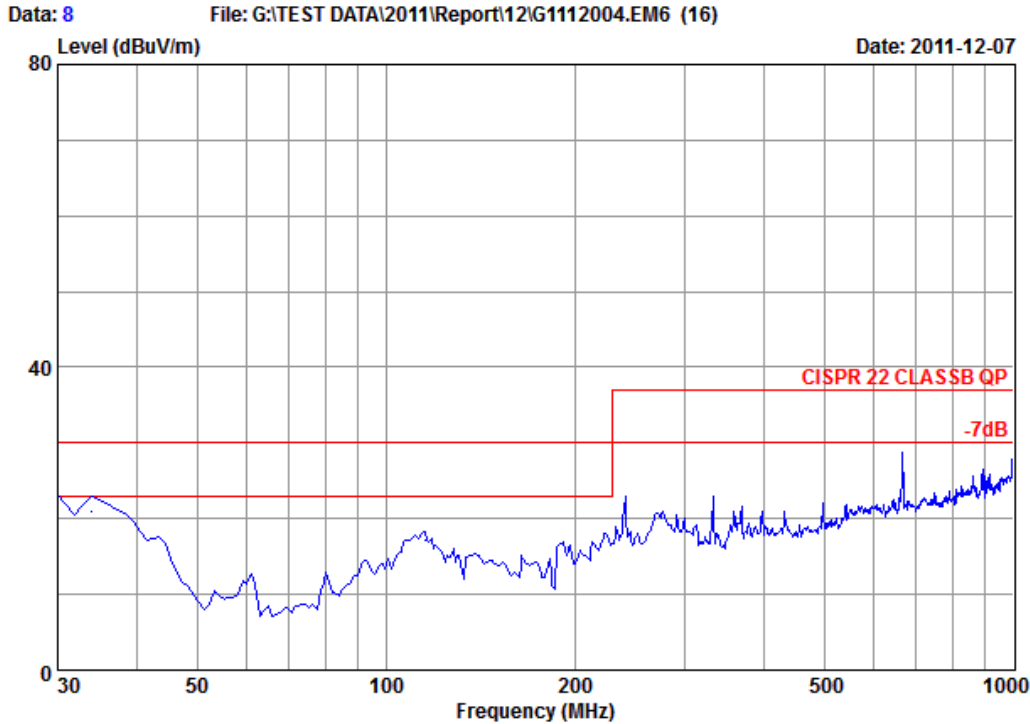

Site No. : NO.1 10m Semi-Anechoic Chamber Data NO. : 8
 Dis./Ant. : 10m . 6112D(22250)-1106 Ant.pol : VERTICAL
 Limit : CISPR 22 CLASSB QP
 Env./Ins. : 20*C 55%/ESCI Engineer : Andy
 EUT : TI-Nspire Navigator Access Point
 M/N : TINAVAP2
 Power Rating : DC 5V Via Laptop
 Test Mode : Test Configuration 1
 Memo : 60" USB Cable

	Freq. (MHz)	Ant. Factor (dB/m)	Cable Loss (dB)	Reading (dBuV)	Emission Level (dBuV/m)	Limits (dBuV/m)	Margin (dB)	Remark
1	30.00	20.30	0.65	-0.73	20.22	30.00	9.78	QP
2	33.88	17.80	0.63	2.48	20.91	30.00	9.09	QP
3	115.36	12.30	1.10	3.79	17.19	30.00	12.81	QP
4	240.49	11.30	1.57	9.06	21.93	37.00	15.07	QP
5	664.38	19.20	2.82	5.70	27.72	37.00	9.28	QP
6	1000.00	21.60	3.86	1.88	27.34	37.00	9.66	QP

Remarks: 1.Emission Level= Antenna factor + Cable loss + Reading
 2.The emission level that are 20dB below the official limit are not reported

4.5.6. Radiated Emission Measurement Results (For Above 1GHz) (For FCC Part15 Subpart B)



Audix Technology(Wujiang)Co.,Ltd.
 No.1289,Jiang Xing East Road,Eastern Part of WuJiang
 Economic Development Zone,JiangSu,China
 Tel:0512-63403993 Fax:0512-63403339

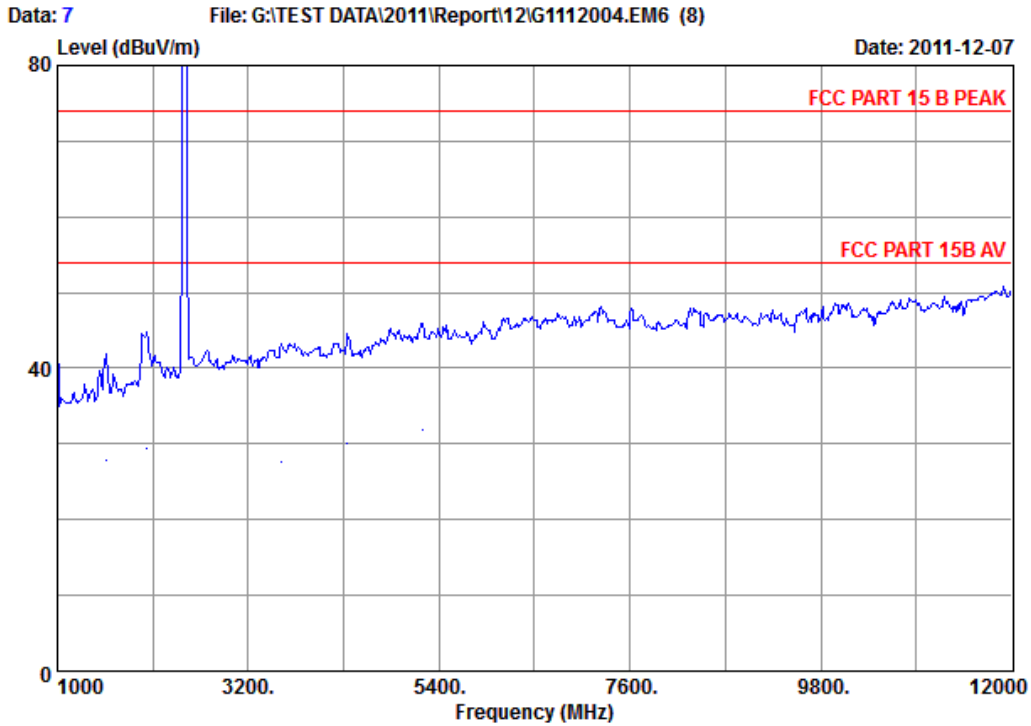

Site No. : NO.1 10m Semi-Anechoic Chamber Data NO. : 7
 Dis./Ant. : 3m 3115(62593)-1105 Ant.pol : HORIZONTAL
 Limit : FCC PART 15 B PEAK
 Env./Ins. : 20*C 55%/ESCI Engineer : Andy
 EUT. : TI-Nspire Navigator Access Point
 M/N : TINAVAP2
 Power Rating : DC 5V Via Laptop
 Test Mode : Test Configuration 1
 Memo : 12" USB Cable

	Freq. (MHz)	Ant. Factor (dB/m)	Cable Loss (dB)	Reading (dBuV)	Preamp Factor (dB)	Emission Level (dBuV/m)	Limits (dBuV/m)	Margin (dB)	Remark
1	1000.00	23.60	1.58	52.05	34.50	42.73	74.00	31.27	Peak
2	1000.00	23.60	1.58	39.50	34.50	30.18	54.00	23.82	Average
3	1572.00	25.70	2.10	48.59	34.60	41.79	74.00	32.21	Peak
4	1572.00	25.70	2.10	34.60	34.60	27.80	54.00	26.20	Average
5	2034.00	27.30	2.29	49.88	34.62	44.85	74.00	29.15	Peak
6	2034.00	27.30	2.29	34.50	34.62	29.47	54.00	24.53	Average
7	2452.00	28.54	2.21	100.05	34.78	96.02	74.00	-22.02	Peak
8	3574.00	31.87	3.29	26.50	34.05	27.61	54.00	26.39	Average
9	3574.00	31.87	3.29	42.18	34.05	43.29	74.00	30.71	Peak
10	4344.00	32.55	3.57	41.63	33.20	44.55	74.00	29.45	Peak
11	4344.00	32.55	3.57	27.20	33.20	30.12	54.00	23.88	Average
12	5202.00	33.94	4.03	41.38	33.40	45.95	74.00	28.05	Peak
13	5202.00	33.94	4.03	27.40	33.40	31.97	54.00	22.03	Average

Remarks: 1.Emission Level= Antenna factor + Cable loss + Reading - Preamp
 2.The emission level that are 20dB below the official limit are not reported



Audix Technology(Wujiang)Co.,Ltd.
 No.1289,Jiang Xing East Road,Eastern Part of WuJiang
 Economic Development Zone,JiangSu,China
 Tel:0512-63403993 Fax:0512-63403339

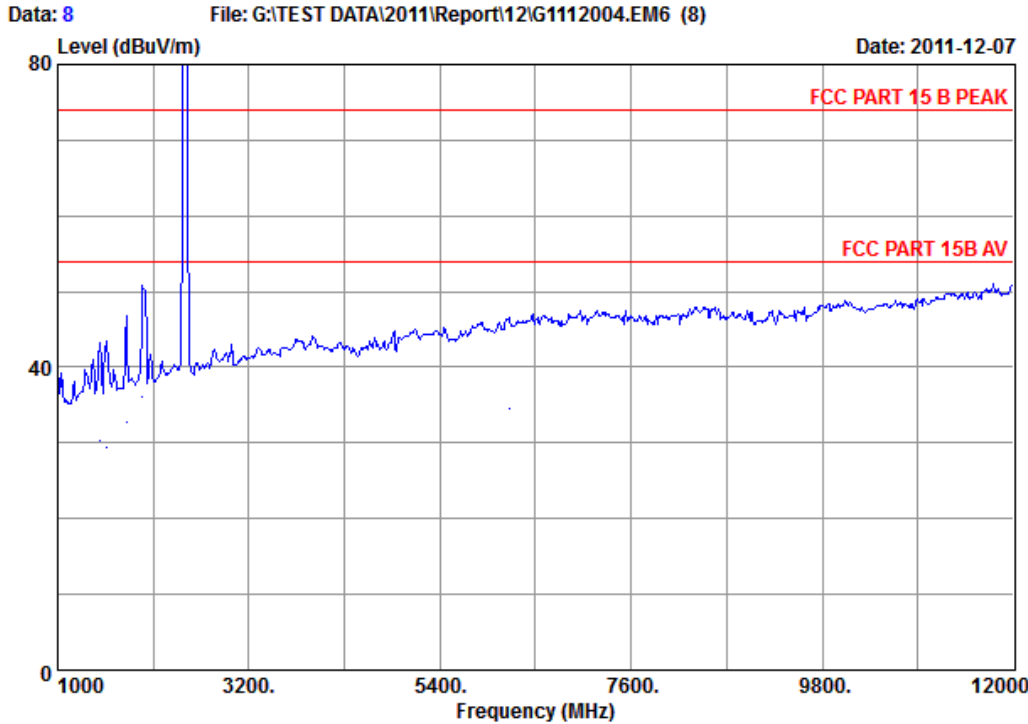

Site No. : NO.1 10m Semi-Anechoic Chamber Data NO. : 8
 Dis./Ant. : 3m 3115(62593)-1105 Ant.pol : VERTICAL
 Limit : FCC PART 15 B PEAK
 Env./Ins. : 20*C 55%/ESCI Engineer : Andy
 EUT. : TI-Nspire Navigator Access Point
 M/N : TINAVAP2
 Power Rating : DC 5V Via Laptop
 Test Mode : Test Configuration 1
 Memo : 12" USB Cable

	Freq. (MHz)	Ant. Factor (dB/m)	Cable Loss (dB)	Reading (dBuV)	Preamp Factor (dB)	Emission Level (dBuV/m)	Limits (dBuV/m)	Margin (dB)	Remark
1	1000.00	23.60	1.58	48.77	34.50	39.45	74.00	34.55	Peak
2	1001.00	23.60	1.58	36.60	34.50	27.28	54.00	26.72	Average
3	1484.00	25.34	2.07	50.51	34.59	43.33	74.00	30.67	Peak
4	1484.00	25.34	2.07	37.49	34.59	30.31	54.00	23.69	Average
5	1572.00	25.70	2.10	50.25	34.60	43.45	74.00	30.55	Peak
6	1572.00	25.70	2.10	36.20	34.60	29.40	54.00	24.60	Average
7	1792.00	26.48	2.32	52.69	34.60	46.89	74.00	27.11	Peak
8	1792.00	26.48	2.32	38.50	34.60	32.70	54.00	21.30	Average
9	1979.00	27.14	2.33	55.99	34.60	50.86	74.00	23.14	Peak
10	1979.00	27.14	2.33	41.20	34.60	36.07	54.00	17.93	Average
11	2452.00	28.54	2.21	101.33	34.78	97.30	74.00	-23.30	Peak
12	6192.00	34.92	4.23	39.78	32.44	46.49	74.00	27.51	Peak
13	6192.00	34.92	4.23	27.90	32.44	34.61	54.00	19.39	Average

Remarks: 1.Emission Level= Antenna factor + Cable loss + Reading - Preamp
 2.The emission level that are 20dB below the official limit are not reported



Audix Technology(Wujiang)Co.,Ltd.
 No.1289,Jiang Xing East Road,Eastern Part of WuJiang
 Economic Development Zone,JiangSu,China
 Tel:0512-63403993 Fax:0512-63403339

Data: 5 File: G:\TEST DATA\2011\Report\12\G1112004.EM6 (8) Date: 2011-12-07

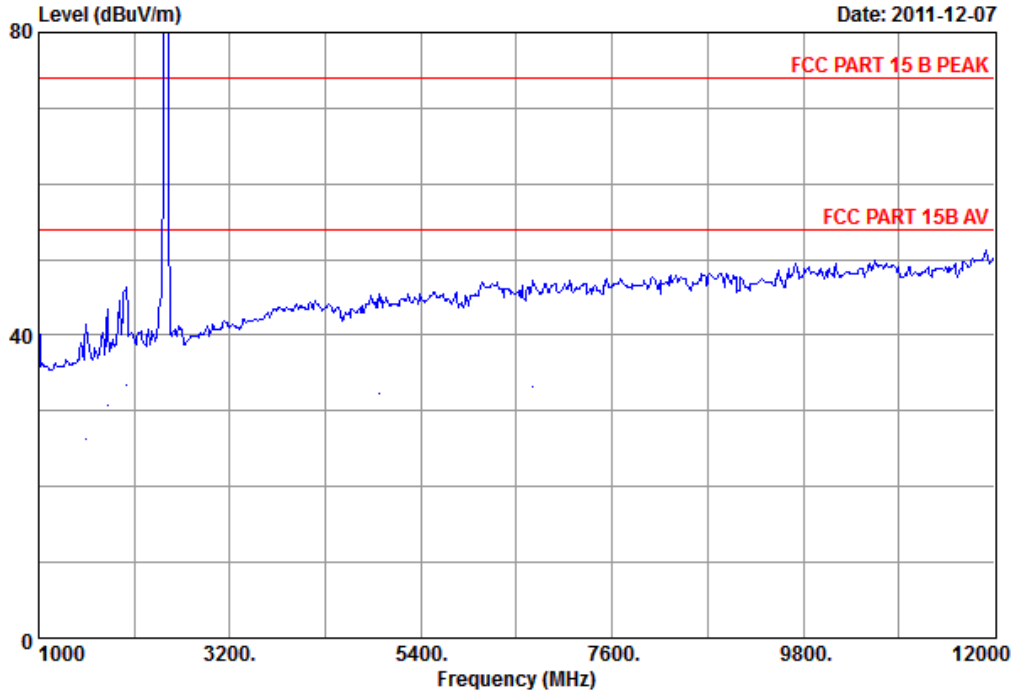

Site No. : NO.1 10m Semi-Anechoic Chamber Data NO. : 5
 Dis./Ant. : 3m 3115(62593)-1105 Ant.pol : HORIZONTAL
 Limit : FCC PART 15 B PEAK
 Env./Ins. : 20*C 55%/ESCI Engineer : Andy
 EUT. : TI-Nspire Navigator Access Point
 M/N : TINAVAP2
 Power Rating : DC 5V Via Laptop
 Test Mode : Test Configuration 1
 Memo : 60" USB Cable

	Freq. (MHz)	Ant. Factor (dB/m)	Cable Loss (dB)	Reading (dBuV)	Preamp Factor (dB)	Emission Level (dBuV/m)	Limits (dBuV/m)	Margin (dB)	Remark
1	1000.00	23.60	1.58	50.94	34.50	41.62	74.00	32.38	Peak
2	1000.00	23.60	1.58	38.50	34.50	29.18	54.00	24.82	Average
3	1539.00	25.58	2.09	48.29	34.60	41.36	74.00	32.64	Peak
4	1539.00	25.58	2.09	33.20	34.60	26.27	54.00	27.73	Average
5	1792.00	26.48	2.32	49.15	34.60	43.35	74.00	30.65	Peak
6	1792.00	26.48	2.32	36.50	34.60	30.70	54.00	23.30	Average
7	2012.00	27.25	2.29	51.51	34.61	46.44	74.00	27.56	Peak
8	2012.00	27.25	2.29	38.50	34.61	33.43	54.00	20.57	Average
9	2452.00	28.54	2.21	101.94	34.78	97.91	74.00	-23.91	Peak
10	4927.00	33.35	3.81	41.66	33.37	45.45	74.00	28.55	Peak
11	4927.00	33.35	3.81	28.60	33.37	32.39	54.00	21.61	Average
12	6687.00	35.57	4.58	39.63	32.54	47.24	74.00	26.76	Peak
13	6687.00	35.57	4.58	25.49	32.54	33.10	54.00	20.90	Average

Remarks: 1.Emission Level= Antenna factor + Cable loss + Reading - Preamp
 2.The emission level that are 20dB below the official limit are not reported



Audix Technology(Wujiang)Co.,Ltd.
 No.1289,Jiang Xing East Road,Eastern Part of WuJiang
 Economic Development Zone,JiangSu,China
 Tel:0512-63403993 Fax:0512-63403339

Data: 6 File: G:\TEST DATA\2011\Report\12\G1112004.EM6 (8) Date: 2011-12-07

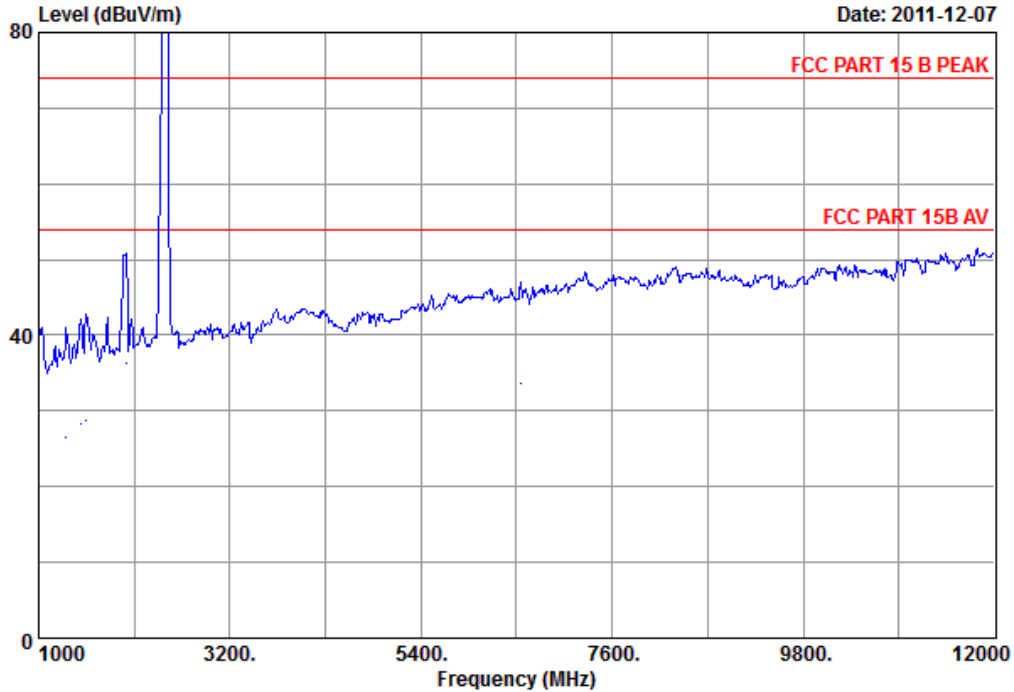

Site No. : NO.1 10m Semi-Anechoic Chamber Data NO. : 6
 Dis./Ant. : 3m 3115(62593)-1105 Ant.pol : VERTICAL
 Limit : FCC PART 15 B PEAK
 Env./Ins. : 20*C 55%/ESCI Engineer : Andy
 EUT. : TI-Nspire Navigator Access Point
 M/N : TINAVAP2
 Power Rating : DC 5V Via Laptop
 Test Mode : Test Configuration 1
 Memo : 60" USB Cable

	Freq. (MHz)	Ant. Factor (dB/m)	Cable Loss (dB)	Reading (dBuV)	Preamp Factor (dB)	Emission Level (dBuV/m)	Limits (dBuV/m)	Margin (dB)	Remark
1	1000.00	23.60	1.58	50.56	34.50	41.24	74.00	32.76	Peak
2	1001.00	23.60	1.58	36.50	34.50	27.18	54.00	26.82	Average
3	1319.00	24.78	1.89	48.90	34.56	41.01	74.00	32.99	Peak
4	1319.00	24.78	1.89	34.49	34.56	26.60	54.00	27.40	Average
5	1484.00	25.34	2.07	49.19	34.59	42.01	74.00	31.99	Peak
6	1484.00	25.34	2.07	35.59	34.59	28.41	54.00	25.59	Average
7	1539.00	25.58	2.09	49.76	34.60	42.83	74.00	31.17	Peak
8	1539.00	25.58	2.09	35.60	34.60	28.67	54.00	25.33	Average
9	2012.00	27.25	2.29	55.89	34.61	50.82	74.00	23.18	Peak
10	2012.00	27.25	2.29	41.50	34.61	36.43	54.00	17.57	Average
11	2419.00	28.44	2.76	102.70	34.77	99.13	74.00	-25.13	Peak
12	6544.00	35.35	4.41	39.78	32.51	47.03	74.00	26.97	Peak
13	6544.00	35.35	4.41	26.50	32.51	33.75	54.00	20.25	Average

Remarks: 1.Emission Level= Antenna factor + Cable loss + Reading - Preamp
 2.The emission level that are 20dB below the official limit are not reported

4.6. Restricted Bands Measurement Results

4.6.1. Type of Network : IEEE 802.11b

Data of Test: Dec. 08, 2011

Ambient temperature: 20.0°C Relative humidity: 60%

Data Rate: 1Mbps

Test Frequency band: TX 2412MHz

Frequency (MHz)	Antenna Polarization	Emission Level (dBuv)	Limit (dBuv)	Margin (dB)	Remark
99.84	Horizontal	31.97	43.5	11.53	QP
128.94	Horizontal	32.67	43.5	10.83	QP
148.34	Horizontal	33	43.5	10.50	QP
329.73	Horizontal	41.55	46	4.45	QP
667.29	Horizontal	32.88	46	13.12	QP
897.18	Horizontal	36.08	46	9.92	QP
4818.75	Horizontal	50.78	74	23.22	Peak
4823.992	Horizontal	44.8	54	9.20	Average

Note 1. : All the emissions (up to 25GHz) not reported are too low to be measured.

Note 2. : The emission behavior belongs to narrowband spurious emission.

Frequency (MHz)	Antenna Polarization	Emission Level (dBuv)	Limit (dBuv)	Margin (dB)	Remark
31.94	Vertical	35.15	40	4.85	QP
62.98	Vertical	33.21	40	6.79	QP
128.94	Vertical	33.53	43.5	9.97	QP
148.34	Vertical	32.72	43.5	10.78	QP
664.38	Vertical	33.97	46	12.03	QP
897.18	Vertical	35.36	46	10.64	QP
4818.75	Vertical	53.26	74	20.74	Peak
4823.98	Vertical	52.03	54	1.97	Average

Note 1. : All the emissions (up to 25GHz) not reported are too low to be measured.

Note 2. : The emission behavior belongs to narrowband spurious emission.

Test Frequency band: TX 2437MHz

Frequency (MHz)	Antenna Polarization	Emission Level (dBuv)	Limit (dBuv)	Margin (dB)	Remark
62.98	Horizontal	23.12	40	16.88	QP
148.34	Horizontal	33.09	43.5	10.41	QP
288.99	Horizontal	33.2	46	12.80	QP
332.64	Horizontal	39.39	46	6.61	QP
667.29	Horizontal	33	46	13.00	QP
897.18	Horizontal	35.04	46	10.96	QP
4877.5	Horizontal	50.39	74	23.61	Peak
4874.004	Horizontal	44.17	54	9.83	Average

Note 1. : All the emissions (up to 25GHz) not reported are too low to be measured.

Note 2. : The emission behavior belongs to narrowband spurious emission.

Frequency (MHz)	Antenna Polarization	Emission Level (dBuv)	Limit (dBuv)	Margin (dB)	Remark
31.94	Vertical	35.05	40	4.95	QP
62.98	Vertical	32.63	40	7.37	QP
111.48	Vertical	33.28	43.5	10.22	QP
581.93	Vertical	32.38	46	13.62	QP
664.38	Vertical	34.24	46	11.76	QP
897.18	Vertical	30.96	46	15.04	QP
4873.86	Vertical	56.1	74	17.90	Peak
4874	Vertical	51.96	54	2.04	Average

Note 1. : All the emissions (up to 25GHz) not reported are too low to be measured.

Note 2. : The emission behavior belongs to narrowband spurious emission.

Test Frequency band: TX 2462MHz

Frequency (MHz)	Antenna Polarization	Emission Level (dBuv)	Limit (dBuv)	Margin (dB)	Remark
148.34	Horizontal	31.86	43.5	11.64	QP
286.08	Horizontal	32.4	46	13.60	QP
332.64	Horizontal	39.46	46	6.54	QP
415.09	Horizontal	39.69	46	6.31	QP
497.54	Horizontal	34.92	46	11.08	QP
664.38	Horizontal	34.39	46	11.61	QP
4912.75	Horizontal	50.62	74	23.38	Peak
4923.94	Horizontal	43.32	54	10.68	Average

Note 1. : All the emissions (up to 25GHz) not reported are too low to be measured.

Note 2. : The emission behavior belongs to narrowband spurious emission.

Frequency (MHz)	Antenna Polarization	Emission Level (dBuv)	Limit (dBuv)	Margin (dB)	Remark
31.94	Vertical	35.35	40	4.65	QP
62.98	Vertical	33.44	40	6.56	QP
111.48	Vertical	33.41	43.5	10.09	QP
128.94	Vertical	34.67	43.5	8.83	QP
664.38	Vertical	33.22	46	12.78	QP
897.18	Vertical	34.55	46	11.45	QP
4912.75	Vertical	51.62	74	22.38	Peak
4923.98	Vertical	51.14	54	2.86	Average

Note 1. : All the emissions (up to 25GHz) not reported are too low to be measured.

Note 2. : The emission behavior belongs to narrowband spurious emission.

4.6.2. Type of Network : IEEE 802.11g

Data of Test: Dec. 08, 2011

Ambient temperature: 20.0°C Relative humidity: 60%

Data Rate: 6Mbps

Test Frequency band: TX 2412MHz

Frequency (MHz)	Antenna Polarization	Emission Level (dBuv)	Limit (dBuv)	Margin (dB)	Remark
62.98	Horizontal	23.48	40	16.52	QP
128.94	Horizontal	30.69	43.5	12.81	QP
148.34	Horizontal	33.03	43.5	10.47	QP
332.64	Horizontal	36.81	46	9.19	QP
664.38	Horizontal	34.59	46	11.41	QP
897.18	Horizontal	34.8	46	11.20	QP
4818.75	Horizontal	51.33	74	22.67	Peak
4822.39	Horizontal	39.74	54	14.26	Average

Note 1. : All the emissions (up to 25GHz) not reported are too low to be measured.

Note 2. : The emission behavior belongs to narrowband spurious emission.

Frequency (MHz)	Antenna Polarization	Emission Level (dBuv)	Limit (dBuv)	Margin (dB)	Remark
31.94	Vertical	34.97	40	5.03	QP
62.98	Vertical	33.38	40	6.62	QP
111.48	Vertical	33.99	43.5	9.51	QP
169.68	Vertical	31.42	43.5	12.08	QP
497.54	Vertical	36.85	46	9.15	QP
664.38	Vertical	34.05	46	11.95	QP
4818.75	Vertical	54.61	74	19.39	Peak
4822	Vertical	45.39	54	8.61	Average

Note 1. : All the emissions (up to 25GHz) not reported are too low to be measured.

Note 2. : The emission behavior belongs to narrowband spurious emission.

Test Frequency band: TX 2437MHz

Frequency (MHz)	Antenna Polarization	Emission Level (dBuv)	Limit (dBuv)	Margin (dB)	Remark
62.98	Horizontal	23.6	40	16.40	QP
116.33	Horizontal	31.17	43.5	12.33	QP
148.34	Horizontal	31.89	43.5	11.61	QP
332.64	Horizontal	34.89	46	11.11	QP
664.38	Horizontal	34.03	46	11.97	QP
897.18	Horizontal	38.07	46	7.93	QP
4877.5	Horizontal	50.75	74	23.25	Peak
4874.38	Horizontal	40.71	54	13.29	Average

Note 1. : All the emissions (up to 25GHz) not reported are too low to be measured.

Note 2. : The emission behavior belongs to narrowband spurious emission.

Frequency (MHz)	Antenna Polarization	Emission Level (dBuv)	Limit (dBuv)	Margin (dB)	Remark
31.94	Vertical	35.1	40	4.90	QP
62.98	Vertical	33.83	40	6.17	QP
119.24	Vertical	36.24	43.5	7.26	QP
240.012	Vertical	41.5	46	4.50	QP
720.64	Vertical	36.05	46	9.95	QP
897.18	Vertical	38.45	46	7.55	QP
4877.5	Vertical	55.73	74	18.27	Peak
4875.85	Vertical	44.55	54	9.45	Average

Note 1. : All the emissions (up to 25GHz) not reported are too low to be measured.

Note 2. : The emission behavior belongs to narrowband spurious emission.

Test Frequency band: TX 2462MHz

Frequency (MHz)	Antenna Polarization	Emission Level (dBuv)	Limit (dBuv)	Margin (dB)	Remark
62.98	Horizontal	23.13	40	16.87	QP
116.33	Horizontal	29.82	43.5	13.68	QP
148.34	Horizontal	31.48	43.5	12.02	QP
332.64	Horizontal	40.07	46	5.93	QP
664.38	Horizontal	32.53	46	13.47	QP
897.18	Horizontal	36.92	46	9.08	QP
4912.75	Horizontal	49.9	74	24.10	Peak
4919.78	Horizontal	38.49	54	15.51	Average

Note 1. : All the emissions (up to 25GHz) not reported are too low to be measured.

Note 2. : The emission behavior belongs to narrowband spurious emission.

Frequency (MHz)	Antenna Polarization	Emission Level (dBuv)	Limit (dBuv)	Margin (dB)	Remark
31.94	Vertical	34.99	40	5.01	QP
62.98	Vertical	31.94	40	8.06	QP
111.48	Vertical	35.74	43.5	7.76	QP
130.88	Vertical	36.28	43.5	7.22	QP
240.49	Vertical	41.49	46	4.51	QP
960.23	Vertical	35.16	54	18.84	QP
4936.25	Vertical	56.85	74	17.15	Peak
4921.88	Vertical	44.66	54	9.34	Average

Note 1. : All the emissions (up to 25GHz) not reported are too low to be measured.

Note 2. : The emission behavior belongs to narrowband spurious emission.

4.6.3. Type of Network : IEEE 802.11n HT20

Data of Test: Dec. 08, 2011

Ambient temperature: 20.0°C Relative humidity: 60%

Data Rate: MCS0

Test Frequency band: TX 2412MHz

Frequency (MHz)	Antenna Polarization	Emission Level (dBuv)	Limit (dBuv)	Margin (dB)	Remark
62.98	Horizontal	22.75	40	17.25	QP
119.24	Horizontal	30.52	43.5	12.98	QP
148.34	Horizontal	31.76	43.5	11.74	QP
286.08	Horizontal	32.18	46	13.82	QP
664.38	Horizontal	31.95	46	14.05	QP
897.18	Horizontal	31.7	46	14.30	QP
4818.75	Horizontal	51.37	74	22.63	Peak
4824.1	Horizontal	36.06	54	17.94	Average

Note 1. : All the emissions (up to 25GHz) not reported are too low to be measured.

Note 2. : The emission behavior belongs to narrowband spurious emission.

Frequency (MHz)	Antenna Polarization	Emission Level (dBuv)	Limit (dBuv)	Margin (dB)	Remark
31.94	Vertical	34.81	40	5.19	QP
62.98	Vertical	32.72	40	7.28	QP
111.48	Vertical	35.96	43.5	7.54	QP
240.49	Vertical	43.04	46	2.96	QP
664.38	Vertical	34.66	46	11.34	QP
720.64	Vertical	35.73	46	10.27	QP
4818.75	Vertical	55.58	74	18.42	Peak
4824.28	Vertical	42.86	54	11.14	Average

Note 1. : All the emissions (up to 25GHz) not reported are too low to be measured.

Note 2. : The emission behavior belongs to narrowband spurious emission.

Test Frequency band: TX 2437MHz

Frequency (MHz)	Antenna Polarization	Emission Level (dBuv)	Limit (dBuv)	Margin (dB)	Remark
148.34	Horizontal	32.42	43.5	11.08	QP
281.23	Horizontal	30.91	46	15.09	QP
332.64	Horizontal	39.79	46	6.21	QP
376.29	Horizontal	31.96	46	14.04	QP
667.29	Horizontal	32.91	46	13.09	QP
897.18	Horizontal	36.37	46	9.63	QP
4877.5	Horizontal	51.07	74	22.93	Peak
4870	Horizontal	36.55	54	17.45	Average

Note 1. : All the emissions (up to 25GHz) not reported are too low to be measured.

Note 2. : The emission behavior belongs to narrowband spurious emission.

Frequency (MHz)	Antenna Polarization	Emission Level (dBuv)	Limit (dBuv)	Margin (dB)	Remark
31.94	Vertical	34.78	40	5.22	QP
62.98	Vertical	34.07	40	5.93	QP
130.88	Vertical	35.38	43.5	8.12	QP
240.49	Vertical	42.93	46	3.07	QP
664.38	Vertical	34.3	46	11.70	QP
720.64	Vertical	35.45	46	10.55	QP
4877.5	Vertical	55.53	74	18.47	Peak
4868.64	Vertical	42.68	54	11.32	Average

Note 1. : All the emissions (up to 25GHz) not reported are too low to be measured.

Note 2. : The emission behavior belongs to narrowband spurious emission.

Test Frequency band: TX 2462MHz

Frequency (MHz)	Antenna Polarization	Emission Level (dBuv)	Limit (dBuv)	Margin (dB)	Remark
62.98	Horizontal	24.87	40	15.13	QP
119.24	Horizontal	31.07	43.5	12.43	QP
148.34	Horizontal	32.1	43.5	11.40	QP
332.64	Horizontal	36.64	46	9.36	QP
415.09	Horizontal	35.85	46	10.15	QP
664.38	Horizontal	32.87	46	13.13	QP
4912.75	Horizontal	51.01	74	22.99	Peak
4927.4	Horizontal	35.84	54	18.16	Average

Note 1. : All the emissions (up to 25GHz) not reported are too low to be measured.

Note 2. : The emission behavior belongs to narrowband spurious emission.

Frequency (MHz)	Antenna Polarization	Emission Level (dBuv)	Limit (dBuv)	Margin (dB)	Remark
31.94	Vertical	34.88	40	5.12	QP
62.98	Vertical	33.37	40	6.63	QP
119.24	Vertical	35.71	43.5	7.79	QP
240.49	Vertical	41.91	46	4.09	QP
720.64	Vertical	35.75	46	10.25	QP
897.18	Vertical	36.59	46	9.41	QP
4912.75	Vertical	52.64	74	21.36	Peak
4923.53	Vertical	40.34	54	13.66	Average

Note 1. : All the emissions (up to 25GHz) not reported are too low to be measured.

Note 2. : The emission behavior belongs to narrowband spurious emission.

4.7. Spurious Emission Measurement Results in Band Edge Emission (FCC Part 15, 15.205)

4.7.1. IEEE 802.11b



Audix Technology(Wujiang)Co.,Ltd.
 No.1289,Jiang Xing East Road,The Eastern Part of Wu Jiang
 Economic Development Zone,JiangSu,China
 Tel:(0512) 63403993 Fax:(0512) 63403993

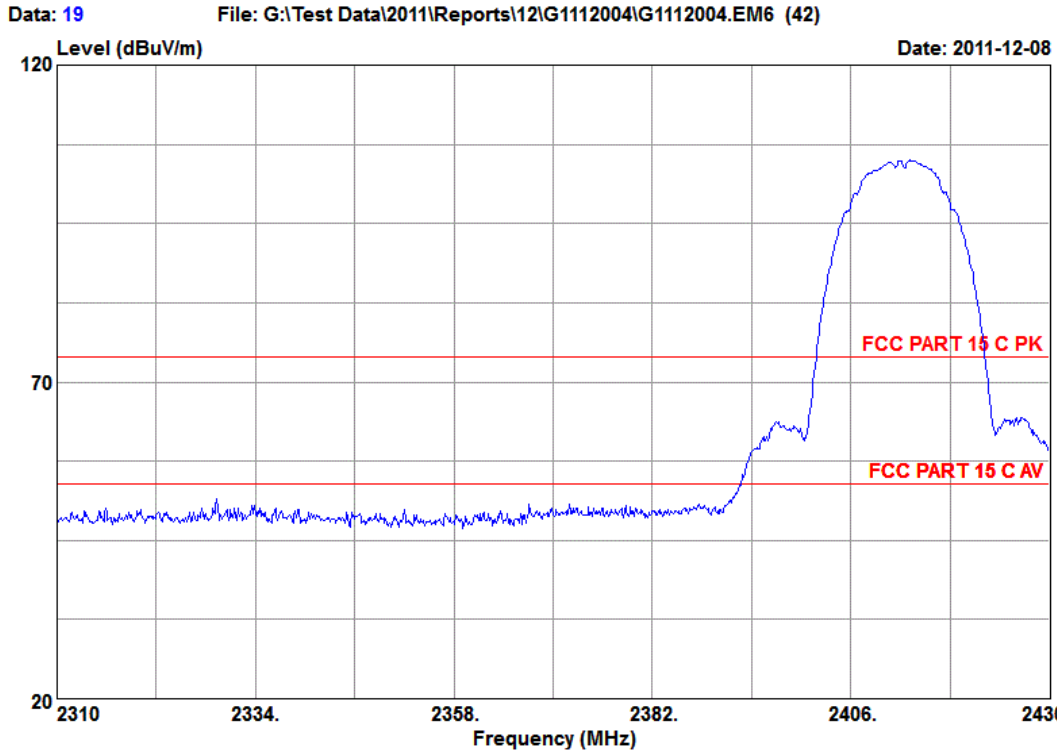

Site NO. : 3m Semi-Anechoic Chamber	Data NO. : 19
Dis. / Ant. : 3m HORN 3115(62961)	Ant. pol. : HORIZONTAL
Limit : FCC PART 15 C PK	Engineer : Justin
Env. / Ins. : 20.0*C&60%/Agilent E4447A	
EUT : TI-Nspire Navigator Access Point	
M/N : TINAVAP2	
Power Rating: DC 5V Via Laptop	
Test Mode : TX CH1	
Memo : 802.11b	

	Freq. (MHz)	Ant. Factor (dB/m)	Cable Loss (dB)	Reading (dBUV)	Preamp. Factor (dB)	Emission Level (dBUV/m)	Limits (dBUV/m)	Margin (dB)	Remark
1	2390.00	28.53	8.47	47.78	35.46	49.32	74.00	24.68	Peak

Remarks: 1. Emission Level= Ant.Factor + Cable Loss + Reading - Preamp.Factor.
 2. The emission levels that are 20dB below the official limit are not reported.



Audix Technology(Wujiang)Co.,Ltd.
 No.1289,Jiang Xing East Road,The Eastern Part of Wu Jiang
 Economic Development Zone,JiangSu,China
 Tel:(0512)63403993 Fax:(0512)63403993

Data: 20 File: G:\Test Data\2011\Reports\12\G1112004\G1112004.EM6 (42)

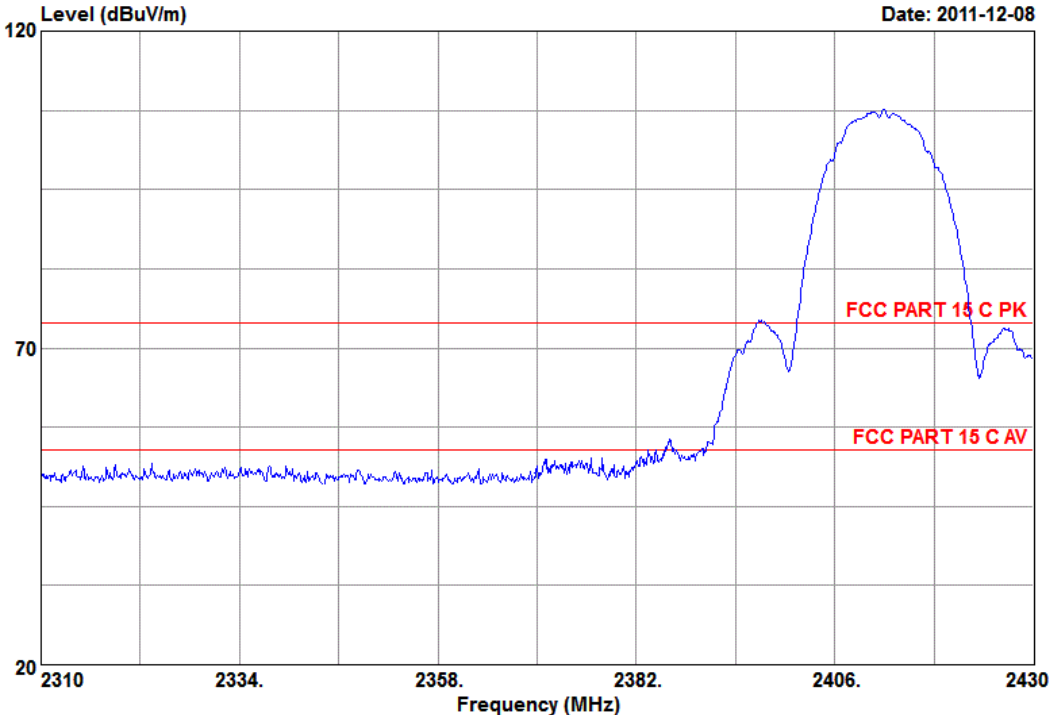

Site NO. : 3m Semi-Anechoic Chamber Data NO. : 20
 Dis. / Ant. : 3m HORN 3115(62961) Ant. pol. : VERTICAL
 Limit : FCC PART 15 C PK
 Env. / Ins. : 20.0*CS&60%/Agilent E4447A Engineer : Justin
 EUT : TI-Nspire Navigator Access Point
 M/N : TINAVAP2
 Power Rating: DC 5V Via Laptop
 Test Mode : TX CH1
 Memo : 802.11b

	Freq. (MHz)	Ant. Factor (dB/m)	Cable Loss (dB)	Reading (dBuV)	Preamp. Factor (dB)	Emission Level (dBuV/m)	Limits (dBuV/m)	Margin (dB)	Remark
1	2390.00	28.53	8.47	52.55	35.46	54.09	74.00	19.91	Peak

Remarks: 1. Emission Level= Ant.Factor + Cable Loss + Reading - Preamp.Factor.
 2. The emission levels that are 20dB below the official limit are not reported.



Audix Technology(Wujiang)Co.,Ltd.
 No.1289,Jiang Xing East Road,The Eastern Part of Wu Jiang
 Economic Development Zone,JiangSu,China
 Tel:(0512)63403993 Fax:(0512)63403993

Data: 21 File: G:\Test Data\2011\Reports\12\G1112004\G1112004.EM6 (42)

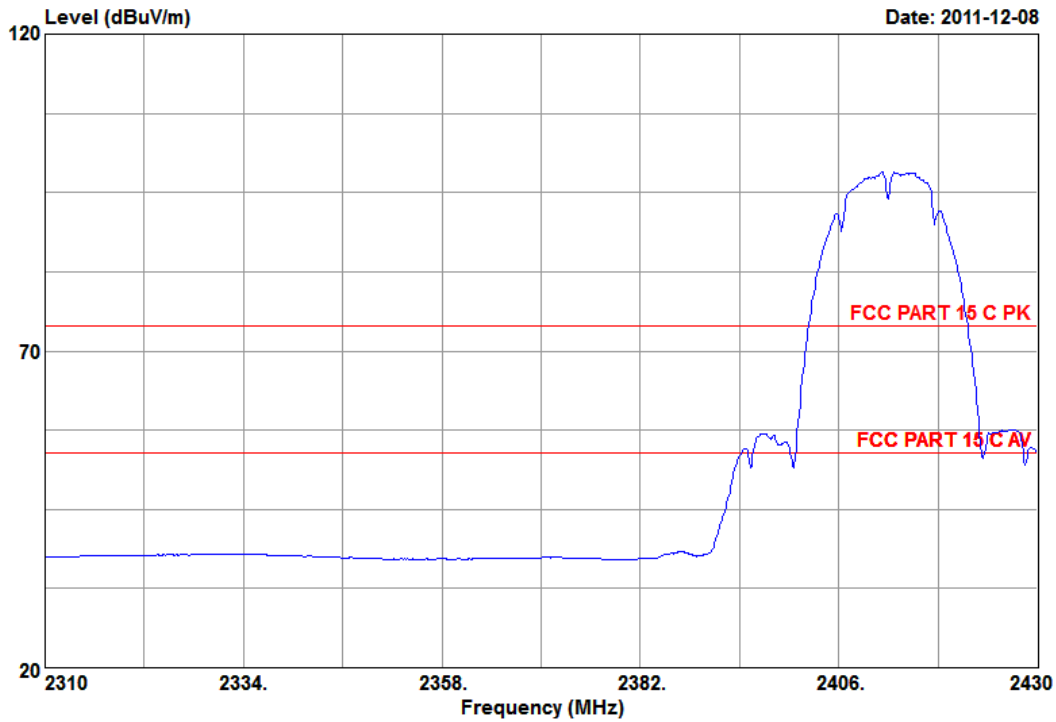

Site NO. : 3m Semi-Anechoic Chamber Data NO. : 21
 Dis. / Ant. : 3m HORN 3115(62961) Ant. pol. : HORIZONTAL
 Limit : FCC PART 15 C PK
 Env. / Ins. : 20.0*CS&60%/Agilent E4447A Engineer : Justin
 EUT : TI-Nspire Navigator Access Point
 M/N : TINAVAP2
 Power Rating: DC 5V Via Laptop
 Test Mode : TX CH1
 Memo : 802.11b

	Freq. (MHz)	Ant. Factor (dB/m)	Cable Loss (dB)	Reading (dBuV)	Preamp. Factor (dB)	Emission Level (dBuV/m)	Limits (dBuV/m)	Margin (dB)	Remark
1	2390.00	28.53	8.47	36.40	35.46	37.94	54.00	16.06	Average

Remarks: 1. Emission Level= Ant.Factor + Cable Loss + Reading - Preamp.Factor.
 2. The emission levels that are 20dB below the official limit are not reported.



Audix Technology(Wujiang)Co.,Ltd.
 No.1289,Jiang Xing East Road,The Eastern Part of Wu Jiang
 Economic Development Zone,JiangSu,China
 Tel:(0512)63403993 Fax:(0512)63403993

Data: 22 File: G:\Test Data\2011\Reports\12\G1112004\G1112004.EM6 (42)

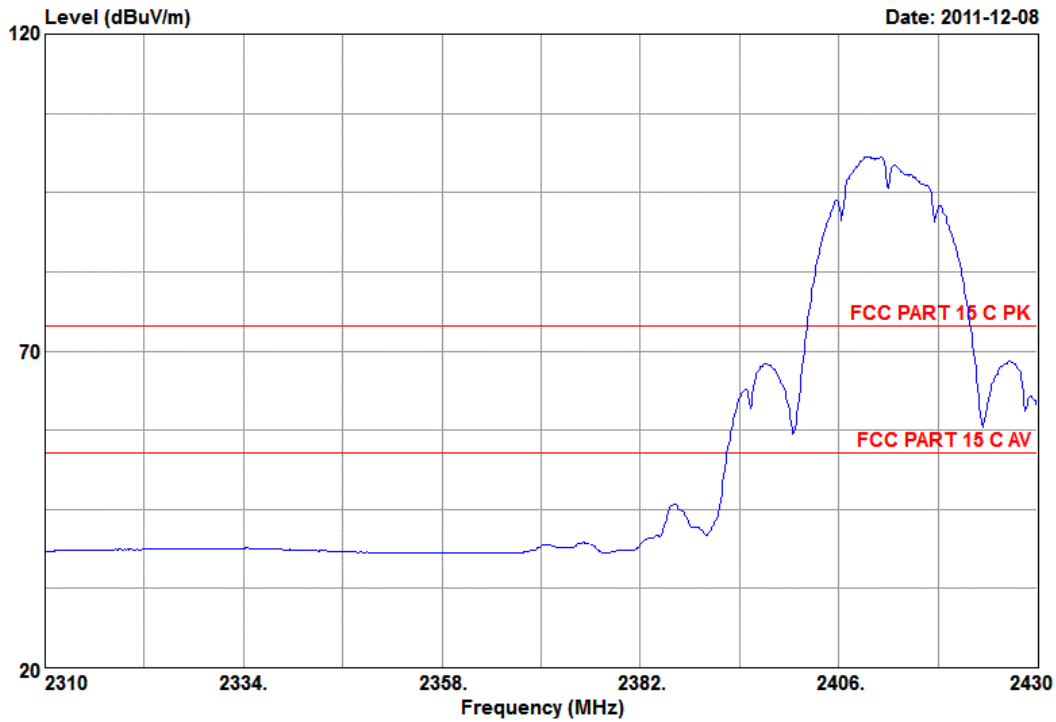

Site NO. : 3m Semi-Anechoic Chamber	Data NO. : 22
Dis. / Ant. : 3m HORN 3115(62961)	Ant. pol. : VERTICAL
Limit : FCC PART 15 C PK	Engineer : Justin
Env. / Ins. : 20.0*CS&60%/Agilent E4447A	
EUT : TI-Nspire Navigator Access Point	
M/N : TINAVAP2	
Power Rating: DC 5V Via Laptop	
Test Mode : TX CH1	
Memo : 802.11b	

	Freq. (MHz)	Ant. Factor (dB/m)	Cable Loss (dB)	Reading (dBuV)	Preamp. Factor (dB)	Emission Level (dBuV/m)	Limits (dBuV/m)	Margin (dB)	Remark
1	2390.00	28.53	8.47	39.37	35.46	40.91	54.00	13.09	Average

Remarks: 1. Emission Level= Ant.Factor + Cable Loss + Reading - Preamp.Factor.
 2. The emission levels that are 20dB below the official limit are not reported.



Audix Technology(Wujiang)Co.,Ltd.
 No.1289,Jiang Xing East Road,The Eastern Part of Wu Jiang
 Economic Development Zone,JiangSu,China
 Tel:(0512)63403993 Fax:(0512)63403993

Data: 23 File: G:\Test Data\2011\Reports\12\G1112004\G1112004.EM6 (42)

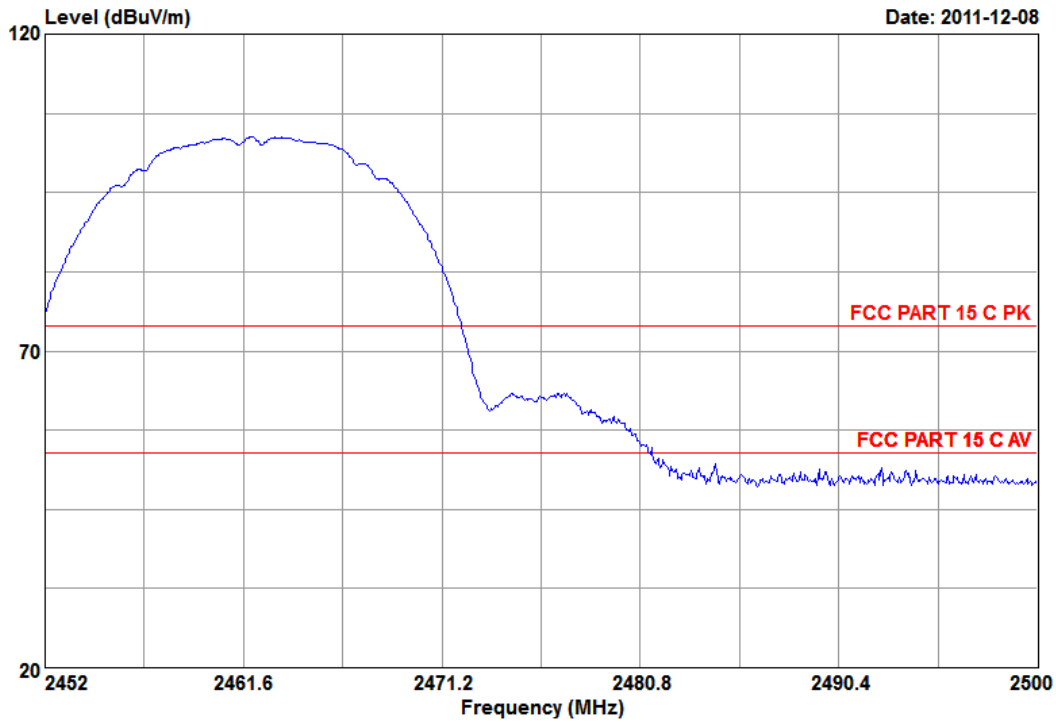

Site NO. : 3m Semi-Anechoic Chamber Data NO. : 23
 Dis. / Ant. : 3m HORN 3115(62961) Ant. pol. : HORIZONTAL
 Limit : FCC PART 15 C PK
 Env. / Ins. : 20.0*CS&60%/Agilent E4447A Engineer : Justin
 EUT : TI-Nspire Navigator Access Point
 M/N : TINAVAP2
 Power Rating: DC 5V Via Laptop
 Test Mode : TX CH11
 Memo : 802.11b

	Freq. (MHz)	Ant. Factor (dB/m)	Cable Loss (dB)	Reading (dBuV)	Preamp. Factor (dB)	Emission Level (dBuV/m)	Limits (dBuV/m)	Margin (dB)	Remark
1	2483.00	28.76	9.42	47.75	35.49	50.44	74.00	23.56	Peak

Remarks: 1. Emission Level= Ant.Factor + Cable Loss + Reading - Preamp.Factor.
 2. The emission levels that are 20dB below the official limit are not reported.



Audix Technology(Wujiang)Co.,Ltd.
 No.1289,Jiang Xing East Road,The Eastern Part of Wu Jiang
 Economic Development Zone,JiangSu,China
 Tel:(0512)63403993 Fax:(0512)63403993

Data: 24 File: G:\Test Data\2011\Reports\12\G1112004\G1112004.EM6 (42)

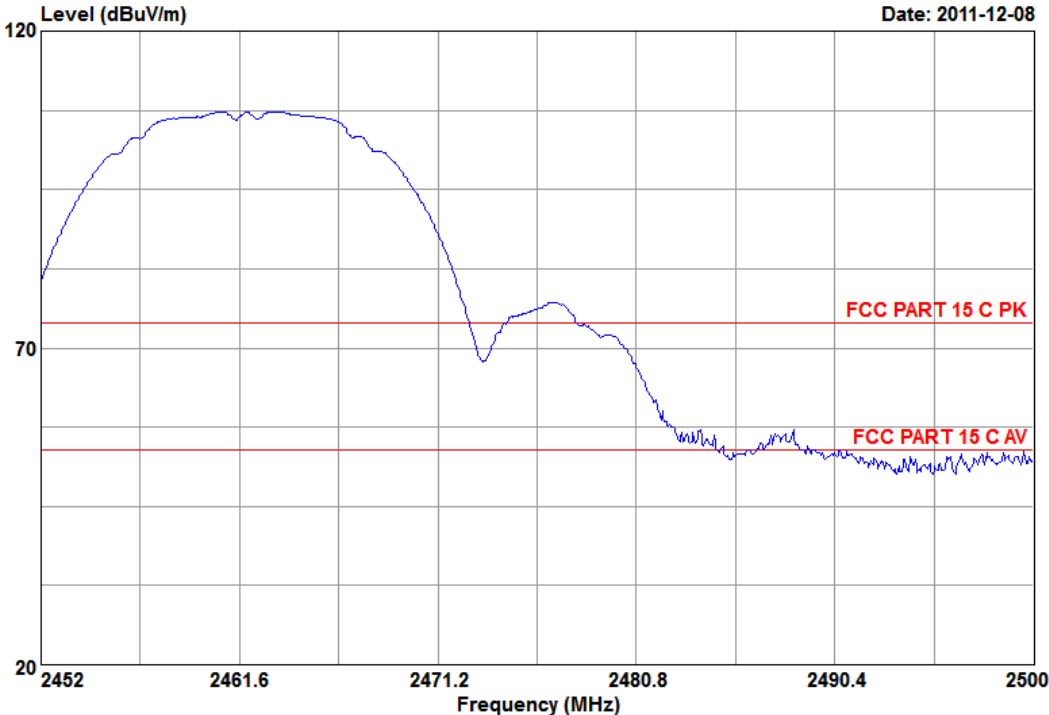

Site NO. : 3m Semi-Anechoic Chamber	Data NO. : 24
Dis. / Ant. : 3m HORN 3115(62961)	Ant. pol. : VERTICAL
Limit : FCC PART 15 C PK	
Env. / Ins. : 20.0*CS&60%/Agilent E4447A	Engineer : Justin
EUT : TI-Nspire Navigator Access Point	
M/N : TINAVAP2	
Power Rating: DC 5V Via Laptop	
Test Mode : TX CH11	
Memo : 802.11b	

	Freq. (MHz)	Ant. Factor (dB/m)	Cable Loss (dB)	Reading (dBuV)	Preamp. Factor (dB)	Emission Level (dBuV/m)	Limits (dBuV/m)	Margin (dB)	Remark
1	2483.00	28.76	9.42	54.02	35.49	56.71	74.00	17.29	Peak

Remarks: 1. Emission Level= Ant.Factor + Cable Loss + Reading - Preamp.Factor.
 2. The emission levels that are 20dB below the official limit are not reported.



Audix Technology(Wujiang)Co.,Ltd.
 No.1289,Jiang Xing East Road,The Eastern Part of Wu Jiang
 Economic Development Zone,JiangSu,China
 Tel:(0512)63403993 Fax:(0512)63403993

Data: 25 File: G:\Test Data\2011\Reports\12\G1112004\G1112004.EM6 (42)

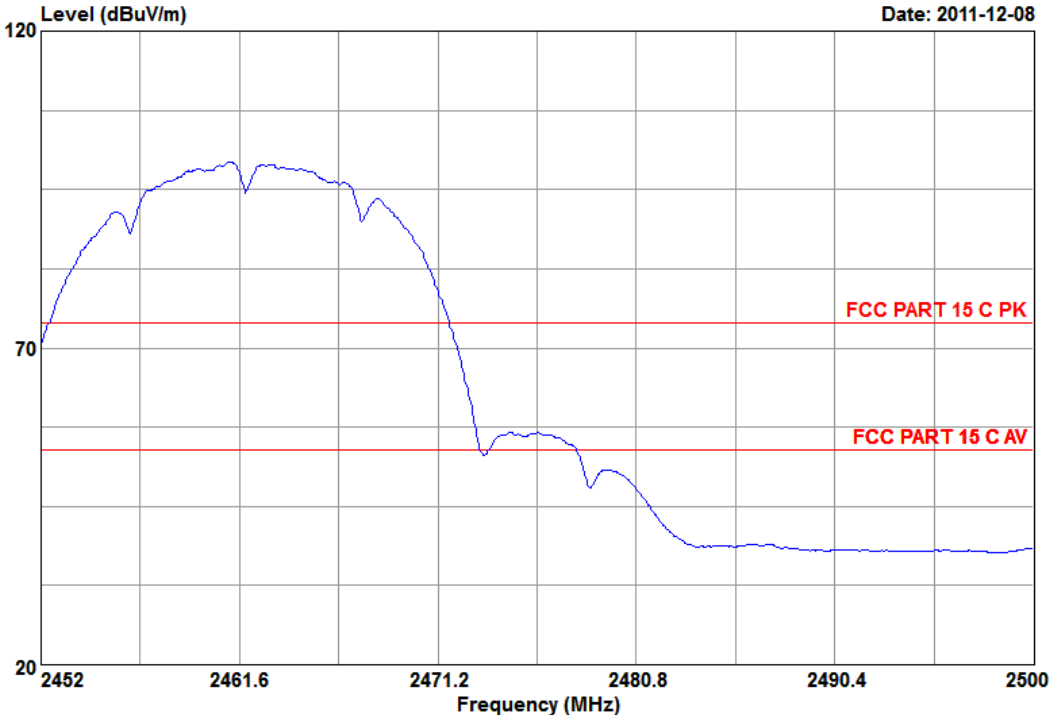

Site NO. : 3m Semi-Anechoic Chamber Data NO. : 25
 Dis. / Ant. : 3m HORN 3115(62961) Ant. pol. : HORIZONTAL
 Limit : FCC PART 15 C PK
 Env. / Ins. : 20.0*CS&60%/Agilent E4447A Engineer : Justin
 EUT : TI-Nspire Navigator Access Point
 M/N : TINAVAP2
 Power Rating: DC 5V Via Laptop
 Test Mode : TX CH11
 Memo : 802.11b

	Freq. (MHz)	Ant. Factor (dB/m)	Cable Loss (dB)	Reading (dBuV)	Preamp. Factor (dB)	Emission Level (dBuV/m)	Limits (dBuV/m)	Margin (dB)	Remark
1	2483.00	28.76	9.42	36.94	35.49	39.63	54.00	14.37	Average

Remarks: 1. Emission Level= Ant.Factor + Cable Loss + Reading - Preamp.Factor.
 2. The emission levels that are 20dB below the official limit are not reported.



Audix Technology(Wujiang)Co.,Ltd.
 No.1289,Jiang Xing East Road,The Eastern Part of Wu Jiang
 Economic Development Zone,JiangSu,China
 Tel:(0512)63403993 Fax:(0512)63403993

Data: 26 File: G:\Test Data\2011\Reports\12\G1112004\G1112004.EM6 (42)

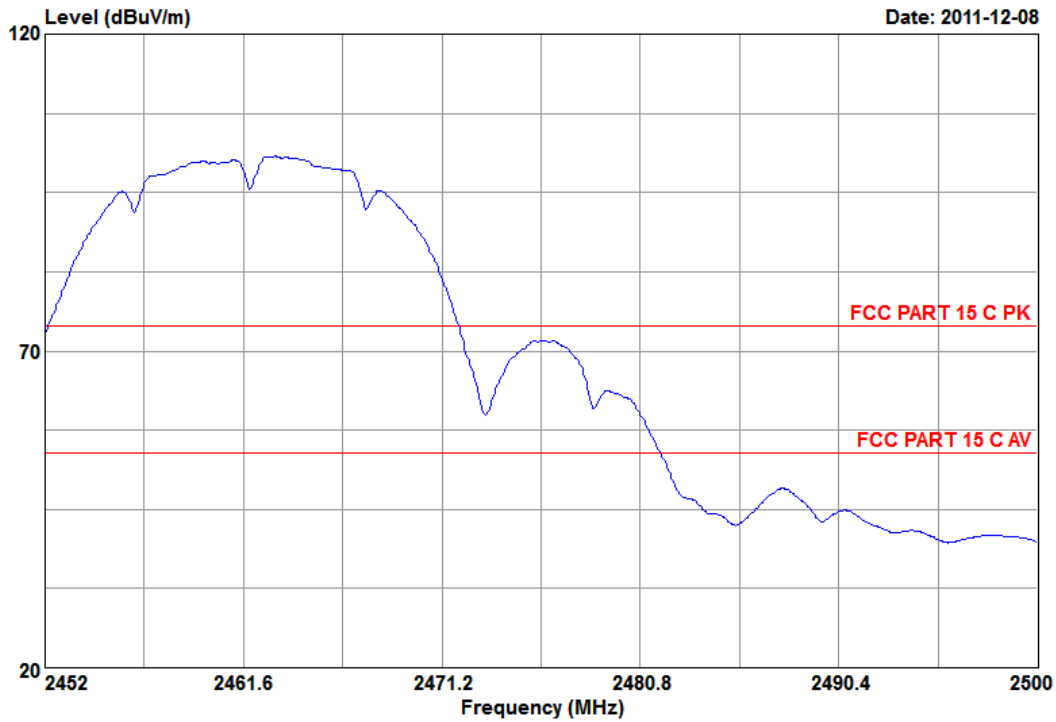

Site NO. : 3m Semi-Anechoic Chamber	Data NO. : 26
Dis. / Ant. : 3m HORN 3115(62961)	Ant. pol. : VERTICAL
Limit : FCC PART 15 C PK	
Env. / Ins. : 20.0*CS&60%/Agilent E4447A	Engineer : Justin
EUT : TI-Nspire Navigator Access Point	
M/N : TINAVAP2	
Power Rating: DC 5V Via Laptop	
Test Mode : TX CH11	
Memo : 802.11b	

	Freq. (MHz)	Ant. Factor (dB/m)	Cable Loss (dB)	Reading (dBuV)	Preamp. Factor (dB)	Emission Level (dBuV/m)	Limits (dBuV/m)	Margin (dB)	Remark
1	2483.00	28.76	9.42	44.08	35.49	46.77	54.00	7.23	Average

Remarks: 1. Emission Level= Ant.Factor + Cable Loss + Reading - Preamp.Factor.
 2. The emission levels that are 20dB below the official limit are not reported.

4.7.2. IEEE 802.11g



Audix Technology(Wujiang)Co.,Ltd.
No.1289,Jiang Xing East Road,The Eastern Part of Wu Jiang
Economic Development Zone,JiangSu,China
Tel:(0512)63403993 Fax:(0512)63403993

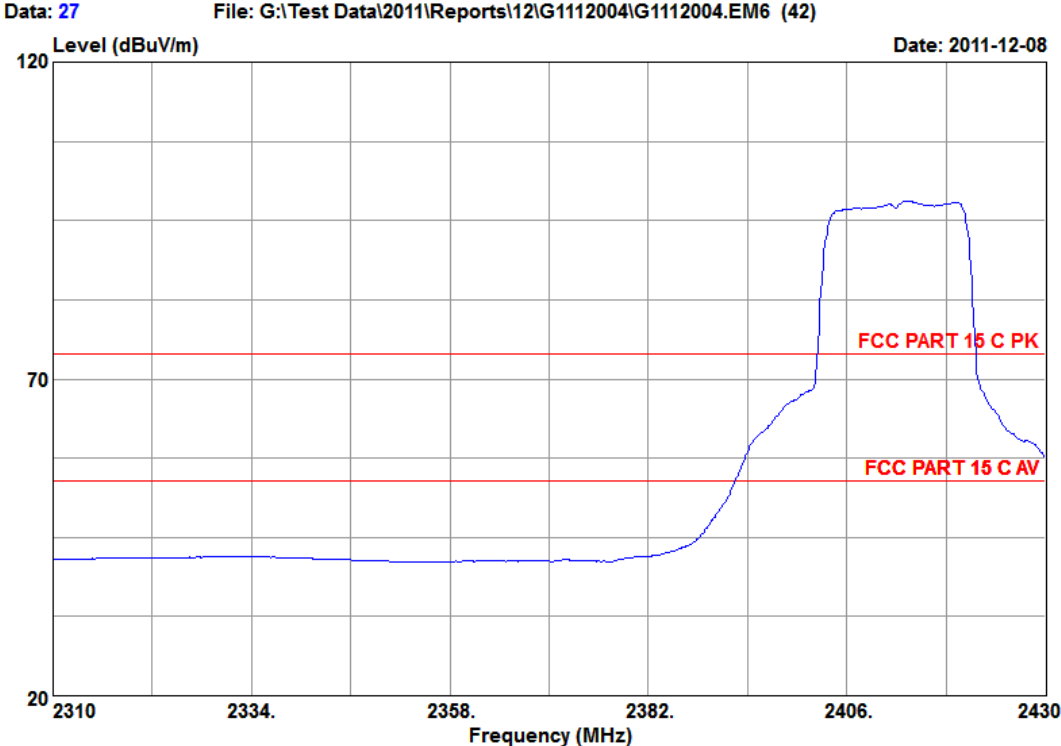

Site NO. : 3m Semi-Anechoic Chamber
Dis. / Ant. : 3m HORN 3115(62961)
Limit : FCC PART 15 C PK
Env. / Ins. : 20.0*C&60%/Agilent E4447A
EUT : TI-Nspire Navigator Access Point
M/N : TINAVAP2
Power Rating: DC 5V Via Laptop
Test Mode : TX CH1
Memo : 802.11g
Data NO. : 27
Ant. pol. : HORIZONTAL
Engineer : Justin

Table with 10 columns: Freq. (MHz), Ant. Factor (dB/m), Cable Loss (dB), Reading (dBuV), Preamp. Factor (dB), Emission Level (dBuV/m), Limits (dBuV/m), Margin (dB), Remark. Row 1: 2390.00, 28.53, 8.47, 46.62, 35.46, 48.16, 54.00, 5.84, Average

Remarks: 1. Emission Level= Ant.Factor + Cable Loss + Reading - Preamp.Factor.
2. The emission levels that are 20dB below the official limit are not reported.



Audix Technology(Wujiang)Co.,Ltd.
 No.1289,Jiang Xing East Road,The Eastern Part of Wu Jiang
 Economic Development Zone,JiangSu,China
 Tel:(0512)63403993 Fax:(0512)63403993

Data: 28 File: G:\Test Data\2011\Reports\12\G1112004\G1112004.EM6 (42)

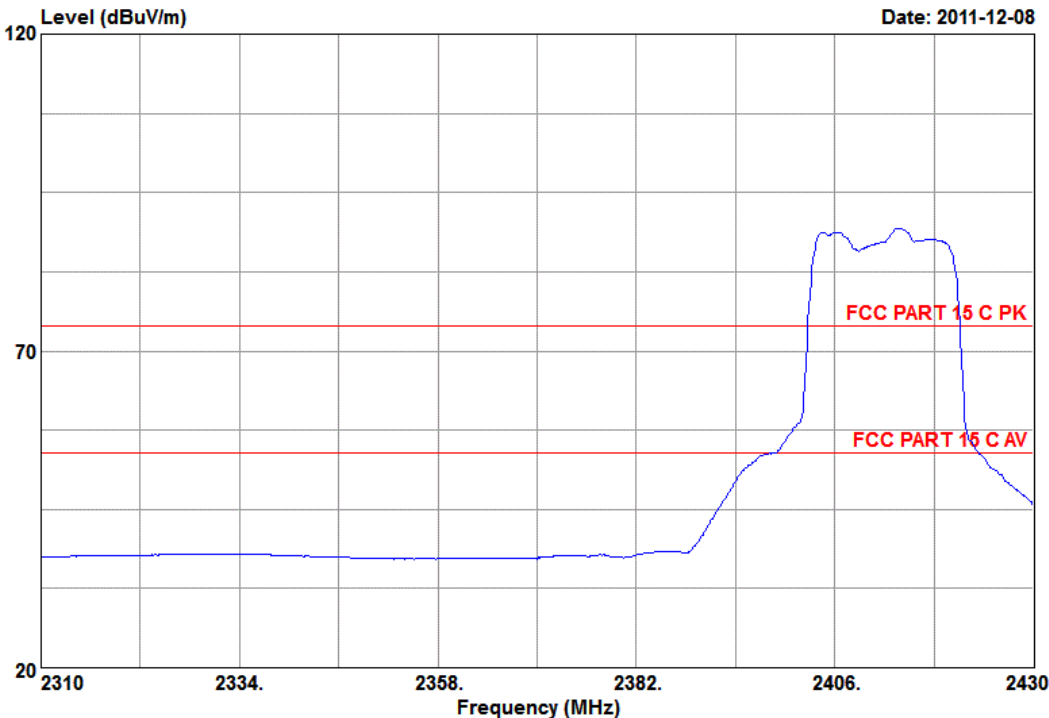

Site NO. : 3m Semi-Anechoic Chamber Data NO. : 28
 Dis. / Ant. : 3m HORN 3115(62961) Ant. pol. : VERTICAL
 Limit : FCC PART 15 C PK
 Env. / Ins. : 20.0*CS&60%/Agilent E4447A Engineer : Justin
 EUT : TI-Nspire Navigator Access Point
 M/N : TINAVAP2
 Power Rating: DC 5V Via Laptop
 Test Mode : TX CH1
 Memo : 802.11g

	Freq. (MHz)	Ant. Factor (dB/m)	Cable Loss (dB)	Reading (dBuV)	Preamp. Factor (dB)	Emission Level (dBuV/m)	Limits (dBuV/m)	Margin (dB)	Remark
1	2390.00	28.53	8.47	39.34	35.46	40.88	54.00	13.12	Average

Remarks: 1. Emission Level= Ant.Factor + Cable Loss + Reading - Preamp.Factor.
 2. The emission levels that are 20dB below the official limit are not reported.



Audix Technology(Wujiang)Co.,Ltd.
 No.1289,Jiang Xing East Road,The Eastern Part of Wu Jiang
 Economic Development Zone,JiangSu,China
 Tel:(0512)63403993 Fax:(0512)63403993

Data: 29 File: G:\Test Data\2011\Reports\12\G1112004\G1112004.EM6 (42)

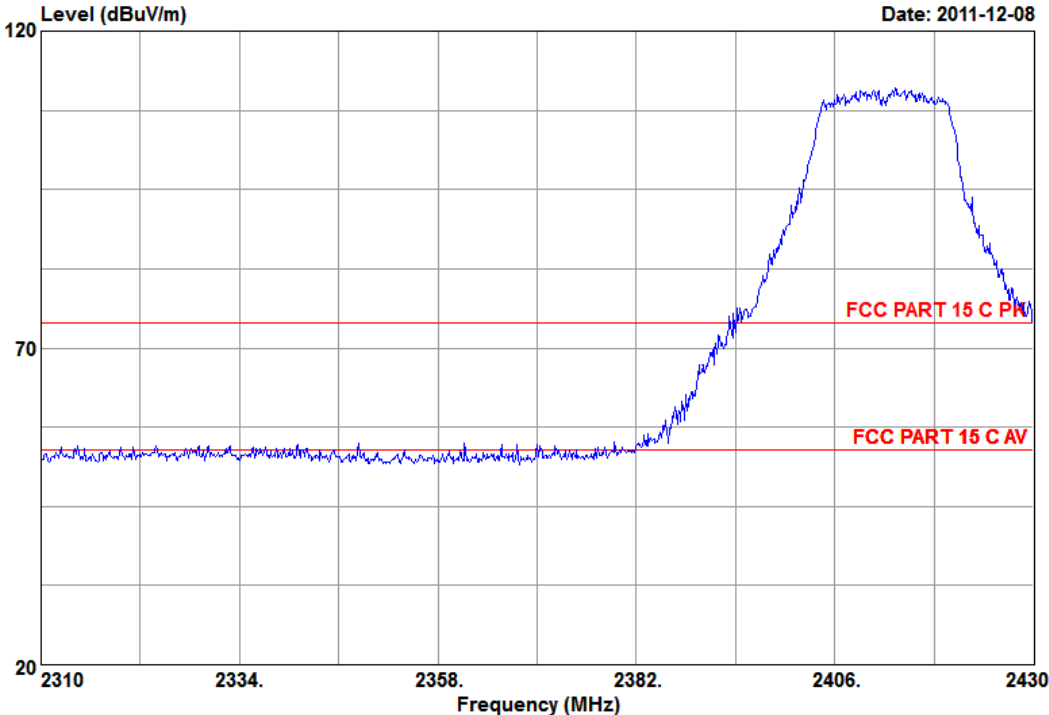

Site NO. : 3m Semi-Anechoic Chamber Data NO. : 29
 Dis. / Ant. : 3m HORN 3115(62961) Ant. pol. : HORIZONTAL
 Limit : FCC PART 15 C PK
 Env. / Ins. : 20.0*CS&60%/Agilent E4447A Engineer : Justin
 EUT : TI-Nspire Navigator Access Point
 M/N : TINAVAP2
 Power Rating: DC 5V Via Laptop
 Test Mode : TX CH1
 Memo : 802.11g

	Freq. (MHz)	Ant. Factor (dB/m)	Cable Loss (dB)	Reading (dBuV)	Preamp. Factor (dB)	Emission Level (dBuV/m)	Limits (dBuV/m)	Margin (dB)	Remark
1	2390.00	28.53	8.47	65.91	35.46	67.45	74.00	6.55	Peak

Remarks: 1. Emission Level= Ant.Factor + Cable Loss + Reading - Preamp.Factor.
 2. The emission levels that are 20dB below the official limit are not reported.



Audix Technology(Wujiang)Co.,Ltd.
 No.1289,Jiang Xing East Road,The Eastern Part of Wu Jiang
 Economic Development Zone,JiangSu,China
 Tel:(0512)63403993 Fax:(0512)63403993

Data: 30 File: G:\Test Data\2011\Reports\12\G1112004\G1112004.EM6 (42) Date: 2011-12-08

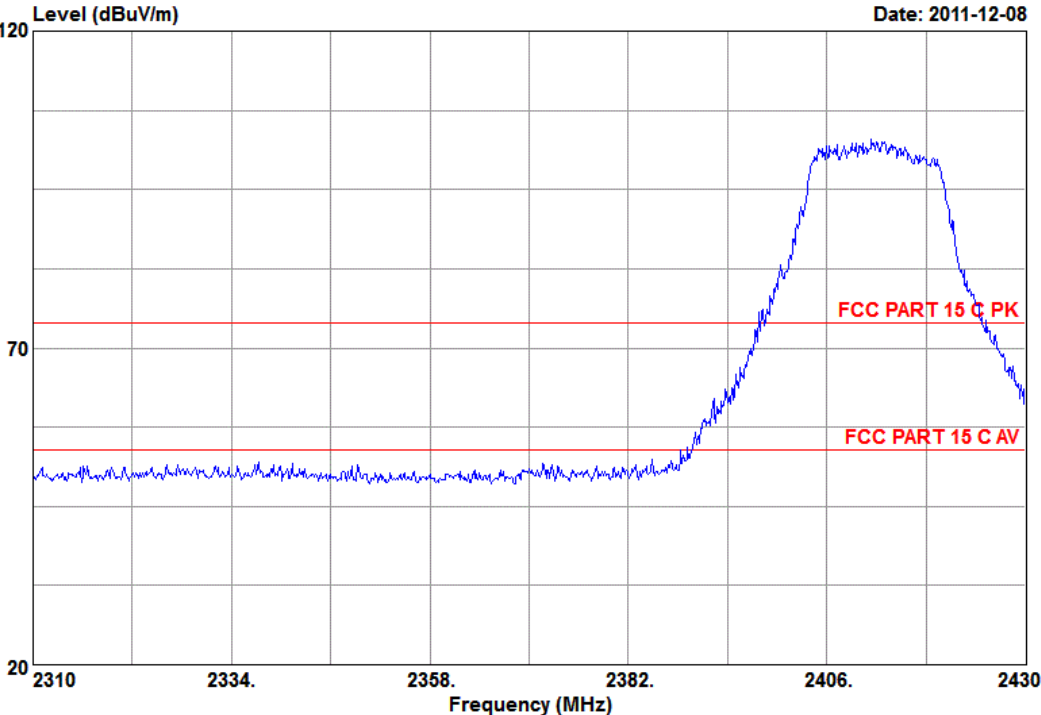

Site NO. : 3m Semi-Anechoic Chamber Data NO. : 30
 Dis. / Ant. : 3m HORN 3115(62961) Ant. pol. : VERTICAL
 Limit : FCC PART 15 C PK
 Env. / Ins. : 20.0*CS&60%/Agilent E4447A Engineer : Justin
 EUT : TI-Nspire Navigator Access Point
 M/N : TINAVAP2
 Power Rating: DC 5V Via Laptop
 Test Mode : TX CH1
 Memo : 802.11g

	Freq. (MHz)	Ant. Factor (dB/m)	Cable Loss (dB)	Reading (dBuV)	Preamp. Factor (dB)	Emission Level (dBuV/m)	Limits (dBuV/m)	Margin (dB)	Remark
1	2390.00	28.53	8.47	54.19	35.46	55.73	74.00	18.27	Peak

Remarks: 1. Emission Level= Ant.Factor + Cable Loss + Reading - Preamp.Factor.
 2. The emission levels that are 20dB below the official limit are not reported.



Audix Technology(Wujiang)Co.,Ltd.
 No.1289,Jiang Xing East Road,The Eastern Part of Wu Jiang
 Economic Development Zone,JiangSu,China
 Tel:(0512)63403993 Fax:(0512)63403993

Data: 31 File: G:\Test Data\2011\Reports\12\G1112004\G1112004.EM6 (42) Date: 2011-12-08

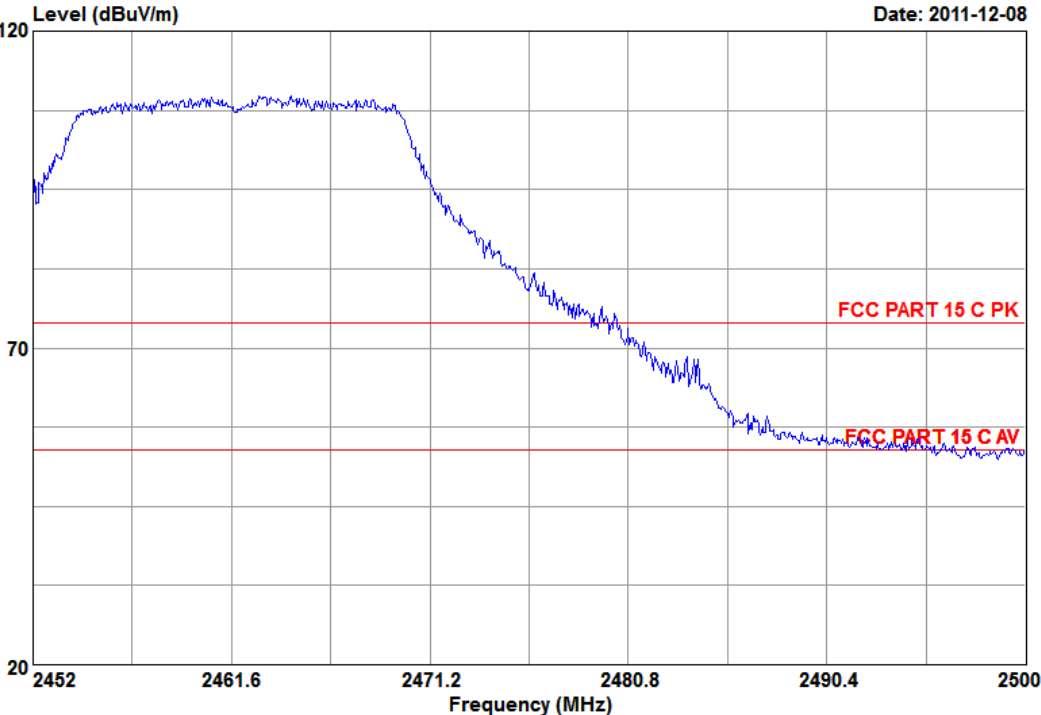

Site NO. : 3m Semi-Anechoic Chamber Data NO. : 31
 Dis. / Ant. : 3m HORN 3115(62961) Ant. pol. : HORIZONTAL
 Limit : FCC PART 15 C PK
 Env. / Ins. : 20.0*CS&60%/Agilent E4447A Engineer : Justin
 EUT : TI-Nspire Navigator Access Point
 M/N : TINAVAP2
 Power Rating: DC 5V Via Laptop
 Test Mode : TX CH11
 Memo : 802.11g

	Freq. (MHz)	Ant. Factor (dB/m)	Cable Loss (dB)	Reading (dBuV)	Preamp. Factor (dB)	Emission Level (dBuV/m)	Limits (dBuV/m)	Margin (dB)	Remark
1	2483.00	28.76	9.42	61.87	35.49	64.56	74.00	9.44	Peak

Remarks: 1. Emission Level= Ant.Factor + Cable Loss + Reading - Preamp.Factor.
 2. The emission levels that are 20dB below the official limit are not reported.



Audix Technology(Wujiang)Co.,Ltd.
 No.1289,Jiang Xing East Road,The Eastern Part of Wu Jiang
 Economic Development Zone,JiangSu,China
 Tel:(0512)63403993 Fax:(0512)63403993

Data: 32 File: G:\Test Data\2011\Reports\12\G1112004\G1112004.EM6 (42) Date: 2011-12-08

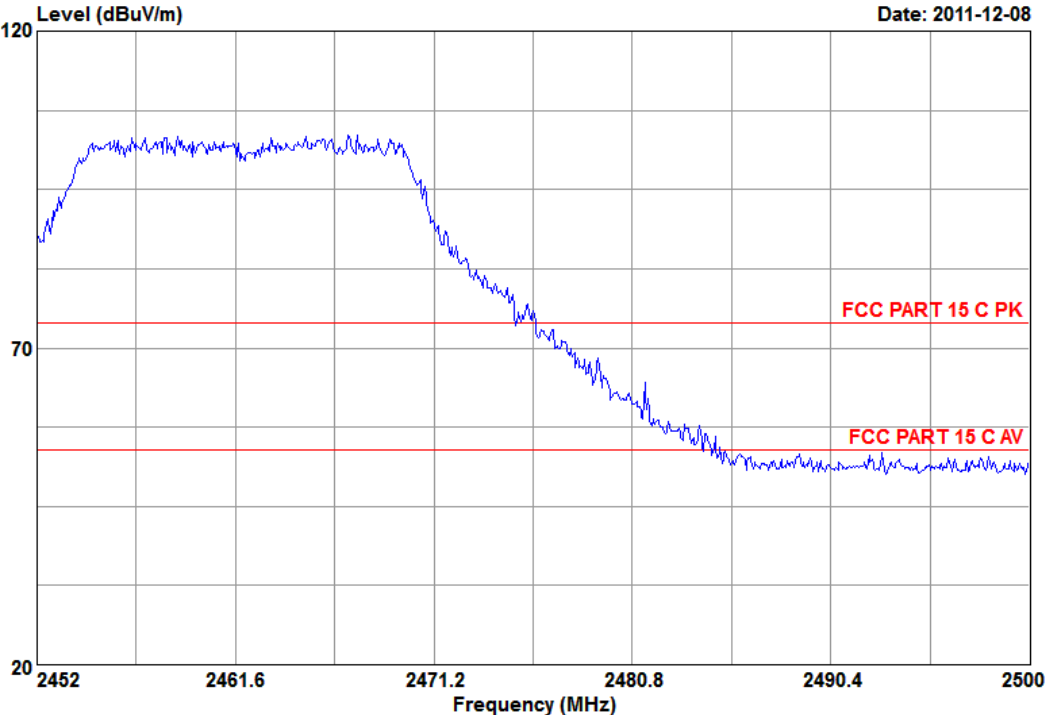

Site NO. : 3m Semi-Anechoic Chamber Data NO. : 32
 Dis. / Ant. : 3m HORN 3115(62961) Ant. pol. : VERTICAL
 Limit : FCC PART 15 C PK
 Env. / Ins. : 20.0*CS&60%/Agilent E4447A Engineer : Justin
 EUT : TI-Nspire Navigator Access Point
 M/N : TINAVAP2
 Power Rating: DC 5V Via Laptop
 Test Mode : TX CH11
 Memo : 802.11g

	Freq. (MHz)	Ant. Factor (dB/m)	Cable Loss (dB)	Reading (dBuV)	Preamp. Factor (dB)	Emission Level (dBuV/m)	Limits (dBuV/m)	Margin (dB)	Remark
1	2483.00	28.76	9.42	54.26	35.49	56.95	74.00	17.05	Peak

Remarks: 1. Emission Level= Ant.Factor + Cable Loss + Reading - Preamp.Factor.
 2. The emission levels that are 20dB below the official limit are not reported.



Audix Technology(Wujiang)Co.,Ltd.
 No.1289,Jiang Xing East Road,The Eastern Part of Wu Jiang
 Economic Development Zone,JiangSu,China
 Tel:(0512)63403993 Fax:(0512)63403993

Data: 33 File: G:\Test Data\2011\Reports\12\G1112004\G1112004.EM6 (42)

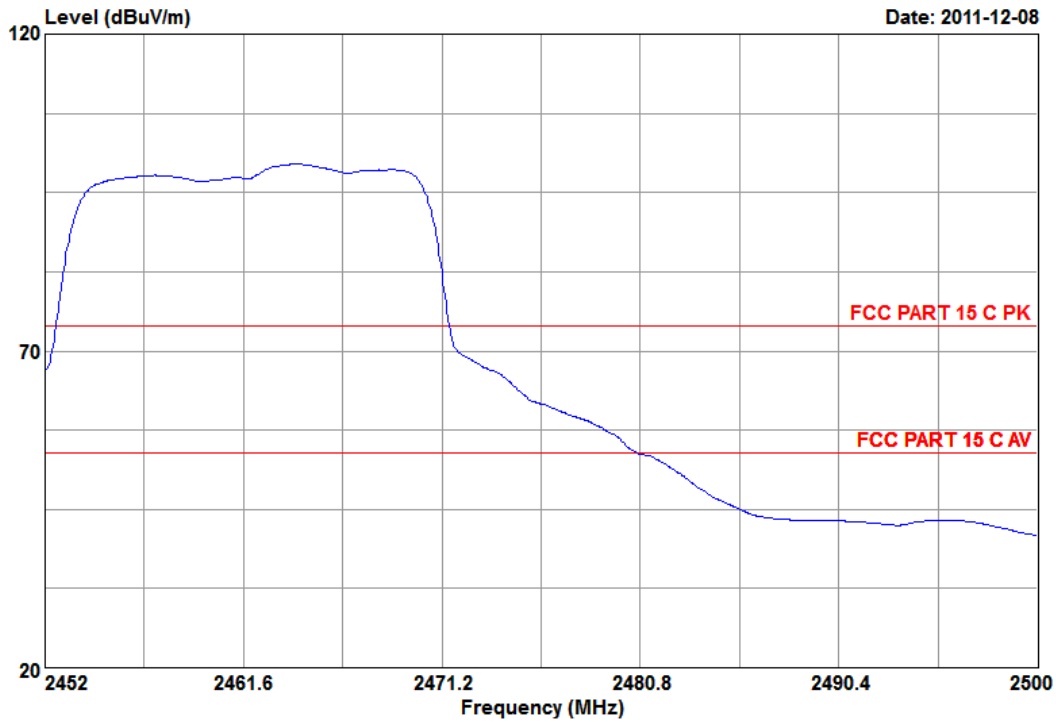

Site NO. : 3m Semi-Anechoic Chamber Data NO. : 33
 Dis. / Ant. : 3m HORN 3115(62961) Ant. pol. : HORIZONTAL
 Limit : FCC PART 15 C PK
 Env. / Ins. : 20.0*CS&60%/Agilent E4447A Engineer : Justin
 EUT : TI-Nspire Navigator Access Point
 M/N : TINAVAP2
 Power Rating: DC 5V Via Laptop
 Test Mode : TX CH11
 Memo : 802.11g

	Freq. (MHz)	Ant. Factor (dB/m)	Cable Loss (dB)	Reading (dBuV)	Preamp. Factor (dB)	Emission Level (dBuV/m)	Limits (dBuV/m)	Margin (dB)	Remark
1	2483.00	28.76	9.42	47.18	35.49	49.87	54.00	4.13	Average

Remarks: 1. Emission Level= Ant.Factor + Cable Loss + Reading - Preamp.Factor.
 2. The emission levels that are 20dB below the official limit are not reported.



Audix Technology(Wujiang)Co.,Ltd.
 No.1289,Jiang Xing East Road,The Eastern Part of Wu Jiang
 Economic Development Zone,JiangSu,China
 Tel:(0512)63403993 Fax:(0512)63403993

Data: 34 File: G:\Test Data\2011\Reports\12\G1112004\G1112004.EM6 (42)

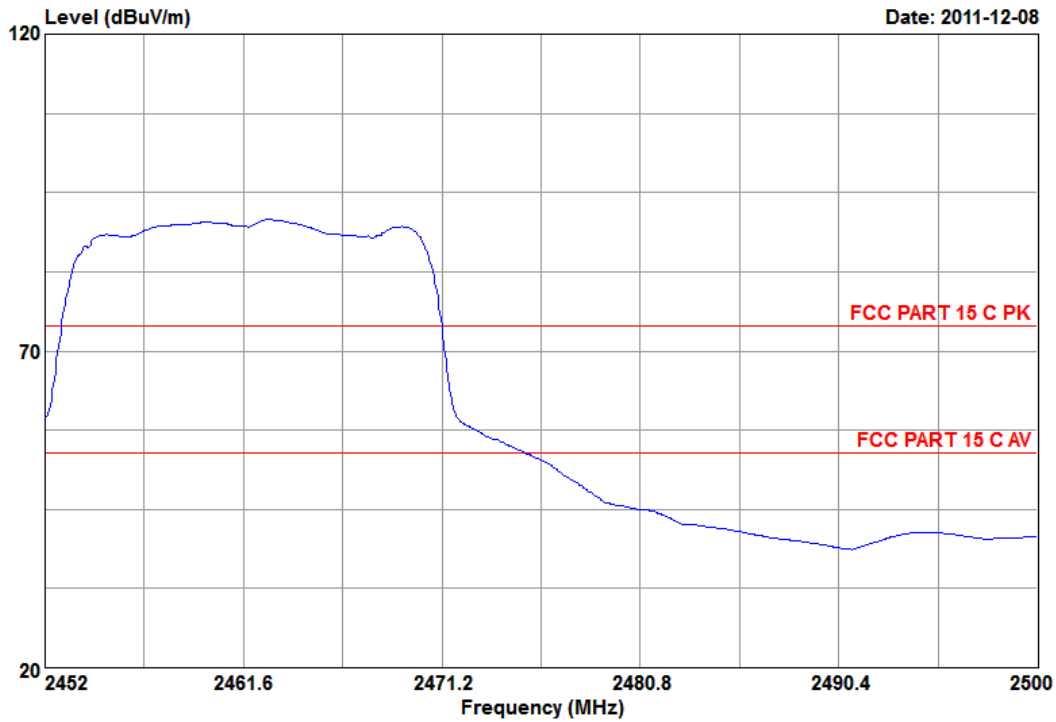

Site NO. : 3m Semi-Anechoic Chamber Data NO. : 34
 Dis. / Ant. : 3m HORN 3115(62961) Ant. pol. : VERTICAL
 Limit : FCC PART 15 C PK
 Env. / Ins. : 20.0*CS&60%/Agilent E4447A Engineer : Justin
 EUT : TI-Nspire Navigator Access Point
 M/N : TINAVAP2
 Power Rating: DC 5V Via Laptop
 Test Mode : TX CH11
 Memo : 802.11g

	Freq. (MHz)	Ant. Factor (dB/m)	Cable Loss (dB)	Reading (dBuV)	Preamp. Factor (dB)	Emission Level (dBuV/m)	Limits (dBuV/m)	Margin (dB)	Remark
1	2483.00	28.76	9.42	39.90	35.49	42.59	54.00	11.41	Average

Remarks: 1. Emission Level= Ant.Factor + Cable Loss + Reading - Preamp.Factor.
 2. The emission levels that are 20dB below the official limit are not reported.

4.7.3. IEEE 802.11n HT20



Audix Technology(Wujiang)Co.,Ltd.
 No.1289,Jiang Xing East Road,The Eastern Part of Wu Jiang
 Economic Development Zone,JiangSu,China
 Tel: (0512) 63403993 Fax: (0512) 63403993

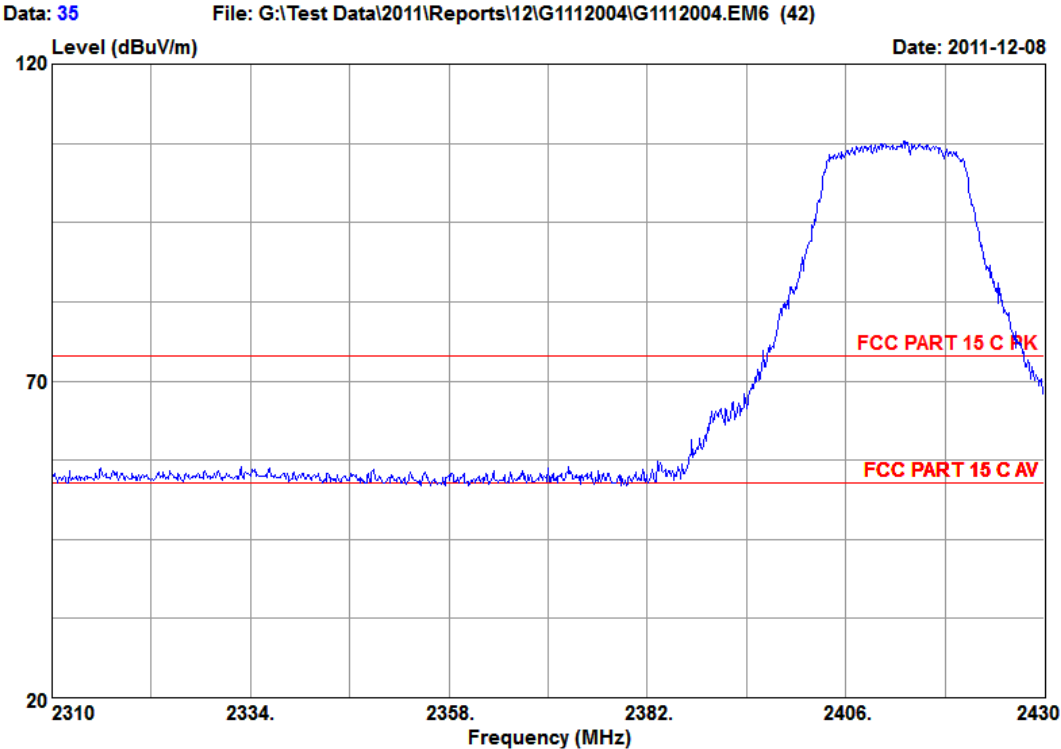

Site NO. : 3m Semi-Anechoic Chamber
 Dis. / Ant. : 3m HORN 3115(62961)
 Limit : FCC PART 15 C PK
 Env. / Ins. : 20.0*CS&60%/Agilent E4447A
 EUT : TI-Nspire Navigator Access Point
 M/N : TINAVAP2
 Power Rating: DC 5V Via Laptop
 Test Mode : TX CH1
 Memo : 802.11n HT20

Data NO. : 35
 Ant. pol. : HORIZONTAL
 Engineer : Justin

	Freq. (MHz)	Ant. Factor (dB/m)	Cable Loss (dB)	Reading (dBuV)	Preamp. Factor (dB)	Emission Level (dBuV/m)	Limits (dBuV/m)	Margin (dB)	Remark
1	2390.00	28.53	8.47	61.97	35.46	63.51	74.00	10.49	Peak

Remarks: 1. Emission Level= Ant.Factor + Cable Loss + Reading - Preamp.Factor.
 2. The emission levels that are 20dB below the official limit are not reported.



Audix Technology(Wujiang)Co.,Ltd.
 No.1289,Jiang Xing East Road,The Eastern Part of Wu Jiang
 Economic Development Zone,JiangSu,China
 Tel: (0512) 63403993 Fax: (0512) 63403993

Data: 36 File: G:\Test Data\2011\Reports\12\G1112004\G1112004.EM6 (42)

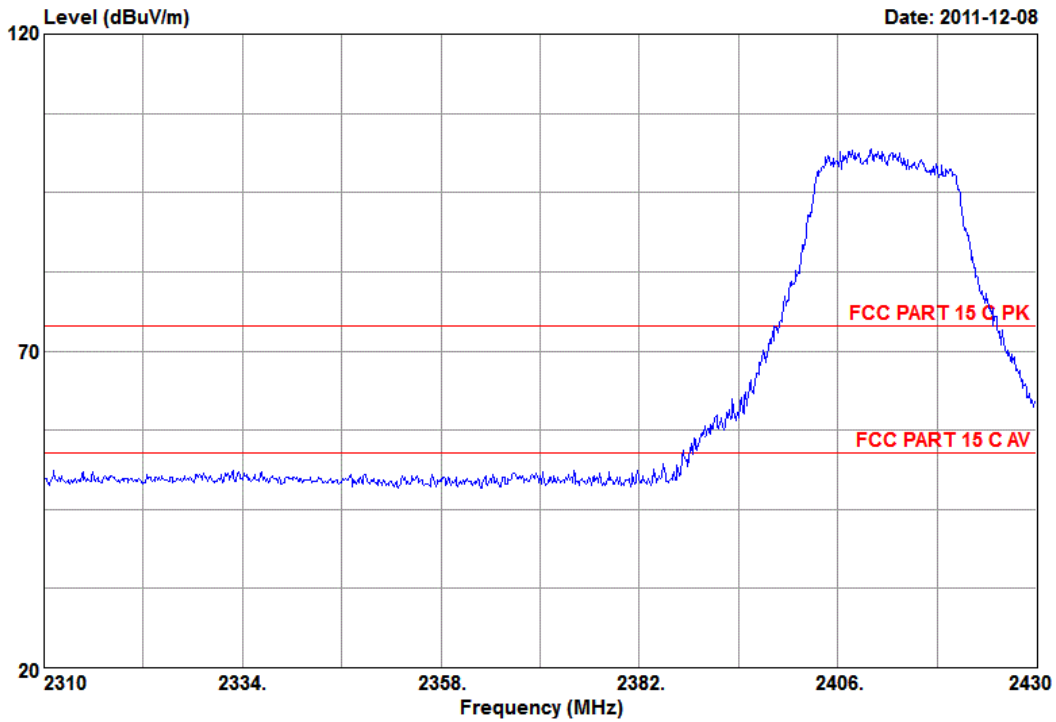

Site NO. : 3m Semi-Anechoic Chamber Data NO. : 36
 Dis. / Ant. : 3m HORN 3115(62961) Ant. pol. : VERTICAL
 Limit : FCC PART 15 C PK
 Env. / Ins. : 20.0*CS&60%/Agilent E4447A Engineer : Justin
 EUT : TI-Nspire Navigator Access Point
 M/N : TINAVAP2
 Power Rating: DC 5V Via Laptop
 Test Mode : TX CH1
 Memo : 802.11n HT20

	Freq. (MHz)	Ant. Factor (dB/m)	Cable Loss (dB)	Reading (dBuV)	Preamp. Factor (dB)	Emission Level (dBuV/m)	Limits (dBuV/m)	Margin (dB)	Remark
1	2390.00	28.53	8.47	54.87	35.46	56.41	74.00	17.59	Peak

Remarks: 1. Emission Level= Ant.Factor + Cable Loss + Reading - Preamp.Factor.
 2. The emission levels that are 20dB below the official limit are not reported.



Audix Technology(Wujiang)Co.,Ltd.
 No.1289,Jiang Xing East Road,The Eastern Part of Wu Jiang
 Economic Development Zone,JiangSu,China
 Tel: (0512) 63403993 Fax: (0512) 63403993

Data: 37 File: G:\Test Data\2011\Reports\12\G1112004\G1112004.EM6 (42)

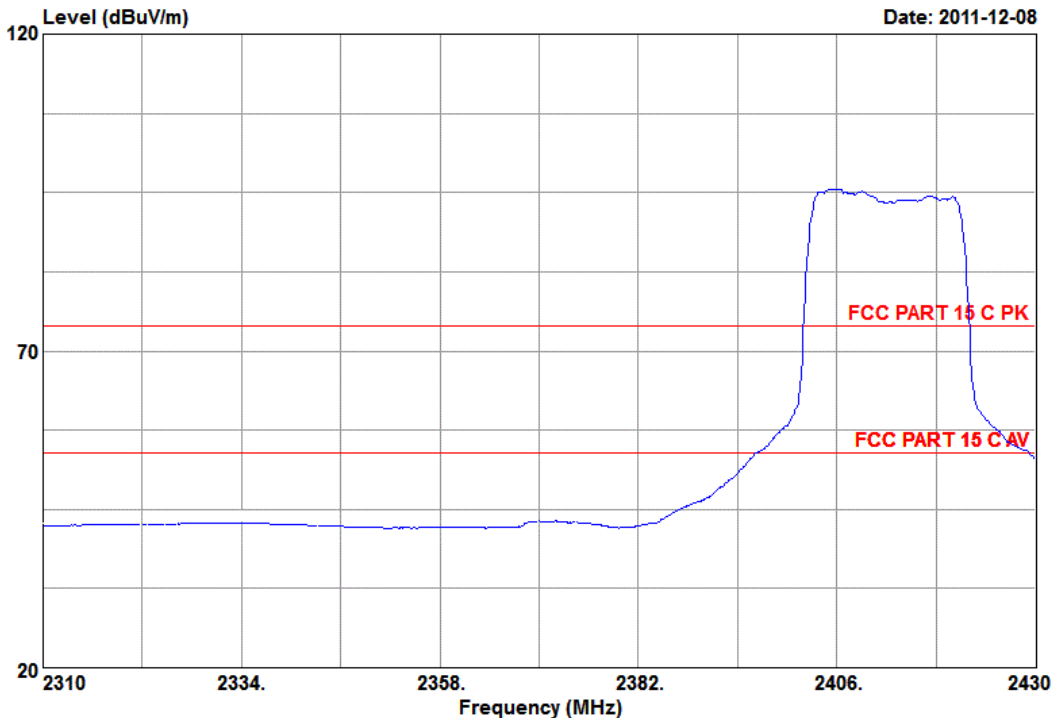

Site NO. : 3m Semi-Anechoic Chamber Data NO. : 37
 Dis. / Ant. : 3m HORN 3115(62961) Ant. pol. : HORIZONTAL
 Limit : FCC PART 15 C PK
 Env. / Ins. : 20.0*CS&60%/Agilent E4447A Engineer : Justin
 EUT : TI-Nspire Navigator Access Point
 M/N : TINAVAP2
 Power Rating: DC 5V Via Laptop
 Test Mode : TX CH1
 Memo : 802.11n HT20

	Freq. (MHz)	Ant. Factor (dB/m)	Cable Loss (dB)	Reading (dBuV)	Preamp. Factor (dB)	Emission Level (dBuV/m)	Limits (dBuV/m)	Margin (dB)	Remark
1	2390.00	28.53	8.47	45.02	35.46	46.56	54.00	7.44	Average

Remarks: 1. Emission Level= Ant.Factor + Cable Loss + Reading - Preamp.Factor.
 2. The emission levels that are 20dB below the official limit are not reported.



Audix Technology(Wujiang)Co.,Ltd.
 No.1289,Jiang Xing East Road,The Eastern Part of Wu Jiang
 Economic Development Zone,JiangSu,China
 Tel: (0512) 63403993 Fax: (0512) 63403993

Data: 38 File: G:\Test Data\2011\Reports\12\G1112004\G1112004.EM6 (42)

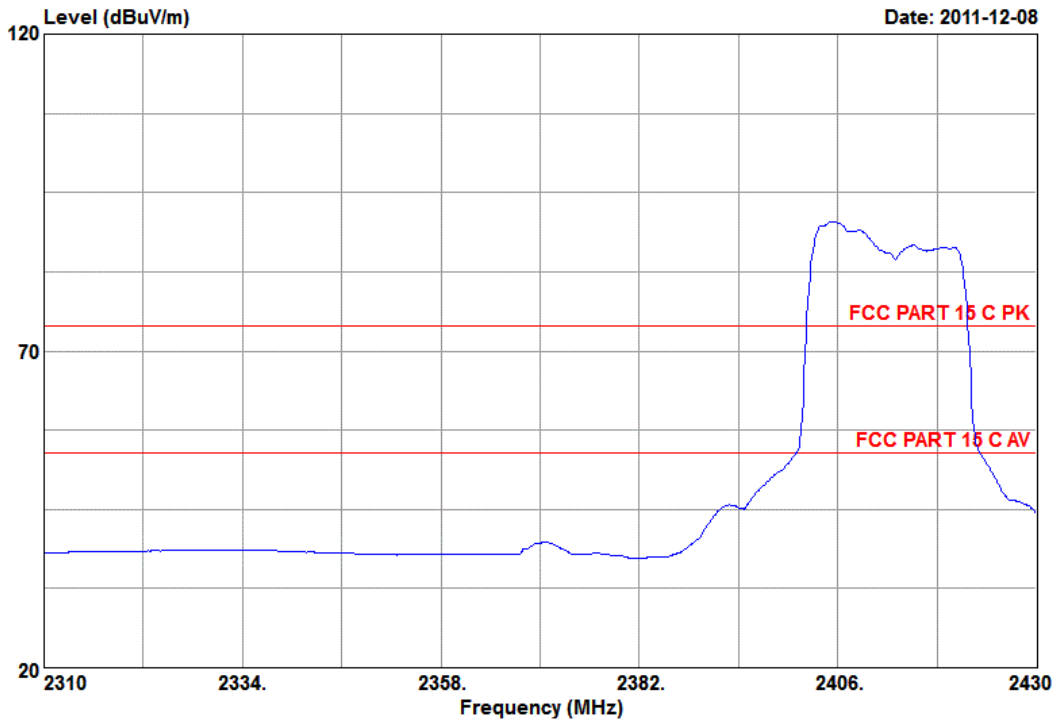

Site NO. : 3m Semi-Anechoic Chamber Data NO. : 38
 Dis. / Ant. : 3m HORN 3115(62961) Ant. pol. : VERTICAL
 Limit : FCC PART 15 C PK
 Env. / Ins. : 20.0*CS&60%/Agilent E4447A Engineer : Justin
 EUT : TI-Nspire Navigator Access Point
 M/N : TINAVAP2
 Power Rating: DC 5V Via Laptop
 Test Mode : TX CH1
 Memo : 802.11n HT20

	Freq. (MHz)	Ant. Factor (dB/m)	Cable Loss (dB)	Reading (dBuV)	Preamp. Factor (dB)	Emission Level (dBuV/m)	Limits (dBuV/m)	Margin (dB)	Remark
1	2390.00	28.53	8.47	40.48	35.46	42.02	54.00	11.98	Average

Remarks: 1. Emission Level= Ant.Factor + Cable Loss + Reading - Preamp.Factor.
 2. The emission levels that are 20dB below the official limit are not reported.



Audix Technology(Wujiang)Co.,Ltd.
 No.1289,Jiang Xing East Road,The Eastern Part of Wu Jiang
 Economic Development Zone,JiangSu,China
 Tel: (0512) 63403993 Fax: (0512) 63403993

Data: 39 File: G:\Test Data\2011\Reports\12\G1112004\G1112004.EM6 (42)

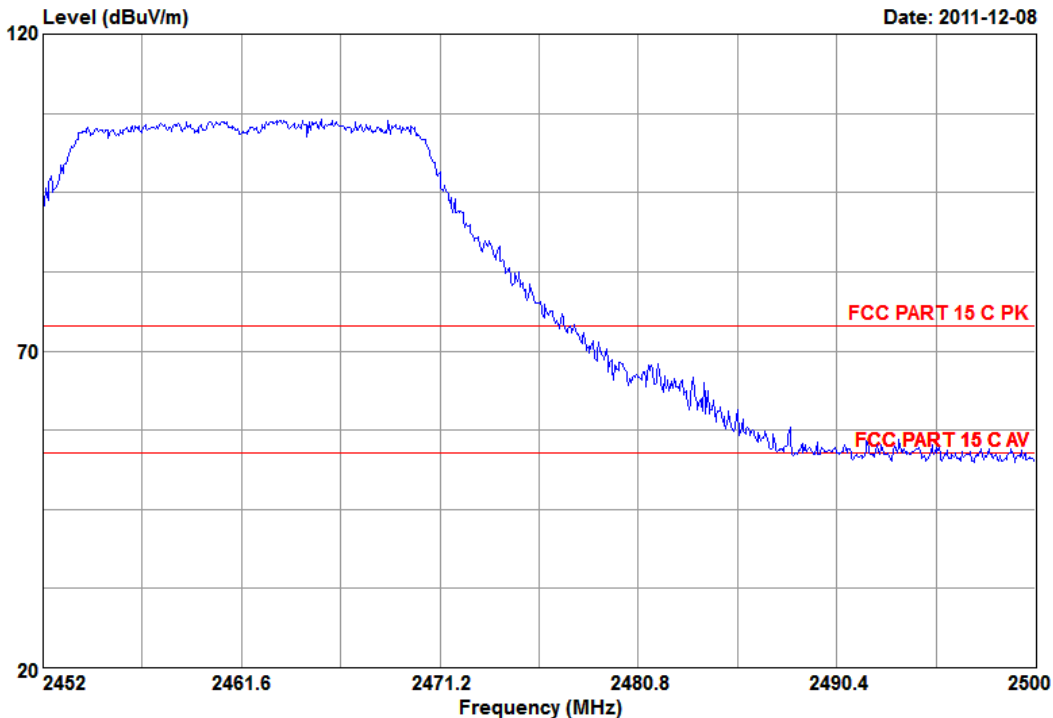

Site NO. : 3m Semi-Anechoic Chamber Data NO. : 39
 Dis. / Ant. : 3m HORN 3115(62961) Ant. pol. : HORIZONTAL
 Limit : FCC PART 15 C PK
 Env. / Ins. : 20.0*CS&60%/Agilent E4447A Engineer : Justin
 EUT : TI-Nspire Navigator Access Point
 M/N : TINAVAP2
 Power Rating: DC 5V Via Laptop
 Test Mode : TX CH11
 Memo : 802.11n HT20

	Freq. (MHz)	Ant. Factor (dB/m)	Cable Loss (dB)	Reading (dBuV)	Preamp. Factor (dB)	Emission Level (dBuV/m)	Limits (dBuV/m)	Margin (dB)	Remark
1	2483.00	28.76	9.42	60.39	35.49	63.08	74.00	10.92	Peak

Remarks: 1. Emission Level= Ant.Factor + Cable Loss + Reading - Preamp.Factor.
 2. The emission levels that are 20dB below the official limit are not reported.



Audix Technology(Wujiang)Co.,Ltd.
 No.1289,Jiang Xing East Road,The Eastern Part of Wu Jiang
 Economic Development Zone,JiangSu,China
 Tel: (0512) 63403993 Fax: (0512) 63403993

Data: 40 File: G:\Test Data\2011\Reports\12\G1112004\G1112004.EM6 (42)

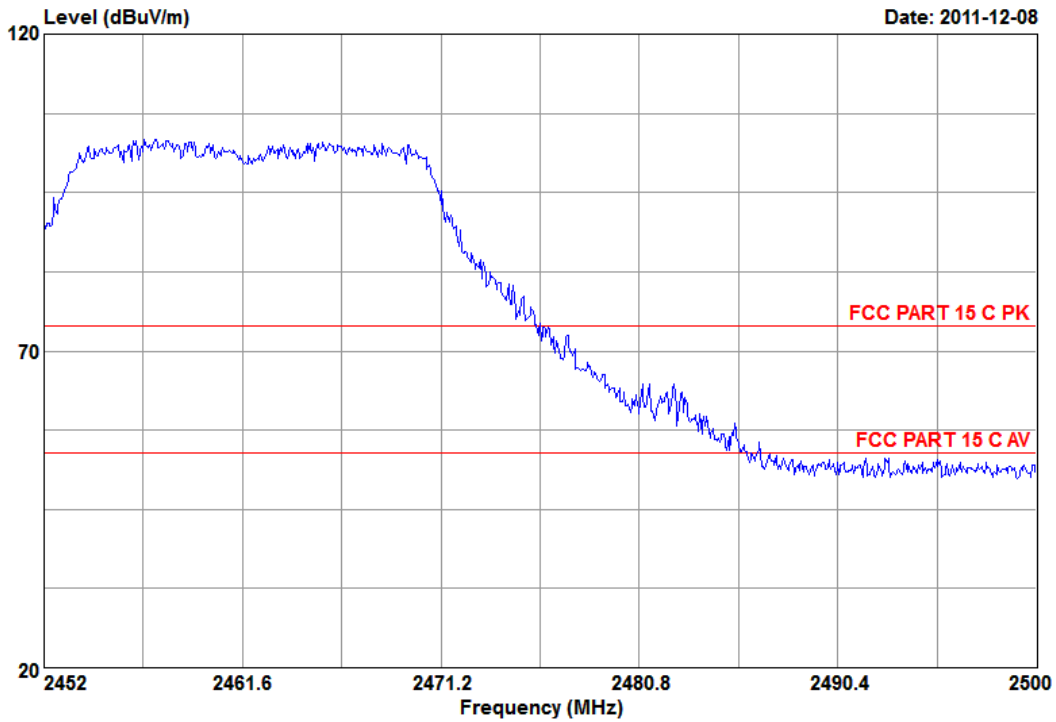

Site NO. : 3m Semi-Anechoic Chamber Data NO. : 40
 Dis. / Ant. : 3m HORN 3115(62961) Ant. pol. : VERTICAL
 Limit : FCC PART 15 C PK
 Env. / Ins. : 20.0*CS&60%/Agilent E4447A Engineer : Justin
 EUT : TI-Nspire Navigator Access Point
 M/N : TINAVAP2
 Power Rating: DC 5V Via Laptop
 Test Mode : TX CH11
 Memo : 802.11n HT20

	Freq. (MHz)	Ant. Factor (dB/m)	Cable Loss (dB)	Reading (dBuV)	Preamp. Factor (dB)	Emission Level (dBuV/m)	Limits (dBuV/m)	Margin (dB)	Remark
1	2483.00	28.76	9.42	60.04	35.49	62.73	74.00	11.27	Peak

Remarks: 1. Emission Level= Ant.Factor + Cable Loss + Reading - Preamp.Factor.
 2. The emission levels that are 20dB below the official limit are not reported.



Audix Technology(Wujiang)Co.,Ltd.
 No.1289,Jiang Xing East Road,The Eastern Part of Wu Jiang
 Economic Development Zone,JiangSu,China
 Tel: (0512) 63403993 Fax: (0512) 63403993

Data: 41 File: G:\Test Data\2011\Reports\12\G1112004\G1112004.EM6 (42)

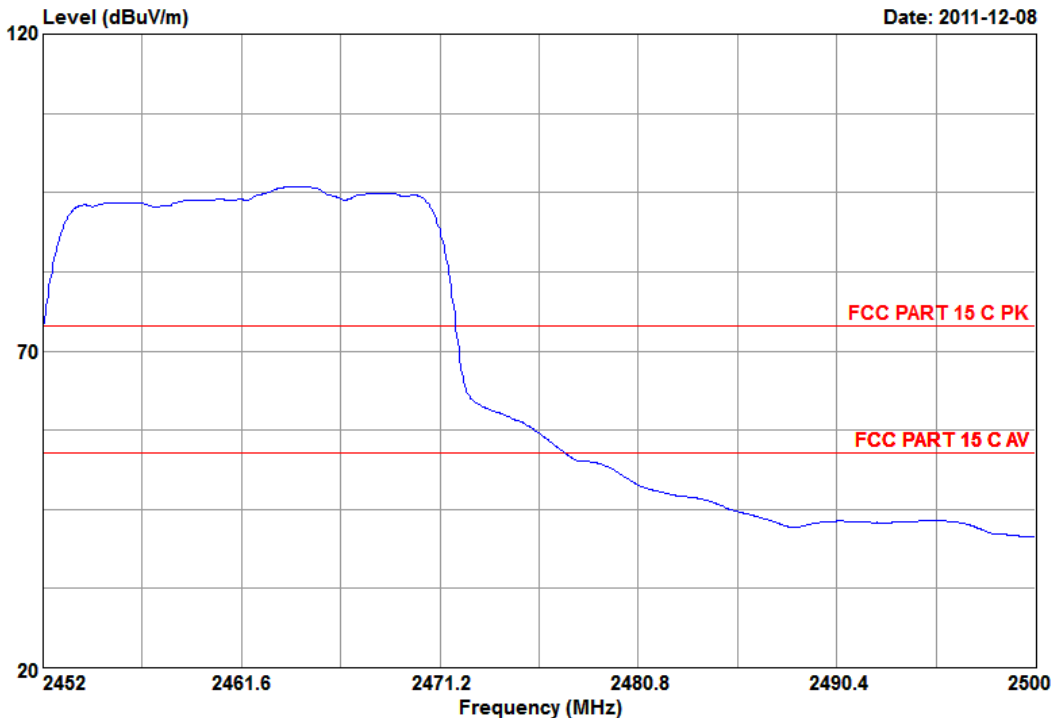

Site NO. : 3m Semi-Anechoic Chamber Data NO. : 41
 Dis. / Ant. : 3m HORN 3115(62961) Ant. pol. : HORIZONTAL
 Limit : FCC PART 15 C PK
 Env. / Ins. : 20.0*CS&60%/Agilent E4447A Engineer : Justin
 EUT : TI-Nspire Navigator Access Point
 M/N : TINAVAP2
 Power Rating: DC 5V Via Laptop
 Test Mode : TX CH11
 Memo : 802.11n HT20

	Freq. (MHz)	Ant. Factor (dB/m)	Cable Loss (dB)	Reading (dBuV)	Preamp. Factor (dB)	Emission Level (dBuV/m)	Limits (dBuV/m)	Margin (dB)	Remark
1	2483.00	28.76	9.42	44.36	35.49	47.05	54.00	6.95	Average

Remarks: 1. Emission Level= Ant.Factor + Cable Loss + Reading - Preamp.Factor.
 2. The emission levels that are 20dB below the official limit are not reported.



Audix Technology(Wujiang)Co.,Ltd.
 No.1289,Jiang Xing East Road,The Eastern Part of Wu Jiang
 Economic Development Zone,JiangSu,China
 Tel: (0512) 63403993 Fax: (0512) 63403993

Data: 42 File: G:\Test Data\2011\Reports\12\G1112004\G1112004.EM6 (42)

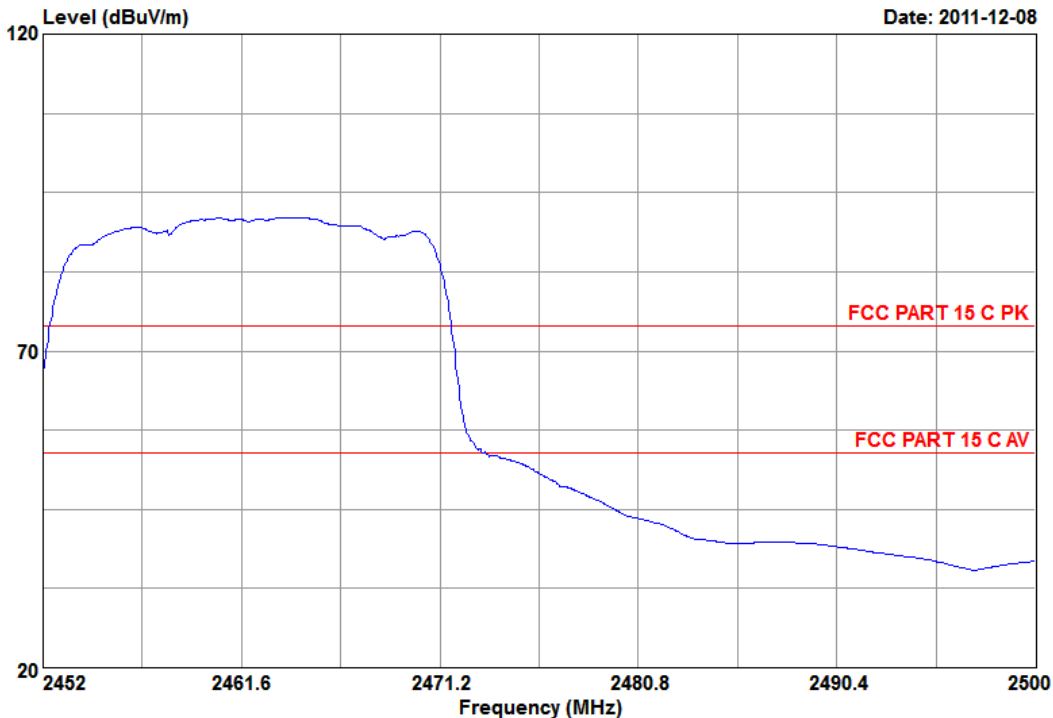

Site NO. : 3m Semi-Anechoic Chamber Data NO. : 42
 Dis. / Ant. : 3m HORN 3115(62961) Ant. pol. : VERTICAL
 Limit : FCC PART 15 C PK
 Env. / Ins. : 20.0*CS&60%/Agilent E4447A Engineer : Justin
 EUT : TI-Nspire Navigator Access Point
 M/N : TINAVAP2
 Power Rating: DC 5V Via Laptop
 Test Mode : TX CH11
 Memo : 802.11n HT20

	Freq. (MHz)	Ant. Factor (dB/m)	Cable Loss (dB)	Reading (dBuV)	Preamp. Factor (dB)	Emission Level (dBuV/m)	Limits (dBuV/m)	Margin (dB)	Remark
1	2483.00	28.76	9.42	38.24	35.49	40.93	54.00	13.07	Average

Remarks: 1. Emission Level= Ant.Factor + Cable Loss + Reading - Preamp.Factor.
 2. The emission levels that are 20dB below the official limit are not reported.

5. 6 dB BANDWIDTH MEASUREMENT

5.1. Test Equipment

Item	Type	Manufacturer	Model No.	Serial No.	Last Cal.	Next Cal.
1.	Spectrum Analyzer	Agilent	E4447A	MY45300136	2010-12-30	2011-12-29

5.2. Block Diagram of Test Setup

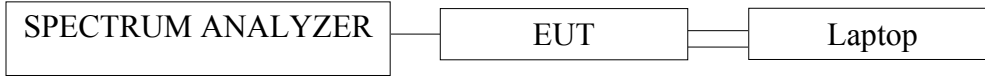

— : SIGNAL LINE

5.3. Specification Limits (§15.247(a)(2))

Systems using digital modulation techniques may operate in the 902 - 928 MHz, 2400 - 2483.5 MHz, and 5725 - 5850 MHz bands. The minimum 6 dB bandwidth shall be at least 500kHz.

5.4. Test Results

PASSED. All the test results are attached in next pages.

Test Date: Dec.10, 2011 Temperature: 19.1 °C Humidity: 58 %

Item	Channel	Test Frequency	6dB Bandwidth
802.11b	1	2412MHz	12.25 MHz
	6	2437MHz	12.25 MHz
	11	2462MHz	12.25 MHz
802.11g	1	2412MHz	16.50MHz
	6	2437MHz	16.50MHz
	11	2462MHz	16.50MHz
802.11n HT20	1	2412MHz	17.50MHz
	6	2437MHz	17.75MHz
	11	2462MHz	17.75MHz

5.4.1. 802.11b

CH 1

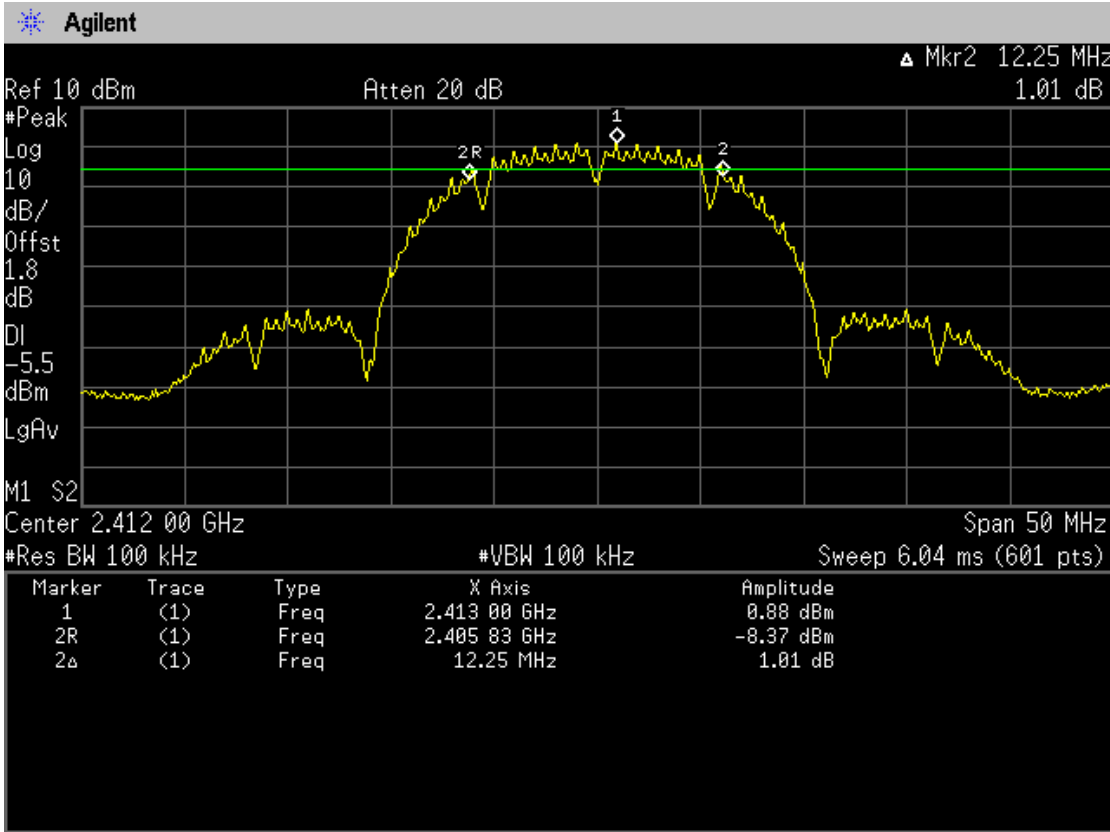

CH 6

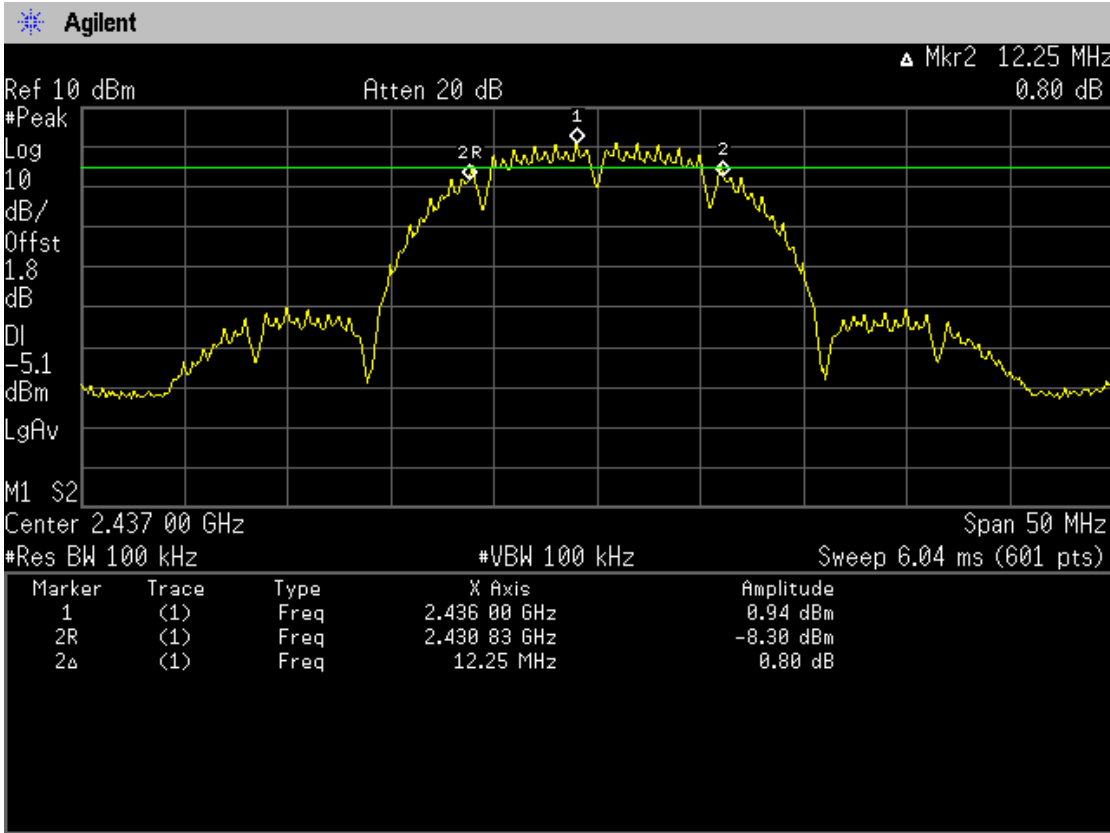

CH 11

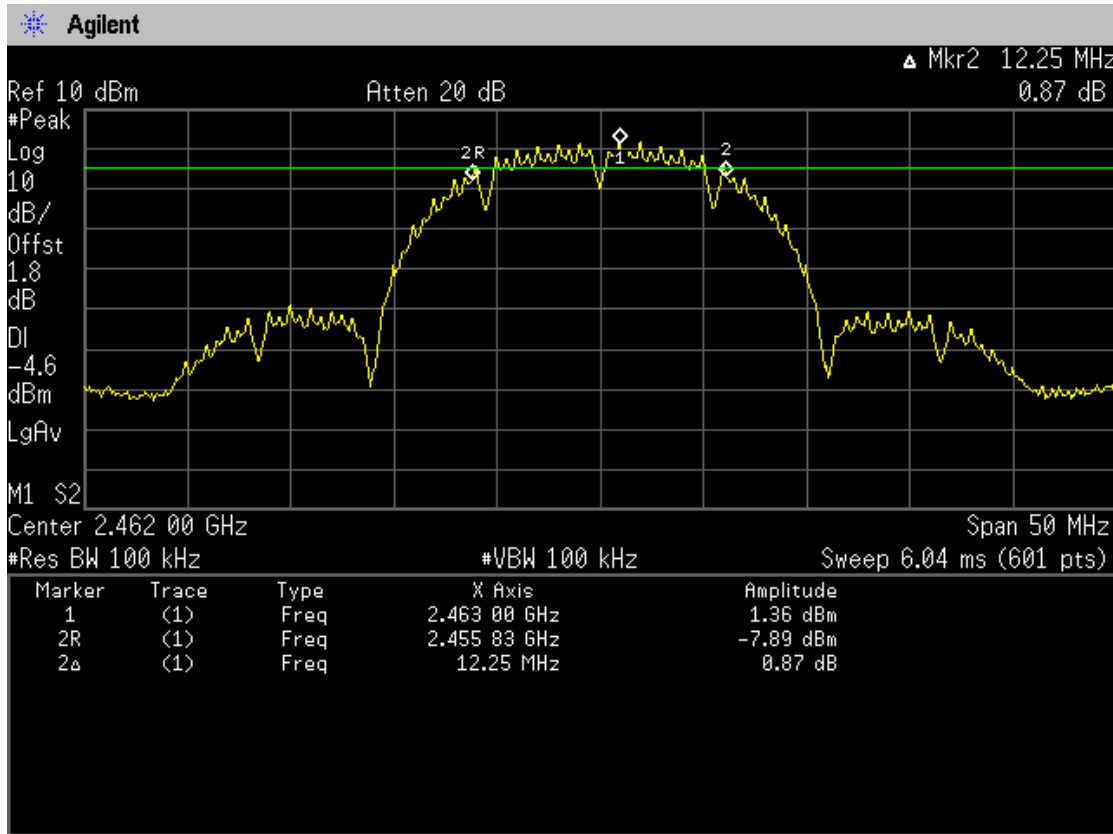

5.4.2. 802.11g

CH 1

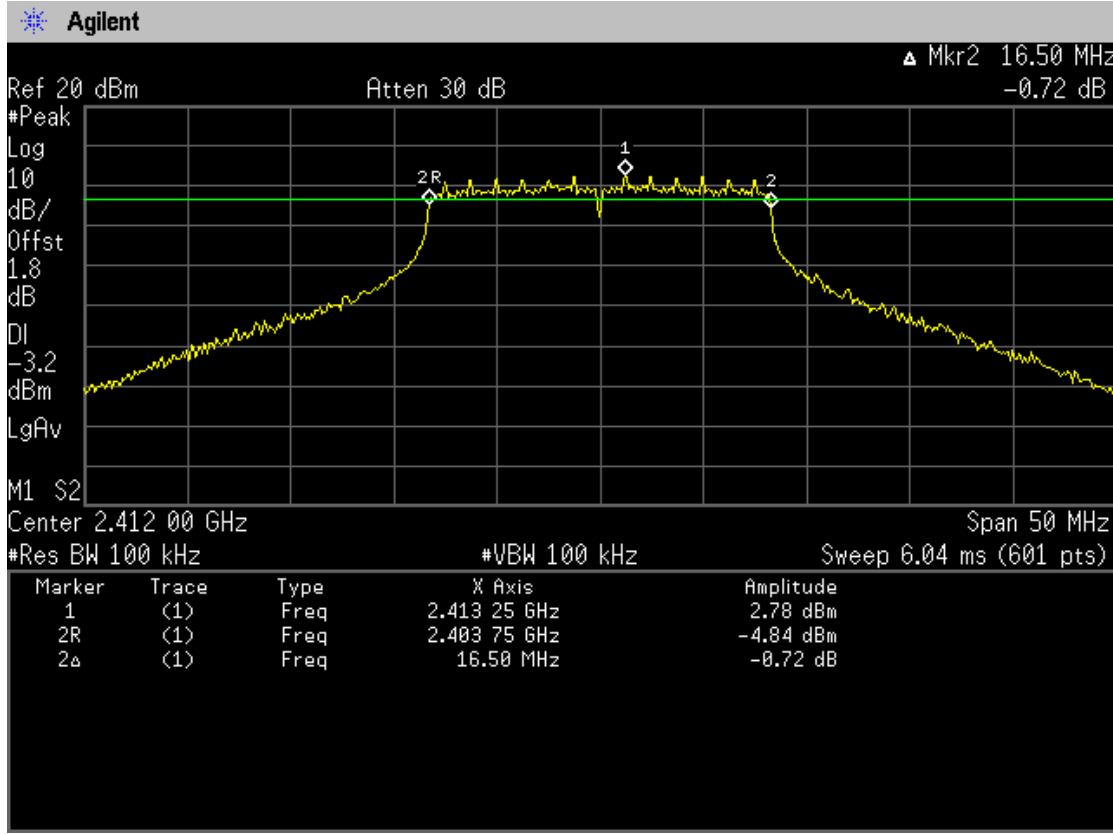

CH 6

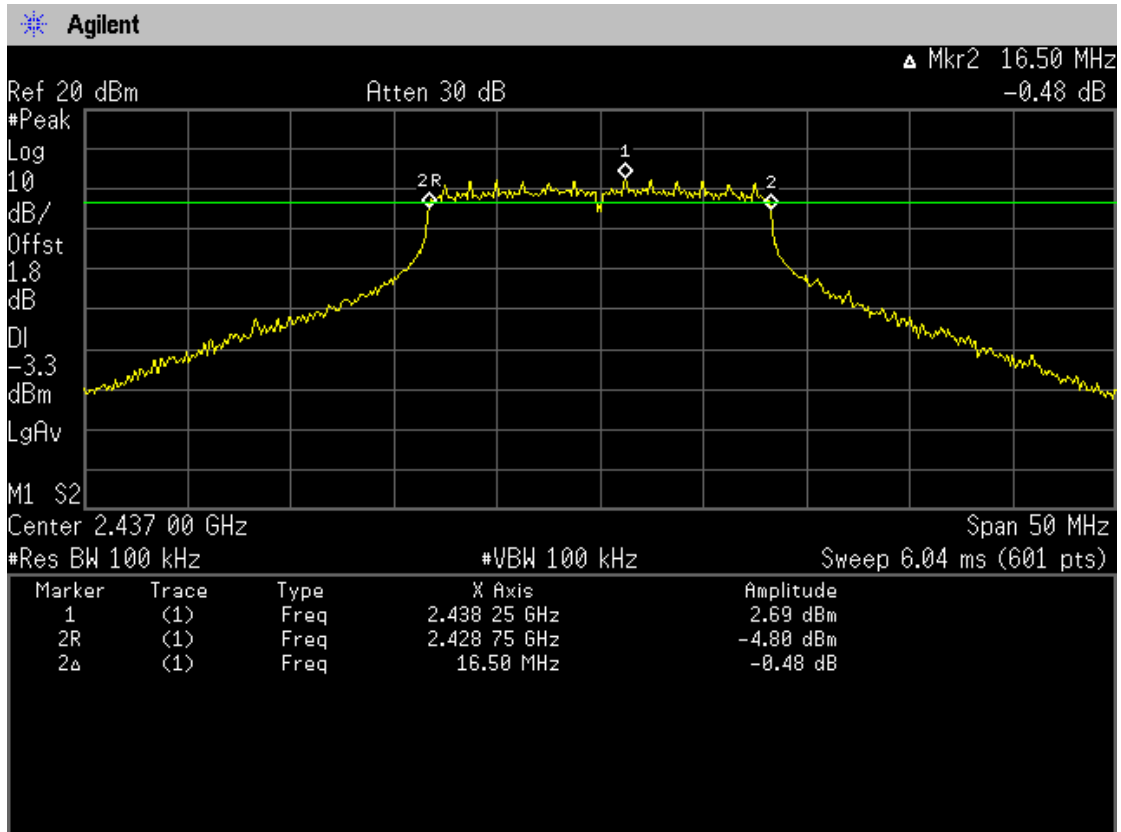

CH 11

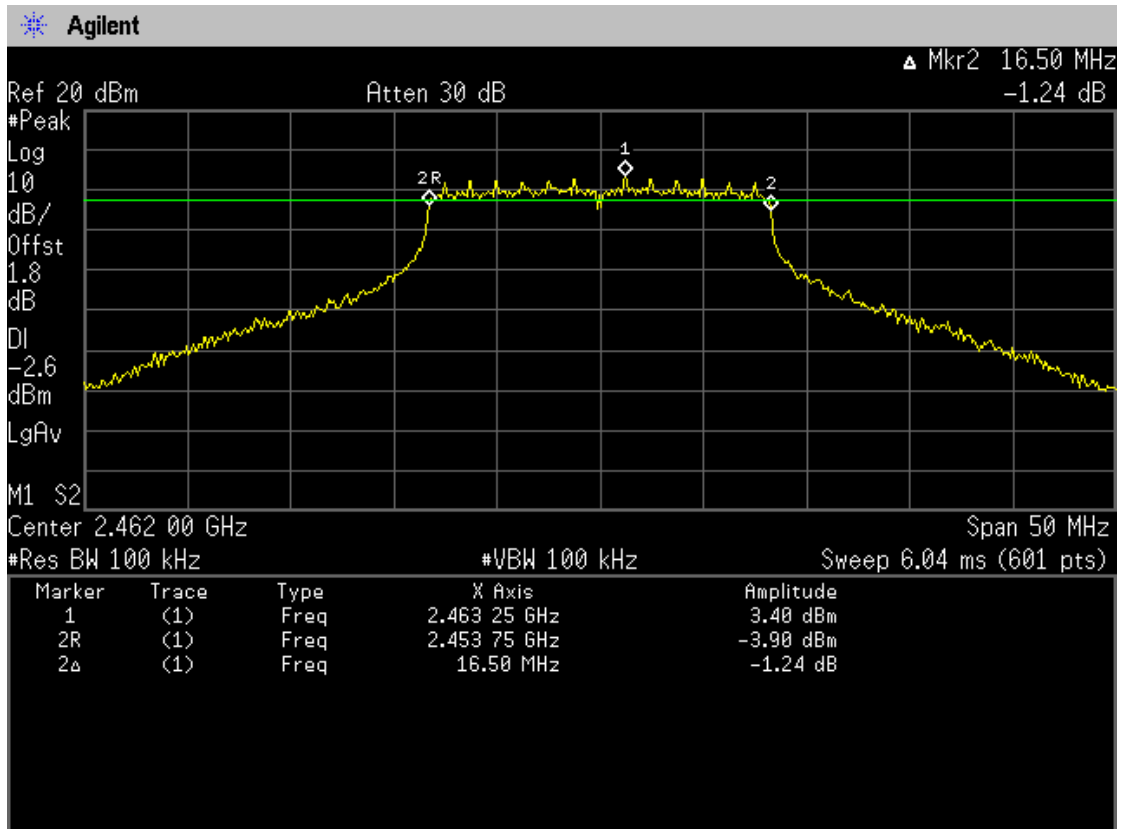

5.4.3. 802.11n HT20

CH1

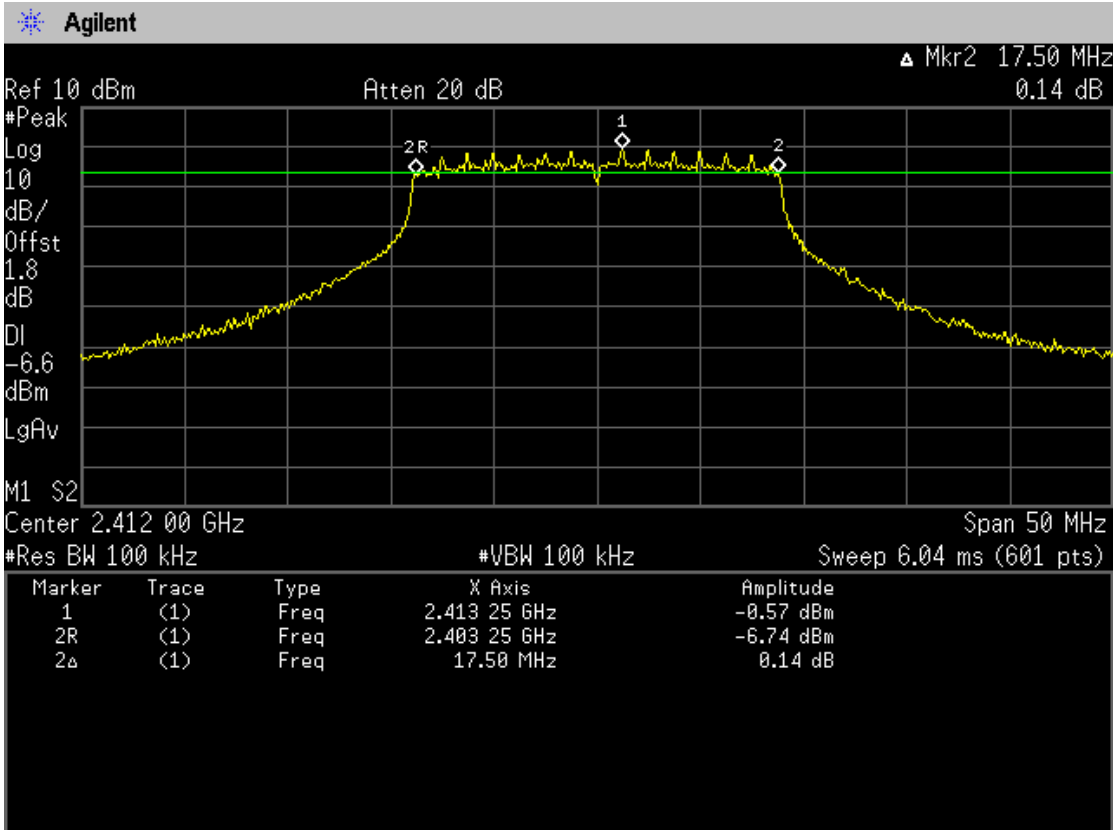

CH 6

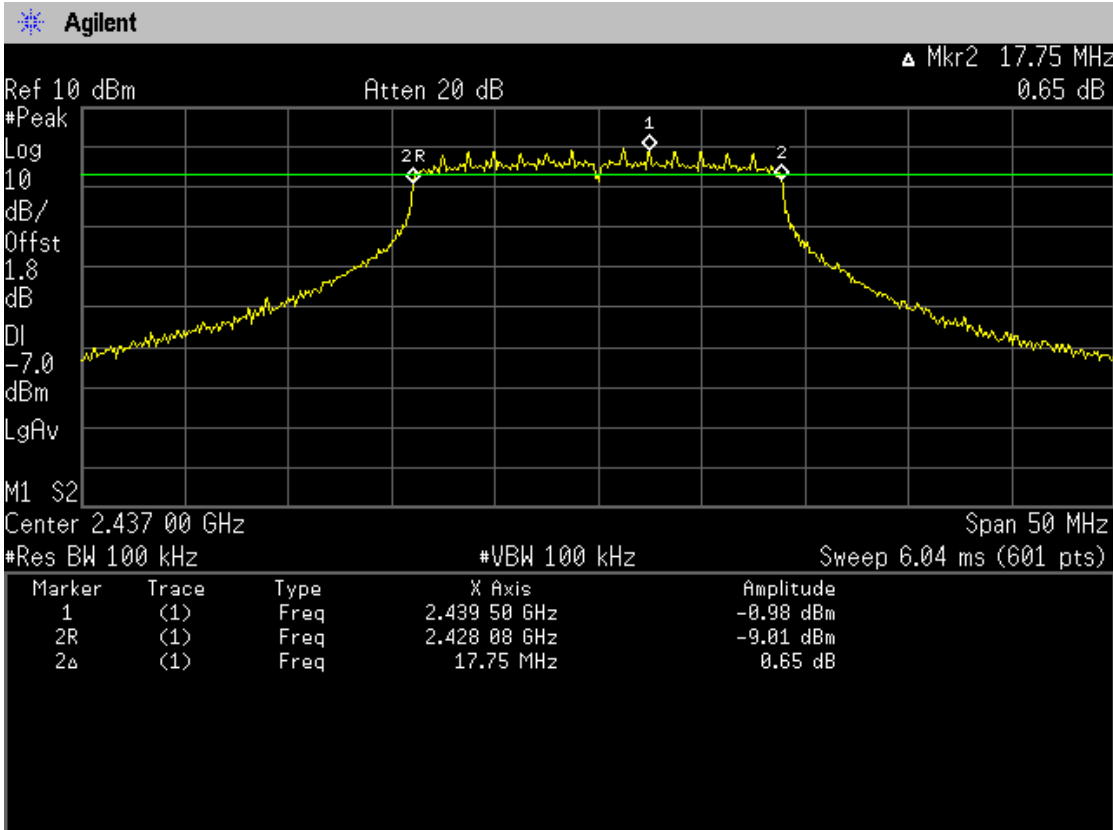

CH 11

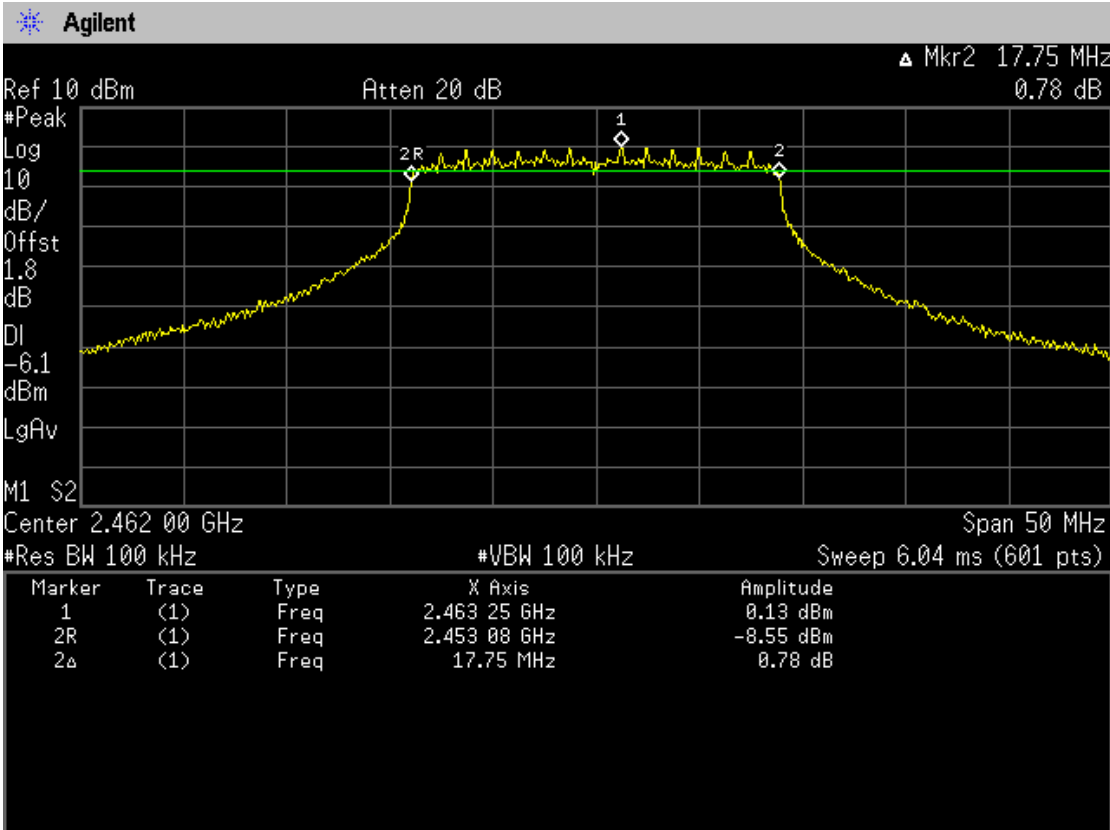

6. MAXIMUM PEAK OUTPUT POWER MEASUREMENT

6.1. Test Equipment

Item	Type	Manufacturer	Model No.	Serial No.	Last Cal.	Next Cal.
1.	Power Meter	Agilent	N1911A	MY45100361	2010-12-30	2011-12-29
2.	Power Sensor	Agilent	N1921A	MY45240521	2011-01-05	2012-01-04

6.2. Block Diagram of Test Setup



— : SIGNAL LINE

6.3. Specification Limits (§15.247(b)(3))

For systems using digital modulation in the 902-928 MHz, 2400-2483.5 MHz, and 5725-5850 MHz bands: 1 Watt. As an alternative to a peak power measurement, compliance with the one Watt limit can be based on a measurement of the maximum conducted output power. Maximum Conducted Output Power is defined as the total transmit power delivered to all antennas and antenna elements averaged across all symbols in the signaling alphabet when the transmitter is operating at its maximum power control level. Power must be summed across all antennas and antenna elements. The average must not include any time intervals during which the transmitter is off or is transmitting at a reduced power level. If multiple modes of operation are possible (e.g., alternative modulation methods), the *maximum conducted output power* is the highest total transmit power occurring in any mode.

6.4. Test Results

PASSED. All the test results are attached in next pages.

Test Date: Dec.10, 2010 Test Mode: 802.11b

Test Condition			Peak Power (dBm)		
Temperature (*C)	Voltage (V)	Data rate (Mbps)	CH 1 2412 MHz	CH 6 2437 MHz	CH 11 2462 MHz
19.1	5	1	12.98	13.23	13.51
19.1	5	2	12.90	13.06	13.50
19.1	5	5.5	12.88	13.14	13.47
19.1	5	11	12.93	13.19	13.36

Test Date: Dec.10, 2010 Test Mode: 802.11g

Test Condition			Peak Power (dBm)		
Temperature (*C)	Voltage (V)	Data rate (Mbps)	CH 1 2412 MHz	CH 6 2437 MHz	CH 11 2462 MHz
19.1	5	6	22.76	22.93	23.23
19.1	5	9	22.28	22.36	22.69
19.1	5	12	22.72	22.91	23.17
19.1	5	18	22.39	22.59	22.79
19.1	5	24	22.68	22.79	23.17
19.1	5	36	22.54	22.77	22.81
19.1	5	48	22.26	22.19	22.78
19.1	5	54	22.03	22.33	22.39

Test Date: Dec.10, 2010 Test Mode: 802.11n HT20

Test Condition			Peak Power (dBm)		
Temperature (*C)	Voltage (V)	Data rate (Mbps)	CH 1 2412 MHz	CH 6 2437 MHz	CH 11 2462 MHz
19.1	5	MCS0	20.23	20.46	20.80
19.1	5	MCS1	20.17	20.33	20.19
19.1	5	MCS2	19.89	20.43	20.45
19.1	5	MCS3	19.84	20.03	20.28
19.1	5	MCS4	20.03	20.37	20.36
19.1	5	MCS5	19.85	20.06	20.11
19.1	5	MCS6	20.21	20.08	20.18
19.1	5	MCS7	19.65	20.03	20.14

7. BAND EDGES MEASUREMENT

7.1. Test Equipment

Item	Type	Manufacturer	Model No.	Serial No.	Last Cal.	Next Cal.
1.	Spectrum Analyzer	Agilent	E4447A	MY45300136	2010-12-30	2011-12-29

7.2. Block Diagram of Test Setup

The same as section 5.2.

7.3. Specification Limits (§15.247(d))

In any 100 kHz bandwidth outside the frequency band in which the spread spectrum or digitally modulated intentional radiator is operating, the radio frequency power that is produced by the intentional radiator shall be at least 20 dB below that in the 100 kHz bandwidth within the band that contains the highest level of the desired power, based on either an RF conducted or a radiated measurement, provided the transmitter demonstrates compliance with the peak conducted power limits. If the transmitter complies with the conducted power limits based on the use of RMS averaging over a time interval, as permitted under paragraph (b)(3) of this section, the attenuation required under this paragraph shall be 30 dB instead of 20 dB. Attenuation below the general limits specified in Section 15.209(a) is not required. In addition, radiated emissions which fall in the restricted bands, as defined in Section 15.205(a), must also comply with the radiated emission limits specified in Section 15.209(a) (see Section 15.205(c)).

7.4. Test Results

PASSED. The testing data was attached in the next pages.

7.4.1. 802.11b

CH1

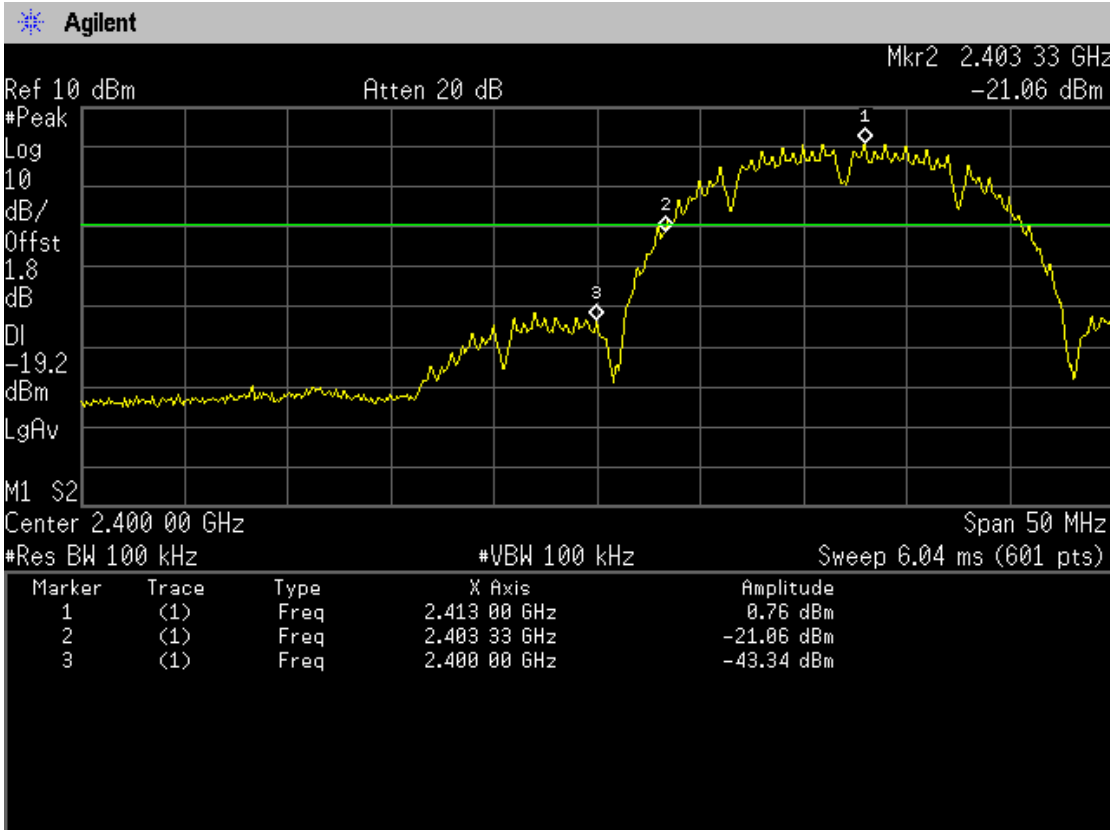

CH11

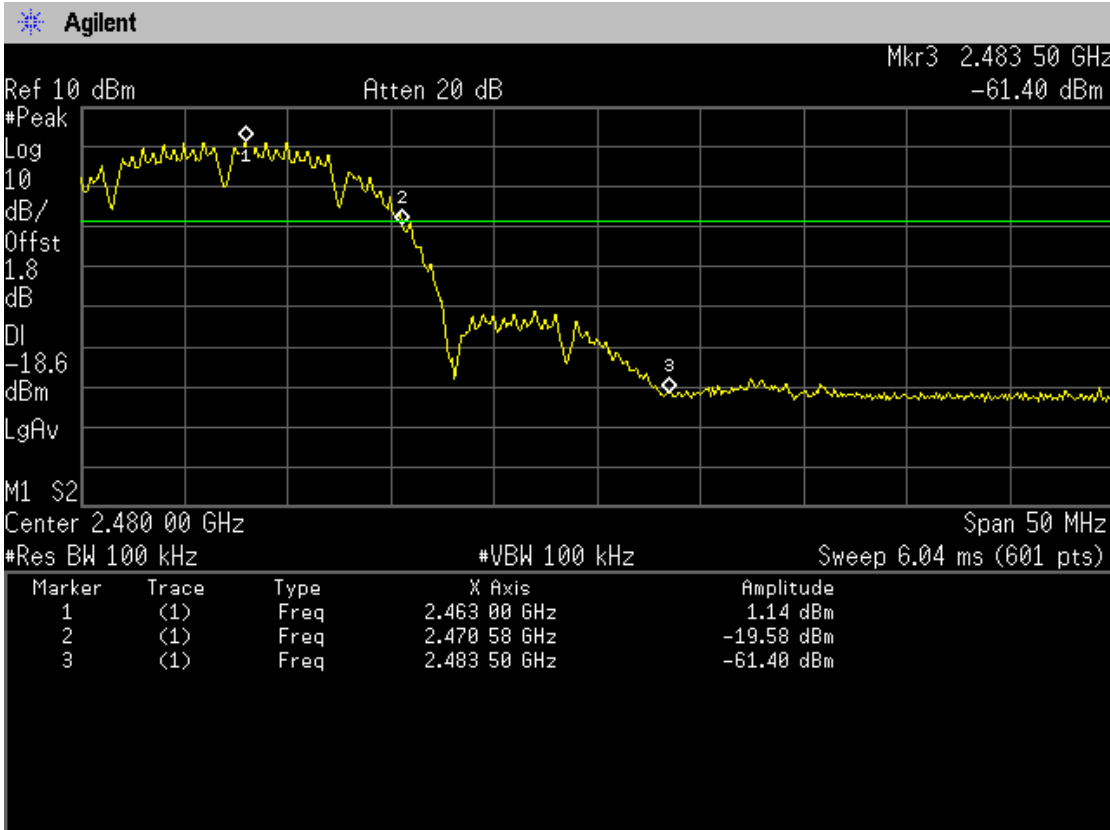

7.4.2. 802.11g

CH1

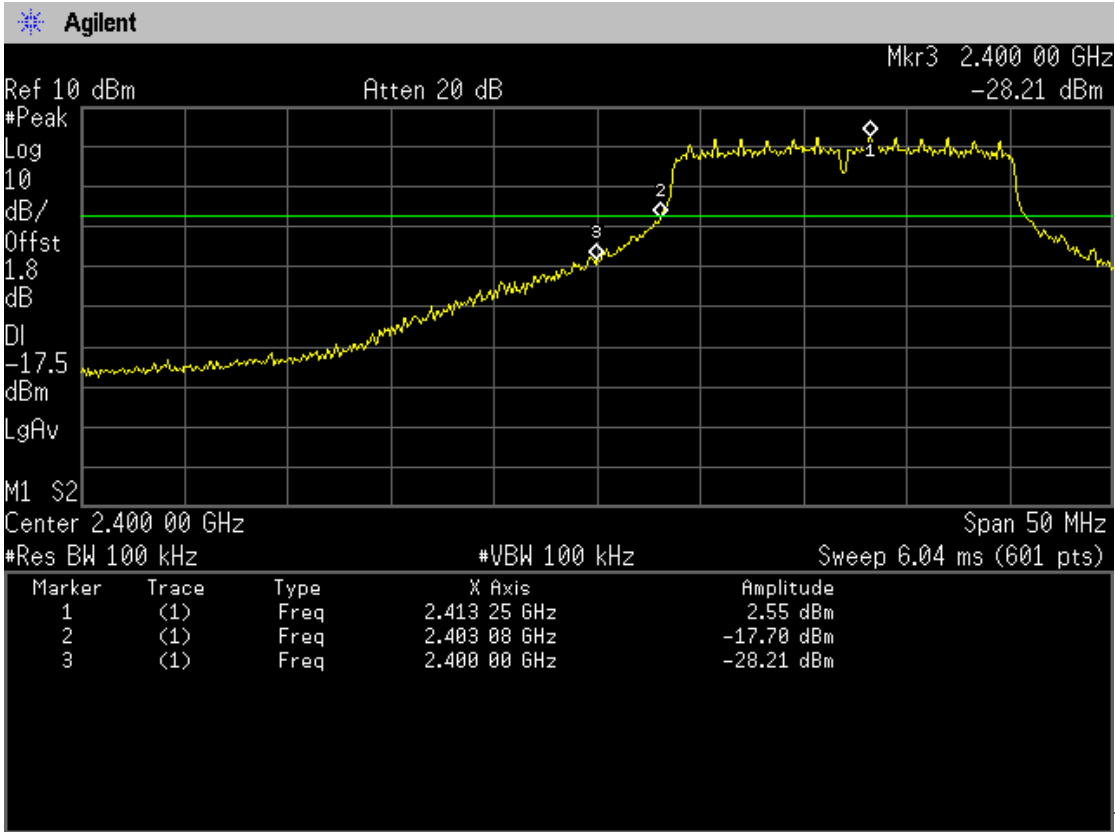

CH11

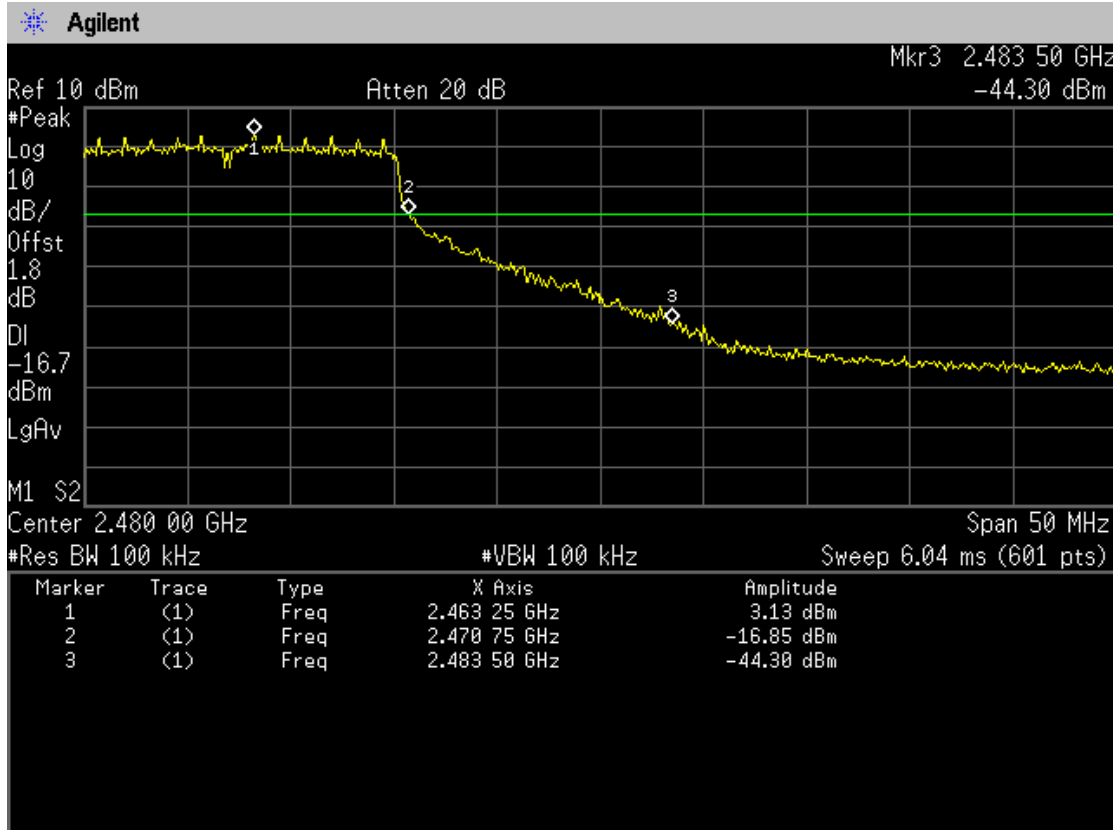

7.4.3. 802.11n HT20

CH1

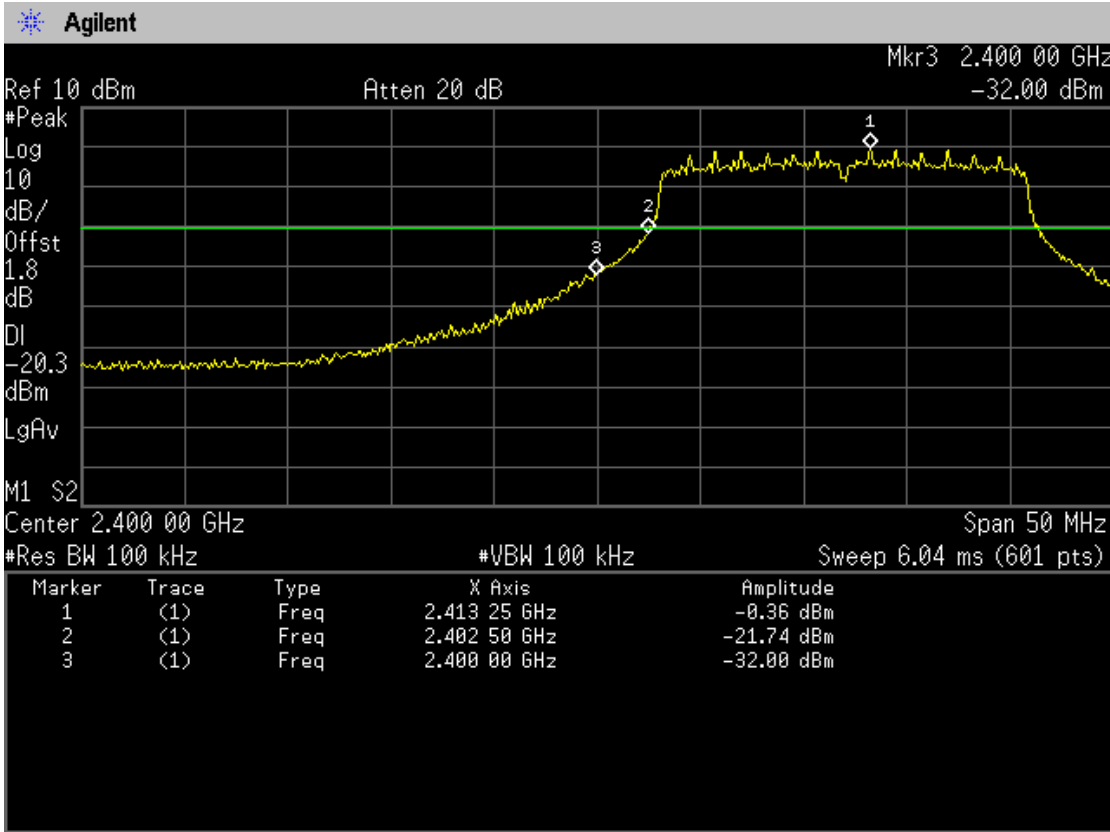

CH11

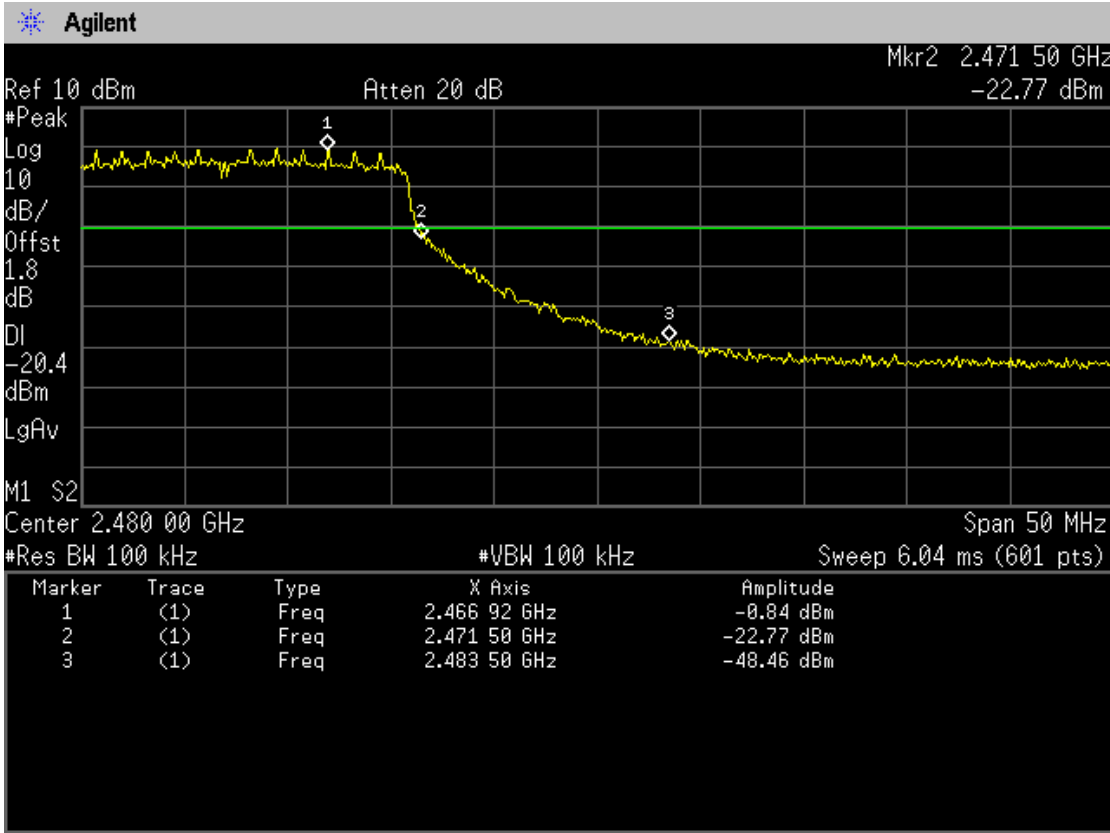

8. POWER SPECTRAL DENSITY MEASUREMENT

8.1. Test Equipment

Item	Type	Manufacturer	Model No.	Serial No.	Last Cal.	Next Cal.
1.	Spectrum Analyzer	Agilent	E4447A	MY45300136	2010-12-30	2011-12-29

8.2. Block Diagram of Test Setup

The same as section 5.2.

8.3. Specification Limits (§15.247(e))

For digitally modulated systems, the power spectral density conducted from the intentional radiator to the antenna shall not be greater than 8 dBm in any 3 kHz band during any time interval of continuous transmission.

8.4. Test Results

PASSED. All the test results are attached in next page.

Test Date: Dec.10 Temperature: 19.1 °C Humidity: 58 %

Item	Channel	Frequency(GHz)	Value(dBm)
802.11b	1	2.4129734	-13.81
	6	2.4339618	-14.59
	11	2.4629629	-13.34
802.11g	1	2.4132390	-11.30
	6	2.4382621	-11.64
	11	2.4644519	-10.70
802.11n HT20	1	2.41325650	-13.81
	6	2.4382580	-13.66
	11	2.4632570	-13.08

8.4.1. 802.11b

CH 1

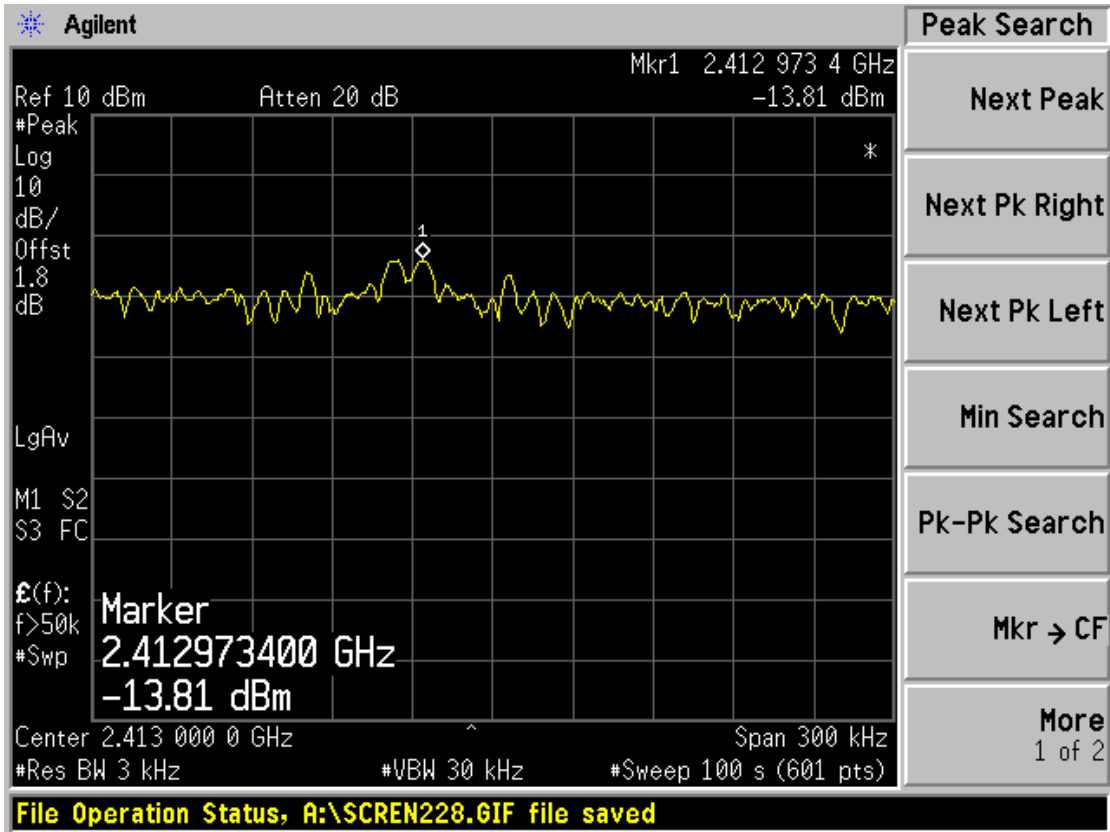

CH 6

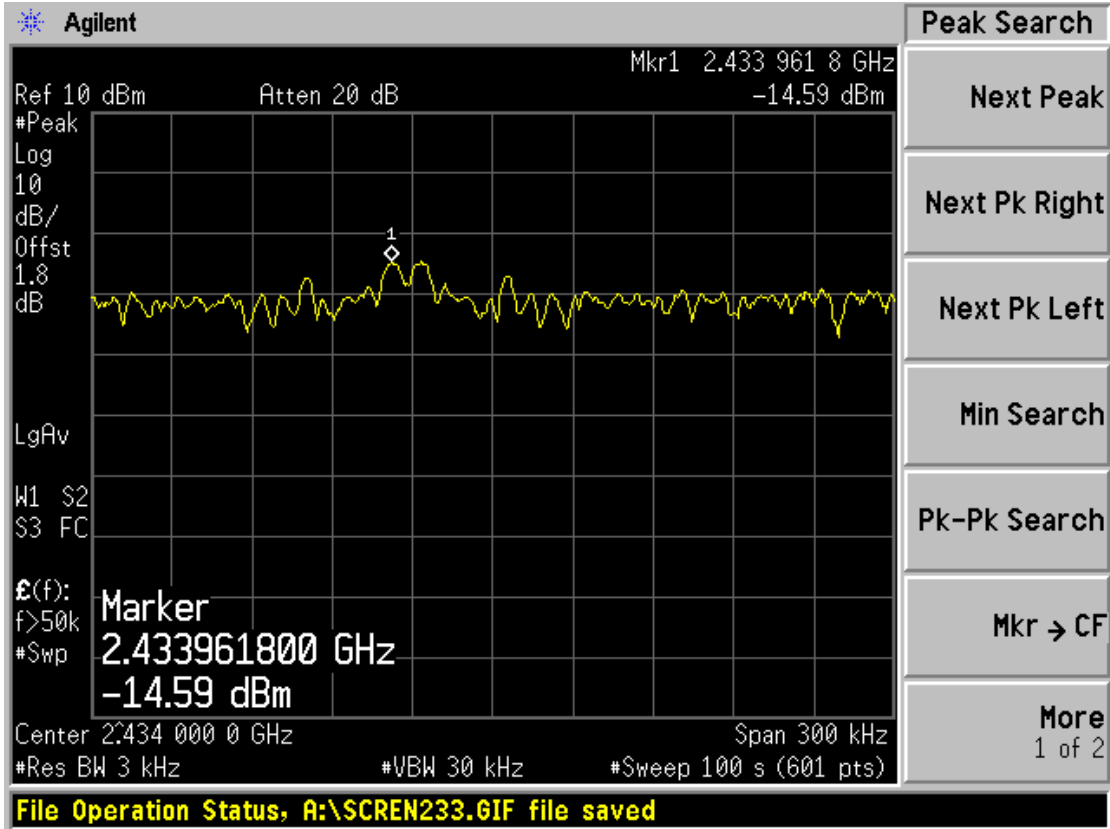

CH 11

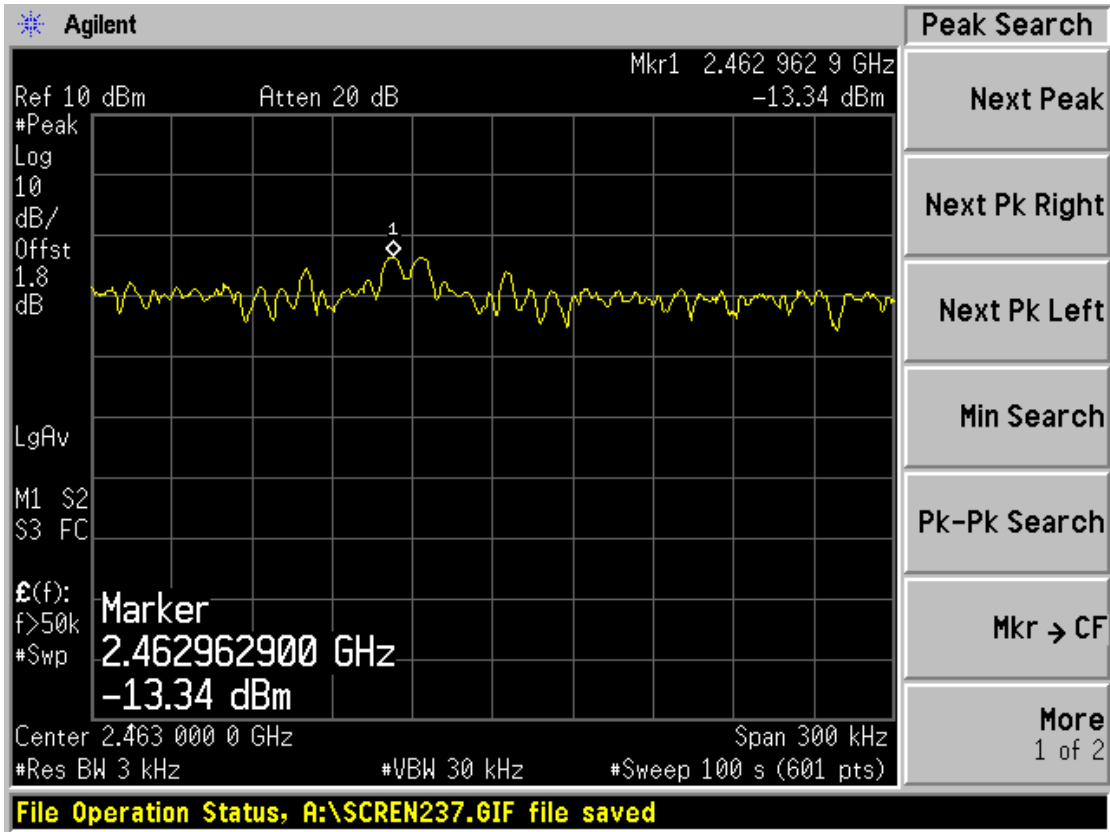

8.4.2. 802.11g

CH 1

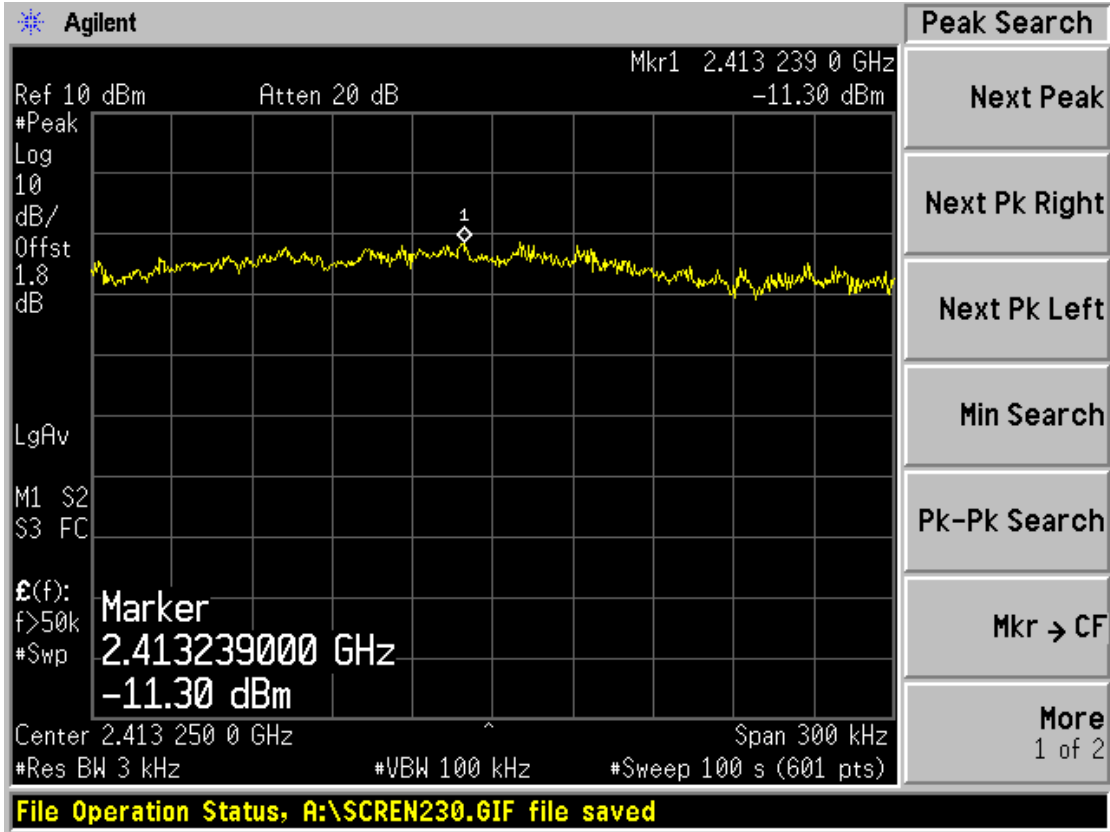

CH 6

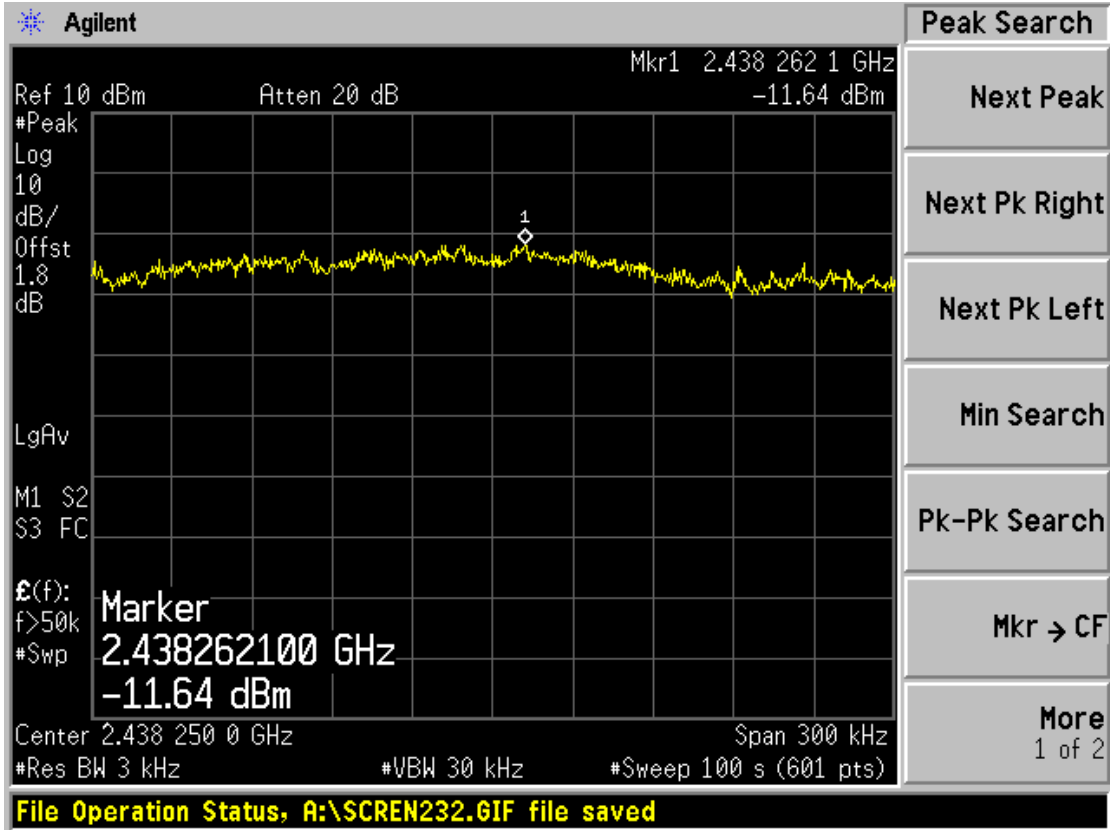

CH 11

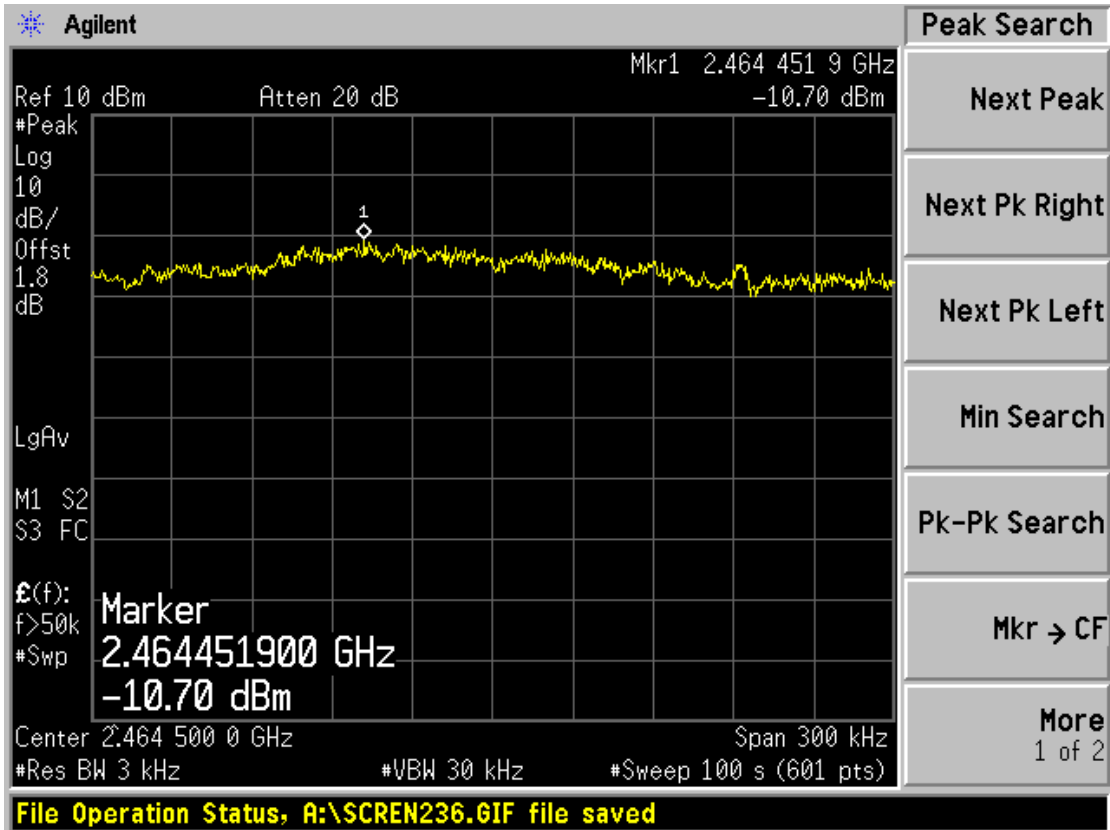

8.4.3. 802.11n HT20

CH 1

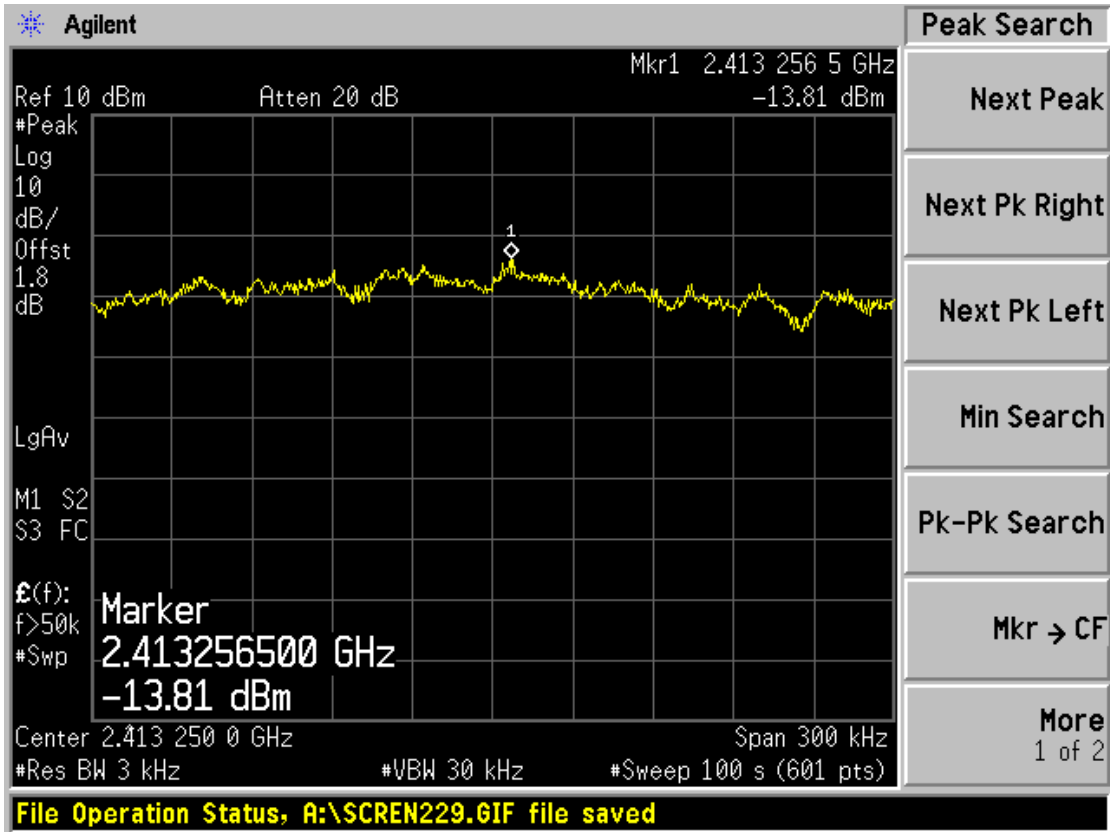

CH 6

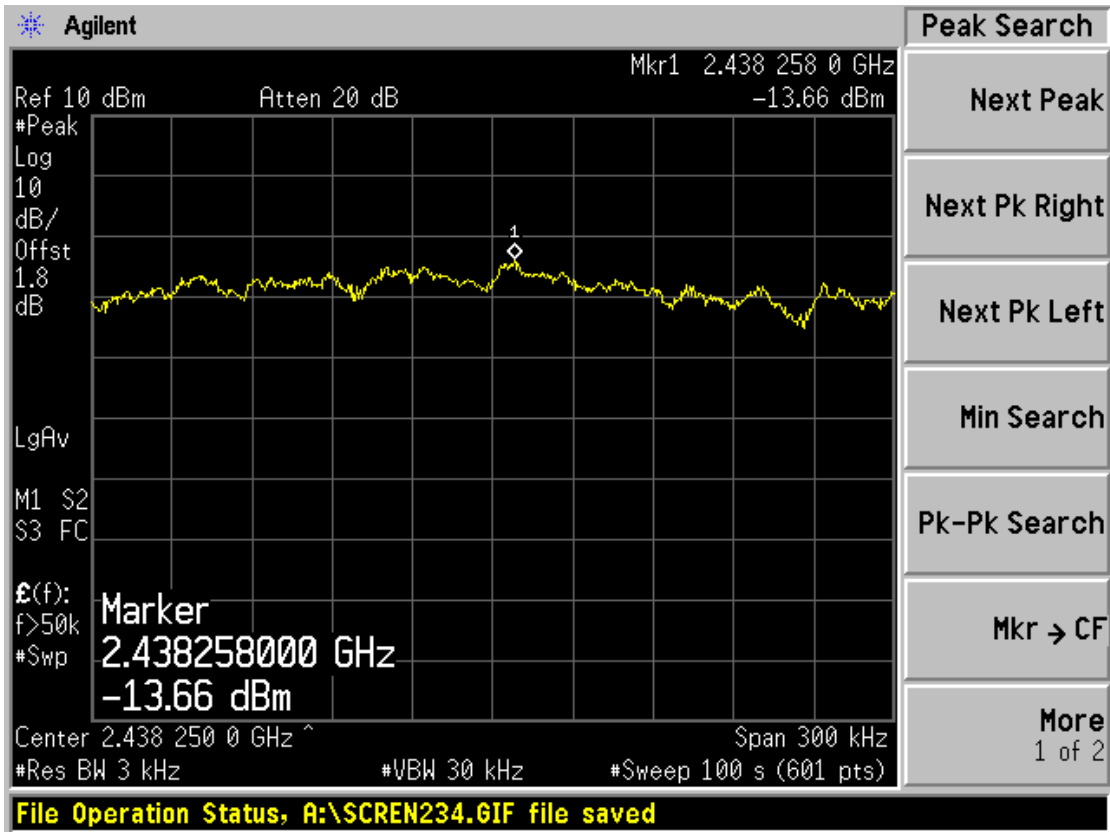

CH 11

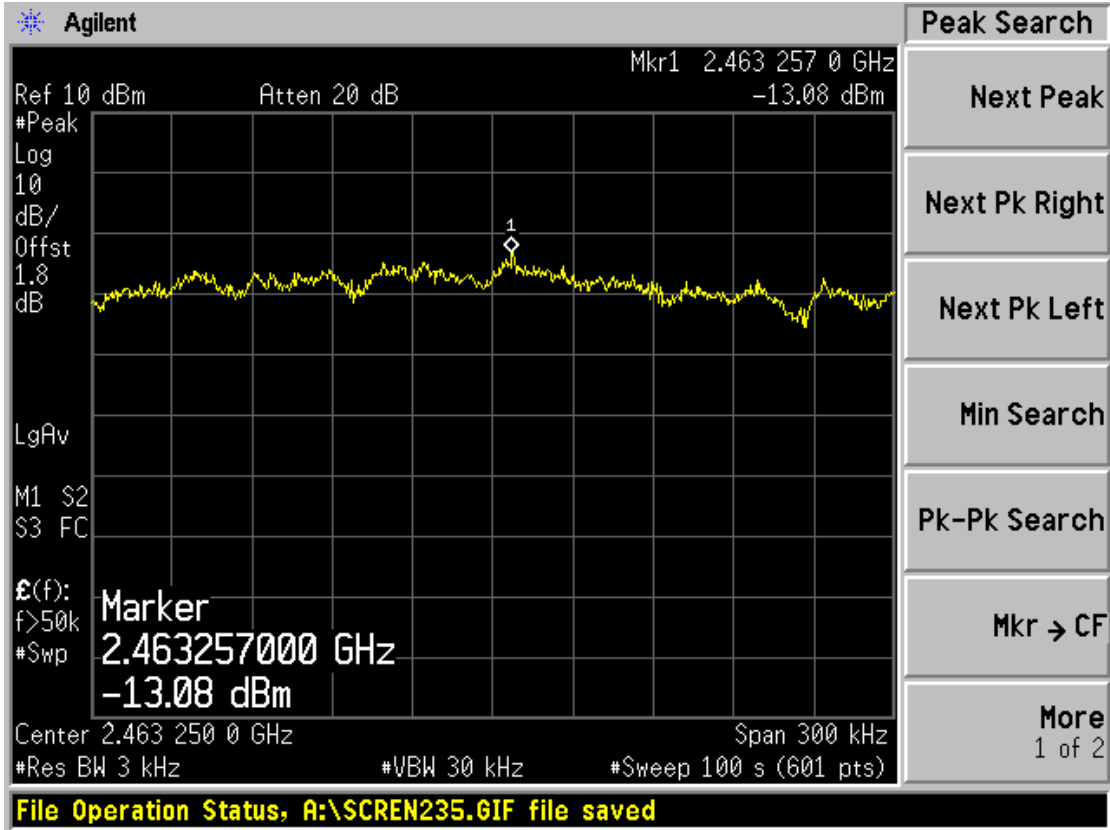

9. EMISSION LIMITATIONS MEASUREMENT

9.1. Test Equipment

Item	Type	Manufacturer	Model No.	Serial No.	Last Cal.	Next Cal.
1.	Spectrum Analyzer	Agilent	E4447A	MY45300136	2010-12-30	2011-12-29

9.2. Block Diagram of Test Setup

The same as section 5.2.

9.3. Specification Limits (§15.247(d))

In any 100 kHz bandwidth outside the frequency band in which the spread spectrum or digitally modulated intentional radiator is operating, the radio frequency power that is produced by the intentional radiator shall be at least 20 dB below that in the 100 kHz bandwidth within the band that contains the highest level of the desired power, based on either an RF conducted or a radiated measurement, provided the transmitter demonstrates compliance with the peak conducted power limits. If the transmitter complies with the conducted power limits based on the use of RMS averaging over a time interval, as permitted under paragraph (b)(3) of this section, the attenuation required under this paragraph shall be 30 dB instead of 20 dB. Attenuation below the general limits specified in Section 15.209(a) is not required. In addition, radiated emissions which fall in the restricted bands, as defined in Section 15.205(a), must also comply with the radiated emission limits specified in Section 15.209(a) (see Section 15.205(c)).

9.4. Test Results

PASSED. All the test results are attached in next pages.

Test Date: Dec.10, 2011 Temperature: 19.1 °C Humidity: 58 %

Item	Channel	Frequency(GHz)	Amplitude(dBm)
802.11b	1	2.400	-0.94
		1.602	-53.31
		1.826	-59.62
		4.820	-45.70
	6	2.400	-0.94
		1.602	-53.31
		1.826	-59.62
		4.820	-45.70
	11	2.450	0.05
		0.504	-64.02
		1.826	-60.88
		4.920	-44.66
802.11g	1	2.400	-0.56
		1.602	-48.23
		1.826	-59.35
		4.820	-48.94
	6	2.450	3.16
		1.627	-48.22
		1.826	-59.31
		4.870	-48.95
	11	2.450	0.50
		1.652	-47.99
		3.274	-58.92
		4.920	-47.56
802.11n HT20	1	2.425	-3.35
		1.602	-47.29
		1.826	-60.69
		4.820	-54.85
	6	2.450	-0.26
		1.627	-49.21
		1.826	-59.99
		4.870	-54.47
	11	2.475	-3.08
		1.652	-48.25
		1.826	-60.14
		4.920	-53.05

9.4.1. 802.11b

CH 1

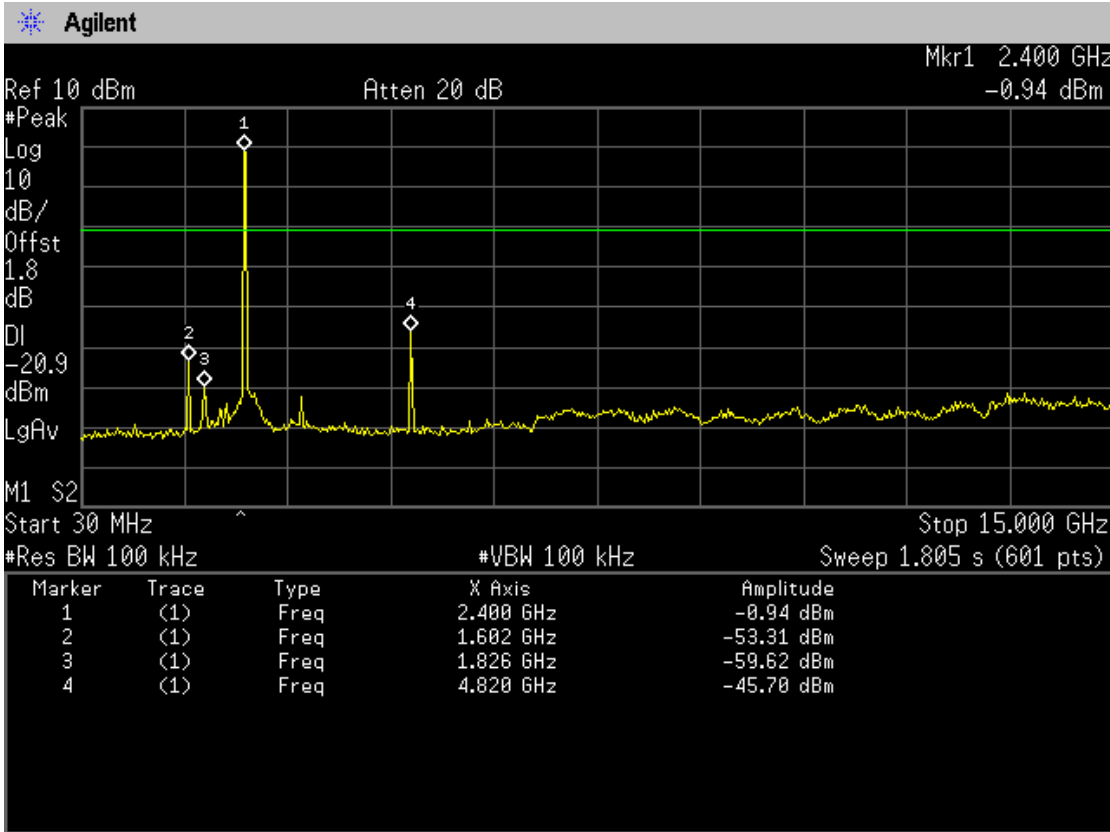

CH 6

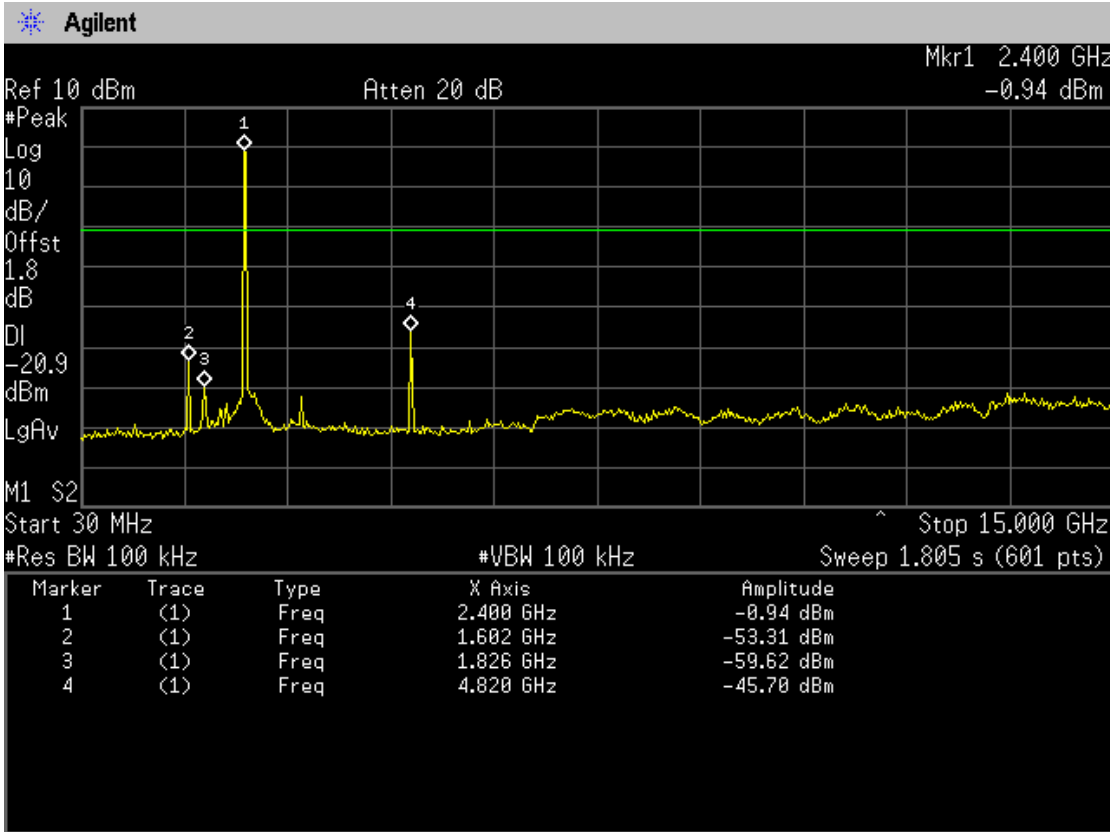

CH 11

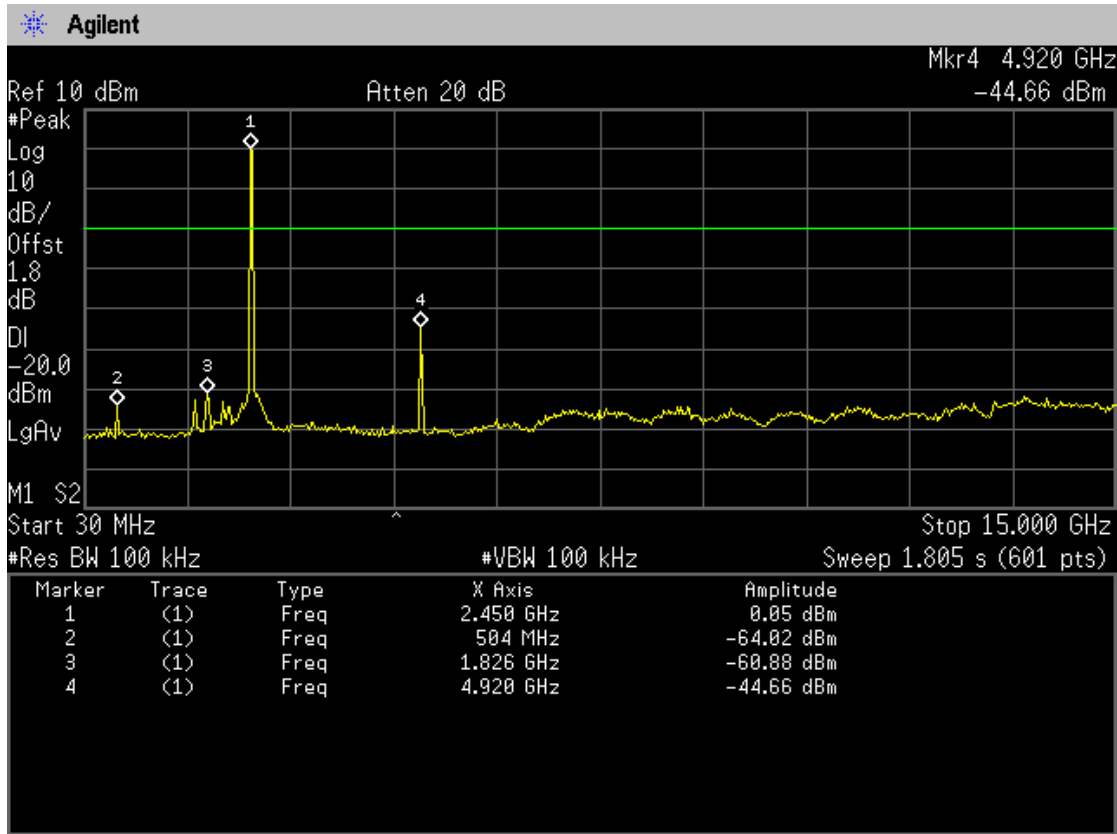

9.4.2. For 802.11g

CH 1

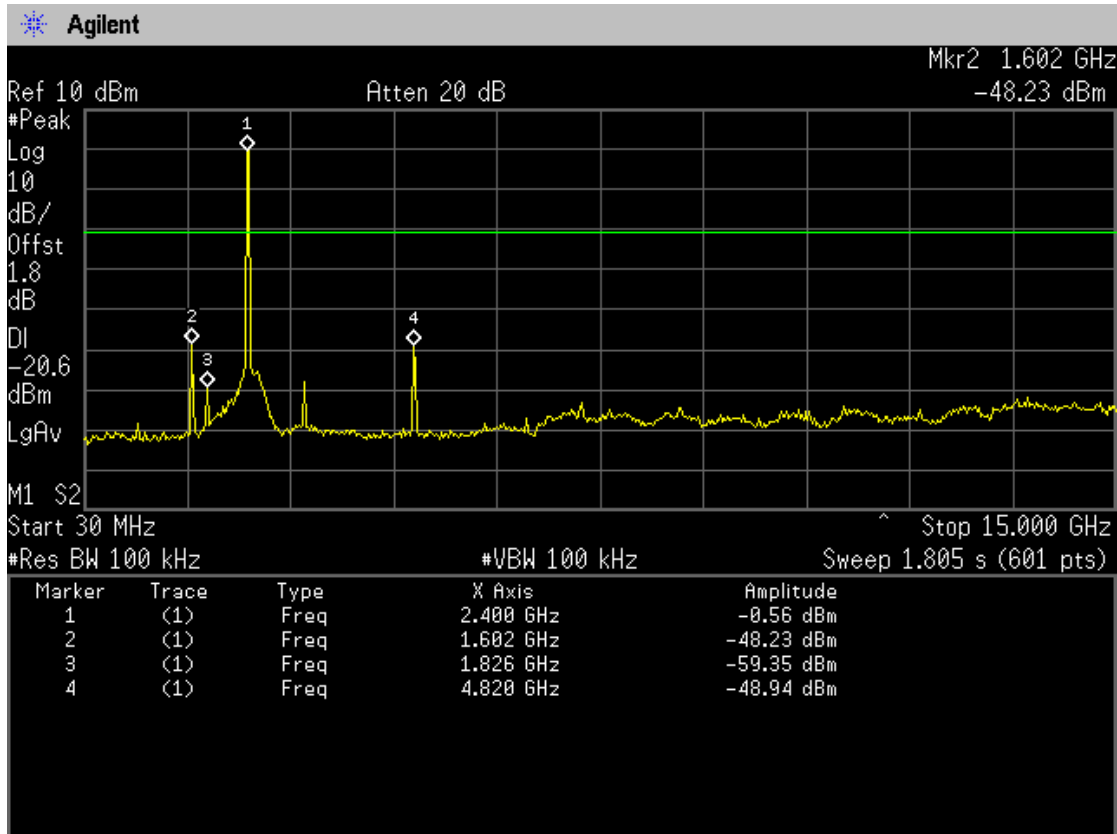

CH 6

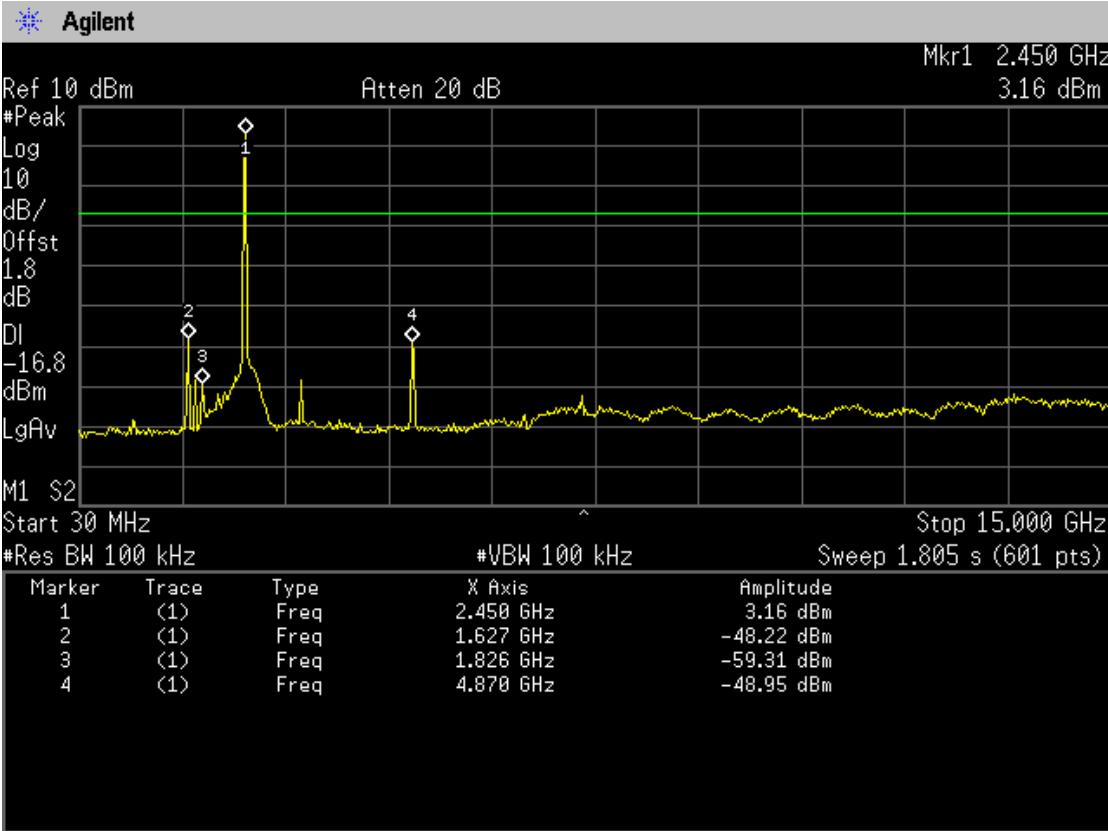

CH 11

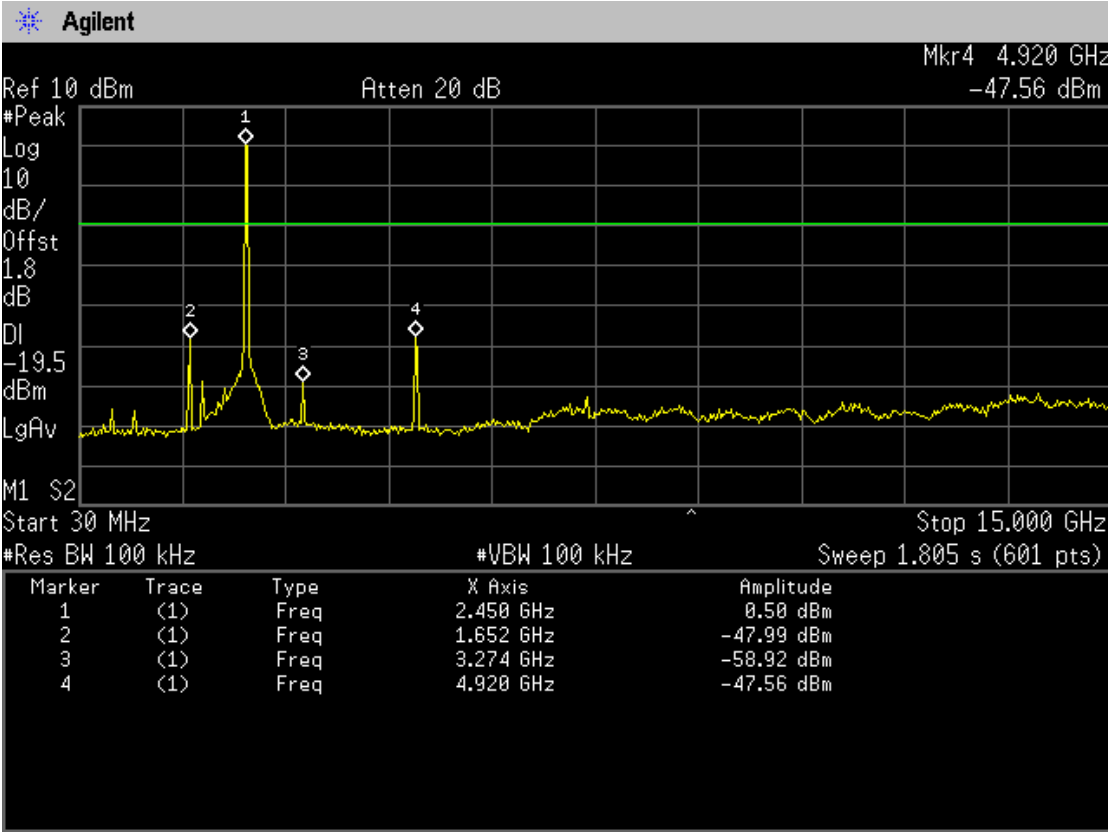

CH 11

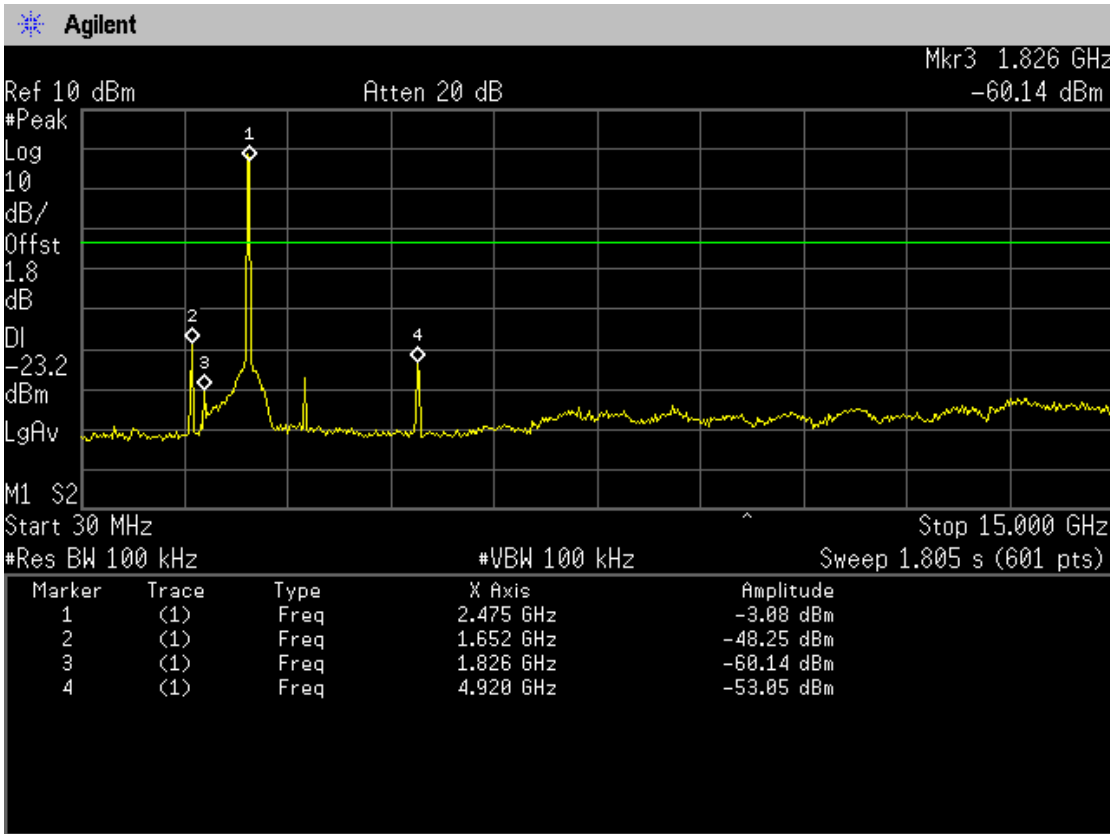

10.DEVIATION TO TEST SPECIFICATIONS

【NONE】