



**RADIATED SPURIOUS EMISSIONS PORTIONS OF  
FCC CFR47 PART 15 SUBPART C  
FOR  
DUAL-BAND 1xRTT CDMA PHONE WITH BLUETOOTH AND WIFI**

**MODEL NUMBER: SCP-8600**

**FCC ID: V65SCP-8600**

**REPORT NUMBER: 10U13193-4**

**ISSUE DATE: MAY 20, 2010**

*Prepared for*  
**KYOCERA COMMUNICATIONS, INC  
10300 CAMPUS POINT DRIVE  
SAN DIEGO, CA 92121, U.S.A.**

*Prepared by*  
**COMPLIANCE CERTIFICATION SERVICES  
47173 BENICIA STREET  
FREMONT, CA 94538, U.S.A.  
TEL: (510) 771-1000  
FAX: (510) 661-0888**



**NVLAP LAB CODE 200065-0**

Revision History

<u>Rev.</u>	<u>Issue Date</u>	<u>Revisions</u>	<u>Revised By</u>
---	05/20/10	Initial Issue	T. Chan

## TABLE OF CONTENTS

<b>1. ATTESTATION OF TEST RESULTS</b> .....	<b>4</b>
<b>2. TEST METHODOLOGY</b> .....	<b>5</b>
<b>3. FACILITIES AND ACCREDITATION</b> .....	<b>5</b>
<b>4. CALIBRATION AND UNCERTAINTY</b> .....	<b>5</b>
4.1. <i>MEASURING INSTRUMENT CALIBRATION</i> .....	5
4.2. <i>SAMPLE CALCULATION</i> .....	5
4.3. <i>MEASUREMENT UNCERTAINTY</i> .....	5
<b>5. EQUIPMENT UNDER TEST</b> .....	<b>6</b>
5.1. <i>DESCRIPTION OF EUT</i> .....	6
5.2. <i>DESCRIPTION OF AVAILABLE ANTENNAS</i> .....	6
5.3. <i>SOFTWARE AND FIRMWARE</i> .....	6
5.4. <i>WORST-CASE CONFIGURATION</i> .....	6
5.5. <i>DESCRIPTION OF TEST SETUP</i> .....	7
<b>6. TEST AND MEASUREMENT EQUIPMENT</b> .....	<b>9</b>
<b>7. RADIATED TEST RESULTS</b> .....	<b>10</b>
7.1. <i>LIMITS AND PROCEDURE</i> .....	10
7.2. <i>TRANSMITTER ABOVE 1 GHz</i> .....	11
7.2.1. <i>BASIC DATA RATE GFSK MODULATION</i> .....	11
7.2.2. <i>ENHANCED DATA RATE 8PSK MODULATION</i> .....	16
7.3. <i>WORST-CASE BELOW 1 GHz</i> .....	21
<b>8. AC POWER LINE CONDUCTED EMISSIONS</b> .....	<b>24</b>
<b>9. SETUP PHOTOS</b> .....	<b>28</b>

# 1. ATTESTATION OF TEST RESULTS

**COMPANY NAME:** KYOCERA COMMUNICATIONS, INC  
10300 CAMPUS POINT DRIVE  
SAN DIEGO, CA 92121, U.S.A.

**EUT DESCRIPTION:** DUAL-BAND 1xRTT CDMA PHONE WITH BLUETOOTH AND  
WIFI

**MODEL:** SCP-8600

**SERIAL NUMBER:** A0000012FEED44

**DATE TESTED:** MAY 19 - 20, 2010

APPLICABLE STANDARDS	
STANDARD	TEST RESULTS
CFR 47 Part 15 Subpart C	PASS (Radiated Portion )

Compliance Certification Services, Inc. (CCS) tested the above equipment in accordance with the requirements set forth in the above standards. All indications of Pass/Fail in this report are opinions expressed by CCS based on interpretations and/or observations of test results. Measurement Uncertainties were not taken into account and are published for informational purposes only. The test results show that the equipment tested is capable of demonstrating compliance with the requirements as documented in this report.

**Note:** The results documented in this report apply only to the tested sample, under the conditions and modes of operation as described herein. This document may not be altered or revised in any way unless done so by CCS and all revisions are duly noted in the revisions section. Any alteration of this document not carried out by CCS will constitute fraud and shall nullify the document. This report must not be used by the client to claim product certification, approval, or endorsement by NVLAP, NIST, any agency of the Federal Government, or any agency of any government.

Approved & Released For CCS By:

Tested By:



THU CHAN  
EMC MANAGER  
COMPLIANCE CERTIFICATION SERVICES

CHIN PANG  
EMC ENGINEER  
COMPLIANCE CERTIFICATION SERVICES

## 2. TEST METHODOLOGY

The tests documented in this report were performed in accordance with ANSI C63.10-2009, FCC CFR 47 Part 2, and FCC CFR 47 Part 15.

## 3. FACILITIES AND ACCREDITATION

The test sites and measurement facilities used to collect data are located at 47173 Benicia Street, Fremont, California, USA.

CCS is accredited by NVLAP, Laboratory Code 200065-0. The full scope of accreditation can be viewed at <http://www.ccsemc.com>.

## 4. CALIBRATION AND UNCERTAINTY

### 4.1. MEASURING INSTRUMENT CALIBRATION

The measuring equipment utilized to perform the tests documented in this report has been calibrated in accordance with the manufacturer's recommendations, and is traceable to recognized national standards.

### 4.2. SAMPLE CALCULATION

Where relevant, the following sample calculation is provided:

$$\begin{aligned} \text{Field Strength (dBuV/m)} &= \text{Measured Voltage (dBuV)} + \text{Antenna Factor (dB/m)} + \\ &\text{Cable Loss (dB)} - \text{Preamp Gain (dB)} \\ 36.5 \text{ dBuV} + 18.7 \text{ dB/m} + 0.6 \text{ dB} - 26.9 \text{ dB} &= 28.9 \text{ dBuV/m} \end{aligned}$$

### 4.3. MEASUREMENT UNCERTAINTY

Where relevant, the following measurement uncertainty levels have been estimated for tests performed on the apparatus:

PARAMETER	UNCERTAINTY
Conducted Disturbance, 0.15 to 30 MHz	3.52 dB
Radiated Disturbance, 30 to 1000 MHz	4.94 dB

Uncertainty figures are valid to a confidence level of 95%.

## **5. EQUIPMENT UNDER TEST**

### **5.1. DESCRIPTION OF EUT**

The EUT is a Bluetooth featured Dual-band CDMA Phone with Bluetooth and WiFi feature that manufactured by KYOCERA Communications, Inc.

### **5.2. DESCRIPTION OF AVAILABLE ANTENNAS**

The radio utilizes an internal antenna, with a maximum gain of -1.0dBi.

### **5.3. SOFTWARE AND FIRMWARE**

The firmware installed in the EUT during testing was 1.0.10.0.

The test utility software used during testing was FCC\_tools.

### **5.4. WORST-CASE CONFIGURATION**

The EUT has been evaluated at X, Y, Z-axis, and AC/DC adapter. The highest measured output power was at X-Axis with AC/DC adapter.

## 5.5. DESCRIPTION OF TEST SETUP

### SUPPORT EQUIPMENT

PERIPHERAL SUPPORT EQUIPMENT LIST				
Description	Manufacturer	Model	Serial Number	FCC ID
Laptop PC	Dell	D620	CCS # C01095	E2KWM3945ABG
AC Adapter	Dell	LA65NS0-00	CN-ODF263-71615-720-2D21	N/A
AC Adapter	Sanyo	SCP-24ADT	NA	NA
Headset	N/A	N/A	N/A	N/A

### I/O CABLES

I/O CABLE LIST						
Cable No.	Port	# of Identic Ports	Connector Type	Cable Type	Cable Length	Remarks
1	AC	2	US115V	Un-Shielded	1m	NA
2	DC Input	2	Mini-USB	Un-Shielded	2m	N/A
3	USB	1	Mini-USB	Un-Shielded	1m	N/A
4	AUDIO	1	Mini-Jack	Un-Shielded	1.2m	NA

### TEST SETUP

The headset attached EUT is tested as stand-alone unit. The support laptop is used only to setup, change channels and modulations for the EUT.

**SETUP DIAGRAM FOR TESTS**

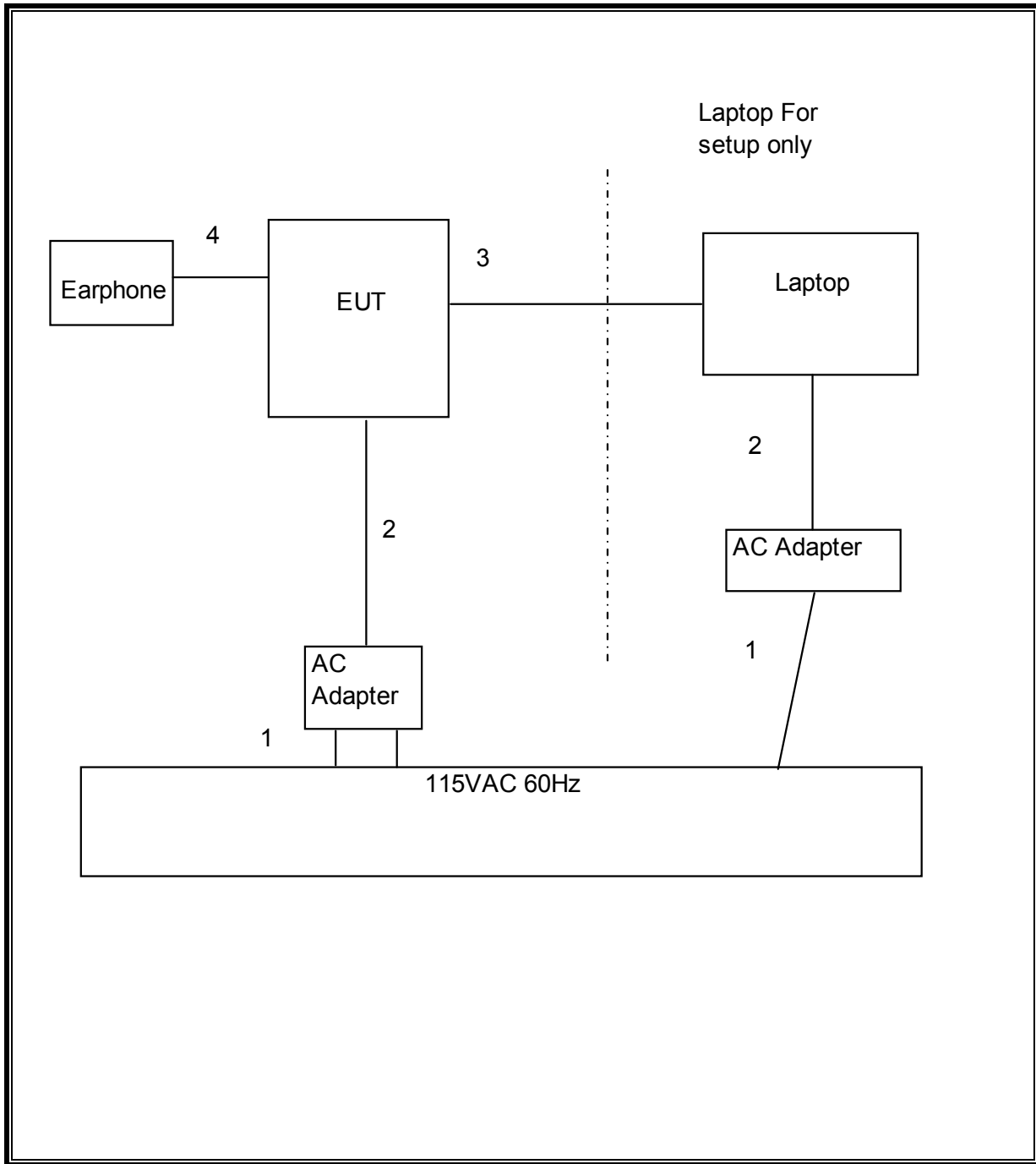



## 6. TEST AND MEASUREMENT EQUIPMENT

The following test and measurement equipment was utilized for the tests documented in this report:

TEST EQUIPMENT LIST				
Description	Manufacturer	Model	Asset	Cal Due
Preamplifier, 26.5 GHz	Agilent / HP	8449B	C01052	08/04/10
Antenna, Horn, 18 GHz	EMCO	3115	C00945	07/29/10
Preamplifier, 1300 MHz	Agilent / HP	8447D	C00885	07/06/10
Antenna, Bilog, 2 GHz	Sunol Sciences	JB1	C01016	07/14/10
Spectrum Analyzer, 26.5 GHz	Agilent / HP	E4440A	C01178	08/31/10
EMI Test Receiver, 30 MHz	R & S	ESHS 20	N02396	05/06/11
LISN, 30 MHz	FCC	LISN-50/250-25-2	N02625	11/06/10
Reject Filter, 2.4-2.5 GHz	Micro-Tronics	BRC13192	N02683	CNR

## 7. RADIATED TEST RESULTS

### 7.1. LIMITS AND PROCEDURE

#### LIMITS

FCC §15.205 and §15.209

Frequency Range (MHz)	Field Strength Limit (uV/m) at 3 m	Field Strength Limit (dBuV/m) at 3 m
30 - 88	100	40
88 - 216	150	43.5
216 - 960	200	46
Above 960	500	54

#### TEST PROCEDURE

The EUT is placed on a non-conducting table 80 cm above the ground plane. The antenna to EUT distance is 3 meters. The EUT is configured in accordance with ANSI C63.4. The EUT is set to transmit in a continuous mode.

For measurements below 1 GHz the resolution bandwidth is set to 100 kHz for peak detection measurements or 120 kHz for quasi-peak detection measurements. Peak detection is used unless otherwise noted as quasi-peak.

For measurements above 1 GHz the resolution bandwidth is set to 1 MHz, then the video bandwidth is set to 1 MHz for peak measurements and 10 Hz for average measurements.

The spectrum from 30 MHz to 26 GHz is investigated with the transmitter set to the lowest, middle, and highest channels in the 2.4 GHz band.

The spectrum from 30 MHz to 40 GHz is investigated with the transmitter set to the lowest, middle, and highest channels in each applicable band.

The frequency range of interest is monitored at a fixed antenna height and EUT azimuth. The EUT is rotated through 360 degrees to maximize emissions received. The antenna is scanned from 1 to 4 meters above the ground plane to further maximize the emission. Measurements are made with the antenna polarized in both the vertical and the horizontal positions.

#### RESULTS

## 7.2. TRANSMITTER ABOVE 1 GHz

### 7.2.1. BASIC DATA RATE GFSK MODULATION

#### RESTRICTED BANDEDGE (LOW CHANNEL, HORIZONTAL)

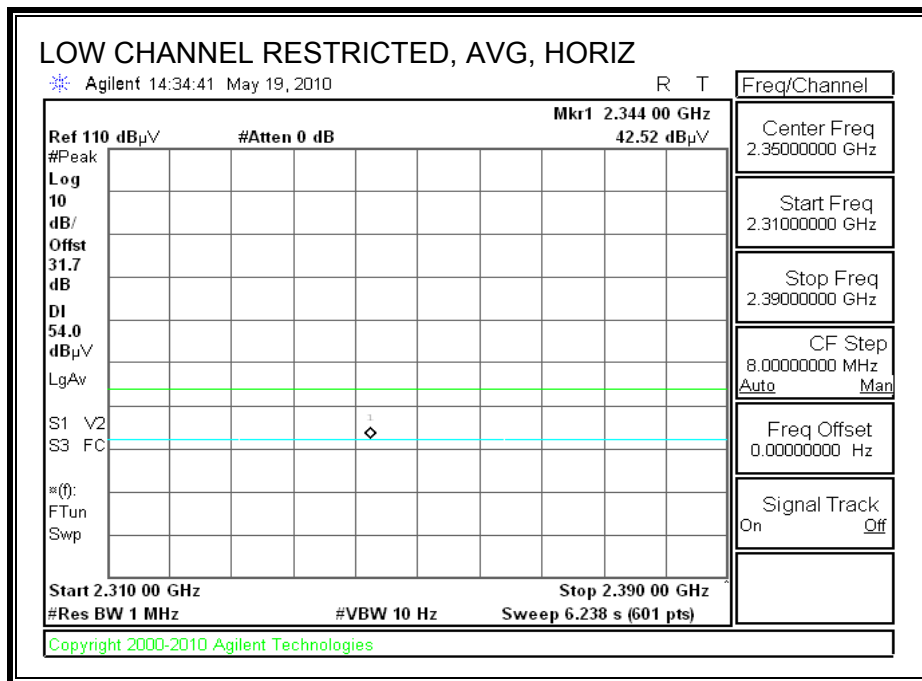
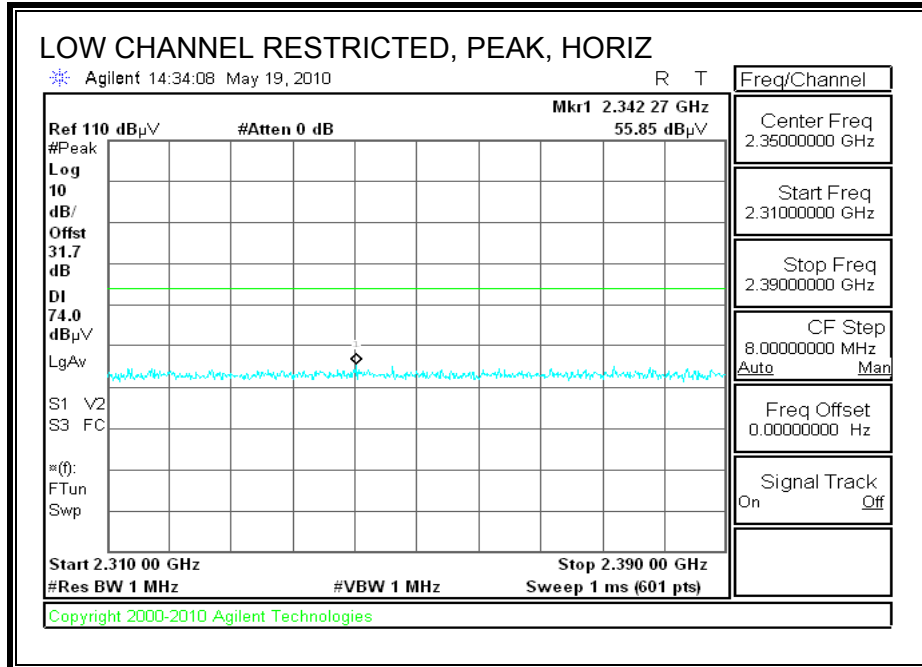

**RESTRICTED BANDEGE (LOW CHANNEL, VERTICAL)**

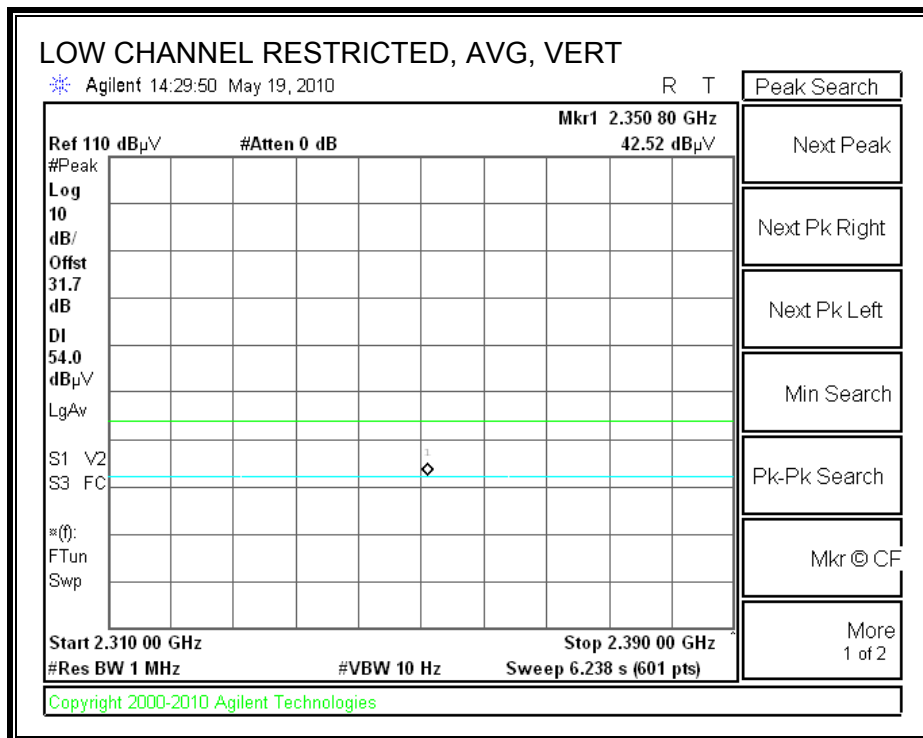
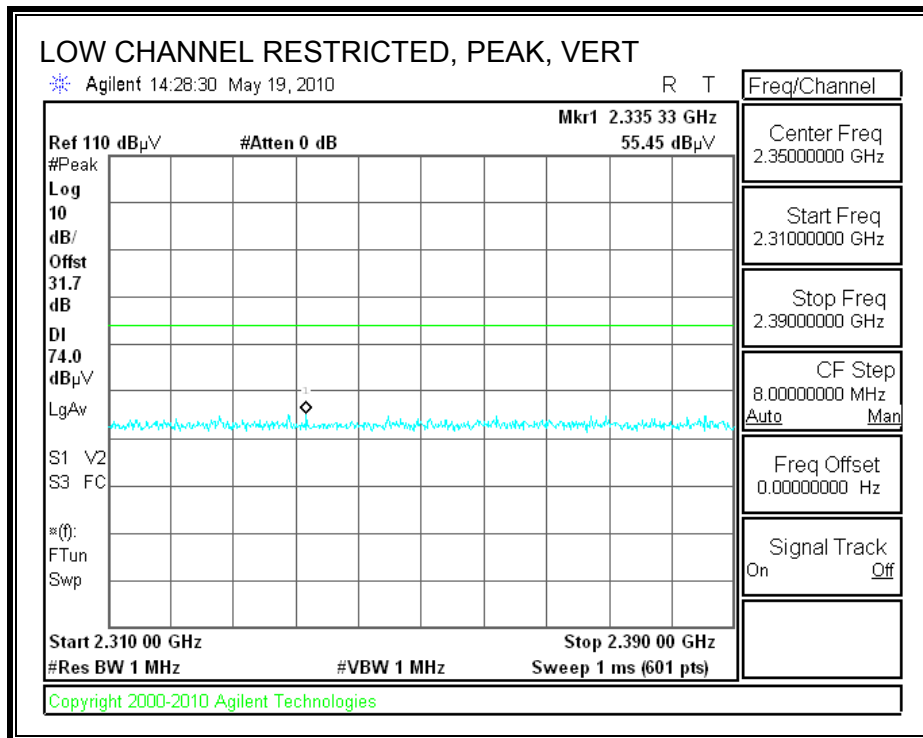

**RESTRICTED BANEDGE (HIGH CHANNEL, HORIZONTAL)**

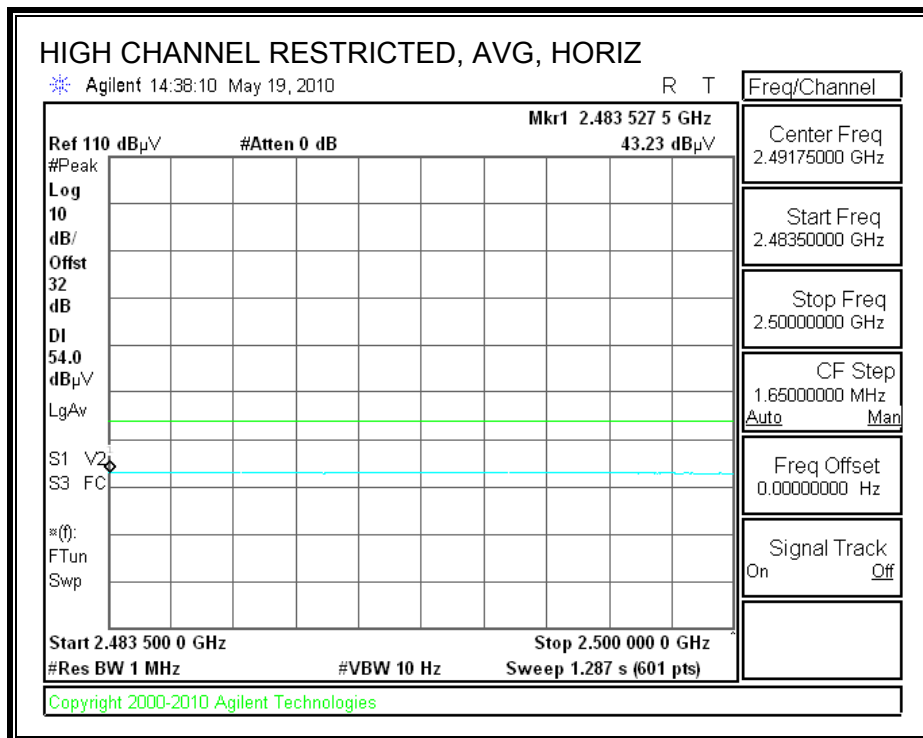
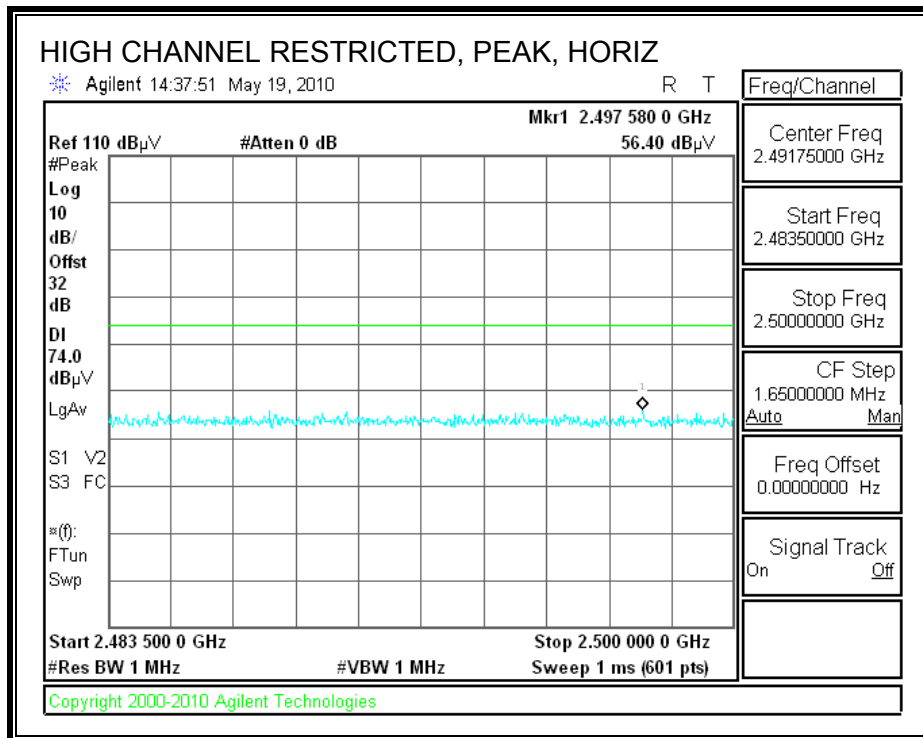

**RESTRICTED BANDEDGE (HIGH CHANNEL, VERTICAL)**

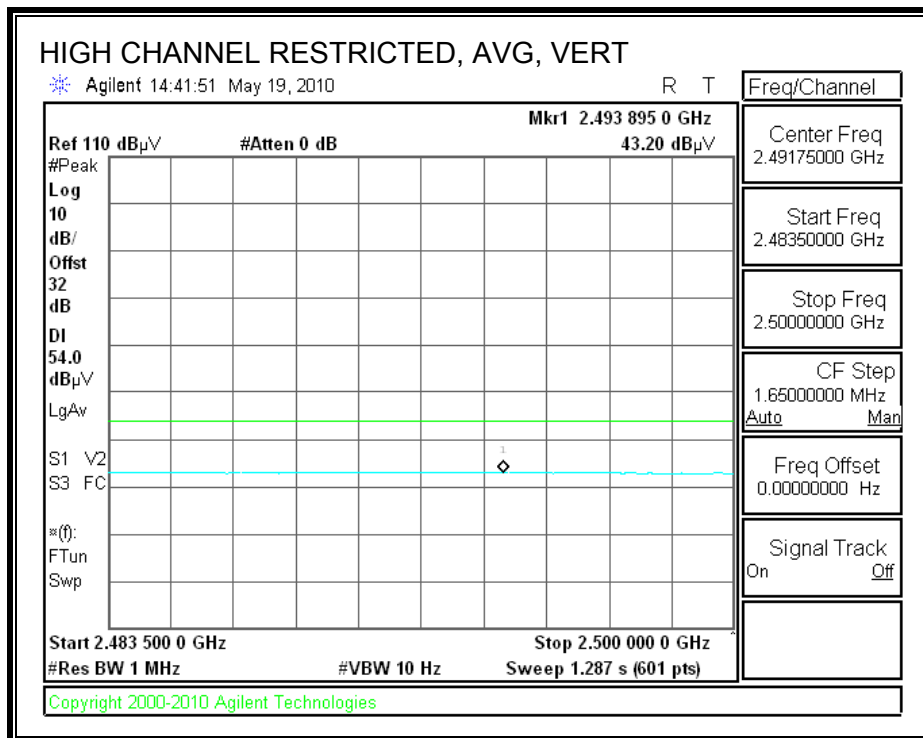
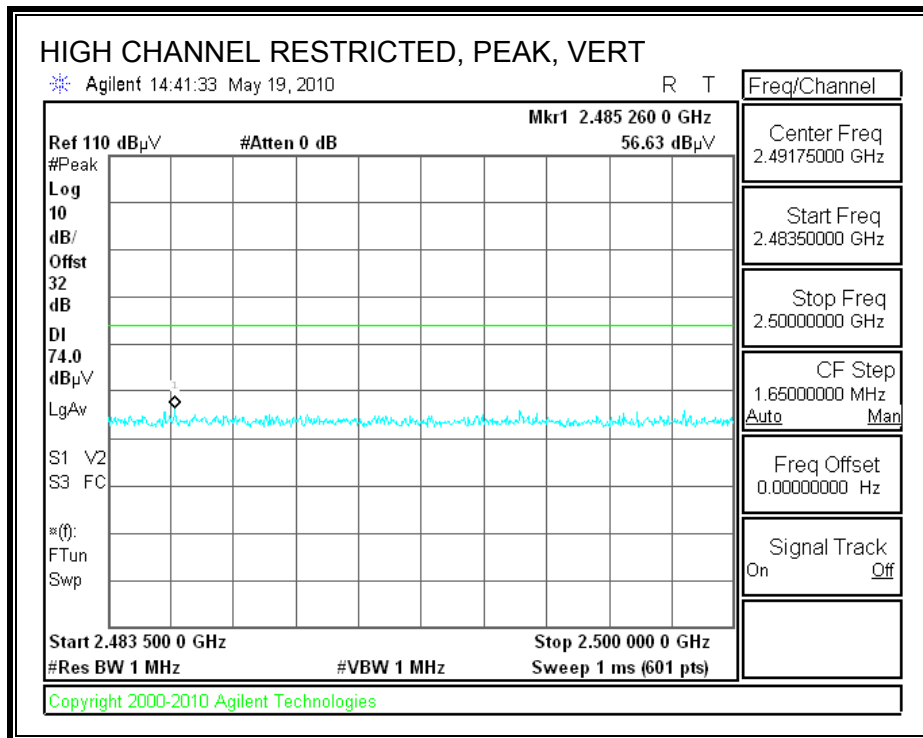

**HARMONICS AND SPURIOUS EMISSIONS**

High Frequency Measurement													
Compliance Certification Services, Fremont 5m Chamber													
Test Engr:		Chin Pang											
Date:		05/19/10											
Project #:		10U13193											
Company:		Kyocera											
EUT Description:		WiFi + Dual-Band CDMA Phone with Bluetooth 2.0 + EDR											
EUT M/N:		SCP-8600											
Test Target:		FCC 15.247											
Mode Oper:		TX, BT, Basic Rate											
f	Measurement Frequency			Amp	Preamp Gain			Average Field Strength Limit					
Dist	Distance to Antenna			D Corr	Distance Correct to 3 meters			Peak Field Strength Limit					
Read	Analyzer Reading			Avg	Average Field Strength @ 3 m			Margin vs. Average Limit					
AF	Antenna Factor			Peak	Calculated Peak Field Strength			Margin vs. Peak Limit					
CL	Cable Loss			HPF	High Pass Filter								
f	Dist	Read	AF	CL	Amp	D Corr	Fltr	Corr.	Limit	Margin	Ant. Pol.	Det.	Notes
GHz	(m)	dBuV	dB/m	dB	dB	dB	dB	dBuV/m	dBuV/m	dB	V/H	P/A/QP	
<b>Low Ch, 2402MHz</b>													
4.804	3.0	40.3	33.0	5.8	-36.5	0.0	0.0	42.7	74.0	-31.3	V	P	
4.804	3.0	31.0	33.0	5.8	-36.5	0.0	0.0	33.4	54.0	-20.6	V	A	
4.804	3.0	39.1	33.0	5.8	-36.5	0.0	0.0	41.5	74.0	-32.5	H	P	
4.804	3.0	26.5	33.0	5.8	-36.5	0.0	0.0	28.9	54.0	-25.1	H	A	
<b>Mid Ch 2441MHz</b>													
4.882	3.0	40.4	33.1	5.8	-36.5	0.0	0.0	42.9	74.0	-31.1	V	P	
4.882	3.0	31.3	33.1	5.8	-36.5	0.0	0.0	33.8	54.0	-20.2	V	A	
7.323	3.0	37.8	35.3	7.3	-36.2	0.0	0.0	44.1	74.0	-29.9	V	P	
7.323	3.0	25.6	35.3	7.3	-36.2	0.0	0.0	31.9	54.0	-22.1	V	A	
4.882	3.0	38.3	33.1	5.8	-36.5	0.0	0.0	40.7	74.0	-33.3	H	P	
4.882	3.0	25.9	33.1	5.8	-36.5	0.0	0.0	28.4	54.0	-25.6	H	A	
7.323	3.0	37.4	35.3	7.3	-36.2	0.0	0.0	43.7	74.0	-30.3	H	P	
7.323	3.0	25.6	35.3	7.3	-36.2	0.0	0.0	32.0	54.0	-22.0	H	A	
<b>High Ch, 2480MHz</b>													
4.960	3.0	39.1	33.2	5.9	-36.5	0.0	0.0	41.8	74.0	-32.2	V	P	
4.960	3.0	29.6	33.2	5.9	-36.5	0.0	0.0	32.2	54.0	-21.8	V	A	
7.440	3.0	37.3	35.5	7.3	-36.2	0.0	0.0	43.9	74.0	-30.1	V	P	
7.440	3.0	25.0	35.5	7.3	-36.2	0.0	0.0	31.6	54.0	-22.4	V	A	
4.960	3.0	39.0	33.2	5.9	-36.5	0.0	0.0	41.6	74.0	-32.4	H	P	
4.960	3.0	25.6	33.2	5.9	-36.5	0.0	0.0	28.2	54.0	-25.8	H	A	
7.440	3.0	37.0	35.5	7.3	-36.2	0.0	0.0	43.6	74.0	-30.4	H	P	
7.440	3.0	24.7	35.5	7.3	-36.2	0.0	0.0	31.3	54.0	-22.7	H	A	
Rev. 4.1.2.7													
Note: No other emissions were detected above the system noise floor.													

### 7.2.2. ENHANCED DATA RATE 8PSK MODULATION

#### RESTRICTED BANDEDGE (LOW CHANNEL, HORIZONTAL)

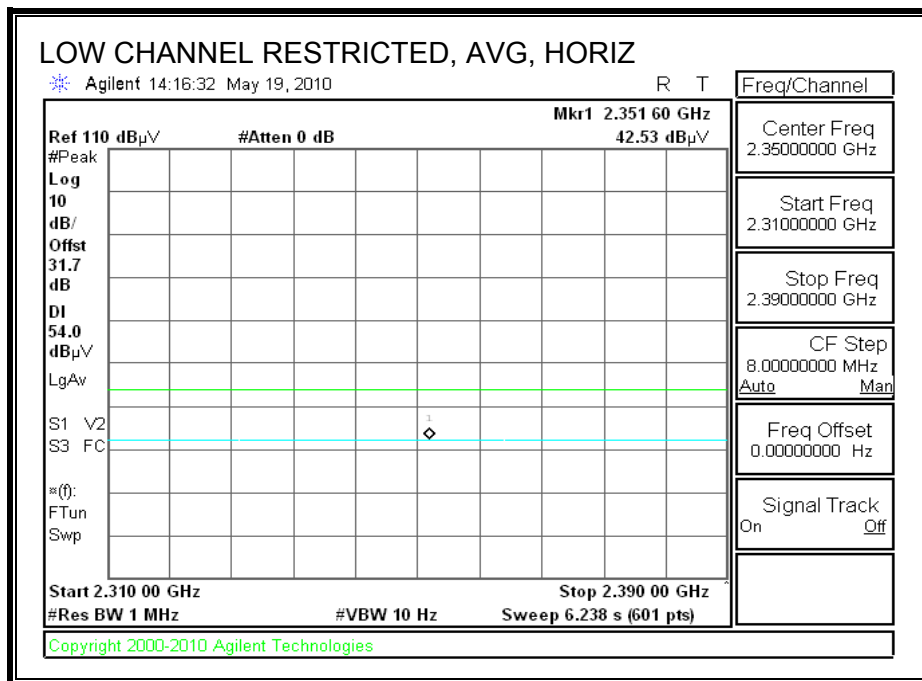
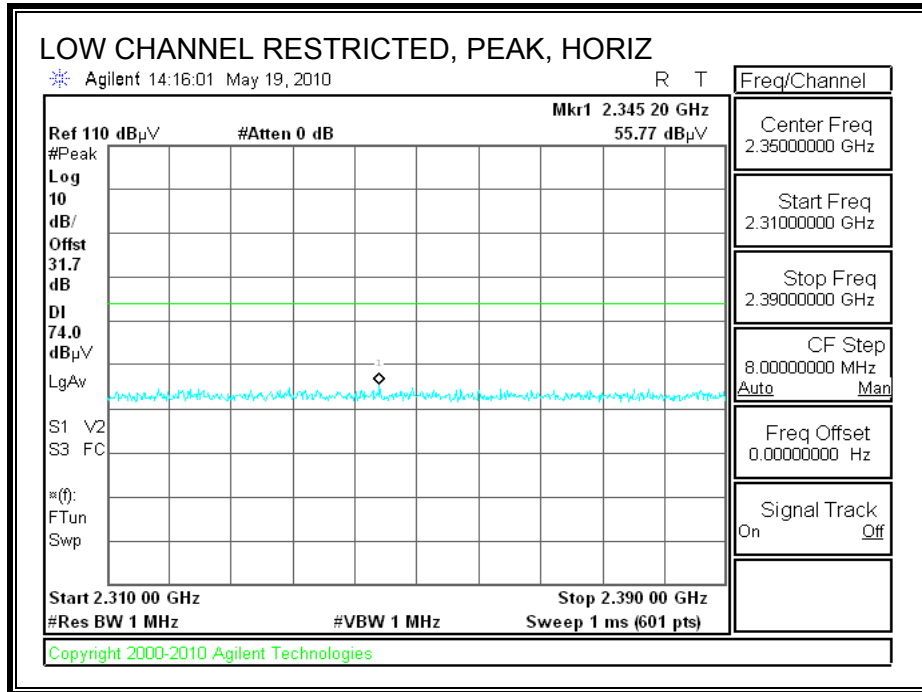



**RESTRICTED BANEDGE (LOW CHANNEL, VERTICAL)**

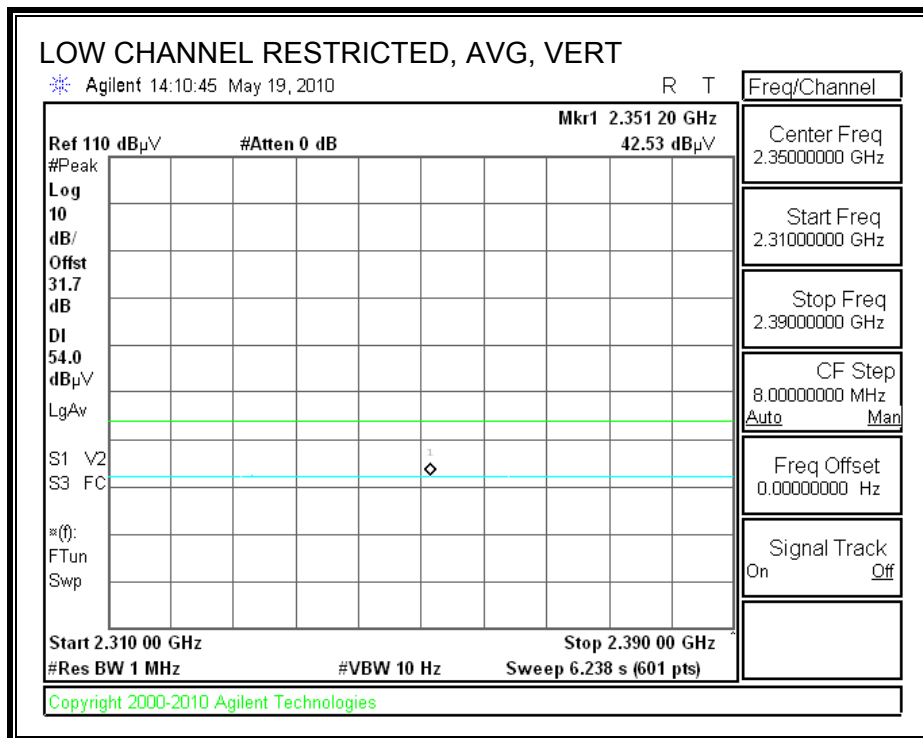
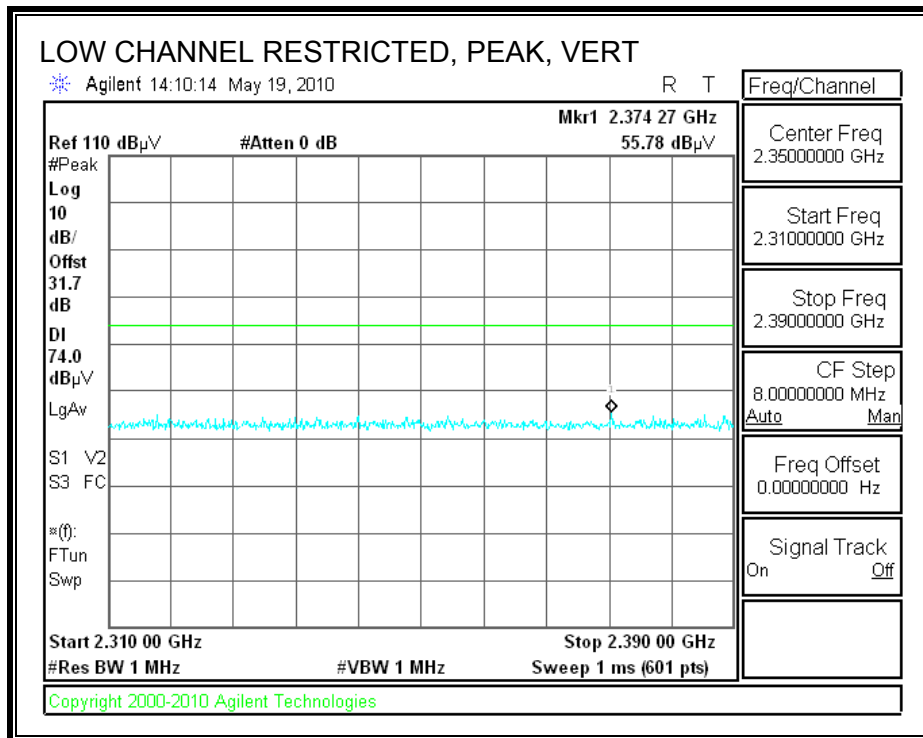

**RESTRICTED BANDEDGE (HIGH CHANNEL, HORIZONTAL)**

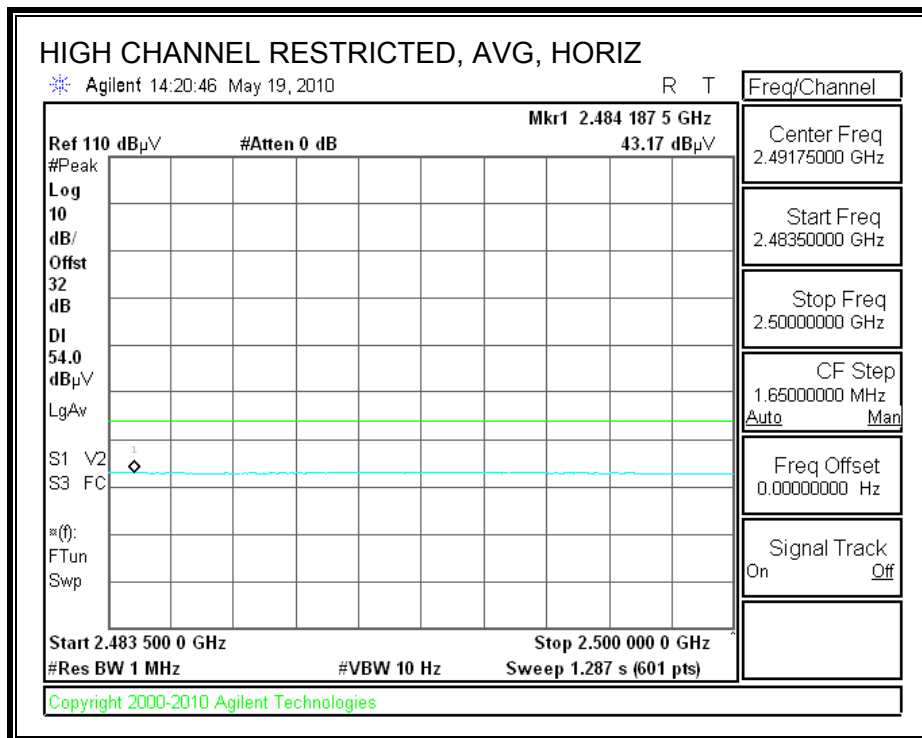
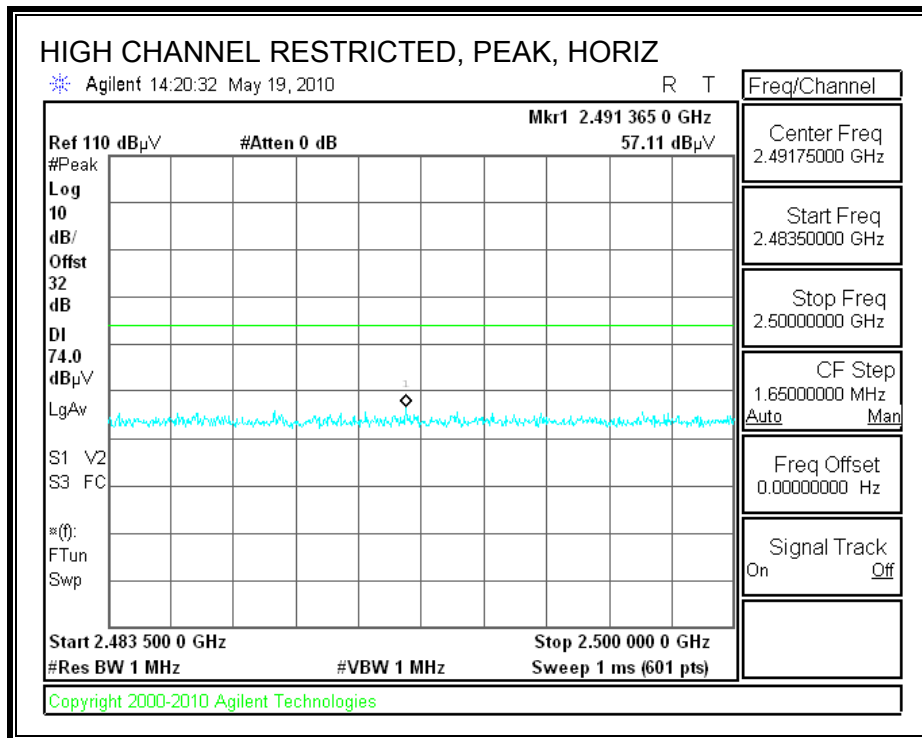

**RESTRICTED BANDEDGE (HIGH CHANNEL, VERTICAL)**

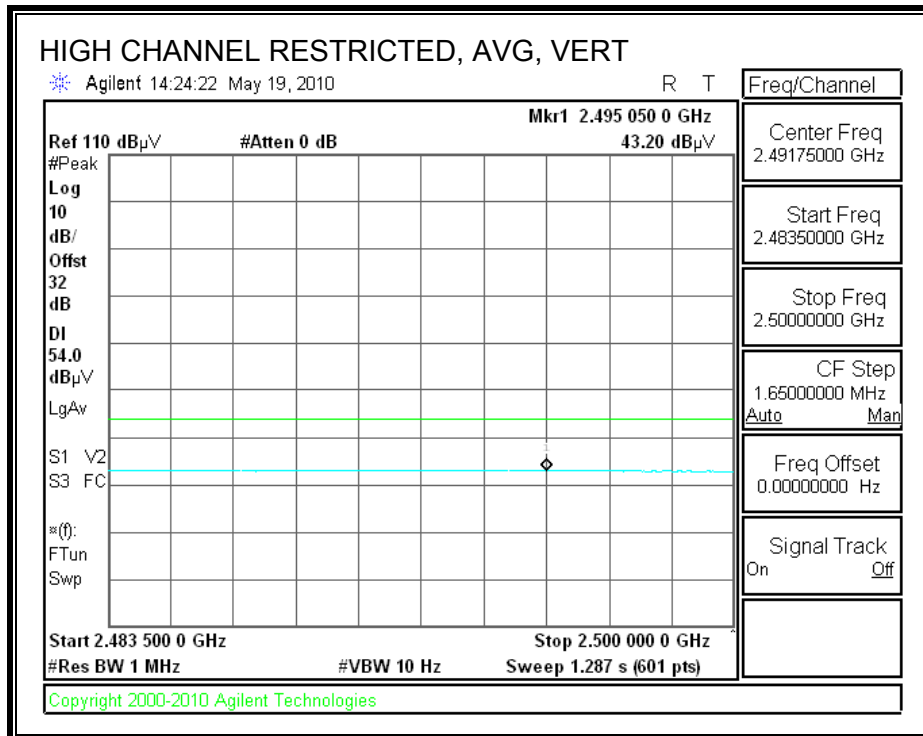
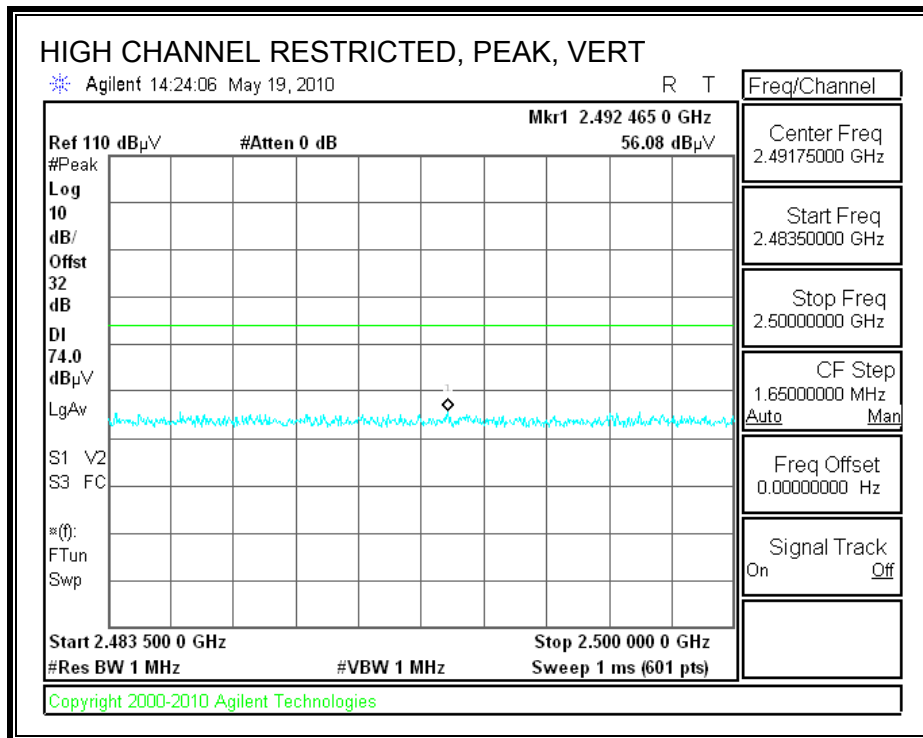

**HARMONICS AND SPURIOUS EMISSIONS**

High Frequency Measurement													
Compliance Certification Services, Fremont 5m Chamber													
Test Engr:		Chin Pang											
Date:		05/19/10											
Project #:		10U13193											
Company:		Kyocera											
EUT Description:		WiFi + Dual-Band CDMA Phone with Bluetooth 2.0 + EDR											
EUT M/N:		SCP-8600											
Test Target:		FCC 15.247											
Mode Oper:		TX, BT, EDR											
f	Measurement Frequency		Amp	Preamp Gain		Average Field Strength Limit							
Dist	Distance to Antenna		D Corr	Distance Correct to 3 meters		Peak Field Strength Limit							
Read	Analyzer Reading		Avg	Average Field Strength @ 3 m		Margin vs. Average Limit							
AF	Antenna Factor		Peak	Calculated Peak Field Strength		Margin vs. Peak Limit							
CL	Cable Loss		HPF	High Pass Filter									
f	Dist	Read	AF	CL	Amp	D Corr	Filtr	Corr.	Limit	Margin	Ant. Pol.	Det.	Notes
GHz	(m)	dBuV	dB/m	dB	dB	dB	dB	dBuV/m	dBuV/m	dB	V/H	P/A/QP	
<b>Low Ch, 2402MHz</b>													
4.804	3.0	41.5	33.0	5.8	-36.5	0.0	0.0	43.9	74.0	-30.1	V	P	
4.804	3.0	30.2	33.0	5.8	-36.5	0.0	0.0	32.6	54.0	-21.4	V	A	
4.804	3.0	38.3	33.0	5.8	-36.5	0.0	0.0	40.6	74.0	-33.4	H	P	
4.804	3.0	26.3	33.0	5.8	-36.5	0.0	0.0	28.7	54.0	-25.3	H	A	
<b>Mid Ch, 2441MHz</b>													
4.882	3.0	40.6	33.1	5.8	-36.5	0.0	0.0	43.1	74.0	-30.9	V	P	
4.882	3.0	30.4	33.1	5.8	-36.5	0.0	0.0	32.9	54.0	-21.1	V	A	
7.323	3.0	38.9	35.3	7.3	-36.2	0.0	0.0	45.3	74.0	-28.7	V	P	
7.323	3.0	25.5	35.3	7.3	-36.2	0.0	0.0	31.8	54.0	-22.2	V	A	
4.882	3.0	38.1	33.1	5.8	-36.5	0.0	0.0	40.5	74.0	-33.5	H	P	
4.882	3.0	25.8	33.1	5.8	-36.5	0.0	0.0	28.3	54.0	-25.7	H	A	
7.323	3.0	37.8	35.3	7.3	-36.2	0.0	0.0	44.2	74.0	-29.8	H	P	
7.323	3.0	25.5	35.3	7.3	-36.2	0.0	0.0	31.8	54.0	-22.2	H	A	
<b>High Ch, 2480MHz</b>													
4.960	3.0	39.6	33.2	5.9	-36.5	0.0	0.0	42.2	74.0	-31.8	V	P	
4.960	3.0	29.2	33.2	5.9	-36.5	0.0	0.0	31.8	54.0	-22.2	V	A	
7.440	3.0	38.1	35.5	7.3	-36.2	0.0	0.0	44.7	74.0	-29.3	V	P	
7.440	3.0	24.9	35.5	7.3	-36.2	0.0	0.0	31.6	54.0	-22.4	V	A	
4.960	3.0	37.8	33.2	5.9	-36.5	0.0	0.0	40.4	74.0	-33.6	H	P	
4.960	3.0	25.5	33.2	5.9	-36.5	0.0	0.0	28.2	54.0	-25.8	H	A	
7.440	3.0	37.8	35.5	7.3	-36.2	0.0	0.0	44.4	74.0	-29.6	H	P	
7.440	3.0	24.9	35.5	7.3	-36.2	0.0	0.0	31.6	54.0	-22.4	H	A	
Rev. 4.1.2.7													
Note: No other emissions were detected above the system noise floor.													

### 7.3. WORST-CASE BELOW 1 GHz

#### SPURIOUS EMISSIONS 30 TO 1000 MHz (WORST-CASE CONFIGURATION, HORIZONTAL)

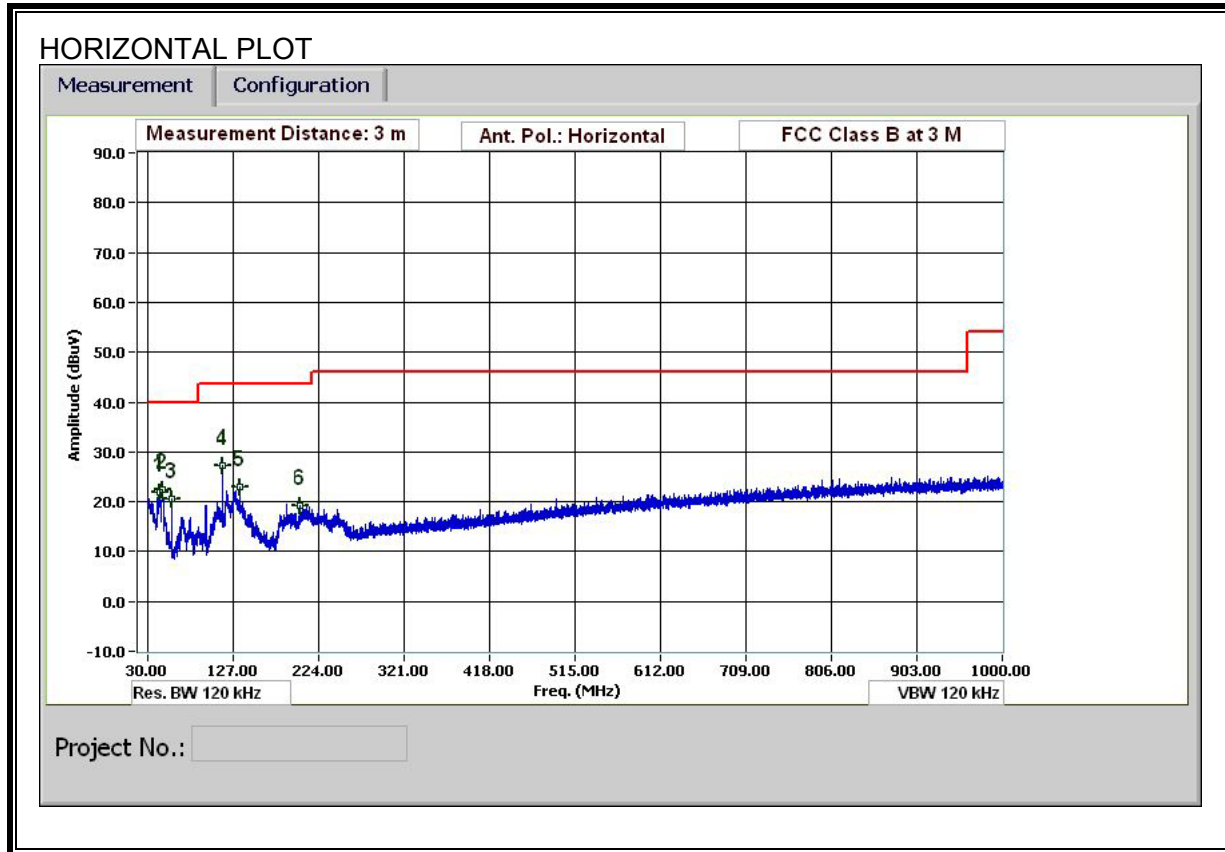

**SPURIOUS EMISSIONS 30 TO 1000 MHz (WORST-CASE CONFIGURATION, VERTICAL)**

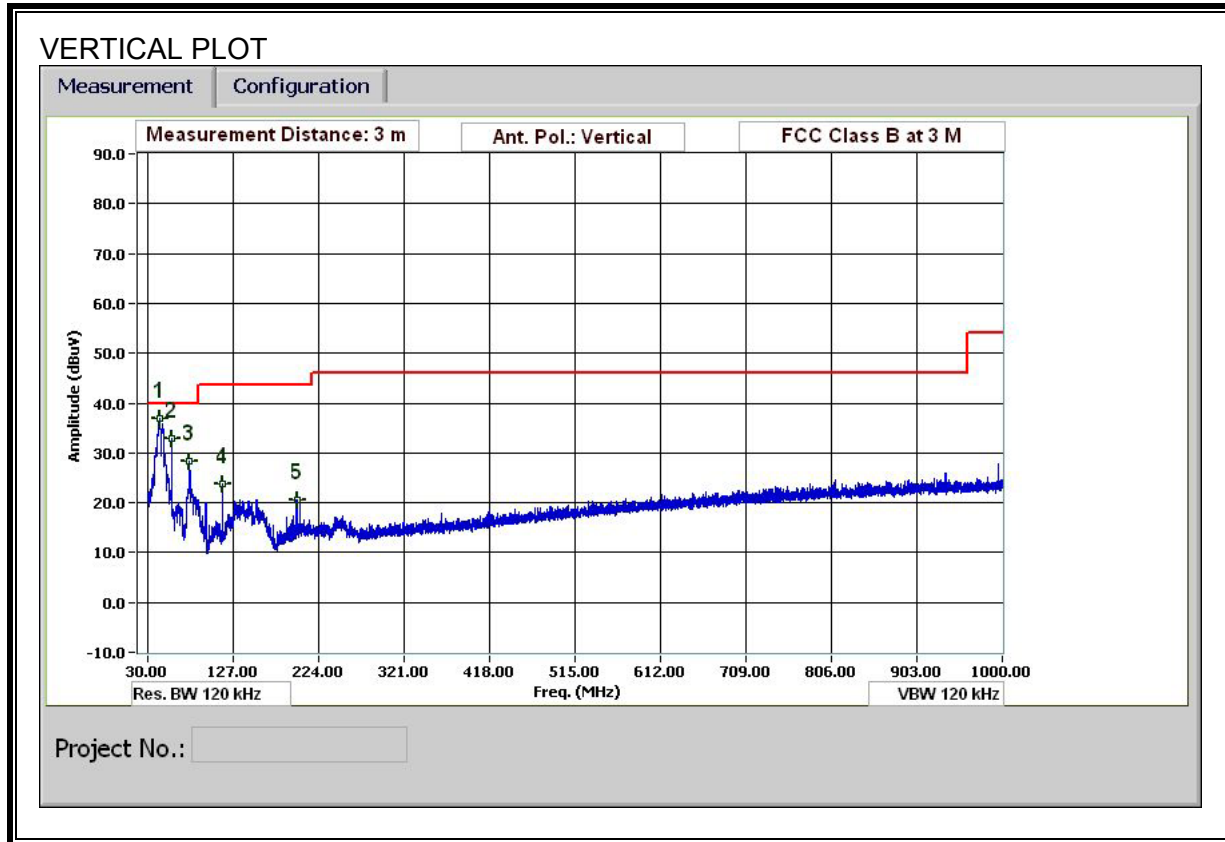

**HORIZONTAL AND VERTICAL DATA**

30-1000MHz Frequency Measurement  
 Compliance Certification Services, Fremont 5m Chamber

Test Engr: Chin Pang  
 Date: 05/19/10  
 Project #: 10U13193  
 Company: Kyocera  
 EUT Description: WiFi + Dual band CDMA phone with bluetooth 2.0 + EDR  
 EUT M/N: SCP-8600  
 Test Target: FCC 15B  
 Mode Oper: TX, BT

f Measurement Frequency Amp Preamp Gain Margin Margin vs. Limit  
 Dist Distance to Antenna D Corr Distance Correct to 3 meters  
 Read Analyzer Reading Filter Filter Insert Loss  
 AF Antenna Factor Corr. Calculated Field Strength  
 CL Cable Loss Limit Field Strength Limit

f MHz	Dist (m)	Read dBuV	AF dB/m	CL dB	Amp dB	D Corr dB	Filter dB	Corr. dBuV/m	Limit dBuV/m	Margin dB	Ant. Pol V/H	Det. P/A/QP	Notes
43.081	3.0	37.7	12.0	0.6	28.4	0.0	0.0	21.9	40.0	-18.1	H	P	
46.681	3.0	40.3	10.0	0.6	28.4	0.0	0.0	22.5	40.0	-17.5	H	P	
57.601	3.0	40.3	8.0	0.7	28.4	0.0	0.0	20.6	40.0	-19.4	H	P	
115.204	3.0	41.8	12.8	1.0	28.3	0.0	0.0	27.2	43.5	-16.3	H	P	
134.404	3.0	36.7	13.4	1.1	28.3	0.0	0.0	22.9	43.5	-20.6	H	P	
202.687	3.0	34.2	12.0	1.3	28.2	0.0	0.0	19.2	43.5	-24.3	H	P	
43.441	3.0	53.0	11.8	0.6	28.4	0.0	0.0	37.0	40.0	-3.0	V	P	
43.441	3.0	50.3	11.8	0.6	28.4	0.0	0.0	34.3	40.0	-5.7	V	QP	
57.601	3.0	52.5	8.0	0.7	28.4	0.0	0.0	32.8	40.0	-7.2	V	P	
76.802	3.0	48.5	7.6	0.8	28.3	0.0	0.0	28.4	40.0	-11.6	V	P	
115.204	3.0	38.4	12.8	1.0	28.3	0.0	0.0	23.9	43.5	-19.6	V	P	
199.087	3.0	35.7	11.9	1.2	28.2	0.0	0.0	20.7	43.5	-22.8	V	P	

## 8. AC POWER LINE CONDUCTED EMISSIONS

### LIMITS

FCC §15.207 (a)

RSS-Gen 7.2.2

Frequency of Emission (MHz)	Conducted Limit (dBuV)	
	Quasi-peak	Average
0.15-0.5	66 to 56*	56 to 46*
0.5-5	56	46
5-30	60	50

\*Decreases with the logarithm of the frequency.

### TEST PROCEDURE

The EUT is placed on a non-conducting table 40 cm from the vertical ground plane and 80 cm above the horizontal ground plane. The EUT is configured in accordance with ANSI C63.4.

The receiver is set to a resolution bandwidth of 9 kHz. Peak detection is used unless otherwise noted as quasi-peak or average.

Line conducted data is recorded for both NEUTRAL and HOT lines.

### RESULTS



**6 WORST EMISSIONS**

CONDUCTED EMISSIONS DATA (115VAC 60Hz)									
Freq. (MHz)	Reading			Class (dB)	Limit QP	EN B AV	Margin		Remark L1 / L2
	PK (dBuV)	QP (dBuV)	AV (dBuV)				QP (dB)	AV (dB)	
0.40	50.28	--	43.28	0.00	57.90	47.90	-7.62	-4.62	L1
0.70	52.94	--	43.77	0.00	56.00	46.00	-3.06	-2.23	L1
2.50	51.69	--	38.85	0.00	56.00	46.00	-4.31	-7.15	L1
0.34	50.45	--	40.52	0.00	59.28	49.28	-8.83	-8.76	L2
0.98	51.18	--	43.63	0.00	56.00	46.00	-4.82	-2.37	L2
2.57	51.65	--	40.09	0.00	56.00	46.00	-4.35	-5.91	L2
6 Worst Data									

**LINE 1 RESULTS**

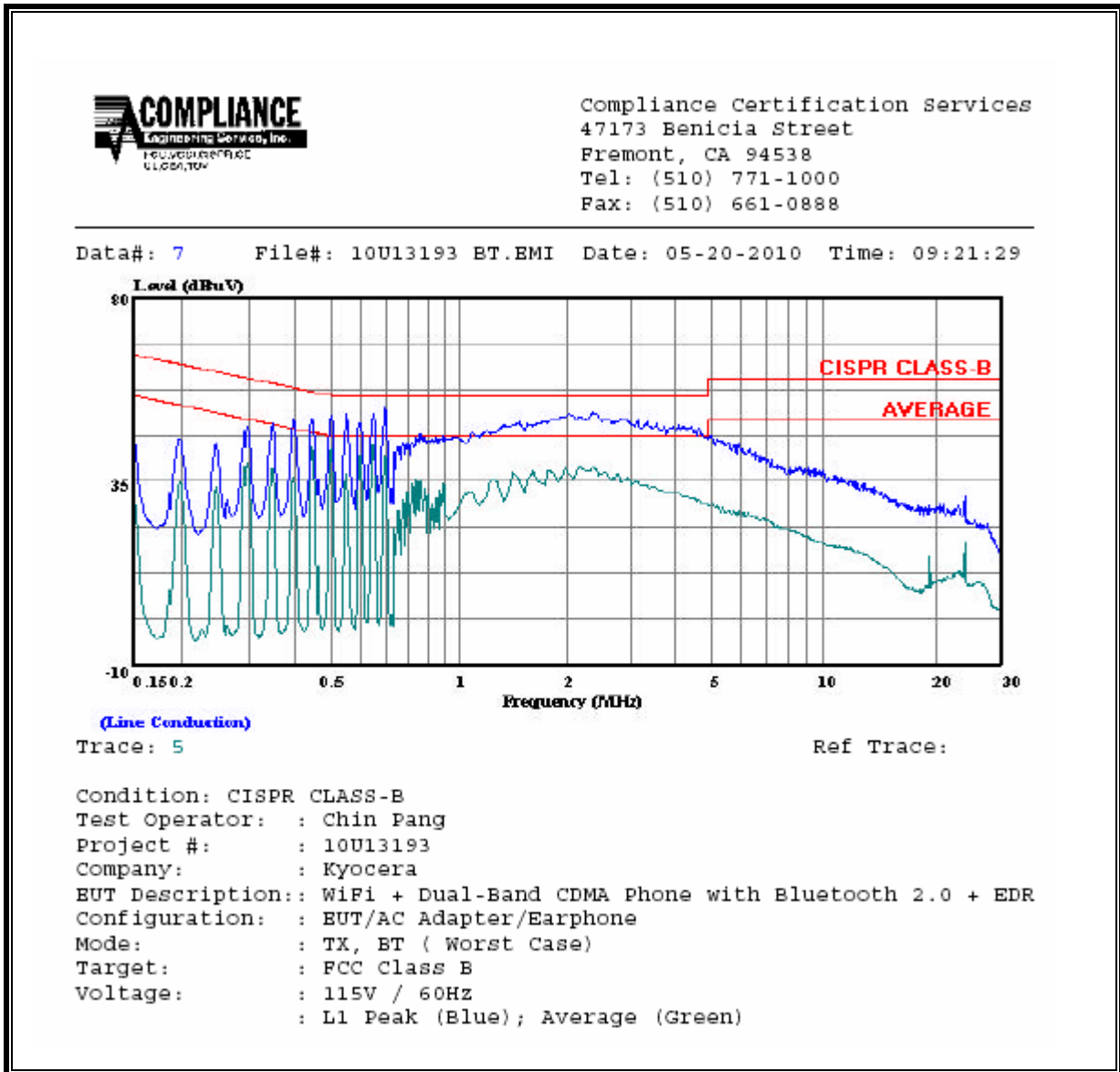

**LINE 2 RESULTS**

