



**FCC CFR47 PART 20.19  
ANSI C63.19-2011**

**HAC T-COIL SIGNAL TEST REPORT**

*For*  
**Tri-Band 1xRTT CDMA with Bluetooth**

**Model: S3150  
FCC ID: V65S3150**

**Report Number: 13U16201-5A**

**Issue Date: 11/12/2013**

*Prepared for*  
**Kyocera Communications  
8611 Balboa Avenue,  
San Diego, CA 92126**

*Prepared by*  
**UL VERIFICATION SERVICES INC.  
47173 BENICIA STREET  
FREMONT, CA 94538, U.S.A.  
TEL: (510) 771-1000  
FAX: (510) 661-0888**



**NVLAP LAB CODE 200065-0**

Revision History

<u>Rev.</u>	<u>Issue Date</u>	<u>Revisions</u>	<u>Revised By</u>
--	10/23/2013	Initial Issue	--
A	11/12/2013	Changed ANSI C63.19-2.11 to ANSI C63.19-2011 in Section 1	Roy Chen

## Table of Contents

<b>1. Attestation of Test Results</b>	<b>4</b>
<b>2. Test Methodology</b>	<b>5</b>
<b>3. Facilities and Accreditation</b>	<b>5</b>
<b>4. Calibration and Uncertainty</b>	<b>6</b>
4.1. <i>Measuring Instrument Calibration</i>	6
4.2. <i>Measurement Uncertainty</i>	7
<b>5. Device Under Test</b>	<b>8</b>
5.1. <i>Air Interfaces and Operating Mode</i>	8
<b>6. Test Procedures</b>	<b>9</b>
<b>7. Establish WD Reference Level</b>	<b>11</b>
<b>8. T-coil Measurement Criteria</b>	<b>13</b>
8.1. <i>Frequency Response</i>	13
8.2. <i>Signal to Noise</i>	14
<b>9. T-coil Test Results</b>	<b>15</b>
9.1. <i>Test Plots (Frequency Response &amp; SNR)</i>	16
<b>10. Appendix</b>	<b>25</b>
10.1. <i>Setup Photo</i>	25
10.2. <i>Calibration Certificate - Magnetic Field Probe AM1DV3 - SN 3083</i>	25

# 1. Attestation of Test Results

Applicant	Kyocera Communications
DUT Description	Tri-Band 1xRTT CDMA with Bluetooth
Model	S3150
Test device is	An identical prototype
Device category	Portable
Exposure category	General Population/Uncontrolled Exposure
Date tested	10/11/2013
HAC rating	T3
Applicable standard	ANSI C63.19-2011
Test Results	Pass

UL Verification Services Inc. tested the above equipment in accordance with the requirements set forth in the above standards. All indications of Pass/Fail in this report are opinions expressed by UL Verification Services Inc. based on interpretations and/or observations of test results. Measurement Uncertainties were not taken into account and are published for informational purposes only. The test results show that the equipment tested is capable of demonstrating compliance with the requirements as documented in this report.

**Note:** The results documented in this report apply only to the tested sample, under the conditions and modes of operation as described herein. This document may not be altered or revised in any way unless done so by UL Verification Services Inc. and all revisions are duly noted in the revisions section. Any alteration of this document not carried out by UL Verification Services Inc. will constitute fraud and shall nullify the document. This report must not be used by the client to claim product certification, approval, or endorsement by NVLAP, NIST, any agency of the Federal Government, or any agency of any government (NIST Handbook 150, Annex A). This report is written to support regulatory compliance of the applicable standards stated above.

Approved & Released By:

Prepared By:



Bobby Bayani  
 WiSE Engineer  
 UL Verification Services Inc.

Roy Chen  
 WiSE Laboratory Technician  
 UL Verification Services Inc.

## 2. Test Methodology

The tests documented in this report were performed in accordance with ANSI C63.19-2011 Methods of Measurement of Compatibility between Wireless Communications Devices and Hearing Aids and FCC published procedure KDB 285076 D01 HAC Guidance v03r02 and KDB 285076 D02 T Coil testing for CMRS IP v01.

## 3. Facilities and Accreditation

The test sites and measurement facilities used to collect data are located at 47173 Benicia Street, Fremont, California, USA.

UL VERIFICATION SERVICES INC. is accredited by NVLAP, Laboratory Code 200065-0. The full scope of accreditation can be viewed at <http://www.ccsemc.com>.

## 4. Calibration and Uncertainty

### 4.1. Measuring Instrument Calibration

The measuring equipment utilized to perform the tests documented in this report has been calibrated in accordance with the manufacturer's recommendations, and is traceable to recognized national standards.

Name of Equipment	Manufacturer	Type/Model	Serial Number	Cal. Due date		
				MM	DD	Year
Robot - Six Axes	Stäubli	TX90 XL	N/A	N/A		
Robot Remote Control	Stäubli	CS8C	N/A	N/A		
DASY5 Measurement Server	SPEAG	SEUMS001BA	1041	N/A		
Probe Alignment Unit	SPEAG	LB (V2)	261	N/A		
Audio Magnetic Measuring Ins.l	SPEAG	AMMI	1127	N/A		
Coordinating Systeml	SPEAG	AMCC	N/A	N/A		
ABM Probe	SPEAG	AM1DV3	3083	1	10	2014
Data Acquisition Electronics	SPEAG	DAE3	500	5	28	2014
Radio Communication Tester	R &S	CMU 200	106301	7	3	2014

## 4.2. Measurement Uncertainty

### Measurement Uncertainty for Audio Band Magnetic Measurement

Error Description	Uncertainty values (%)	Probe Dist.	Div.	c		Std. Unc.	
				AMB1	AMB2	AMB1 (%)	AMB2 (%)
<b>Probe Sensitivity</b>							
Reference level	3.0	N	1	1.00	1.00	3.00	3.00
AMCC geometry	0.4	R	1.73	1.00	1.00	0.23	0.23
AMCC current	0.6	R	1.73	1.00	1.00	0.35	0.35
Probe positioning during calibration	0.1	R	1.73	1.00	1.00	0.06	0.06
Noise contribution	0.7	R	1.73	0.01	1.00	0.01	0.40
Frequency slope	5.9	R	1.73	0.10	1.00	0.34	3.41
<b>Probe System</b>							
Repeatability / drift	1.0	R	1.73	1.00	1.00	0.58	0.58
Linearity / Dynamic range	0.6	R	1.73	1.00	1.00	0.35	0.35
Acoustic noise	1.0	R	1.73	0.10	1.00	0.06	0.58
Probe angle	2.3	R	1.73	1.00	1.00	1.33	1.33
Spectral processing	0.9	R	1.73	1.00	1.00	0.52	0.52
Integration time	0.6	N	1.00	1.00	5.00	0.60	3.00
Field disturbance	0.2	R	1.73	1.00	1.00	0.12	0.12
<b>Test Signal</b>							
Reference signal spectral response	0.6	R	1.73	0.00	1.00	0.00	0.35
<b>Positioning</b>							
Probe positioning	1.9	R	1.73	1.00	1.00	1.10	1.10
Phantom positioning	0.9	R	1.73	1.00	1.00	0.52	0.52
EUT positioning	1.9	R	1.73	1.00	1.00	1.10	1.10
<b>External Contributions</b>							
RF interference	0.0	R	1.73	1.00	1.00	0.00	0.00
Test signal variation	2.0	R	1.73	1.00	1.00	1.15	1.15
<b>Combined Std. Uncertainty (ABM field)</b>						4.02	6.08
<b>Expanded Std. Uncertainty (%)</b>						8.04	12.15
Notes for table							
1. N - Nomal							
2. R - Rectangular							
3. Div. - Divisor used to obtain standard uncertainty							

## 5. Device Under Test

Tri-Band 1xRTT CDMA with Bluetooth S3150	
Normal operation:	Held to head

### 5.1. Air Interfaces and Operating Mode

Air-Interface	Bands (MHz)	Type Transport	HAC Tested	Simultaneous but not Tested	Concurrent HAC Tested or not Tested	Voice over digital Transport OTT Capability	WiFi Low Power	Additional GSM Power Reduction
CDMA	BC0 (850)	VD	Yes	Yes – BT	Not tested <sup>1</sup>	NA	NA	NA
CDMA	BC1 (1900)	VD	Yes	Yes – BT	Not tested <sup>1</sup>	NA	NA	NA
CDMA	BC10 (850)	VD	Yes	Yes -BT	Not tested <sup>1</sup>	NA	NA	NA

Type Transport  
 VO = Voice only  
 DT = Digital Transport  
 VD = CMRS and Data transport (HAC Tested)

Note:  
 1. No concurrent mode was found to be the Worst Case mode



## 6. Test Procedures

ANSI C63.19-2011, Section 7

This document describes the procedures used to measure the ABM (T-Coil) performance of the WD. In addition to measuring the absolute signal levels, the A-weighted magnitude of the unintended signal shall also be determined. In order to assure that the required signal quality is measured, the measurement of the intended signal and the measurement of the unintended signal must be made at the same location for all measurement positions. In addition, the RF field strength at each measurement location must be at or below that required for the assigned category.

Measurements shall not include undesired properties from the WD's RF field; therefore, use of a coaxial connection to a base station simulator or non-radiating load may be necessary. However, even then with a coaxial connection to a base station simulator or non-radiating load there may still be RF leakage from the WD, which may interfere with the desired measurement. Pre-measurement checks should be made to avoid this possibility. All measurements shall be done with the WD operating on battery power with an appropriate normal speech audio signal input level given in Table 7.1. If the device display can be turned off during a phone call then that may be done during the measurement as well.

Measurements shall be performed at two locations specified in A.3, with the correct probe orientation for a particular location, in a multistage sequence by first measuring the field intensity of the desired T-Coil signal (ABM1) that is useful to a hearing aid T-Coil. The undesired magnetic components (ABM2) must be measured at the same location as the desired ABM or T-Coil signal (ABM1), and the ratio of desired to undesired ABM signals must be calculated. For the perpendicular field location, only the ABM1 frequency response shall be determined in a third measurement stage. The flow chart in Figure 7.3 illustrates this three-stage, two orientation process.

The following steps summarize the basic test flow for determining ABM1<sup>1</sup> and ABM2<sup>2</sup>. These steps assume that a sine wave or narrowband 1/3 octave signal can be used for the measurement of ABM1.

- a) A validation of the test setup and instrumentation may be performed using a TMFS or Helmholtz coil. Measure the emissions and confirm that they are within the specified tolerance.
- b) Position the WD in the test setup and connect the WD RF connector to a base station simulator or a non-radiating load as shown in Figure 7.1 or Figure 7.2. Confirm that equipment that requires calibration has been calibrated, and that the noise level meets the requirements given in 7.3.1.
- c) The drive level to the WD is set such that the reference input level specified in Table 7.1 is input to the base station simulator (or manufacturer's test mode equivalent) in the 1 kHz, 1/3 octave band. This drive level shall be used for the T-Coil signal test (ABM1) at  $f = 1$  kHz. Either a sine wave at 1025 Hz or a voice-like signal, band-limited to the 1 kHz 1/3 octave, as defined in 7.4.2, shall be used for the reference audio signal. If interference is found at 1025 Hz an alternative nearby reference audio signal frequency may be used.<sup>46</sup> The same drive level will be used for the ABM1 frequency response measurements at each 1/3 octave band center frequency. The WD volume control may be set at any level up to maximum, provided that a signal at any frequency at maximum modulation would not result in clipping or signal overload.
- d) Determine the magnetic measurement locations for the WD device (A.3), if not already specified by the manufacturer, as described in 7.4.4.1.1 and 7.4.4.2.

---

<sup>1</sup> **Audio Band Magnetic signal - desired (ABM1):** Measured quantity of the desired magnetic signal

<sup>2</sup> **Audio Band Magnetic signal - undesired (ABM2):** Measured quantity of the undesired magnetic signal, such as interference from battery current and similar non-signal elements.

- e) At each measurement location, measure and record the desired T-Coil magnetic signals (ABM1 at  $f_i$ ) as described in 7.4.4.2 in each individual ISO 266-1975 R10 standard 1/3 octave band. The desired audio band input frequency ( $f_i$ ) shall be centered in each 1/3 octave band maintaining the same drive level as determined in item c) and the reading taken for that band.

Equivalent methods of determining the frequency response may also be employed, such as fast Fourier transform (FFT) analysis using noise excitation or input–output comparison using simulated speech. The full-band integrated or half-band integrated probe output, as specified in D.9, may be used, as long as the appropriate calibration curve is applied to the measured result, so as to yield an accurate measurement of the field magnitude. (The resulting measurement shall be an accurate measurement in dB A/m.)

All measurements of the desired signal shall be shown to be of the desired signal and not of an undesired signal. This may be shown by turning the desired signal ON and OFF with the probe measuring the same location. If the scanning method is used the scans shall show that all measurement points selected for the ABM1 measurement meet the ambient and test system noise criteria in 7.3.1.

- f) At the measurement location for each orientation, measure and record the undesired broadband audio magnetic signal (ABM2) as specified in 7.4.4.4 with no audio signal applied (or digital zero applied, if appropriate) using A-weighting and the half-band integrator. Calculate the ratio of the desired to undesired signal strength (i.e., signal quality).
- g) Obtain the data from the postprocessor, SEMCAD, and determine the category that properly classifies the signal quality based on Table 8.5.

Test Setup Diagram

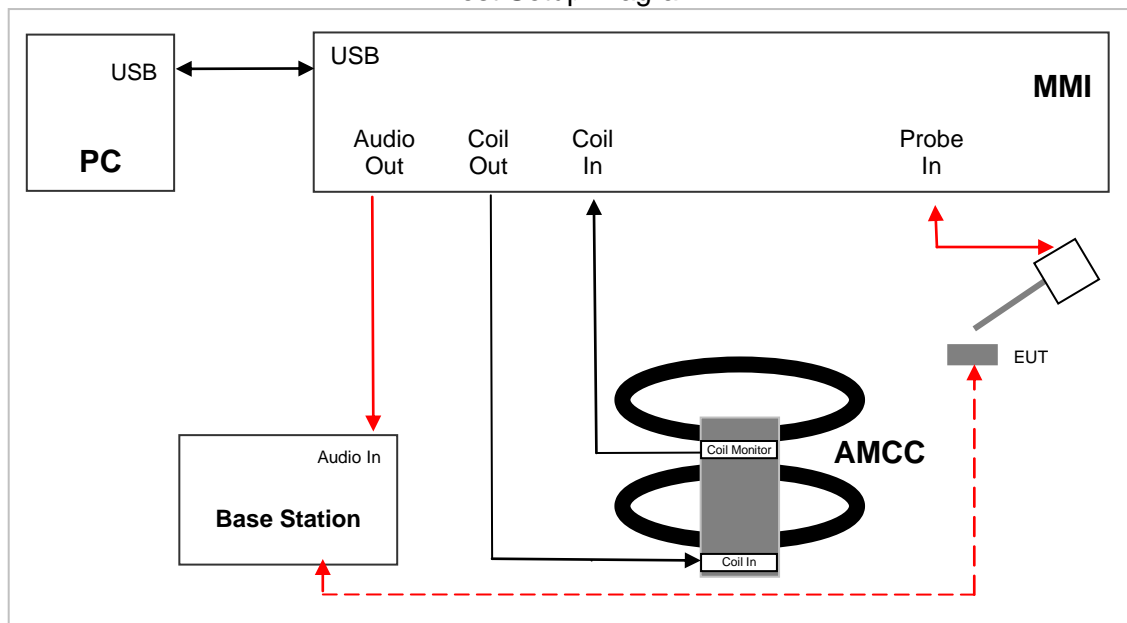

## 7. Establish WD Reference Level

First step is to find the Uref, which is 1 kHz signal output of the CMU200. The following figures show the setup for the measurements. The first step is to measure Uref and the following step is to measure U, which is the signal from AMMI to the CMU200 during testing.

The setup shown below is used to measure Uref. To measure the reference input level, first connect the Coil In of the AMMI to the Audio Out of the CMU200 (as indicated by the figure below). Then establish a conducted link between the EUT and the CMU200. Once the link is established, select the network tab of the CMU200 and change the bitstream setting to decoder cal in order for the CMU to produce the necessary calibration 1 kHz signal. Record the value from the Dasy4 file and use this value as Uref.

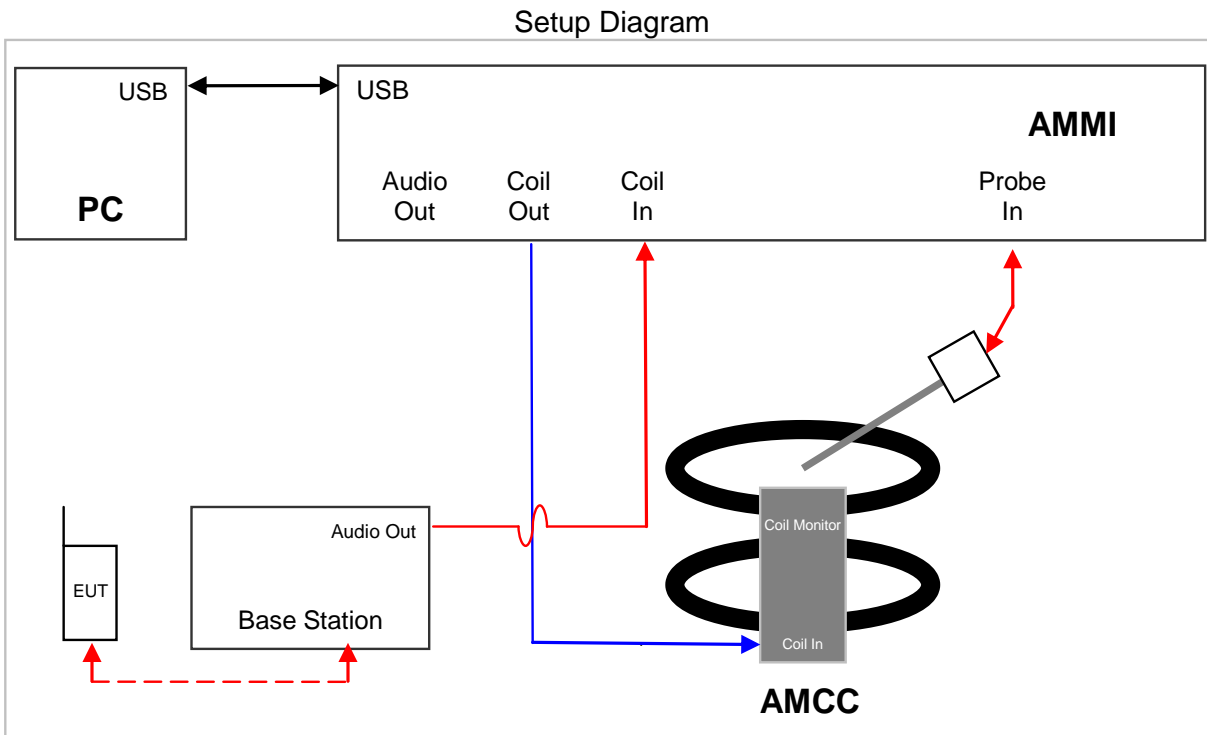

Next step is to measure U, which is the signal from AMMI to the CMU200 during testing. The following setup is used to measure U for narrow band (Voice1.025 kHz) and broad band (300 Hz – 300 kHz) signals:

To determine the DASY gain setting necessary to achieve the proper EUT signal level, connect the Coil In of AMMI to the Audio Out of AMMI. Run the narrow band job (Voice 1.025kHz signal setting) from DASY4 and record the RMS coil signal. Adjust the gain of the signal by changing the gain value within the particular DASY job until the coil signal reading is that of the desired output signal level. Repeat this step for the broad band job (Voice 300 – 3kHz signal).

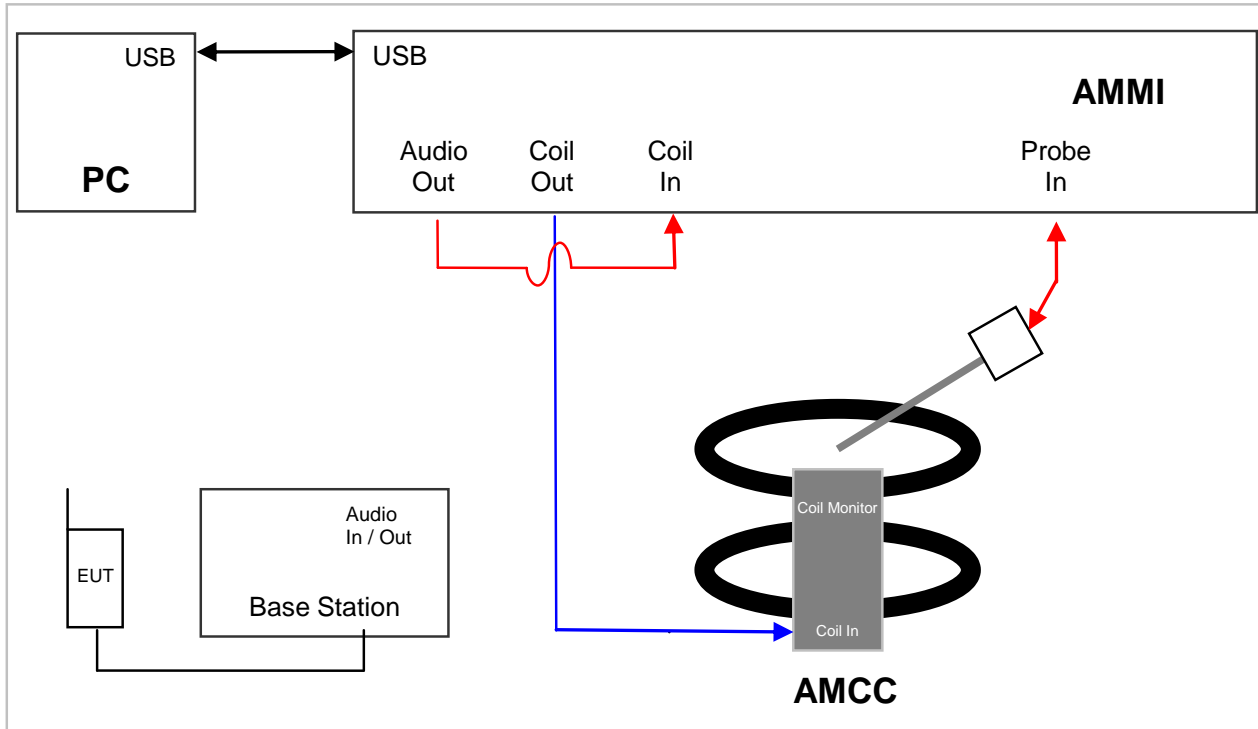

Measured Input Level is calculated:  $Measured\_Input\_Level = 20 * \log\left(\frac{U}{U_{ref}}\right)$

**RESULTS**

**CDMA2000**

**1 kHz Signal**

Applied Signal	RMS V	Result Input Level (dBm0)	Reference Input Level (dBm0)
U	0.095	-18.0	CDMA -18.0
U <sub>ref</sub>	0.750		GSM -16.0

Adjusted Gain Setting	RMS dB V
27.98	-20.460
N/A	-2.497

**300 Hz-3 kHz Signal**

Applied Signal	RMS V	Measured Input Level (dBm0)	Reference Input Level (dBm0)
U	0.095	-18.0	CDMA -18.0
U <sub>ref</sub>	0.750		GSM -16.0

Gain Setting	RMS dB V
55.22	-20.451
N/A	-2.497

## 8. T-coil Measurement Criteria

### 8.1. Frequency Response

The frequency response of the axial component of the magnetic field, measured in 1/3 octave bands, shall follow the response curve, over the frequency range 300 Hz to 3000 Hz.

Figure 8.1 and Figure 8.2 provide the boundaries for the specified frequency. These response curves are for true field strength measurements of the T-Coil signal. Thus the 6 dB/octave probe response has been corrected from the raw readings.

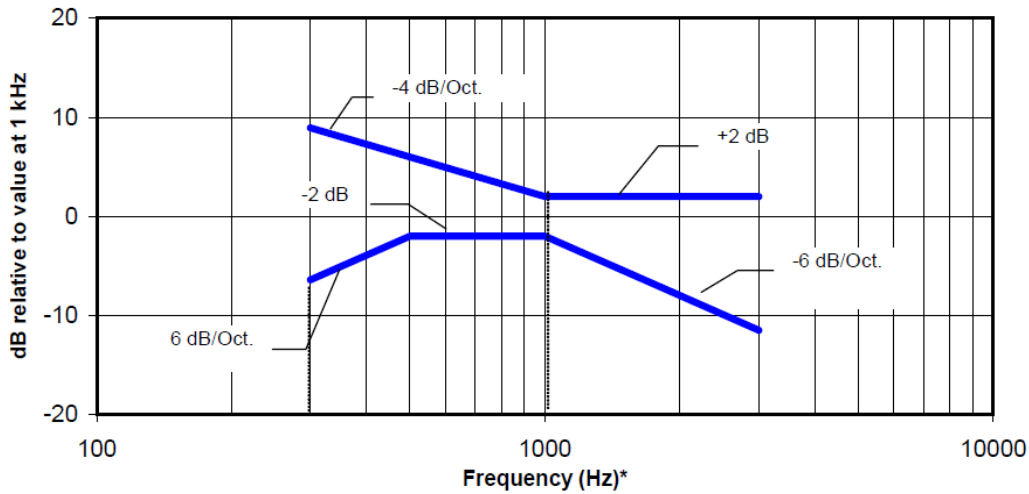

NOTE—The frequency response is between 300 Hz and 3000 Hz.

**Figure 8.1—Magnetic field frequency response for WDs with field strength  $\leq -15$  dB (A/m) at 1 kHz**

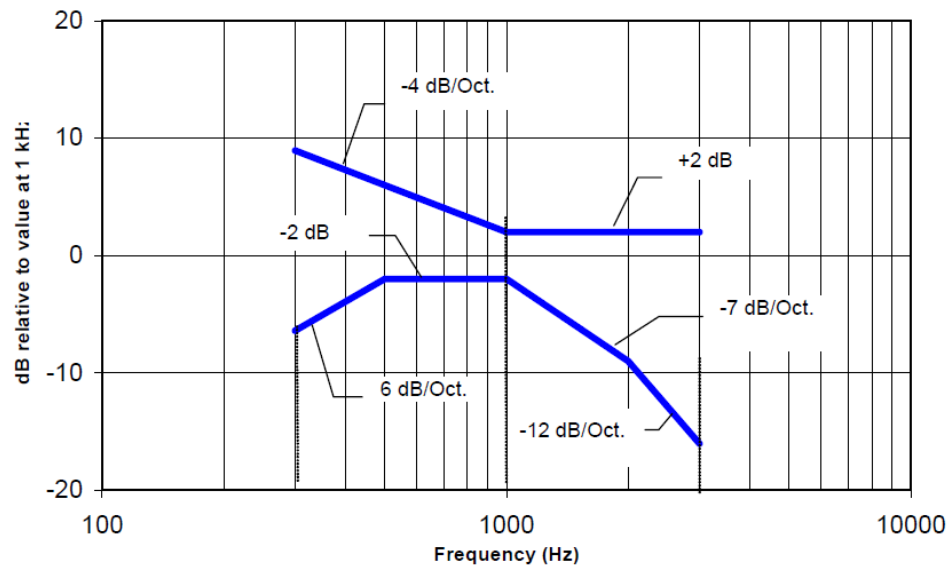

NOTE—The frequency response is between 300 Hz and 3000 Hz.

**Figure 8.2—Magnetic field frequency response for WDs with a field that exceeds  $-15$  dB(A/m) at 1 kHz**

## 8.2. Signal to Noise

This specifies the signal-to-noise quality requirement for the intended T-Coil signal from a WD. The worst signal to noise of the two T-Coil signal measurements, as determined in Clause 7, shall be used to determine the T-Coil mode category per Table 8.5.

Only the RF immunity of the hearing aid is measured in T-Coil mode. It is assumed that a hearing aid can have no immunity to an interference signal in the audio band, which is the intended reception band for this mode. So, the only criterion that can be measured is the RF immunity in T-Coil Mode. This is measured using the same procedure as for the audio coupling mode and at the same levels as specified in 6.4.

**Table 8.5—T-Coil signal-to-noise categories**

<b>Category</b>	<b>Telephone parameters WD signal quality [(signal + noise)-to-noise ratio in decibels]</b>
Category T1	0 dB to 10 dB
Category T2	10 dB to 20 dB
Category T3	20 dB to 30 dB
Category T4	>30 dB

### 9. T-coil Test Results

Mode	Ch. No/Freq.	Probe orientation	ABM1 $\geq -16$ dB (A/m)	BWC Factor (dB)	ABM SNR (dB)	T-Rating
CDMA2000 BC0 RC1/SO3 Voice Coder: 8k Enhanced (Low)	384/ 836.52 MHz	z (Axial):	-13.18	0.16	32.56	T4
		y (transversal):	-22.59	0.16	26.52	T3
CDMA2000 BC1 RC1/SO3 Voice Coder: 8k Enhanced (Low)	600/ 1880 MHz	z (Axial):	-12.87	0.16	32.41	T4
		y (transversal):	-20.73	0.16	28.34	T3
CDMA2000 BC10 RC1/SO3 Voice Coder: 8k Enhanced (Low)	580/ 820.50	z (Axial):	-17.05	0.16	30.49	T4
		y (transversal):	-22.16	0.16	27.00	T3

**Note:**

The radial longitudinal (x axis) measurements are no longer required per ANSI C63.19-2011

Measurement locations and reference plane to be used for the T-coil measurements

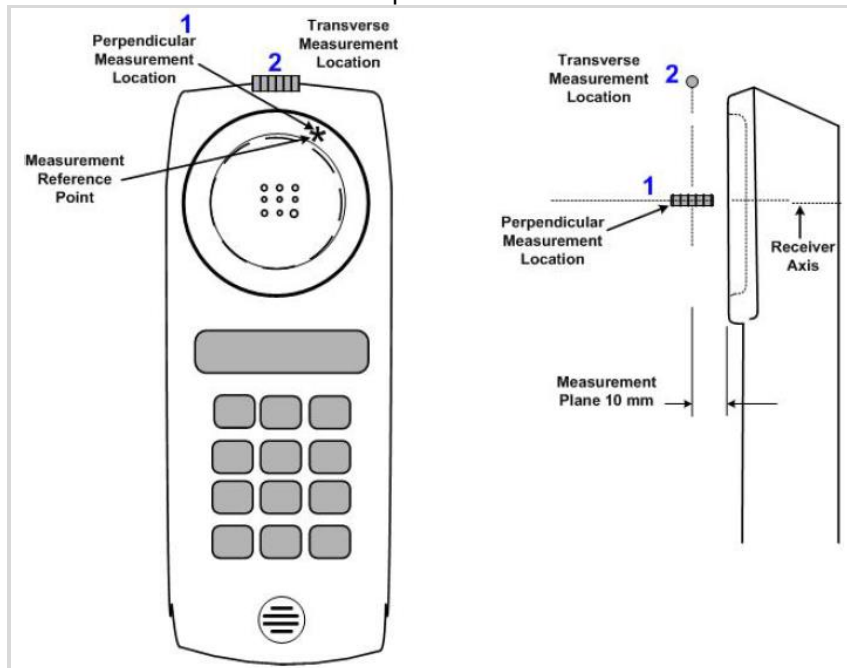

## 9.1. Test Plots (Frequency Response & SNR)

### Test Plots for CDMA2000 BC0

Freq. Resp.

Test Laboratory: UL Verification Services Inc. SAR Lab C

Date: 10/15/2013

### CDMA 2000 BC0

Communication System: UID 0, CDMA2000; Frequency: 836.52 MHz; Duty Cycle: 1:1

**T-Coil scan (scan for ANSI C63.19-2007 & 2011 compliance)/General Scans ch 384/z (axial) wideband at best S/N/ABM Freq Resp(x,y,z,f) (1x1x1):** Measurement grid: dx=10mm, dy=10mm

Signal Type: Audio File (.wav) 48k\_voice\_300-3000\_2s.wav

Output Gain: 55.22

Measure Window Start: 300ms

Measure Window Length: 2000ms

BWC applied: 10.80 dB

Device Reference Point: 0, 0, -6.3 mm

Category	Telephone parameters WD signal quality [(signal+noise)-to-noise ratio in decibels]
Category T1	0 dB to 10 dB
Category T2	10 dB to 20 dB
Category T3	20 dB to 30 dB
Category T4	> 30 dB

**Cursor:**

Diff = 1.86 dB

BWC Factor = 10.80 dB

Location: 1.7, -0.1, 3.7 mm

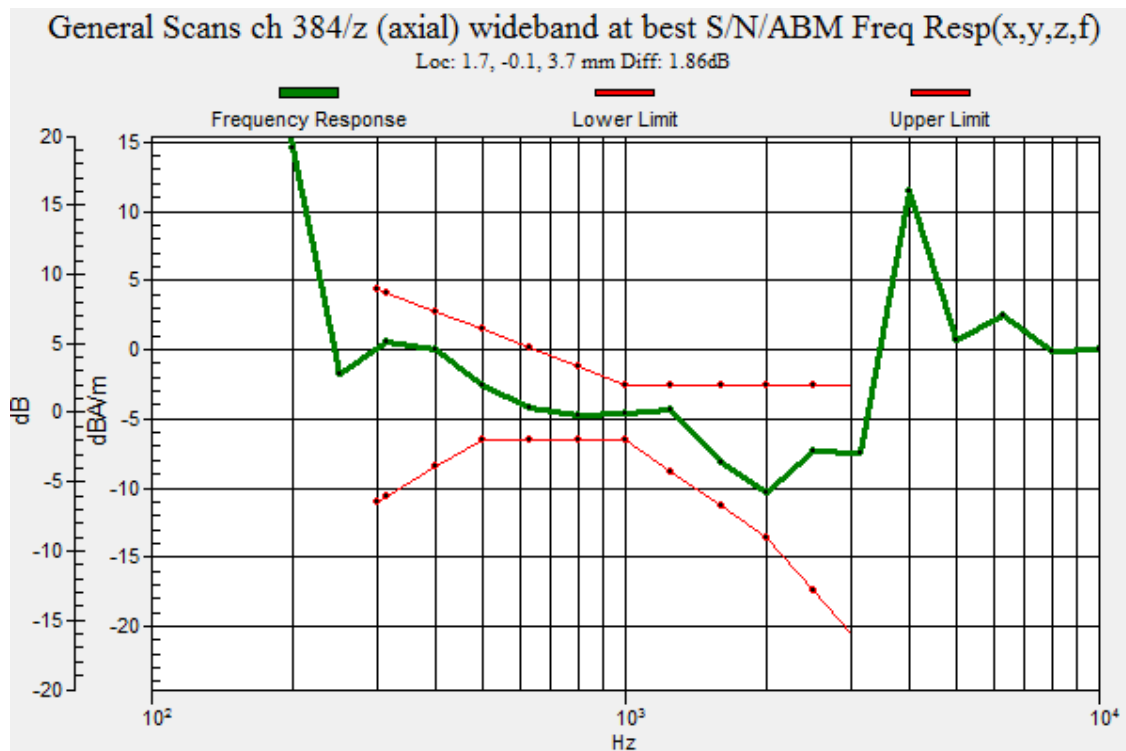



Z (Axial)

Test Laboratory: UL Verification Services Inc. SAR Lab C

Date: 10/11/2013

**CDMA 2000 BC0**

Communication System: UID 0, CDMA2000; Frequency: 836.52 MHz; Duty Cycle: 1:1

Phantom section: TCoil Section

DASY5 Configuration:

- Probe: AM1DV3 - 3083; ; Calibrated: 1/10/2013
- Sensor-Surface: 0mm (Fix Surface)
- Electronics: DAE3 Sn500; Calibrated: 5/28/2013
- Phantom: HAC Test Arch with AMCC; Type: SD HAC P01 BB
- Measurement SW: DASY52, Version 52.8 (7); SEMCAD X Version 14.6.10 (7164)

**T-Coil scan (scan for ANSI C63.19-2007 & 2011 compliance)/General Scans ch 384/z (axial) 4.2mm 50 x 50/ABM Interpolated SNR(x,y,z) (121x121x1):** Interpolated grid: dx=1.000 mm, dy=1.000 mm

Signal Type: Audio File (.wav) 48k\_voice\_1kHz\_1s.wav  
Output Gain: 27.98  
Measure Window Start: 300ms  
Measure Window Length: 1000ms  
BWC applied: 0.16 dB  
Device Reference Point: 0, 0, -6.3 mm

**Cursor:**

ABM1/ABM2 = 32.56 dB  
ABM1 comp = -13.18 dBA/m  
BWC Factor = 0.16 dB  
Location: 1.7, 0, 3.7 mm

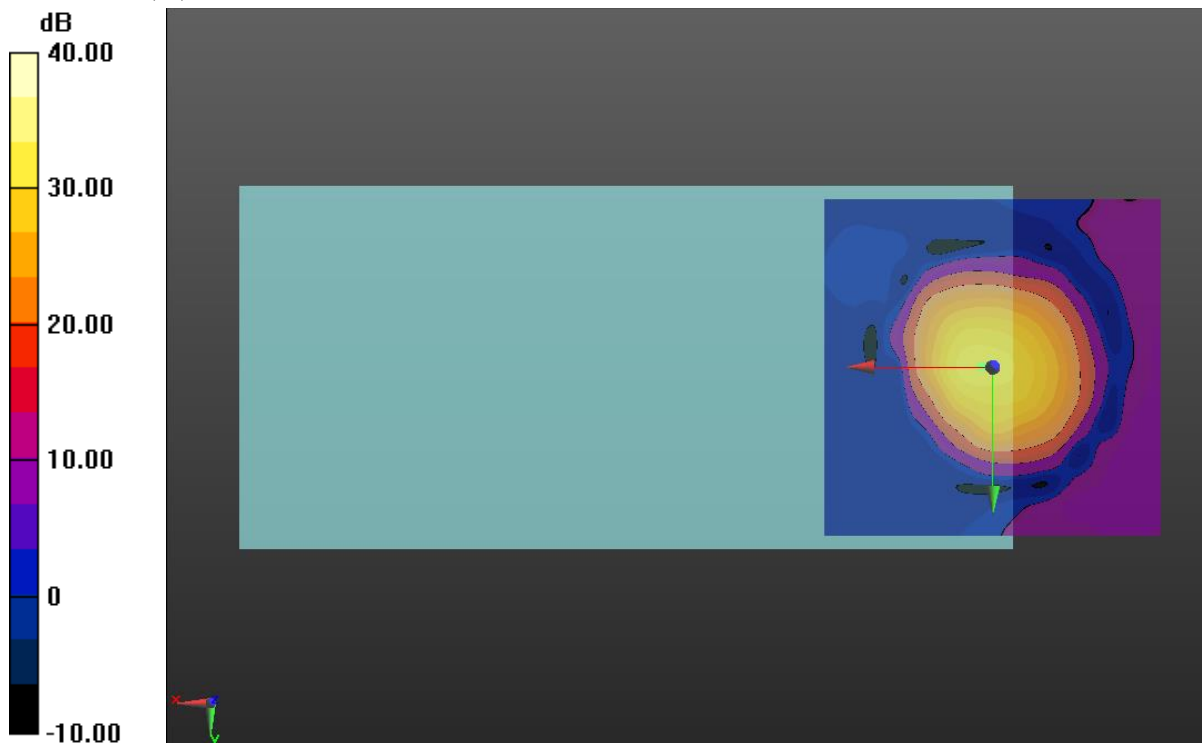

0 dB = 1.000 = 0.00 dB

Y (Transversal)

Test Laboratory: UL Verification Services Inc. SAR Lab C

Date: 10/11/2013

**CDMA 2000 BC0**

Communication System: UID 0, CDMA2000; Frequency: 836.52 MHz; Duty Cycle: 1:1

Phantom section: TCoil Section

DASY5 Configuration:

- Probe: AM1DV3 - 3083; ; Calibrated: 1/10/2013
- Sensor-Surface: 0mm (Fix Surface)
- Electronics: DAE3 Sn500; Calibrated: 5/28/2013
- Phantom: HAC Test Arch with AMCC; Type: SD HAC P01 BB
- Measurement SW: DASY52, Version 52.8 (7);SEMCAD X Version 14.6.10 (7164)

**T-Coil scan (scan for ANSI C63.19-2007 & 2011 compliance)/General Scans ch 384/y (transversal) 4.2mm 50 x 50/ABM Interpolated SNR(x,y,z) (121x121x1):** Interpolated grid:

dx=1.000 mm, dy=1.000 mm

Signal Type: Audio File (.wav) 48k\_voice\_1kHz\_1s.wav

Output Gain: 27.98

Measure Window Start: 300ms

Measure Window Length: 1000ms

BWC applied: 0.16 dB

Device Reference Point: 0, 0, -6.3 mm

**Cursor:**

ABM1/ABM2 = 26.52 dB

ABM1 comp = -22.59 dBA/m

BWC Factor = 0.16 dB

Location: -3.7, -8.3, 3.7 mm

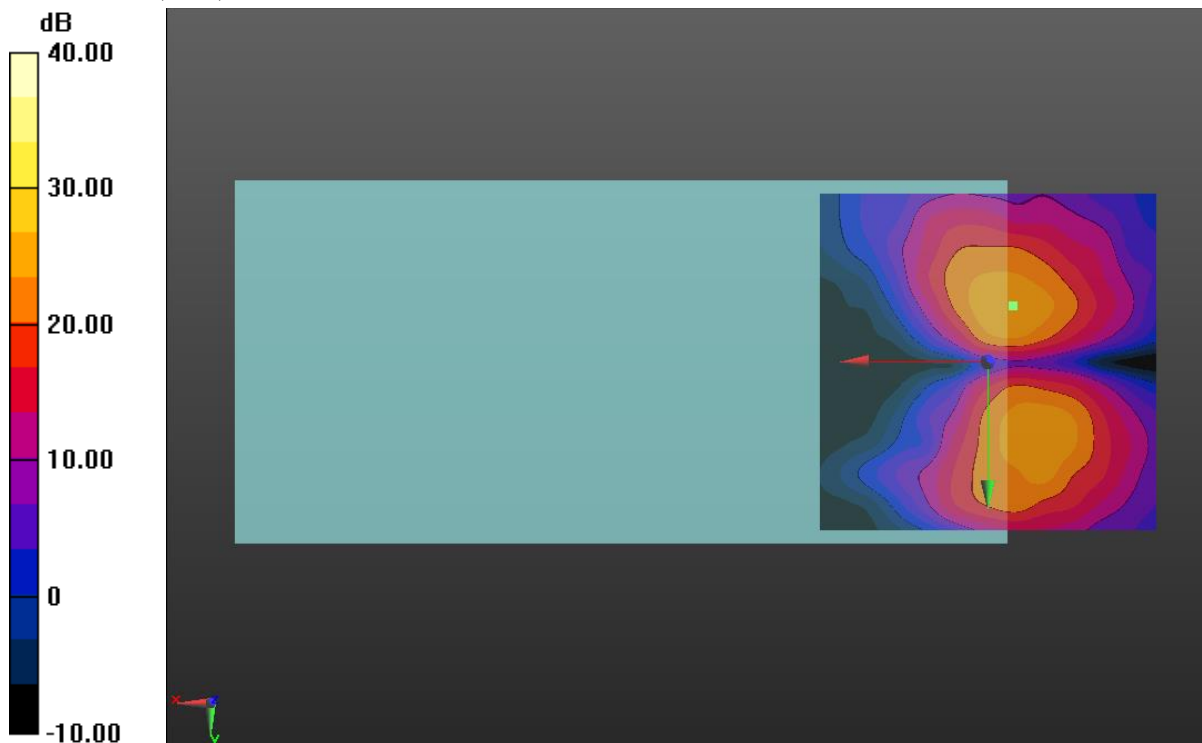

0 dB = 1.000 = 0.00 dB

**Test Plots for CDMA2000 BC1**

Freq. Resp.

Test Laboratory: UL Verification Services Inc. SAR Lab C

Date: 10/15/2013

**CDMA 2000 BC1**

Communication System: UID 0, CDMA2000 (0); Frequency: 1880 MHz;Duty Cycle: 1:1

**T-Coil scan (scan for ANSI C63.19-2007 & 2011 compliance)/General Scans ch 600/z (axial) wideband at best S/N/ABM Freq Resp(x,y,z,f) (1x1x1):** Measurement grid: dx=10mm, dy=10mm

Signal Type: Audio File (.wav) 48k\_voice\_300-3000\_2s.wav

Output Gain: 55.22

Measure Window Start: 300ms

Measure Window Length: 2000ms

BWC applied: 10.80 dB

Device Reference Point: 0, 0, -6.3 mm

Category	Telephone parameters WD signal quality [(signal+noise)-to-noise ratio in decibels]
Category T1	0 dB to 10 dB
Category T2	10 dB to 20 dB
Category T3	20 dB to 30 dB
Category T4	> 30 dB

**Cursor:**

Diff = 1.25 dB

BWC Factor = 10.80 dB

Location: 1.6, 0.3, 3.7 mm

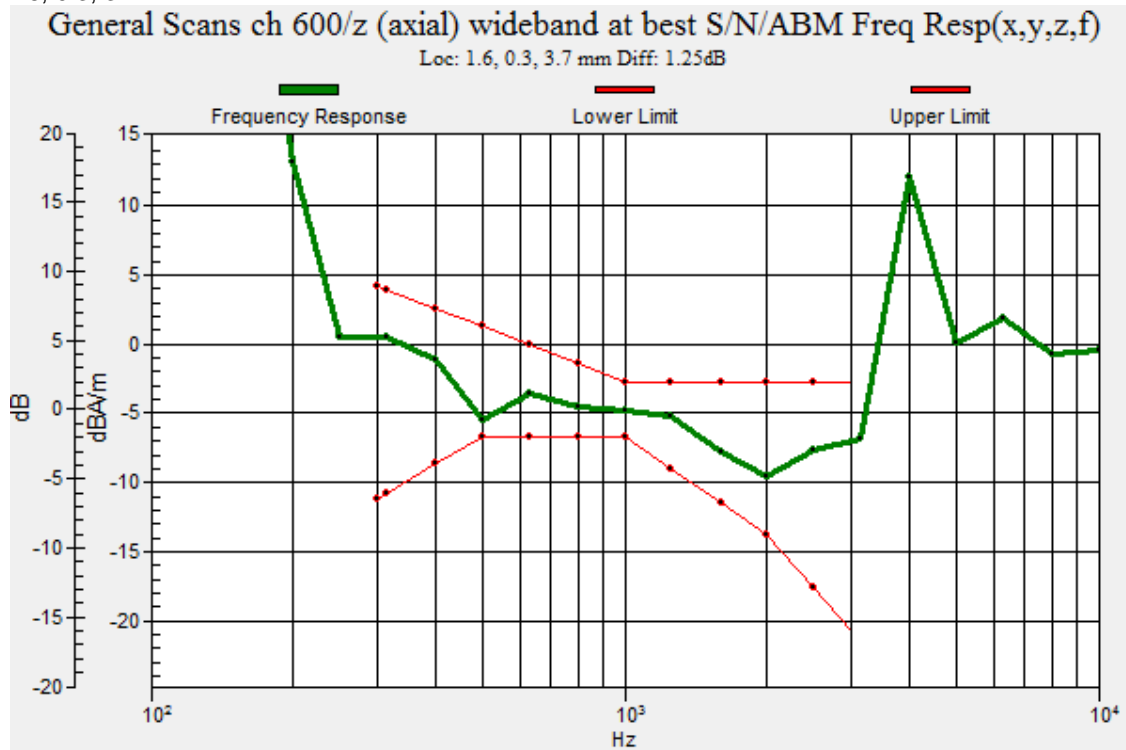

Z (Axial)

Test Laboratory: UL Verification Services Inc. SAR Lab C

Date: 10/11/2013

**CDMA 2000 BC1**

Communication System: UID 0, CDMA2000 (0); Frequency: 1880 MHz; Duty Cycle: 1:1

Phantom section: TCoil Section

DASY5 Configuration:

- Probe: AM1DV3 - 3083; ; Calibrated: 1/10/2013
- Sensor-Surface: 0mm (Fix Surface)
- Electronics: DAE3 Sn500; Calibrated: 5/28/2013
- Phantom: HAC Test Arch with AMCC; Type: SD HAC P01 BB
- Measurement SW: DASY52, Version 52.8 (7);SEMCAD X Version 14.6.10 (7164)

**T-Coil scan (scan for ANSI C63.19-2007 & 2011 compliance)/General Scans ch 600/z (axial) 4.2mm 50 x 50/ABM Interpolated SNR(x,y,z) (121x121x1):** Interpolated grid: dx=1.000 mm, dy=1.000 mm

Signal Type: Audio File (.wav) 48k\_voice\_1kHz\_1s.wav  
Output Gain: 27.98  
Measure Window Start: 300ms  
Measure Window Length: 1000ms  
BWC applied: 0.16 dB  
Device Reference Point: 0, 0, -6.3 mm

**Cursor:**

ABM1/ABM2 = 32.41 dB  
ABM1 comp = -12.87 dBA/m  
BWC Factor = 0.16 dB  
Location: 1.7, 0.4, 3.7 mm

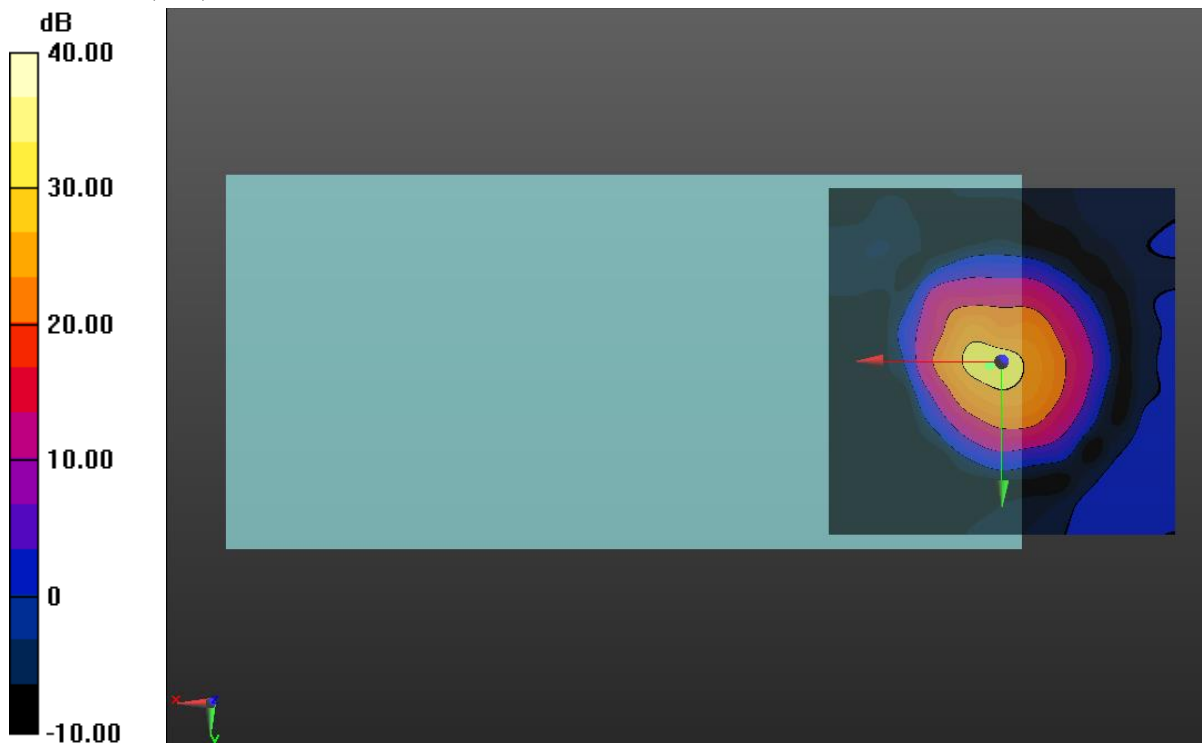

0 dB = 1.000 = 0.00 dB

Y (Transversal)

Test Laboratory: UL Verification Services Inc. SAR Lab C

Date: 10/11/2013

### CDMA 2000 BC1

Communication System: UID 0, CDMA2000 (0); Frequency: 1880 MHz; Duty Cycle: 1:1

Phantom section: TCoil Section

DASY5 Configuration:

- Probe: AM1DV3 - 3083; ; Calibrated: 1/10/2013
- Sensor-Surface: 0mm (Fix Surface)
- Electronics: DAE3 Sn500; Calibrated: 5/28/2013
- Phantom: HAC Test Arch with AMCC; Type: SD HAC P01 BB
- Measurement SW: DASY52, Version 52.8 (7); SEMCAD X Version 14.6.10 (7164)

### T-Coil scan (scan for ANSI C63.19-2007 & 2011 compliance)/General Scans ch 600/y (transversal) 4.2mm 50 x 50/ABM Interpolated SNR(x,y,z) (121x121x1): Interpolated grid:

dx=1.000 mm, dy=1.000 mm

Signal Type: Audio File (.wav) 48k\_voice\_1kHz\_1s.wav

Output Gain: 27.98

Measure Window Start: 300ms

Measure Window Length: 1000ms

BWC applied: 0.16 dB

Device Reference Point: 0, 0, -6.3 mm

#### Cursor:

ABM1/ABM2 = 28.34 dB

ABM1 comp = -20.73 dBA/m

BWC Factor = 0.16 dB

Location: -0.8, -8.8, 3.7 mm

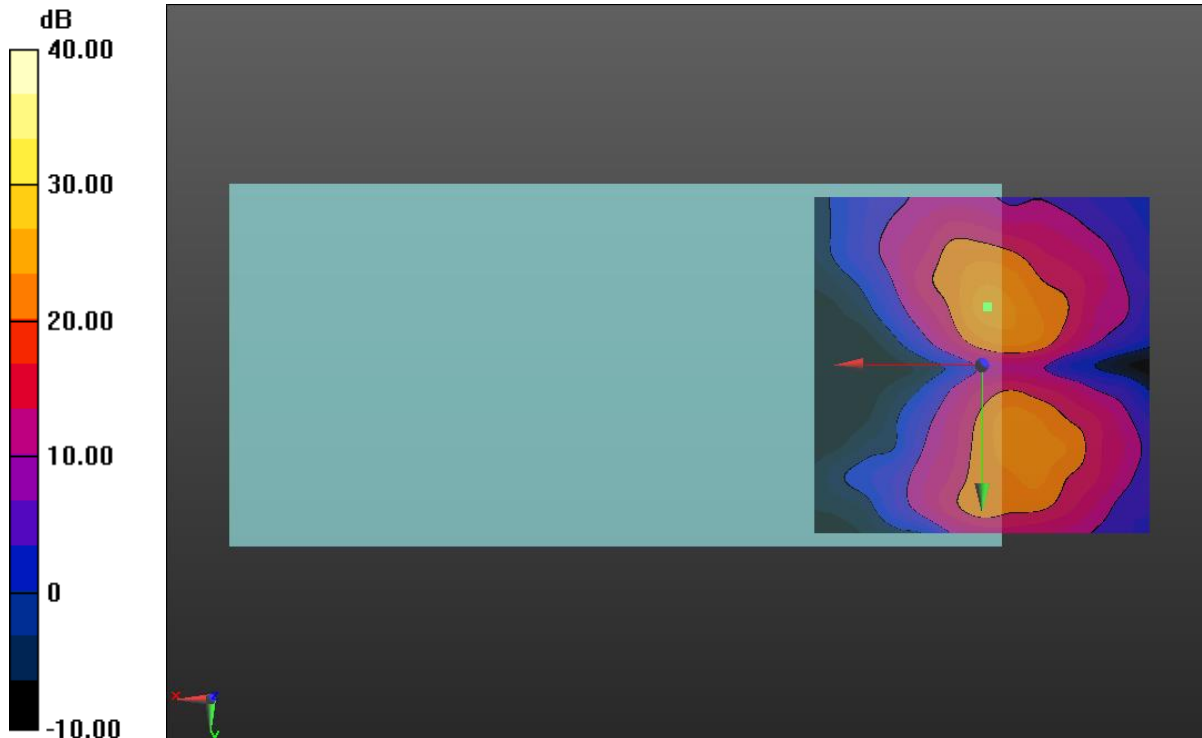

0 dB = 1.000 = 0.00 dB

**Test Plots for CDMA2000 BC10**

Freq. Resp.

Test Laboratory: UL Verification Services Inc. SAR Lab C

Date: 10/15/2013

**CDMA 2000 BC10**

Communication System: UID 0, CDMA2000 (0); Frequency: 820.5 MHz; Duty Cycle: 1:1

**T-Coil scan (scan for ANSI C63.19-2007 & 2011 compliance)/General Scans ch 580/z (axial) wideband at best S/N/ABM Freq Resp(x,y,z,f) (1x1x1):** Measurement grid: dx=10mm, dy=10mm

Signal Type: Audio File (.wav) 48k\_voice\_300-3000\_2s.wav

Output Gain: 55.22

Measure Window Start: 300ms

Measure Window Length: 2000ms

BWC applied: 10.80 dB

Device Reference Point: 0, 0, -6.3 mm

Category	Telephone parameters WD signal quality [(signal+noise)-to-noise ratio in decibels]
Category T1	0 dB to 10 dB
Category T2	10 dB to 20 dB
Category T3	20 dB to 30 dB
Category T4	> 30 dB

**Cursor:**

Diff = 2.00 dB

BWC Factor = 10.80 dB

Location: 3.4, -2.4, 3.7 mm

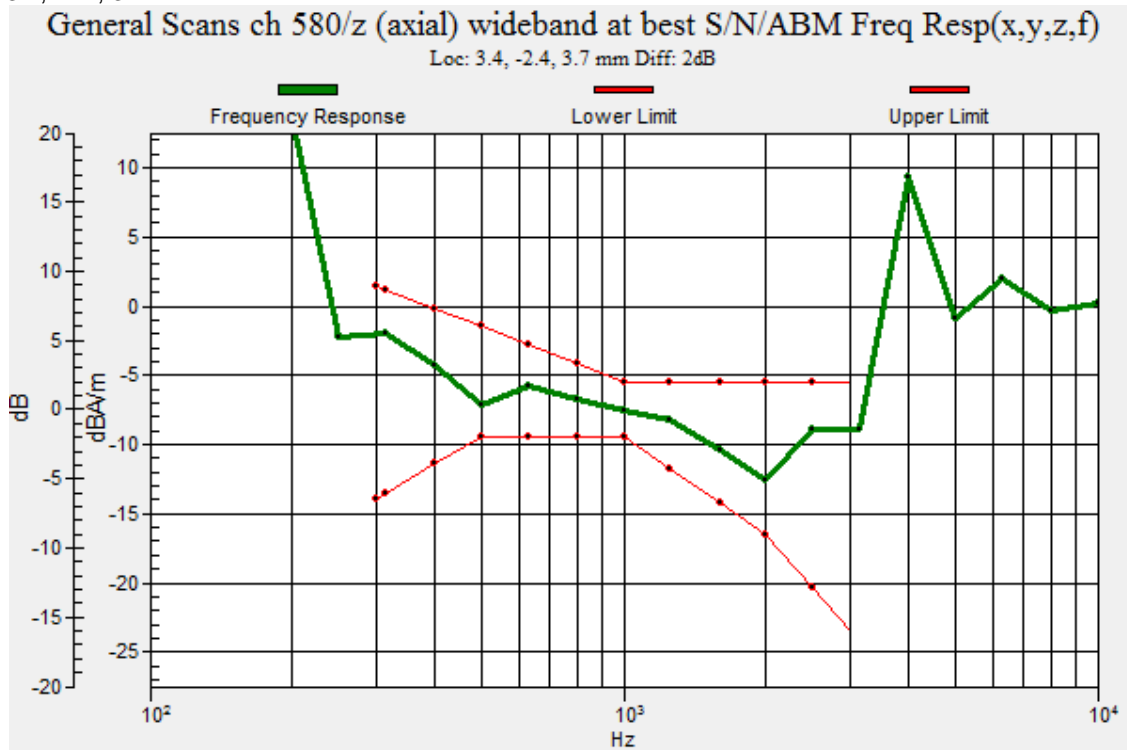

Z (Axial)

Test Laboratory: UL Verification Services Inc. SAR Lab C

Date: 10/11/2013

**CDMA 2000 BC10**

Communication System: UID 0, CDMA2000 (0); Frequency: 820.5 MHz; Duty Cycle: 1:1

Phantom section: TCoil Section

DASY5 Configuration:

- Probe: AM1DV3 - 3083; ; Calibrated: 1/10/2013
- Sensor-Surface: 0mm (Fix Surface)
- Electronics: DAE3 Sn500; Calibrated: 5/28/2013
- Phantom: HAC Test Arch with AMCC; Type: SD HAC P01 BB
- Measurement SW: DASY52, Version 52.8 (7); SEMCAD X Version 14.6.10 (7164)

**T-Coil scan (scan for ANSI C63.19-2007 & 2011 compliance)/General Scans ch 580/z (axial) 4.2mm 50 x 50/ABM Interpolated SNR(x,y,z) (121x121x1):** Interpolated grid: dx=1.000 mm, dy=1.000 mm

Signal Type: Audio File (.wav) 48k\_voice\_1kHz\_1s.wav  
Output Gain: 27.98  
Measure Window Start: 300ms  
Measure Window Length: 1000ms  
BWC applied: 0.16 dB  
Device Reference Point: 0, 0, -6.3 mm

**Cursor:**

ABM1/ABM2 = 30.49 dB  
ABM1 comp = -17.05 dBA/m  
BWC Factor = 0.16 dB  
Location: 3.3, -2.5, 3.7 mm

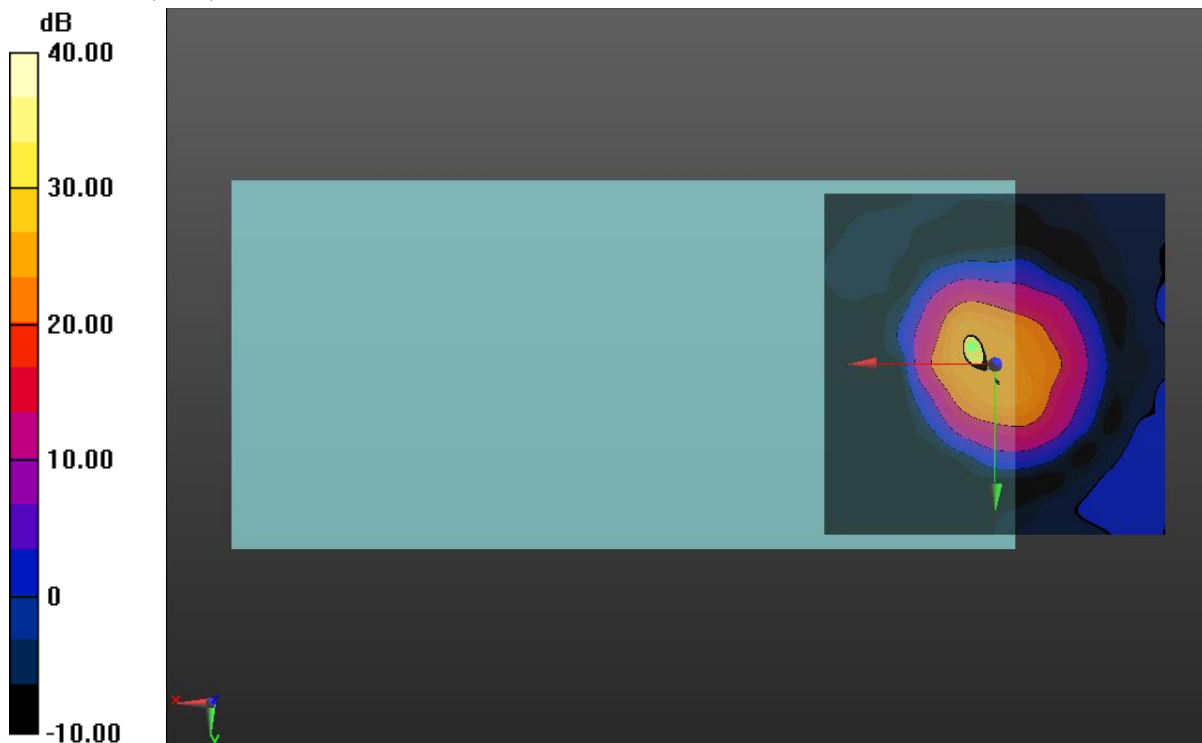

0 dB = 1.000 = 0.00 dB

Y (Transversal)

Test Laboratory: UL Verification Services Inc. SAR Lab C

Date: 10/11/2013

**CDMA 2000 BC10**

Communication System: UID 0, CDMA2000 (0); Frequency: 820.5 MHz; Duty Cycle: 1:1

Phantom section: TCoil Section

DASY5 Configuration:

- Probe: AM1DV3 - 3083; ; Calibrated: 1/10/2013
- Sensor-Surface: 0mm (Fix Surface)
- Electronics: DAE3 Sn500; Calibrated: 5/28/2013
- Phantom: HAC Test Arch with AMCC; Type: SD HAC P01 BB
- Measurement SW: DASY52, Version 52.8 (7);SEMCAD X Version 14.6.10 (7164)

**T-Coil scan (scan for ANSI C63.19-2007 & 2011 compliance)/General Scans ch 580/y (transversal) 4.2mm 50 x 50/ABM Interpolated SNR(x,y,z) (121x121x1):** Interpolated grid:

dx=1.000 mm, dy=1.000 mm

Signal Type: Audio File (.wav) 48k\_voice\_1kHz\_1s.wav

Output Gain: 27.98

Measure Window Start: 300ms

Measure Window Length: 1000ms

BWC applied: 0.16 dB

Device Reference Point: 0, 0, -6.3 mm

**Cursor:**

ABM1/ABM2 = 27.00 dB

ABM1 comp = -22.16 dBA/m

BWC Factor = 0.16 dB

Location: -4.2, -7.5, 3.7 mm

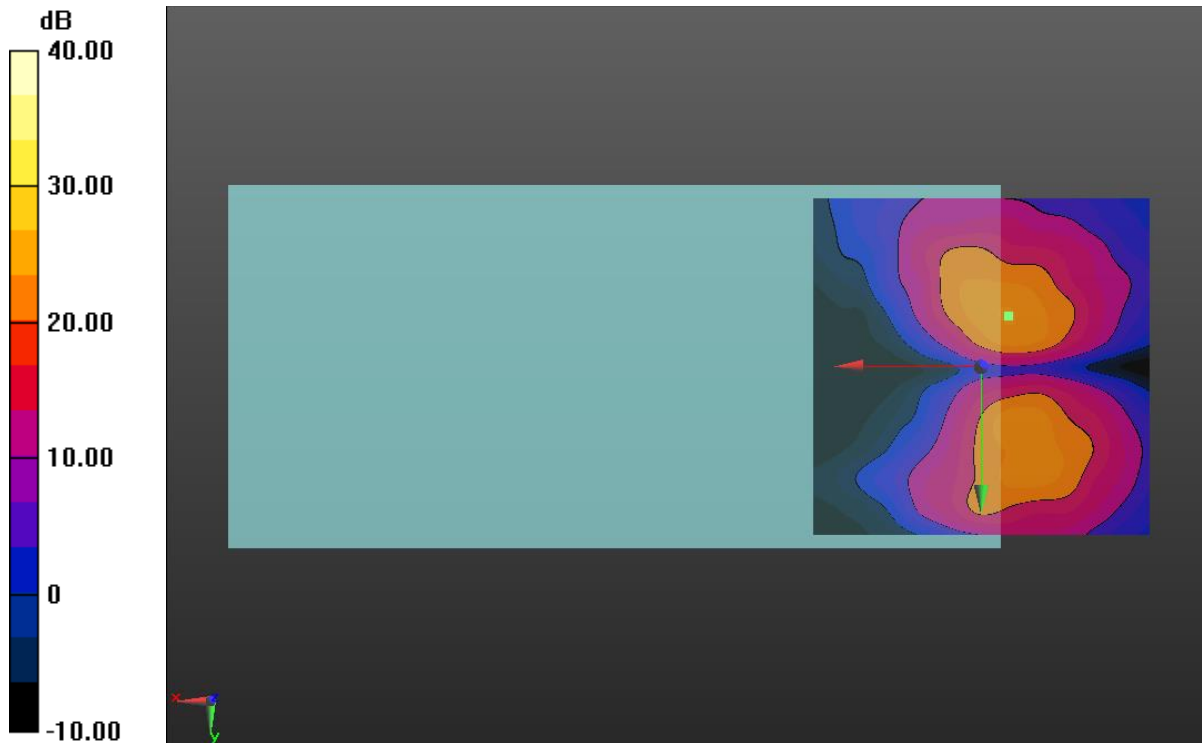

0 dB = 1.000 = 0.00 dB



## **10. Appendix**

**10.1. Setup Photo**

**10.2. Calibration Certificate - Magnetic Field Probe AM1DV3 - SN 3083**

**END OF REPORT**