

Applicant:	Kyocera
FCC ID:	V65S3015
Report #:	CT-S3015-90-0711-R0

RF Emissions Test Report

FCC Part 90

For

Kyocera Corporation
c/o Kyocera Communication Inc.

Product:	CDMA Phone
Model:	S3015

TABLE OF CONTENTS

1 SUMMARY OF TESTING 4

2 EQUIPMENT UNDER TEST INFORMATION..... 4

3 TEST FACILITIES..... 5

4 TEST SETUP 5

 4.1 Test Configuration 5

5 Conducted RF OUTPUT POWER..... 6

 5.1 Test Configuration 6

 5.2 Test Results..... 6

6 RADIATED RF OUTPUT POWER 6

 6.1 Test Configuration 6

7 OCCUPIED BANDWIDTH 7

 7.1 Test Configuration 7

 7.2 Test Result 7

8 EMISSION MASK 8

 8.1 Test Configuration 8

 8.2 Test Result 8

9 Spurious Emissions At Antenna Terminals 10

 9.1 Test Configuration 10

 9.2 Test Result 10

10 Transmitter Radiated Spurious Emissions 12

11 Transmitter RF Carrier Frequency Stability..... 12

 11.1 Test Configuration 12

 11.2 Test Result 13

12 Exposure of Humans to RF Fields (SAR) 14

 12.1 Test Configuration and Result 14

13 TEST EQUIPMENT..... 14



Applicant:	Kyocera
FCC ID:	V65S3015
Report #:	CT-S3015-90-0711-R0

ATTESTATION

The tested device complies with the requirements in respect of all parameters subject to the test.

The test results and statements relate only to the items tested.

The test equipment used was suitable for the tests performed and within manufacturer's published specifications and operating parameters.

The test methods were consistent with the methods described in the relevant standards.

Product:	CDMA Phone with Bluetooth
Model #:	S3015
FCC ID:	V65S3015
Tested in accordance with:	FCC Part 90
Test performed by:	CompTest Services LLC
Test Requested by:	Kyocera Corporation c/o Kyocera Communication Inc 8611 Balboa Ave., San Diego, CA 92123 United States
Date of Test:	July 10, 2011

Responsible Engineer

Benjamin Nguyen

Benjamin Nguyen
Test Engineer

Reviewed and approved by:

Tammy To
Quality Manager

1 SUMMARY OF TESTING

Section #	Rule Part	Test Description	Verdict
5	FCC § 2.1046	Conducted Power	Pass
6	FCC § 90.635 (b)	Radiated Power	Pass
7	FCC § 2.1049, 90.691	Occupied Bandwidth	Pass
8	FCC § 2.1051, 90.691	Emission Mask	Pass
9	FCC § 2.1051, 90.691	Spurious Emissions at Antenna Terminals	Pass
10	FCC § 2.1053, 90.691	Transmitter Radiated Spurious Emissions	Pass
11	FCC § 2.1055, 90.213	Transmitter RF Carrier Frequency Stability	Pass
12	FCC § 2.1093	Exposure of Humans to RF Fields	Pass

2 EQUIPMENT UNDER TEST INFORMATION

EUT Serial Number:	268435457816722940
Type:	[] Prototype, [X] Pre-Production, [] Production
Equipment Category:	Portable
RF Exposure Environment:	General Population / Uncontrolled
Antenna:	Internal Antenna
Detachable Antenna:	No
External Input:	Audio/Digital Data
Quantity:	Quantity production is planned
Multiple Access Scheme:	CDMA
Emission Designators:	1M25F9W
FCC Rule Parts:	§90.691
Modes:	800 CDMA BC-10
TX Frequency (MHz):	817.9 – 823.1
Conducted Output Power (dBm):	24.5

3 TEST FACILITIES

The test sites and measurement facilities used to collect data are located at 8611 Balboa Ave., San Diego, CA 92123, USA

4 TEST SETUP

All CDMA measurements were conducted with a base station simulator to establish a CDMA link with the equipment under test (EUT). To investigate the response of the EUT the main antenna RF output port of the EUT was connected to the input of the spectrum analyzer with a RF cable. The amplitude of the spectrum analyzer is corrected for the cable insertion loss and any other applicable losses. A fully charged battery was used as a power supply voltage, except for the Transmitter RF Carrier Frequency Stability test a dummy battery connected to a power supply was used.

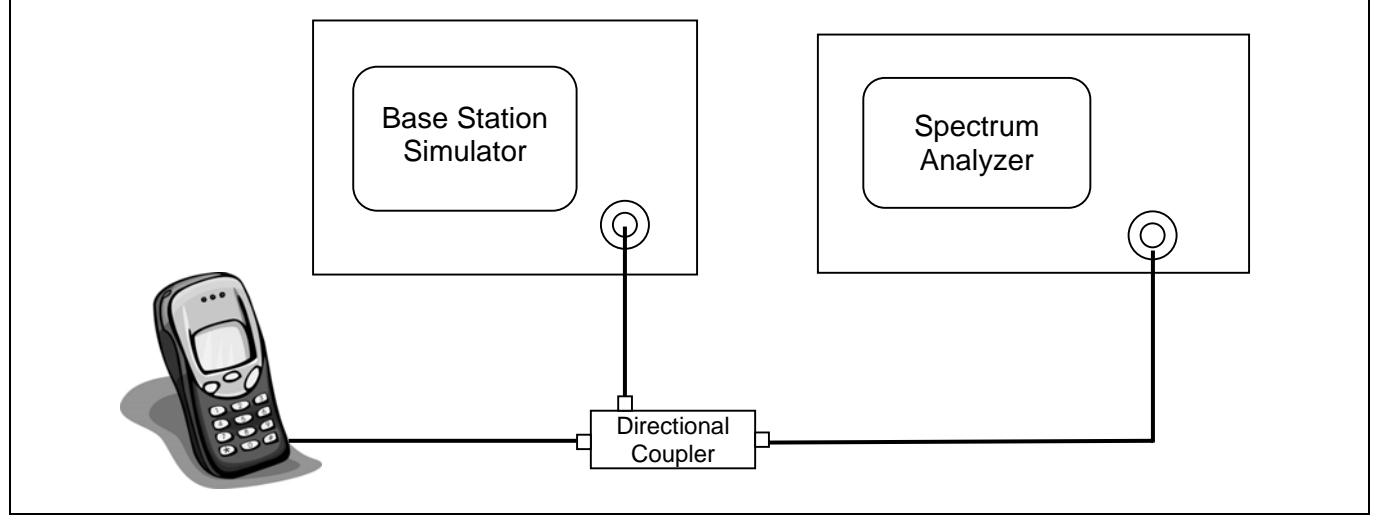

4.1 Test Configuration

To justify on the selection of applicable configurations, the EUT was pre-tested under all Radio Configuration and Service Option operation modes to determine the worst-case scenario. The following configuration was determined and reported as worst-case for all measurements:

Radio Configuration:	RC1
Service Options:	SO55
Data Rate:	Full Rate
Reference:	RF Exposure Report

5 CONDUCTED RF OUTPUT POWER

5.1 Test Configuration

FCC: § 2.1046, § 90.635

IC: --

The EUT was connected to a Power Meter through a RF cable. The cable loss was taken into account for accurate power measurement. The EUT was set at low, mid, high channels and each frequency band to investigate the conducted power.

5.2 Test Results

Mode	Channel	Frequency (MHz)	Conducted Power (dBm)
CDMA 800 BC-10	476	817.9	24.60
	580	820.5	24.64
	684	823.1	24.75

6 RADIATED RF OUTPUT POWER

6.1 Test Configuration

FCC: § 90.635

IC: --

The test was performed in UL Compliance Certification Service using substitution method. See separated radiated emission report for details.

ERP Limit: <100 Watts

7 OCCUPIED BANDWIDTH

7.1 Test Configuration

FCC: § 2.1049, § 90.691
IC: --

The RF output of the EUT was connected to the input of the spectrum analyzer (S.A.) with sufficient attenuation. The spectrum with no modulation was recorded.

For Digital: Modulate with full rate all up power control bit.

S.A. Setting	RBW	VBW	Span	Measurement ch
Bandwidth Measurement	30KHz	300kHz	3 MHz	Highest Conducted Power

Limits: N/A

7.2 Test Result

Figure	Description	Mode	Result
7-1	Occupied Bandwidth @ Ch476	CDMA 800 BC-10	Pass

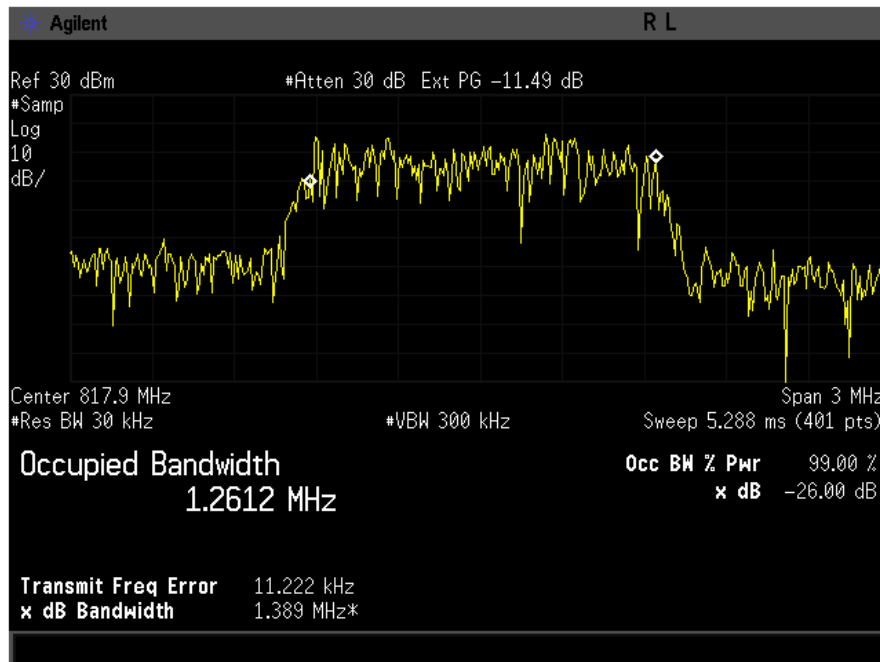

Figure 7-1 CDMA 800 BC-10 @ CH 476

8 EMISSION MASK

8.1 Test Configuration

FCC: § 2.1051, § 90.691

IC: --

The RF output of the EUT was connected to the input of the spectrum analyzer (S.A.) with sufficient attenuation. The spectrum with no modulation was recorded.

For Digital: Modulate with full rate all up power control bit.

S.A. Setting	RBW	VBW	Span	Measurement ch
Emission Mask	30KHz	30KHz	3 MHz	476 and 684

Limits:

For any frequency removed from the EA licensee’s frequency block by up to and including 37.5 kHz, the power of any emission shall be attenuated below the transmitter power (P) in watts by at least 116 Log₁₀(f/6.1) dB or 50 + 10 Log₁₀(P) dB, whichever is the lesser attenuation, where f is the frequency removed from the center of the outer channel in the block in kHz and where f is greater than 12.5 kHz.

Limit Level: -20dBm

8.2 Test Result

Figure	Description	Mode	Result
8-1	Lower Band Edge @ Ch 476	CDMA 800 BC-10	Pass
8-2	Upper Band Edge @ Ch 684		Pass



Applicant:	Kyocera
FCC ID:	V65S3015
Report #:	CT-S3015-90-0711-R0

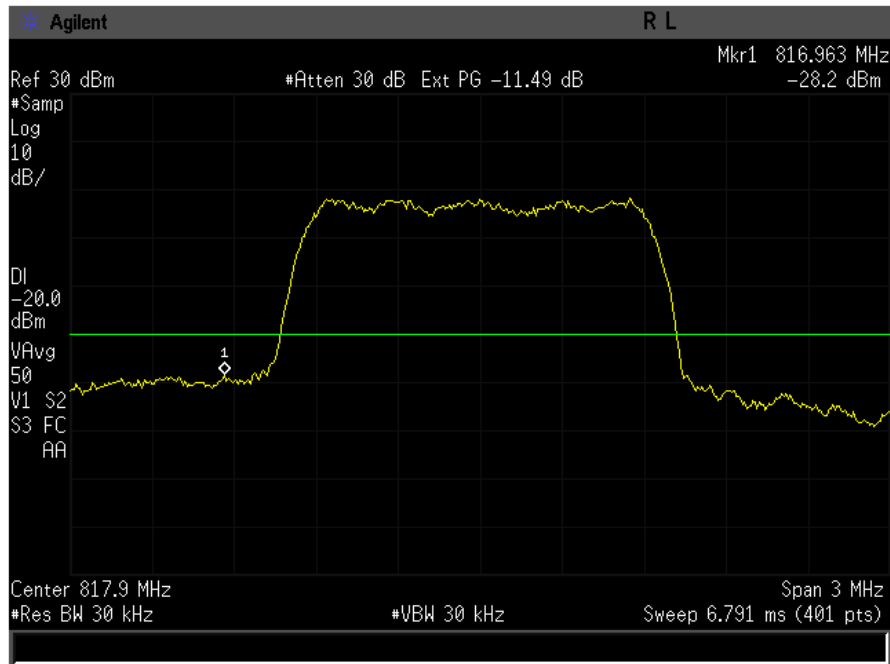

Figure 7-2 CDMA 800 BC-10 Lower Band Edge @ CH 476

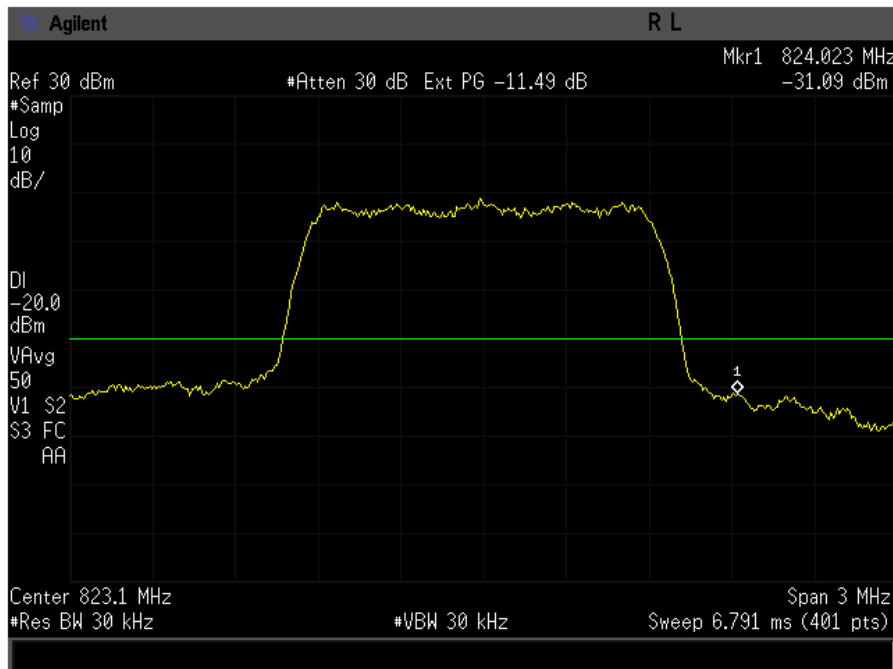

Figure 7-3 CDMA 800 Upper Band Edge @ CH 684

9 SPURIOUS EMISSIONS AT ANTENNA TERMINALS

9.1 Test Configuration

FCC: § 2.1051, § 90.691

IC: --

Measurement Procedures:

Out of Band: The RF output of the EUT was connected to the input of the spectrum analyzer with sufficient attenuation. The modulating signal was applied accordingly. The frequency spectrum was investigated from the lowest frequency signal generated up to at least the 10th harmonic of the fundamental.

S.A. Setting	RBW	VBW	Measurement ch
Spurious Emissions Measurement	1MHz	1MHz	Highest Conducted Power

Limits:

For any frequency removed from the EA licensee's frequency block greater than 37.5 kHz, the power of any emission shall be attenuated below the transmitter power (P) in watts by at least $43 + 10\log_{10}(P)$ dB or 80 dB, whichever is the lesser attenuation, where f is the frequency removed from the center of the outer channel in the block in kHz and where f is greater than 37.5 kHz.

Out of Band Limit: -13dBm

9.2 Test Result

Figure	Channel	Plot Description	Result
9-1	476	CDMA 800 BC-10 Conducted spurious emissions 30MHz to 10GHz	Pass

Applicant:	Kyocera
FCC ID:	V65S3015
Report #:	CT-S3015-90-0711-R0

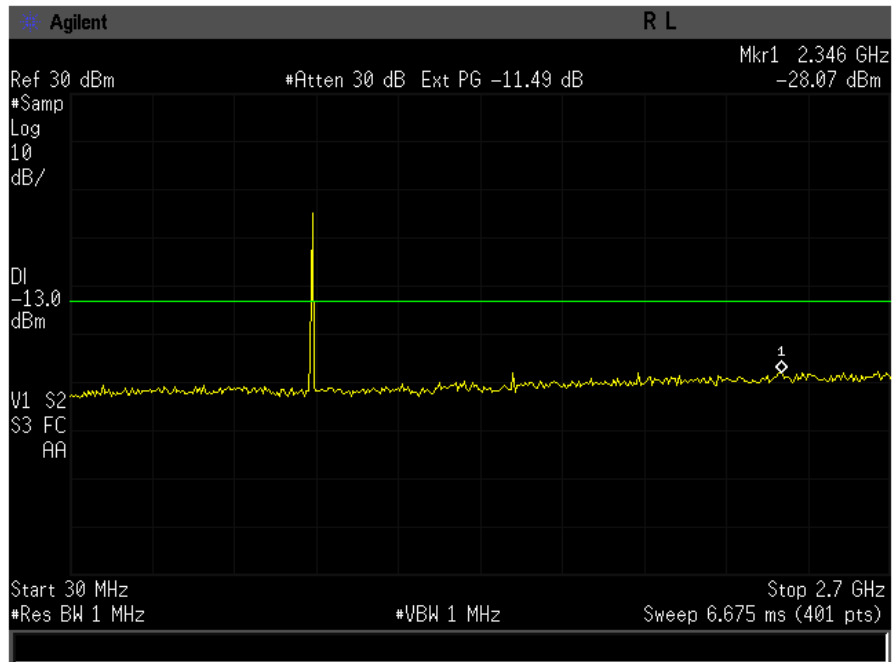

Figure 9-1a CDMA 800 BC-10 – Conducted Spurious Emission (CH 476)

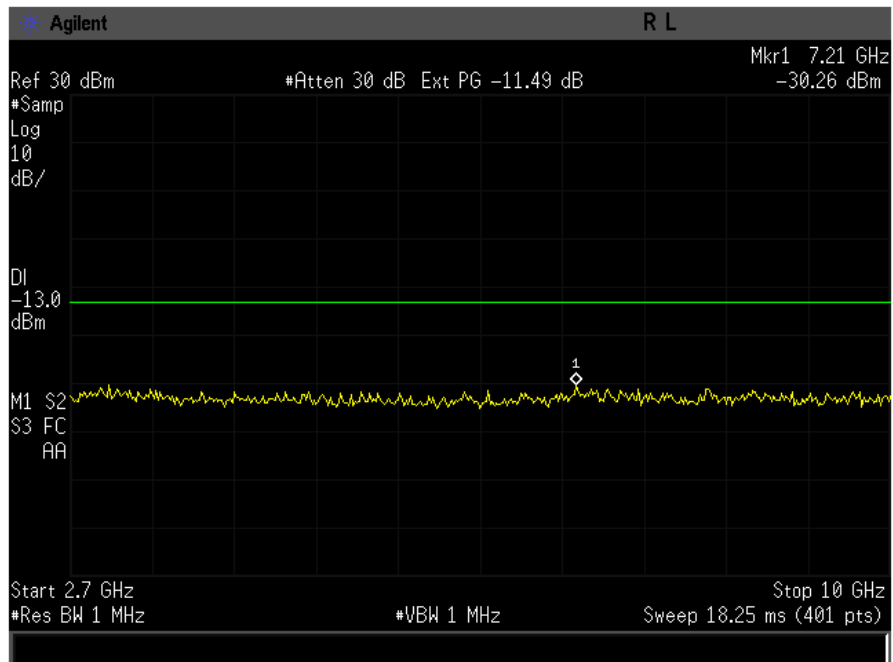

Figure 9-1b CDMA 800 BC-10 – Conducted Spurious Emission (CH 476)

Applicant:	Kyocera
FCC ID:	V65S3015
Report #:	CT-S3015-90-0711-R0

10 TRANSMITTER RADIATED SPURIOUS EMISSIONS

FCC:	§ 2.1053, § 90.691
IC:	--
<p>The radiated spurious emission test was performed at Compliance Certification Service. The test report is attached in a separate attachment.</p>	

11 TRANSMITTER RF CARRIER FREQUENCY STABILITY

11.1 Test Configuration		
FCC:	§ 2.1055, § 90.213	
IC:	--	
<p>The EUT was placed in an environmental chamber. The RF output of the EUT was connected to Agilent 8960 Series 10 E5515C. A power supplier was connected as primary voltage supply. Only the mid channel of each frequency band was investigated.</p>		
<u>Limits:</u>		
Tx Frequency	Channel	Limit
820.5 MHz	476	+/- 2.5 ppm (+/- 2051 Hz)

11.2 Test Result

CDMA 800 - BC10						
Temperature (°C)	Deviation of Carrier (Hz)			Specification (Hz)		Result
	3.3V (Battery endpoint)	3.7V	4.2V (115%)	Lower limit	Upper limit	
-30		8.84		-2051	2051	Pass
-20		-10.56		-2051	2051	
-10		-11.48		-2051	2051	
0		-10.32		-2051	2051	
10		-11.08		-2051	2051	
20	10.73	10.45	10.26	-2051	2051	
30		9.88		-2051	2051	
40		-10.54		-2051	2051	
50		-10.67		-2051	2051	
60		-11.65		-2051	2051	

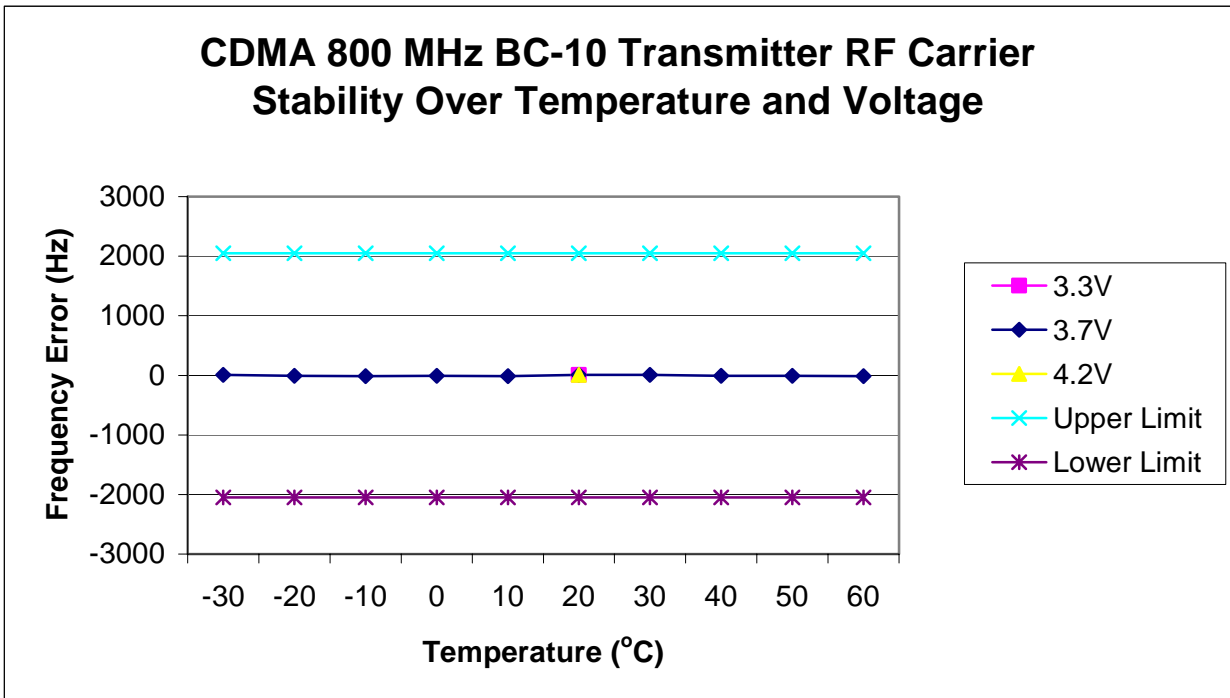

Applicant:	Kyocera
FCC ID:	V65S3015
Report #:	CT-S3015-90-0711-R0

12 EXPOSURE OF HUMANS TO RF FIELDS (SAR)

12.1 Test Configuration and Result

FCC: § 2.1093

IC: --

The SAR test report is attached in a separate attachment.

13 TEST EQUIPMENT

The test equipment utilized to perform the tests documented in this report has been calibrated in accordance with the manufacturer's recommendations and is traceable to recognized national standards.

Description	Manufacturer	Model No.	Serial No.	Cal Due Date
Power Meter	Giga-tronics	8541C	1831306	09/08/11
Spectrum Analyzer	Agilent	E4405B	US41441217	05/26/12
Spectrum Analyzer	Hewlett Packard	8593EM	3710A00203	06/09/12
Wireless Communications Test Set	Agilent	8960	GB44052789	08/17/11
Temperature Chamber	Test Equity	ZH2-033-033-H/AC	ZZ9622421	06/24/12