

## FCC Test Report

### (PART 27)

**Report No.:** RF170407C04-2

**FCC ID:** V65S2720

**Test Model:** S2720

**Received Date:** Apr. 07, 2017

**Test Date:** Apr. 24, 2017 ~ Apr. 28, 2017

**Issued Date:** Jul. 12, 2017

**Applicant:** Kyocera Corporation c/o Kyocera International, Inc.

**Address:** 8611 Balboa Drive, San Diego, CA 92123

**Issued By:** Bureau Veritas Consumer Products Services (H.K.) Ltd., Taoyuan Branch

**Lab Address:** No. 47-2, 14th Ling, Chia Pau Vil., Lin Kou Dist., New Taipei City, Taiwan  
( R.O.C )

**Test Location (1):** No. 19, Hwa Ya 2nd Rd, Wen Hwa Tsuen, Kwei Shan Hsiang, Taoyuan  
Hsien 333, Taiwan, R.O.C.

**Test Location (2):** No.215, Sec. 3, Beixin Rd., Xindian Dist., New Taipei City 231, Taiwan,  
R.O.C



This report is for your exclusive use. Any copying or replication of this report to or for any other person or entity, or use of our name or trademark, is permitted only with our prior written permission. This report sets forth our findings solely with respect to the test samples identified herein. The results set forth in this report are not indicative or representative of the quality or characteristics of the lot from which a test sample was taken or any similar or identical product unless specifically and expressly noted. Our report includes all of the tests requested by you and the results thereof based upon the information that you provided to us. You have 60 days from date of issuance of this report to notify us of any material error or omission caused by our negligence, provided, however, that such notice shall be in writing and shall specifically address the issue you wish to raise. A failure to raise such issue within the prescribed time shall constitute your unqualified acceptance of the completeness of this report, the tests conducted and the correctness of the report contents. Unless specific mention, the uncertainty of measurement has been explicitly taken into account to declare the compliance or non-compliance to the specification. The report must not be used by the client to claim product certification, approval, or endorsement by TAF or any government agency

## Table of Contents

<b>Release Control Record</b> .....	<b>3</b>
<b>1 Certificate of Conformity</b> .....	<b>4</b>
<b>2 Summary of Test Results</b> .....	<b>5</b>
2.1 Measurement Uncertainty .....	6
2.2 Test Site and Instruments .....	7
<b>3 General Information</b> .....	<b>8</b>
3.1 General Description of EUT .....	8
3.2 Configuration of System under Test .....	10
3.2.1 Description of Support Units .....	10
3.3 Test Mode Applicability and Tested Channel Detail .....	11
3.4 EUT Operating Conditions .....	14
3.5 General Description of Applied Standards .....	14
<b>4 Test Types and Results</b> .....	<b>15</b>
4.1 Output Power Measurement .....	15
4.1.1 Limits of Output Power Measurement .....	15
4.1.2 Test Procedures .....	15
4.1.3 Test Setup .....	16
4.1.4 Test Results .....	17
4.2 Frequency Stability Measurement .....	23
4.2.1 Limits of Frequency Stability Measurement .....	23
4.2.2 Test Procedure .....	23
4.2.3 Test Setup .....	23
4.2.4 Test Results .....	24
4.3 Occupied Bandwidth Measurement .....	32
4.3.1 Limits of Occupied Bandwidth Measurement .....	32
4.3.2 Test Procedure .....	32
4.3.3 Test Setup .....	32
4.3.4 Test Result .....	33
4.4 Band Edge Measurement .....	37
4.4.1 Limits of Band Edge Measurement .....	37
4.4.2 Test Setup .....	37
4.4.3 Test Procedures .....	37
4.4.4 Test Results .....	38
4.5 Peak to Average Ratio .....	48
4.5.1 Limits of Peak to Average Ratio Measurement .....	48
4.5.2 Test Setup .....	48
4.5.3 Test Procedures .....	48
4.5.4 Test Results .....	49
4.6 Conducted Spurious Emissions .....	53
4.6.1 Limits of Conducted Spurious Emissions Measurement .....	53
4.6.2 Test Setup .....	53
4.6.3 Test Procedure .....	53
4.6.4 Test Results .....	54
4.7 Radiated Emission Measurement .....	61
4.7.1 Limits of Radiated Emission Measurement .....	61
4.7.2 Test Procedure .....	61
4.7.3 Deviation from Test Standard .....	61
4.7.4 Test Setup .....	62
4.7.5 Test Results .....	63
<b>5 Pictures of Test Arrangements</b> .....	<b>73</b>
<b>Appendix – Information on the Testing Laboratories</b> .....	<b>74</b>

### Release Control Record

Issue No.	Description	Date Issued
RF170407C04-2	Original Release	Jul. 12, 2017

## 1 Certificate of Conformity

**Product:** Feature phone

**Brand:** Kyocera

**Test Model:** S2720

**Sample Status:** Identical Prototype

**Applicant:** Kyocera Corporation c/o Kyocera International, Inc.

**Test Date:** Apr. 24, 2017 ~ Apr. 28, 2017

**Standards:** FCC Part 27, Subpart C, L

The above equipment has been tested by **Bureau Veritas Consumer Products Services (H.K.) Ltd., Taoyuan Branch**, and found compliance with the requirement of the above standards. The test record, data evaluation & Equipment Under Test (EUT) configurations represented herein are true and accurate accounts of the measurements of the sample's EMC characteristics under the conditions specified in this report.

**Prepared by :**  , **Date:** Jul. 12, 2017  
Gina Liu / Specialist

**Approved by :**  , **Date:** Jul. 12, 2017  
David Huang / Project Engineer

## 2 Summary of Test Results

Applied Standard: FCC Part 27 & Part 2 (LTE 4)			
FCC Clause	Test Item	Result	Remarks
2.1046 27.50(d)(4)	Maximum Peak Output Power	Pass	Meet the requirement of limit.
2.1055 27.54	Frequency Stability	Pass	Meet the requirement of limit.
2.1049 27.53(h)	Occupied Bandwidth	Pass	Meet the requirement of limit.
27.50(d)(5)	Peak to Average Ratio	Pass	Meet the requirement of limit.
27.53(h)	Band Edge Measurements	Pass	Meet the requirement of limit.
2.1051 27.53(h)	Conducted Spurious Emissions	Pass	Meet the requirement of limit.
2.1053 27.53(h)	Radiated Spurious Emissions	Pass	Meet the requirement of limit. Minimum passing margin is -23.37 dB at 5197.50 MHz.

Applied Standard: FCC Part 27 & Part 2 (LTE 13)			
FCC Clause	Test Item	Result	Remarks
2.1046 27.50(b)(10)	Maximum Peak Output Power	Pass	Meet the requirement of limit.
2.1055 27.54	Frequency Stability	Pass	Meet the requirement of limit.
2.1049 27.53(g)	Occupied Bandwidth	Pass	Meet the requirement of limit.
27.50(d)(5)	Peak to Average Ratio	Pass	Meet the requirement of limit.
27.53(g)	Band Edge Measurements	Pass	Meet the requirement of limit.
2.1051 27.53(g)	Conducted Spurious Emissions	Pass	Meet the requirement of limit.
2.1053 27.53(g)(f)	Radiated Spurious Emissions	Pass	Meet the requirement of limit. Minimum passing margin is -18.41 dB at 1564.00 MHz.

## 2.1 Measurement Uncertainty

Where relevant, the following measurement uncertainty levels have been estimated for tests performed on the EUT as specified in CISPR 16-4-2:

Measurement	Frequency	Expanded Uncertainty (k=2) (±)
Conducted Emissions at mains ports	150 kHz ~ 30 MHz	2.44 dB
Radiated Emissions up to 1 GHz	30 MHz ~ 200 MHz	2.0153 dB
	200 MHz ~ 1000 MHz	2.0224 dB
Radiated Emissions above 1 GHz	1 GHz ~ 18 GHz	1.0121 dB
	18 GHz ~ 40 GHz	1.1508 dB

## 2.2 Test Site and Instruments

Description & Manufacturer	Model No.	Serial No.	Date of Calibration	Due Date of Calibration
Test Receiver Agilent Technologies	N9038A	MY52260177	Jun. 21, 2016	Jun. 20, 2017
Spectrum Analyzer ROHDE & SCHWARZ	FSU43	101261	Dec. 13, 2016	Dec. 12, 2017
BILOG Antenna SCHWARZBECK	VULB9168	9168-472	Dec. 16, 2016	Dec. 15, 2017
HORN Antenna ETS-Lindgren	3117	00143293	Dec. 29, 2016	Dec. 28, 2017
Double Ridge Guide Horn Antenna EMCO	3115	5619	Dec. 27, 2016	Dec. 26, 2017
BILOG Antenna SCHWARZBECK	VULB 9168	9168-153	Dec. 13, 2016	Dec. 12, 2017
Agilent Communications Tester-Wireless	8960 Series 10	MY53201073	Jul. 03, 2015	Jul. 02, 2017
Preamplifier Agilent	310N	187226	Jun. 24, 2016	Jun. 23, 2017
Preamplifier Agilent	83017A	MY39501357	Jun. 24, 2016	Jun. 23, 2017
Power Meter Anritsu	ML2495A	1232002	Sep. 08, 2016	Sep. 07, 2017
Power Sensor Anritsu	MA2411B	1207325	Sep. 08, 2016	Sep. 07, 2017
RF signal cable ETS-LINDGREN	5D-FB	Cable-CH1-01(RFC -SMS-100-SMS-12 0+RFC-SMS-100-S MS-400)	Jun. 24, 2016	Jun. 23, 2017
RF signal cable ETS-LINDGREN	8D-FB	Cable-CH1-02(RFC -SMS-100-SMS-24)	Jun. 24, 2016	Jun. 23, 2017
Software BV ADT	E3 8.130425b	NA	NA	NA
Antenna Tower MF	NA	NA	NA	NA
Turn Table MF	NA	NA	NA	NA
Antenna Tower & Turn Table Controller MF	MF-7802	NA	NA	NA
Communications Tester-Wireless Agilent	8960 Series 10	MY53201073	Jul. 03, 2015	Jul. 02, 2017
Radio Communication Analyzer Anritsu	MT8820C	6201240432	Jul. 06, 2015	Jul. 05, 2017
Temperature & Humidity Chamber	GTH-120-40-CP-AR	MAA1306-019	Sep. 02, 2016	Sep. 01, 2017
DC Power Supply Topward	33010D	807748	Oct. 25, 2016	Oct. 24, 2018
Digital Multimeter Fluke	87-III	70360742	Jul. 01, 2016	Jun. 30, 2017

- Note:
1. The calibration interval of the above test instruments is 12 / 24 months and the calibrations are traceable to NML/ROC and NIST/USA.
  2. The test was performed in HsinTien Chamber 1.
  3. The horn antenna and preamplifier (model: 83017A) are used only for the measurement of emission frequency above 1 GHz if tested.
  4. The FCC Site Registration No. is 149147.
  5. The IC Site Registration No. is IC7450I-1.

### 3 General Information

#### 3.1 General Description of EUT

<b>Product</b>	Feature phone	
<b>Brand</b>	Kyocera	
<b>Test Model</b>	S2720	
<b>Status of EUT</b>	Identical Prototype	
<b>Power Supply Rating</b>	5.0 Vdc (adapter or host equipment) 3.8 Vdc (Li-ion battery)	
<b>Modulation Type</b>	LTE	QPSK, 16QAM
<b>Frequency Range</b>	LTE Band 4 (Channel Bandwidth: 1.4 MHz)	1710.7 ~ 1754.3 MHz
	LTE Band 4 (Channel Bandwidth: 3 MHz)	1711.5 ~ 1753.5 MHz
	LTE Band 4 (Channel Bandwidth: 5 MHz)	1712.5 ~ 1752.5 MHz
	LTE Band 4 (Channel Bandwidth: 10 MHz)	1715.0 ~ 1750.0 MHz
	LTE Band 4 (Channel Bandwidth: 15 MHz)	1717.5 ~ 1747.5 MHz
	LTE Band 4 (Channel Bandwidth: 20 MHz)	1720.0 ~ 1745.0 MHz
	LTE Band 13 (Channel Bandwidth: 5 MHz)	779.5 ~ 784.5 MHz
	LTE Band 13 (Channel Bandwidth: 10 MHz)	782.0 MHz
<b>Emission Designator</b>	LTE Band 4 (Channel Bandwidth: 1.4 MHz)	1M09W7D
	LTE Band 4 (Channel Bandwidth: 3 MHz)	2M70G7D
	LTE Band 4 (Channel Bandwidth: 5 MHz)	4M50W7D
	LTE Band 4 (Channel Bandwidth: 10 MHz)	8M97W7D
	LTE Band 4 (Channel Bandwidth: 15 MHz)	14M5W7D
	LTE Band 4 (Channel Bandwidth: 20 MHz)	18M0W7D
	LTE Band 13 (Channel Bandwidth: 5 MHz)	4M50W7D
	LTE Band 13 (Channel Bandwidth: 10 MHz)	8M96W7D
<b>Max. ERP Power</b>	LTE Band 13 (Channel Bandwidth: 5 MHz)	227.04mW
	LTE Band 13 (Channel Bandwidth: 10 MHz)	226.31mW
<b>Max. EIRP Power</b>	LTE Band 4 (Channel Bandwidth: 1.4 MHz)	284.90mW
	LTE Band 4 (Channel Bandwidth: 3 MHz)	286.09mW
	LTE Band 4 (Channel Bandwidth: 5 MHz)	284.45mW
	LTE Band 4 (Channel Bandwidth: 10 MHz)	287.74mW
	LTE Band 4 (Channel Bandwidth: 15 MHz)	288.87mW
	LTE Band 4 (Channel Bandwidth: 20 MHz)	285.43mW
<b>Antenna Type</b>	Fixed Internal Antenna	
<b>Accessory Device</b>	Refer to Note as below	
<b>Data Cable Supplied</b>	Refer to Note as below	



Note:

1. The EUT contains following accessory devices.

Product	Brand	Model	Description
Adapter 1	KYOCERA	SCP-47ADT	I/P: 100-240 Vac, 50/60 Hz, 200 mA O/P: 5.0 Vdc, 1000 mA
Adapter 2	KYOCERA	SCP-51ADT	I/P: 100-240 Vac, 50/60 Hz, 200 mA O/P: 5.0 Vdc, 1000 mA
Battery	KYOCERA	SCP-70LBPS	3.8 Vdc, 1400/1430 mAh
USB Cable	KYOCERA	SCP-23SDC	1.0 m shielded cable w/o core

2. The above EUT information is declared by manufacturer and for more detailed features description, please refer to the manufacturer's specifications or user's manual.

### 3.2 Configuration of System under Test

#### <Radiated Emission Test>

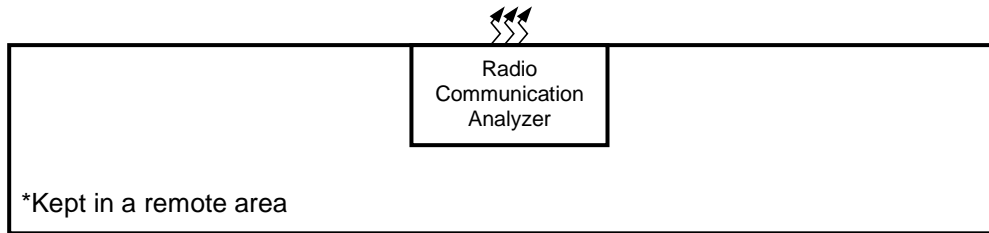
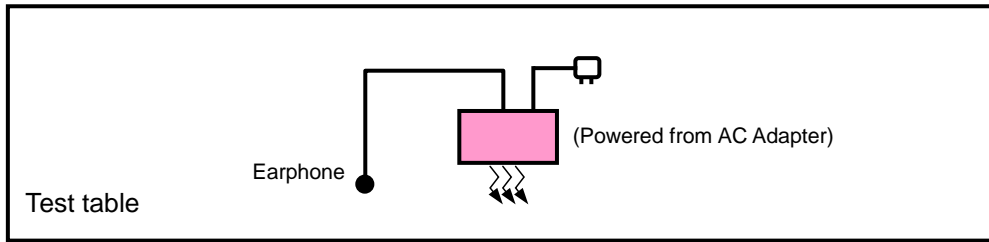

#### <E.R.P. / E.I.R.P. Test>

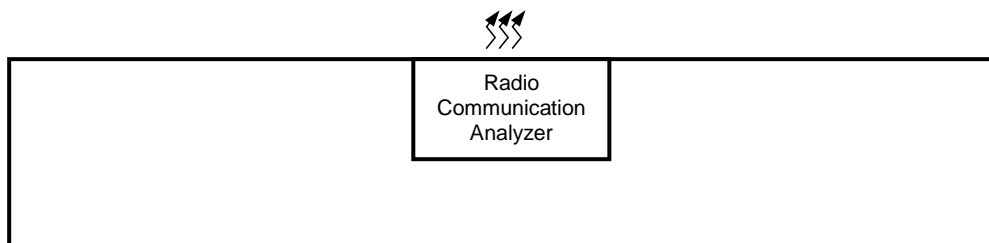
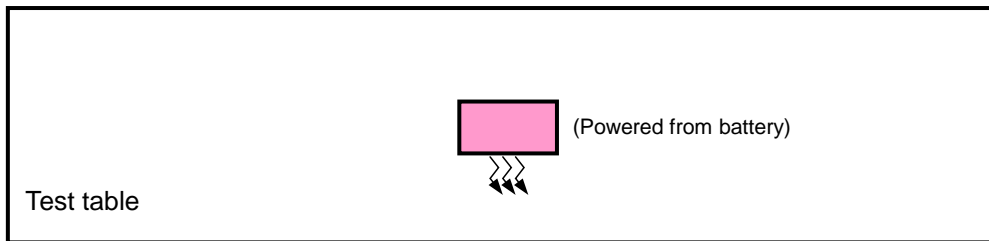

#### 3.2.1 Description of Support Units

The EUT has been tested as an independent unit together with other necessary accessories or support units. The following support units or accessories were used to form a representative test configuration during the tests.

No.	Product	Brand	Model No.	Serial No.	FCC ID
1.	Radio Communication Analyzer	Anritsu	MT8820C	6201300640	N/A
2.	Earphone	N/A	N/A	N/A	N/A

No.	Signal Cable Description Of The Above Support Units
1.	N/A
2.	N/A

Note:

1. All power cords of the above support units are non-shielded (1.8m).
2. Item 1 acted as communication partner to transfer data.

### 3.3 Test Mode Applicability and Tested Channel Detail

Pre-Scan has been conducted to determine the worst-case mode from all possible combinations between available modulations, data rates, XYZ axis, and antenna ports

The worst case was found when positioned as the table below. Following channel(s) was (were) selected for the final test as listed below:

Band	ERP / EIRP	Radiated Emission
LTE Band 4	Y-plane	Y-axis
LTE Band 13	Y-plane	Y-axis

#### LTE Band 4

EUT Configure Mode	Test Item	Available Channel	Tested Channel	Channel Bandwidth	Modulation	Mode
-	EIRP	19957 to 20393	19957, 20175, 20393	1.4 MHz	QPSK, 16QAM	1 RB / 5 RB Offset
		19965 to 20385	19965, 20175, 20385	3 MHz	QPSK, 16QAM	1 RB / 14 RB Offset
		19975 to 20375	19975, 20175, 20375	5 MHz	QPSK, 16QAM	1 RB / 24 RB Offset
		20000 to 20350	20000, 20175, 20350	10 MHz	QPSK, 16QAM	1 RB / 49 RB Offset
		20025 to 20325	20025, 20175, 20325	15 MHz	QPSK, 16QAM	1 RB / 74 RB Offset
		20050 to 20300	20050, 20175, 20300	20 MHz	QPSK, 16QAM	1 RB / 99 RB Offset
-	Frequency Stability	19957 to 20393	19957, 20393	1.4 MHz	QPSK	1 RB / 5 RB Offset
		19965 to 20385	19965, 20385	3 MHz	QPSK	1 RB / 14 RB Offset
		19975 to 20375	19975, 20375	5 MHz	QPSK	1 RB / 24 RB Offset
		20000 to 20350	20000, 20350	10 MHz	QPSK	1 RB / 49 RB Offset
		20025 to 20325	20025, 20325	15 MHz	QPSK	1 RB / 74 RB Offset
		20050 to 20300	20050, 20300	20 MHz	QPSK	1 RB / 99 RB Offset
-	Occupied Bandwidth	19957 to 20393	19957, 20175, 20393	1.4 MHz	QPSK, 16QAM	6 RB / 0 RB Offset
		19965 to 20385	19965, 20175, 20385	3 MHz	QPSK, 16QAM	15 RB / 0 RB Offset
		19975 to 20375	19975, 20175, 20375	5 MHz	QPSK, 16QAM	25 RB / 0 RB Offset
		20000 to 20350	20000, 20175, 20350	10 MHz	QPSK, 16QAM	50 RB / 0 RB Offset
		20025 to 20325	20025, 20175, 20325	15 MHz	QPSK, 16QAM	75 RB / 0 RB Offset
		20050 to 20300	20050, 20175, 20300	20 MHz	QPSK, 16QAM	100 RB / 0 RB Offset
-	Peak to Average Ratio	19957 to 20393	19957, 20175, 20393	1.4 MHz	QPSK, 16QAM	1 RB / 2 RB Offset
		19965 to 20385	19965, 20175, 20385	3 MHz	QPSK, 16QAM	1 RB / 7 RB Offset
		19975 to 20375	19975, 20175, 20375	5 MHz	QPSK, 16QAM	12 RB / 0 RB Offset
		20000 to 20350	20000, 20175, 20350	10 MHz	QPSK, 16QAM	1 RB / 24 RB Offset
		20025 to 20325	20025, 20175, 20325	15 MHz	QPSK, 16QAM	36 RB / 0 RB Offset
		20050 to 20300	20050, 20175, 20300	20 MHz	QPSK, 16QAM	50 RB / 0 RB Offset

EUT Configure Mode	Test Item	Available Channel	Tested Channel	Channel Bandwidth	Modulation	Mode		
-	Band Edge	19957 to 20393	19957	1.4 MHz	QPSK	1 RB / 0 RB Offset 6 RB / 0 RB Offset		
			20393	1.4 MHz	QPSK	1 RB / 5 RB Offset 6 RB / 0 RB Offset		
		19965 to 20385	19965	3 MHz	QPSK	1 RB / 0 RB Offset 15 RB / 0 RB Offset		
			20385	3 MHz	QPSK	1 RB / 14 RB Offset 15 RB / 0 RB Offset		
		19975 to 20375	19975	5 MHz	QPSK	1 RB / 0 RB Offset 25 RB / 0 RB Offset		
			20375	5 MHz	QPSK	1 RB / 24 RB Offset 25 RB / 0 RB Offset		
		20000 to 20350	20000	10 MHz	QPSK	1 RB / 0 RB Offset 50 RB / 0 RB Offset		
			20350	10 MHz	QPSK	1 RB / 49 RB Offset 50 RB / 0 RB Offset		
		20025 to 20325	20025	15 MHz	QPSK	1 RB / 0 RB Offset 75 RB / 0 RB Offset		
			20325	15 MHz	QPSK	1 RB / 74 RB Offset 75 RB / 0 RB Offset		
		20050 to 20300	20050	20 MHz	QPSK	1 RB / 0 RB Offset 100 RB / 0 RB Offset		
			20300	20 MHz	QPSK	1 RB / 99 RB Offset 100 RB / 0 RB Offset		
		-	Conducted Emission	19957 to 20393	19957, 20175, 20393	1.4 MHz	QPSK	1 RB / 2 RB Offset
				19965 to 20385	19965, 20175, 20385	3 MHz	QPSK	1 RB / 7 RB Offset
				19975 to 20375	19975, 20175, 20375	5 MHz	QPSK	12 RB / 0 RB Offset
				20000 to 20350	20000, 20175, 20350	10 MHz	QPSK	50 RB / 0 RB Offset
				20025 to 20325	20025, 20175, 20325	15 MHz	QPSK	36 RB / 0 RB Offset
				20050 to 20300	20050, 20175, 20300	20 MHz	QPSK	50 RB / 0 RB Offset
-	Radiated Emission	20050 to 20300	20050, 20175, 20300	20 MHz	QPSK	1 RB / 99 RB Offset		

**Note:** This device was tested under all bandwidths, RB configurations and modulations. The worst case was found in QPSK modulation.

### LTE Band 13

EUT Configure Mode	Test Item	Available Channel	Tested Channel	Channel Bandwidth	Modulation	Mode
-	ERP	23205 to 23255	23205, 23230, 23255	5 MHz	QPSK, 16QAM	1 RB / 0 RB Offset
		23230	23230	10 MHz	QPSK, 16QAM	1 RB / 24 RB Offset
-	Frequency Stability	23205 to 23255	23205, 23255	5 MHz	QPSK	1 RB / 0 RB Offset
		23230	23230	10 MHz	QPSK	1 RB / 24 RB Offset
-	Occupied Bandwidth	23205 to 23255	23205, 23230, 23255	5 MHz	QPSK, 16QAM	25 RB / 0 RB Offset
		23230	23230	10 MHz	QPSK, 16QAM	50 RB / 0 RB Offset
-	Peak to Average Ratio	23205 to 23255	23205, 23230, 23255	5 MHz	QPSK, 16QAM	1 RB / 0 RB Offset
		23230	23230	10 MHz	QPSK, 16QAM	1 RB / 0 RB Offset
-	Band Edge	23205 to 23255	23205	5 MHz	QPSK	1 RB / 0 RB Offset
			23255	5 MHz	QPSK	25 RB / 0 RB Offset
		23230	23230	10 MHz	QPSK	1 RB / 24 RB Offset
			23230	10 MHz	QPSK	25 RB / 0 RB Offset
			23230	10 MHz	QPSK	1 RB / 0 RB Offset
			23230	10 MHz	QPSK	50 RB / 0 RB Offset
-	Conducted Emission	23205 to 23255	23205, 23230, 23255	5 MHz	QPSK	1 RB / 0 RB Offset
		23230	23230	10 MHz	QPSK	1 RB / 0 RB Offset
-	Radiated Emission	23230	23230	10 MHz	QPSK	1 RB / 24 RB Offset
						1 RB / 50 RB Offset

**Note:** This device was tested under all bandwidths, RB configurations and modulations. The worst case was found in QPSK modulation.

#### Test Condition:

Test Item	Environmental Conditions	Input Power	Tested By
ERP / EIRP	25 deg. C, 65 % RH	3.8 Vdc	Karl Lee
Frequency Stability	25 deg. C, 65 % RH	3.8 Vdc	Anson Lin
Occupied Bandwidth	25 deg. C, 65 % RH	3.8 Vdc	Anson Lin
Band Edge	25 deg. C, 65 % RH	3.8 Vdc	Anson Lin
Peak to Average Ratio	25 deg. C, 65 % RH	3.8 Vdc	Anson Lin
Condcudeted Emission	25 deg. C, 65 % RH	3.8 Vdc	Anson Lin
Radiated Emission	25 deg. C, 65 % RH	120 Vac, 60 Hz	Karl Lee

### **3.4 EUT Operating Conditions**

The EUT makes a call to the communication simulator. The communication simulator station system controlled a EUT to export maximum output power under transmission mode and specific channel frequency

### **3.5 General Description of Applied Standards**

The EUT is a RF Product. According to the specifications of the manufacturer, it must comply with the requirements of the following standards:

**FCC 47 CFR Part 2**

**FCC 47 CFR Part 27**

**KDB 971168 D01 Power Meas License Digital Systems v02r02**

**ANSI/TIA/EIA-603-D 2010**

**Note:** All test items have been performed and recorded as per the above standards.

## 4 Test Types and Results

### 4.1 Output Power Measurement

#### 4.1.1 Limits of Output Power Measurement

Fixed, mobile, and portable (hand-held) stations operating in the 1710–1755 MHz band are limited to 1 watt EIRP.

Portable stations (hand-held devices) operating in the 776-787 MHz band are limited to 3 watts ERP

#### 4.1.2 Test Procedures

##### **EIRP / ERP Measurement:**

- a. All measurements were done at low, middle and high operational frequency range. RBW and VBW is 5 MHz for WCDMA and 10 MHz for LTE mode.
- b. Substitution method is used for E.I.R.P measurement. In the semi-anechoic chamber, EUT placed on the 0.8 m height of Turn Table, rotated the table around 360 degrees to search the maximum radiation power and receiver antenna shall be rotated vertical and horizontal polarization and moved height from 1 m to 4 m to find the maximum polar radiated power. The “Read Value” is the spectrum reading the maximum power value.
- c. The substitution horn antenna is substituted for EUT at the same position and signals generator export the CW signal to the substitution antenna via a tx cable. Rotated the Turn Table and moved receiving antenna to find the maximum radiation power. Adjust output power level of S.G to get a Value of spectrum reading equal to “Read Value” of step b. Record the power level of S.G.
- d.  $EIRP = \text{Output power level of S.G} - \text{TX cable loss} + \text{Antenna gain of substitution horn}$ . E.R.P power can be calculated form E.I.R.P power by subtracting the gain of dipole,  $E.R.P \text{ power} = E.I.P.R \text{ power} - 2.15 \text{ dBi}$ .

##### **Conducted Power Measurement:**

- a. The EUT was set up for the maximum power with LTE link data modulation and link up with simulator.
- b. Set the EUT to transmit under low, middle and high channel and record the power level shown on simulator.

### 4.1.3 Test Setup

#### EIRP / ERP Measurement:

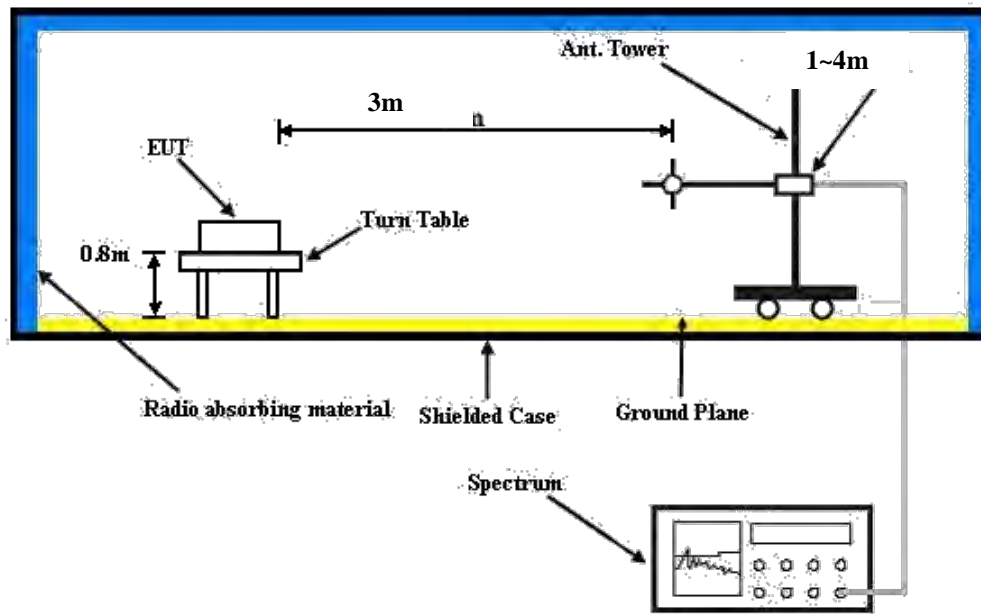

For the actual test configuration, please refer to the attached file (Test Setup Photo).

#### Conducted Power Measurement:





4.1.4 Test Results

**Conducted Output Power (dBm)**

Band / BW	RB Size	RB Offset	QPSK			3GPP MPR (dB)	16QAM			3GPP MPR (dB)
			Low Ch 19957	Mid Ch 20175	High Ch 20393		Low Ch 19957	Mid Ch 20175	High Ch 20393	
			1710.7 MHz	1732.5 MHz	1754.3 MHz		1710.7 MHz	1732.5 MHz	1754.3 MHz	
4 / 1.4M	1	0	23.34	23.57	23.71	0	22.28	22.51	22.65	1
	1	2	23.21	23.44	23.58	0	22.15	22.38	22.52	1
	1	5	23.40	23.63	23.77	0	22.34	22.57	22.71	1
	3	0	23.31	23.54	23.68	0	22.25	22.48	22.62	1
	3	1	23.09	23.32	23.46	0	22.03	22.26	22.40	1
	3	3	22.97	23.20	23.34	0	21.91	22.14	22.28	1
	6	0	22.37	22.60	22.74	1	21.31	21.54	21.68	2

Band / BW	RB Size	RB Offset	QPSK			3GPP MPR (dB)	16QAM			3GPP MPR (dB)
			Low Ch 19965	Mid Ch 20175	High Ch 20385		Low Ch 19965	Mid Ch 20175	High Ch 20385	
			1711.5 MHz	1732.5 MHz	1753.5 MHz		1711.5 MHz	1732.5 MHz	1753.5 MHz	
4 / 3M	1	0	23.40	23.63	23.77	0	22.34	22.57	22.71	1
	1	7	23.27	23.50	23.64	0	22.21	22.44	22.58	1
	1	14	23.46	23.69	23.83	0	22.40	22.63	22.77	1
	8	0	22.57	22.80	22.94	1	21.51	21.74	21.88	2
	8	3	22.35	22.58	22.72	1	21.29	21.52	21.66	2
	8	7	22.23	22.46	22.60	1	21.17	21.40	21.54	2
	15	0	22.43	22.66	22.80	1	21.37	21.60	21.74	2

Band / BW	RB Size	RB Offset	QPSK			3GPP MPR (dB)	16QAM			3GPP MPR (dB)
			Low Ch 19975	Mid Ch 20175	High Ch 20375		Low CH 19975	Mid CH 20175	High CH 20375	
			1712.5 MHz	1732.5 MHz	1752.5 MHz		1712.5 MHz	1732.5 MHz	1752.5 MHz	
4 / 5M	1	0	23.47	23.70	23.84	0	22.41	22.64	22.78	1
	1	12	23.34	23.57	23.71	0	22.28	22.51	22.65	1
	1	24	23.53	23.76	23.90	0	22.47	22.70	22.84	1
	12	0	22.64	22.87	23.01	1	21.58	21.81	21.95	2
	12	6	22.42	22.65	22.79	1	21.36	21.59	21.73	2
	12	13	22.30	22.53	22.67	1	21.24	21.47	21.61	2
	25	0	22.50	22.73	22.87	1	21.44	21.67	21.81	2

Band / BW	RB Size	RB Offset	QPSK			3GPP MPR (dB)	16QAM			3GPP MPR (dB)
			Low Ch 20000	Mid Ch 20175	High Ch 20350		Low Ch 20000	Mid Ch 20175	High Ch 20350	
			1715.0 MHz	1732.5 MHz	1750.0 MHz		1715.0 MHz	1732.5 MHz	1750.0 MHz	
4 / 10M	1	0	23.55	23.78	23.92	0	22.49	22.72	22.86	1
	1	24	23.42	23.65	23.79	0	22.36	22.59	22.73	1
	1	49	23.61	23.84	23.98	0	22.55	22.78	22.92	1
	25	0	22.72	22.95	23.09	1	21.66	21.89	22.03	2
	25	12	22.50	22.73	22.87	1	21.44	21.67	21.81	2
	25	25	22.38	22.61	22.75	1	21.32	21.55	21.69	2
	50	0	22.58	22.81	22.95	1	21.52	21.75	21.89	2

Band / BW	RB Size	RB Offset	QPSK			3GPP MPR (dB)	16QAM			3GPP MPR (dB)
			Low Ch 20025	Mid Ch 20175	High Ch 20325		Low Ch 20025	Mid Ch 20175	High Ch 20325	
			1717.5 MHz	1732.5 MHz	1747.5 MHz		1717.5 MHz	1732.5 MHz	1747.5 MHz	
4 / 15M	1	0	23.64	23.87	24.01	0	22.58	22.81	22.95	1
	1	37	23.51	23.74	23.88	0	22.45	22.68	22.82	1
	1	74	23.70	23.93	24.07	0	22.64	22.87	23.01	1
	36	0	22.81	23.04	23.18	1	21.75	21.98	22.12	2
	36	19	22.59	22.82	22.96	1	21.53	21.76	21.90	2
	36	39	22.47	22.70	22.84	1	21.41	21.64	21.78	2
	75	0	22.67	22.90	23.04	1	21.61	21.84	21.98	2

Band / BW	RB Size	RB Offset	QPSK			3GPP MPR (dB)	16QAM			3GPP MPR (dB)
			Low Ch 20050	Mid Ch 20175	High Ch 20300		Low Ch 20050	Mid Ch 20175	High Ch 20300	
			1720.0 MHz	1732.5 MHz	1745.0 MHz		1720.0 MHz	1732.5 MHz	1745.0 MHz	
4 / 20M	1	0	23.75	23.98	24.12	0	22.69	22.92	23.06	1
	1	50	23.62	23.85	23.99	0	22.56	22.79	22.93	1
	1	99	23.81	24.04	24.18	0	22.75	22.98	23.12	1
	50	0	22.92	23.15	23.29	1	21.86	22.09	22.23	2
	50	25	22.70	22.93	23.07	1	21.64	21.87	22.01	2
	50	50	22.58	22.81	22.95	1	21.52	21.75	21.89	2
	100	0	22.78	23.01	23.15	1	21.72	21.95	22.09	2

Band / BW	RB Size	RB Offset	QPSK			3GPP MPR (dB)	16QAM			3GPP MPR (dB)
			Low Ch 23205	Mid Ch 23230	High Ch 23255		Low Ch 23205	Mid Ch 23230	High Ch 23255	
			779.5 MHz	782.0 MHz	784.5 MHz		779.5 MHz	782.0 MHz	784.5 MHz	
13 / 5M	1	0	23.52	23.63	23.65	0	22.47	22.58	22.60	1
	1	12	23.66	23.77	23.79	0	22.61	22.72	22.74	1
	1	24	23.72	23.83	23.85	0	22.67	22.78	22.80	1
	12	0	22.56	22.67	22.69	1	21.51	21.62	21.64	2
	12	6	22.48	22.59	22.61	1	21.43	21.54	21.56	2
	12	13	22.51	22.62	22.64	1	21.46	21.57	21.59	2
	25	0	22.52	22.63	22.65	1	21.47	21.58	21.60	2

Band / BW	RB Size	RB Offset	QPSK		3GPP MPR (dB)	16QAM		3GPP MPR (dB)
			Mid Ch 23230	782.0 MHz		Mid Ch 23230	782.0 MHz	
			782.0 MHz	782.0 MHz		782.0 MHz	782.0 MHz	
13 / 10M	1	0	23.75	782.0 MHz	0	22.70	782.0 MHz	1
	1	24	23.89	782.0 MHz	0	22.84	782.0 MHz	1
	1	49	23.95	782.0 MHz	0	22.90	782.0 MHz	1
	25	0	22.79	782.0 MHz	1	21.74	782.0 MHz	2
	25	12	22.71	782.0 MHz	1	21.66	782.0 MHz	2
	25	25	22.74	782.0 MHz	1	21.69	782.0 MHz	2
	50	0	22.75	782.0 MHz	1	21.70	782.0 MHz	2

**ERP Power (dBm)**

LTE Band 13							
Channel Bandwidth: 5 MHz / QPSK							
Plane	Channel	Frequency (MHz)	LVL (dBm)	Correction Factor (dB)	ERP (dBm)	ERP (mW)	Polarization (H/V)
Y	23205	779.5	-7.11	32.771	23.51	224.44	H
	23230	782.0	-7.03	32.741	23.56	227.04	
	23255	784.5	-7.18	32.854	23.52	225.11	
	23205	779.5	-9.81	32.5	20.54	113.24	V
	23230	782.0	-9.83	32.52	20.54	113.24	
	23255	784.5	-9.92	32.62	20.55	113.50	
Channel Bandwidth: 5 MHz / 16QAM							
Y	23205	779.5	-8.13	32.771	22.49	177.46	H
	23230	782.0	-8.03	32.741	22.56	180.34	
	23255	784.5	-8.16	32.854	22.54	179.64	
	23205	779.5	-10.83	32.5	19.52	89.54	V
	23230	782.0	-10.78	32.52	19.59	90.99	
	23255	784.5	-10.97	32.62	19.50	89.13	

LTE Band 13							
Channel Bandwidth: 10 MHz / QPSK							
Plane	Channel	Frequency (MHz)	LVL (dBm)	Correction Factor (dB)	ERP (dBm)	ERP (mW)	Polarization (H/V)
Y	23230	782.0	-7.04	32.737	23.55	226.31	H
	23230	782.0	-9.81	32.52	20.56	113.76	V
Channel Bandwidth: 10 MHz / 16QAM							
Y	23230	782.0	-8.02	32.737	22.57	180.59	H
	23230	782.0	-10.77	32.52	19.60	91.20	V

**EIRP Power (dBm)**

LTE Band 4							
Channel Bandwidth: 1.4 MHz / QPSK							
Plane	Channel	Frequency (MHz)	LVL (dBm)	Correction Factor (dB)	EIRP (dBm)	EIRP (mW)	Polarization (H/V)
Y	19957	1710.7	-17.96	42.49	24.53	283.47	H
	20175	1732.5	-17.78	42.33	24.55	284.90	
	20393	1754.3	-17.58	42.10	24.52	283.14	
	19957	1710.7	-23.54	42.99	19.45	88.10	V
	20175	1732.5	-23.24	42.74	19.50	89.13	
	20393	1754.3	-22.67	42.21	19.54	89.95	
Channel Bandwidth: 1.4 MHz / 16QAM							
Y	19957	1710.7	-19.00	42.49	23.49	223.10	H
	20175	1732.5	-18.82	42.33	23.51	224.23	
	20393	1754.3	-18.60	42.10	23.50	223.87	
	19957	1710.7	-24.50	42.99	18.49	70.63	V
	20175	1732.5	-24.17	42.74	18.57	71.94	
	20393	1754.3	-23.60	42.21	18.61	72.61	

LTE Band 4							
Channel Bandwidth: 3 MHz / QPSK							
Plane	Channel	Frequency (MHz)	LVL (dBm)	Correction Factor (dB)	EIRP (dBm)	EIRP (mW)	Polarization (H/V)
Y	19965	1711.5	-17.92	42.49	24.57	286.09	H
	20175	1732.5	-17.82	42.33	24.51	282.29	
	20385	1753.5	-17.54	42.10	24.56	285.76	
	19965	1711.5	-23.38	42.99	19.61	91.41	V
	20175	1732.5	-23.26	42.74	19.48	88.72	
	20385	1753.5	-22.76	42.21	19.45	88.10	
Channel Bandwidth: 3 MHz / 16QAM							
Y	19965	1711.5	-18.92	42.49	23.57	227.25	H
	20175	1732.5	-18.70	42.33	23.63	230.52	
	20385	1753.5	-18.62	42.10	23.48	222.84	
	19965	1711.5	-24.40	42.99	18.59	72.28	V
	20175	1732.5	-24.19	42.74	18.55	71.61	
	20385	1753.5	-23.77	42.21	18.44	69.82	

LTE Band 4							
Channel Bandwidth: 5 MHz / QPSK							
Plane	Channel	Frequency (MHz)	LVL (dBm)	Correction Factor (dB)	EIRP (dBm)	EIRP (mW)	Polarization (H/V)
Y	19975	1712.5	-17.96	42.49	24.53	283.47	H
	20175	1732.5	-17.83	42.33	24.50	281.64	
	20375	1752.5	-17.56	42.10	24.54	284.45	
	19975	1712.5	-23.50	42.99	19.49	88.92	V
	20175	1732.5	-23.26	42.74	19.48	88.72	
	20375	1752.5	-22.63	42.21	19.58	90.78	
Channel Bandwidth: 5 MHz / 16QAM							
Y	19975	1712.5	-18.92	42.49	23.57	227.25	H
	20175	1732.5	-18.83	42.33	23.50	223.72	
	20375	1752.5	-18.58	42.10	23.52	224.91	
	19975	1712.5	-24.56	42.99	18.43	69.66	V
	20175	1732.5	-24.21	42.74	18.53	71.29	
	20375	1752.5	-23.71	42.21	18.50	70.79	

LTE Band 4							
Channel Bandwidth: 10 MHz / QPSK							
Plane	Channel	Frequency (MHz)	LVL (dBm)	Correction Factor (dB)	EIRP (dBm)	EIRP (mW)	Polarization (H/V)
Y	20000	1715.0	-17.93	42.49	24.56	285.43	H
	20175	1732.5	-17.80	42.33	24.53	283.60	
	20350	1750.0	-17.51	42.10	24.59	287.74	
	20000	1715.0	-23.50	42.99	19.49	88.92	V
	20175	1732.5	-23.15	42.74	19.59	90.99	
	20350	1750.0	-22.69	42.21	19.52	89.54	
Channel Bandwidth: 10 MHz / 16QAM							
Y	20000	1715.0	-18.90	42.49	23.59	228.30	H
	20175	1732.5	-18.92	42.33	23.41	219.13	
	20350	1750.0	-18.64	42.10	23.46	221.82	
	20000	1715.0	-24.50	42.99	18.49	70.63	V
	20175	1732.5	-24.12	42.74	18.62	72.78	
	20350	1750.0	-23.63	42.21	18.58	72.11	

LTE Band 4							
Channel Bandwidth: 15 MHz / QPSK							
Plane	Channel	Frequency (MHz)	LVL (dBm)	Correction Factor (dB)	EIRP (dBm)	EIRP (mW)	Polarization (H/V)
Y	20025	1717.5	-18.01	42.49	24.48	280.22	H
	20175	1732.5	-17.72	42.33	24.61	288.87	
	20325	1747.5	-17.56	42.10	24.54	284.45	
	20025	1717.5	-23.52	42.99	19.47	88.51	V
	20175	1732.5	-23.14	42.74	19.60	91.20	
	20325	1747.5	-22.70	42.21	19.51	89.33	
Channel Bandwidth: 15 MHz / 16QAM							
Y	20025	1717.5	-19.01	42.49	23.48	222.59	H
	20175	1732.5	-18.76	42.33	23.57	227.35	
	20325	1747.5	-18.62	42.10	23.48	222.84	
	20025	1717.5	-24.50	42.99	18.49	70.63	V
	20175	1732.5	-24.19	42.74	18.55	71.61	
	20325	1747.5	-23.60	42.21	18.61	72.61	

LTE Band 4							
Channel Bandwidth: 20 MHz / QPSK							
Plane	Channel	Frequency (MHz)	LVL (dBm)	Correction Factor (dB)	EIRP (dBm)	EIRP (mW)	Polarization (H/V)
Y	20050	1720.0	-17.93	42.49	24.56	285.43	H
	20175	1732.5	-17.84	42.33	24.49	281.00	
	20300	1745.0	-17.60	42.10	24.50	281.84	
	20050	1720.0	-23.46	42.99	19.53	89.74	V
	20175	1732.5	-23.17	42.74	19.57	90.57	
	20300	1745.0	-22.69	42.21	19.52	89.54	
Channel Bandwidth: 20 MHz / 16QAM							
Y	20050	1720.0	-18.94	42.49	23.55	226.20	H
	20175	1732.5	-18.76	42.33	23.57	227.35	
	20300	1745.0	-18.62	42.10	23.48	222.84	
	20050	1720.0	-24.43	42.99	18.56	71.78	V
	20175	1732.5	-24.21	42.74	18.53	71.29	
	20300	1745.0	-23.66	42.21	18.55	71.61	

## 4.2 Frequency Stability Measurement

### 4.2.1 Limits of Frequency Stability Measurement

The frequency stability shall be sufficient to ensure that the fundamental emissions stay within the authorized bands of operation.

### 4.2.2 Test Procedure

- Device is placed at the oven room. The oven room could control the temperatures and humidity. Power warm up is at least 15 min and power applied should perform before recording frequency error.
- EUT is connected the external power supply to control the DC input power. The test voltage range is from minimum to maximum working voltage. Each step shall be record the frequency error rate.
- The temperature range step is 10 degrees in this test items. All temperature levels shall be hold the  $\pm 0.5$  °C during the measurement testing. The each temperature step shall be at least 0.5 hours, consider the EUT could be test under the stability condition.

**Note:** The frequency error was recorded frequency error from the communication simulator.

### 4.2.3 Test Setup

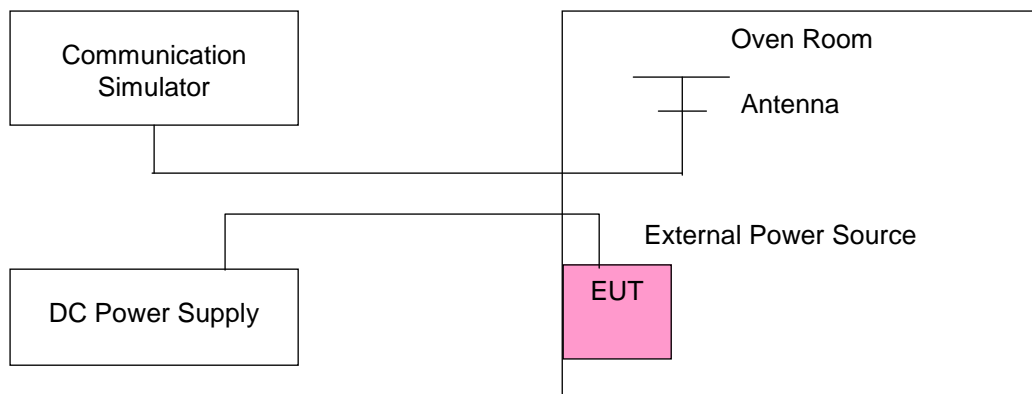

#### 4.2.4 Test Results

##### Frequency Error vs. Voltage

Voltage (Volts)	LTE Band 4				Limit (ppm)
	Channel Bandwidth: 1.4 MHz				
	Low Channel		High Channel		
	Frequency (MHz)	Frequency Error (ppm)	Frequency (MHz)	Frequency Error (ppm)	
3.8	1710.700003	0.002	1754.300003	0.002	2.5
3.3	1710.700004	0.002	1754.300004	0.002	2.5
4.35	1710.700004	0.002	1754.300001	0.001	2.5

**Note:** The applicant defined the normal working voltage of the battery is from 3.3 Vdc to 4.35 Vdc.

##### Frequency Error vs. Temperature

Temp. (°C)	LTE Band 4				Limit (ppm)
	Channel Bandwidth: 1.4 MHz				
	Low Channel		High Channel		
	Frequency (MHz)	Frequency Error (ppm)	Frequency (MHz)	Frequency Error (ppm)	
-30	1710.700001	0.001	1754.300003	0.002	2.5
-20	1710.700003	0.001	1754.300002	0.001	2.5
-10	1710.700001	0.001	1754.300002	0.001	2.5
0	1710.700004	0.002	1754.300002	0.001	2.5
10	1710.700002	0.001	1754.300004	0.002	2.5
20	1710.699996	-0.002	1754.299998	-0.001	2.5
30	1710.699996	-0.002	1754.299996	-0.002	2.5
40	1710.699997	-0.002	1754.299997	-0.002	2.5
50	1710.699997	-0.002	1754.299996	-0.002	2.5
60	1710.699997	-0.002	1754.299997	-0.002	2.5

**Note:**

1. The applicant declared that the normal operating temperature of the EUT is from -20°C to 60°C.
2. The EUT would shut down automatically as below -20°C.



Frequency Error vs. Voltage

Voltage (Volts)	LTE Band 4				Limit (ppm)
	Channel Bandwidth: 3 MHz				
	Low Channel		High Channel		
	Frequency (MHz)	Frequency Error (ppm)	Frequency (MHz)	Frequency Error (ppm)	
3.8	1711.500001	0.001	1753.500004	0.002	2.5
3.3	1711.500002	0.001	1753.500004	0.002	2.5
4.35	1711.500003	0.002	1753.500001	0.001	2.5

**Note:** The applicant defined the normal working voltage of the battery is from 3.3 Vdc to 4.35 Vdc.

Frequency Error vs. Temperature

Temp. (°C)	LTE Band 4				Limit (ppm)
	Channel Bandwidth: 3 MHz				
	Low Channel		High Channel		
	Frequency (MHz)	Frequency Error (ppm)	Frequency (MHz)	Frequency Error (ppm)	
-30	1711.500001	0.001	1753.500003	0.002	2.5
-20	1711.500004	0.002	1753.500003	0.002	2.5
-10	1711.500004	0.002	1753.500002	0.001	2.5
0	1711.500004	0.002	1753.500001	0.001	2.5
10	1711.500004	0.002	1753.500002	0.001	2.5
20	1711.499997	-0.002	1753.499997	-0.002	2.5
30	1711.499999	-0.001	1753.499998	-0.001	2.5
40	1711.499996	-0.002	1753.499998	-0.001	2.5
50	1711.499999	-0.001	1753.499996	-0.002	2.5
60	1711.499997	-0.002	1753.499997	-0.002	2.5

**Note:**

1. The applicant declared that the normal operating temperature of the EUT is from -20°C to 60°C.
2. The EUT would shut down automatically as below -20°C.

Frequency Error vs. Voltage

Voltage (Volts)	LTE Band 4				Limit (ppm)
	Channel Bandwidth: 5 MHz				
	Low Channel		High Channel		
	Frequency (MHz)	Frequency Error (ppm)	Frequency (MHz)	Frequency Error (ppm)	
3.8	1712.500004	0.002	1752.500002	0.001	2.5
3.3	1712.500001	0.001	1752.500003	0.002	2.5
4.35	1712.500002	0.001	1752.500002	0.001	2.5

**Note:** The applicant defined the normal working voltage of the battery is from 3.3 Vdc to 4.35 Vdc.

Frequency Error vs. Temperature

Temp. (°C)	LTE Band 4				Limit (ppm)
	Channel Bandwidth: 5 MHz				
	Low Channel		High Channel		
	Frequency (MHz)	Frequency Error (ppm)	Frequency (MHz)	Frequency Error (ppm)	
-30	1712.500004	0.002	1752.500002	0.001	2.5
-20	1712.500003	0.002	1752.500001	0.001	2.5
-10	1712.500001	0.001	1752.500002	0.001	2.5
0	1712.500002	0.001	1752.500002	0.001	2.5
10	1712.500002	0.001	1752.500003	0.002	2.5
20	1712.499998	-0.001	1752.499997	-0.002	2.5
30	1712.499998	-0.001	1752.499998	-0.001	2.5
40	1712.499999	-0.001	1752.499999	-0.001	2.5
50	1712.499997	-0.002	1752.499997	-0.002	2.5
60	1712.499996	-0.002	1752.499997	-0.002	2.5

**Note:**

1. The applicant declared that the normal operating temperature of the EUT is from -20°C to 60°C.
2. The EUT would shut down automatically as below -20°C.

Frequency Error vs. Voltage

Voltage (Volts)	LTE Band 4				Limit (ppm)
	Channel Bandwidth: 10 MHz				
	Low Channel		High Channel		
	Frequency (MHz)	Frequency Error (ppm)	Frequency (MHz)	Frequency Error (ppm)	
3.8	1715.000002	0.001	1750.000001	0.001	2.5
3.3	1715.000003	0.002	1750.000002	0.001	2.5
4.35	1715.000002	0.001	1750.000003	0.002	2.5

**Note:** The applicant defined the normal working voltage of the battery is from 3.3 Vdc to 4.35 Vdc.

Frequency Error vs. Temperature

Temp. (°C)	LTE Band 4				Limit (ppm)
	Channel Bandwidth: 10 MHz				
	Low Channel		High Channel		
	Frequency (MHz)	Frequency Error (ppm)	Frequency (MHz)	Frequency Error (ppm)	
-30	1715.000002	0.001	1750.000004	0.002	2.5
-20	1715.000003	0.002	1750.000002	0.001	2.5
-10	1715.000004	0.002	1750.000003	0.002	2.5
0	1715.000003	0.002	1750.000003	0.002	2.5
10	1715.000003	0.002	1750.000002	0.001	2.5
20	1714.999997	-0.002	1749.999999	-0.001	2.5
30	1714.999999	-0.001	1749.999999	-0.001	2.5
40	1714.999998	-0.001	1749.999998	-0.001	2.5
50	1714.999998	-0.001	1749.999999	-0.001	2.5
60	1714.999996	-0.002	1749.999997	-0.002	2.5

**Note:**

1. The applicant declared that the normal operating temperature of the EUT is from -20°C to 60°C.
2. The EUT would shut down automatically as below -20°C.

Frequency Error vs. Voltage

Voltage (Volts)	LTE Band 4				Limit (ppm)
	Channel Bandwidth: 15 MHz				
	Low Channel		High Channel		
	Frequency (MHz)	Frequency Error (ppm)	Frequency (MHz)	Frequency Error (ppm)	
3.8	1717.500004	0.002	1747.500003	0.001	2.5
3.3	1717.500003	0.002	1747.500003	0.002	2.5
4.35	1717.500003	0.002	1747.500003	0.002	2.5

**Note:** The applicant defined the normal working voltage of the battery is from 3.3 Vdc to 4.35 Vdc.

Frequency Error vs. Temperature

Temp. (°C)	LTE Band 4				Limit (ppm)
	Channel Bandwidth: 15 MHz				
	Low Channel		High Channel		
	Frequency (MHz)	Frequency Error (ppm)	Frequency (MHz)	Frequency Error (ppm)	
-30	1717.500002	0.001	1747.500002	0.001	2.5
-20	1717.500002	0.001	1747.500004	0.002	2.5
-10	1717.500001	0.001	1747.500004	0.002	2.5
0	1717.500002	0.001	1747.500004	0.002	2.5
10	1717.500002	0.001	1747.500003	0.001	2.5
20	1717.499998	-0.001	1747.499997	-0.002	2.5
30	1717.499996	-0.002	1747.499999	-0.001	2.5
40	1717.499996	-0.002	1747.499997	-0.002	2.5
50	1717.499997	-0.002	1747.499999	-0.001	2.5
60	1717.499999	-0.001	1747.499998	-0.001	2.5

**Note:**

1. The applicant declared that the normal operating temperature of the EUT is from -20°C to 60°C.
2. The EUT would shut down automatically as below -20°C.

Frequency Error vs. Voltage

Voltage (Volts)	LTE Band 4				Limit (ppm)
	Channel Bandwidth: 20 MHz				
	Low Channel		High Channel		
	Frequency (MHz)	Frequency Error (ppm)	Frequency (MHz)	Frequency Error (ppm)	
3.8	1720.000003	0.001	1745.000001	0.001	2.5
3.3	1720.000002	0.001	1745.000003	0.002	2.5
4.35	1720.000001	0.001	1745.000002	0.001	2.5

**Note:** The applicant defined the normal working voltage of the battery is from 3.3 Vdc to 4.35 Vdc.

Frequency Error vs. Temperature

Temp. (°C)	LTE Band 4				Limit (ppm)
	Channel Bandwidth: 20 MHz				
	Low Channel		High Channel		
	Frequency (MHz)	Frequency Error (ppm)	Frequency (MHz)	Frequency Error (ppm)	
-30	1720.000003	0.002	1745.000002	0.001	2.5
-20	1720.000001	0.001	1745.000003	0.002	2.5
-10	1720.000003	0.002	1745.000002	0.001	2.5
0	1720.000003	0.002	1745.000003	0.002	2.5
10	1720.000001	0.001	1745.000004	0.002	2.5
20	1719.999998	-0.001	1744.999999	-0.001	2.5
30	1719.999997	-0.002	1744.999996	-0.002	2.5
40	1719.999998	-0.001	1744.999997	-0.001	2.5
50	1719.999999	-0.001	1744.999998	-0.001	2.5
60	1719.999998	-0.001	1744.999998	-0.001	2.5

**Note:**

1. The applicant declared that the normal operating temperature of the EUT is from -20°C to 60°C.
2. The EUT would shut down automatically as below -20°C.

Frequency Error vs. Voltage

Voltage (Volts)	LTE Band 13				Limit (ppm)
	Channel Bandwidth: 5 MHz				
	Low Channel		High Channel		
	Frequency (MHz)	Frequency Error (ppm)	Frequency (MHz)	Frequency Error (ppm)	
3.8	779.500002	0.003	784.500001	0.002	2.5
3.3	779.500002	0.002	784.500001	0.001	2.5
4.35	779.500004	0.004	784.500003	0.004	2.5

**Note:** The applicant defined the normal working voltage of the battery is from 3.3 Vdc to 4.35 Vdc.

Frequency Error vs. Temperature

Temp. (°C)	LTE Band 13				Limit (ppm)
	Channel Bandwidth: 5 MHz				
	Low Channel		High Channel		
	Frequency (MHz)	Frequency Error (ppm)	Frequency (MHz)	Frequency Error (ppm)	
-30	779.500003	0.004	784.500004	0.005	2.5
-20	779.500003	0.004	784.500002	0.002	2.5
-10	779.500001	0.002	784.500001	0.001	2.5
0	779.500003	0.004	784.500002	0.002	2.5
10	779.500003	0.004	784.500003	0.004	2.5
20	779.499997	-0.004	784.499998	-0.003	2.5
30	779.499999	-0.002	784.499999	-0.001	2.5
40	779.499998	-0.003	784.499997	-0.003	2.5
50	779.499997	-0.003	784.499997	-0.003	2.5
60	779.499997	-0.004	784.499997	-0.004	2.5

**Note:**

1. The applicant declared that the normal operating temperature of the EUT is from -20°C to 60°C.
2. The EUT would shut down automatically as below -20°C.

Frequency Error vs. Voltage

Voltage (Volts)	LTE Band 13		Limit (ppm)
	Channel Bandwidth: 10 MHz		
	Frequency (MHz)	Frequency Error (ppm)	
3.8	782.000003	0.004	2.5
3.3	782.000003	0.003	2.5
4.35	782.000003	0.004	2.5

**Note:** The applicant defined the normal working voltage of the battery is from 3.3 Vdc to 4.35 Vdc.

Frequency Error vs. Temperature

Temp. (°C)	LTE Band 13		Limit (ppm)
	Channel Bandwidth: 10 MHz		
	Frequency (MHz)	Frequency Error (ppm)	
-30	782.000003	0.004	2.5
-20	782.000001	0.002	2.5
-10	782.000002	0.002	2.5
0	782.000004	0.005	2.5
10	782.000004	0.005	2.5
20	781.999998	-0.002	2.5
30	781.999999	-0.001	2.5
40	781.999996	-0.005	2.5
50	781.999997	-0.004	2.5
60	781.999998	-0.003	2.5

**Note:**

1. The applicant declared that the normal operating temperature of the EUT is from -20°C to 60°C.
2. The EUT would shut down automatically as below -20°C.

### 4.3 Occupied Bandwidth Measurement

#### 4.3.1 Limits of Occupied Bandwidth Measurement

The width of a frequency band such that, below the lower and above the upper frequency limits, the mean powers emitted are each equal to a specified percentage 0.5 % of the total mean power of a given emission.

#### 4.3.2 Test Procedure

- The conducted occupied bandwidth used the power splitter via EUT RF power connector between simulation base station and spectrum analyzer.
- Use OBW measurement function of Spectrum analyzer to measure 99 % occupied bandwidth.

#### 4.3.3 Test Setup

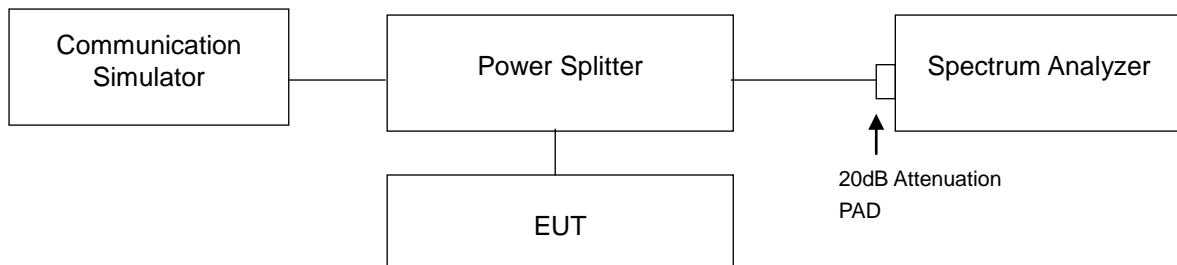



### 4.3.4 Test Result

LTE Band 4							
Channel Bandwidth: 1.4 MHz				Channel Bandwidth: 3 MHz			
Channel	Frequency (MHz)	99 % Occupied Bandwidth (MHz)		Channel	Frequency (MHz)	99 % Occupied Bandwidth (MHz)	
		QPSK	16QAM			QPSK	16QAM
19957	1710.7	1.09	1.09	19965	1711.5	2.70	2.70
20175	1732.5	1.09	1.09	20175	1732.5	2.70	2.70
20393	1754.3	1.09	1.09	20385	1753.5	2.70	2.70

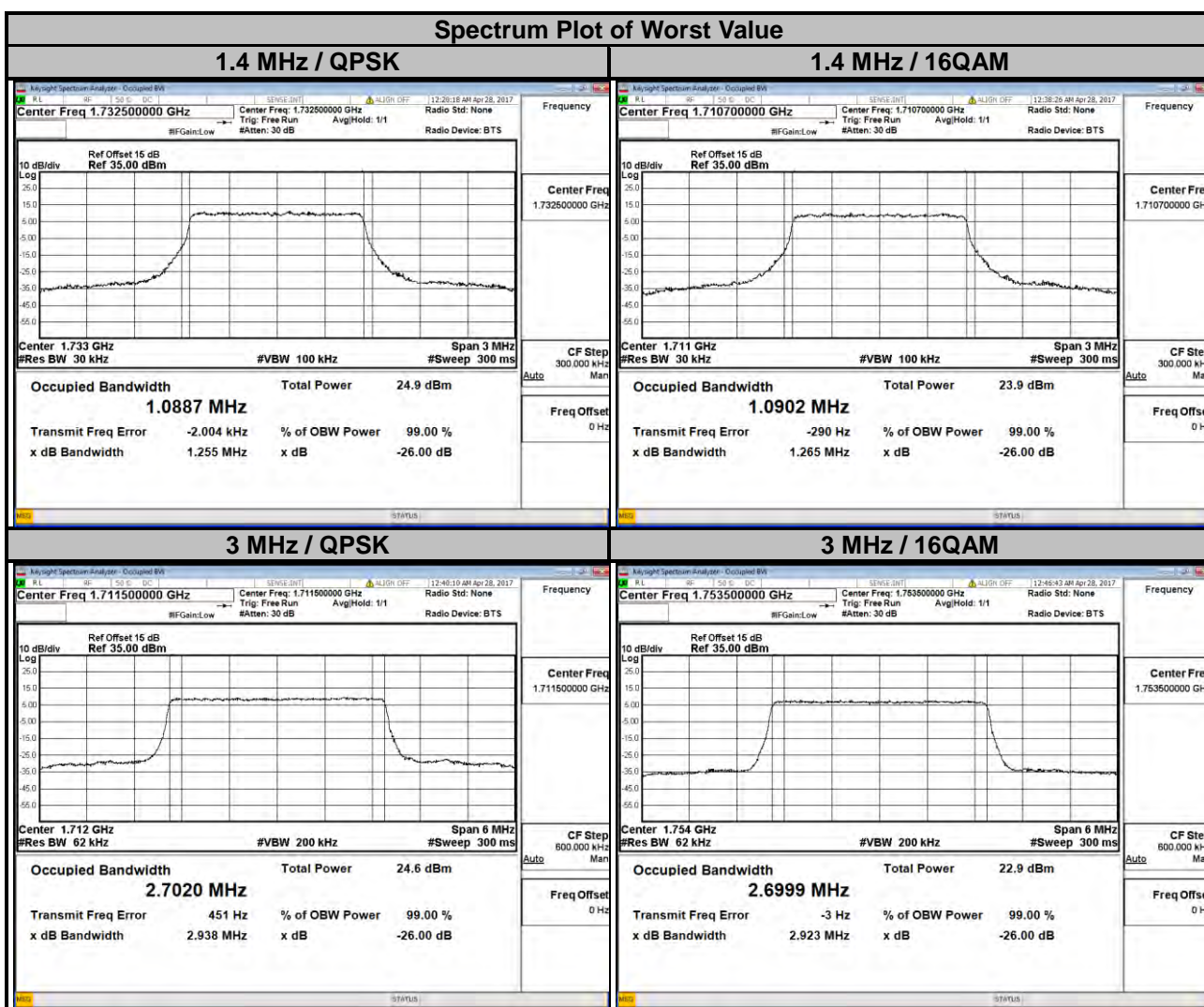

### LTE Band 4

Channel Bandwidth: 5 MHz				Channel Bandwidth: 10 MHz			
Channel	Frequency (MHz)	99 % Occupied Bandwidth (MHz)		Channel	Frequency (MHz)	99 % Occupied Bandwidth (MHz)	
		QPSK	16QAM			QPSK	16QAM
19975	1712.5	4.49	4.50	20000	1715.0	8.96	8.97
20175	1732.5	4.49	4.49	20175	1732.5	8.97	8.97
20375	1752.5	4.49	4.49	20350	1750.0	8.97	8.96

### Spectrum Plot of Worst Value

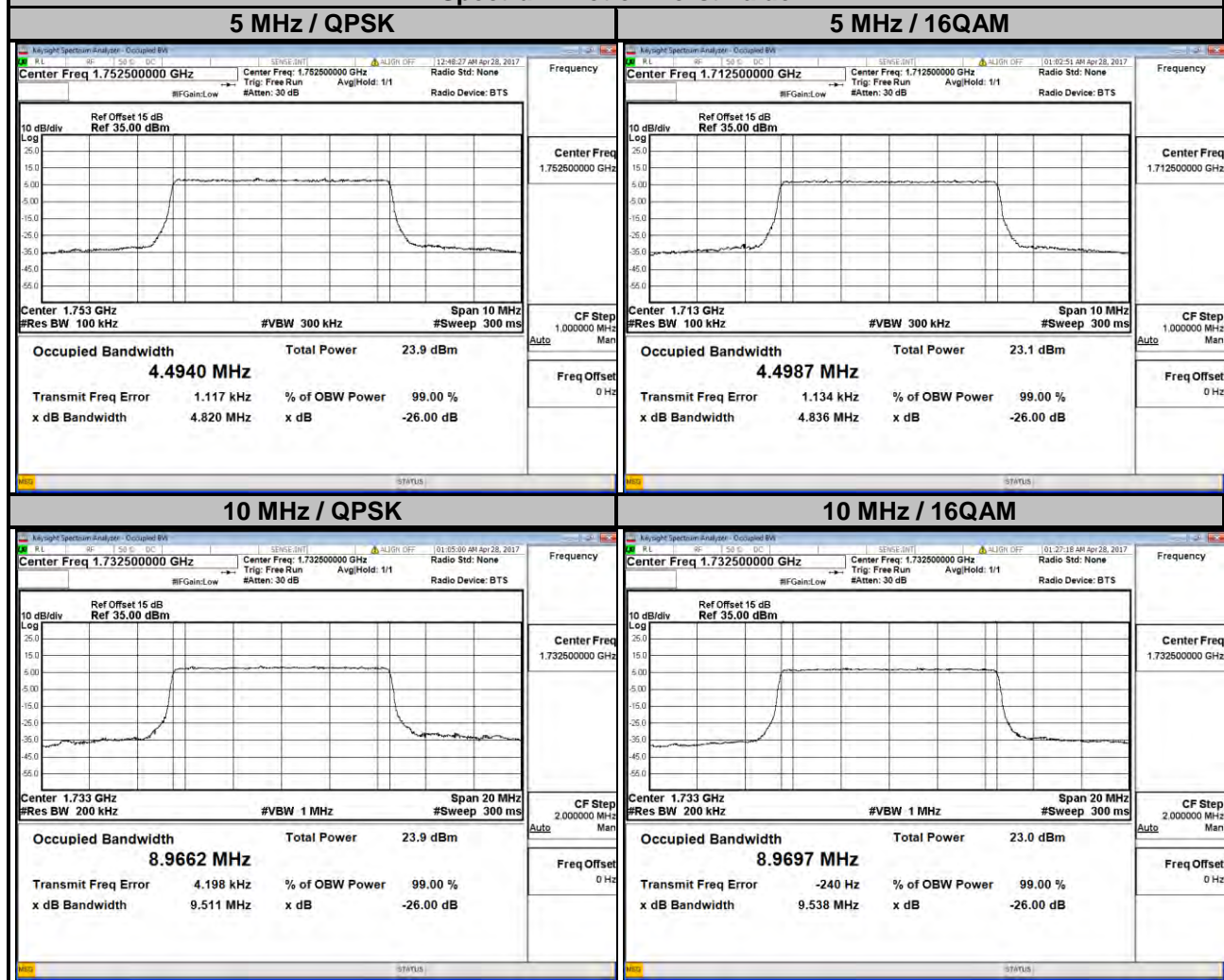

### LTE Band 4

Channel Bandwidth: 15 MHz				Channel Bandwidth: 20 MHz			
Channel	Frequency (MHz)	99 % Occupied Bandwidth (MHz)		Channel	Frequency (MHz)	99 % Occupied Bandwidth (MHz)	
		QPSK	16QAM			QPSK	16QAM
20025	1717.5	13.47	13.46	20050	1720.0	17.93	17.96
20175	1732.5	13.47	14.46	20175	1732.5	17.93	17.95
20325	1747.5	13.47	13.45	20300	1745.0	17.92	17.94

### Spectrum Plot of Worst Value

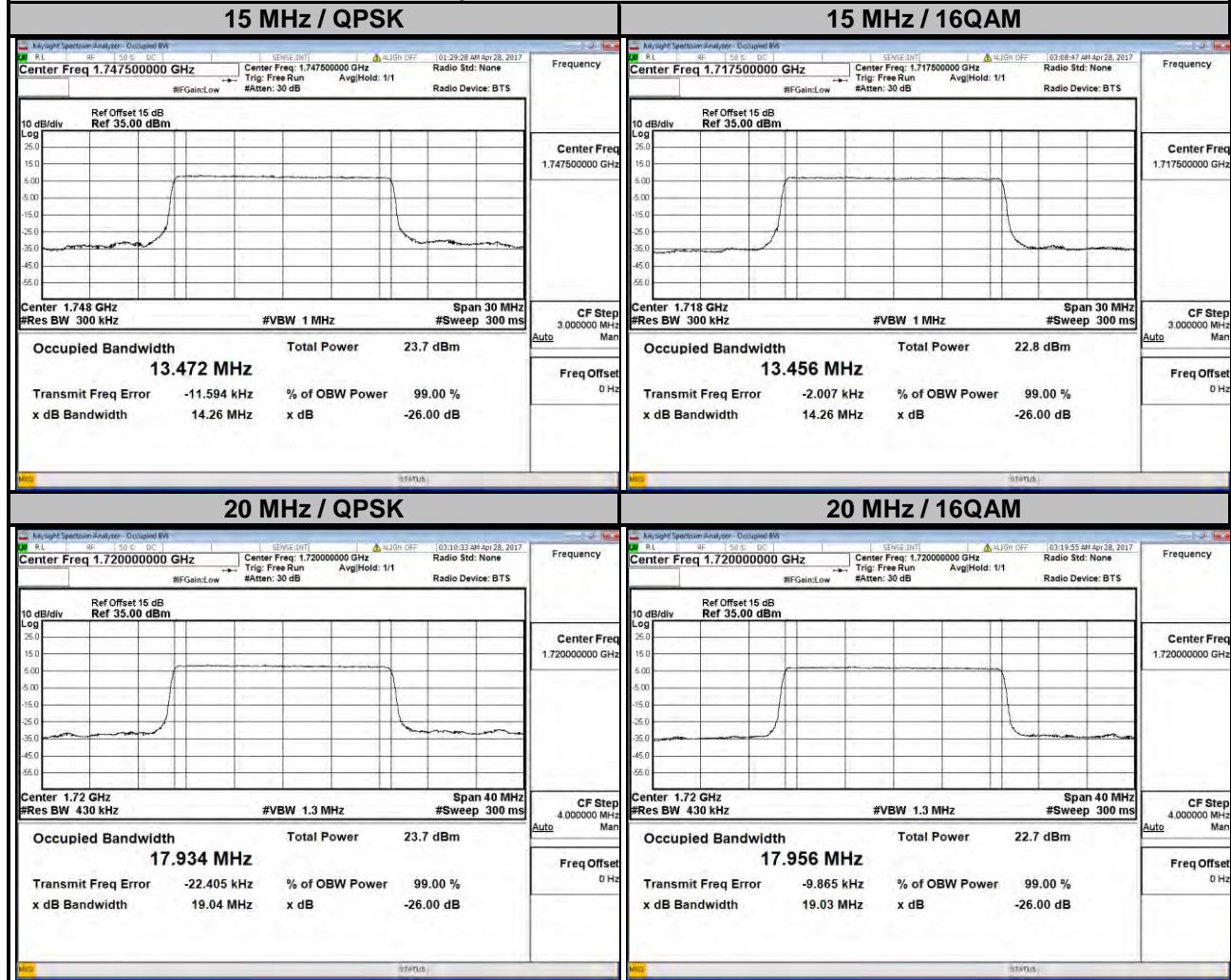

### LTE Band 13

#### Channel Bandwidth: 5 MHz

#### Channel Bandwidth: 10 MHz

Channel	Frequency (MHz)	99 % Occupied Bandwidth (MHz)		Channel	Frequency (MHz)	99 % Occupied Bandwidth (MHz)	
		QPSK	16QAM			QPSK	16QAM
23205	779.5	4.49	4.49	23230	782.0	8.96	8.96
23230	782.0	4.49	4.49				
23255	784.5	4.50	4.50				

### Spectrum Plot of Worst Value

#### 5 MHz / QPSK

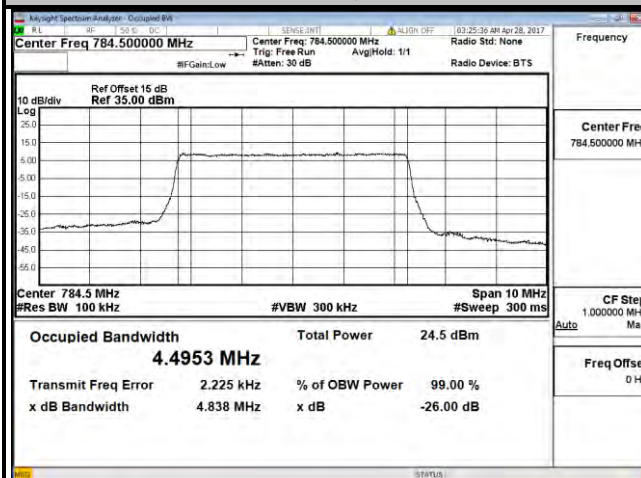

#### 5 MHz / 16QAM

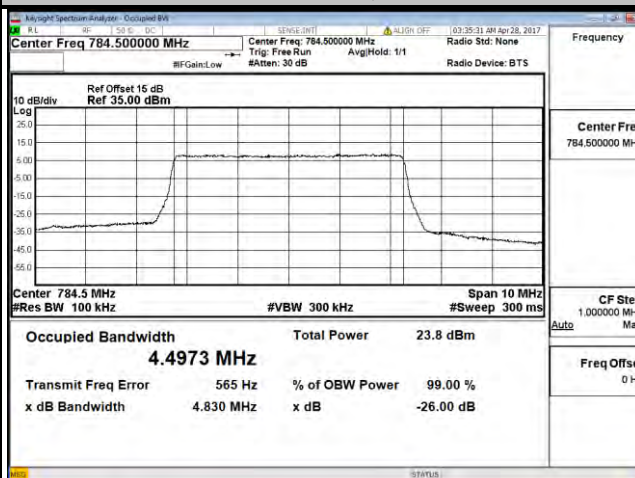

#### 10 MHz / QPSK

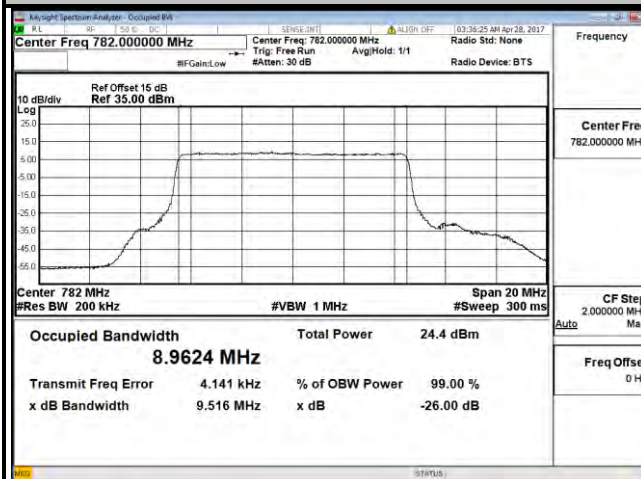

#### 10 MHz / 16QAM

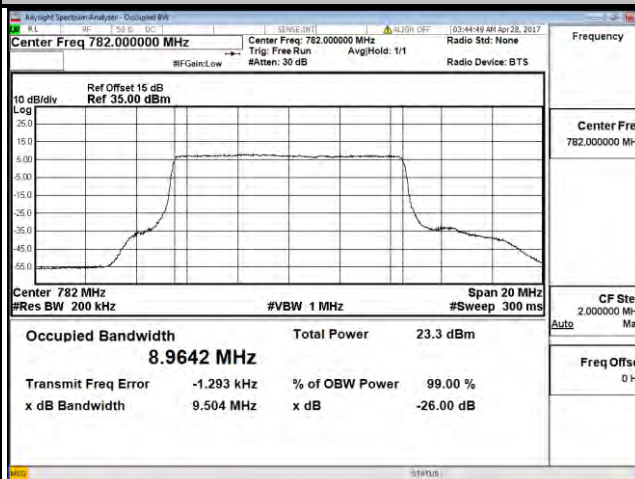

## 4.4 Band Edge Measurement

### 4.4.1 Limits of Band Edge Measurement

For operations in the 776-787 MHz band, the power of any emission outside a licensee's frequency band(s) of operation shall be attenuated below the transmitter power (P) within the licensed band(s) of operation, measured in watts, by at least  $43 + 10 \log(P)$  dB. Compliance with this provision is based on the use of measurement instrumentation employing a resolution bandwidth of 100 kilohertz or greater.

However, in the 100 kilohertz bands immediately outside and adjacent to a licensee's frequency block, a resolution bandwidth of at least 30 kHz may be employed.

For operations in the 1710–1755 MHz bands, the power of any emission outside a licensee's frequency block shall be attenuated below the transmitter power (P) by at least  $43 + 10 \log_{10}(P)$  dB.

### 4.4.2 Test Setup

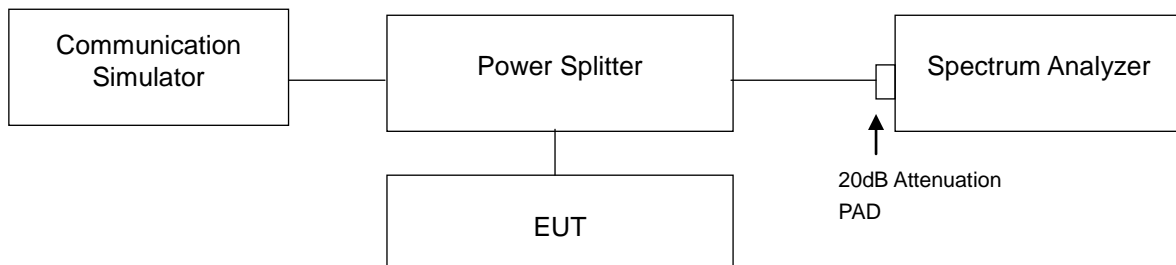

### 4.4.3 Test Procedures

- a. All measurements were done at low and high operational frequency range.
- b. The center frequency of spectrum is the band edge frequency and span is 1 MHz. RB of the spectrum is 13 kHz and VB of the spectrum is 51 kHz (LTE Bandwidth 1.4 MHz).
- c. The center frequency of spectrum is the band edge frequency and span is 1 MHz. RB of the spectrum is 30 kHz and VB of the spectrum is 100 kHz (LTE Bandwidth 3 MHz).
- d. The center frequency of spectrum is the band edge frequency and span is 1 MHz. RB of the spectrum is 100 kHz and VB of the spectrum is 300 kHz (LTE Bandwidth 5 MHz/10 MHz).
- e. The center frequency of spectrum is the band edge frequency and span is 1 MHz. RB of the spectrum is 150 kHz and VB of the spectrum is 470 kHz (LTE Bandwidth 15 MHz).
- f. The center frequency of spectrum is the band edge frequency and span is 1 MHz. RB of the spectrum is 180 kHz and VB of the spectrum is 560 kHz (LTE Bandwidth 20 MHz).
- g. Record the max trace plot into the test report.

### 4.4.4 Test Results

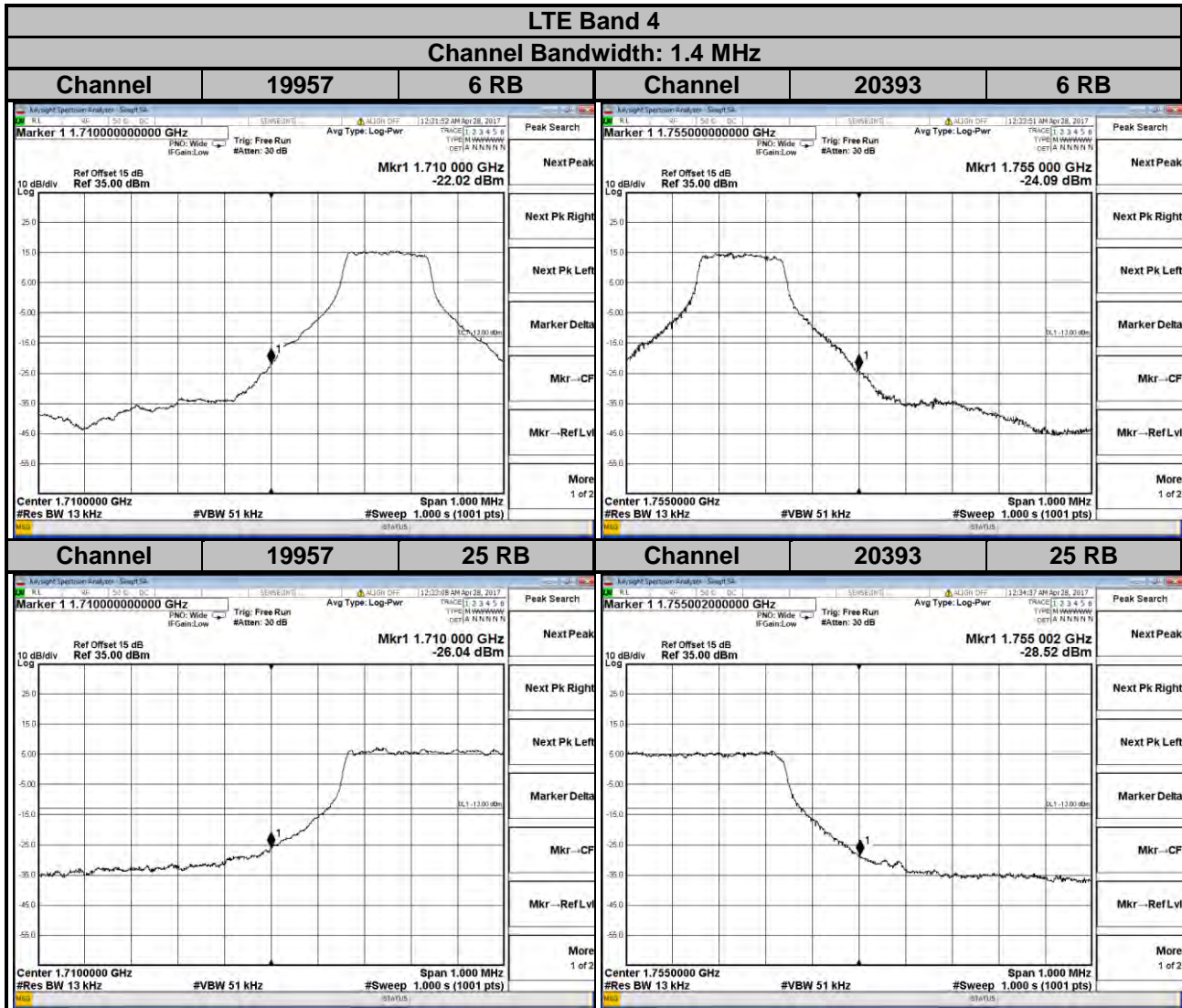

**LTE Band 4**  
**Channel Bandwidth: 3 MHz**

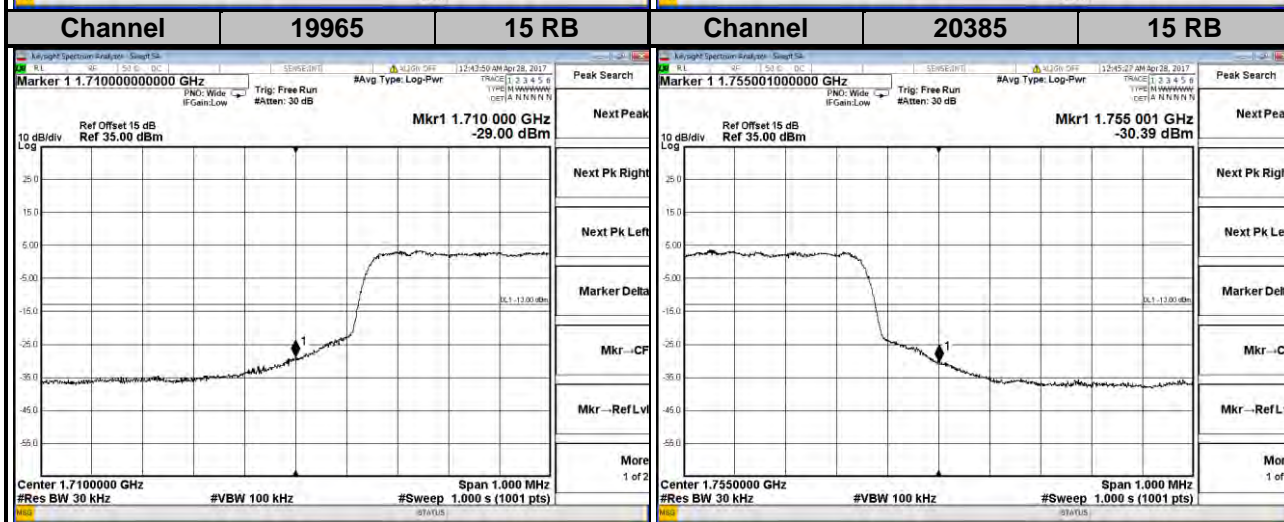
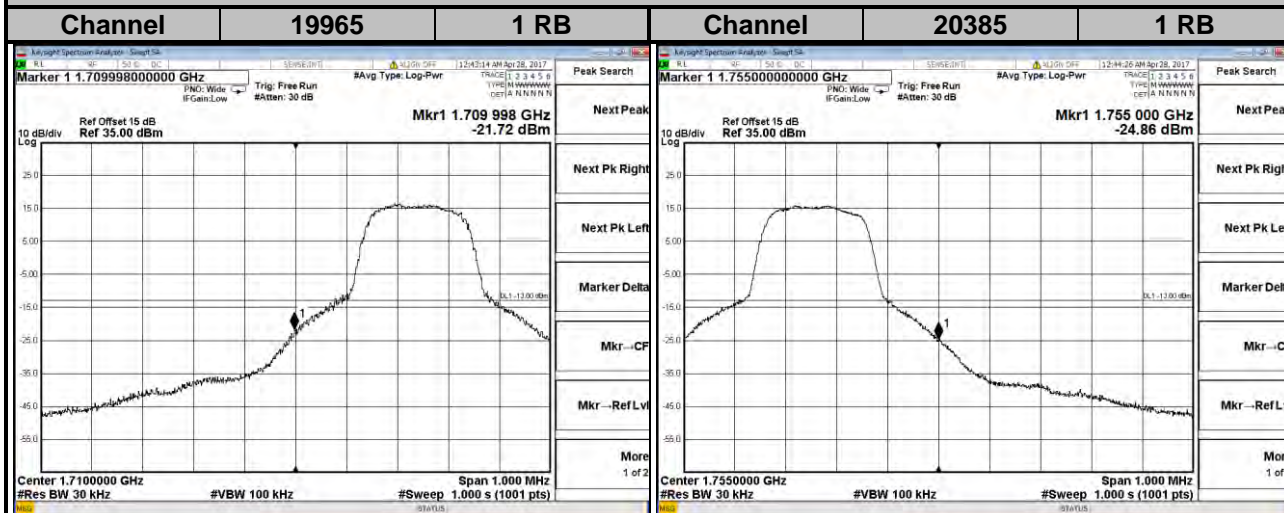

**LTE Band 4**  
**Channel Bandwidth: 5 MHz**

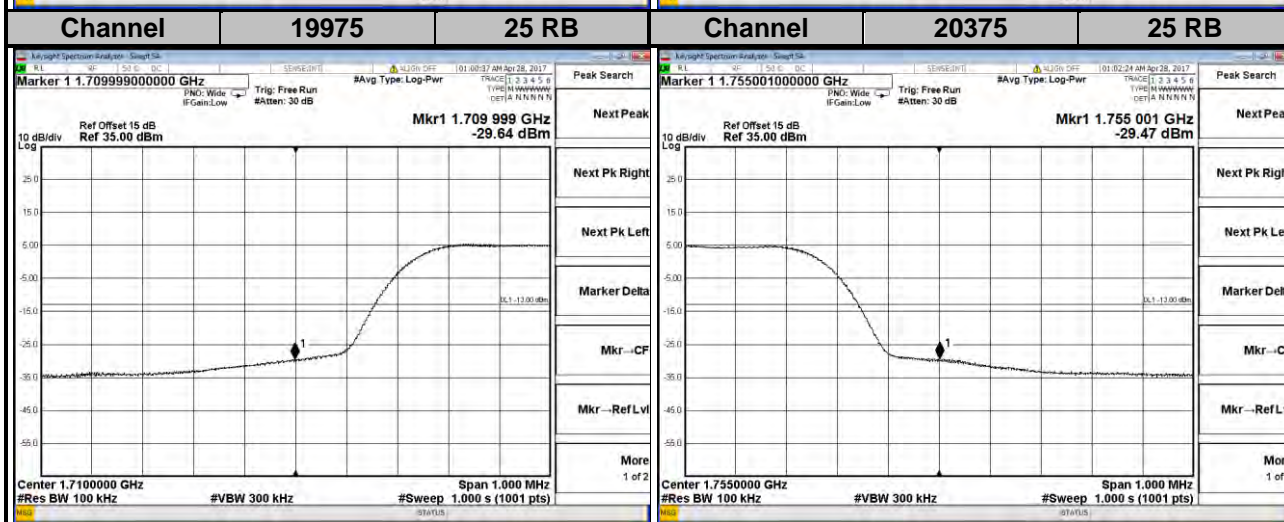
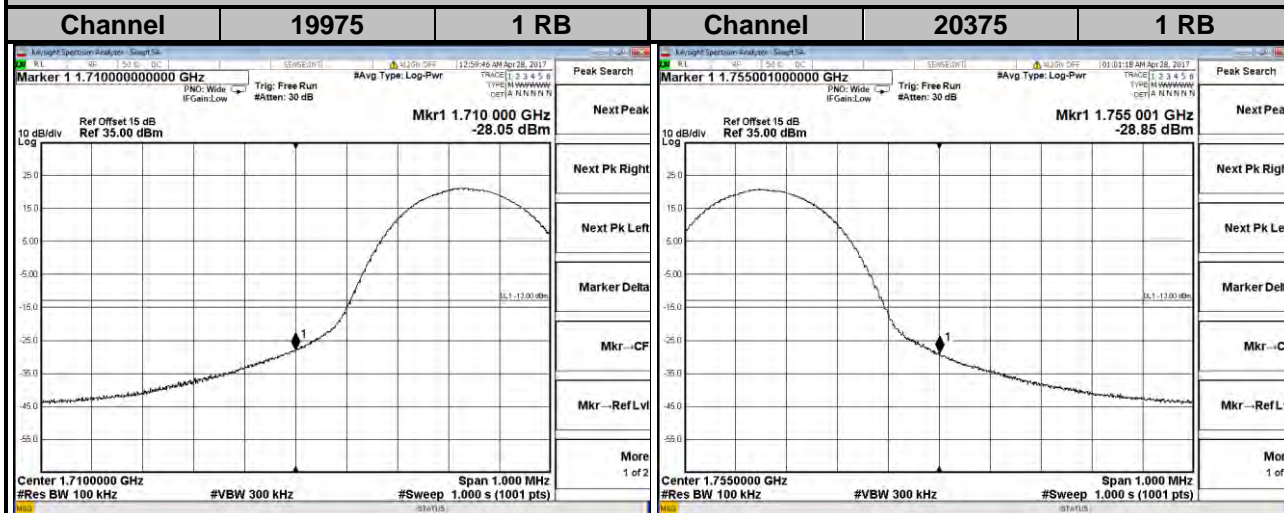



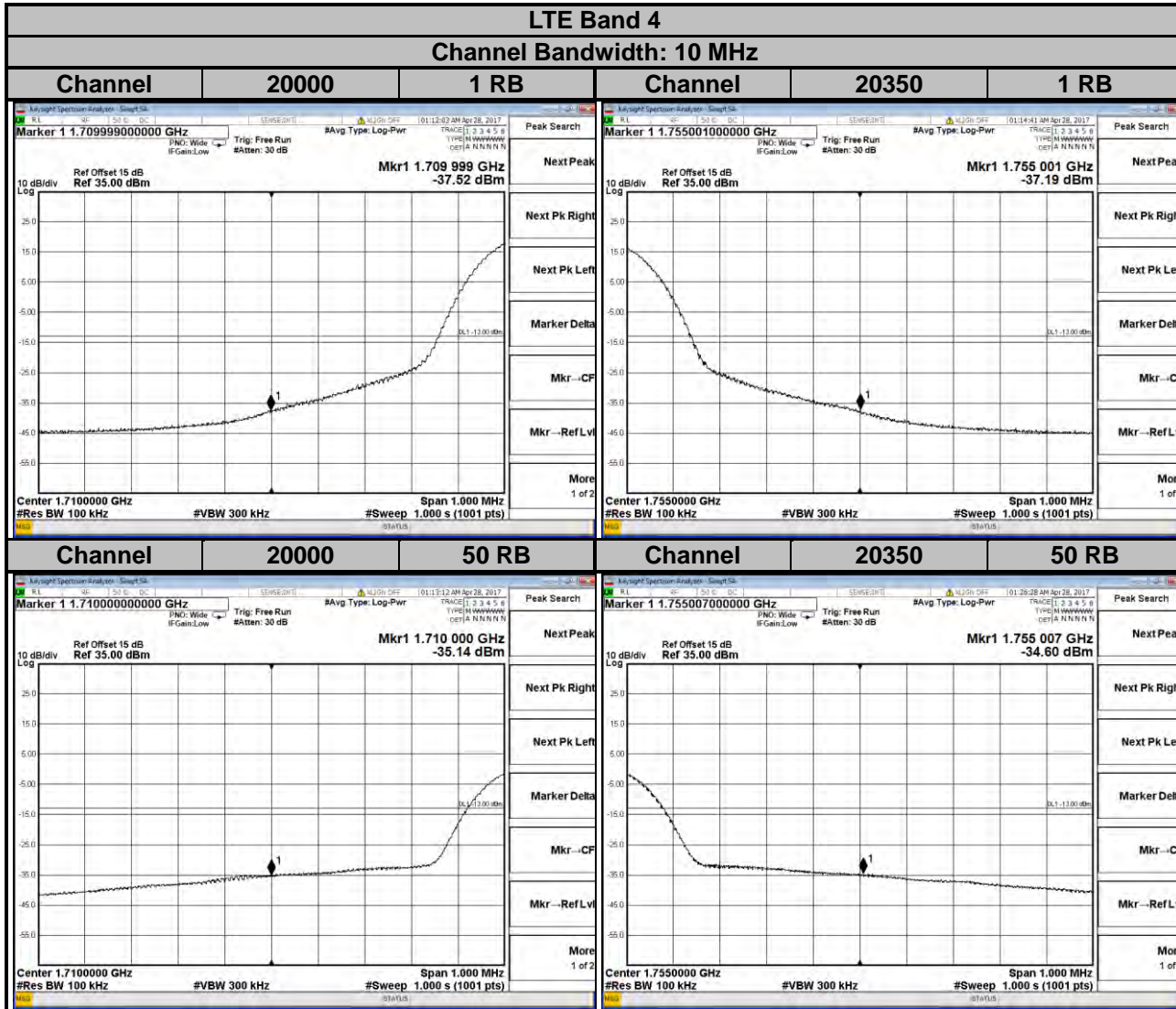

**LTE Band 4**  
**Channel Bandwidth: 15 MHz**

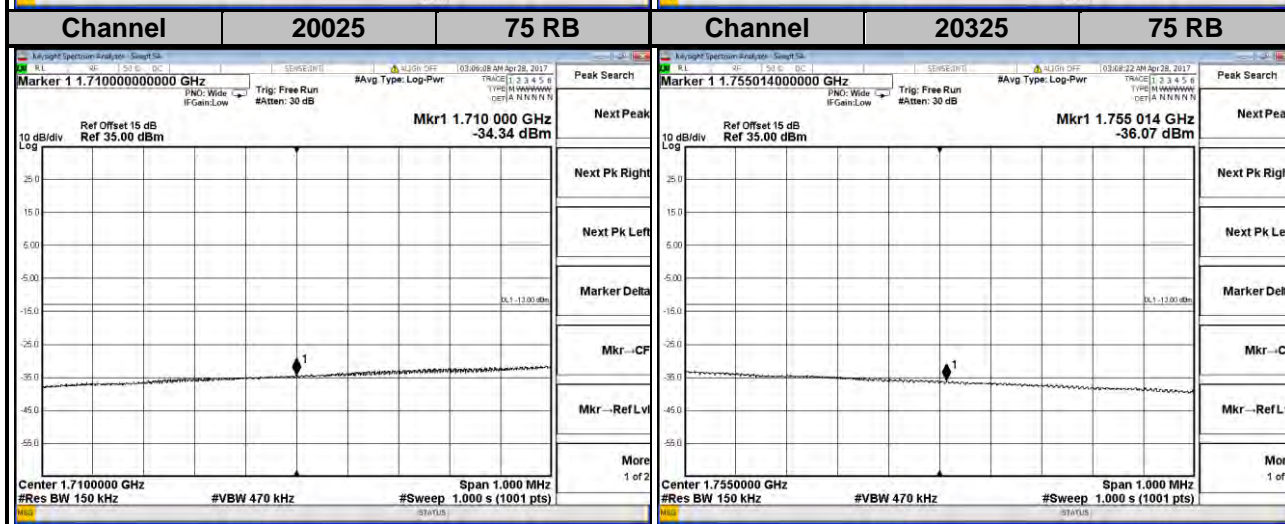
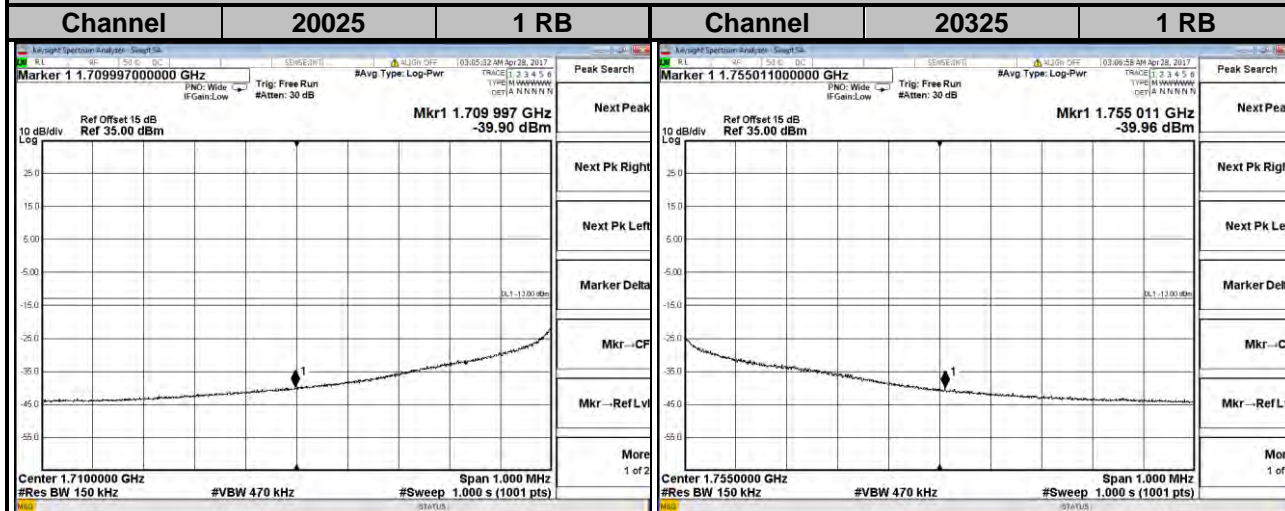

**LTE Band 4**  
**Channel Bandwidth: 20 MHz**

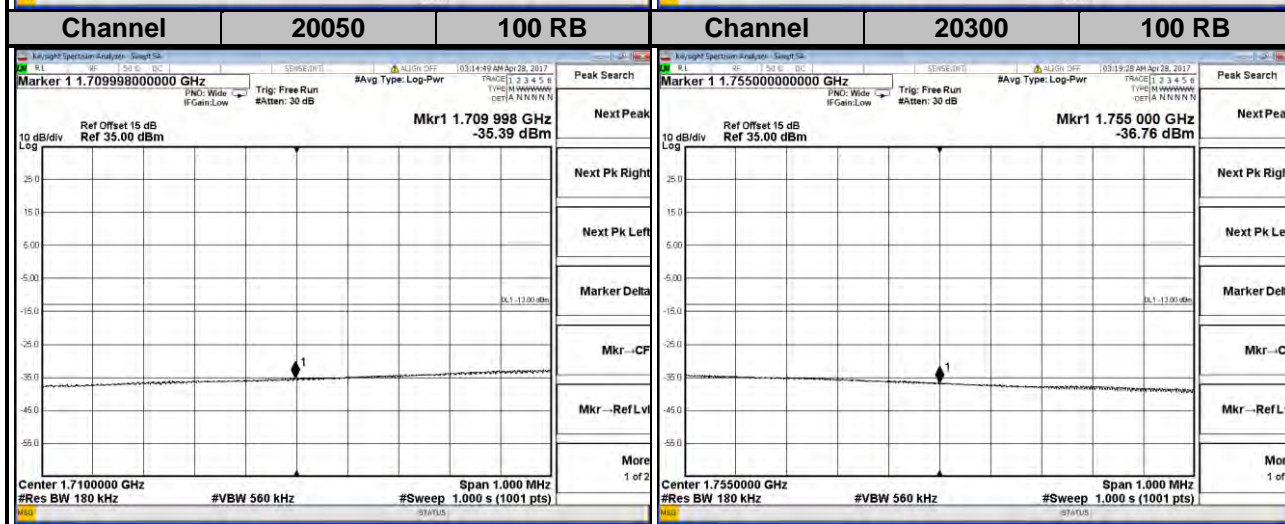
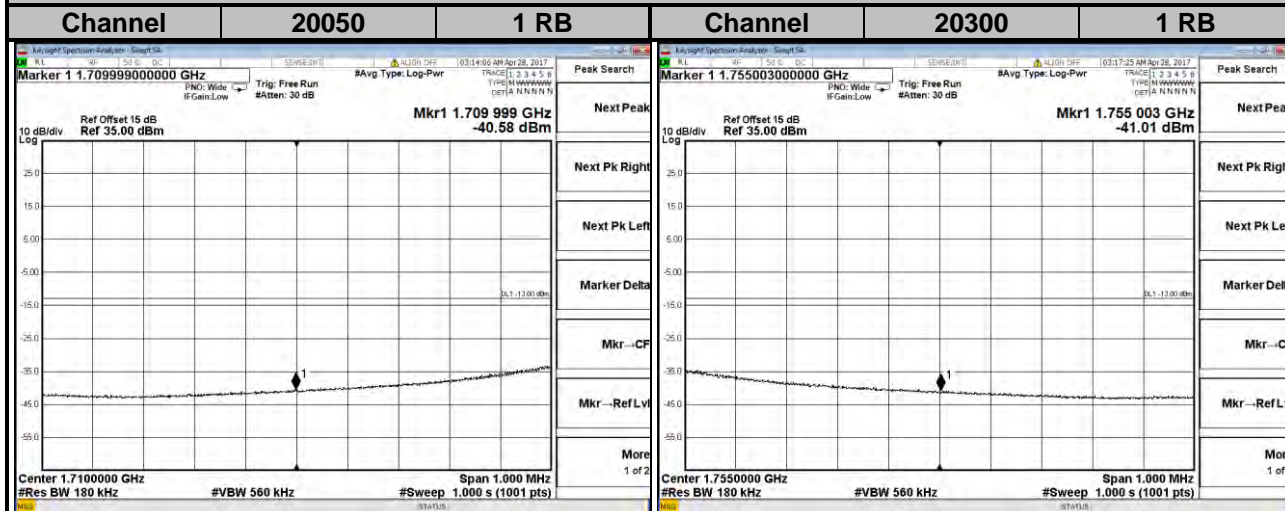

**LTE Band 13**  
**Channel Bandwidth: 5 MHz**

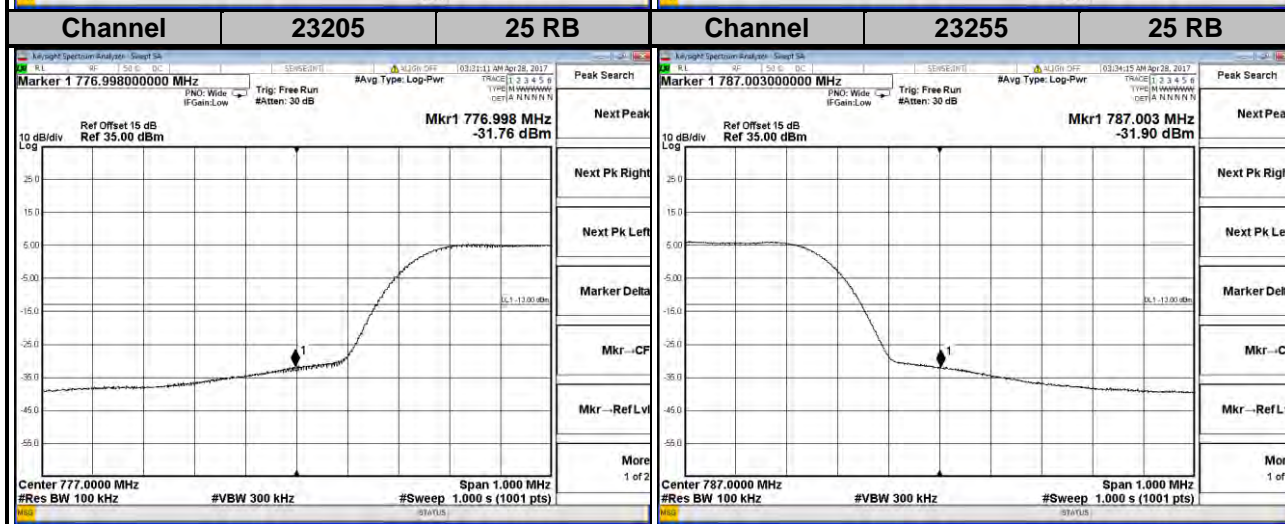
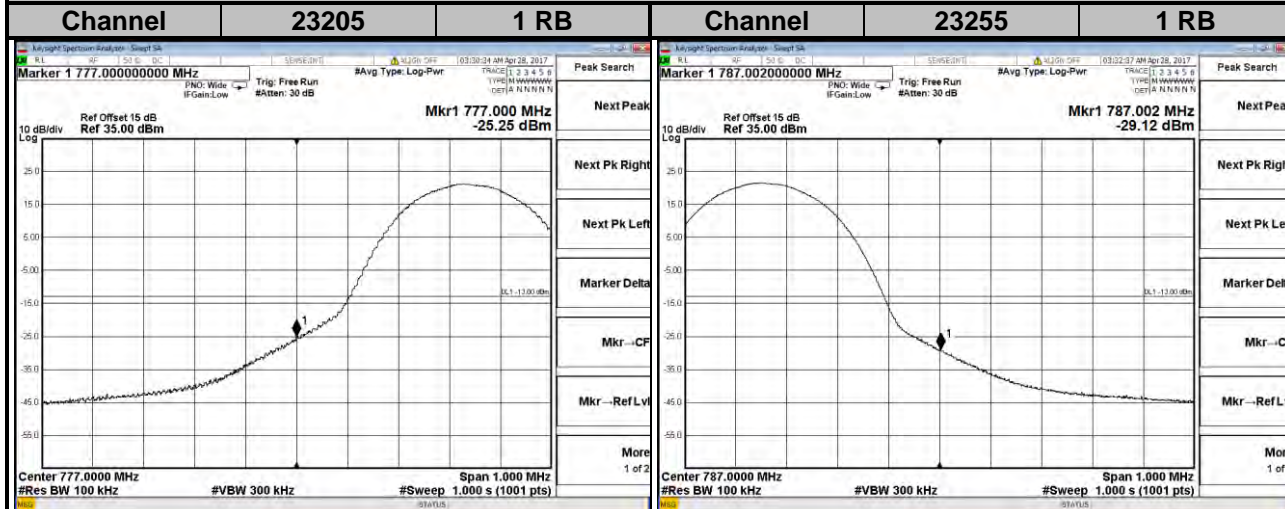

**LTE Band 13**  
**Channel Bandwidth: 10 MHz**

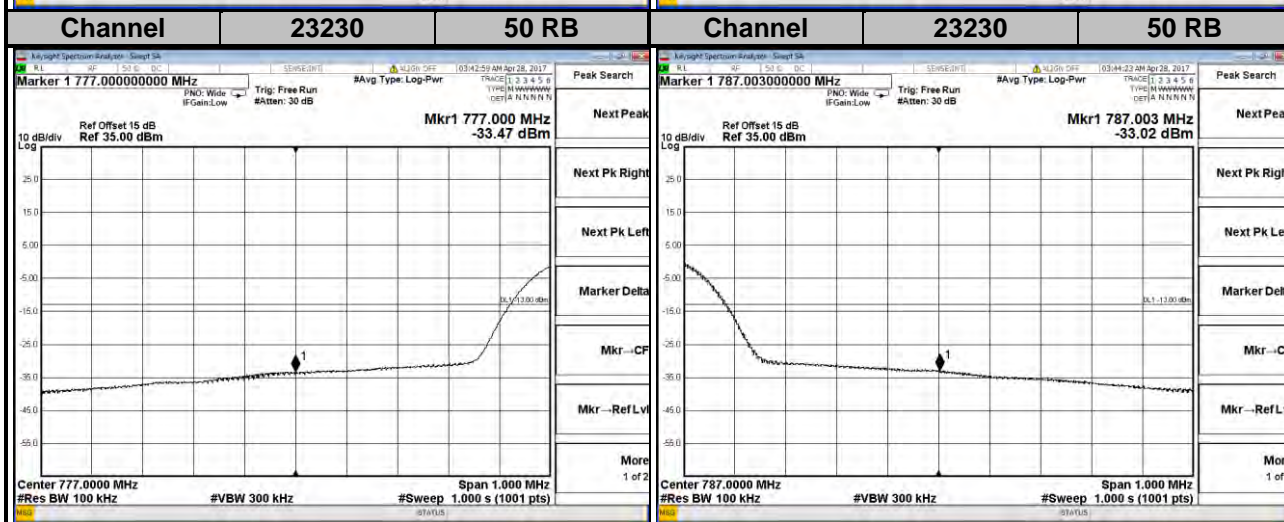
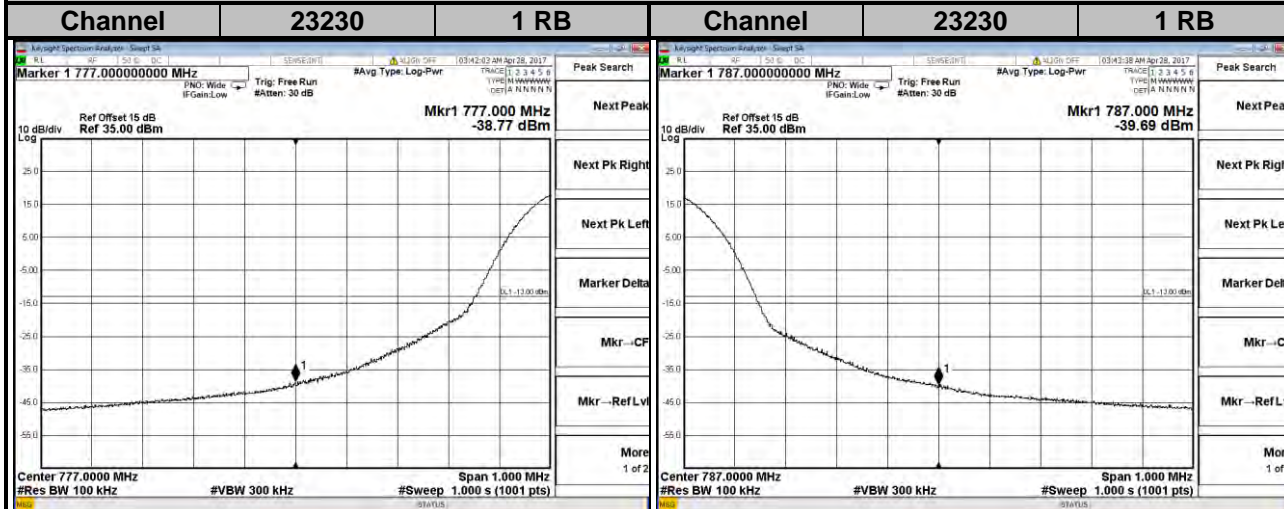

### Emission Mask

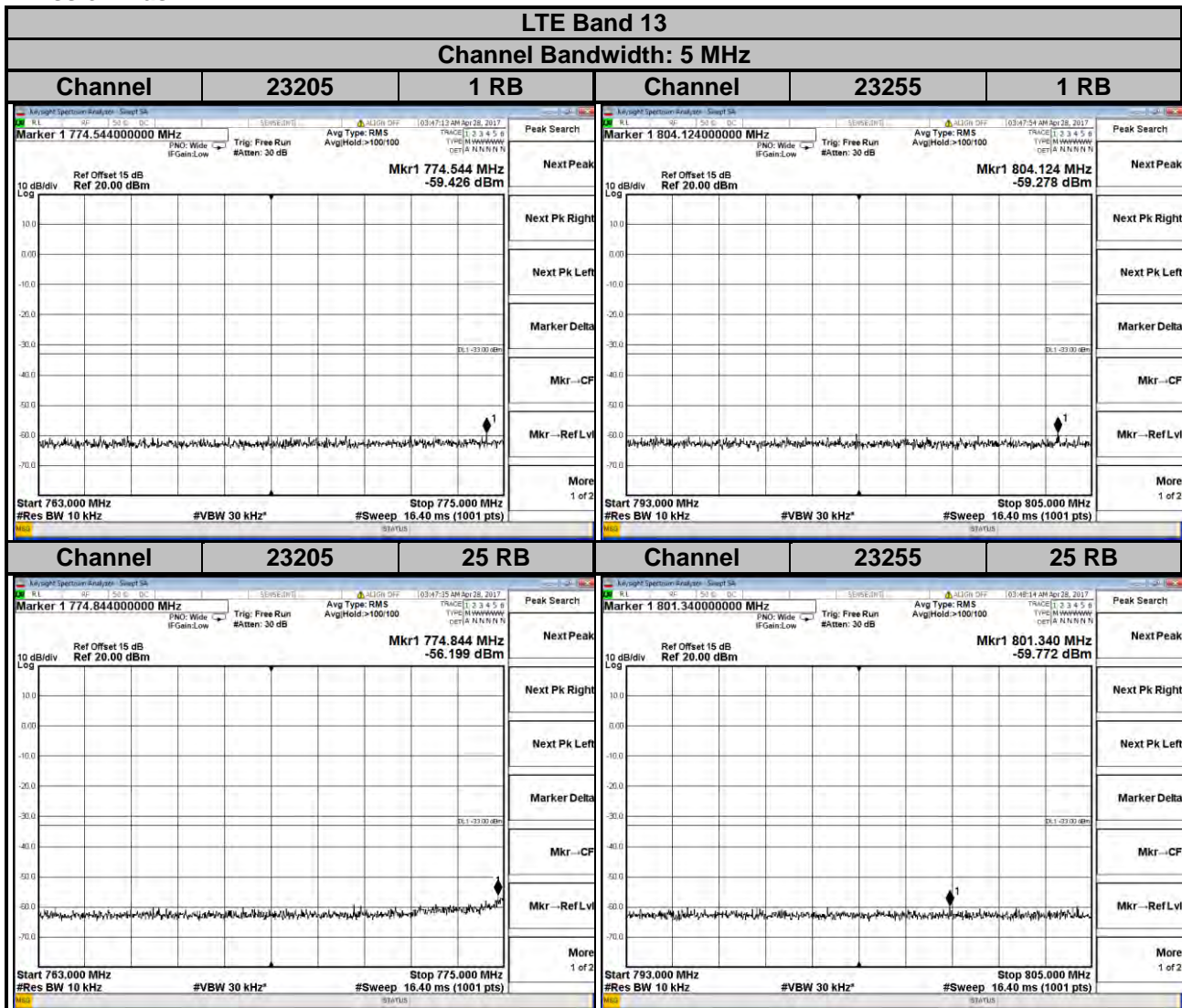

For the 763 - 775 MHz and 793 - 805 MHz band ,the FCC limit is  $65+10\log(P[\text{watt}])$  in a 6.25 kHz bandwidth . Since it was not possible to set the resolution bandwidth to 6.25 kHz with the available equipment , a bandwidth of 10 kHz was used instead to show compliance. By using a 10 kHz bandwidth on the spectrum analyzer.

$$10\log(10\text{kHz}/6.25\text{kHz}) = 2.04 \text{ dB}$$

$$\text{Limit line} = -35 \text{ dBm} + 2.04 \text{ dB} = -32.96 \text{ dBm}$$

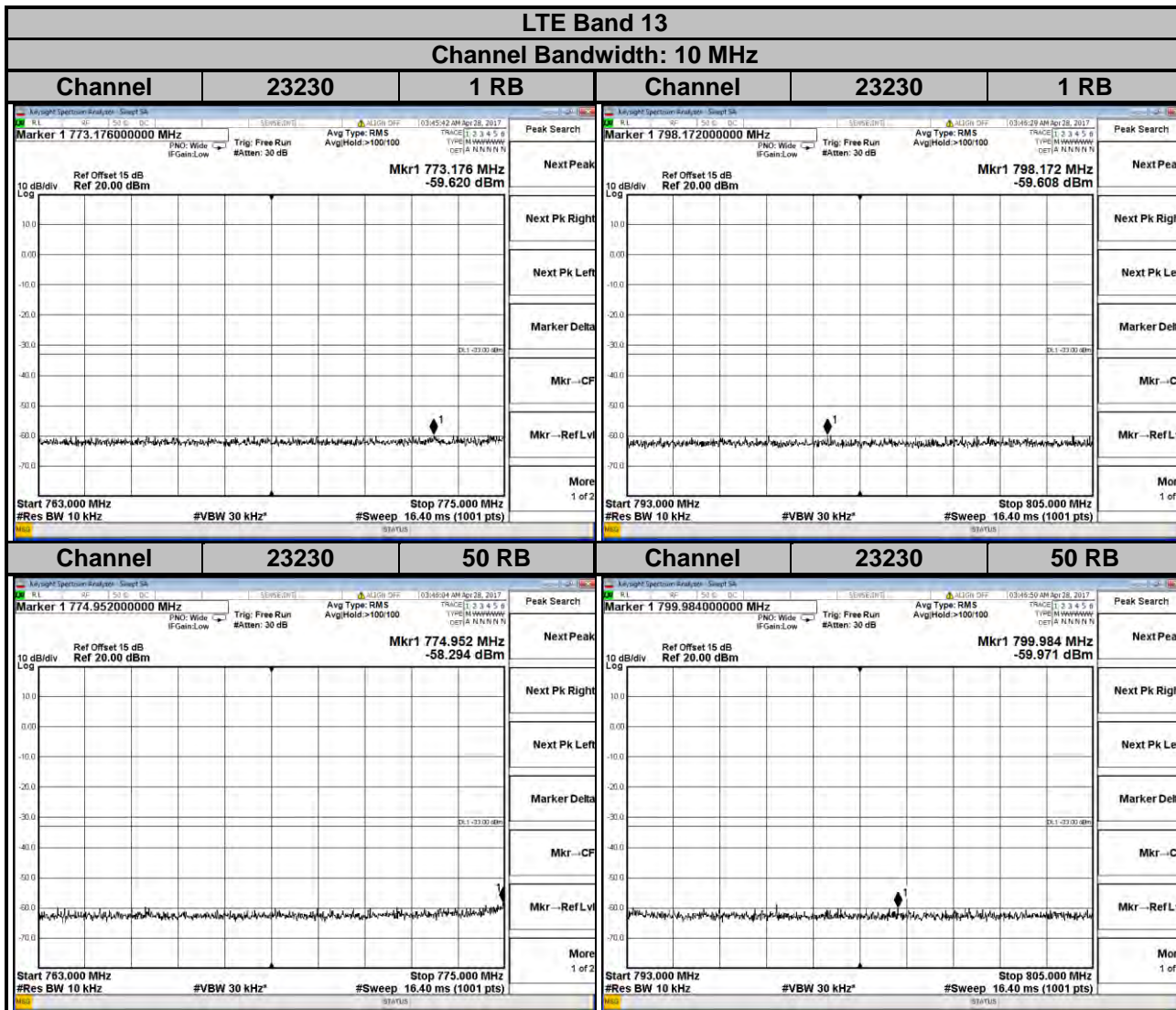

For the 763 - 775 MHz and 793 - 805 MHz band ,the FCC limit is  $65+10\log(P[\text{watt}])$  in a 6.25 kHz bandwidth . Since it was not possible to set the resolution bandwidth to 6.25 kHz with the available equipment , a bandwidth of 10 kHz was used instead to show compliance. By using a 10 kHz bandwidth on the spectrum analyzer.

$$10\log(10\text{kHz}/6.25\text{kHz}) = 2.04 \text{ dB}$$

$$\text{Limit line} = -35 \text{ dBm} + 2.04 \text{ dB} = -32.96 \text{ dBm}$$

## 4.5 Peak to Average Ratio

### 4.5.1 Limits of Peak to Average Ratio Measurement

In measuring transmissions in this band using an average power technique, the peak to-average ratio (PAR) of the transmission may not exceed 13 dB.

### 4.5.2 Test Setup

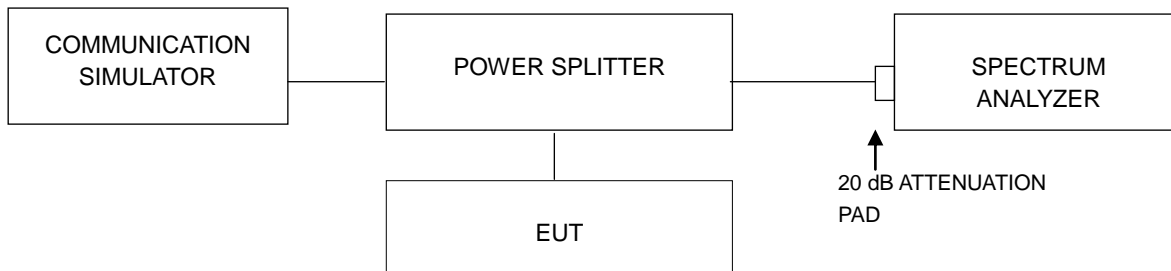

### 4.5.3 Test Procedures

1. Set resolution/measurement bandwidth  $\geq$  signal's occupied bandwidth;
2. Set the number of counts to a value that stabilizes the measured CCDF curve;
3. Record the maximum PAPR level associated with a probability of 0.1 %.



4.5.4 Test Results

LTE Band 4							
Channel Bandwidth: 1.4 MHz				Channel Bandwidth: 3 MHz			
Channel	Frequency (MHz)	Peak to Average Ratio (dB)		Channel	Frequency (MHz)	Peak to Average Ratio (dB)	
		QPSK	16QAM			QPSK	16QAM
19957	1710.7	3.78	4.66	19965	1711.5	3.82	4.57
20175	1732.5	4.09	4.88	20175	1732.5	4.14	5.15
20393	1754.3	3.88	5.02	20385	1753.5	3.96	4.74

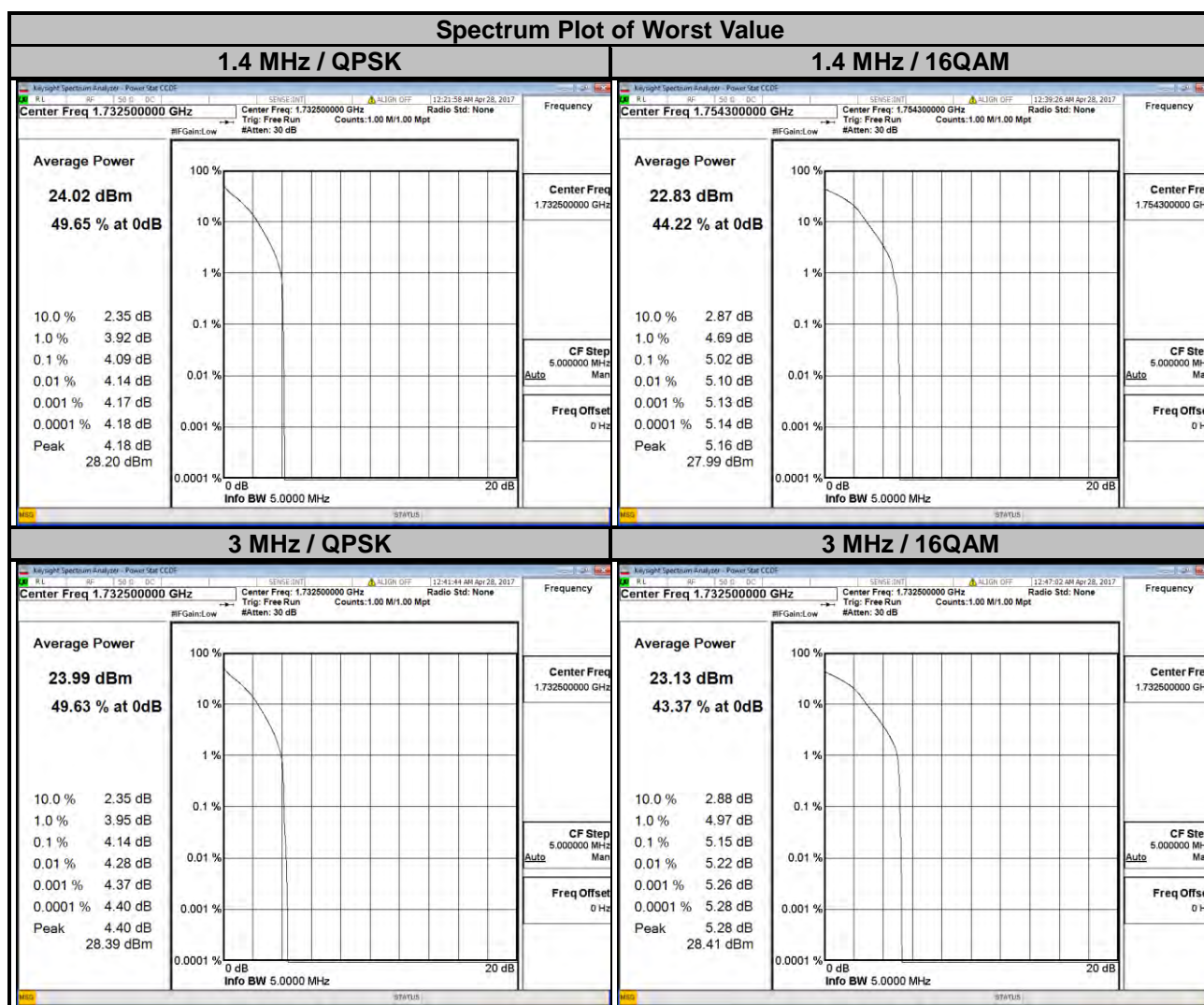

### LTE Band 4

Channel Bandwidth: 5 MHz				Channel Bandwidth: 10 MHz			
Channel	Frequency (MHz)	Peak to Average Ratio (dB)		Channel	Frequency (MHz)	Peak to Average Ratio (dB)	
		QPSK	16QAM			QPSK	16QAM
19975	1712.5	3.85	4.56	20000	1715.0	3.79	4.71
20175	1732.5	4.11	5.06	20175	1732.5	4.09	5.07
20375	1752.5	3.95	4.76	20350	1750.0	3.92	4.72

### Spectrum Plot of Worst Value

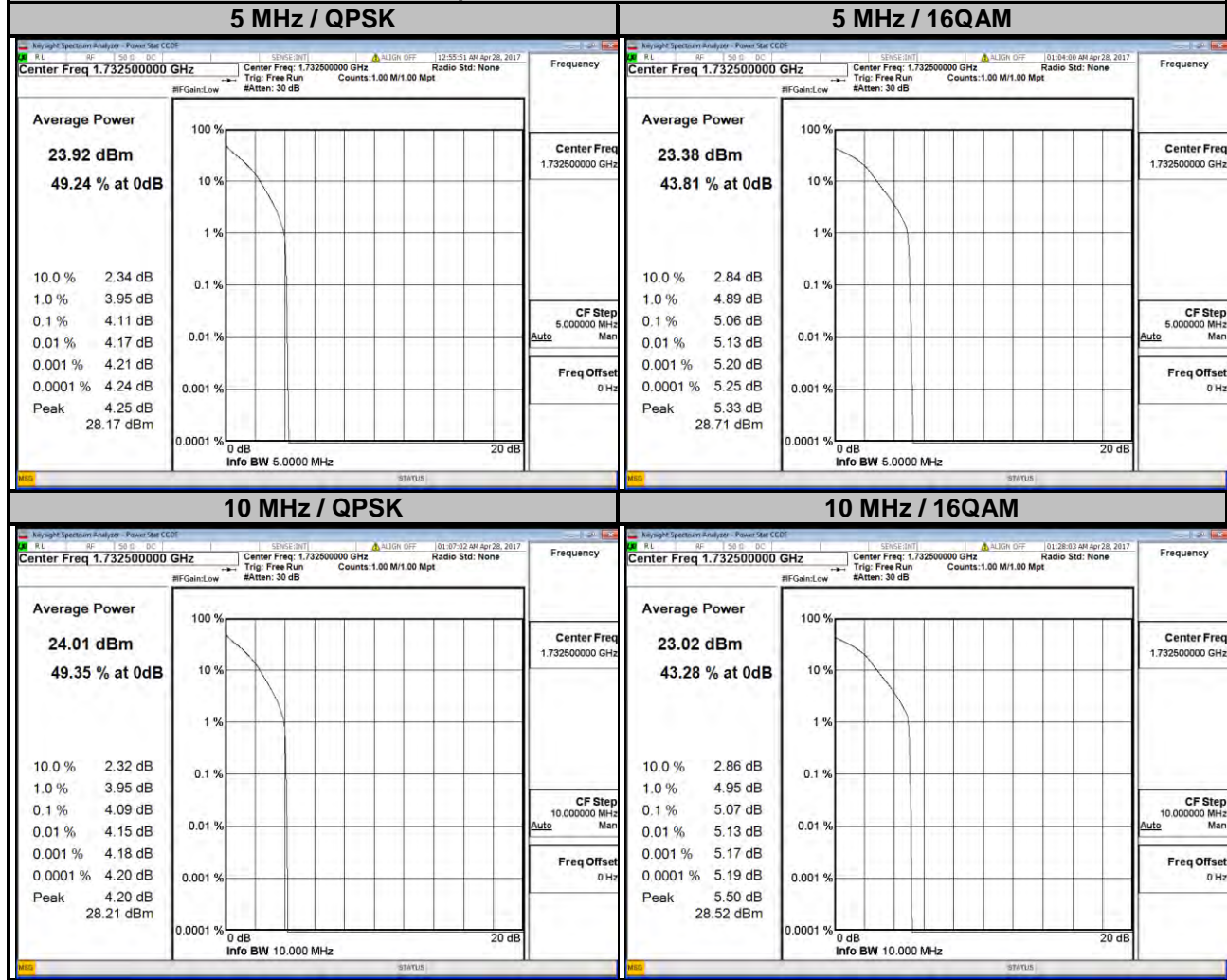

### LTE Band 4

#### Channel Bandwidth: 15 MHz

#### Channel Bandwidth: 20 MHz

Channel	Frequency (MHz)	Peak to Average Ratio (dB)		Channel	Frequency (MHz)	Peak to Average Ratio (dB)	
		QPSK	16QAM			QPSK	16QAM
20025	1717.5	3.75	4.66	20050	1720.0	3.79	4.76
20175	1732.5	4.31	5.06	20175	1732.5	4.28	5.07
20325	1747.5	3.77	4.63	20300	1745.0	3.85	4.91

### Spectrum Plot of Worst Value

#### 15 MHz / QPSK

#### 15 MHz / 16QAM

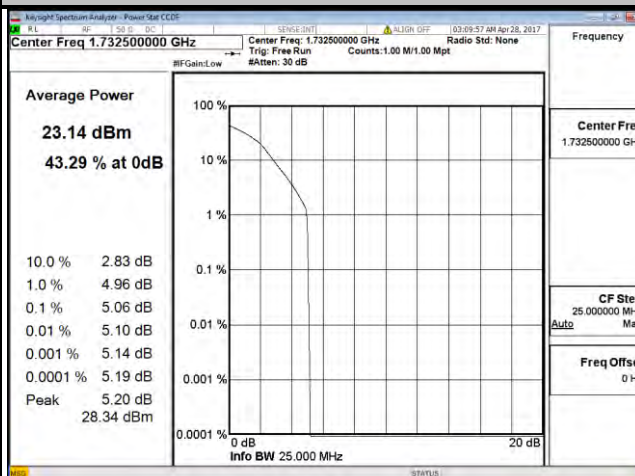
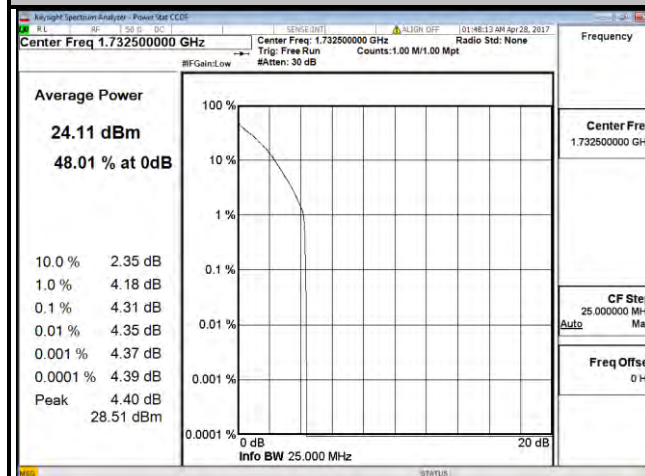

#### 20 MHz / QPSK

#### 20 MHz / 16QAM

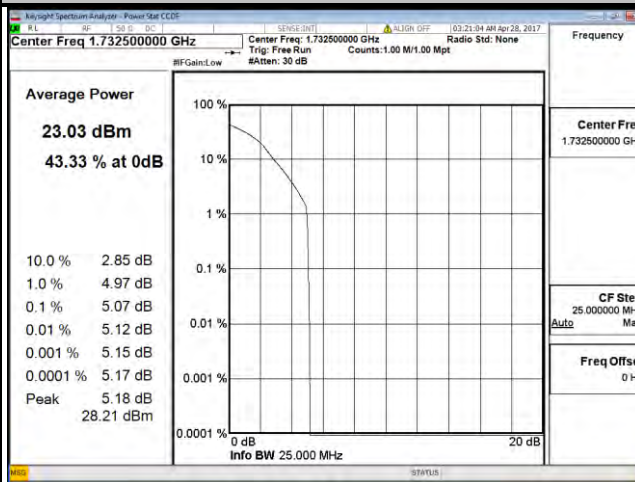
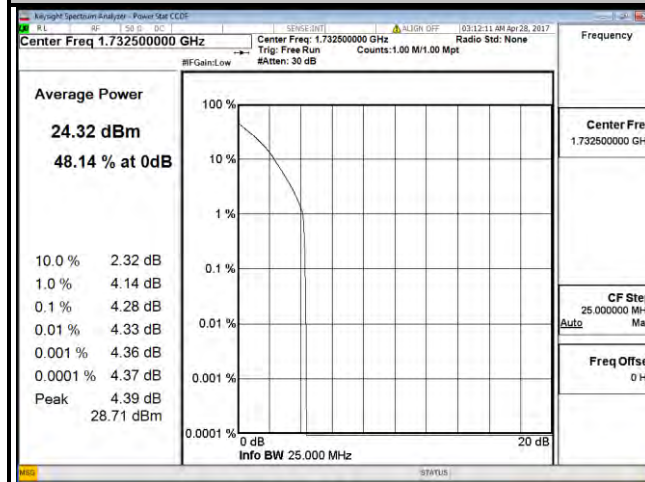

### LTE Band 13

Channel Bandwidth: 5 MHz				Channel Bandwidth: 10 MHz			
Channel	Frequency (MHz)	Peak to Average Ratio (dB)		Channel	Frequency (MHz)	Peak to Average Ratio (dB)	
		QPSK	16QAM			QPSK	16QAM
23205	779.5	3.27	4.13				
23230	782.0	3.99	4.98	23230	782.0	3.25	4.24
23255	784.5	4.00	5.05				

### Spectrum Plot of Worst Value

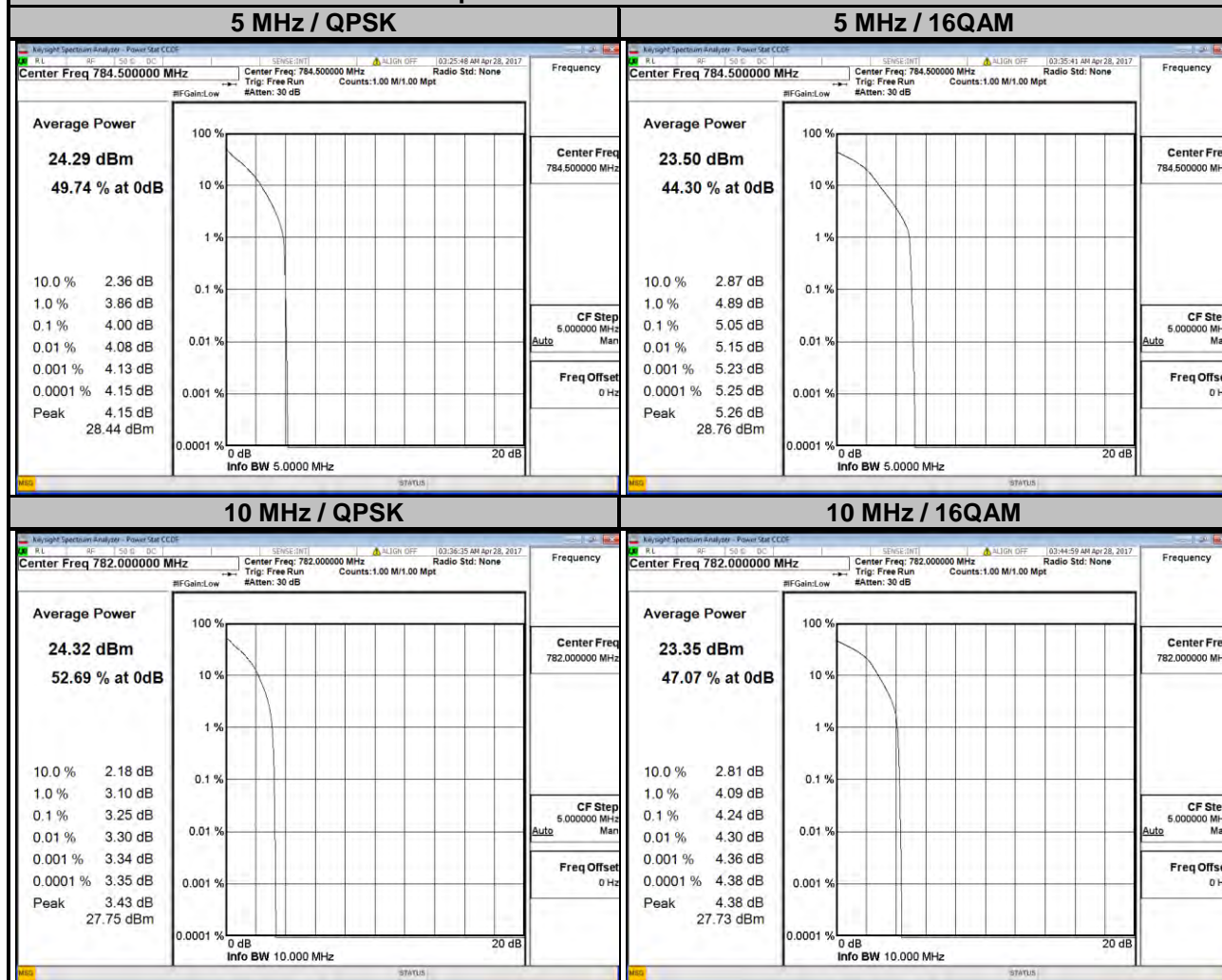

## 4.6 Conducted Spurious Emissions

### 4.6.1 Limits of Conducted Spurious Emissions Measurement

The power of any emission outside a licensee's frequency block shall be attenuated below the transmitter power (P) by at least  $43 + 10 \log_{10}(P)$  dB. The limit of emission is equal to -13 dBm.

### 4.6.2 Test Setup

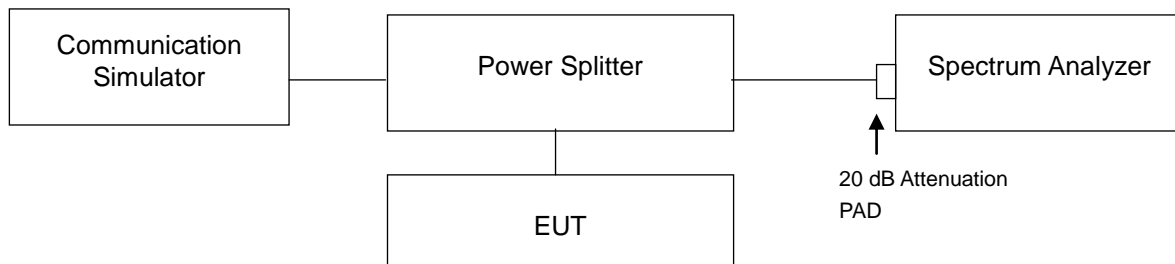

### 4.6.3 Test Procedure

- The EUT makes a phone call to the communication simulator. All measurements were done at low, middle and high operational frequency range.
- Measuring frequency range is from 30 MHz to 18 GHz for LTE Band 4. 10 dB attenuation pad is connected with spectrum. RBW=1 MHz and VBW=3 MHz are used for conducted emission measurement.

### 4.6.4 Test Results

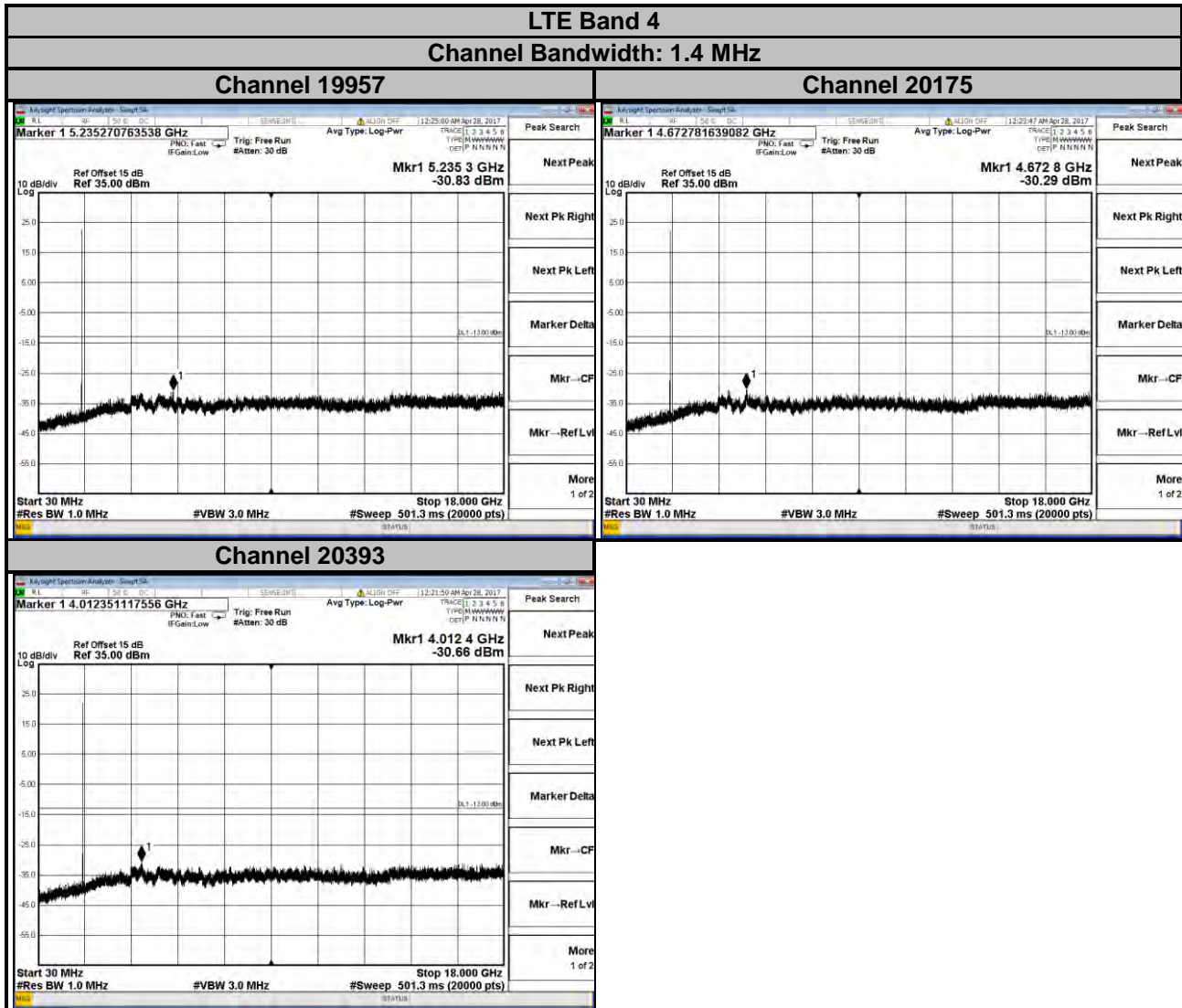

### LTE Band 4

Channel Bandwidth: 3 MHz

#### Channel 19965

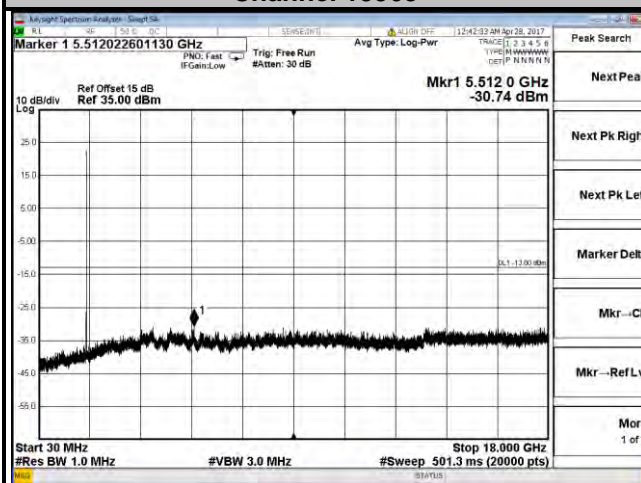

#### Channel 10175

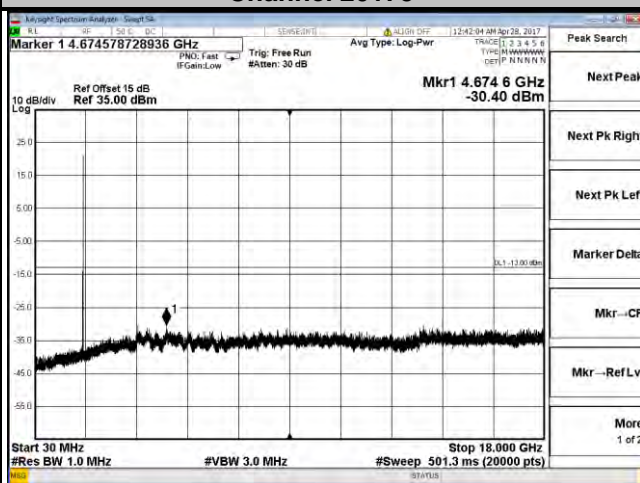

#### Channel 20385

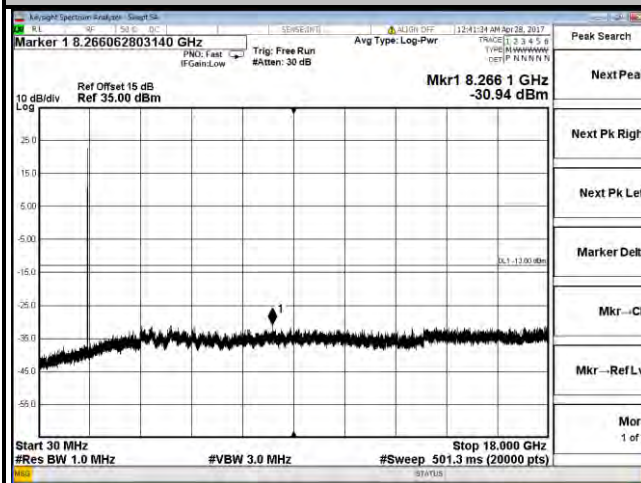

LTE Band 4  
Channel Bandwidth: 5 MHz

Channel 19975

Channel 10175

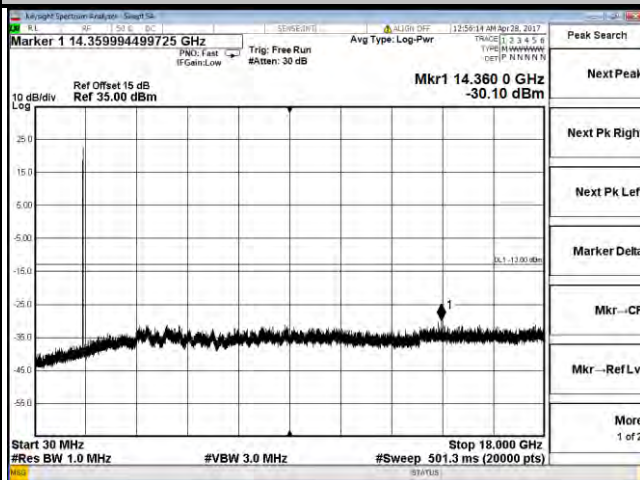
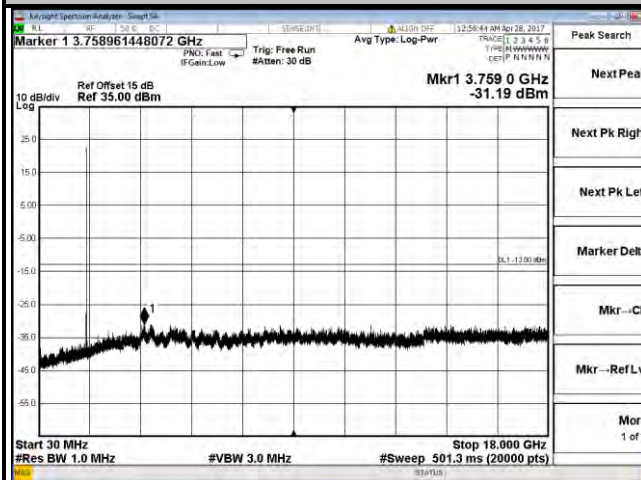

Channel 20375

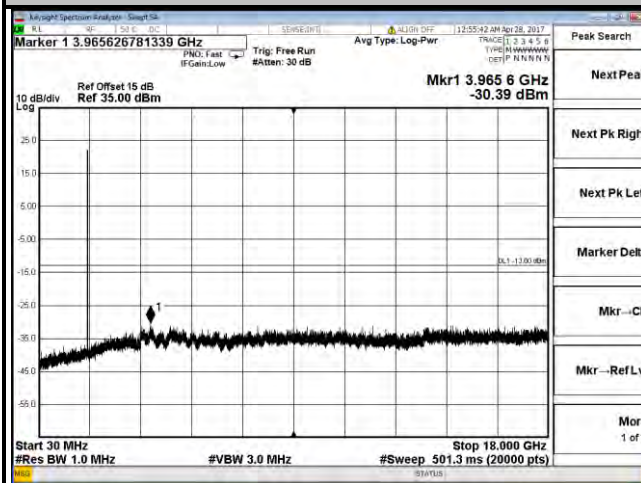



**LTE Band 4**  
**Channel Bandwidth: 10 MHz**

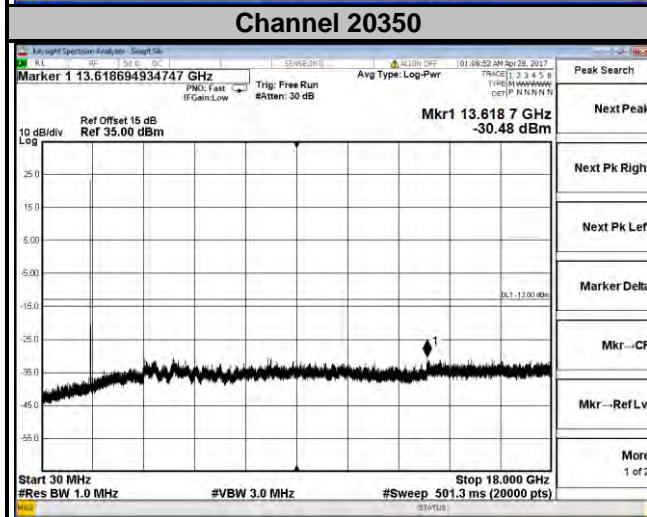
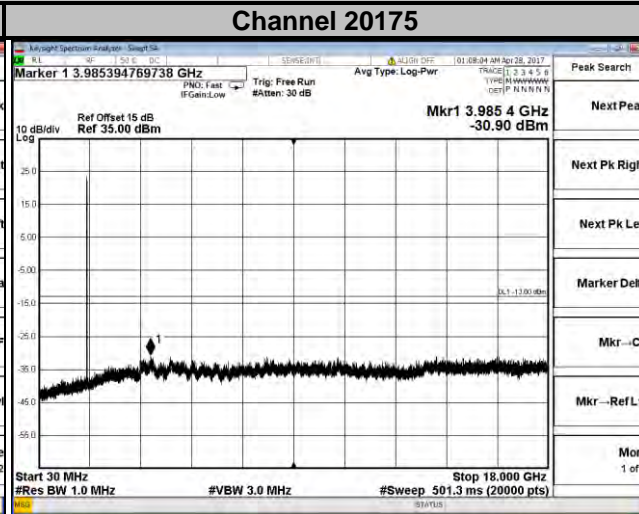
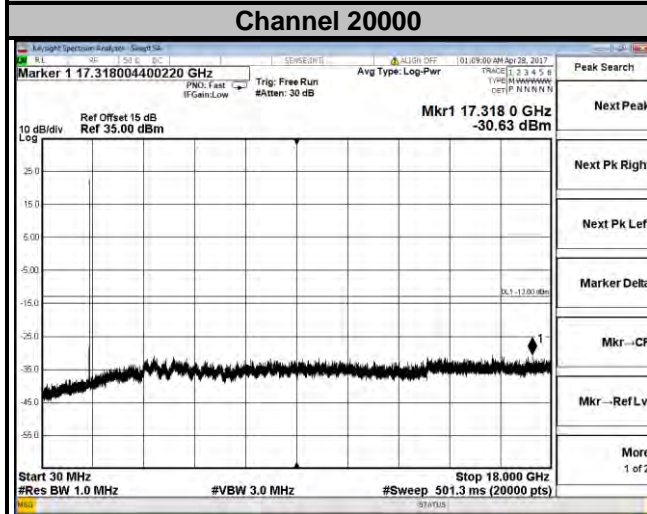

**LTE Band 4**  
**Channel Bandwidth: 15 MHz**

**Channel 2025**

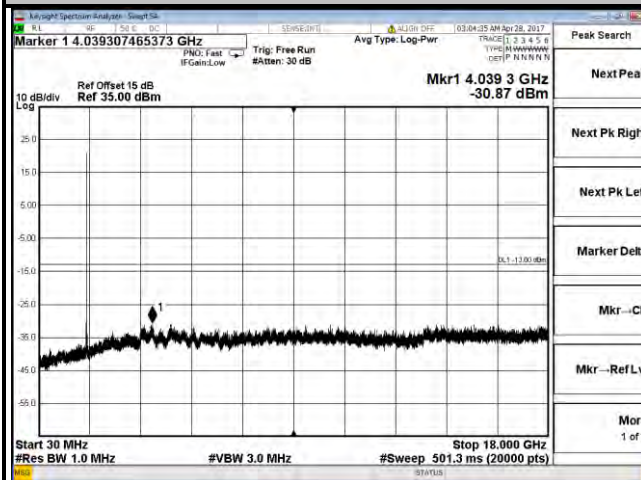

**Channel 1715**

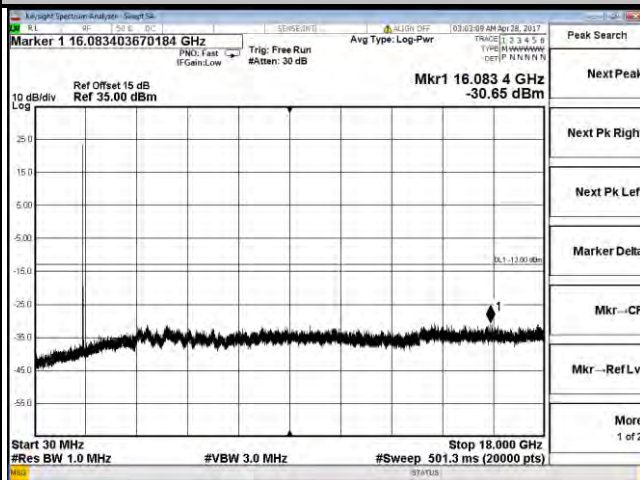

**Channel 2025**

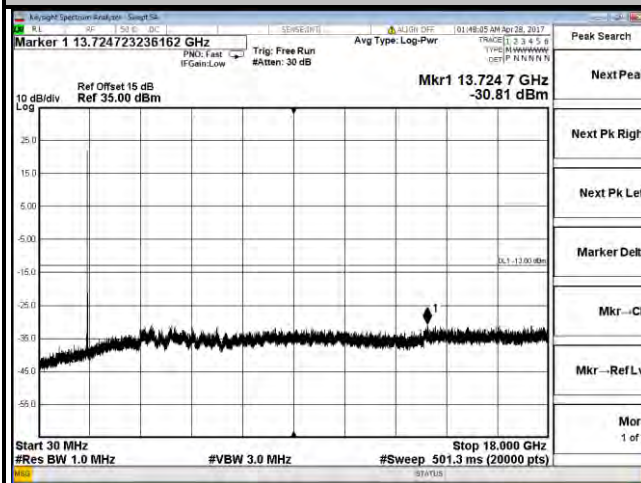

LTE Band 4

Channel Bandwidth: 20 MHz

Channel 20050

Channel 17175

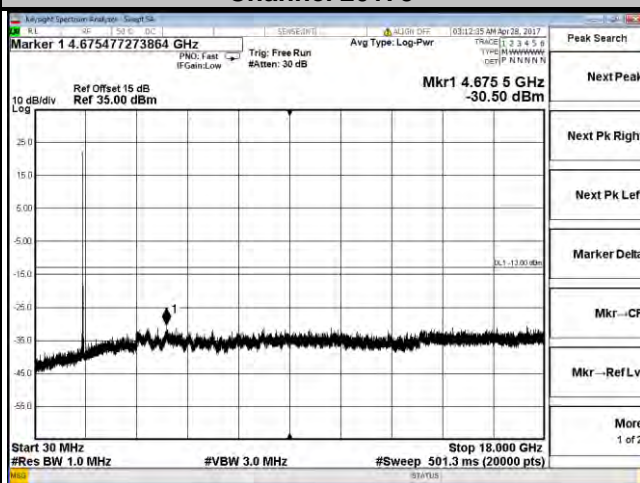
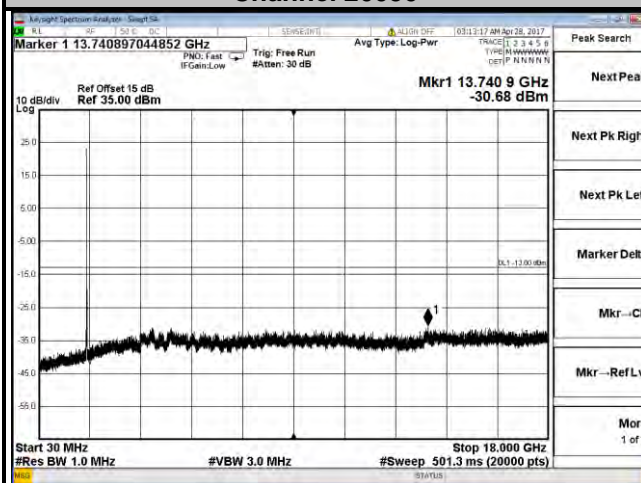

Channel 20300

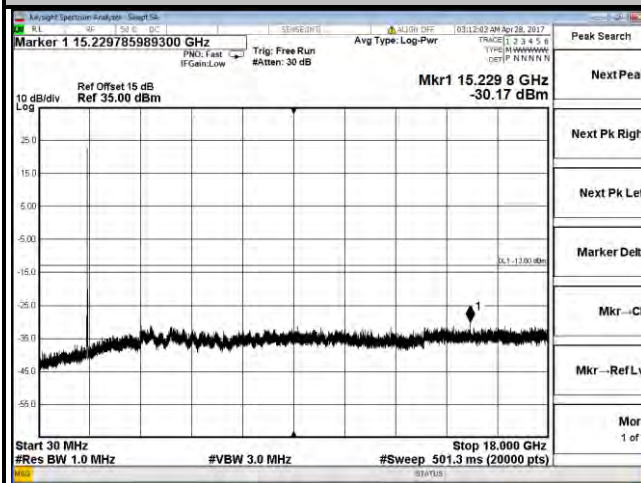

**LTE Band 13**  
**Channel Bandwidth: 5 MHz**

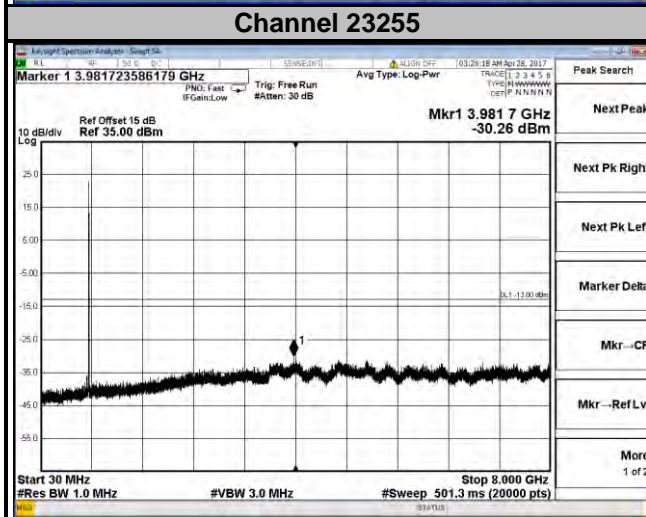
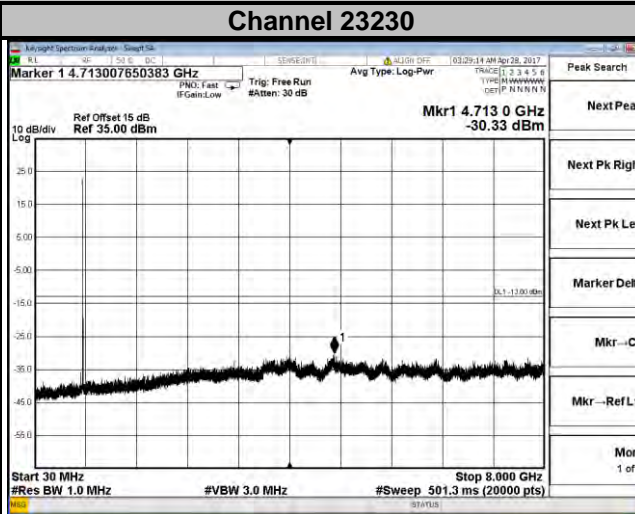
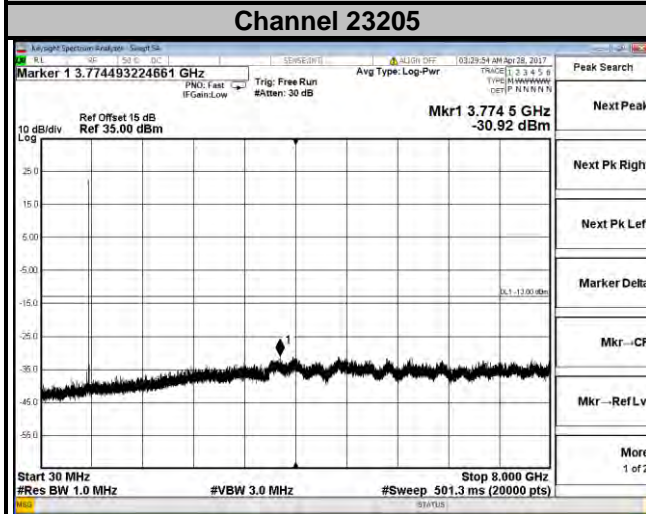

**LTE Band 13**  
**Channel Bandwidth: 10 MHz**  
**Channel 23230**

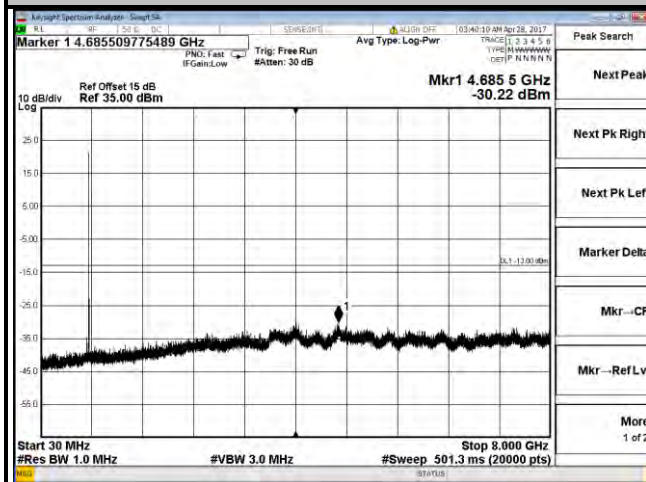

## 4.7 Radiated Emission Measurement

### 4.7.1 Limits of Radiated Emission Measurement

- a. The power of any emission outside a licensee's frequency block shall be attenuated below the transmitter power (P) by at least  $43 + 10 \log_{10}(P)$  dB. The limit of emission is equal to -13 dBm.
- b. For operations in the 775-788 MHz, emissions in the band 1559-1610 MHz shall be limited to -70 dBW/MHz. The limit of emissions is equal to -40 dBm.

### 4.7.2 Test Procedure

- a. Substitution method is used for E.I.R.P measurement. In the semi-anechoic chamber, EUT placed on the 0.8 m height of Turn Table, rotated the table around 360 degrees to search the maximum radiation power and receiver antenna shall be rotated vertical and horizontal polarization and moved height from 1 m to 4 m to find the maximum polar radiated power. The "Read Value" is the spectrum reading the maximum power value.
- b. The substitution horn antenna is substituted for EUT at the same position and signals generator export the CW signal to the substitution antenna via a TX cable. Rotated the Turn Table and moved receiving antenna to find the maximum radiation power. Adjust output power level of S.G to get a Value of spectrum reading equal to "Read Value" of step a. Record the power level of S.G.
- c.  $EIRP = \text{Output power level of S.G} - \text{TX cable loss} + \text{Antenna gain of substitution horn}$ .
- d. E.R.P power can be calculated form E.I.R.P power by subtracting the gain of dipole,  $E.R.P \text{ power} = E.I.P.R \text{ power} - 2.15 \text{ dBi}$ .

**Note:** The resolution bandwidth of spectrum analyzer is 1 MHz and the video bandwidth is 3 MHz.

### 4.7.3 Deviation from Test Standard

No deviation.

#### 4.7.4 Test Setup

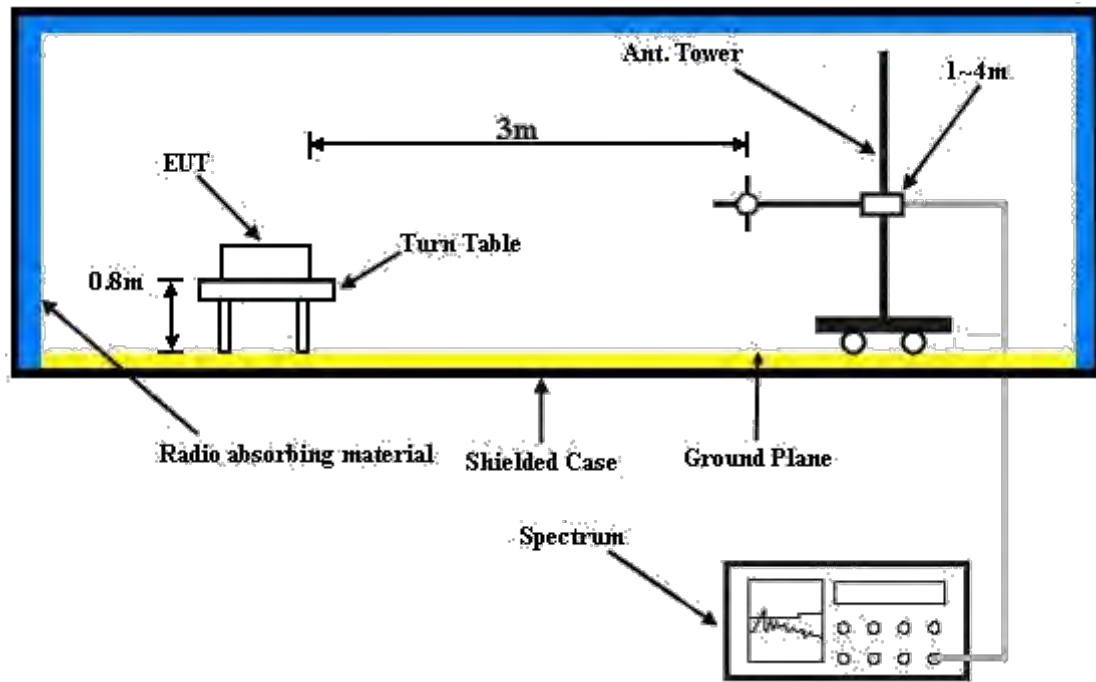

For the actual test configuration, please refer to the attached file (Test Setup Photo).

4.7.5 Test Results

LTE Band 4

Channel Bandwidth: 20 MHz / QPSK

Low Channel



Bureau Veritas Consumer Products Services Ltd., Taoyuan Branch

A D T

Data: 9

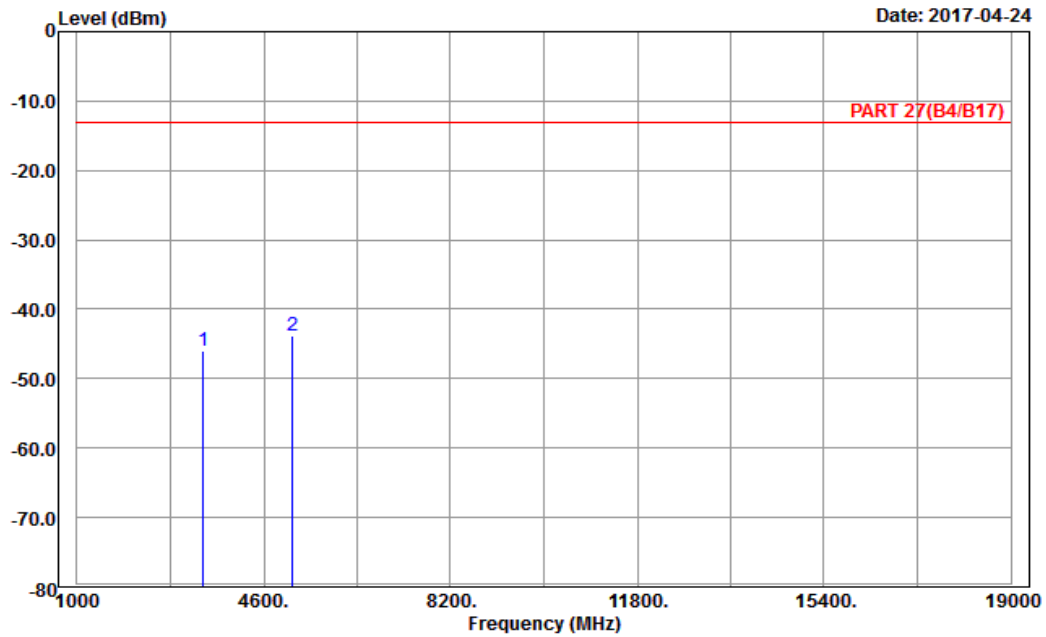

Site : 966 chamber 1  
 Condition: PART 27(B4/B17) Horizontal  
 Remark : LTE\_Band 4\_Link\_CH20050  
 Tested by: Harry Hsueh

	Read	Limit	Over				
Freq	Level	Level	Line	Limit	Factor	Remark	
MHz	dBm	dBm	dBm	dB	dB		
1	3440.00	-45.95	-60.30	-13.00	-32.95	14.35	Peak
2 pp	5160.00	-43.85	-63.77	-13.00	-30.85	19.92	Peak



A D T

Data: 10

Date: 2017-04-24

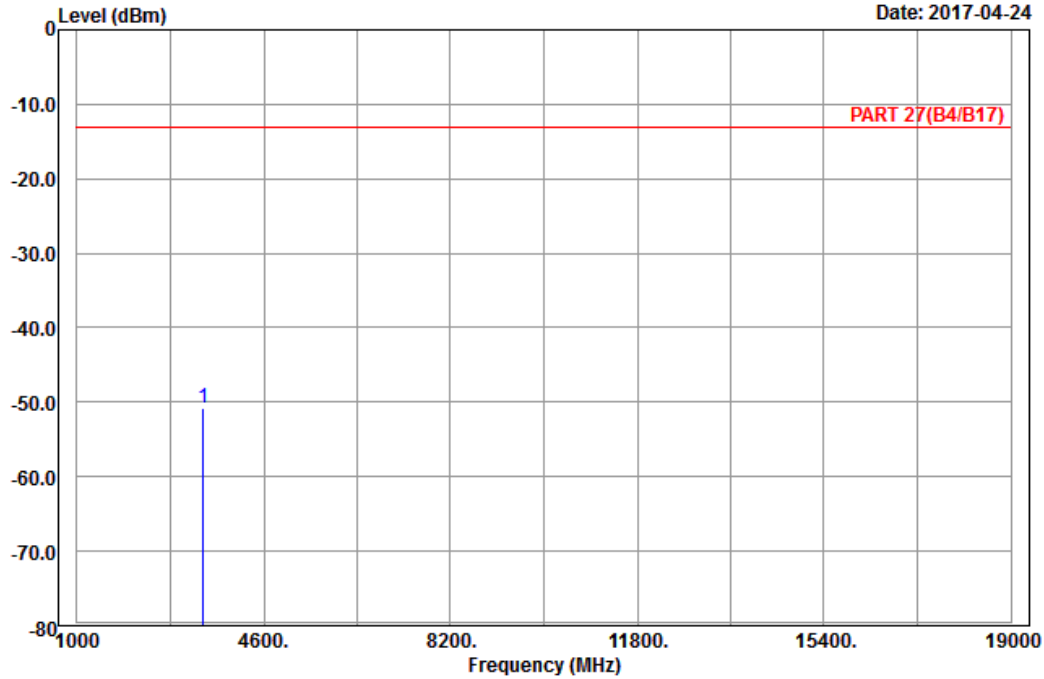

Site : 966 chamber 1  
 Condition: PART 27(B4/B17) Vertical  
 Remark : LTE\_Band 4\_Link\_CH20050  
 Tested by: Harry Hsueh

	Freq	Level	Read Level	Limit Line	Over Limit	Factor	Remark
	MHz	dBm	dBm	dBm	dB	dB	
1	pp 3440.00	-50.73	-65.08	-13.00	-37.73	14.35	Peak



Middle Channel



Bureau Veritas Consumer Products Services Ltd., Taoyuan Branch

A D T

Data: 13

Date: 2017-04-24

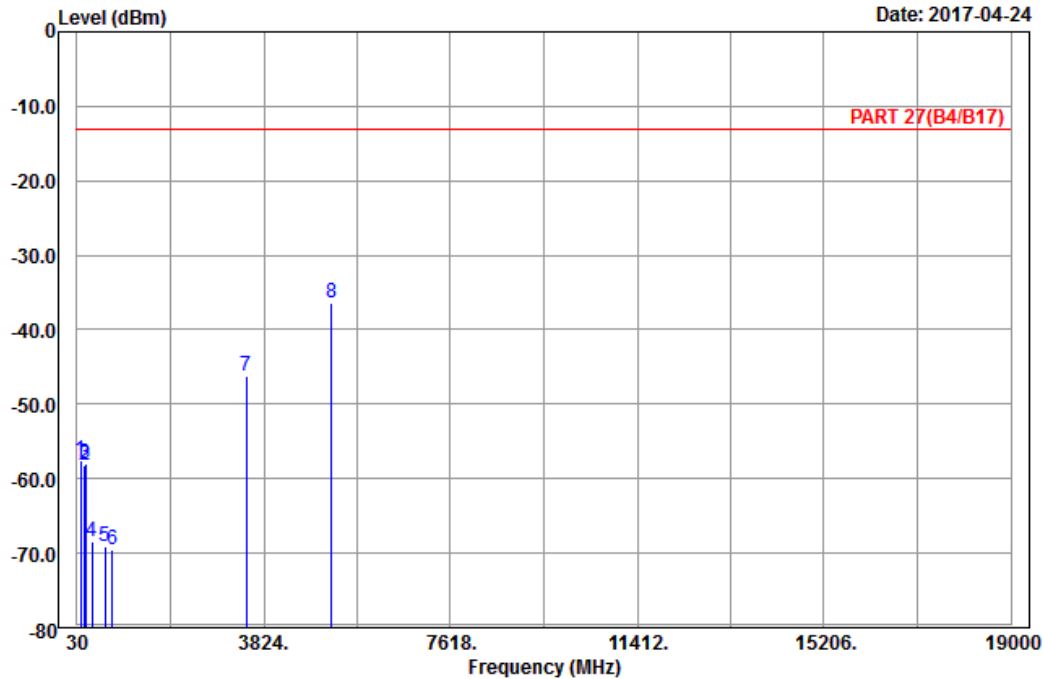

Site : 966 chamber 1  
 Condition: PART 27(B4/B17) Horizontal  
 Remark : LTE\_Band 4\_Link\_CH20175  
 Tested by: Harry Hsueh

	Freq	Level	Read Level	Limit Line	Over Limit	Factor	Remark
	MHz	dBm	dBm	dBm	dB	dB	
1	103.17	-57.48	-47.71	-13.00	-44.48	-9.77	Peak
2	193.08	-58.16	-52.29	-13.00	-45.16	-5.87	Peak
3	208.47	-58.05	-51.98	-13.00	-45.05	-6.07	Peak
4	337.80	-68.50	-62.98	-13.00	-55.50	-5.52	Peak
5	602.40	-69.00	-69.40	-13.00	-56.00	0.40	Peak
6	741.00	-69.64	-68.49	-13.00	-56.64	-1.15	Peak
7	3465.00	-46.11	-60.45	-13.00	-33.11	14.34	Peak
8 pp	5197.50	-36.37	-56.49	-13.00	-23.37	20.12	Peak



A D T

Data: 14

Date: 2017-04-24

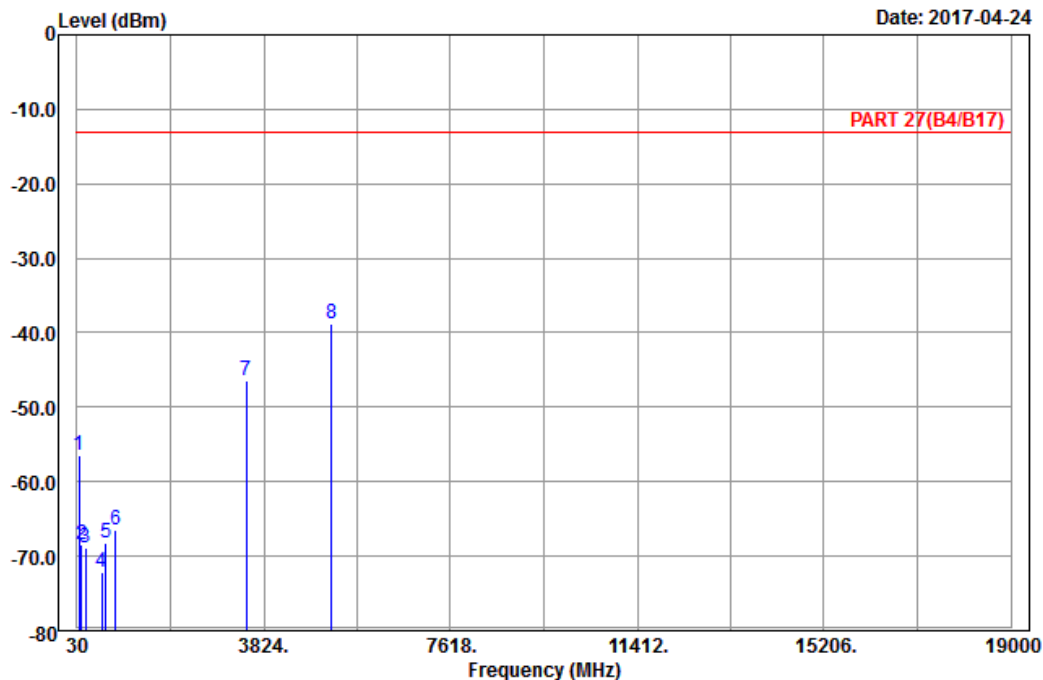

Site : 966 chamber 1  
 Condition: PART 27(B4/B17) Vertical  
 Remark : LTE\_Band 4\_Link\_CH20175  
 Tested by: Harry Hsueh

	Freq	Level	Read Level	Limit Line	Over Limit	Factor	Remark
	MHz	dBm	dBm	dBm	dB	dB	
1	74.28	-56.49	-44.22	-13.00	-43.49	-12.27	Peak
2	119.64	-68.48	-60.16	-13.00	-55.48	-8.32	Peak
3	201.72	-68.89	-62.73	-13.00	-55.89	-6.16	Peak
4	531.00	-72.20	-69.12	-13.00	-59.20	-3.08	Peak
5	616.40	-68.30	-68.54	-13.00	-55.30	0.24	Peak
6	812.40	-66.51	-68.38	-13.00	-53.51	1.87	Peak
7	3465.00	-46.35	-60.69	-13.00	-33.35	14.34	Peak
8 pp	5197.50	-38.80	-58.92	-13.00	-25.80	20.12	Peak

# High Channel



Bureau Veritas Consumer Products Services Ltd., Taoyuan Branch

A D T

Data: 9

Date: 2017-04-24

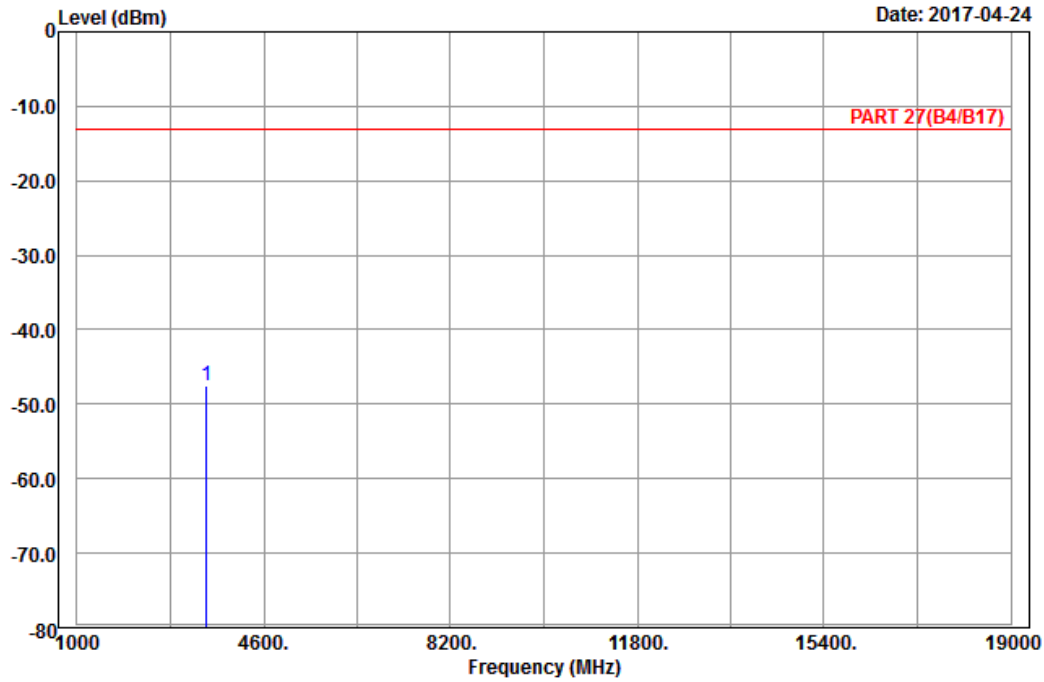

Site : 966 chamber 1  
 Condition: PART 27(B4/B17) Horizontal  
 Remark : LTE\_Band 4\_Link\_CH20300  
 Tested by: Harry Hsueh

	Read	Limit	Over			
Freq	Level	Level	Line	Limit	Factor	Remark
MHz	dBm	dBm	dBm	dB	dB	
1 pp 3490.00	-47.52	-61.83	-13.00	-34.52	14.31	Peak



Bureau Veritas Consumer Products Services Ltd., Taoyuan Branch

A D T

Data: 10

Date: 2017-04-24

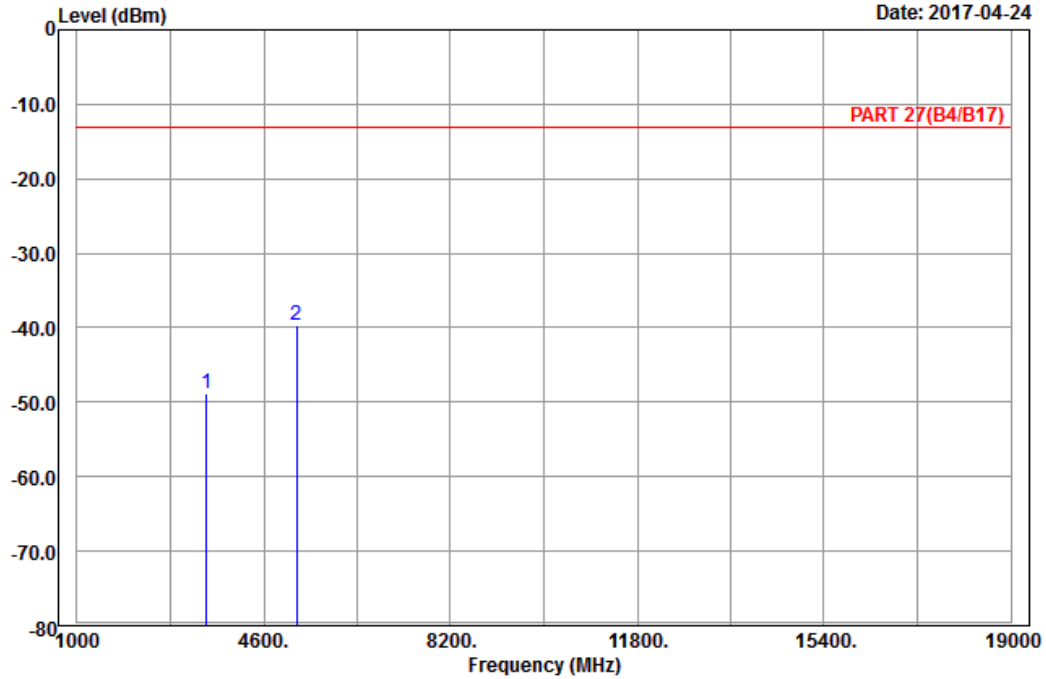

Site : 966 chamber 1  
 Condition: PART 27(B4/B17) Vertical  
 Remark : LTE\_Band 4\_Link\_CH20300  
 Tested by: Harry Hsueh

	Freq	Level	Read Level	Limit Line	Over Limit	Factor	Remark
	MHz	dBm	dBm	dBm	dB	dB	
1	3490.00	-48.81	-63.12	-13.00	-35.81	14.31	Peak
2 pp	5235.00	-39.66	-59.82	-13.00	-26.66	20.16	Peak

LTE Band 13  
Channel Bandwidth: 10 MHz / QPSK (1, 49)



Bureau Veritas Consumer Products Services Ltd., Taoyuan Branch

A D T

Data: 9

Date: 2017-04-24

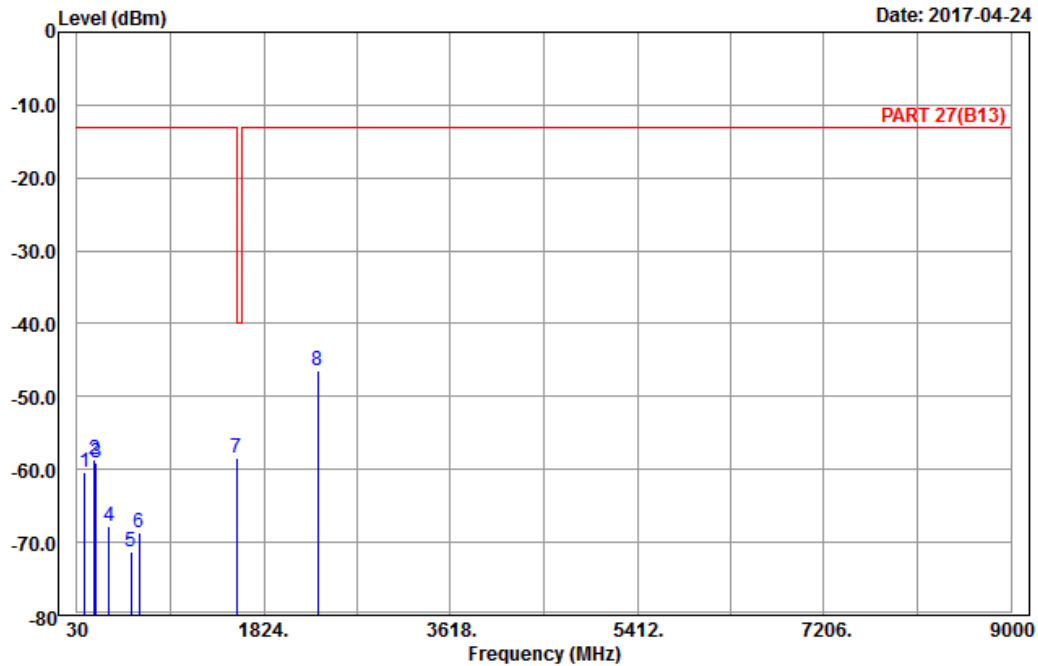

Site : 966 chamber 1  
Condition: PART 27(B13) Horizontal  
Remark : LTE\_Band 13\_Link\_CH23230  
Tested by: Karl Lee

	Read	Limit	Over				
Freq	Level	Level	Line	Limit	Factor	Remark	
MHz	dBm	dBm	dBm	dB	dB		
1	100.20	-60.34	-50.22	-13.00	-47.34	-10.12	Peak
2	193.89	-58.56	-52.65	-13.00	-45.56	-5.91	Peak
3	211.71	-59.12	-53.09	-13.00	-46.12	-6.03	Peak
4	335.70	-67.86	-62.31	-13.00	-54.86	-5.55	Peak
5	547.80	-71.28	-69.48	-13.00	-58.28	-1.80	Peak
6	624.80	-68.71	-68.86	-13.00	-55.71	0.15	Peak
7 pp	1564.00	-58.43	-65.29	-40.00	-18.43	6.86	Peak
8	2346.00	-46.48	-57.42	-13.00	-33.48	10.94	Peak



A D T

Data: 10

Date: 2017-04-24

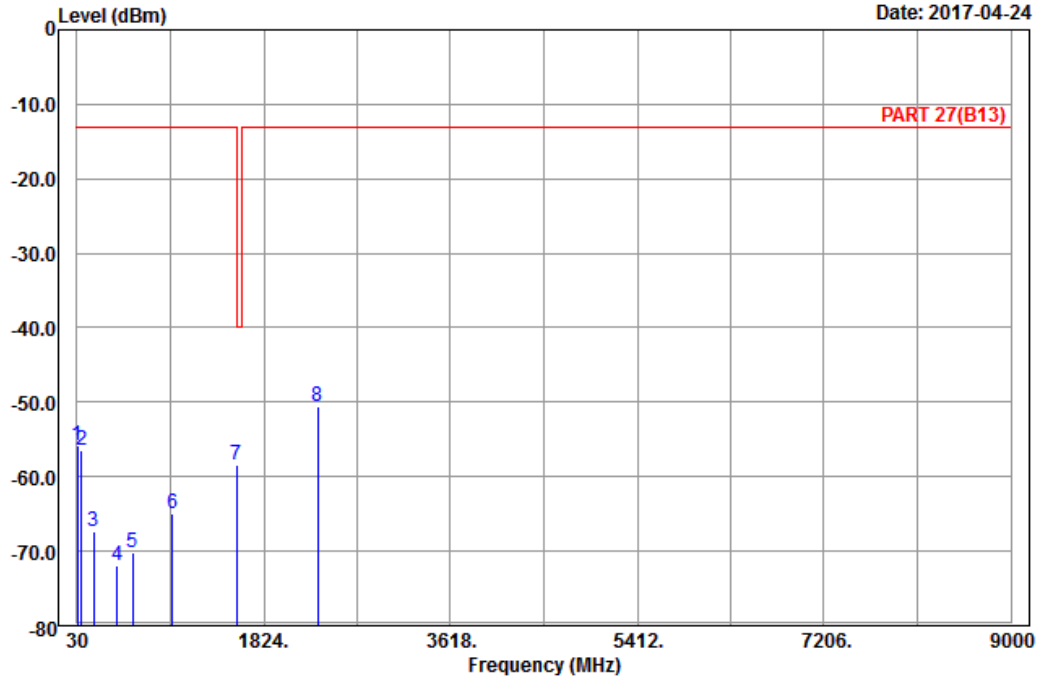

Site : 966 chamber 1  
 Condition: PART 27(B13) Vertical  
 Remark : LTE\_Band 13\_Link\_CH23230  
 Tested by: Karl Lee

	Freq	Level	Read Level	Limit Line	Over Limit	Factor	Remark
	MHz	dBm	dBm	dBm	dB	dB	
1	33.78	-55.85	-44.87	-13.00	-42.85	-10.98	Peak
2	74.55	-56.48	-44.21	-13.00	-43.48	-12.27	Peak
3	187.68	-67.38	-61.68	-13.00	-54.38	-5.70	Peak
4	419.70	-71.90	-68.71	-13.00	-58.90	-3.19	Peak
5	567.40	-70.28	-69.34	-13.00	-57.28	-0.94	Peak
6	943.30	-65.03	-69.87	-13.00	-52.03	4.84	Peak
7 pp	1564.00	-58.41	-65.27	-40.00	-18.41	6.86	Peak
8	2346.00	-50.49	-61.43	-13.00	-37.49	10.94	Peak

Channel Bandwidth: 10 MHz / QPSK (50, 0)



Bureau Veritas Consumer Products Services Ltd., Taoyuan Branch

A D T

Data: 9

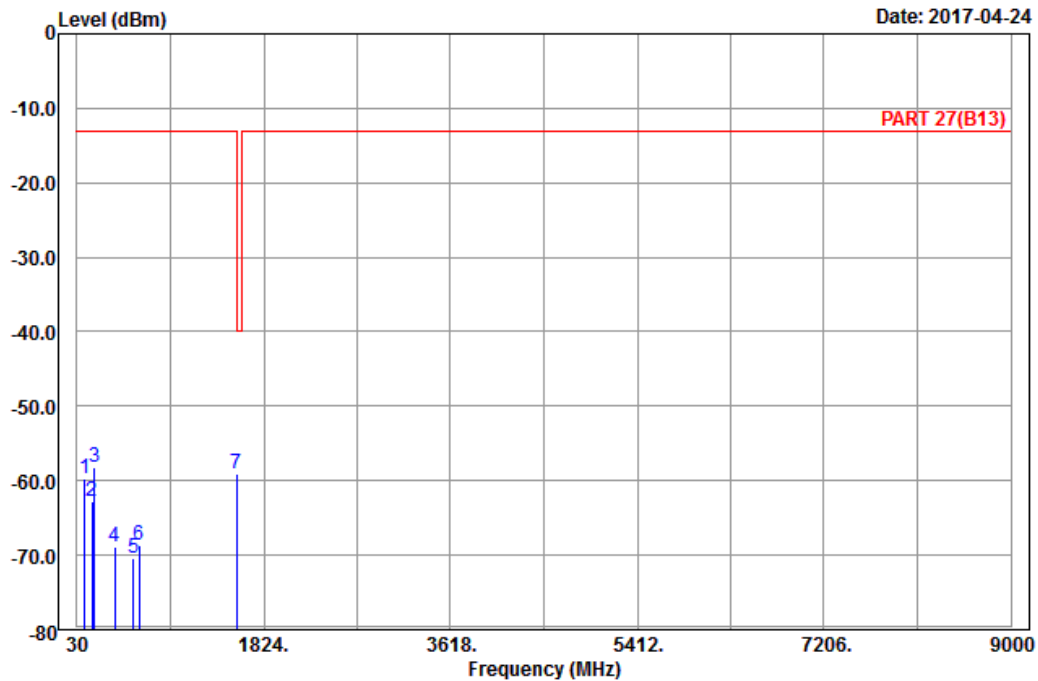

Site : 966 chamber 1  
 Condition: PART 27(B13) Horizontal  
 Remark : LTE\_Band 13\_Link\_CH23230  
 Tested by: Karl Lee

	Freq	Level	Read Level	Limit Line	Over Limit	Factor	Remark
	MHz	dBm	dBm	dBm	dB	dB	
1	104.79	-59.72	-50.19	-13.00	-46.72	-9.53	Peak
2	171.75	-62.81	-56.31	-13.00	-49.81	-6.50	Peak
3	201.18	-58.26	-52.09	-13.00	-45.26	-6.17	Peak
4	394.50	-68.94	-65.94	-13.00	-55.94	-3.00	Peak
5	575.10	-70.33	-69.71	-13.00	-57.33	-0.62	Peak
6	628.30	-68.63	-68.74	-13.00	-55.63	0.11	Peak
7 pp	1564.00	-59.08	-65.94	-40.00	-19.08	6.86	Peak



A D T

Data: 10

Date: 2017-04-24

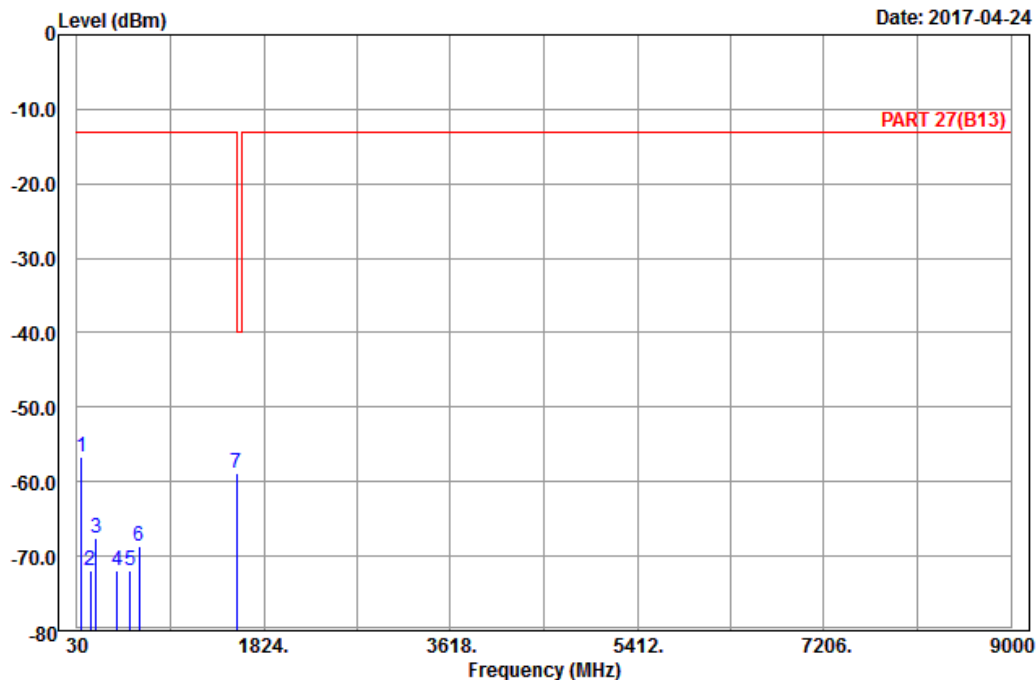

Site : 966 chamber 1  
 Condition: PART 27(B13) Vertical  
 Remark : LTE\_Band 13\_Link\_CH23230  
 Tested by: Karl Lee

	Freq	Level	Read Level	Limit Line	Over Limit	Factor	Remark
	MHz	dBm	dBm	dBm	dB	dB	
1	74.28	-56.57	-44.30	-13.00	-43.57	-12.27	Peak
2	161.49	-71.94	-64.47	-13.00	-58.94	-7.47	Peak
3	214.95	-67.56	-61.58	-13.00	-54.56	-5.98	Peak
4	419.00	-72.00	-68.83	-13.00	-59.00	-3.17	Peak
5	540.10	-72.02	-69.65	-13.00	-59.02	-2.37	Peak
6	626.90	-68.59	-68.72	-13.00	-55.59	0.13	Peak
7 pp	1564.00	-58.83	-65.69	-40.00	-18.83	6.86	Peak



## 5 Pictures of Test Arrangements

Please refer to the attached file (Test Setup Photo).

## Appendix – Information on the Testing Laboratories

We, Bureau Veritas Consumer Products Services (H.K.) Ltd., Taoyuan Branch, were founded in 1988 to provide our best service in EMC, Radio, Telecom and Safety consultation. Our laboratories are accredited and approved according to ISO/IEC 17025.

If you have any comments, please feel free to contact us at the following:

**Linko EMC/RF Lab**

Tel: 886-2-26052180

Fax: 886-2-26051924

**Hsin Chu EMC/RF/Telecom Lab**

Tel: 886-3-6668565

Fax: 886-3-6668323

**Hwa Ya EMC/RF/Safety**

Tel: 886-3-3183232

Fax: 886-3-3270892

**Email:** [service.adt@tw.bureauveritas.com](mailto:service.adt@tw.bureauveritas.com)

**Web Site:** [www.bureauveritas-adt.com](http://www.bureauveritas-adt.com)

The address and road map of all our labs can be found in our web site also.

--- END ---