



Inter**Lab**[®]

FCC Measurement/Technical Report on

WLAN transceiver
build in a mobile phone
F42 (OASY1)
FCC ID: V65OASY1

Report Reference: ODE_MJP_KYOCE_1102_FCCf

Test Laboratory:

Borsigstr. 11
Germany
7Layers AG
40880 Ratingen



Deutsche
Akkreditierungsstelle
D-PL-12140-01-01

Note:

The following test results relate only to the devices specified in this document. This report shall not be reproduced in parts without the written approval of the test laboratory.

7Layers AG
Borsigstrasse 11
40880 Ratingen, Germany
Phone: +49 (0) 2102 749 0
Fax: +49 (0) 2102 749 350
www.7Layers.com

Aufsichtsratsvorsitzender •
Chairman of the Supervisory Board:
Markus Becker
Vorstand • Board:
Dr. H.-J. Meckelburg

Registergericht • registered in:
Düsseldorf, HRB 44096
USt-IdNr • VAT No.:
DE 203159652
TAX No. 147/5869/0385



Table of Contents

0	Summary	3
0.1	Technical Report Summary	3
0.2	Measurement Summary	4
1	Administrative Data	6
1.1	Testing Laboratory	6
1.2	Project Data	6
1.3	Applicant Data	6
1.4	Manufacturer Data	6
2	Test object Data	7
2.1	General EUT Description	7
2.2	EUT Main components	8
2.3	Ancillary Equipment	8
2.4	Auxiliary Equipment	9
2.5	EUT Setups	9
2.6	Operating Modes	10
2.7	Special software used for testing	10
2.8	Product labelling	10
3	Test Results	11
3.1	Conducted emissions (AC power line)	11
3.2	Occupied bandwidth	13
3.3	Peak power output	16
3.4	Spurious RF conducted emissions	19
3.5	Spurious radiated emissions	23
3.6	Band edge compliance	29
3.7	Power density	33
4	Test Equipment	36
5	Photo Report	42
6	Setup Drawings	42
7	FCC and IC Correlation of measurement requirements	43
8	Annex measurement plots	44
8.1	AC Mains conducted	44
8.2	Occupied bandwidth	45
8.3	Peak power output	54
8.4	Band edge compliance conducted and Spurious RF conducted emissions	63
8.5	Power density	84



0 Summary

0.1 Technical Report Summary

Type of Authorization

Certification for an Intentional Radiator (Digital Device / Spread Spectrum).

Applicable FCC Rules

Prepared in accordance with the requirements of FCC Rules and Regulations as listed in 47 CFR Ch.1 Parts 2 (10-1-10 Edition) and 15 (10-1-10 Edition). The following subparts are applicable to the results in this test report.

Part 2, Subpart J - Equipment Authorization Procedures, Certification

Part 15, Subpart C – Intentional Radiators

§ 15.201 Equipment authorization requirement

§ 15.207 Conducted limits

§ 15.209 Radiated emission limits; general requirements

§ 15.247 Operation within the bands 902-928 MHz, 2400-2483.5 MHz and 5725-5850 MHz

Note:

The tests were selected and performed with reference to the FCC measurement guide line "Measurement of Digital Transmission Systems Operating under Section 15.247 March 23, 2005"

Summary Test Results:

The EUT complied with all performed tests as listed in chapter 0.2 Measurement Summary.



0.2 Measurement Summary

FCC Part 15, Subpart C § 15.207

Conducted emissions (AC power line)			
The measurement was performed according to ANSI C63.4			2009
OP-Mode	Setup	Port	Final Result
op-mode 4	Setup_01	AC Port (power line)	passed

FCC Part 15, Subpart C § 15.247 (a) (1)

Occupied bandwidth			
The measurement was performed according to FCC § 15.31			10-1-10 Edition
OP-Mode	Setup	Port	Final Result
op-mode 1b	Setup_02	Temp.ant.connector	passed
op-mode 1g	Setup_02	Temp.ant.connector	passed
op-mode 1n	Setup_02	Temp.ant.connector	passed
op-mode 2b	Setup_02	Temp.ant.connector	passed
op-mode 2g	Setup_02	Temp.ant.connector	passed
op-mode 2n	Setup_02	Temp.ant.connector	passed
op-mode 3b	Setup_02	Temp.ant.connector	passed
op-mode 3g	Setup_02	Temp.ant.connector	passed
op-mode 3n	Setup_02	Temp.ant.connector	passed

FCC Part 15, Subpart C § 15.247 (b) (1)

Peak power output			
The measurement was performed according to FCC § 15.31			10-1-10 Edition
OP-Mode	Setup	Port	Final Result
op-mode 1b	Setup_04	Temp.ant.connector	passed
op-mode 1g	Setup_04	Temp.ant.connector	passed
op-mode 1n	Setup_04	Temp.ant.connector	passed
op-mode 2b	Setup_04	Temp.ant.connector	passed
op-mode 2g	Setup_04	Temp.ant.connector	passed
op-mode 2n	Setup_04	Temp.ant.connector	passed
op-mode 3b	Setup_04	Temp.ant.connector	passed
op-mode 3g	Setup_04	Temp.ant.connector	passed
op-mode 3n	Setup_04	Temp.ant.connector	passed

FCC Part 15, Subpart C § 15.247 (d)

Spurious RF conducted emissions			
The measurement was performed according to FCC § 15.31			10-1-10 Edition
OP-Mode	Setup	Port	Final Result
op-mode 1b	Setup_02	Temp.ant.connector	passed
op-mode 1g	Setup_02	Temp.ant.connector	passed
op-mode 1n	Setup_02	Temp.ant.connector	passed
op-mode 2b	Setup_02	Temp.ant.connector	passed
op-mode 2g	Setup_02	Temp.ant.connector	passed
op-mode 2n	Setup_02	Temp.ant.connector	passed
op-mode 3b	Setup_02	Temp.ant.connector	passed
op-mode 3g	Setup_02	Temp.ant.connector	passed
op-mode 3n	Setup_02	Temp.ant.connector	passed

FCC Part 15, Subpart C
§ 15.247 (d), § 15.35 (b), § 15.209

Spurious radiated emissions

The measurement was performed according to ANSI C63.4

2009

OP-Mode	Setup	Port	Final Result
op-mode 1b	Setup_03	Enclosure	passed
op-mode 2b	Setup_03	Enclosure	passed
op-mode 3b	Setup_03	Enclosure	passed
op-mode 1g	Setup_03	Enclosure	passed
op-mode 2g	Setup_03	Enclosure	passed
op-mode 3g	Setup_03	Enclosure	passed
op-mode 1n	Setup_03	Enclosure	passed
op-mode 2n	Setup_03	Enclosure	passed
op-mode 3n	Setup_03	Enclosure	passed

FCC Part 15, Subpart C
§ 15.247 (d)

Band edge compliance

The measurement was performed according to FCC § 15.31 / ANSI C63.4

10-1-10 Edition / 2009

OP-Mode	Setup	Port	Final Result
op-mode 1b	Setup_02	Temp.ant.connector	passed
op-mode 1g	Setup_02	Temp.ant.connector	passed
op-mode 1n	Setup_02	Temp.ant.connector	passed
op-mode 3b	Setup_02	Temp.ant.connector	passed
op-mode 3g	Setup_02	Temp.ant.connector	passed
op-mode 3n	Setup_02	Temp.ant.connector	passed
op-mode 3b	Setup_03	Enclosure	passed
op-mode 3g	Setup_03	Enclosure	passed
op-mode 3n	Setup_03	Enclosure	passed

FCC Part 15, Subpart C
§ 15.247 (e)

Power density

The measurement was performed according to FCC § 15.31

10-1-10

OP-Mode	Setup	Port	Final Result
op-mode 1b	Setup_02	Temp.ant.connector	passed
op-mode 1g	Setup_02	Temp.ant.connector	passed
op-mode 1n	Setup_02	Temp.ant.connector	passed
op-mode 2b	Setup_02	Temp.ant.connector	passed
op-mode 2g	Setup_02	Temp.ant.connector	passed
op-mode 2n	Setup_02	Temp.ant.connector	passed
op-mode 3b	Setup_02	Temp.ant.connector	passed
op-mode 3g	Setup_02	Temp.ant.connector	passed
op-mode 3n	Setup_02	Temp.ant.connector	passed

This test report replaces report referenced by: ODE_MJP_KYOCE_1102_FCCd.

 7 layers AG, Borsigstr. 11
 40880 Ratingen, Germany
 Phone +49 (0)2102 749 0

Responsible for Accreditation Scope:



Responsible for Test Report:

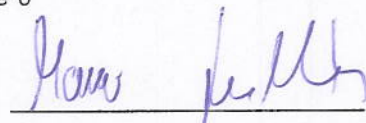



1 Administrative Data

1.1 Testing Laboratory

Company Name: 7Layers AG
Address Borsigstr. 11
40880 Ratingen
Germany

This facility has been fully described in a report submitted to the FCC and accepted under the registration number 96716 .

The test facility is also accredited by the following accreditation organisation:
Laboratory accreditation no.: DAKkS D-PL-12140-01-01

Responsible for Accreditation Scope: Dipl.-Ing. Bernhard Retka
Dipl.-Ing. Robert Machulec
Dipl.-Ing. Thomas Hoell
Dipl.-Ing. Andreas Petz

Report Template Version: 2011-11-16

1.2 Project Data

Responsible for testing and report: Dipl.-Ing. Marco Kullik
Date of Test(s): 2011-09-20 to 2011-12-07
Date of Report: 2011-12-07

1.3 Applicant Data

Company Name: Kyocera Corporation
Address: 2-1-1 Kagahara, Tsuzuki-ku
Yokohama- shi
Japan
Contact Person: Mr. Yoshikazu Yamamoto

1.4 Manufacturer Data

Company Name: please see applicant data

Address:

Contact Person:



2 Test object Data

2.1 General EUT Description

Equipment under Test:	WLAN transceiver build in a mobile phone
Type Designation:	F42 (OASY1)
Kind of Device:	Mobile Phone
(optional)	
Voltage Type:	AC (Mains) / DC (USB)
Voltage Level:	120 V / 5.0 V
Tested Modulation Type:	DBPSK; OFDM:BPSK; OFDM:64-QAM

General product description:

The WLAN (Wireless Local Area Network) Transceiver is operating in the 2.4 GHz ISM band in the range 2412.0 – 2462.0 MHz and uses the Direct Sequence Spread Spectrum (DSSS) Modulation.

Specific product description for the EUT:

The EUT is a mobile phone containing besides WLAN also GSM/UMTS and Bluetooth transceivers.
It supports the modes IEEE802.11b, IEEE802.11g and IEEE802.11n (up to 72.2 Mbps data rate / MCS7).

The EUT provides the following ports:

Ports

Temporary antenna connector
Enclosure
AC Port (power line), provided by external power supply of auxiliary computer
USB Port, to charge the internal battery and for data transfer

The main components of the EUT are listed and described in Chapter 2.2



2.2 EUT Main components

Type, S/N, Short Descriptions etc. used in this Test Report

Short Description	Equipment under Test	Type Designation	Serial No.	HW Status	SW Status	Date of Receipt
EUT A (Code: DE030e01)	WLAN transceiver	F42 (OASY1)	0044013500 40232	1.0 115_0_	0077	2011-08-18
Remark: EUT A is equipped with a temporary antenna connector.						
EUT B (Code: DE030n01)	WLAN transceiver	F42 (OASY1)	0044013500 40398	1.0 115_0_	0077	2011-08-18
Remark: EUT B is equipped with an integral antenna (gain = 0.0 dBi).						
EUT C (Code: DE030f06)	WLAN transceiver	F42 (OASY1)	0044013500 42079	1.0 132.	0.1234	2011-11-02
Remark: EUT B is equipped with an integral antenna (gain = 0.0 dBi).						
EUT D (Code: DE030q01)	WLAN transceiver	F42 (OASY1)	0044013500 42077	1.0 115_0_	0077	2011-08-18
Remark: EUT B is equipped with an integral antenna (gain = 0.0 dBi).						

NOTE: The short description is used to simplify the identification of the EUT in this test report.

2.3 Ancillary Equipment

For the purposes of this test report, ancillary equipment is defined as equipment which is used in conjunction with the EUT to provide operational and control features to the EUT. It is necessary to configure the system in a typical fashion, as a customer would normally use it. But nevertheless Ancillary Equipment can influence the test results.

Short Description	Equipment under Test	Type Designation	HW Status	SW Status	Serial No.	FCC ID
AE1 U	SB cable	-	-	-	-	-



2.4 Auxiliary Equipment

For the purposes of this test report, auxiliary equipment is defined as equipment which is used temporarily to enable operational and control features especially used for the tests of the EUT which is not used during normal operation or equipment that is used during the tests in combination with the EUT but is not subject of this test report. It is necessary to configure the system in a typical fashion, as a customer would normally use it. But nevertheless Auxiliary Equipment can influence the test results.

Short Description	Equipment under Test	Type Designation	Serial No.	HW Status	SW Status	FCC ID
AUX1 Laptop	Toshiba Tecra M9	PTM91E-02800TGR	87060248H	-	WinXP Prof. Ger.	-
AUX2 AC/DC	Adapter (for laptop) Toshiba	PA3283U-1ACA	(P/N: G71C0002T410)	-	- - -	-
AUX3 Keyboard	CHERRY	RS 6000 USB ON	G 0000273 2P28	-	- - -	-
AUX4 Mouse	Logitech	M-BB48 LZC905054	78	-	- - -	-
AUX5 WLAN	Access Point Aruba	AP120121	AD0007421	-	- - -	-
AUX6 Controller	for AP Aruba	800-4 A100185	79	-	Aruba OS 3.3.1.10	-

2.5 EUT Setups

This chapter describes the combination of EUTs and equipment used for testing. The rationale for selecting the EUTs, ancillary and auxiliary equipment and interconnecting cables, is to test a representative configuration meeting the requirements of the referenced standards.

Setup No.	Combination of EUTs	Description and Rationale
Setup_01	EUT C + AE1 + AUX1 + AUX2 + AUX3 + AUX4 + AUX5 + AUX6	setup for the test conducted emissions (representative computer peripheral setup to connect to USB port); AUX7 + 8 are used to setup a normal WLAN connection
Setup_02	EUT A + AE1	setup for conducted radio measurements
Setup_03	EUT B + AE1	setup for radiated measurements
Setup_04	EUT D + AE1	setup for conducted radio measurements



2.6 Operating Modes

This chapter describes the operating modes of the EUTs used for testing.

Op. Mode	Description of Operating Modes	Remarks
op-mode 1b	TX-mode, the EUT transmits on the lowest channel (2412 MHz)	Worst case data rate 1 Mbps
op-mode 1g	TX-mode, the EUT transmits on the lowest channel (2412 MHz)	Worst case data rate 6 Mbps
op-mode 1n	TX-mode, the EUT transmits on the lowest channel (2412 MHz)	Worst case data rate 54 Mbps
op-mode 2b	TX-mode, the EUT transmits on the mid channel (2437 MHz)	Worst case data rate 1 Mbps
op-mode 2g	TX-mode, the EUT transmits on the mid channel (2437 MHz)	Worst case data rate 6 Mbps
op-mode 2n	TX-mode, the EUT transmits on the mid channel (2437 MHz)	Worst case data rate 54 Mbps
op-mode 3b	TX-mode, the EUT transmits on the highest channel (2462 MHz)	Worst case data rate 1 Mbps
op-mode 3g	TX-mode, the EUT transmits on the highest channel (2462 MHz)	Worst case data rate 6 Mbps
op-mode 3n	TX-mode, the EUT transmits on the highest channel (2462 MHz)	Worst case data rate 54 Mbps
op-mode 4	TX-mode, the EUT transmits on the mid channel (2437 MHz); traffic on USB Port; GSM link on TCH661 (1880.0 MHz)	representative worse-case op-mode to exercise the USB port while WLAN is active and to force high power consumption, also GSM transmission is enabled

2.7 Special software used for testing

The EUT is operating in a WLAN test mode set by the applicant's prepared script files.

2.8 Product labelling

2.8.1 FCC ID label

Please refer to the documentation of the applicant.

2.8.2 Location of the label on the EUT

Please refer to the documentation of the applicant.



3 Test Results

3.1 Conducted emissions (AC power line)

Standard FCC Part 15, 10-1-10 Subpart C

The test was performed according to: ANSI C63.4-2009

3.1.1 Test Description

The test set-up was made in accordance to the general provisions of ANSI C63.4-2009. The Equipment Under Test (EUT) was setup in a shielded room to perform the conducted emissions measurements in a typical installation configuration. The EUT was powered from 50 μ H || 50 Ohm Line Impedance Stabilization Network (LISN) which meets the requirements of ANSI C63.4-2009, Annex B, in the frequency range of the measurements. The LISN's unused connections were terminated with 50 Ohm loads.

The measurement procedure consists of two steps. It is implemented into the EMI test software ES-K1 from R&S.

Step 1: Preliminary scan

Intention of this step is, to determine the conducted EMI-profile of the EUT.

EMI receiver settings:

- Detector: Peak - Maxhold
- Frequency range: 150 kHz – 30 MHz
- Frequency steps: 5 kHz
- IF-Bandwidth: 9 kHz
- Measuring time / Frequency step: 20 ms
- Measurement on phase + neutral lines of the power cords

On basis of this preliminary scan the highest amplitudes and the corresponding frequencies relative to the limit are identified. Emissions above the limit and emissions which are in the 10 dB range below the limit are considered.

Step 2: Final measurement

Intention of this step is, to determine the highest emissions with the settings defined in the test specification for the frequencies identified in step 1.

EMI receiver settings:

- Detector: Quasi-Peak
- IF - Bandwidth: 9 kHz
- Measuring time: 1 s / frequency

At each frequency determined in step 1, four measurements are performed in the following combinations:

- 1) Neutral lead - reference ground (PE grounded)
- 2) Phase lead - reference ground (PE grounded)
- 3) Neutral lead - reference ground (PE floating)
- 4) Phase lead - reference ground (PE floating)

The highest value is reported.



3.1.2 Test Requirements / Limits

FCC Part 15, Subpart C, §15.207

Frequency Range (MHz)	QP Limit (dBµV)	AV Limit (dBµV)
0.15 – 0.5	66 to 56	56 to 46
0.5 – 5	56	46
5 – 30	60	50

Used conversion factor: Limit (dBµV) = 20 log (Limit (µV)/1µV).

3.1.3 Test Protocol

Temperature: 22 °C
 Air Pressure: 1017 hPa
 Humidity: 33 %

Op. Mode	Setup	Port
op-mode 4	Setup_01	AC Port (power line)

Power line	Frequency MHz	Measured value QP dBµV	Measured value AV dBµV	QP Limit dBµV	AV Limit dBµV	Delta to QP limit dB	Delta to AV limit dB
N -		-	-	-	-	-	-
L -		-	-	-	-	-	-

Remark: No final measurement was performed because no frequencies (peaks) were found within the offset for acceptance analysis during the preliminary scan. Please see annex for the measurement plot.
 The chosen operating mode is selected as representative mode to generate "worst-case" conditions, i.e. high power consumption.

3.1.4 Test result: Conducted emissions (AC power line)

FCC Part 15, Subpart C		Op. Mode	Result
op-		mode 4	passed



3.2 Occupied bandwidth

Standard FCC Part 15, 10-1-10 Subpart C

The test was performed according to: FCC §15.31

3.2.1 Test Description

The Equipment Under Test (EUT) was setup to perform the occupied bandwidth measurements.

The reference level is the level of the highest amplitude signal observed from the transmitter at either the fundamental frequency or first-order modulation products in all typical modes of operation, including the unmodulated carrier, even if atypical.

The results recorded were measured with the modulation which produce the worst-case (widest) occupied bandwidth.

The EUT was connected to spectrum analyzer via a short coax cable with a known loss.

Analyzer settings:

- Resolution Bandwidth (RBW): 100 kHz
- Video Bandwidth (VBW): 300 kHz
- Span: 30 MHz

3.2.2 Test Requirements / Limits

FCC Part 15, Subpart C, §15.247 (a) (2)

Systems using digital modulation techniques may operate in the 902-928 MHz, 2400-2483.5 MHz and 5725-5850 MHz bands. The minimum 6 dB bandwidth shall be at least 500 kHz.

Used conversion factor: Output power (dBm) = 10 log (Output power (W) / 1mW)

3.2.3 Test Protocol

Temperature: 22 – 24 °C
 Air Pressure: 1007 – 1029 hPa
 Humidity: 33 – 36 %

Op. Mode	Setup	Port
op-mode 1b	Setup_02	Temp.ant.connector

6 dB bandwidth MHz	Remarks
7.104 -	

Remark: Please see annex for the measurement plot.

Op. Mode	Setup	Port
op-mode 1g	Setup_02	Temp.ant.connector

6 dB bandwidth MHz	Remarks
15.156 -	

Remark: Please see annex for the measurement plot.

Op. Mode	Setup	Port
op-mode 1n	Setup_02	Temp.ant.connector

6 dB bandwidth MHz	Remarks
15.156 -	

Remark: Please see annex for the measurement plot.

Op. Mode	Setup	Port
op-mode 2b	Setup_02	Temp.ant.connector

6 dB bandwidth MHz	Remarks
7.104 -	

Remark: Please see annex for the measurement plot.

Op. Mode	Setup	Port
op-mode 2g	Setup_02	Temp.ant.connector

6 dB bandwidth MHz	Remarks
15.216 -	

Remark: Please see annex for the measurement plot.

Op. Mode	Setup	Port
op-mode 2n	Setup_02	Temp.ant.connector

6 dB bandwidth MHz	Remarks
15.156 -	

Remark: Please see annex for the measurement plot.



Op. Mode	Setup	Port
op-mode 3b	Setup_02	Temp.ant.connector

6 dB bandwidth MHz	Remarks
7.584 -	

Remark: Please see annex for the measurement plot.

Op. Mode	Setup	Port
op-mode 3g	Setup_02	Temp.ant.connector

6 dB bandwidth MHz	Remarks
15.156 -	

Remark: Please see annex for the measurement plot.

Op. Mode	Setup	Port
op-mode 3n	Setup_02	Temp.ant.connector

6 dB bandwidth MHz	Remarks
15.156 -	

Remark: Please see annex for the measurement plot.

3.2.4 Test result: Occupied bandwidth

FCC Part 15, Subpart C		Op. Mode	Result
op-		mode 1b	passed
op-		mode 1g	passed
op-		mode 1n	passed
op-		mode 2b	passed
op-		mode 2g	passed
op-		mode 2n	passed
op-		mode 3b	passed
op-		mode 3g	passed
op-		mode 3n	passed



3.3 Peak power output

Standard FCC Part 15, 10-1-10 Subpart C

The test was performed according to: FCC §15.31

3.3.1 Test Description

The Equipment Under Test (EUT) was set up to perform the output power measurements. The results recorded were measured with the modulation which produces the worst-case (highest) output power. The reference level of the spectrum analyzer was set higher than the output power of the EUT. The EUT was connected to the spectrum analyzer via a short coax cable with a known loss.

3.3.2 Test Requirements / Limits

FCC Part 15, Subpart C, §15.247 (b) (3)

For systems using digital modulation techniques in the 902-928 MHz, 2400-2483.5 MHz and 5725-5850 MHz bands: 1 watt.

Used conversion factor: $\text{Limit (dBm)} = 10 \log (\text{Limit (W)}/1\text{mW})$
==> Maximum Output Power: 30 dBm



3.3.3 Test Protocol

Temperature: 23 °C
Air Pressure: 1017 hPa
Humidity: 32 %

Op. Mode	Setup	Port
op-mode 1b	Setup_04	Temp.ant.connector

Output power dBm	Remarks
10.96	The EIRP including antenna gain (0.0 dBi) is 10.96 dBm

Remark: Please see annex for the measurement plot.

Op. Mode	Setup	Port
op-mode 1g	Setup_04	Temp.ant.connector

Output power dBm	Remarks
11.35	The EIRP including antenna gain (0.0 dBi) is 11.35 dBm

Remark: Please see annex for the measurement plot.

Op. Mode	Setup	Port
op-mode 1n	Setup_04	Temp.ant.connector

Output power dBm	Remarks
11.31	The EIRP including antenna gain (0.0 dBi) is 11.31 dBm

Remark: Please see annex for the measurement plot.

Op. Mode	Setup	Port
op-mode 2b	Setup_04	Temp.ant.connector

Output power dBm	Remarks
10.84	The EIRP including antenna gain (0.0 dBi) is 10.84 dBm

Remark: Please see annex for the measurement plot.

Op. Mode	Setup	Port
op-mode 2g	Setup_04	Temp.ant.connector

Output power dBm	Remarks
11.48	The EIRP including antenna gain (0.0 dBi) is 11.48 dBm

Remark: Please see annex for the measurement plot.

Op. Mode	Setup	Port
op-mode 2n	Setup_04	Temp.ant.connector

Output power dBm	Remarks
11.75	The EIRP including antenna gain (0.0 dBi) is 11.75 dBm

Remark: Please see annex for the measurement plot.



Op. Mode	Setup	Port
op-mode 3b	Setup_04	Temp.ant.connector

Output power dBm	Remarks
10.87	The EIRP including antenna gain (0.0 dBi) is 10.87 dBm

Remark: Please see annex for the measurement plot.

Op. Mode	Setup	Port
op-mode 3g	Setup_04	Temp.ant.connector

Output power dBm	Remarks
11.63	The EIRP including antenna gain (0.0 dBi) is 11.63 dBm

Remark: Please see annex for the measurement plot.

Op. Mode	Setup	Port
op-mode 3n	Setup_04	Temp.ant.connector

Output power dBm	Remarks
11.66	The EIRP including antenna gain (0.0 dBi) is 11.66 dBm

Remark: Please see annex for the measurement plot.

3.3.4 Test result: Peak power output

FCC Part 15, Subpart C		Op. Mode	Result
op-		mode 1b	passed
op-		mode 1g	passed
op-		mode 1n	passed
op-		mode 2b	passed
op-		mode 2g	passed
op-		mode 2n	passed
op-		mode 3b	passed
op-		mode 3g	passed
op-		mode 3n	passed



3.4 Spurious RF conducted emissions

Standard FCC Part 15, 10-1-10 Subpart C

The test was performed according to: FCC §15.31

3.4.1 Test Description

The Equipment Under Test (EUT) was set up to perform the spurious emissions measurements.

The EUT was connected to spectrum analyzer via a short coax cable with a known loss.

Analyzer settings:

- Detector: Peak-Maxhold
- Frequency range: 30 – 25000 MHz
- Resolution Bandwidth (RBW): 100 kHz
- Video Bandwidth (VBW): 300 kHz
- Sweep Time: 330 s

The reference value for the measurement of the spurious RF conducted emissions is determined during the test "band edge compliance" (cf. chapter 3.6). This value is used to calculate the 20 dBc limit.

3.4.2 Test Requirements / Limits

FCC Part 15, Subpart C, §15.247 (c)

In any 100 kHz bandwidth outside the frequency band in which the spread spectrum intentional radiator is operating, the radio frequency power that is produced by the intentional radiator shall be at least 20 dB below that in the 100 kHz bandwidth within the band that contains the highest level of the desired power, based on either an RF conducted or a radiated measurement, provided the transmitter demonstrates compliance with the peak conducted power limits. If the transmitter complies with the conducted power limits based on the use of RMS averaging over a time interval, as permitted under paragraph (b)(3) of this section, the attenuation required under this paragraph shall be 30 dB instead of 20 dB.

3.4.3 Test Protocol

Temperature: 24 °C
 Air Pressure: 1029 hPa
 Humidity: 36 %

Op. Mode	Setup	Port
op-mode 1b	Setup_02	Temp.ant.connector

Frequency MHz	Corrected measurement value dBm	Reference value dBm	Limit dBm	Delta to limit dB
6936 -	37.5	1.6	-18.4	19.1

Remark: No (further) spurious emissions in the range 20 dB below the limit found.
 Please see annex for the measurement plot.

Op. Mode	Setup	Port
op-mode 1g	Setup_02	Temp.ant.connector

Frequency MHz	Corrected measurement value dBm	Reference value dBm	Limit dBm	Delta to limit dB
6885 -	36.4	-1.5	-21.5	14.9

Remark: No (further) spurious emissions in the range 20 dB below the limit found.
 Please see annex for the measurement plot.

Op. Mode	Setup	Port
op-mode 1n	Setup_02	Temp.ant.connector

Frequency MHz	Corrected measurement value dBm	Reference value dBm	Limit dBm	Delta to limit dB
6936 -	37.6	-1.5	-21.5	16.1

Remark: No (further) spurious emissions in the range 20 dB below the limit found.
 Please see annex for the measurement plot.

Op. Mode	Setup	Port
op-mode 2b	Setup_02	Temp.ant.connector

Frequency MHz	Corrected measurement value dBm	Reference value dBm	Limit dBm	Delta to limit dB
6936 -	37.4	1.5	-18.5	18.9

Remark: No (further) spurious emissions in the range 20 dB below the limit found.
 Please see annex for the measurement plot.

Op. Mode **Setup** **Port**
 op-mode 2g Setup_02 Temp.ant.connector

Frequency MHz	Corrected measurement value dBm	Reference value dBm	Limit dBm	Delta to limit dB
6936 -	37.1	-1.8	-21.8	15.3

Remark: No (further) spurious emissions in the range 20 dB below the limit found.
 Please see annex for the measurement plot.

Op. Mode **Setup** **Port**
 op-mode 2n Setup_02 Temp.ant.connector

Frequency MHz	Corrected measurement value dBm	Reference value dBm	Limit dBm	Delta to limit dB
6886 -	37.2	-1.9	-21.9	15.3

Remark: No (further) spurious emissions in the range 20 dB below the limit found.
 Please see annex for the measurement plot.

Op. Mode **Setup** **Port**
 op-mode 3b Setup_02 Temp.ant.connector

Frequency MHz	Corrected measurement value dBm	Reference value dBm	Limit dBm	Delta to limit dB
6886 -	37.2	1.3	-18.7	18.5

Remark: No (further) spurious emissions in the range 20 dB below the limit found.
 Please see annex for the measurement plot.

Op. Mode **Setup** **Port**
 op-mode 3g Setup_02 Temp.ant.connector

Frequency MHz	Corrected measurement value dBm	Reference value dBm	Limit dBm	Delta to limit dB
6886 -	36.7	-1.8	-21.8	14.9

Remark: No (further) spurious emissions in the range 20 dB below the limit found.
 Please see annex for the measurement plot.

Op. Mode **Setup** **Port**
 op-mode 3n Setup_02 Temp.ant.connector

Frequency MHz	Corrected measurement value dBm	Reference value dBm	Limit dBm	Delta to limit dB
6936 -	37.0	-1.8	-21.8	15.2

Remark: No (further) spurious emissions in the range 20 dB below the limit found.
 Please see annex for the measurement plot.



3.4.4 Test result: Spurious RF conducted emissions

FCC Part 15, Subpart C	Op. Mode	Result
op-	mode 1b	passed
op-	mode 1g	passed
op-	mode 1n	passed
op-	mode 2b	passed
op-	mode 2g	passed
op-	mode 2n	passed
op-	mode 3b	passed
op-	mode 3g	passed
op-	mode 3n	passed

3.5 Spurious radiated emissions

Standard FCC Part 15, 10-1-10 Subpart C

The test was performed according to: ANSI C63.4-2009

3.5.1 Test Description

The test set-up was made in accordance to the general provisions of ANSI C63.4-2009. The Equipment Under Test (EUT) was set up on a non-conductive table 1.0 x 2.0 m in the semi-anechoic chamber. The influence of the EUT support table that is used between 30-1000 MHz was evaluated.

The test was performed at the distance of 3 m between the EUT and the receiving antenna. The measurement procedure is implemented into the EMI test software ES-K1 from R&S. The radiated emissions measurements were made in a typical installation configuration. Exploratory tests are performed at 3 orthogonal axes to determine the worst-case orientation of a body-worn or handheld EUT. The final test on all kind of EUTs is performed at 2 axes. A pre-check is also performed while the EUT is powered from both AC and DC (battery) power in order to find the worst-case operating condition.

1. Measurement up to 30 MHz

The Loop antenna HFH2-Z2 is used.

Step 1: pre measurement

- Anechoic chamber
- Antenna distance: 10 m
- Detector: Peak-Maxhold
- Frequency range: 0.009 - 0.15 and 0.15 - 30 MHz
- Frequency steps: 0.1 kHz and 5 kHz
- IF-Bandwidth: 0.2 kHz and 10 kHz
- Measuring time / Frequency step: 100 ms

Intention of this step is, to determine the radiated EMI-profile of the EUT. Afterwards the relevant emissions for the final measurement are identified.

Step 2: final measurement

For the relevant emissions determined in step 1, an additional measurement with the following settings will be performed. Intention of this step is to find the maximum emission level.

- Open area test side
- Antenna distance: according to the Standard
- Detector: Quasi-Peak
- Frequency range: 0.009 - 30 MHz
- Frequency steps: measurement at frequencies detected in step 1
- IF-Bandwidth: 200 Hz - 10 kHz
- Measuring time / Frequency step: 100 ms

2. Measurement above 30 MHz and up to 1 GHz

Step 1: Preliminary scan

Preliminary test to identify the highest amplitudes relative to the limit.

Settings for step 1:

- Detector: Peak-Maxhold
- Frequency range: 30 – 1000 MHz
- Frequency steps: 60 kHz
- IF-Bandwidth: 120 kHz
- Measuring time / Frequency step: 100 μ s
- Turntable angle range: -180 to 180°
- Turntable step size: 90°
- Height variation range: 1 – 3 m
- Height variation step size: 2 m
- Polarisation: Horizontal + Vertical

Intention of this step is, to determine the radiated EMI-profile of the EUT. Afterwards the relevant emissions for the final measurement are identified.

Step 2: second measurement

For the relevant emissions determined in step 1, an additional measurement with the following settings will be performed. Intention of this step is, to find out the approximate turntable angle and antenna height for each frequency.

- Detector: Peak – Maxhold
- Measured frequencies: in step 1 determined frequencies
- IF – Bandwidth: 120 kHz
- Measuring time: 100 ms
- Turntable angle range: -180 to 180°
- Turntable step size: 45°
- Height variation range: 1 – 4 m
- Height variation step size: 0.5 m
- Polarisation: horizontal + vertical

After this step the EMI test system has determined the following values for each frequency (of step 1):

- Frequency
- Azimuth value (of turntable)
- Antenna height

The last two values have now the following accuracy:

- Azimuth value (of turntable): 45°
- Antenna height: 0.5 m

Step 3: final measurement

In this step the accuracy of the turntable azimuth and antenna height will be improved. This is necessary to find out the maximum value of every frequency.

For each frequency, which was determined the turntable azimuth and antenna height will be adjusted. The turntable azimuth will be slowly varied by $\pm 22.5^\circ$ around this value. During this action the value of emission is continuously measured. The turntable azimuth at the highest emission will be recorded and adjusted. In this position the antenna height is also slowly varied by ± 25 cm around the antenna height determined. During this action the value of emission is also continuously measured. The antenna height of the highest emission will also be recorded and adjusted.

- Detector: Peak – Maxhold
- Measured frequencies: in step 1 determined frequencies
- IF – Bandwidth: 120 kHz
- Measuring time: 100 ms
- Turntable angle range: -22.5° to $+ 22.5^\circ$ around the determined value
- Height variation range: -0.25 m to $+ 0.25$ m around the determined value

Step 4: final measurement with QP detector

With the settings determined in step 3, the final measurement will be performed:
EMI receiver settings for step 4:



- Detector: Quasi-Peak(< 1 GHz)
- Measured frequencies: in step 1 determined frequencies
- IF – Bandwidth: 120 kHz
- Measuring time: 1 s

3. Measurement above 1 GHz

The following modifications apply to the measurement procedure for the frequency range above 1 GHz:

The Equipment Under Test (EUT) was set up on a non-conductive support at 1.4 m height in the fully-anechoic chamber. The measurement distance was reduced to 1 m. The results were extrapolated by the extrapolation factor of 20 dB/decade (inverse linear-distance for field strength measurements, inverse linear-distance squared for the power reference level measurements). Due to the fact that in this frequency range a double ridged wave guided horn antenna (up to 18 GHz) and a horn antenna (18–25 GHz) are used, the steps 2-4 are omitted. Step 1 was performed with one height of the receiving antenna only.

EMI receiver settings:

- Detector: Peak, Average
- IF Bandwidth = 1 MHz

After the measurement a plot will be generated which contains a diagram with the results of the preliminary scan and a chart with the frequencies and values of the results of the final measurement.

For the data rate in mode n the test is performed as worst-case-check in order to verify that emissions have a comparable level as found at modes b and g. Typically, the measurement is performed in the frequency range 1 to 8 GHz but it depends on the emissions found during the test for the modes b and g. Please refer to the results for the used frequency range.

3.5.2 Test Requirements / Limits

FCC Part 15, Subpart C, §15.247 (d)

... In addition, radiated emissions which fall in the restricted bands, as defined in Section 15.205(a), must also comply with the radiated emission limits specified in Section 15.209(a) (see Section 15.205(c)).

FCC Part 15, Subpart C, §15.209, Radiated Emission Limits

Frequency in MHz	Limit (µV/m) M	Measurement distance (m)	Limit(dBµV/m @10m)
0.009 – 0.49	2400/F(kHz)	300	Limit (dBµV/m)+30dB
0.49 – 1.705	24000/F(kHz)	30	Limit (dBµV/m)+10dB
1.705 – 30	30	30	Limit (dBµV/m)+10dB

Frequency in MHz	Limit (µV/m)	Measurement distance (m)	Limit (dBµV/m)
30 – 88	100	3	40.0
88 – 216	150	3	43.5
216 – 960	200	3	46.0
above 960	500	3	54.0

§15.35(b)

..., there is also a limit on the radio frequency emissions, as measured using instrumentation with a peak detector function, corresponding to 20 dB above the maximum permitted average limit....

Used conversion factor: Limit (dBµV/m) = 20 log (Limit (µV/m)/1µV/m)

3.5.3 Test Protocol

Temperature: 25 °C
 Air Pressure: 1010 – 1015 hPa
 Humidity: 41 %

3.5.3.1 Measurement up to 30 MHz

Op. Mode **Setup** **Port**
 op-mode 2b Setup_04 Enclosure

Polarisation	Frequency MHz	Corrected value dBµV/m			Limit dBµV/m	Limit dBµV/m	Limit dBµV/m	Delta to limit dB	Delta to limit dB
		QP	Peak	AV	QP	Peak	AV	QP/Peak	AV
0°	-	-	-	-	---			-	-
90°	-	-	-	-	---			-	-

Remark: No (further) spurious emissions in the range 20 dB below the limit found therefore step 2 was not performed.

3.5.3.2 Measurement above 30 MHz

Op. Mode **Setup** **Port**
 op-mode 1b Setup_03 Enclosure

Polarisation	Frequency MHz	Corrected value dBµV/m			Limit dBµV/m	Limit dBµV/m	Limit dBµV/m	Delta to limit dB	Delta to limit dB
		QP	Peak	AV	QP	Peak	AV	QP/Peak	AV
Vert. + Hor.	4824	-	52.0	50.1	-	74.0	54.0	22.0	3.9

Remark: No (further) spurious emissions in the range 20 dB below the limit found.

Op. Mode **Setup** **Port**
 op-mode 2b Setup_03 Enclosure

Polarisation	Frequency MHz	Corrected value dBµV/m			Limit dBµV/m	Limit dBµV/m	Limit dBµV/m	Delta to limit dB	Delta to limit dB
		QP	Peak	AV	QP	Peak	AV	QP/Peak	AV
Vert. + Hor.	4874	-	51.7	50.1	-	74.0	54.0	22.3	3.9
Vert. + Hor.	7311	-	52.3	47.6	-	74.0	54.0	21.7	6.4

Remark: No (further) spurious emissions in the range 20 dB below the limit found.



Op. Mode **Setup** **Port**
 op-mode 3b Setup_03 Enclosure

Polarisation	Frequency MHz	Corrected value dBµV/m			Limit dBµV/m	Limit dBµV/m	Limit dBµV/m	Delta to limit dB	Delta to limit dB
		QP	Peak	AV	QP	Peak	AV	QP/Peak	AV
Vert. + Hor.	2484	-	50.6	40.0	-	74.0	54.0	23.4	14.0
Vert. + Hor.	4924	-	53.6	52.2	-	74.0	54.0	20.4	1.8
Vert. + Hor.	7386	-	51.9	46.9	-	74.0	54.0	22.1	7.1

Remark: No (further) spurious emissions in the range 20 dB below the limit found.

Op. Mode **Setup** **Port**
 op-mode 1g Setup_03 Enclosure

Polarisation	Frequency MHz	Corrected value dBµV/m			Limit dBµV/m	Limit dBµV/m	Limit dBµV/m	Delta to limit dB	Delta to limit dB
		QP	Peak	AV	QP	Peak	AV	QP/Peak	AV
-	-	-	-	-	---			-	-

Remark: No (further) spurious emissions in the range 20 dB below the limit found.

Op. Mode **Setup** **Port**
 op-mode 2g Setup_03 Enclosure

Polarisation	Frequency MHz	Corrected value dBµV/m			Limit dBµV/m	Limit dBµV/m	Limit dBµV/m	Delta to limit dB	Delta to limit dB
		QP	Peak	AV	QP	Peak	AV	QP/Peak	AV
-	-	-	-	-	---			-	-

Remark: No (further) spurious emissions in the range 20 dB below the limit found.

Op. Mode **Setup** **Port**
 op-mode 3g Setup_03 Enclosure

Polarisation	Frequency MHz	Corrected value dBµV/m			Limit dBµV/m	Limit dBµV/m	Limit dBµV/m	Delta to limit dB	Delta to limit dB
		QP	Peak	AV	QP	Peak	AV	QP/Peak	AV
Vert. + Hor.	2484	-	51.3	39.9	-	74.0	54.0	22.7	14.1

Remark: No (further) spurious emissions in the range 20 dB below the limit found.



Op. Mode **Setup** **Port**
 op-mode 1n Setup_03 Enclosure

Polarisation	Frequency MHz	Corrected value dBµV/m			Limit dBµV/m	Limit dBµV/m	Limit dBµV/m	Delta to limit dB	Delta to limit dB
		QP	Peak	AV	QP	Peak	AV	QP/Peak	AV
-	-	-	-	-	- - -			-	-

Remark: No (further) spurious emissions in the range 20 dB below the limit found.
 The measurement was performed from 1 GHz up to 8 GHz because no significant spurious emissions were found outside this frequency range in op-mode b and g.

Op. Mode **Setup** **Port**
 op-mode 2n Setup_03 Enclosure

Polarisation	Frequency MHz	Corrected value dBµV/m			Limit dBµV/m	Limit dBµV/m	Limit dBµV/m	Delta to limit dB	Delta to limit dB
		QP	Peak	AV	QP	Peak	AV	QP/Peak	AV
Vert. + Hor.	4874	-	50.5	36.8	-	74.0	54.0	23.5	17.2
Vert. + Hor.	7311	-	50.8	36.6	-	74.0	54.0	23.2	17.4

Remark: No (further) spurious emissions in the range 20 dB below the limit found.
 The measurement was performed from 1 GHz up to 8 GHz because no significant spurious emissions were found outside this frequency range in op-mode b and g.

Op. Mode **Setup** **Port**
 op-mode 3n Setup_03 Enclosure

Polarisation	Frequency MHz	Corrected value dBµV/m			Limit dBµV/m	Limit dBµV/m	Limit dBµV/m	Delta to limit dB	Delta to limit dB
		QP	Peak	AV	QP	Peak	AV	QP/Peak	AV
Vert. + Hor.	2484	-	51.3	39.0	-	74.0	54.0	22.7	15.0

Remark: No (further) spurious emissions in the range 20 dB below the limit found.
 The measurement was performed from 1 GHz up to 8 GHz because no significant spurious emissions were found outside this frequency range in op-mode b and g.

3.5.4 Test result: Spurious radiated emissions

FCC Part 15, Subpart C		Op. Mode	Result
op-		mode 1b	passed
op-		mode 2b	passed
op-		mode 3b	passed
op-		mode 1g	passed
op-		mode 2g	passed
op-		mode 3g	passed
op-		mode 1n	passed
op-		mode 2n	passed
op-		mode 3n	passed



3.6 Band edge compliance

Standard FCC Part 15, 10-1-10 Subpart C

The test was performed according to: ANSI C63.4-2009, FCC §15.31

3.6.1 Test Description

The procedure to show compliance with the band edge requirement is divided into two measurements:

1. Show compliance of the lower band edge by a conducted measurement and
2. show compliance of the higher band edge by a radiated and conducted measurement.

For the conducted measurement, the Equipment Under Test (EUT) is placed in a shielded room. The radiated emissions measurements are performed in a typical installation configuration inside the fully anechoic chamber using a horn antenna at 1 m distance.

For the first measurement the EUT is set to transmit on the lowest channel (2412 MHz). The lower band edge is 2400 MHz.

Analyzer settings:

- Detector: Peak
- RBW / VBW = 100 / 300 kHz

For the second measurement the EUT is set to transmit on the highest channel (2462 MHz). The higher band edge is 2483.5 MHz.

Analyzer settings for conducted measurement:

- Detector: Peak
- RBW / VBW = 100 / 300 kHz

EMI receiver settings for radiated measurement:

- Detector: Peak, Average
- IF Bandwidth = 1 MHz

3.6.2 Test Requirements / Limits

FCC Part 15.247 (d)

"In any 100 kHz bandwidth outside the frequency band in which the spread spectrum or digitally modulated intentional radiator is operating, the radio frequency power that is produced by the intentional radiator shall be at least 20 dB below that in the 100 kHz bandwidth within the band that contains the highest level of the desired power, based on either an RF conducted or a radiated measurement, provided the transmitter demonstrates compliance with the peak conducted power limits. ...

If the transmitter complies with the conducted power limits based on the use of RMS averaging over a time interval, as permitted under paragraph (b)(3) of this section, the attenuation required under this paragraph shall be 30 dB instead of 20 dB. Attenuation below the general limits specified in Section 15.209(a) is not required. In addition, radiated emissions which fall in the restricted bands, as defined in Section 15.205(a), must also comply with the radiated emission limits specified in Section 15.209(a) (see Section 15.205(c))."

For the conducted measurement the RF power at the band edge shall be "at least 20 dB below that in the 100 kHz bandwidth within the band that contains the highest level of the desired power..."

For the radiated measurement of the higher band edge connected to a restricted band the limit is "specified in Section 15.209(a)".

3.6.3 Test Protocol

3.6.3.1 Lower band edge

Conducted measurement

Temperature: 24 °C
 Air Pressure: 1029 hPa
 Humidity: 36 %

Op. Mode	Setup	Port
op-mode 1b	Setup_02	Temp.ant.connector

Frequency MHz	Measured value dBm	Reference value dBm	Limit dBm	Delta to limit dB
2400.00 -	42.1	1.6	-18.4	23.7

Remark: Please see annex for the measurement plot.

Op. Mode	Setup	Port
op-mode 1g	Setup_02	Temp.ant.connector

Frequency MHz	Measured value dBm	Reference value dBm	Limit dBm	Delta to limit dB
2400.00 -	43.2	-1.5	-21.5	21.7

Remark: Please see annex for the measurement plot.

Op. Mode	Setup	Port
op-mode 1n	Setup_02	Temp.ant.connector

Frequency MHz	Measured value dBm	Reference value dBm	Limit dBm	Delta to limit dB
2400.00 -	43.2	-1.5	-21.5	21.7

Remark: Please see annex for the measurement plot.

3.6.3.2 Higher band edge

Conducted measurement

Temperature: 24 °C
 Air Pressure: 1029 hPa
 Humidity: 36 %

Op. Mode	Setup	Port
op-mode 3b	Setup_02	Temp.ant.connector

Frequency MHz	Measured value dBm	Reference value dBm	Limit dBm	Delta to limit dB
2483.50 -	45.3	1.3	-18.7	26.6

Remark: Please see annex for the measurement plot.

Op. Mode	Setup	Port
op-mode 3g	Setup_02	Temp.ant.connector

Frequency MHz	Measured value dBm	Reference value dBm	Limit dBm	Delta to limit dB
2483.50 -	44.9	-1.8	-21.8	23.1

Remark: Please see annex for the measurement plot.

Op. Mode	Setup	Port
op-mode 3n	Setup_02	Temp.ant.connector

Frequency MHz	Measured value dBm	Reference value dBm	Limit dBm	Delta to limit dB
2483.50 -	45.0	-1.8	-21.8	23.2

Remark: Please see annex for the measurement plot.



Radiated measurement

Temperature: 25 °C
 Air Pressure: 1010 hPa
 Humidity: 41 %

Op. Mode	Setup	Port
op-mode 3b	Setup_03	Enclosure

Frequency MHz	Polarisation	Corrected value dBµV/m		Limit Peak dBµV/m	Limit AV dBµV/m	Delta to Peak limit dB	Delta to AV limit dB
		Peak	AV				
2483.50	Vertical + horizontal	50.6 40.	6 74.	0	54.0	23.4	13.4

Remark: Please see annex for the measurement plot.

Op. Mode	Setup	Port
op-mode 3g	Setup_03	Enclosure

Frequency MHz	Polarisation	Corrected value dBµV/m		Limit Peak dBµV/m	Limit AV dBµV/m	Delta to Peak limit dB	Delta to AV limit dB
		Peak	AV				
2483.50	Vertical + horizontal	51.3 39.	9 74.	0	54.0	23.7	14.1

Remark: Please see annex for the measurement plot.

Op. Mode	Setup	Port
op-mode 3n	Setup_03	Enclosure

Frequency MHz	Polarisation	Corrected value dBµV/m		Limit Peak dBµV/m	Limit AV dBµV/m	Delta to Peak limit dB	Delta to AV limit dB
		Peak	AV				
2483.50	Vertical + horizontal	51.3 39.	0 74.	0	54.0	22.7	15.0

Remark: Please see annex for the measurement plot.

3.6.4 Test result: Band edge compliance

FCC Part 15, Subpart C		Op. Mode	Result
op-		mode 1b	passed
op-		mode 1g	passed
op-		mode 1n	passed
		op-mode 3 b	passed
		op-mode 3 g	passed
		op-mode 3 n	passed



3.7 Power density

Standard FCC Part 15, 10-1-10 Subpart C

The test was performed according to: FCC §15.31

3.7.1 Test Description

The EUT was connected to spectrum analyzer via a short coax cable with a known loss.

Analyzer settings:

- Detector: Peak-Maxhold
- Span: 300 kHz
- Resolution Bandwidth (RBW): 3 kHz
- Video Bandwidth (VBW): 30 kHz
- Sweep Time: Coupled

3.7.2 Test Requirements / Limits

FCC Part 15, Subpart C, §15.247 (e)

For digitally modulated systems, the peak power spectral density conducted from the intentional radiator to the antenna shall not be greater than 8 dBm in any 3 kHz band during any time interval of continuous transmission.

...

The same method of determining the conducted output power shall be used to determine the power spectral density.

3.7.3 Test Protocol

Temperature: 24 °C
 Air Pressure: 1029 hPa
 Humidity: 36 %

Op. Mode	Setup	Port
op-mode 1b	Setup_02	Temp.ant.connector

Power density dBm/3 kHz	Remarks
-11.6 -	

Remark: Please see annex for the measurement plot.

Op. Mode	Setup	Port
op-mode 1g	Setup_02	Temp.ant.connector

Power density dBm/3 kHz	Remarks
-14.4 -	

Remark: Please see annex for the measurement plot.

Op. Mode	Setup	Port
op-mode 1n	Setup_02	Temp.ant.connector

Power density dBm/3 kHz	Remarks
-14.2 -	

Remark: Please see annex for the measurement plot.

Op. Mode	Setup	Port
op-mode 2b	Setup_02	Temp.ant.connector

Power density dBm/3 kHz	Remarks
-11.2 -	

Remark: Please see annex for the measurement plot.

Op. Mode	Setup	Port
op-mode 2g	Setup_02	Temp.ant.connector

Power density dBm/3 kHz	Remarks
-14.6 -	

Remark: Please see annex for the measurement plot.

Op. Mode	Setup	Port
op-mode 2n	Setup_02	Temp.ant.connector

Power density dBm/3 kHz	Remarks
-15.3 -	

Remark: Please see annex for the measurement plot.



Op. Mode	Setup	Port
op-mode 3b	Setup_02	Temp.ant.connector

Power density dBm/3 kHz	Remarks
-11.5 -	

Remark: Please see annex for the measurement plot.

Op. Mode	Setup	Port
op-mode 3g	Setup_02	Temp.ant.connector

Power density dBm/3 kHz	Remarks
-14.6 -	

Remark: Please see annex for the measurement plot.

Op. Mode	Setup	Port
op-mode 3n	Setup_02	Temp.ant.connector

Power density dBm/3 kHz	Remarks
14.5 -	

Remark: Please see annex for the measurement plot.

3.7.4 Test result: Power density

FCC Part 15, Subpart C		Op. Mode	Result
op-		mode 1b	passed
op-		mode 1g	passed
op-		mode 1n	passed
op-		mode 2b	passed
op-		mode 2g	passed
op-		mode 2n	passed
op-		mode 3b	passed
op-		mode 3g	passed
op-		mode 3n	passed

4 Test Equipment

he calibration, hardware and software states are shown for the testing period.

Test Equipment Anechoic Chamber

Lab ID: Lab 2
Manufacturer: Frankonia
Description: Anechoic Chamber for radiated testing
Type: 10.58x6.38x6 m³

Single Devices for Anechoic Chamber

Single Device Name	Type	Serial Number	Manufacturer
Air compressor	none	-	Atlas Copco
Anechoic Chamber	10.58 x 6.38 x 6.00 m ³ FCC listing 96716 3m Part15/18 IC listing 3699A-1 3m	none	Frankonia 2011/01/11 2014/01/10 2011/02/07 2014/02/06
Controller Innco 2000	CO 2000	CO2000/328/12470 406/L	Innco innovative constructions GmbH
Controller Maturo	MCU	961208	Maturo GmbH
EMC camera	CE-CAM/1	-	CE-SYS
EMC camera Nr.2	CCD-400E	0005033	Mitsubishi
Filter ISDN	B84312-C110-E1	-	Siemens&Matsushita
Filter Universal 1A	BB4312-C30-H3	-	Siemens&Matsushita

Test Equipment Auxiliary Equipment for Conducted emissions

Lab ID: Lab 1
Manufacturer: Rohde & Schwarz GmbH & Co.KG
Description: EMI Conducted Auxiliary Equipment

Single Devices for Auxiliary Equipment for Conducted emissions

Single Device Name	Type	Serial Number	Manufacturer
AC Power Source	Chroma 6404	64040001304	Chroma ATE INC.
Cable "LISN to ESI"	RG214 Path Calibration	W18.03+W48.03	Huber&Suhner 2010/11/06 2011/11/05
Coupling-Decoupling- Network	CDN ENY41 Standard calibration	100002	Rohde & Schwarz GmbH & Co. KG 2011/01/20 2013/01/19
One-Line V-Network	ESH 3-Z6 Standard calibration	100489	Rohde & Schwarz GmbH & Co. KG 2011/02/08 2014/02/07
Two-Line V-Network	ESH 3-Z5	828304/029	Rohde & Schwarz GmbH & Co. KG
Two-Line V-Network	ESH 3-Z5 DKD calibration DKD calibration	829996/002	Rohde & Schwarz GmbH & Co. KG 2008/10/13 2011/10/12 2011/01/20 2013/01/19



Test Equipment Auxiliary Equipment for Radiated emissions

Lab ID: Lab 2
Description: Equipment for emission measurements
Serial Number: see single devices

Single Devices for Auxiliary Equipment for Radiated emissions

Single Device Name	Type	Serial Number	Manufacturer	
Antenna mast	AS 620 P	620/37	HD GmbH	
Biconical dipole	VUBA 9117	9117-108	Schwarzbeck	
	Calibration Details		Last Execution	Next Exec.
	Standard Calibration		2008/10/27	2013/10/26
Broadband Amplifier 18MHz-26GHz	JS4-18002600-32-5P 849	785	Miteq	
	Path Calibration		2011/05/11	2011/11/10
Broadband Amplifier 1GHz-4GHz	AFS4-01000400-1Q-10P-4 -		Miteq	
	Path Calibration		2011/05/11	2011/11/10
Broadband Amplifier 30MHz-18GHz	JS4-00101800-35-5P 896	037	Miteq	
	Path Calibration		2011/05/11	2011/11/10
Cable "ESI to EMI Antenna"	EcoFlex10	W18.01-2+W38.01-2	Kabel Kusch	
	Path Calibration		2011/05/11	2011/11/10
Cable "ESI to Horn Antenna"	UFB311A+UFB293C	W18.02-2+W38.02-2	Rosenberger Micro-Coax	
	Path Calibration		2011/05/11	2011/11/10
Double-ridged horn	HF 906	357357/001	Rohde & Schwarz GmbH & Co. KG	
	Calibration Details		Last Execution	Next Exec.
	Standard Calibration		2009/04/16	2012/04/15
Double-ridged horn	HF 906	357357/002	Rohde & Schwarz GmbH & Co. KG	
	Standard Calibration		2009/04/28	2012/04/27
Dreheinheit	DE 325		HD GmbH	
High Pass Filter	4HC1600/12750-1.5-KK	9942011	Trilithic	
	Path Calibration		2011/05/11	2011/11/10
High Pass Filter	5HC2700/12750-1.5-KK	9942012	Trilithic	
	Path Calibration		2011/05/11	2011/11/10
High Pass Filter	5HC3500/12750-1.2-KK	200035008	Trilithic	
	Path Calibration		2011/05/11	2011/11/10
High Pass Filter	WHKX 7.0/18G-8SS	09	Wainwright	
	Path Calibration		2011/05/11	2011/11/10
Log.-per. Antenna	HL 562 Ultralog	830547/003	Rohde & Schwarz GmbH & Co. KG	
	Standard Calibration		2009/05/27	2012/05/26
Loop Antenna	HFH2-Z2	829324/006	Rohde & Schwarz GmbH & Co. KG	
	Calibration Details		Last Execution	Next Exec.
	DKD calibration		2008/10/07	2011/10/06
	Standard calibration		2011/10/27	2014/10/26
Network Analyzer E507	1B	MY42200813	Agilent	
	Standard Calibration		2010/11/09	2011/11/09



Single Devices for Auxiliary Equipment for Radiated emissions (continued)

Single Device Name	Type	Serial Number	Manufacturer
Pyramidal Horn Antenna 26,5 GHz	3160-09	00083069	EMCO Elektronik GmbH
Pyramidal Horn Antenna 40 GHz	3160-10	00086675	EMCO Elektronik GmbH
Tilt device Maturò (Rohacell)	Antrieb TD1.5-10kg	TD1.5- 10kg/024/3790709	Maturò GmbH

Test Equipment Auxiliary Test Equipment

Lab ID:	Lab 2
Manufacturer:	see single devices
Description:	Single Devices for various Test Equipment
Type:	various
Serial Number:	none

Single Devices for Auxiliary Test Equipment

Single Device Name	Type	Serial Number	Manufacturer
AC Power Source	Chroma 6404	64040001304	Chroma ATE INC.
Broadband Power Divider N (Aux)	1506A / 93459	LM390	Weinschel Associates
Broadband Power Divider SMA	WA1515 A85	5	Weinschel Associates
Broadband Power Divider SMA (Aux)	1515 / 93459	LN673	Weinschel Associates
Digital Multimeter 01 (Multimeter)	Voltcraft M-3860M	IJ096055	Conrad Electronics
Digital Multimeter 03 (Multimeter)	Fluke 177	86670383	Fluke Europe B.V.
	Standard calibration		2009/10/07 2011/10/06
	Customized calibration		2011/10/19 2013/10/18
Digital Oscilloscope [SA2] (Aux)	TDS 784C	B021311	Tektronix GmbH
Fibre optic link Satellite (Aux)	FO RS232 Link	181-018	Pontis
Fibre optic link Transceiver (Aux)	FO RS232 Link	182-018	Pontis
Isolating Transformer L	TS 604	1888	Thalheimer Transformatorenwerke GmbH
Notch Filter Ultra Stable (Aux)	WRCA800/960-6EEK 24		Wainwright
Spectrum Analyser FSP3		836722/011	Rohde & Schwarz GmbH & Co. KG
	<i>Calibration Details</i>		<i>Last Execution</i> <i>Next Exec.</i>
	DKD calibration		2008/10/06 2011/10/05
ThermoHygro_01 (Aux)	430202	none	Fischer Feingerätebau K. Fischer GmbH
Vector Signal Generator SMI Q 03B		832492/061	Rohde & Schwarz GmbH & Co.KG



Test Equipment Digital Signalling Devices

Lab ID: Lab 1, Lab 2
Description: Signalling equipment for various wireless technologies.

Single Devices for Digital Signalling Devices

Single Device Name	Type	Serial Number	Manufacturer	
Bluetooth Signalling Unit CBT 100 CBT		589	Rohde & Schwarz GmbH & Co. KG	
Digital Radio Communication Tester	CMD 55	831050/020	Rohde & Schwarz GmbH & Co. KG	
Digital Radio Test Set	6103E	2359	Racal Instruments, Ltd.	
Universal Radio Communication Tester	CMU 200	102366	Rohde & Schwarz GmbH & Co. KG	
	<i>HW/SW Status</i>		<i>Date of Start</i>	<i>Date of End</i>
	Hardware: B11, B21V14, B21-2, B41, B52V14, B52-2, B53-2, B56V14, B68 3v04, PCMCIA, U65V04 Software: K21 4v21, K22 4v21, K23 4v21, K24 4v21, K42 4v21, K43 4v21, K53 4v21, K56 4v22, K57 4v22, K58 4v22, K59 4v22, K61 4v22, K62 4v22, K63 4v22, K64 4v22, K65 4v22, K66 4v22, K67 4v22, K68 4v22, K69 4v22 Firmware: µP1 8v50 02.05.06 ---		2007/07/16	
Universal Radio Communication Tester	CMU 200	837983/052	Rohde & Schwarz GmbH & Co. KG	
	Standard calibration		2008/12/01	2011/11/30
	<i>HW/SW Status</i>		<i>Date of Start</i>	<i>Date of End</i>
	HW options: B11, B21V14, B21-2, B41, B52V14, B52-2, B53-2, B54V14, B56V14, B68 3v04, B95, PCMCIA, U65V02 SW options: K21 4v11, K22 4v11, K23 4v11, K24 4v11, K27 4v10, K28 4v10, K42 4v11, K43 4v11, K53 4v10, K65 4v10, K66 4v10, K68 4v10, Firmware: µP1 8v40 01.12.05 ---		2007/01/02	
	SW: K62, K69		2008/11/03	
Vector Signal Generator SMU 200A		100912	Rohde & Schwarz GmbH & Co. KG	
	<i>Calibration Details</i>		<i>Last Execution</i>	<i>Next Exec.</i>
	Standard calibration		2008/10/28	2011/10/27



Test Equipment Emission measurement devices

Lab ID: Lab 1, Lab 2
Description: Equipment for emission measurements
Serial Number: see single devices

Single Devices for Emission measurement devices

Single Device Name	Type	Serial Number	Manufacturer
Personal Computer De	II	30304832059	Dell
Power Sensor N	RV-Z1 Standard Calibration	836219/005	Rohde & Schwarz GmbH & Co. KG 2009/10/20 2011/10/19
Powermeter N	RVS Standard calibration	836333/064	Rohde & Schwarz GmbH & Co. KG 2009/10/15 2011/10/14
Signal Generator SMR	20	846834/008	Rohde & Schwarz GmbH & Co. KG
Spectrum Analyzer ESI	B 26 Standard Calibration	830482/004	Rohde & Schwarz GmbH & Co. KG 2009/12/03 2011/12/02

Test Equipment Multimeter 12

Lab ID: Lab 3
Description: Ex-Tech 520
Serial Number: 05157876

Single Devices for Multimeter 12

Single Device Name	Type	Serial Number	Manufacturer
Digital Multimeter 12 (Multimeter)	EX520 Standard calibration Customized calibration	05157876	Extech Instruments Corp. 2009/10/07 2011/10/06 2011/10/18 2013/10/17

Test Equipment Shielded Room 02

Lab ID: Lab 1
Manufacturer: Frankonia
Description: Shielded Room for conducted testing
Type: 12 qm
Serial Number: none

Test Equipment Shielded Room 07

Lab ID: Lab 3
Description: Shielded Room 4m x 6m

Test Equipment T/H Logger 04

Lab ID: Lab 3
Description: Lufft Opus10
Serial Number: 7481

Single Devices for T/H Logger 04

Single Device Name	Type	Serial Number	Manufacturer
ThermoHygro DataloggerOpus10 THI (8152.00) 04 (Environ)		7481	Lufft Mess- und Regeltechnik GmbH



Test Equipment Temperature Chamber 01

Lab ID: Lab 3
Manufacturer: see single devices
Description: Temperature Chamber KWP 120/70
Type: Weiss
Serial Number: see single devices

Single Devices for Temperature Chamber 01

Single Device Name	Type	Serial Number	Manufacturer
Temperature Chamber Weiss 01	KWP 120/70	59226012190010	Weiss Umwelttechnik GmbH
	Specific calibration		2010/03/16 2012/03/15

Test Equipment WLAN RF Test Solution

Lab ID: Lab 3
Manufacturer: 7 layers AG
Description: Regulatory WLAN RF Tests
Type: WLAN RF
Serial Number: 001

Single Devices for WLAN RF Test Solution

Single Device Name	Type	Serial Number	Manufacturer
Arbitrary Waveform Generator	TGA12101 284	482	
Power Meter NRVD	NRVD Standard Calibration	832025/059	2011/06/14 2012/06/13
Power Sensor NRV Z1 A	PROBE Standard Calibration	832279/013	2011/06/14 2012/06/13
Power Supply	NGSM 32/10 Standard Calibration	2725	2011/06/15 2012/06/14
Rubidium Frequency Normal MFS	Datum MFS Standard Calibration	002	Datum GmbH 2011/08/17 2012/08/16
Signal Analyser FSIQ26	1119.6001.26	832695/007	Rohde & Schwarz GmbH & Co.KG
Signal Generator SMP	03 Standard Calibration	833680/003	Rohde & Schwarz GmbH & Co.KG 2009/06/23 2012/06/22
Spectrum Analyser FSU2	6 Standard calibration FSU FW Update to v4.31 SP1, K5 v4.31 and K73 v4.31	100136	Rohde & Schwarz GmbH & Co.KG 2011/05/11 2012/05/10 2010/02/17
TOCT Switching Unit	Switching Unit	030106	7 layers, Inc.
TOCT Switching Unit (loan unit)	Switching Unit	030101	7 layers, Inc.
Vector Signal Generator SMIQ03B	SMIQ03B 832 Standard Calibration	870/017	2010/06/23 2013/06/20

5 Photo Report

Photos are included in an external report.

6 Setup Drawings

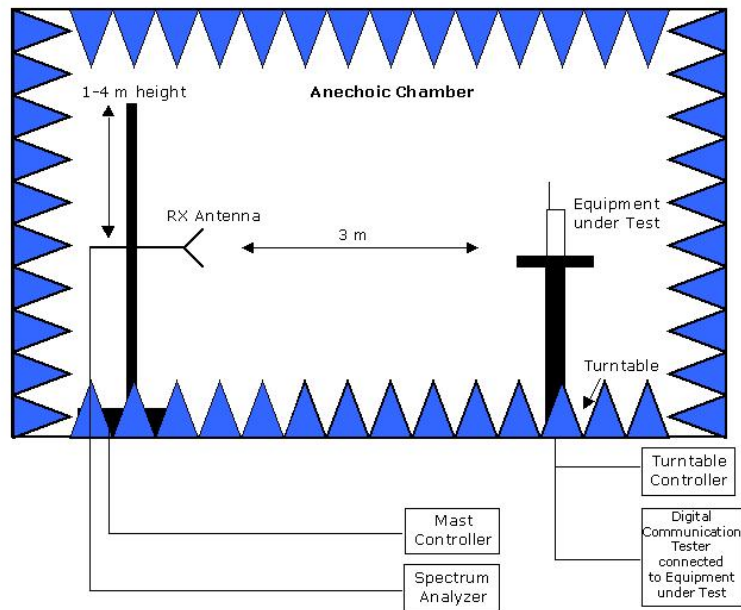

Remark: Depending on the frequency range suitable antenna types, attenuators or preamplifiers are used.

Drawing 1: Setup in the Anechoic chamber:
Measurements below 1 GHz: Semi-anechoic, conducting ground plane.
Measurements above 1 GHz: Fully-anechoic, absorbers on all surfaces.



7 FCC and IC Correlation of measurement requirements

The following tables show the correlation of measurement requirements for WLAN equipment and Digital Apparatus from FCC and IC standards.

WLAN equipment

Measurement	FCC reference	IC reference
Conducted emissions on AC mains	§ 15.207	RSS-Gen: 7.2.4
Occupied bandwidth	§ 15.247 (a) (1)	RSS-210: A8.1
Peak power output	§ 15.247 (b) (1)	RSS-210: A8.4
Spurious RF conducted emissions	§ 15.247 (d)	RSS-Gen: 6; RSS-210: A8.5
Spurious radiated emissions	§ 15.247 (d)	RSS-Gen: 6; RSS-210: A8.5
Band edge compliance	§ 15.247 (d)	RSS-210: A8.5
Power density	§ 15.247 (e)	RSS-210: A8.2 (b)
Antenna requirement	§ 15.203 / 15.204	RSS-Gen: 7.1.2

Digital Apparatus

Measurement	FCC reference	IC reference
Conducted Emissions (AC Power Line)	§15.107 ICES-003	
Spurious Radiated Emissions	§15.109	ICES-003

8 Annex measurement plots

8.1 AC Mains conducted

Op. Mode

op-mode 4

Start Frequency	Stop Frequency	Step Width	Detector	Meas. Time	IF Bandw.	Transducer
150.0 kHz	30.0 MHz	5.0 kHz	MaxPeak Average	20.0 ms	9 kHz	ESH3-Z5

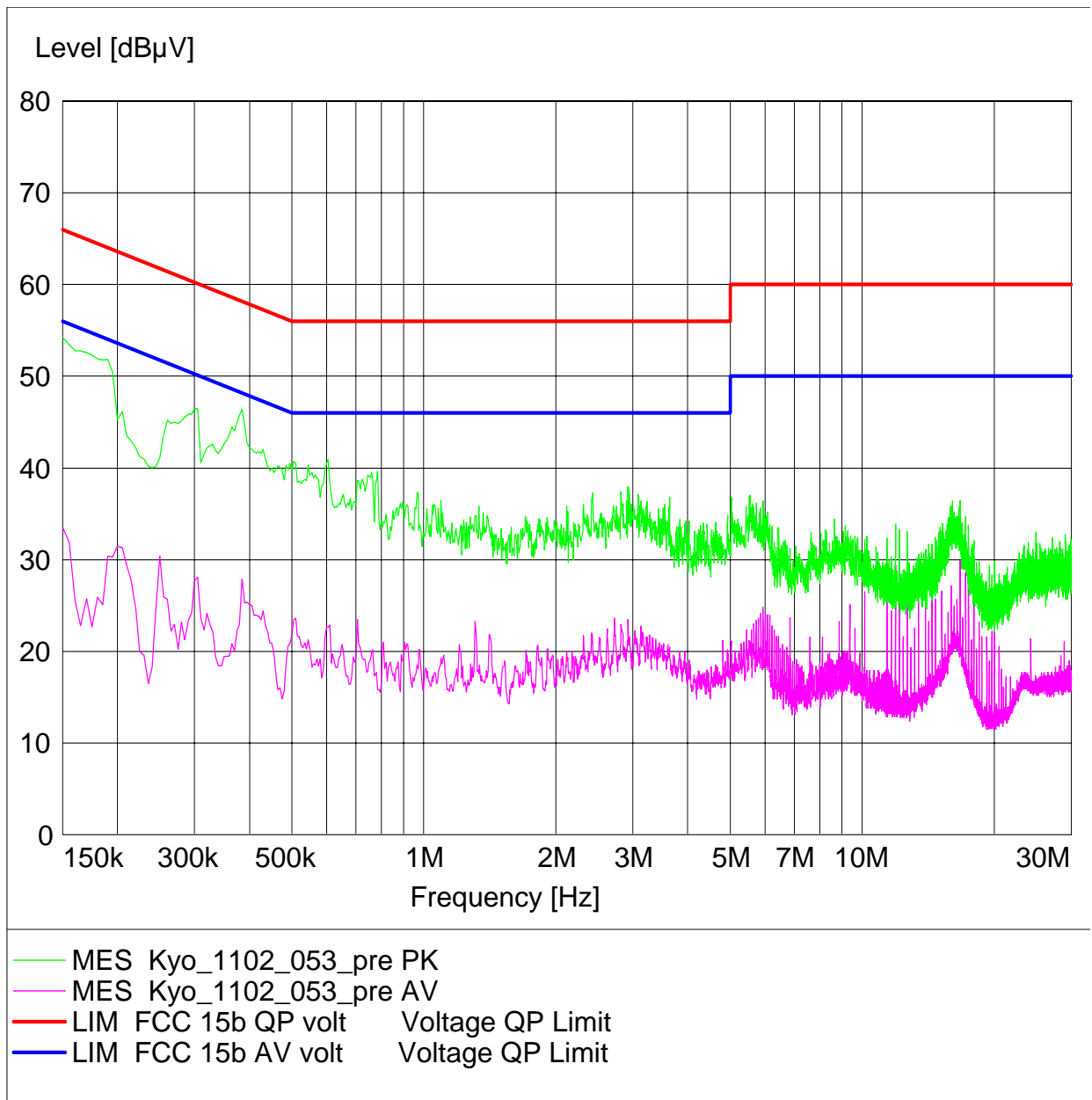



8.2 Occupied bandwidth

8.2.1 Occupied bandwidth operating mode 1

Op. Mode

op-mode 1b

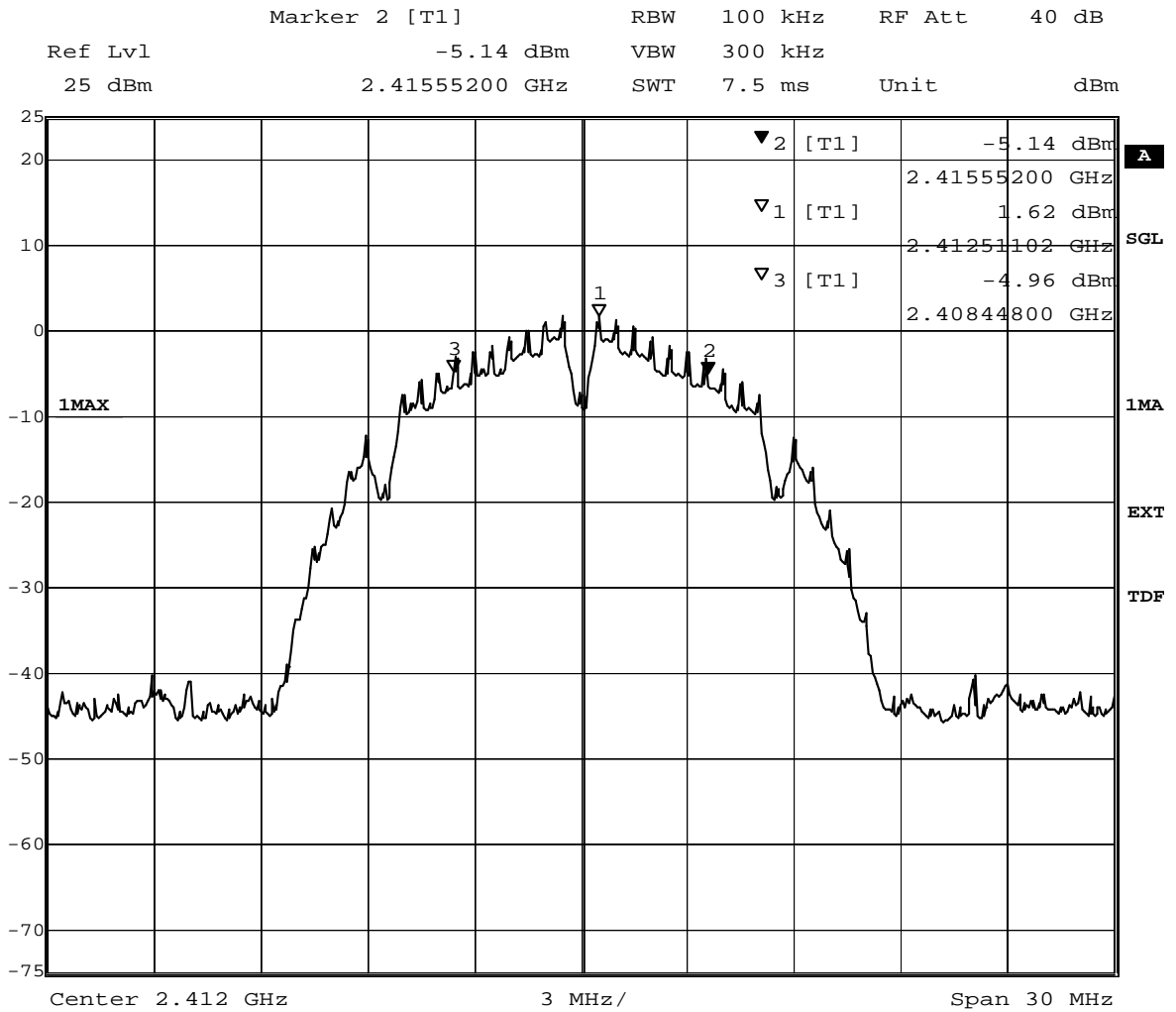

Title: 6dB Bandwidth

Comment A: CH B: 2412 MHz; 6dB bandwidth (kHz):7104

Date: 27.SEP.2011 14:50:15



Op. Mode

op-mode 1g

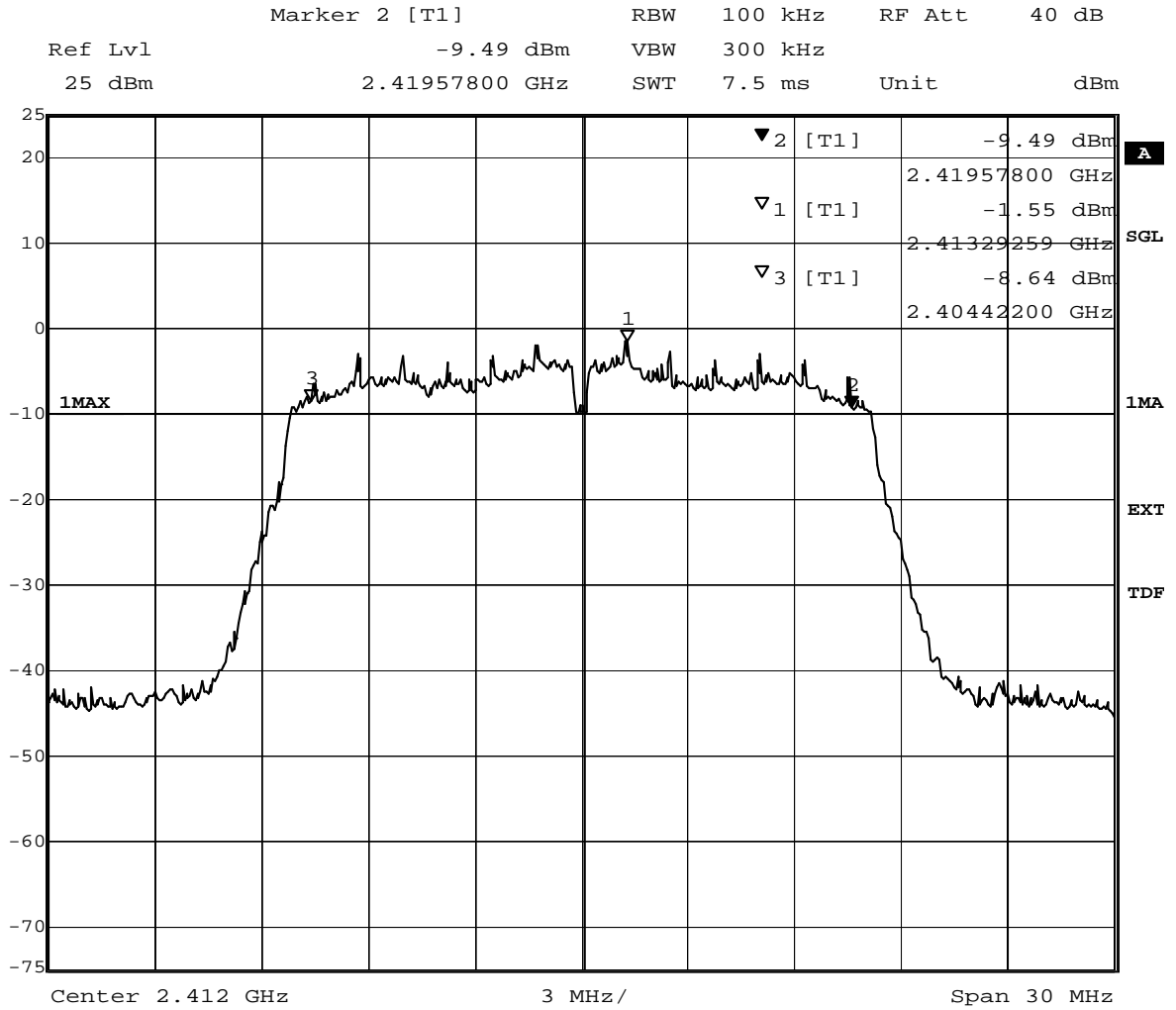

Title: 6dB Bandwidth
 Comment A: CH B: 2412 MHz; 6dB bandwidth (kHz):15156
 Date: 6.OCT.2011 11:55:20



Op. Mode

op-mode 1n

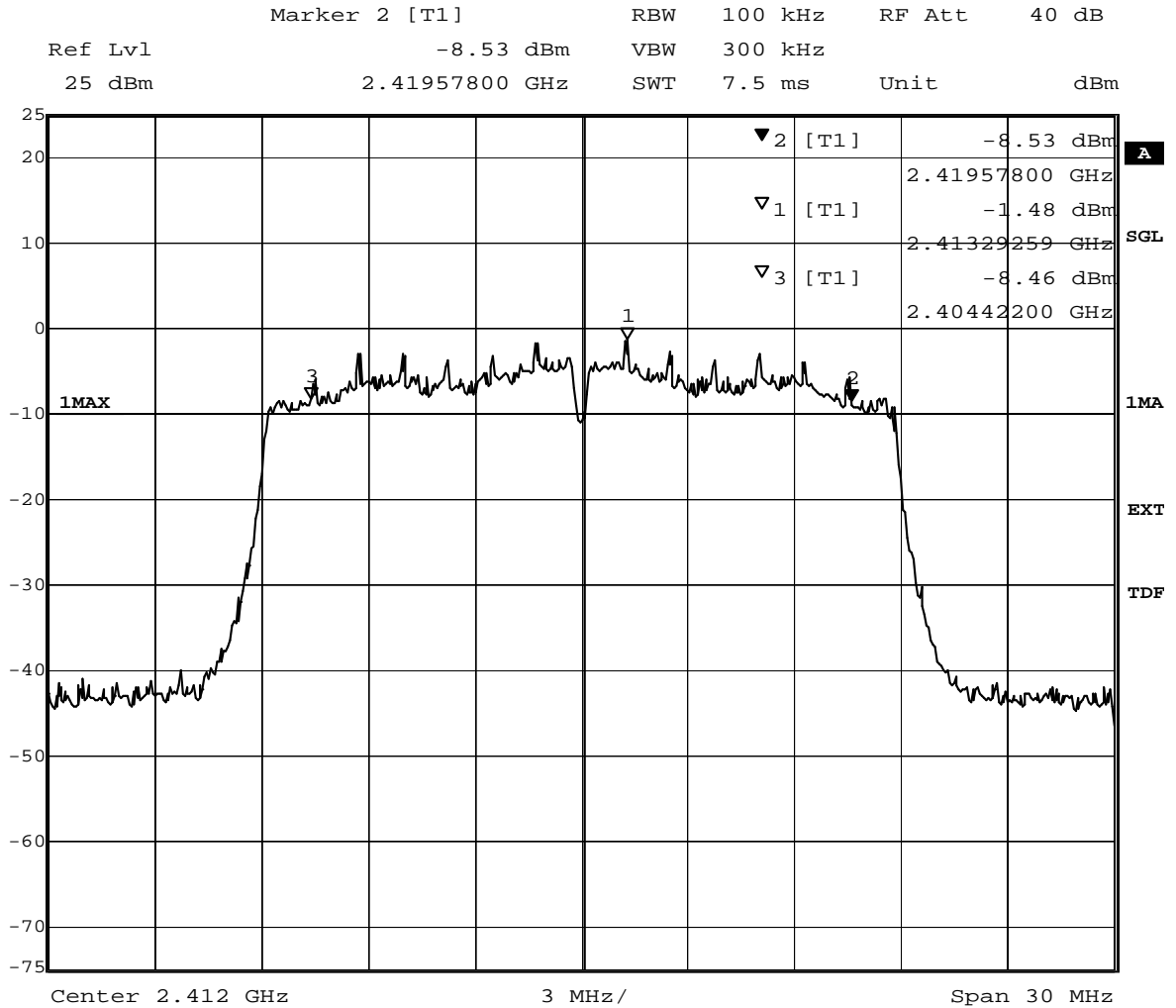

Title: 6dB Bandwidth
 Comment A: CH B: 2412 MHz; 6dB bandwidth (kHz):15156
 Date: 6.OCT.2011 16:17:51



8.2.2 Occupied bandwidth operating mode 2

Op. Mode

op-mode 2b

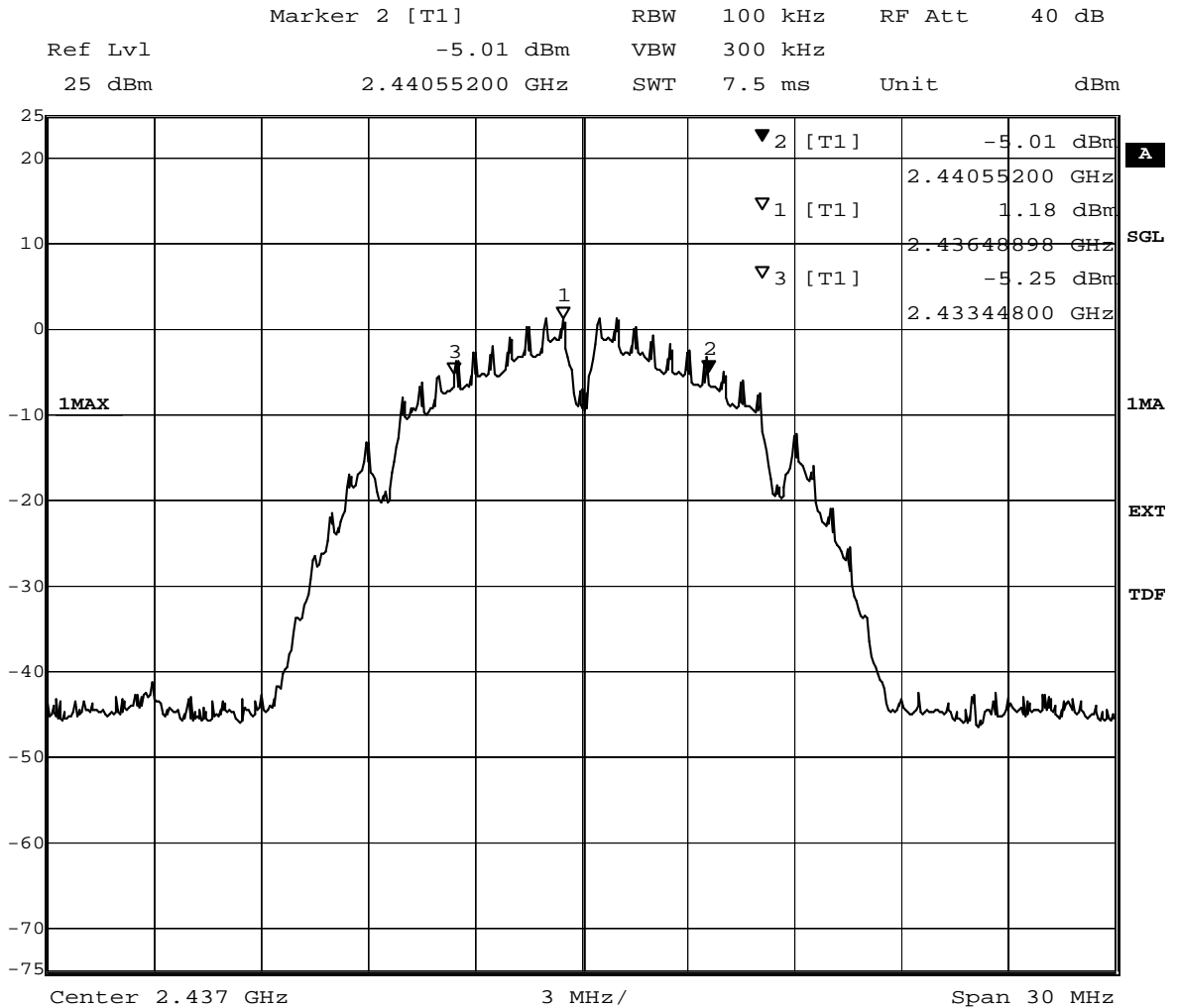

Title: 6dB Bandwidth
 Comment A: CH M: 2437 MHz; 6dB bandwidth (kHz):7104
 Date: 27.SEP.2011 15:36:33



Op. Mode

op-mode 2g

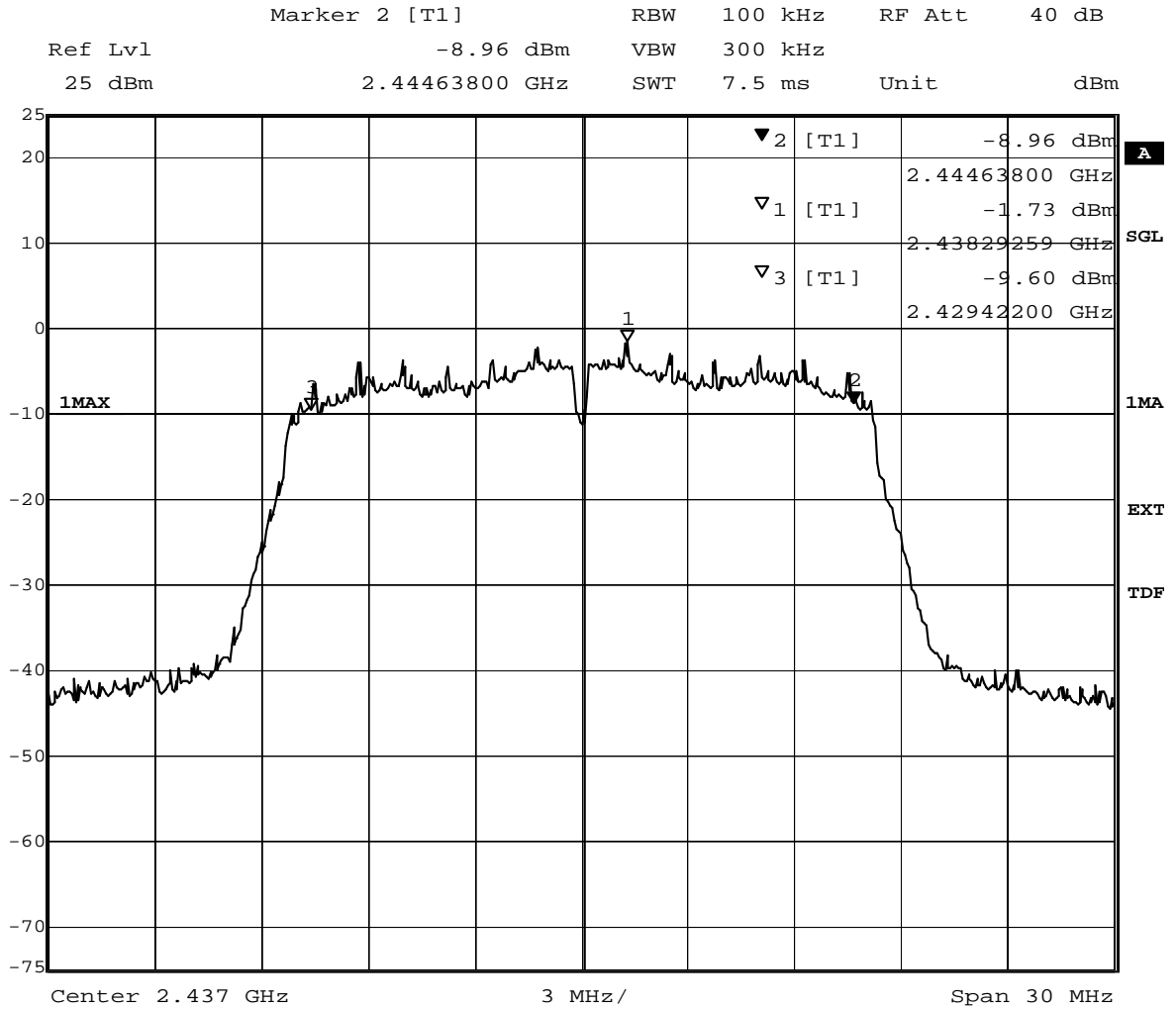

Title: 6dB Bandwidth
 Comment A: CH M: 2437 MHz; 6dB bandwidth (kHz):15216
 Date: 6.OCT.2011 13:07:35



Op. Mode

op-mode 2n

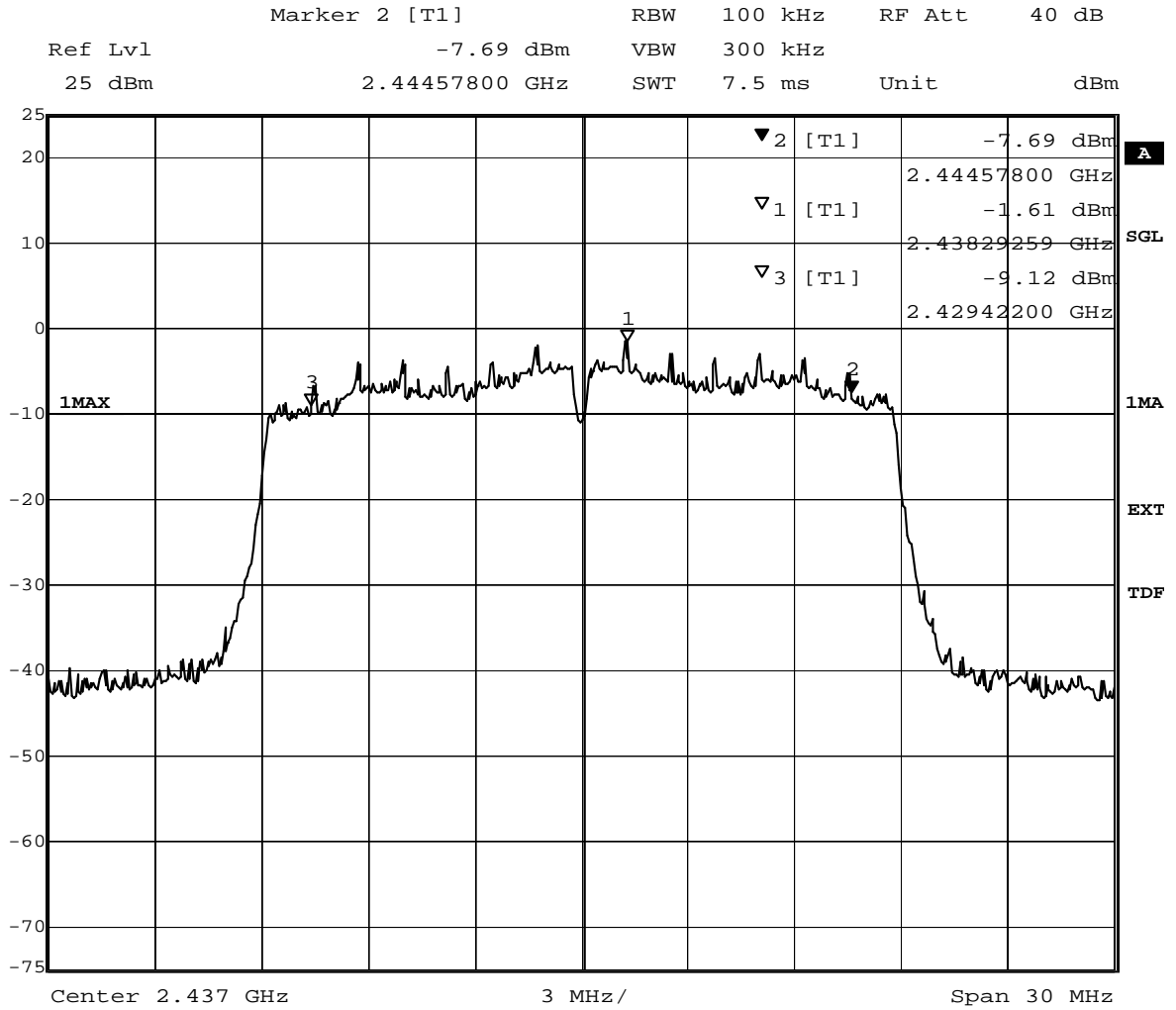

Title: 6dB Bandwidth
 Comment A: CH M: 2437 MHz; 6dB bandwidth (kHz):15156
 Date: 6.OCT.2011 15:18:49

8.2.3 Occupied bandwidth operating mode 3

Op. Mode

op-mode 3b

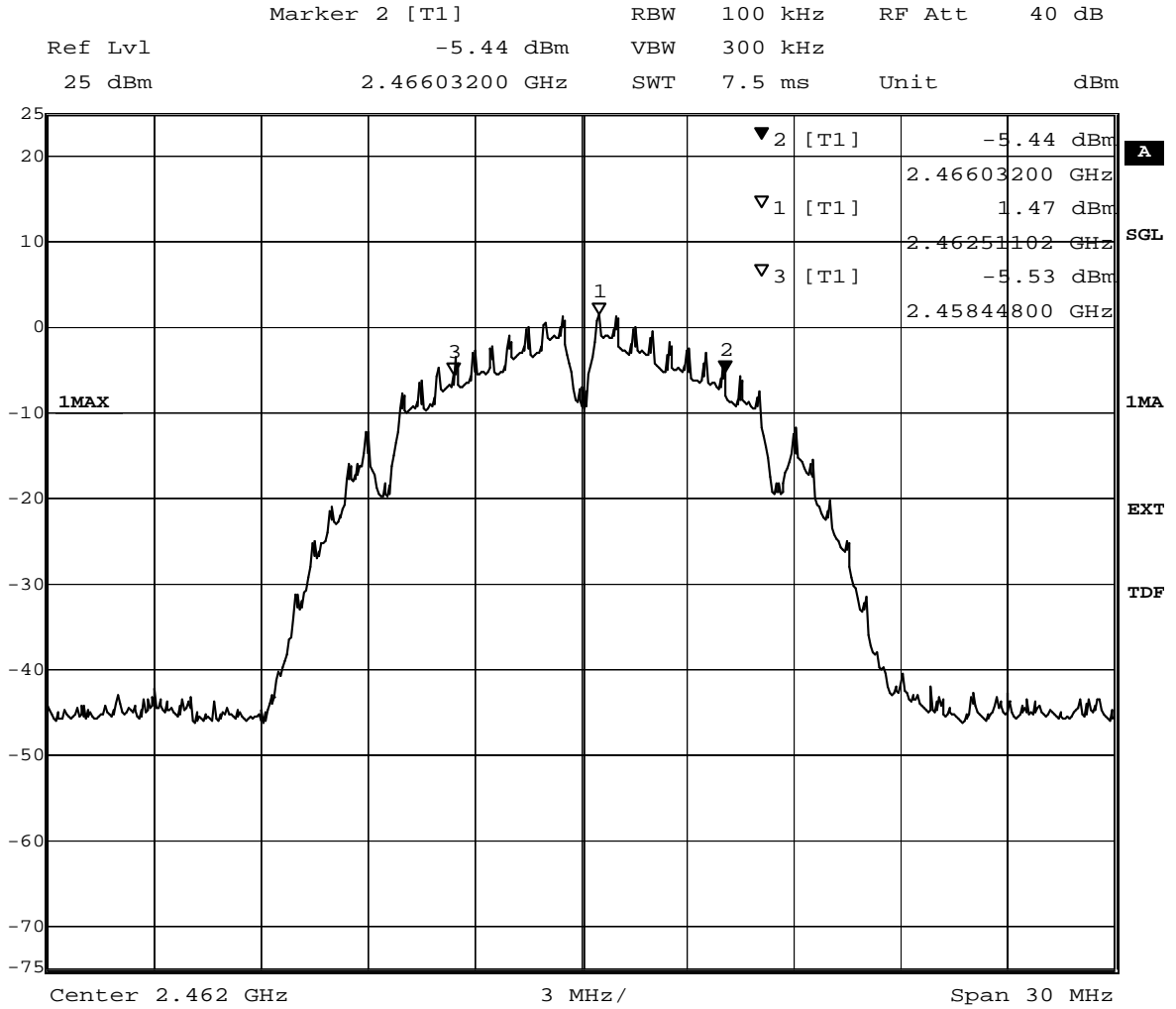

Title: 6dB Bandwidth
 Comment A: CH T: 2462 MHz; 6dB bandwidth (kHz):7584
 Date: 27.SEP.2011 16:12:44



Op. Mode

op-mode 3g

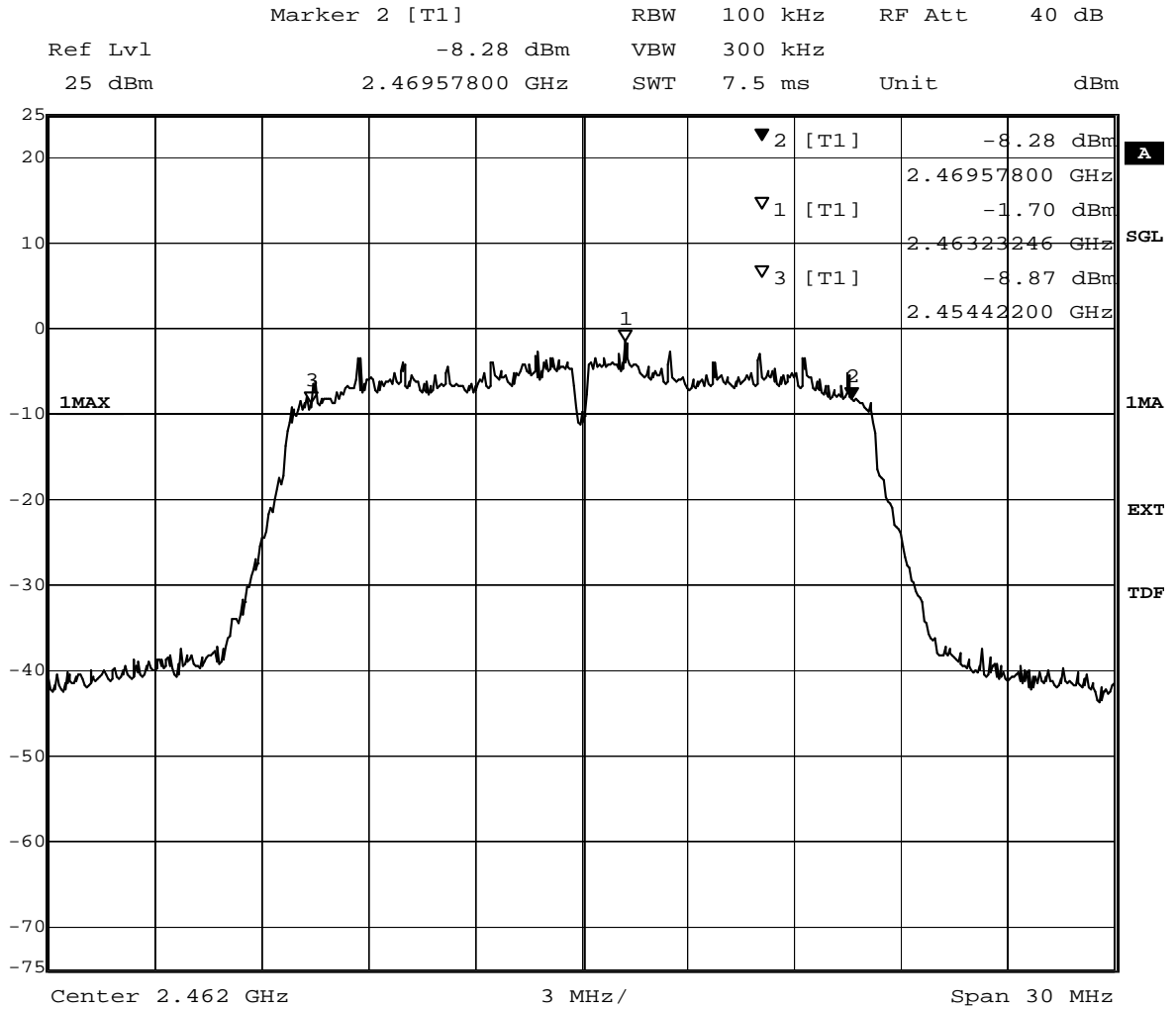

Title: 6dB Bandwidth
 Comment A: CH T: 2462 MHz; 6dB bandwidth (kHz):15156
 Date: 6.OCT.2011 14:11:49



Op. Mode

op-mode 3n

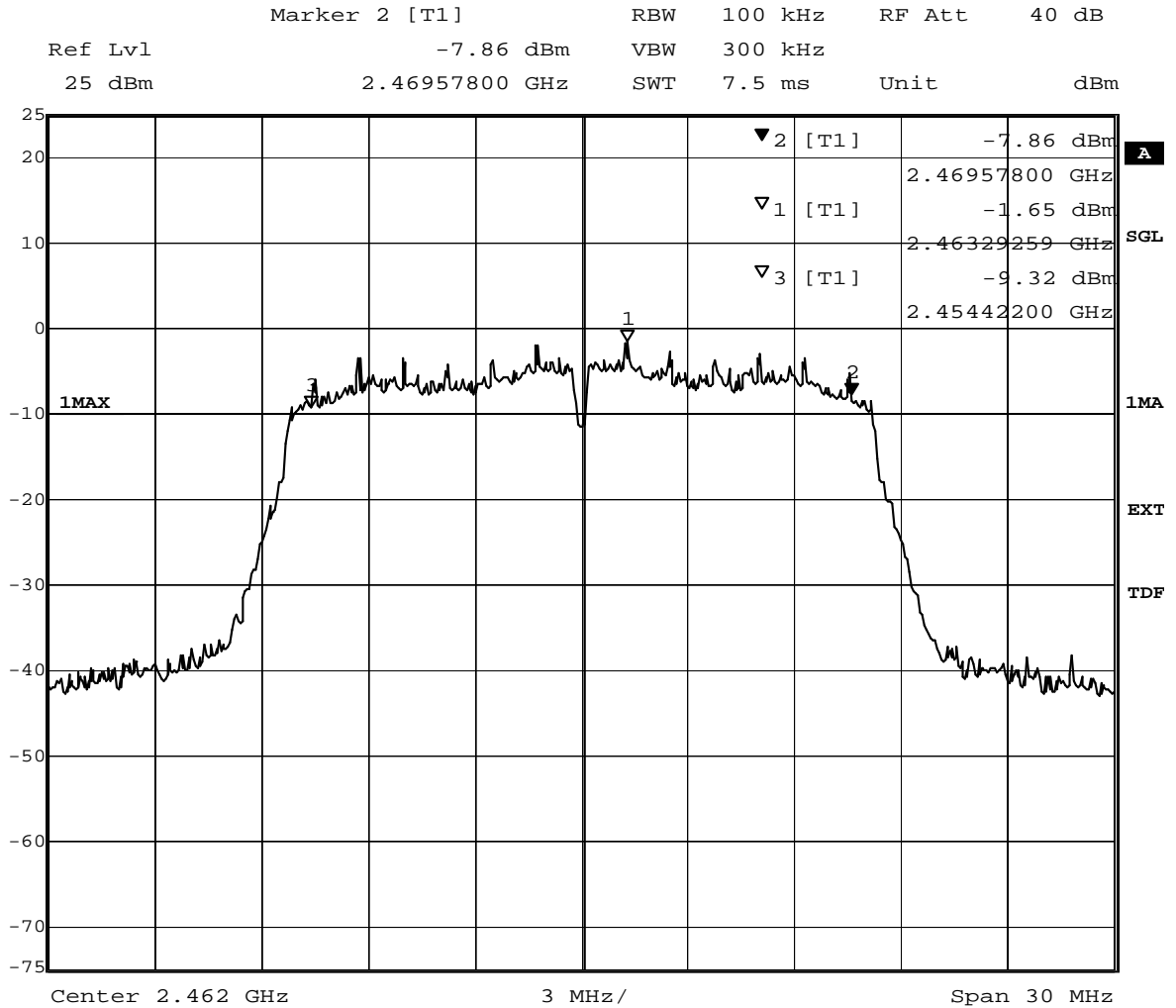

Title: 6dB Bandwidth
 Comment A: CH T: 2462 MHz; 6dB bandwidth (kHz):15156
 Date: 6.OCT.2011 14:46:19

8.3 Peak power output

8.3.1 Peak power output operating mode 1

Op. Mode

op-mode 1b

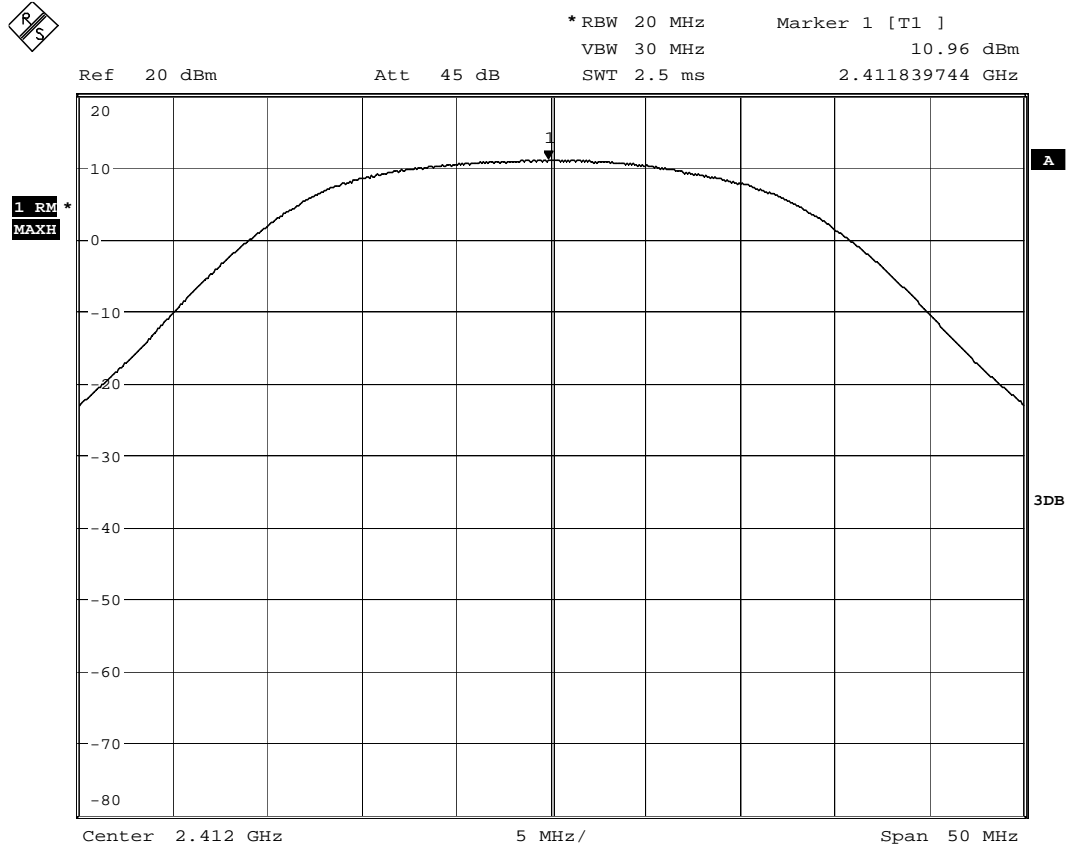

Date: 7.DEC.2011 09:53:33

Op. Mode

op-mode 1g



*RBW 20 MHz Marker 1 [T1]
VBW 30 MHz 11.35 dBm
SWT 2.5 ms 2.410717949 GHz

Ref 20 dBm

Att 45 dB

1 RM
MAXH

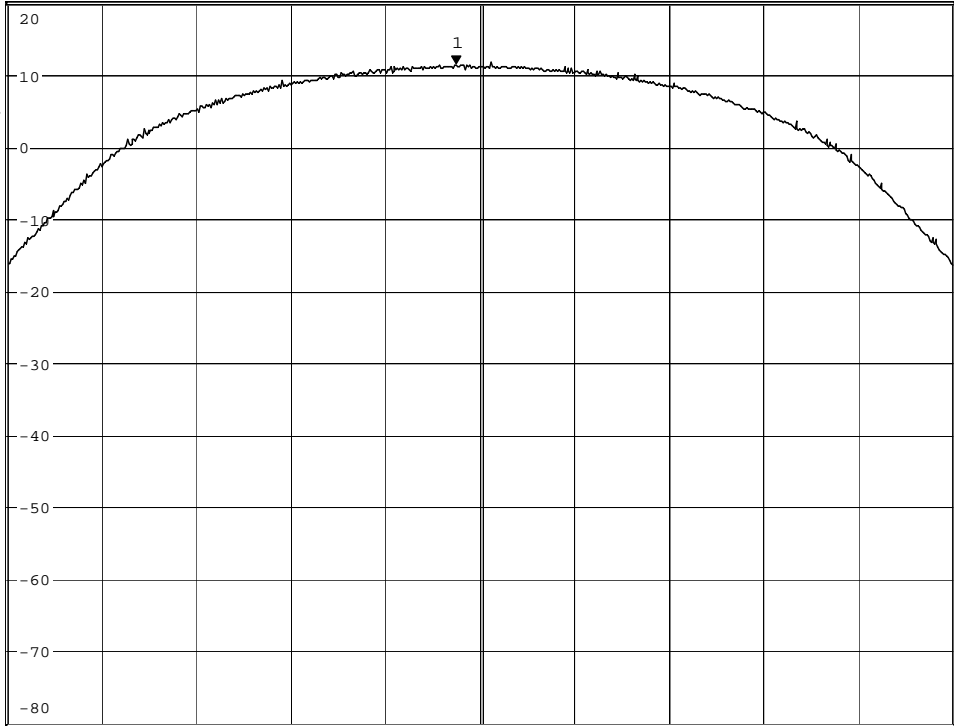

Center 2.412 GHz

5 MHz/

Span 50 MHz

Date: 7.DEC.2011 09:55:51

Op. Mode

op-mode 1n



*RBW 20 MHz Marker 1 [T1]
VBW 30 MHz 11.31 dBm
SWT 2.5 ms 2.408875000 GHz

Ref 20 dBm

Att 45 dB

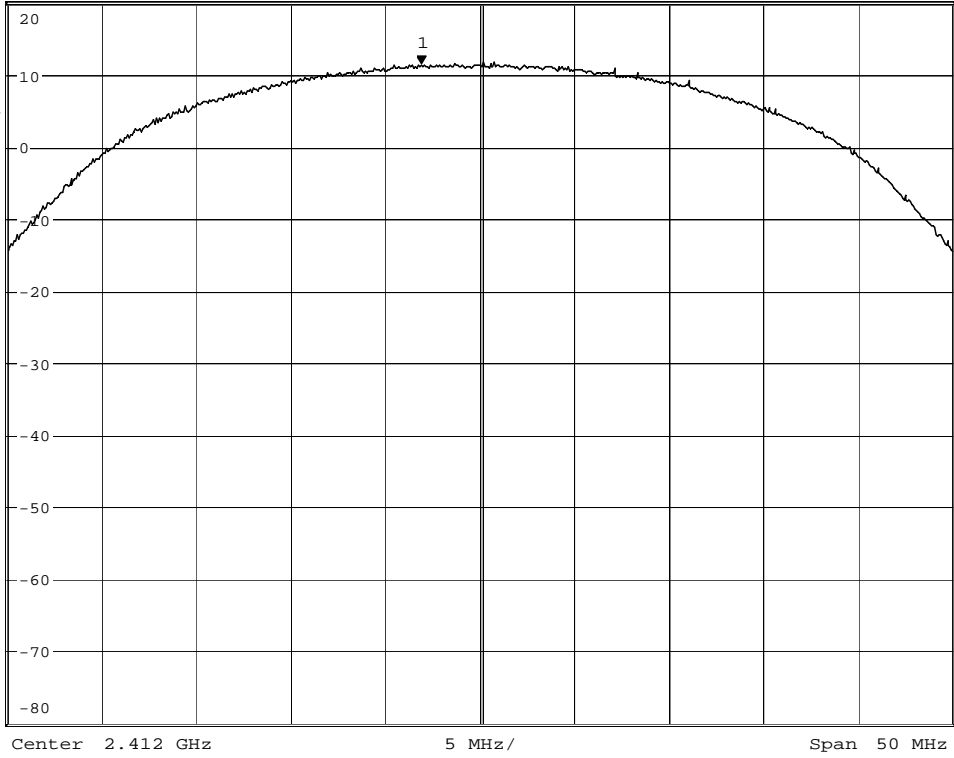

Date: 7.DEC.2011 09:50:50

8.3.2 Peak power output operating mode 2

Op. Mode

op-mode 2b

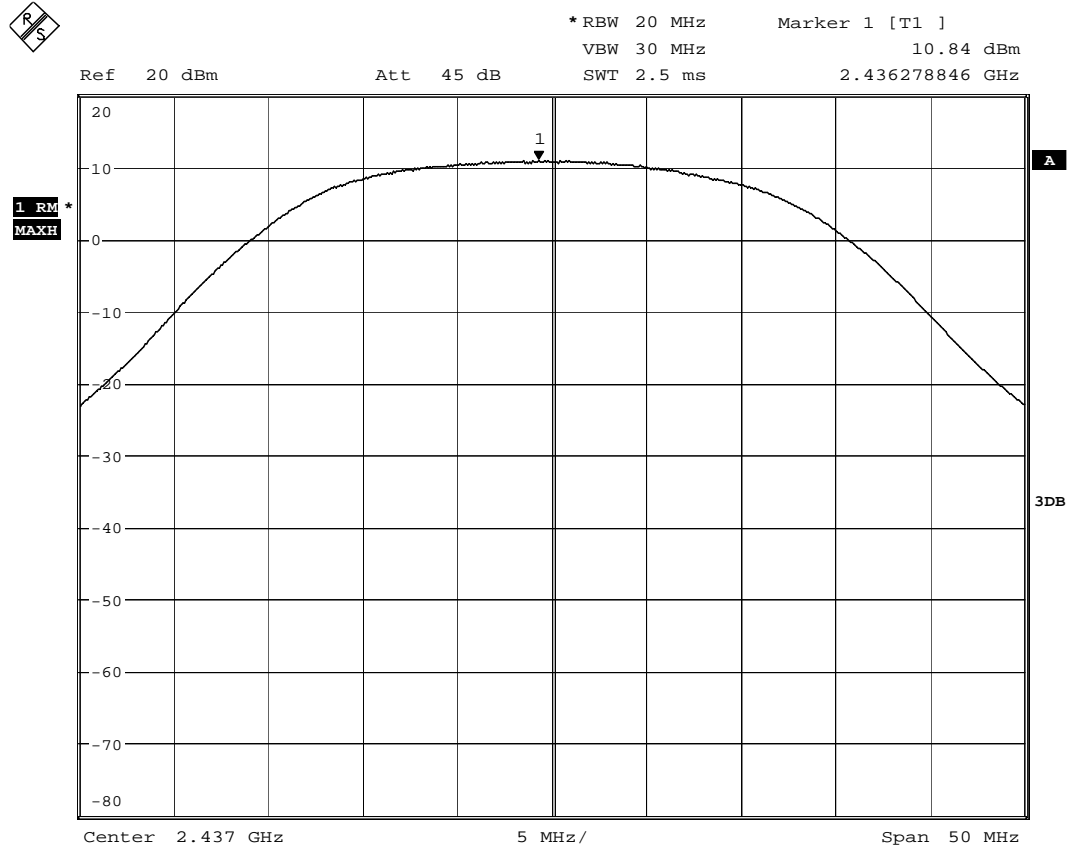

Date: 7.DEC.2011 09:54:19

Op. Mode

op-mode 2g



*RBW 20 MHz Marker 1 [T1]
VBW 30 MHz 11.48 dBm
SWT 2.5 ms 2.435637821 GHz

Ref 20 dBm

Att 45 dB

1 RM*
MAXH

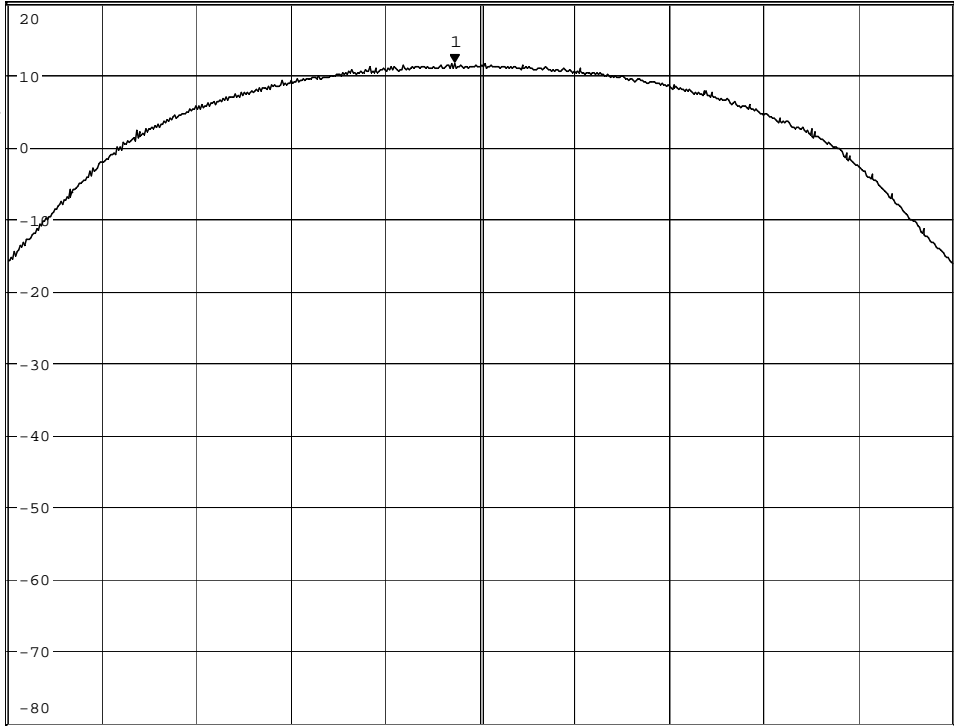

Center 2.437 GHz

5 MHz/

Span 50 MHz

Date: 7.DEC.2011 09:56:32

Op. Mode

op-mode 2n

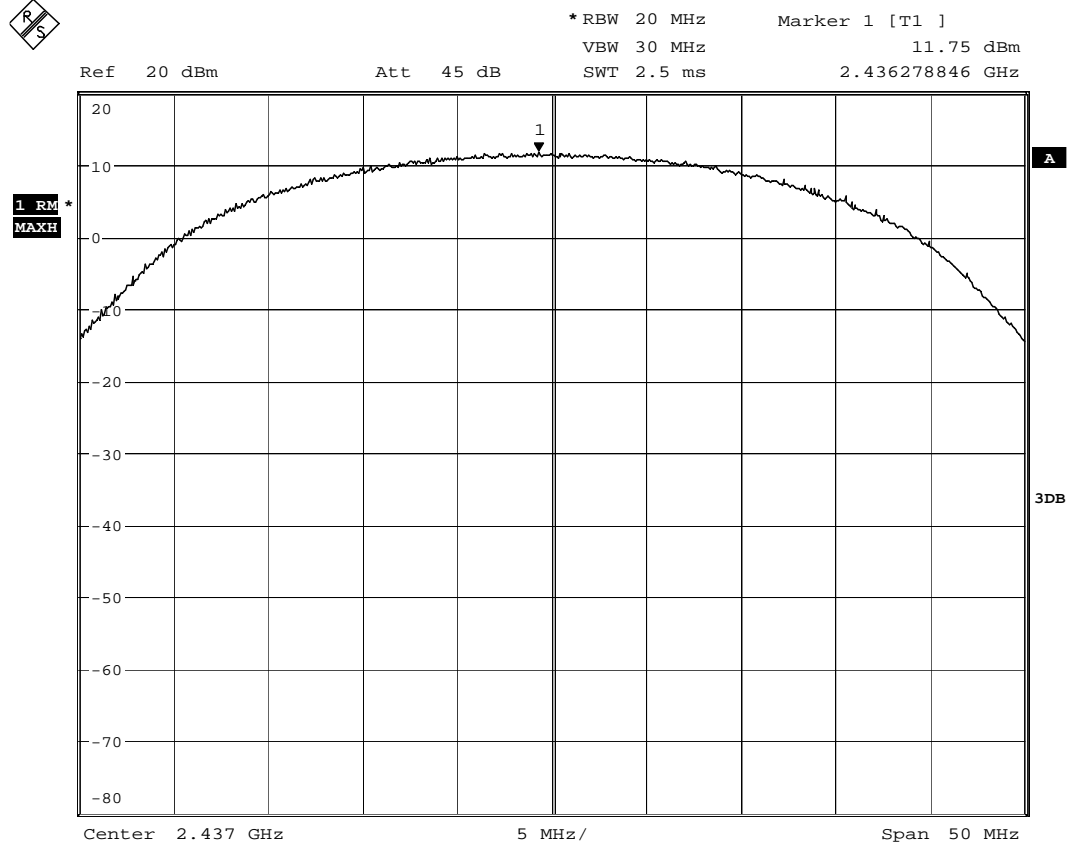

Date: 7.DEC.2011 09:51:21



8.3.3 Peak power output operating mode 3

Op. Mode

op-mode 3b

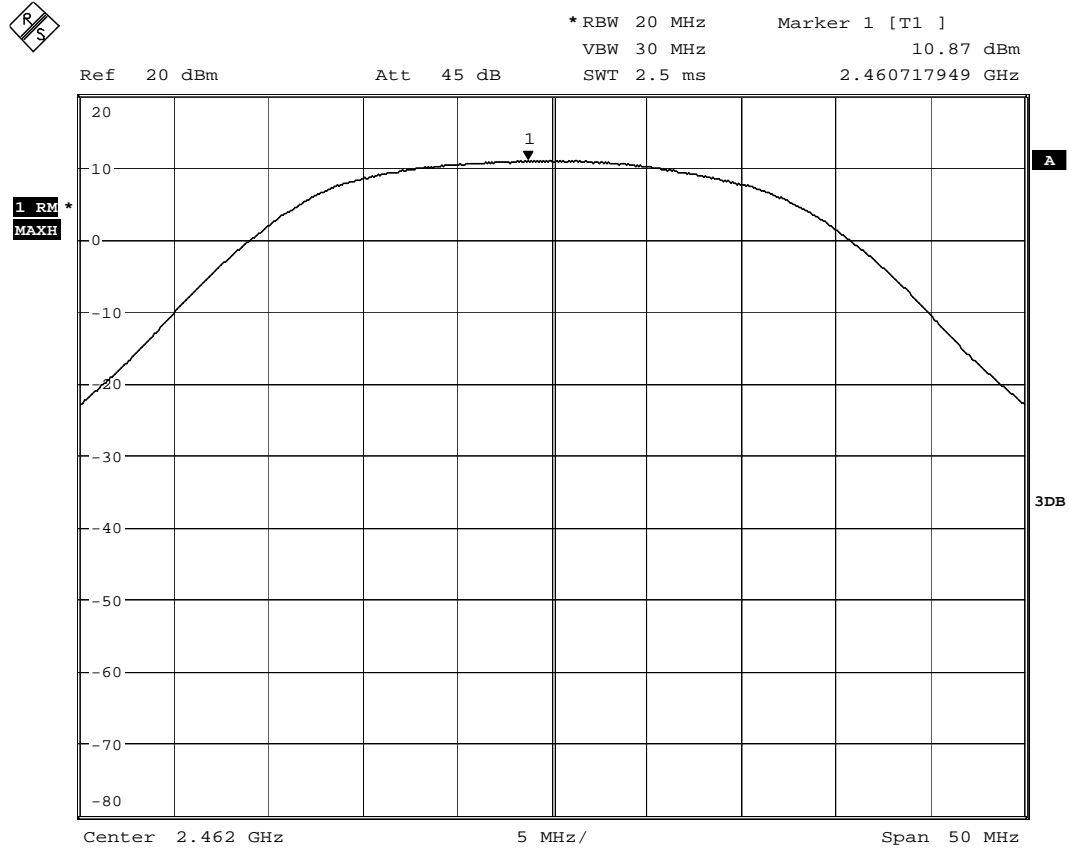

Date: 7.DEC.2011 09:55:02

Op. Mode

op-mode 3g



*RBW 20 MHz Marker 1 [T1]
 VBW 30 MHz 11.63 dBm
 SWT 2.5 ms 2.461679487 GHz

Ref 20 dBm

Att 45 dB

1 RM*
MAXH

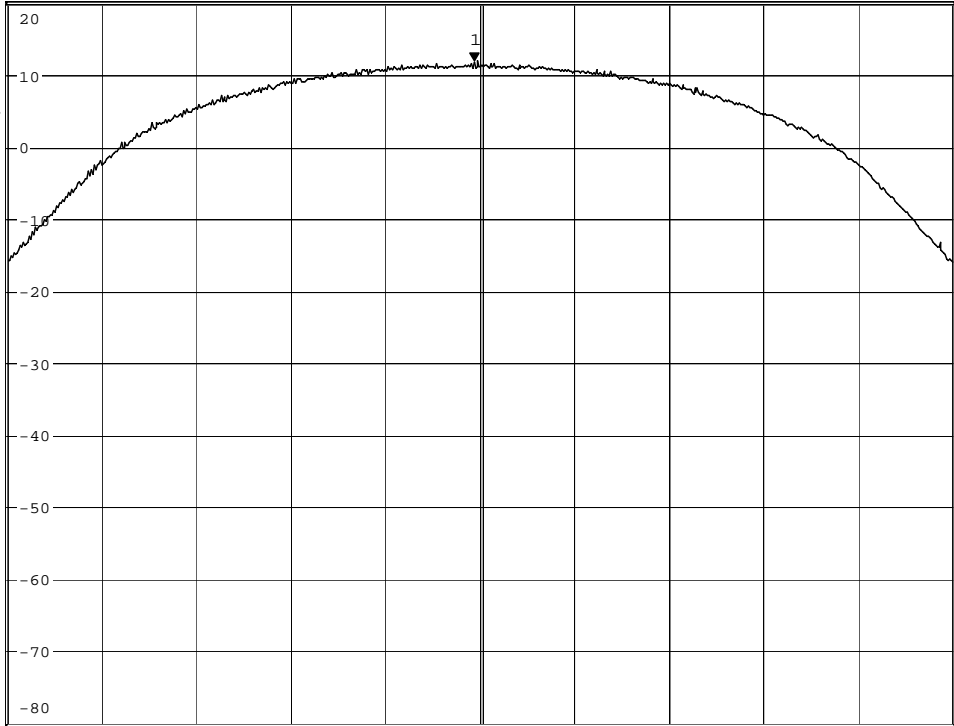

Center 2.462 GHz

5 MHz/

Span 50 MHz

Date: 7.DEC.2011 09:57:32

Op. Mode

op-mode 3n

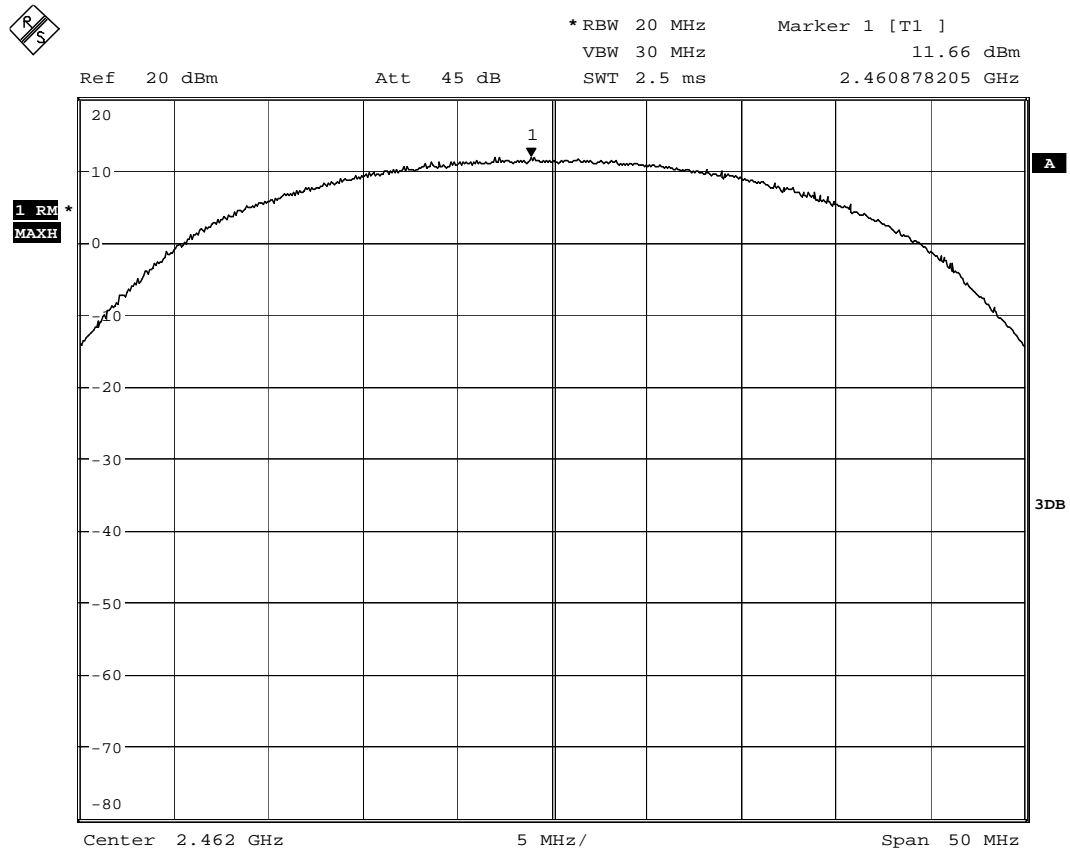

Date: 7.DEC.2011 09:52:06



8.4 Band edge compliance conducted and Spurious RF conducted emissions

8.4.1 Band edge compliance conducted operating mode 1b

Op. Mode

op-mode 1b

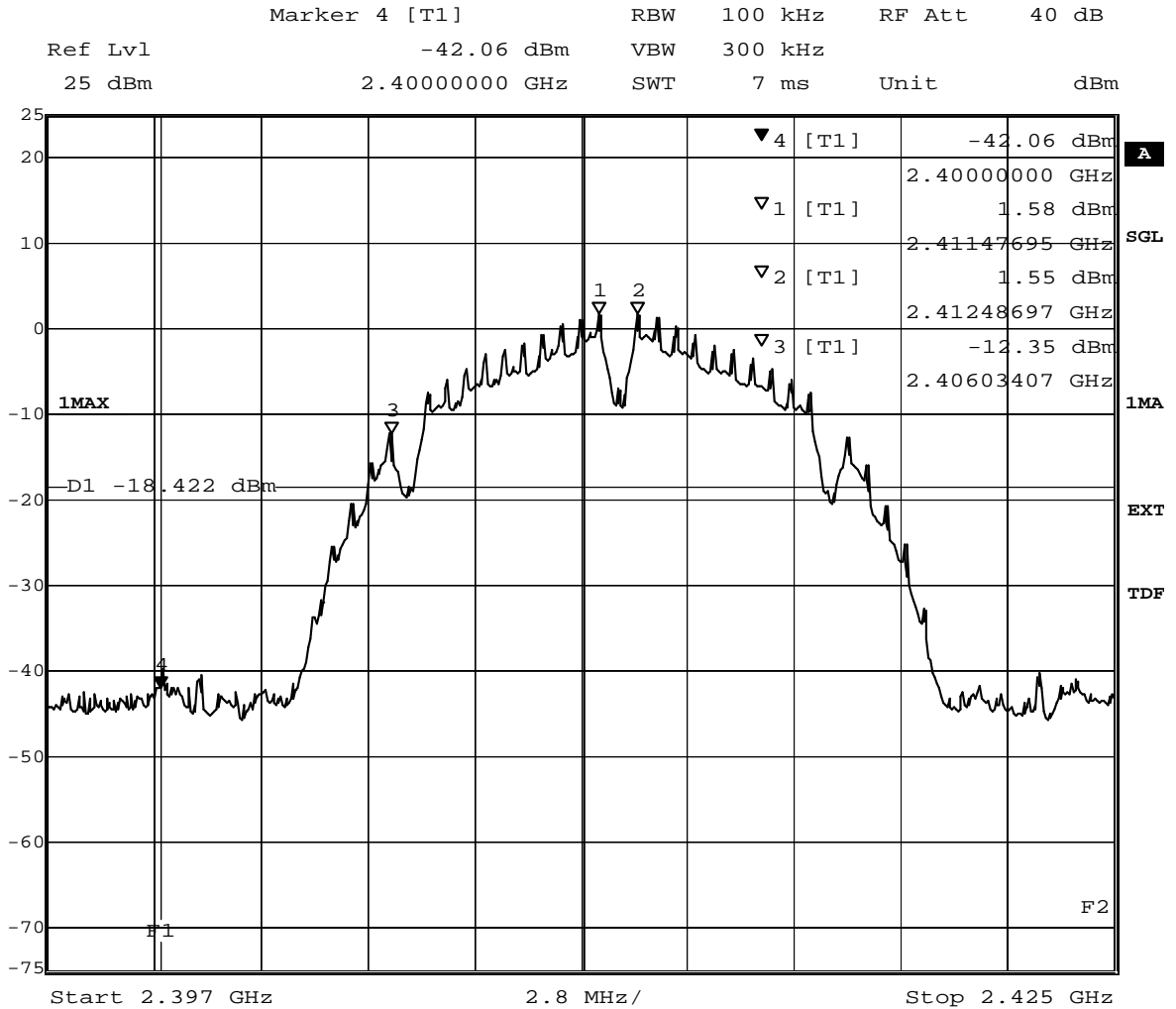

Title: Band Edge Compliance
 Comment A: CH B: 2412 MHz
 Date: 27.SEP.2011 14:35:51



8.4.2 Spurious RF conducted emission operating mode 1b

Op. Mode

op-mode 1b

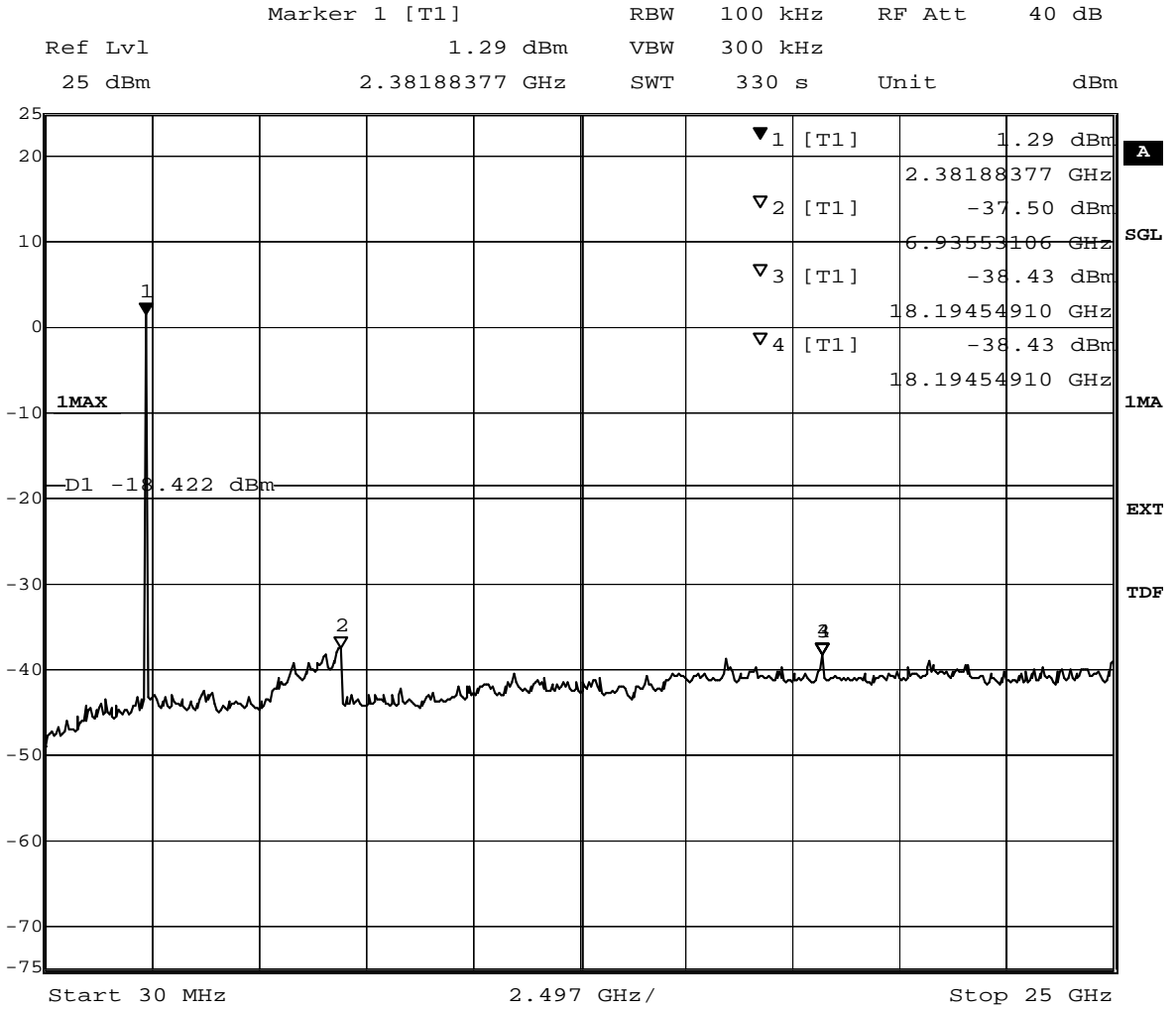

Title: spurious emissions
Comment A: CH B: 2412 MHz
Date: 27.SEP.2011 14:47:30



8.4.3 Band edge compliance conducted operating mode 1g

Op. Mode

op-mode 1g

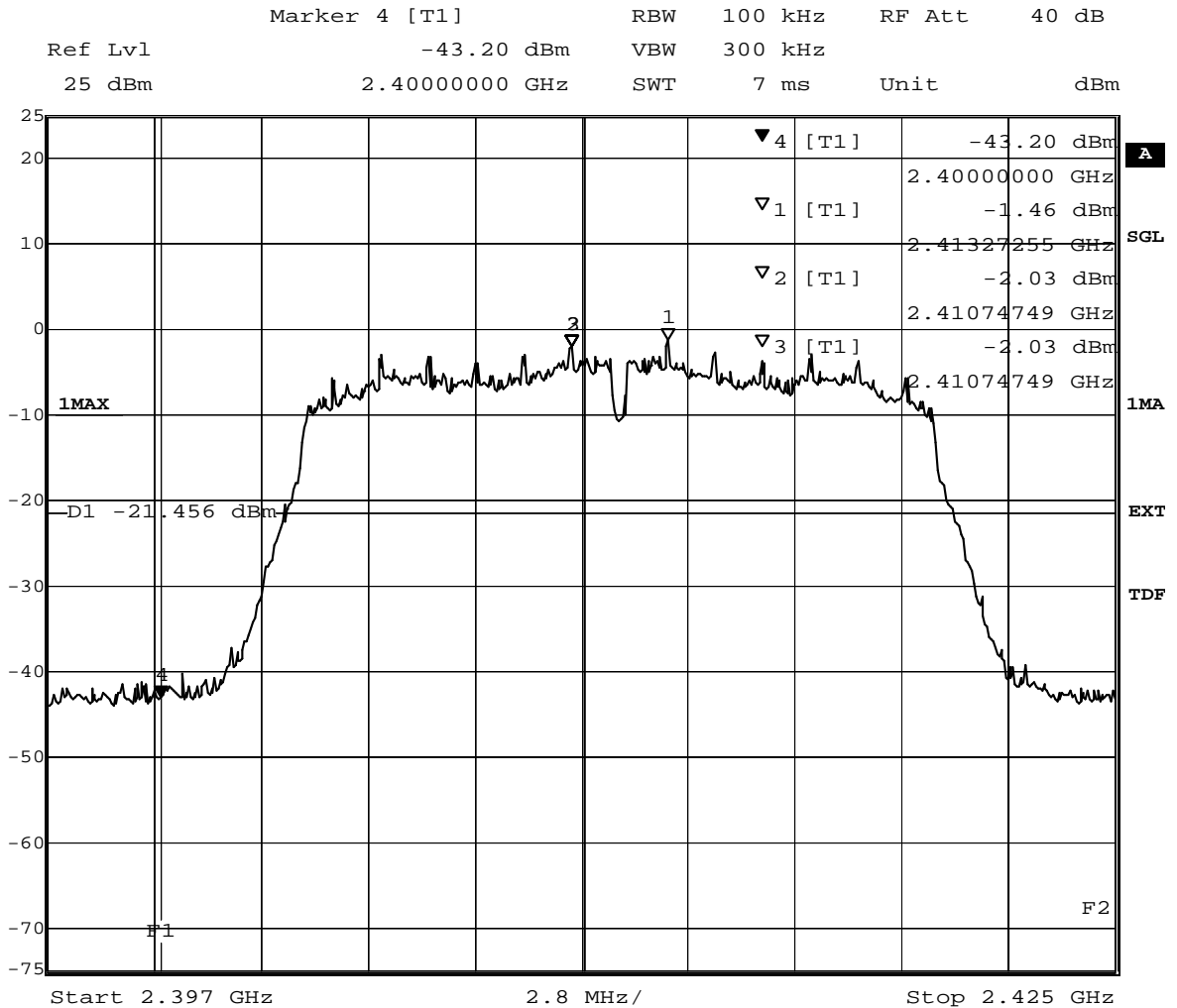

Title: Band Edge Compliance
 Comment A: CH B: 2412 MHz
 Date: 6.OCT.2011 11:41:39



8.4.4 Spurious RF conducted emission operating mode 1g

Op. Mode

op-mode 1g

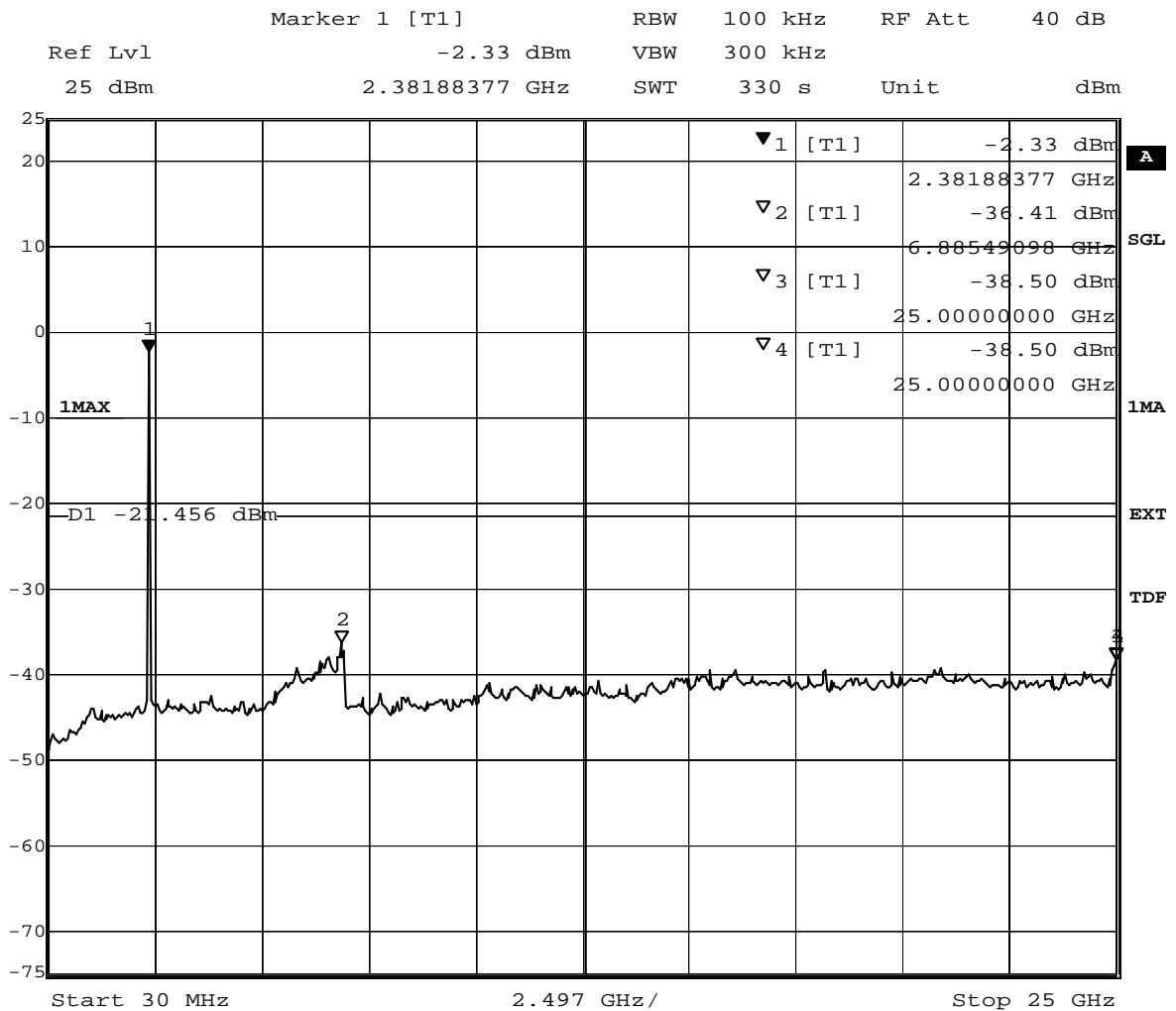

Title: spurious emissions
Comment A: CH B: 2412 MHz
Date: 6.OCT.2011 11:53:18



8.4.5 Band edge compliance conducted operating mode 1n

Op. Mode

op-mode 1n

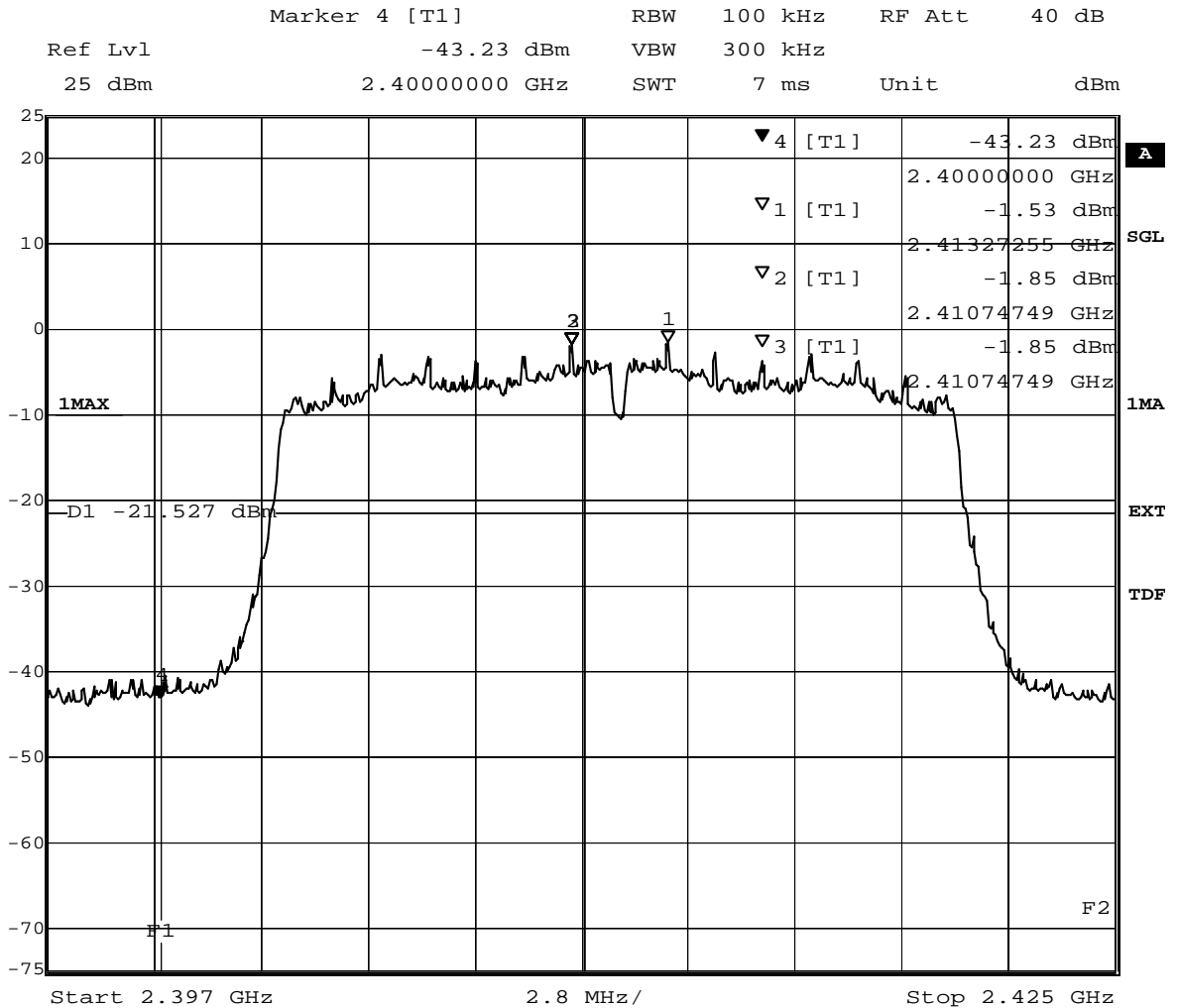

Title: Band Edge Compliance
 Comment A: CH B: 2412 MHz
 Date: 6.OCT.2011 16:04:09

8.4.7 Spurious RF conducted emissions operating mode 2b

Op. Mode

op-mode 2b

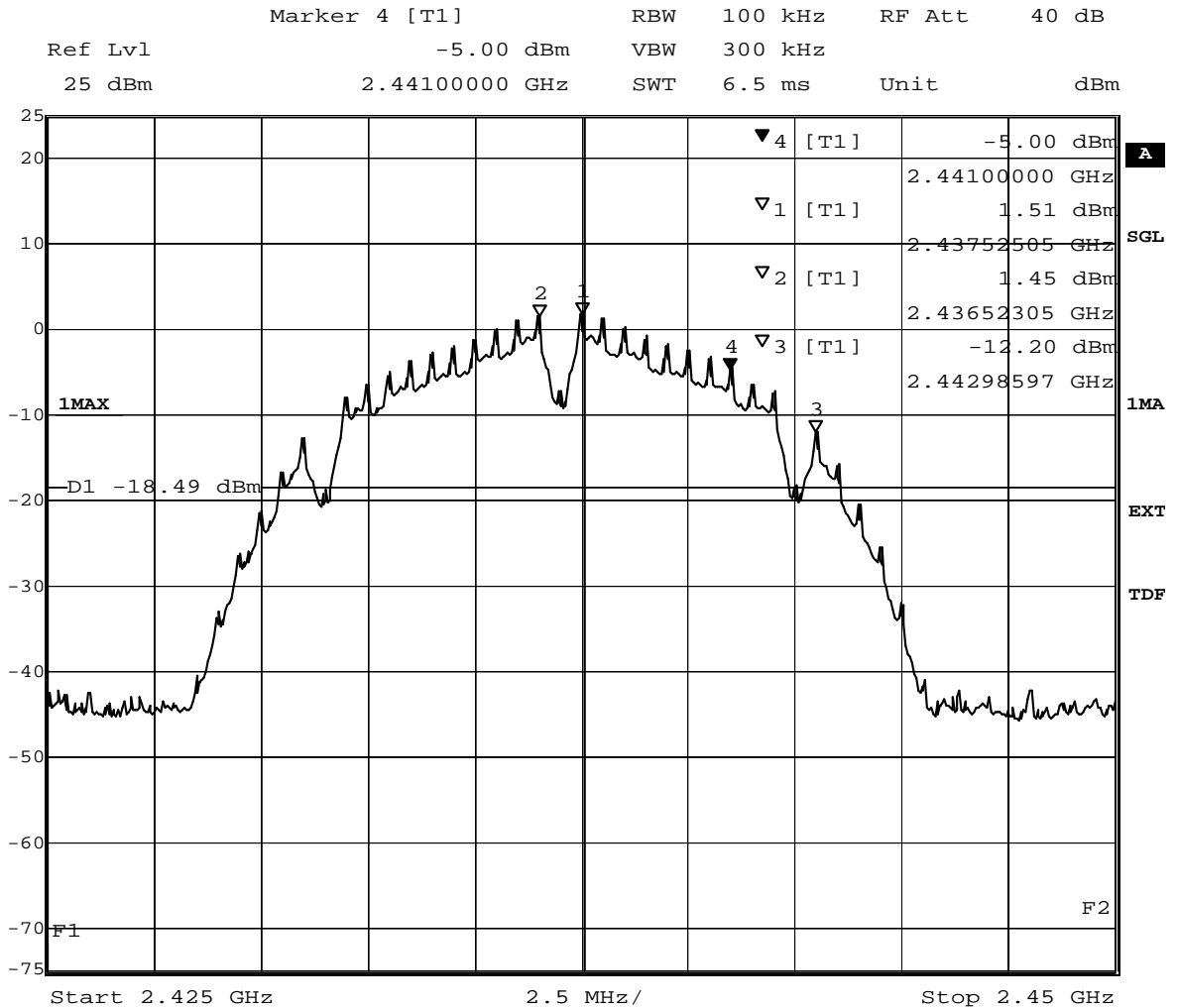

Title: Band Edge Compliance
 Comment A: CH M: 2437 MHz
 Date: 27.SEP.2011 15:22:09

(determination of reference value for spurious emissions measurement)

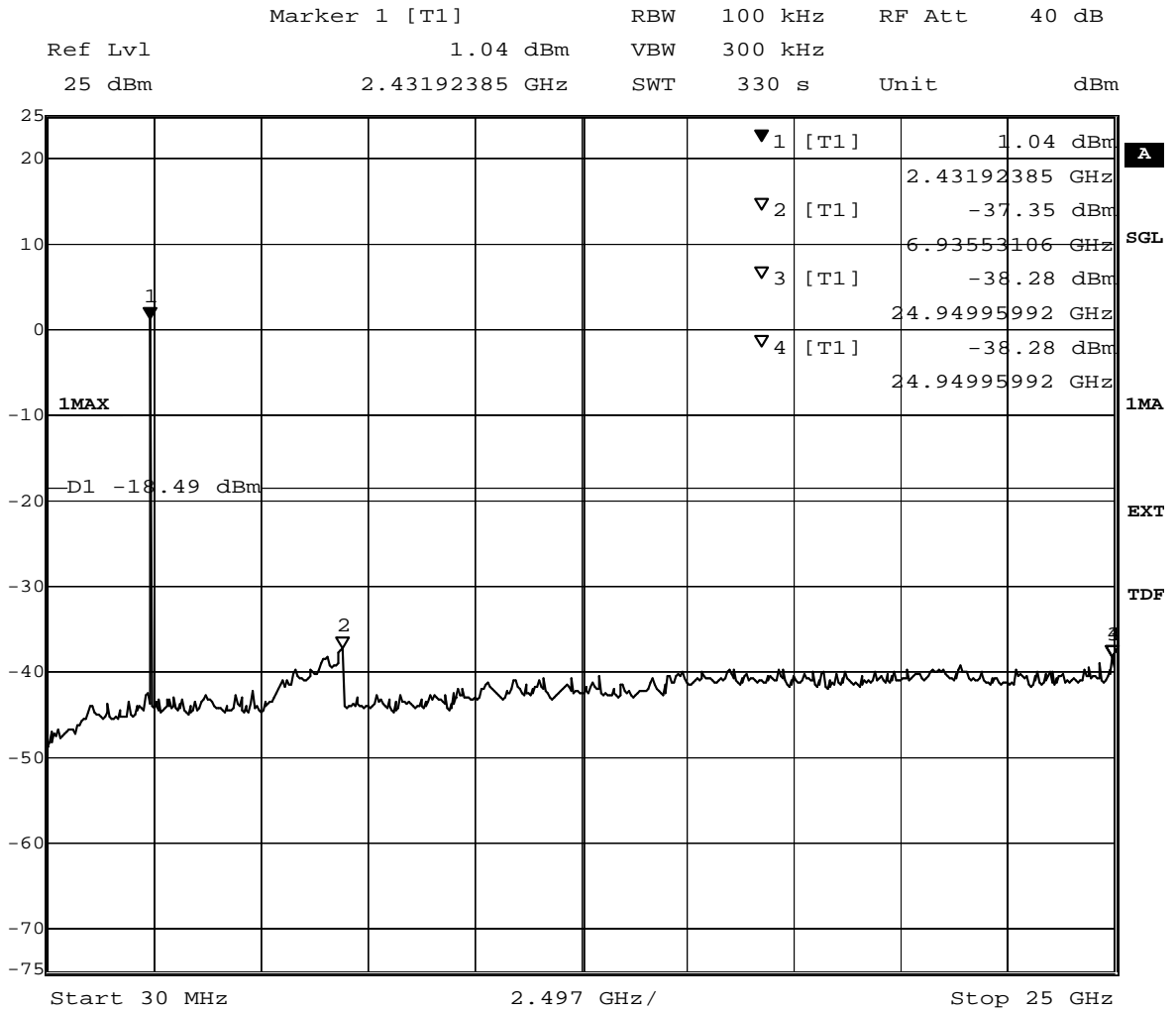

Title: spurious emissions
 Comment A: CH M: 2437 MHz
 Date: 27.SEP.2011 15:33:47

8.4.8 Spurious RF conducted emissions operating mode 2g

Op. Mode

op-mode 2g

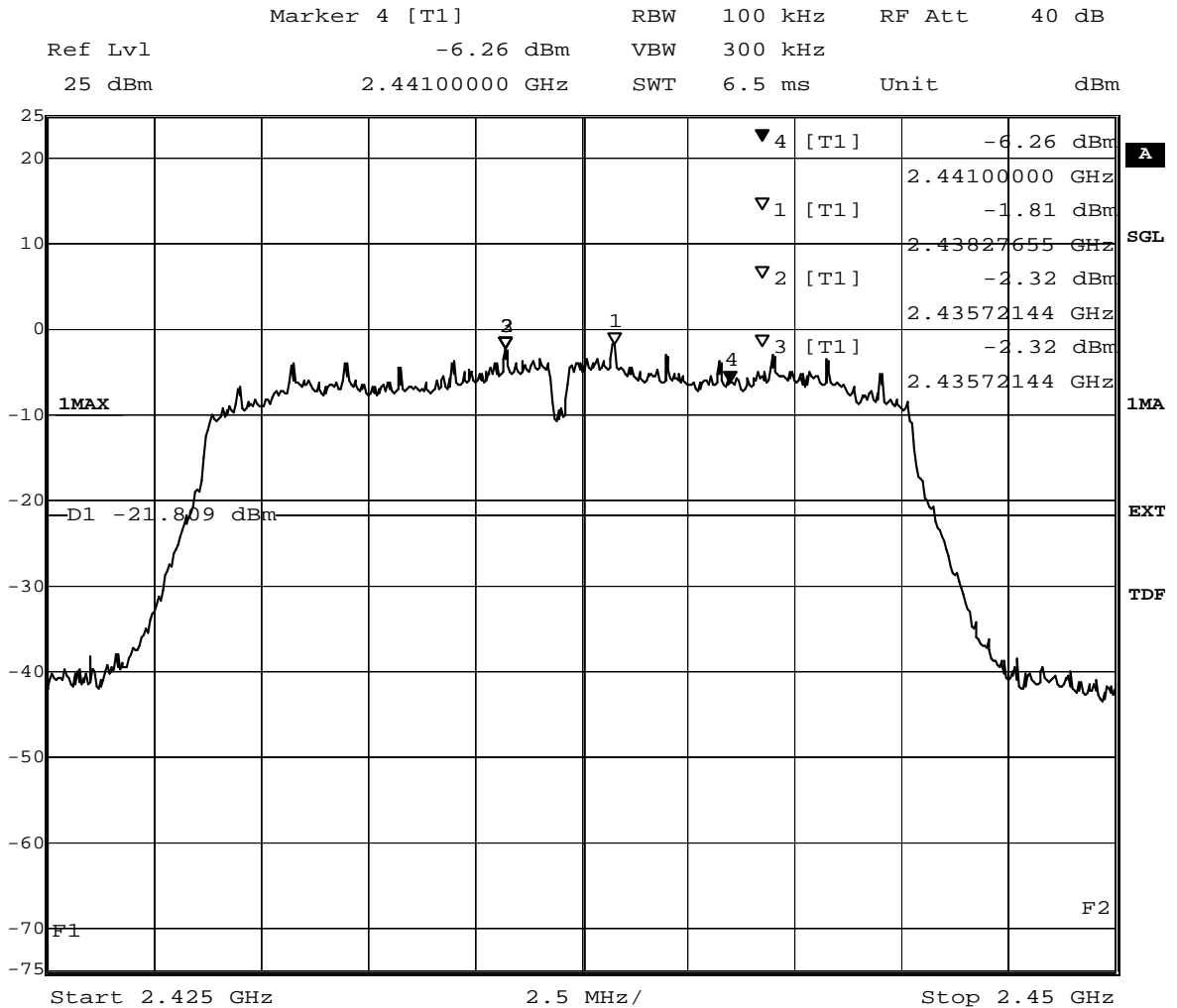

Title: Band Edge Compliance
 Comment A: CH M: 2437 MHz
 Date: 6.OCT.2011 12:53:56

(determination of reference value for spurious emissions measurement)

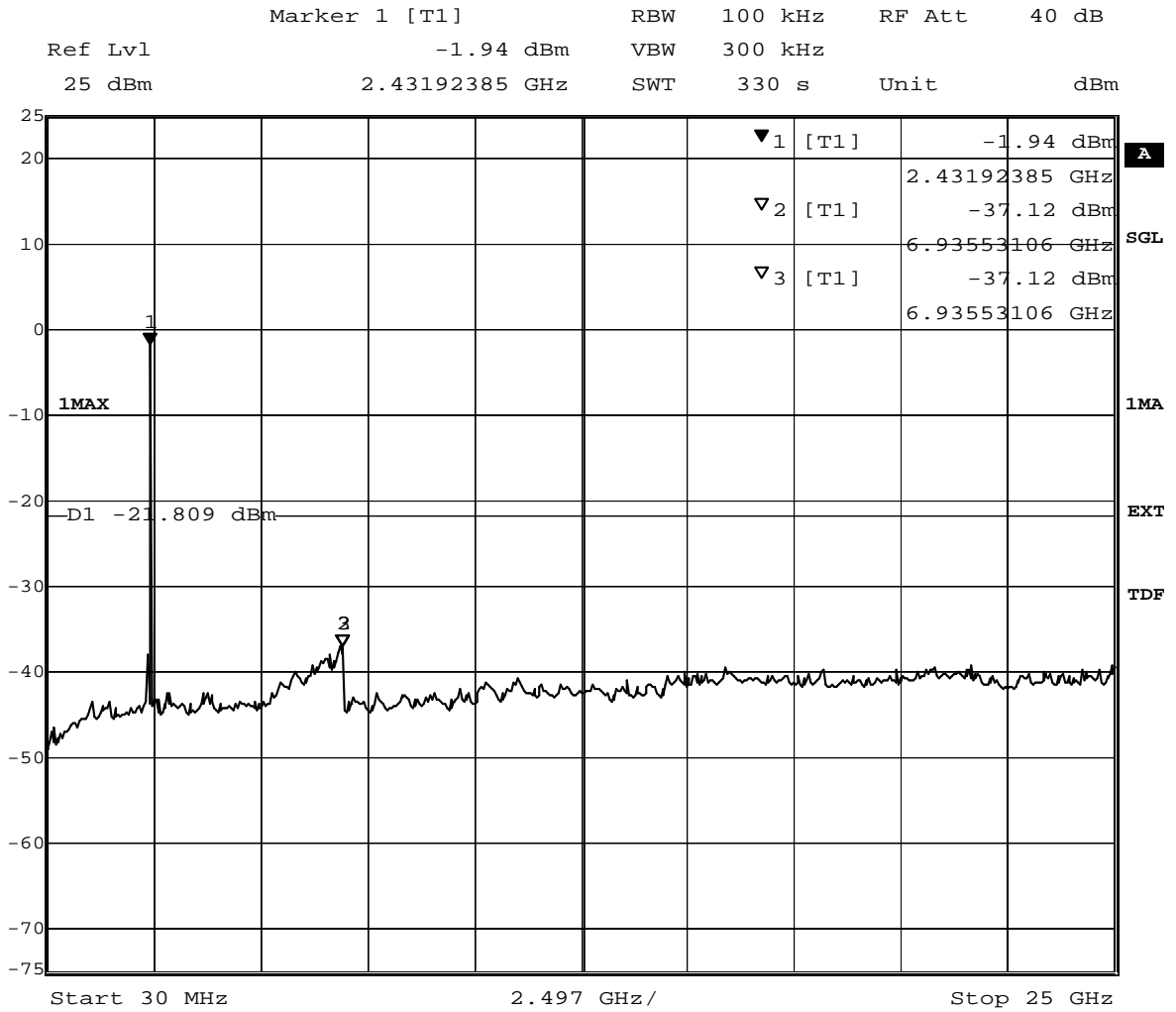

Title: spurious emissions
 Comment A: CH M: 2437 MHz
 Date: 6.OCT.2011 13:05:34

8.4.9 Spurious RF conducted emission operating mode 2n

Op. Mode

op-mode 2n

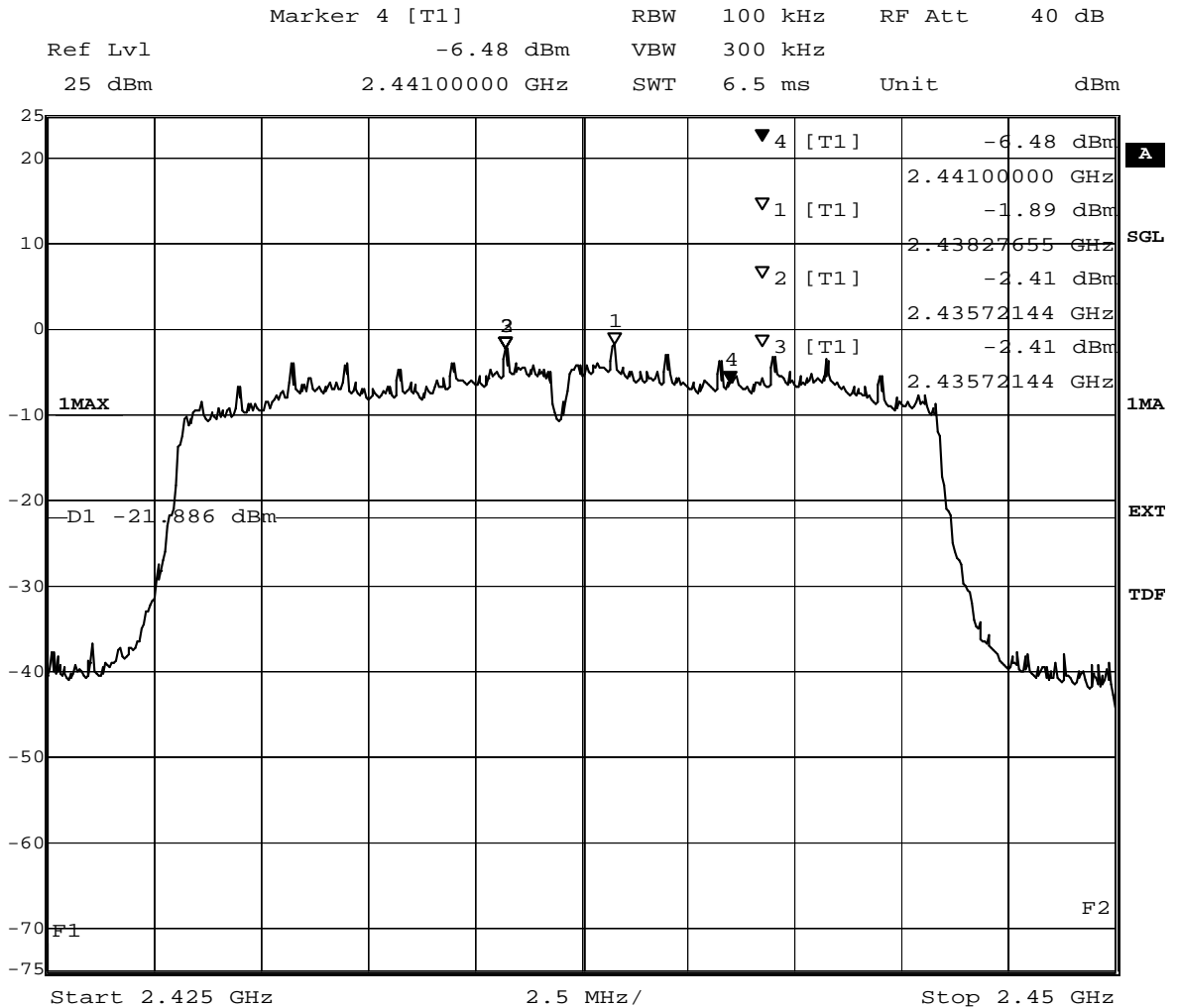

Title: Band Edge Compliance
 Comment A: CH M: 2437 MHz
 Date: 6.OCT.2011 15:05:09

(determination of reference value for spurious emissions measurement)

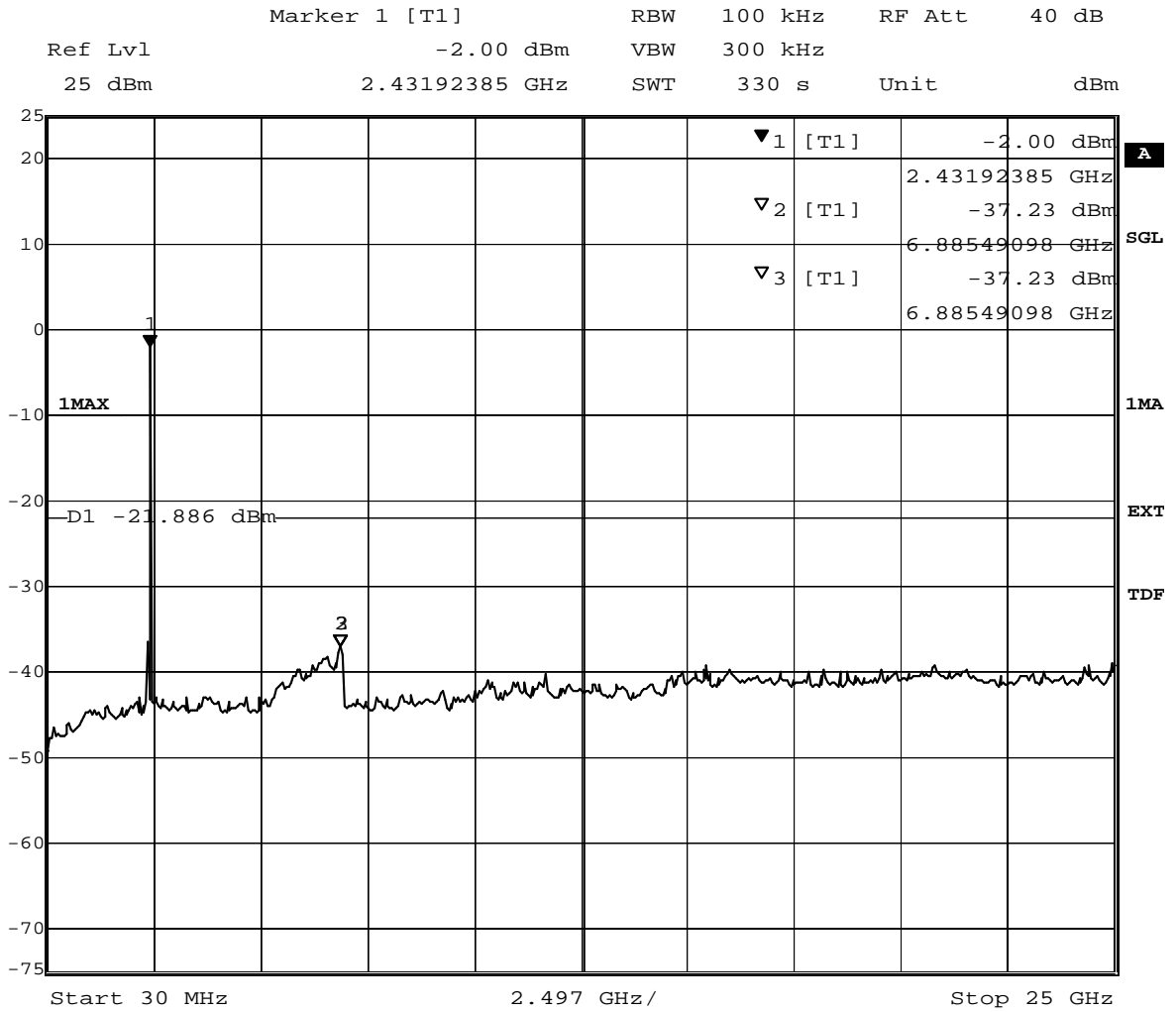

Title: spurious emissions
 Comment A: CH M: 2437 MHz
 Date: 6.OCT.2011 15:16:48

8.4.10 Band edge compliance conducted operating mode 3b

Op. Mode

op-mode 3b

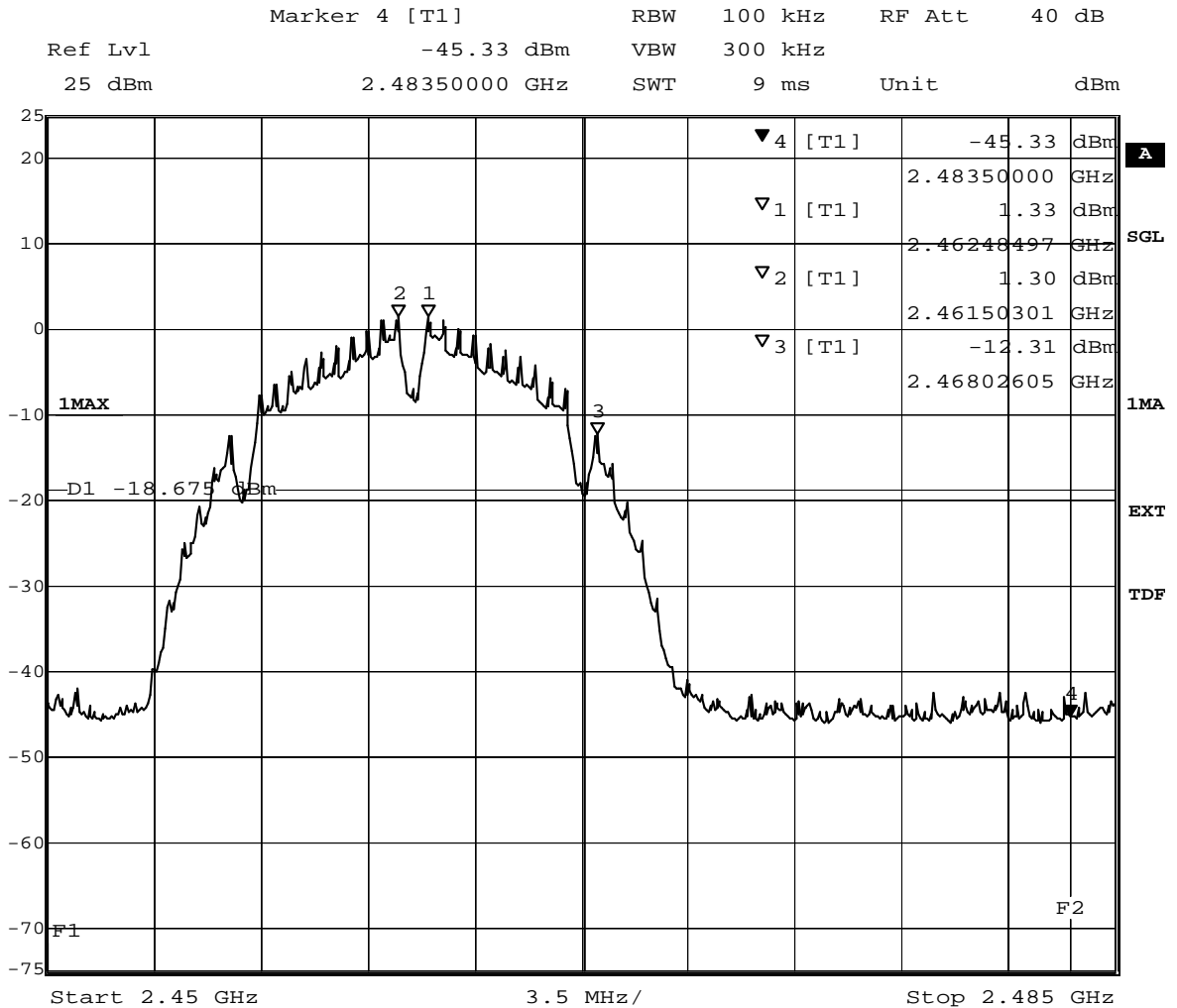

Title: Band Edge Compliance
 Comment A: CH T: 2462 MHz
 Date: 27.SEP.2011 15:58:22



8.4.12 Band edge compliance conducted operating mode 3g

Op. Mode

op-mode 3g

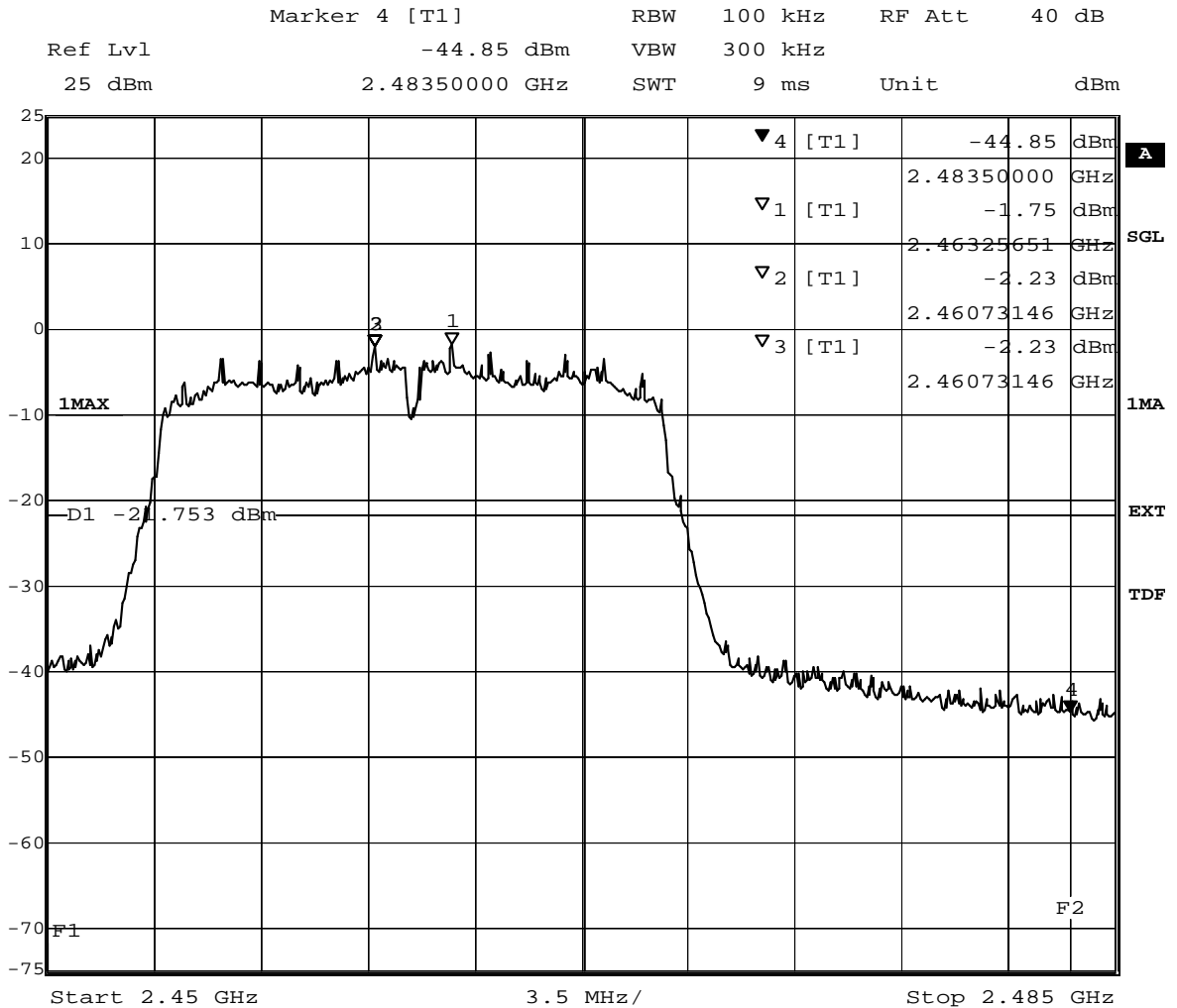

Title: Band Edge Compliance
 Comment A: CH T: 2462 MHz
 Date: 6.OCT.2011 13:58:10



8.4.14 Band edge compliance conducted operating mode 3n

Op. Mode

op-mode 3n

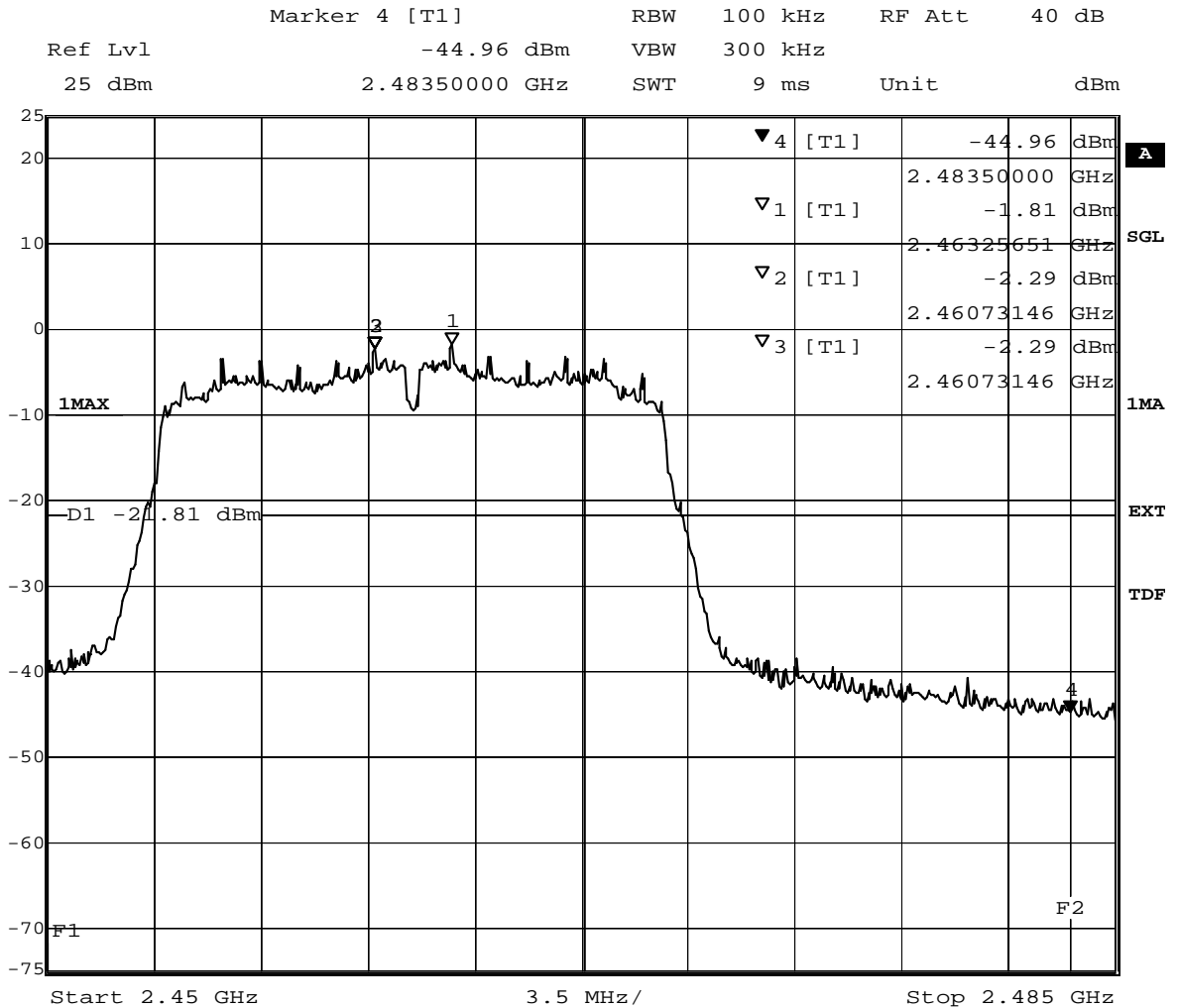

Title: Band Edge Compliance
 Comment A: CH T: 2462 MHz
 Date: 6.OCT.2011 14:32:39

8.4.16 Band edge compliance radiated operating mode 3

Op. Mode higher band edge

op-mode 3b

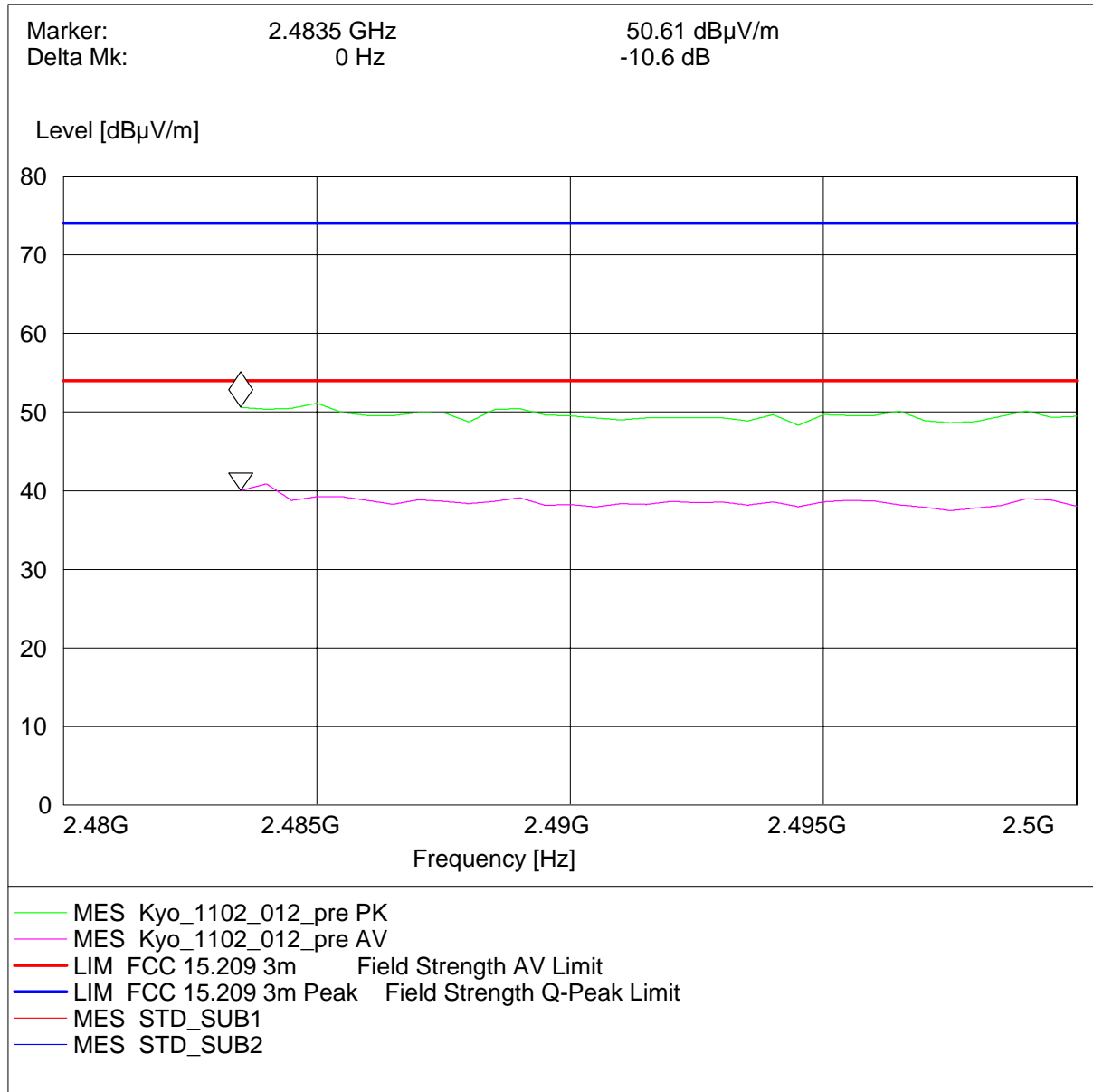

Radiated measurement (higher band edge)

Op. Mode **higher band edge**

op-mode 3g

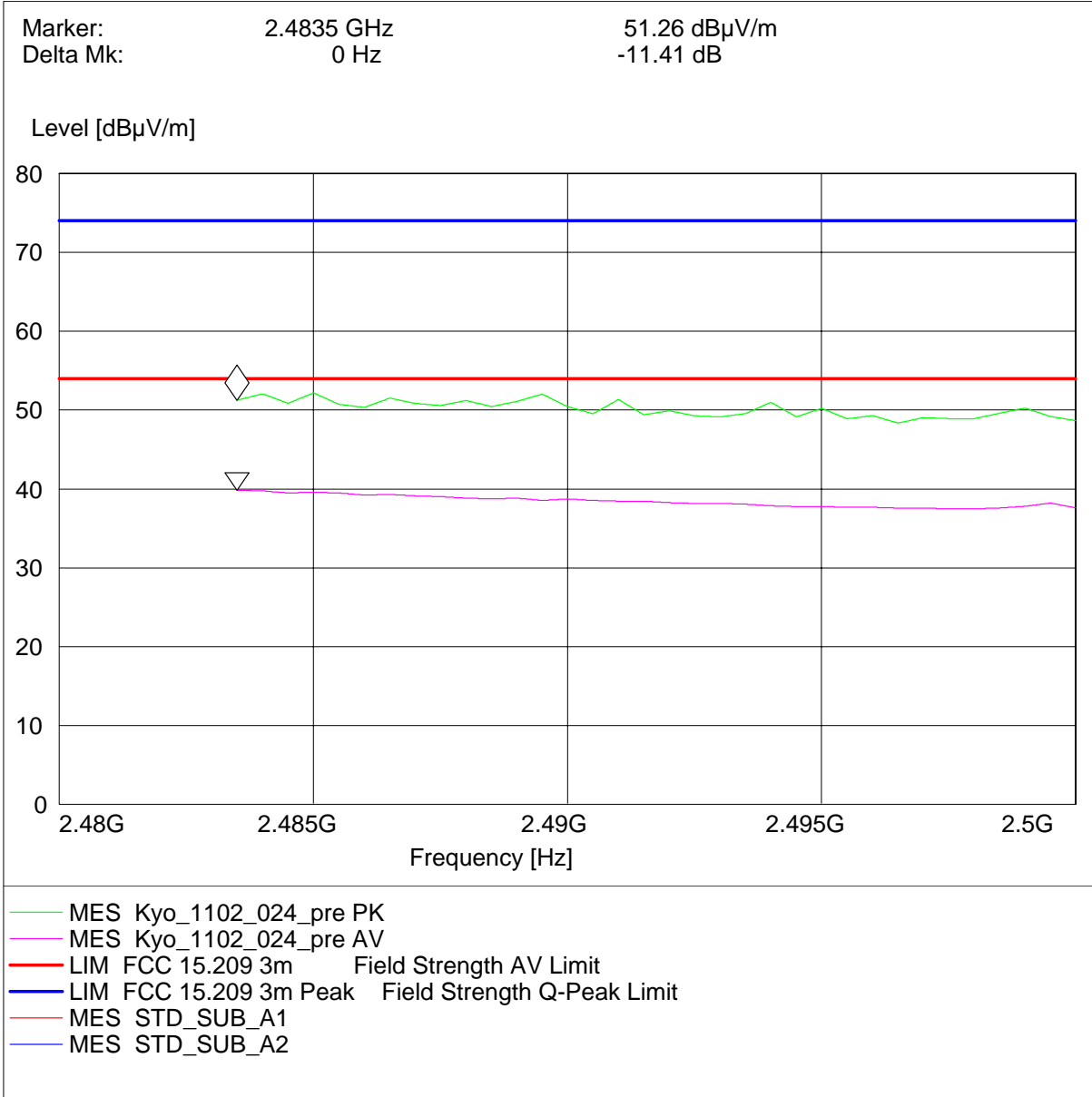

Radiated measurement (higher band edge)

Op. Mode **higher band edge**

op-mode 3n

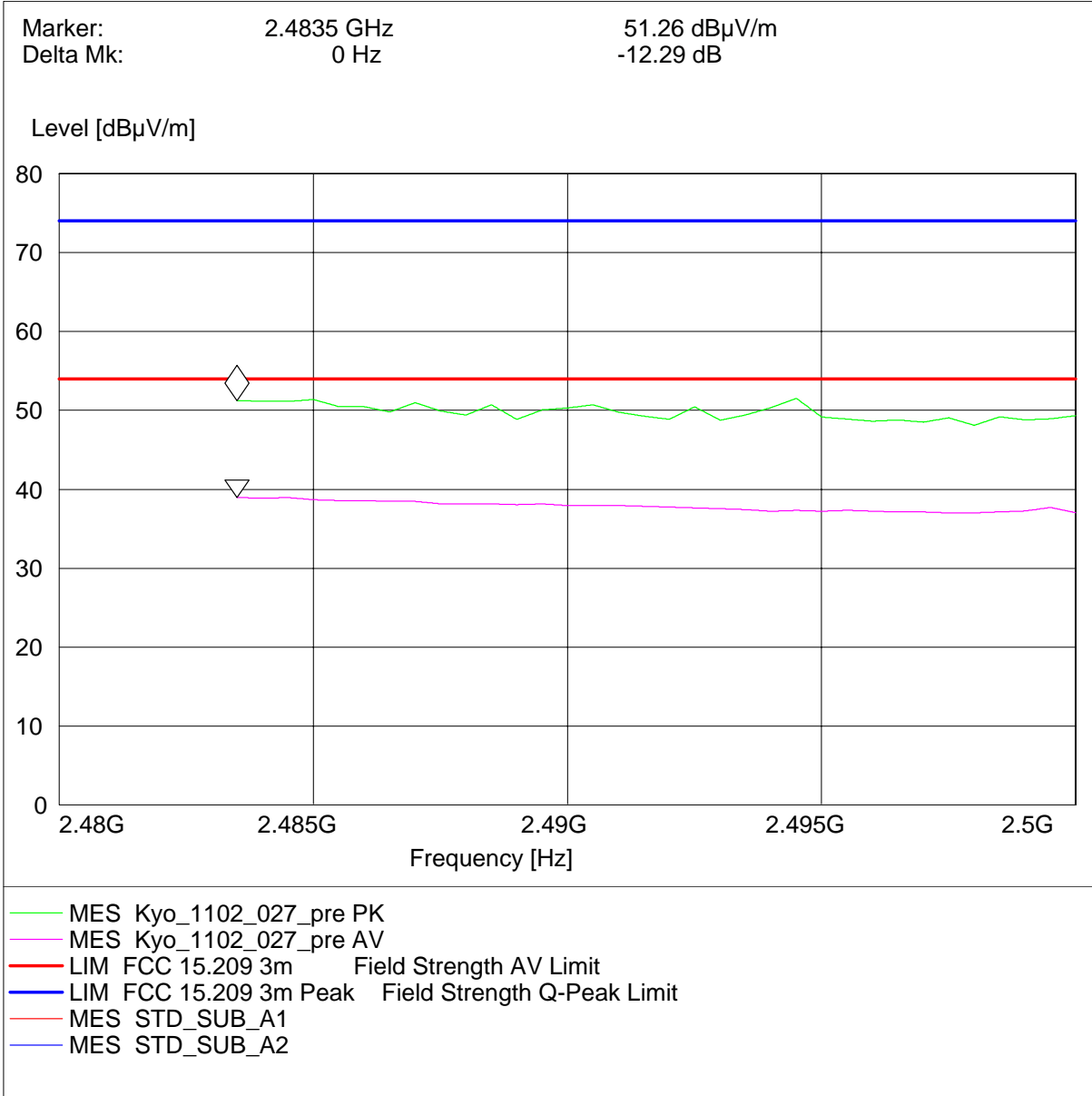

Radiated measurement (higher band edge)



8.5 Power density

Op. Mode

op-mode 1b

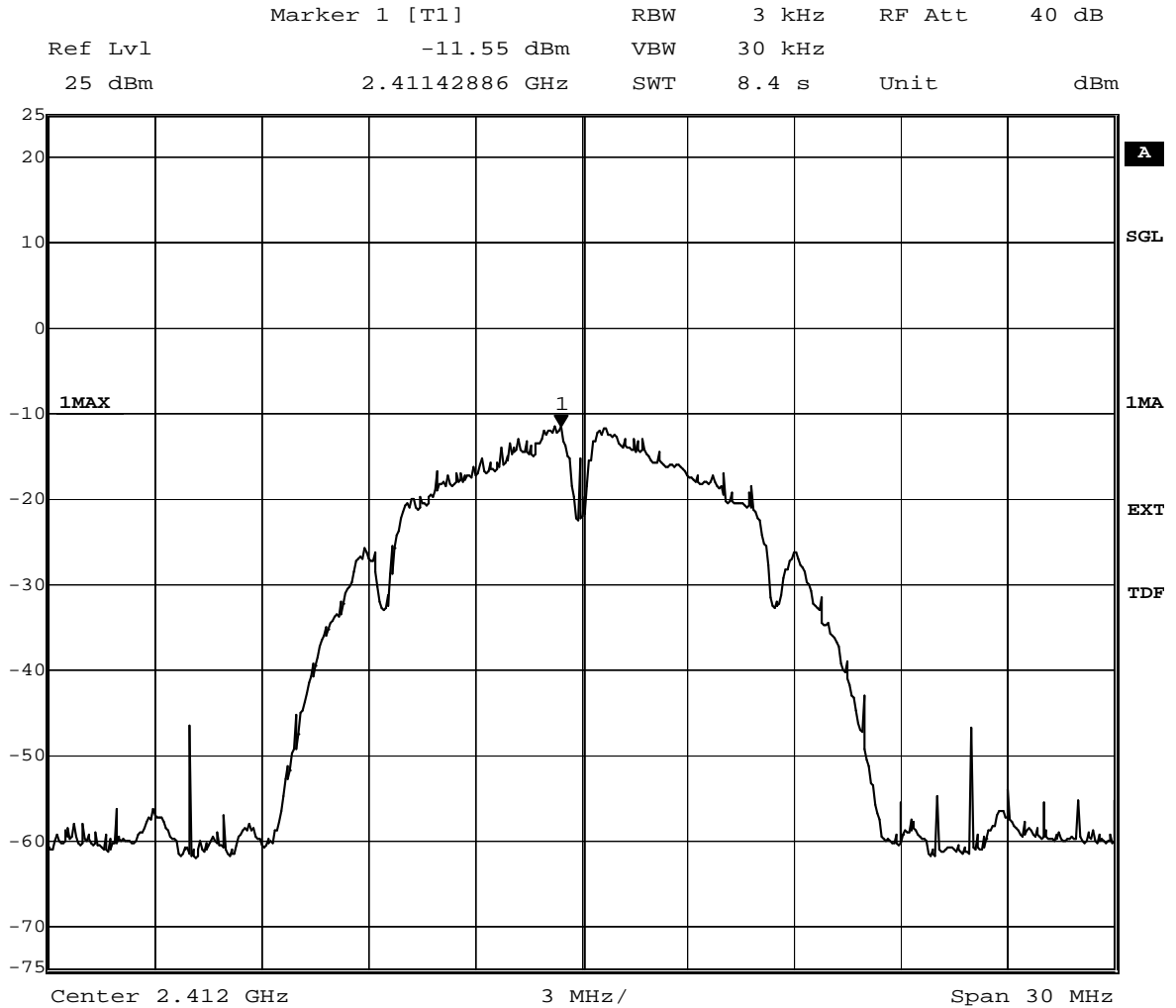

Title: Power Density
Comment A: CH B: 2412 MHz;
Date: 27.SEP.2011 15:04:57



Op. Mode

op-mode 1g

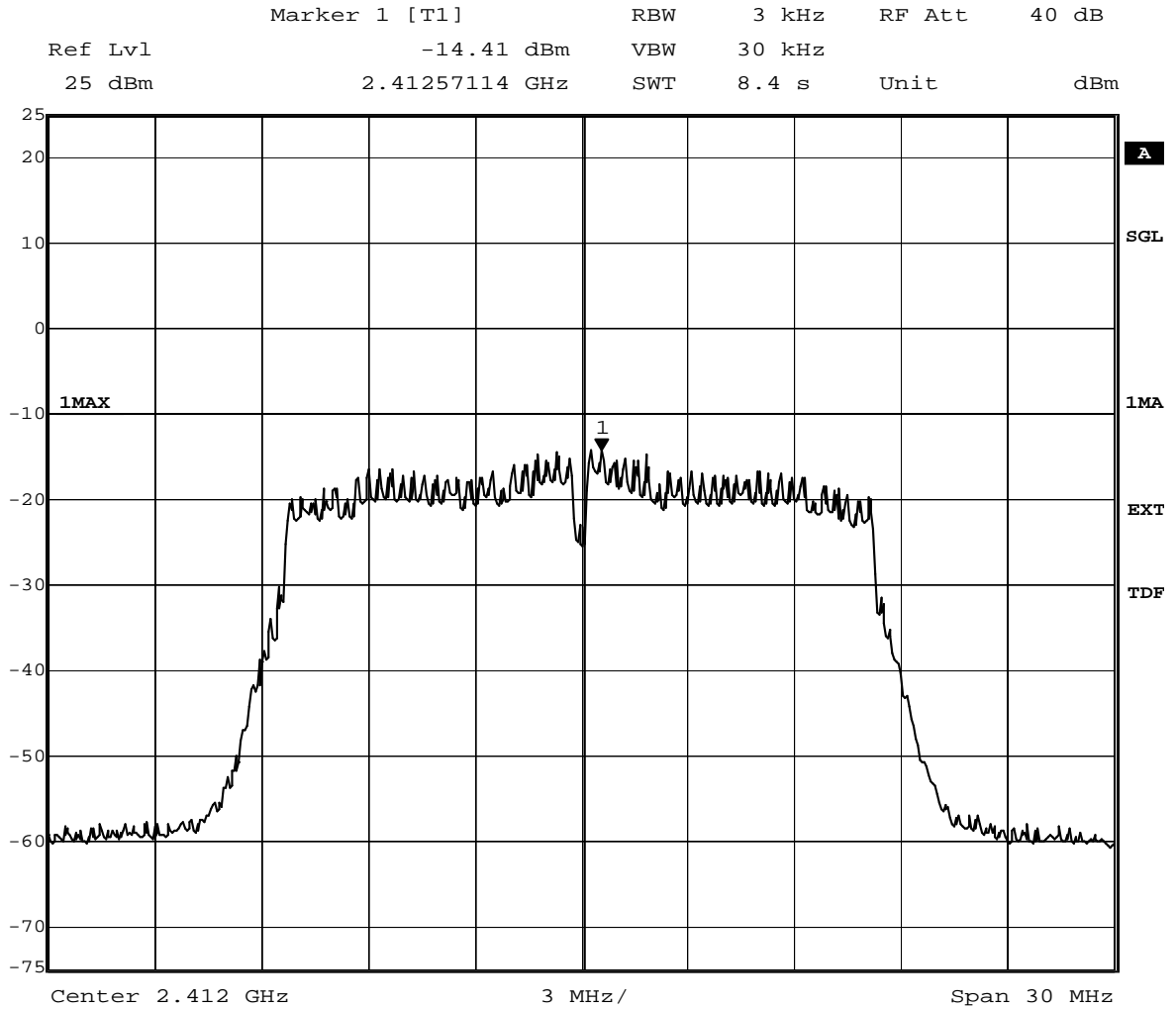

Title: Power Density
Comment A: CH B: 2412 MHz;
Date: 6.OCT.2011 12:10:01



Op. Mode

op-mode 1n

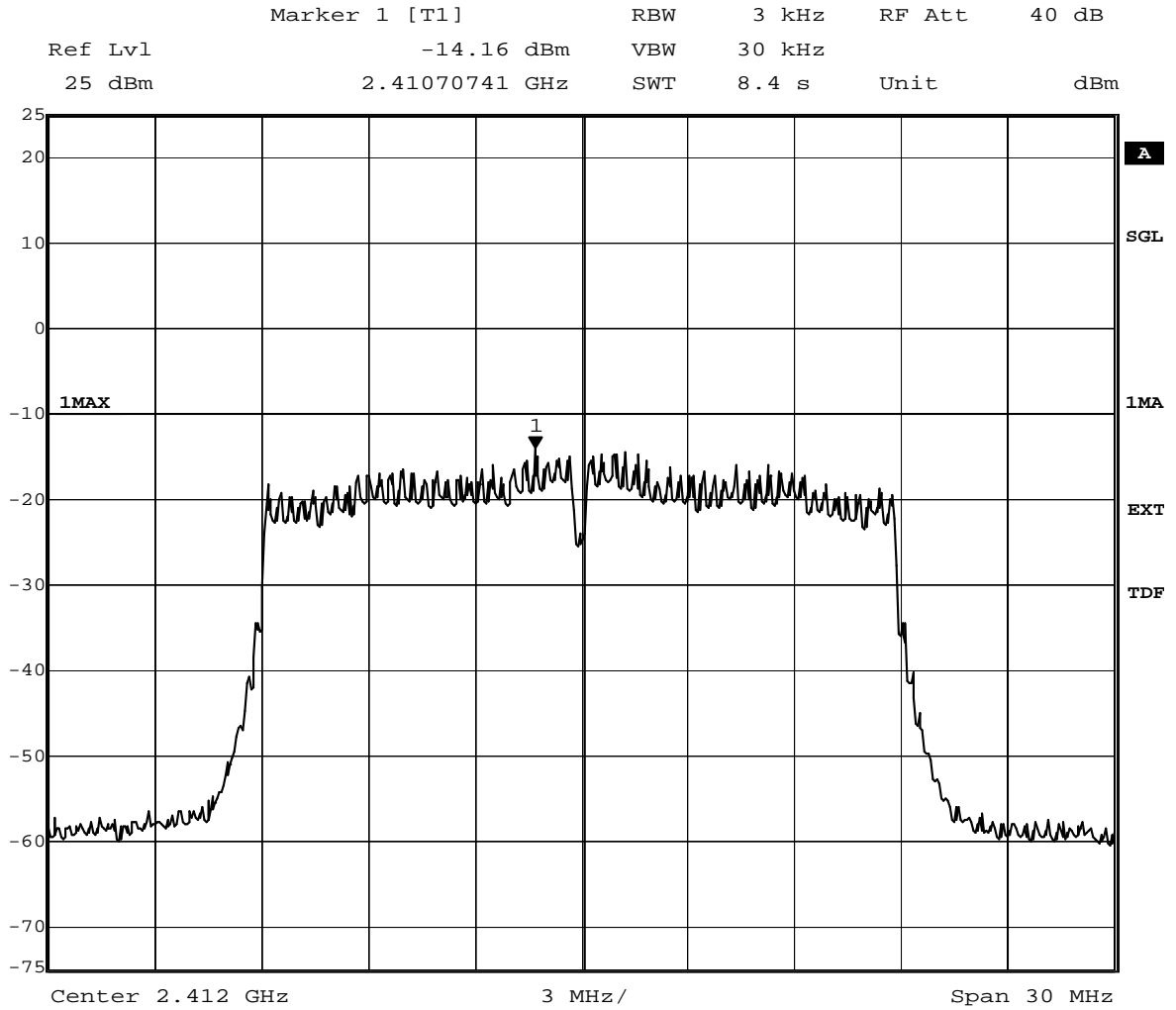

Title: Power Density
Comment A: CH B: 2412 MHz;
Date: 6.OCT.2011 16:32:33



Op. Mode

op-mode 2b

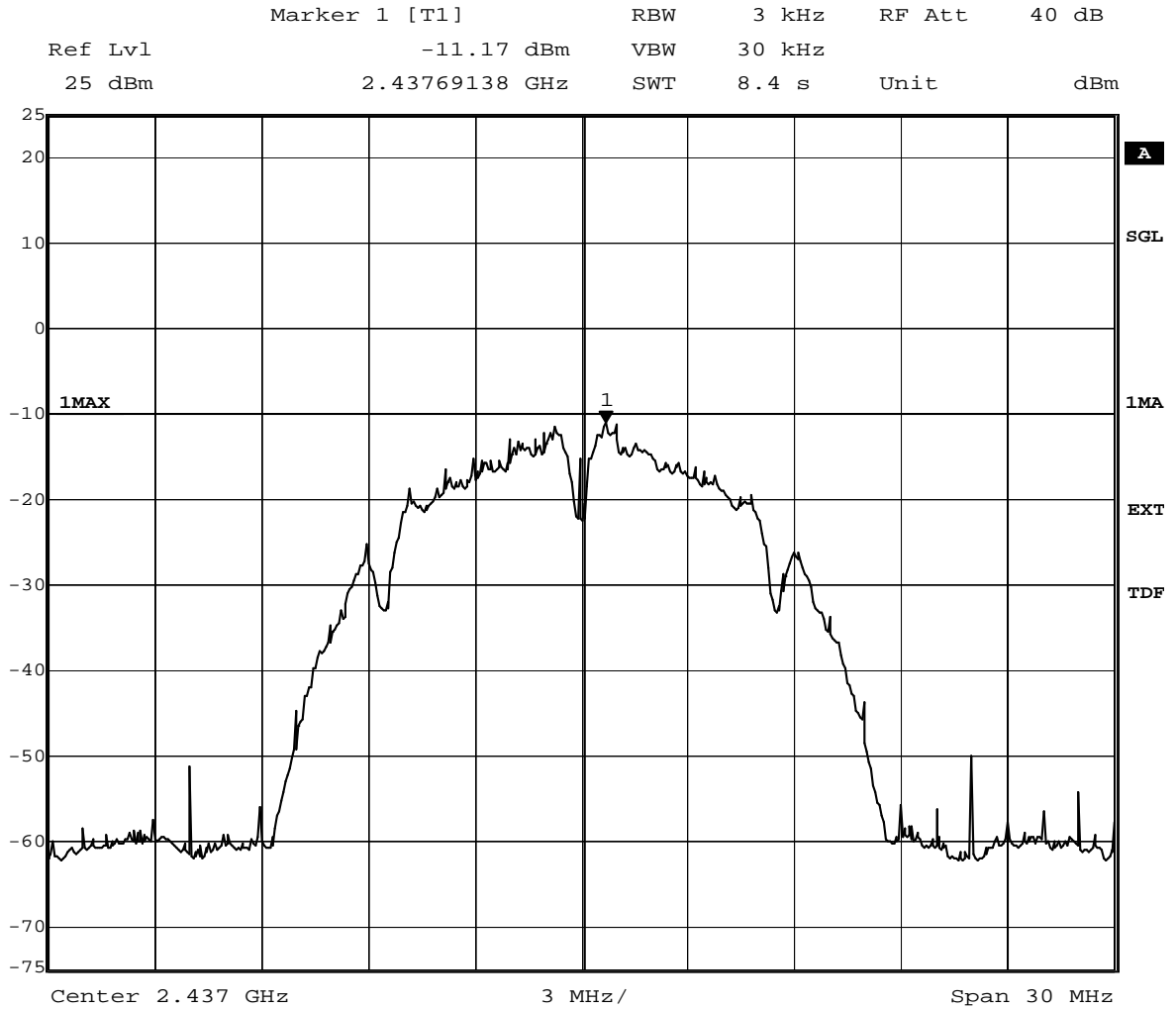

Title: Power Density
Comment A: CH M: 2437 MHz;
Date: 27.SEP.2011 15:51:15



Op. Mode

op-mode 2g

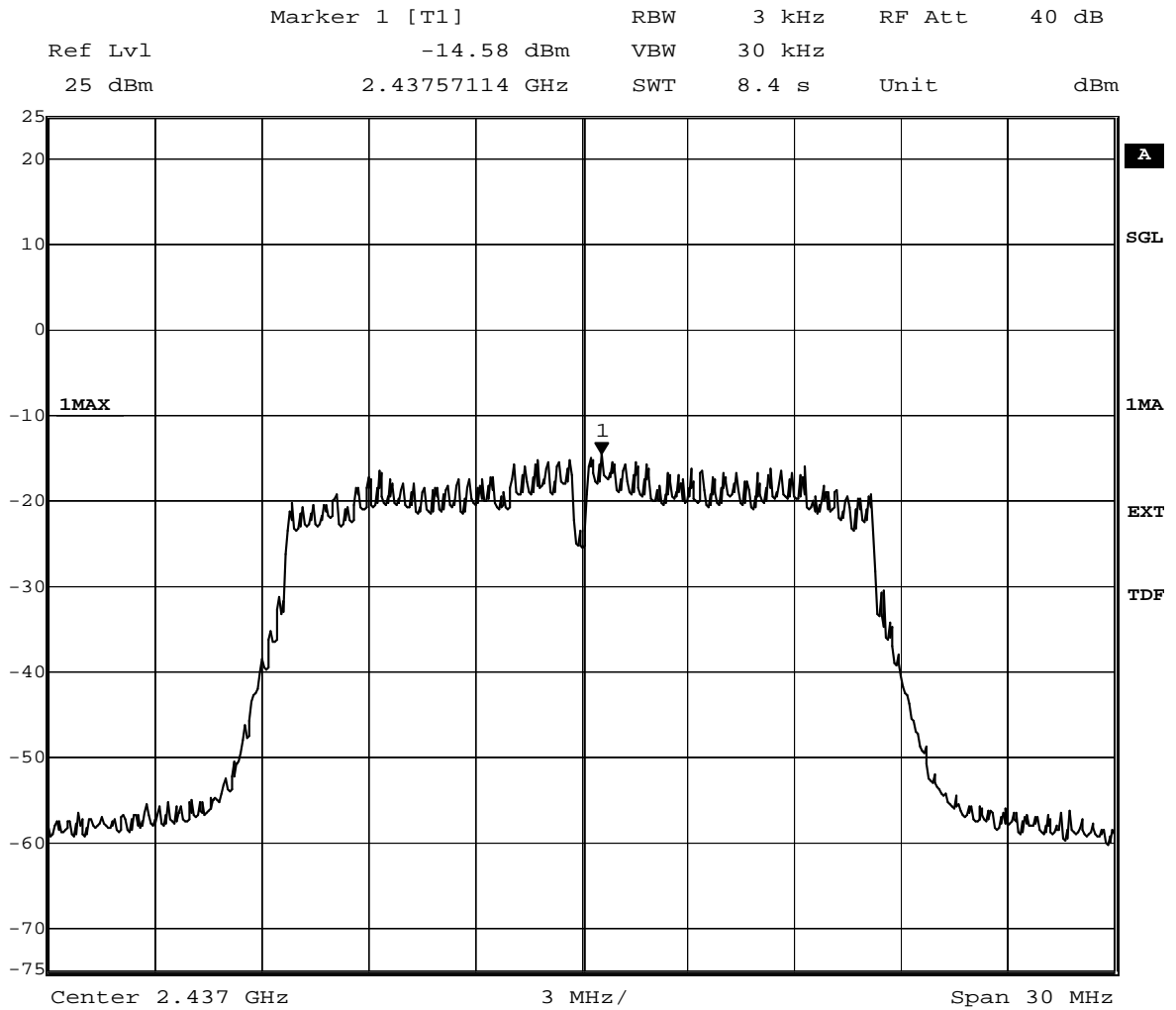

Title: Power Density
Comment A: CH M: 2437 MHz;
Date: 6.OCT.2011 13:22:17



Op. Mode

op-mode 2n

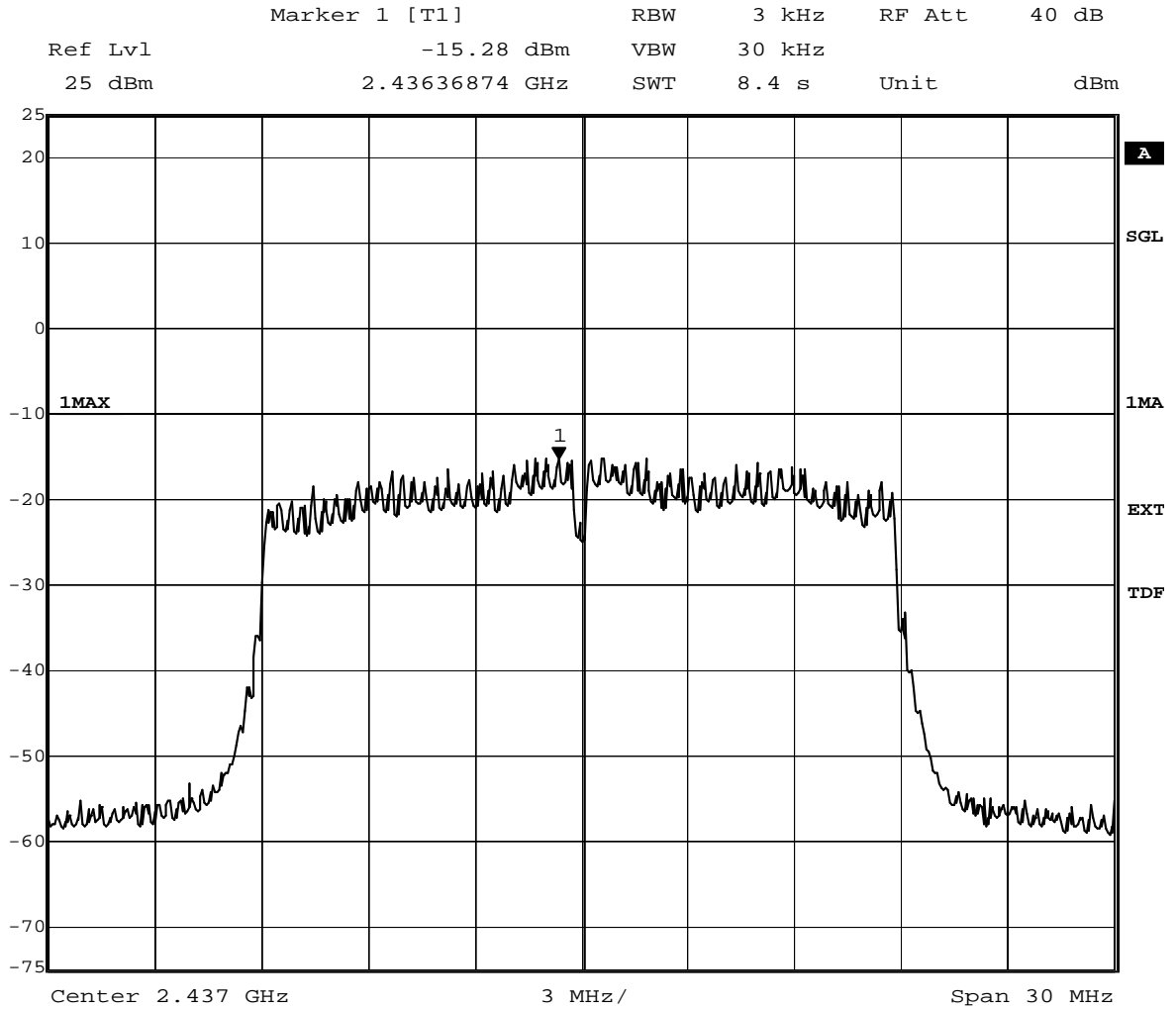

Title: Power Density
Comment A: CH M: 2437 MHz;
Date: 6.OCT.2011 15:33:31



Op. Mode

op-mode 3b

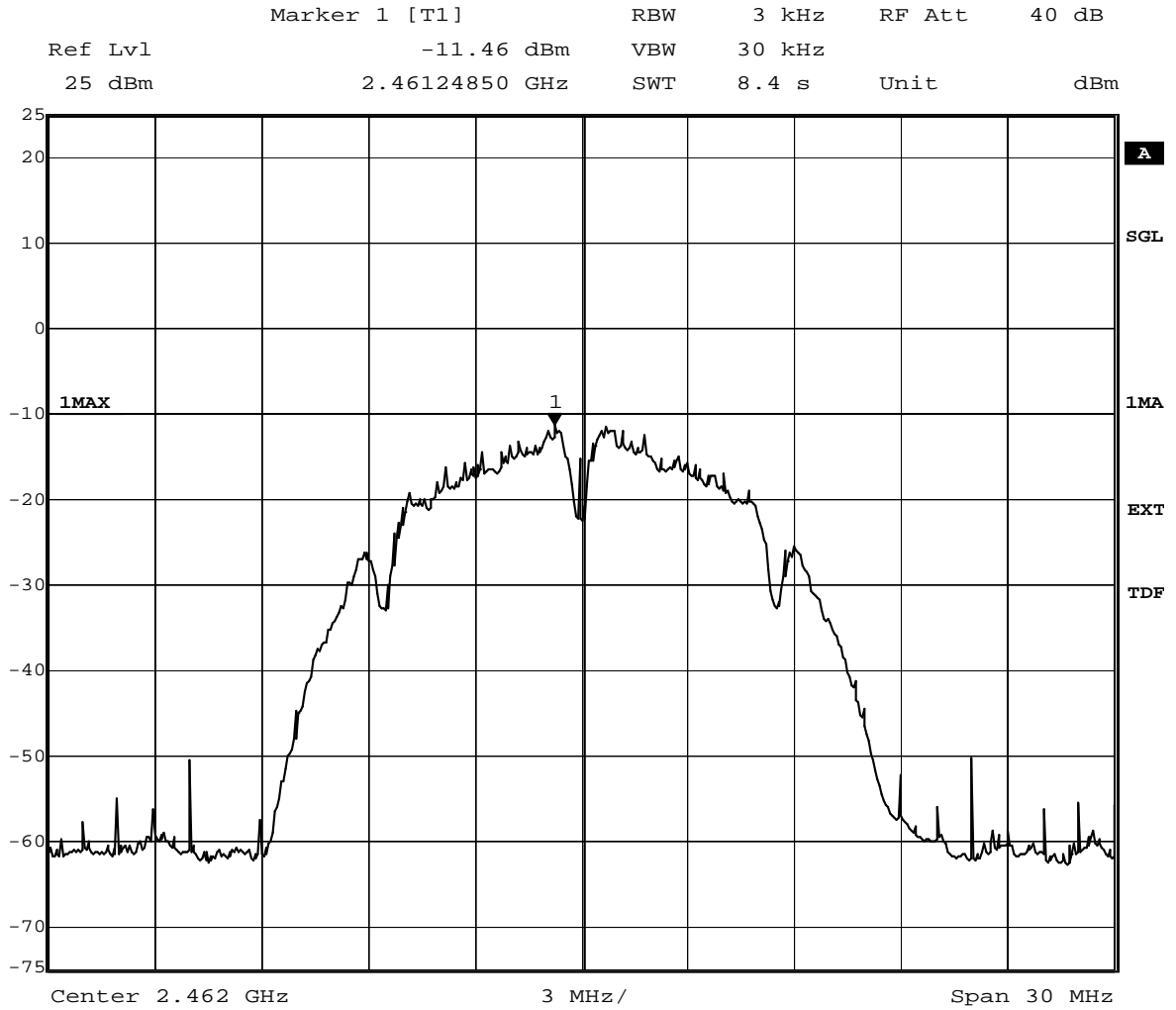

Title: Power Density
Comment A: CH T: 2462 MHz;
Date: 27.SEP.2011 16:27:26



Op. Mode

op-mode 3g

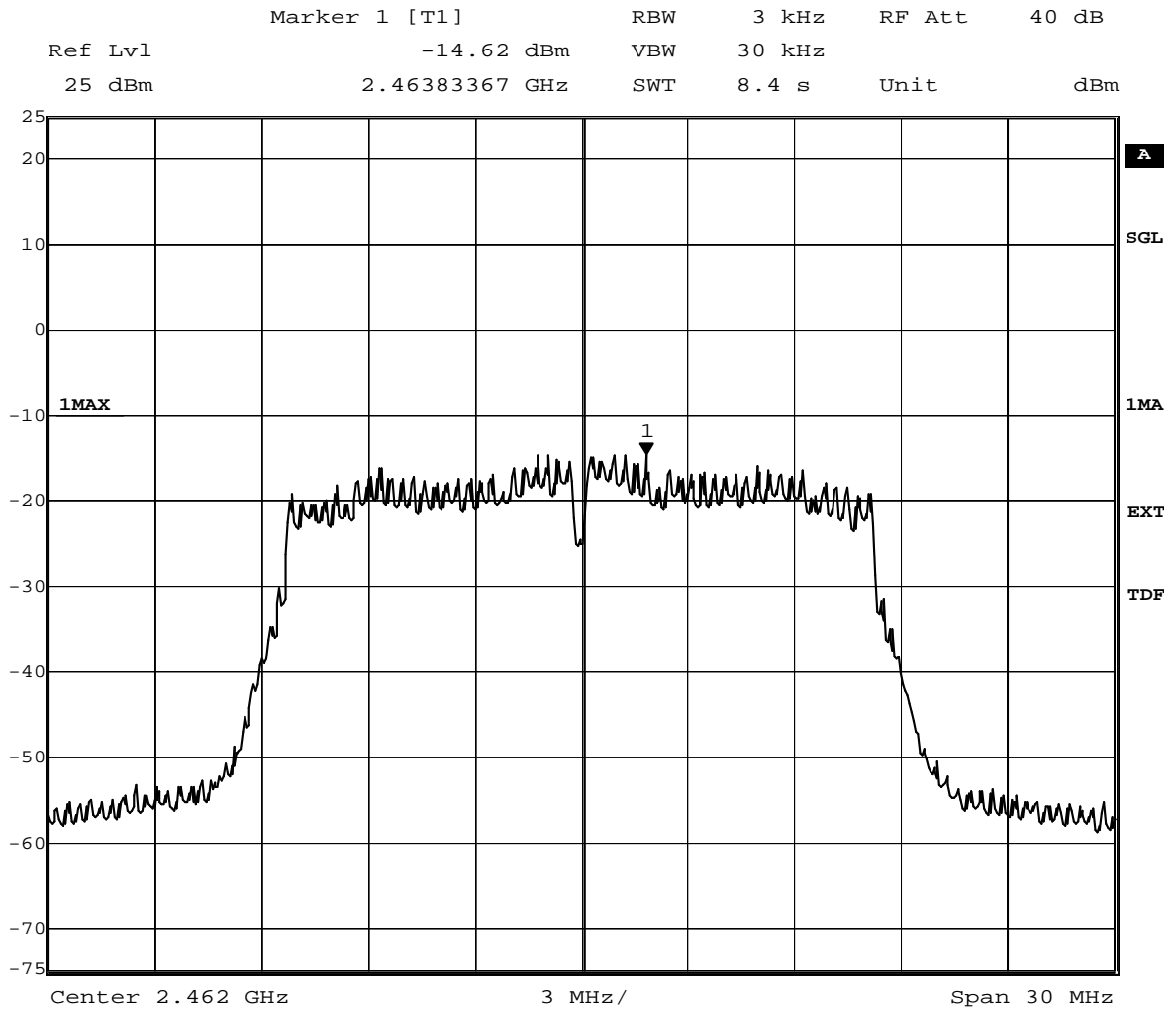

Title: Power Density
Comment A: CH T: 2462 MHz;
Date: 6.OCT.2011 14:26:31



Op. Mode

op-mode 3n

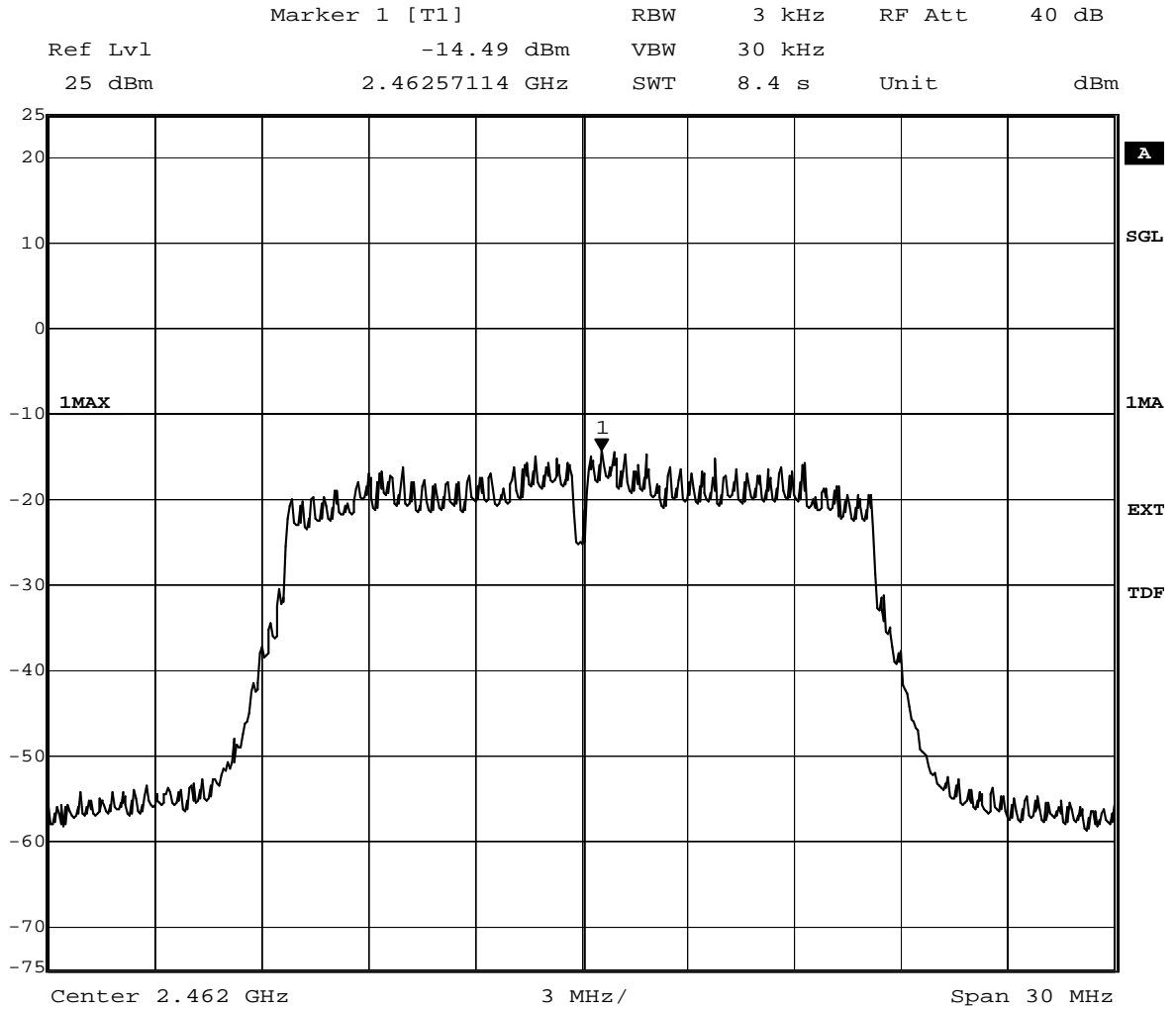

Title: Power Density
Comment A: CH T: 2462 MHz;
Date: 6.OCT.2011 15:01:01