

Appendix for the Report

Dosimetric Assessment of the Portable Device Kyocera F41 (FCC ID: V65XYI11)

According to the FCC Requirements

Calibration Data

November 18, 2011

IMST GmbH
Carl-Friedrich-Gauß-Str. 2
D-47475 Kamp-Lintfort

Customer
KYOCERA Corporation
2-1-1 Kagahara, Tsuzuki-ku,
224-8502 Yokohama-shi
Japan



Accredited by the Swiss Accreditation Service (SAS)
The Swiss Accreditation Service is one of the signatories to the EA
Multilateral Agreement for the recognition of calibration certificates

Accreditation No.: SCS 108

Client **IMST**

Certificate No: EX3-3536_Sep10

CALIBRATION CERTIFICATE

Object **EX3DV4 - SN:3536**

Calibration procedure(s) **QA CAL-01.v6, QA CAL-14.v3, QA CAL-23.v3 and QA CAL-25.v2
Calibration procedure for dosimetric E-field probes**

Calibration date: **September 16, 2010**

This calibration certificate documents the traceability to national standards, which realize the physical units of measurements (SI).
The measurements and the uncertainties with confidence probability are given on the following pages and are part of the certificate.

All calibrations have been conducted in the closed laboratory facility: environment temperature $(22 \pm 3)^\circ\text{C}$ and humidity $< 70\%$.

Calibration Equipment used (M&TE critical for calibration)

Primary Standards	ID #	Cal Date (Certificate No.)	Scheduled Calibration
Power meter E4419B	GB41293874	1-Apr-10 (No. 217-01136)	Apr-11
Power sensor E4412A	MY41495277	1-Apr-10 (No. 217-01136)	Apr-11
Power sensor E4412A	MY41498087	1-Apr-10 (No. 217-01136)	Apr-11
Reference 3 dB Attenuator	SN: S5054 (3c)	30-Mar-10 (No. 217-01159)	Mar-11
Reference 20 dB Attenuator	SN: S5086 (20b)	30-Mar-10 (No. 217-01161)	Mar-11
Reference 30 dB Attenuator	SN: S5129 (30b)	30-Mar-10 (No. 217-01160)	Mar-11
Reference Probe ES3DV2	SN: 3013	30-Dec-09 (No. ES3-3013_Dec09)	Dec-10
DAE4	SN: 660	20-Apr-10 (No. DAE4-660_Apr10)	Apr-11

Secondary Standards	ID #	Check Date (in house)	Scheduled Check
RF generator HP 8648C	US3642U01700	4-Aug-99 (in house check Oct-09)	In house check: Oct-11
Network Analyzer HP 8753E	US37390585	18-Oct-01 (in house check Oct-09)	In house check: Oct10

Calibrated by:	Name	Function	Signature
	Katja Pokovic	Technical Manager	
Approved by:	Fin Bomholt	R&D Director	

Issued: September 16, 2010

This calibration certificate shall not be reproduced except in full without written approval of the laboratory.



Accredited by the Swiss Accreditation Service (SAS)
The Swiss Accreditation Service is one of the signatories to the EA
Multilateral Agreement for the recognition of calibration certificates

Accreditation No.: SCS 108

Glossary:

TSL	tissue simulating liquid
NORM _{x,y,z}	sensitivity in free space
ConvF	sensitivity in TSL / NORM _{x,y,z}
DCP	diode compression point
CF	crest factor (1/duty_cycle) of the RF signal
A, B, C	modulation dependent linearization parameters
Polarization φ	φ rotation around probe axis
Polarization ϑ	ϑ rotation around an axis that is in the plane normal to probe axis (at measurement center), i.e., $\vartheta = 0$ is normal to probe axis

Calibration is Performed According to the Following Standards:

- IEEE Std 1528-2003, "IEEE Recommended Practice for Determining the Peak Spatial-Averaged Specific Absorption Rate (SAR) in the Human Head from Wireless Communications Devices: Measurement Techniques", December 2003
- IEC 62209-1, "Procedure to measure the Specific Absorption Rate (SAR) for hand-held devices used in close proximity to the ear (frequency range of 300 MHz to 3 GHz)", February 2005

Methods Applied and Interpretation of Parameters:

- NORM_{x,y,z}**: Assessed for E-field polarization $\vartheta = 0$ ($f \leq 900$ MHz in TEM-cell; $f > 1800$ MHz: R22 waveguide). NORM_{x,y,z} are only intermediate values, i.e., the uncertainties of NORM_{x,y,z} does not effect the E²-field uncertainty inside TSL (see below ConvF).
- NORM(f)_{x,y,z} = NORM_{x,y,z} * frequency_response** (see Frequency Response Chart). This linearization is implemented in DASY4 software versions later than 4.2. The uncertainty of the frequency response is included in the stated uncertainty of ConvF.
- DCP_{x,y,z}**: DCP are numerical linearization parameters assessed based on the data of power sweep with CW signal (no uncertainty required). DCP does not depend on frequency nor media.
- A_{x,y,z}; B_{x,y,z}; C_{x,y,z}; VR_{x,y,z}; A, B, C** are numerical linearization parameters assessed based on the data of power sweep for specific modulation signal. The parameters do not depend on frequency nor media. VR is the maximum calibration range expressed in RMS voltage across the diode.
- ConvF and Boundary Effect Parameters**: Assessed in flat phantom using E-field (or Temperature Transfer Standard for $f \leq 800$ MHz) and inside waveguide using analytical field distributions based on power measurements for $f > 800$ MHz. The same setups are used for assessment of the parameters applied for boundary compensation (alpha, depth) of which typical uncertainty values are given. These parameters are used in DASY4 software to improve probe accuracy close to the boundary. The sensitivity in TSL corresponds to NORM_{x,y,z} * ConvF whereby the uncertainty corresponds to that given for ConvF. A frequency dependent ConvF is used in DASY version 4.4 and higher which allows extending the validity from ± 50 MHz to ± 100 MHz.
- Spherical isotropy (3D deviation from isotropy)**: in a field of low gradients realized using a flat phantom exposed by a patch antenna.
- Sensor Offset**: The sensor offset corresponds to the offset of virtual measurement center from the probe tip (on probe axis). No tolerance required.

Probe EX3DV4

SN:3536

Manufactured:	April 30, 2004
Last calibrated:	September 18, 2009
Recalibrated:	September 16, 2010

Calibrated for DASY/EASY Systems

(Note: non-compatible with DASY2 system!)

DASY/EASY - Parameters of Probe: EX3DV4 SN:3536**Basic Calibration Parameters**

	Sensor X	Sensor Y	Sensor Z	Unc (k=2)
Norm ($\mu\text{V}/(\text{V}/\text{m})^2$) ^A	0.45	0.42	0.36	$\pm 10.1\%$
DCP (mV) ^B	91.9	90.9	91.4	

Modulation Calibration Parameters

UID	Communication System Name	PAR		A dB	B dBuV	C	VR mV	Unc ^E (k=2)
10000	CW	0.00	X	0.00	0.00	1.00	300	$\pm 1.5\%$
			Y	0.00	0.00	1.00	300	
			Z	0.00	0.00	1.00	300	

The reported uncertainty of measurement is stated as the standard uncertainty of measurement multiplied by the coverage factor $k=2$, which for a normal distribution corresponds to a coverage probability of approximately 95%.

^A The uncertainties of NormX, Y, Z do not affect the E²-field uncertainty inside TSL (see Pages 5 and 6).

^B Numerical linearization parameter; uncertainty not required.

^E Uncertainty is determined using the maximum deviation from linear response applying rectangular distribution and is expressed for the square of the field value.

DASY/EASY - Parameters of Probe: EX3DV4 SN:3536

Calibration Parameter Determined in Head Tissue Simulating Media

f [MHz]	Validity [MHz] ^c	Permittivity	Conductivity	ConvF X	ConvF Y	ConvF Z	Alpha	Depth Unc (k=2)
1950	± 50 / ± 100	40.0 ± 5%	1.40 ± 5%	7.77	7.77	7.77	0.54	0.71 ± 11.0%
2450	± 50 / ± 100	39.2 ± 5%	1.80 ± 5%	7.26	7.26	7.26	0.37	0.86 ± 11.0%
2600	± 50 / ± 100	39.0 ± 5%	1.96 ± 5%	7.31	7.31	7.31	0.44	0.81 ± 11.0%
3500	± 50 / ± 100	37.9 ± 5%	2.91 ± 5%	7.58	7.58	7.58	0.33	1.10 ± 13.1%
5200	± 50 / ± 100	36.0 ± 5%	4.66 ± 5%	5.42	5.42	5.42	0.30	1.90 ± 13.1%
5300	± 50 / ± 100	35.9 ± 5%	4.76 ± 5%	5.08	5.08	5.08	0.35	1.90 ± 13.1%
5600	± 50 / ± 100	35.5 ± 5%	5.07 ± 5%	4.86	4.86	4.86	0.45	1.90 ± 13.1%
5800	± 50 / ± 100	35.3 ± 5%	5.27 ± 5%	4.60	4.60	4.60	0.50	1.90 ± 13.1%

^c The validity of ± 100 MHz only applies for DASY v4.4 and higher (see Page 2). The uncertainty is the RSS of the ConvF uncertainty at calibration frequency and the uncertainty for the indicated frequency band.

DASY/EASY - Parameters of Probe: EX3DV4 SN:3536

Calibration Parameter Determined in Body Tissue Simulating Media

f [MHz]	Validity [MHz] ^c	Permittivity	Conductivity	ConvF X	ConvF Y	ConvF Z	Alpha	Depth Unc (k=2)
1950	± 50 / ± 100	53.3 ± 5%	1.52 ± 5%	7.89	7.89	7.89	0.74	0.61 ± 11.0%
2450	± 50 / ± 100	52.7 ± 5%	1.95 ± 5%	7.48	7.48	7.48	0.30	0.93 ± 11.0%
2600	± 50 / ± 100	52.5 ± 5%	2.16 ± 5%	7.48	7.48	7.48	0.33	1.01 ± 11.0%
3500	± 50 / ± 100	51.3 ± 5%	3.31 ± 5%	6.81	6.81	6.81	0.33	1.30 ± 13.1%
5200	± 50 / ± 100	49.0 ± 5%	5.30 ± 5%	4.36	4.36	4.36	0.60	1.95 ± 13.1%
5300	± 50 / ± 100	48.9 ± 5%	5.42 ± 5%	4.13	4.13	4.13	0.65	1.95 ± 13.1%
5600	± 50 / ± 100	48.5 ± 5%	5.77 ± 5%	3.90	3.90	3.90	0.70	1.95 ± 13.1%
5800	± 50 / ± 100	48.2 ± 5%	6.00 ± 5%	4.10	4.10	4.10	0.65	1.95 ± 13.1%

^c The validity of ± 100 MHz only applies for DASY v4.4 and higher (see Page 2). The uncertainty is the RSS of the ConvF uncertainty at calibration frequency and the uncertainty for the indicated frequency band.

Frequency Response of E-Field

(TEM-Cell:ifi110 EXX, Waveguide: R22)

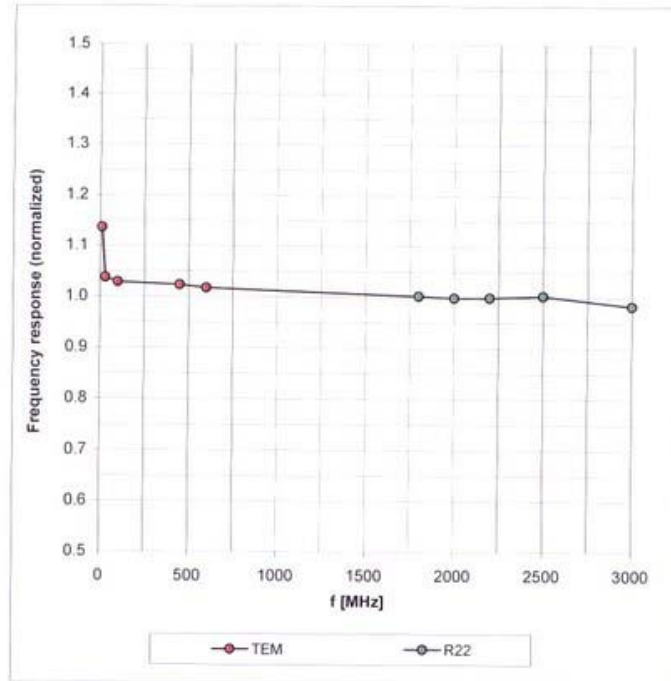

Uncertainty of Frequency Response of E-field: $\pm 6.3\%$ (k=2)

Receiving Pattern (ϕ), $\vartheta = 0^\circ$

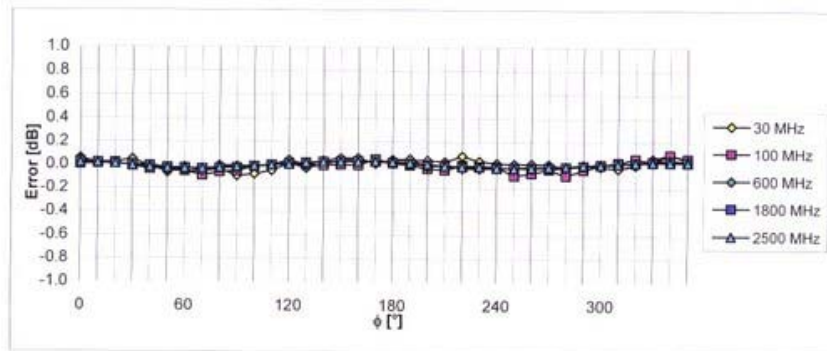
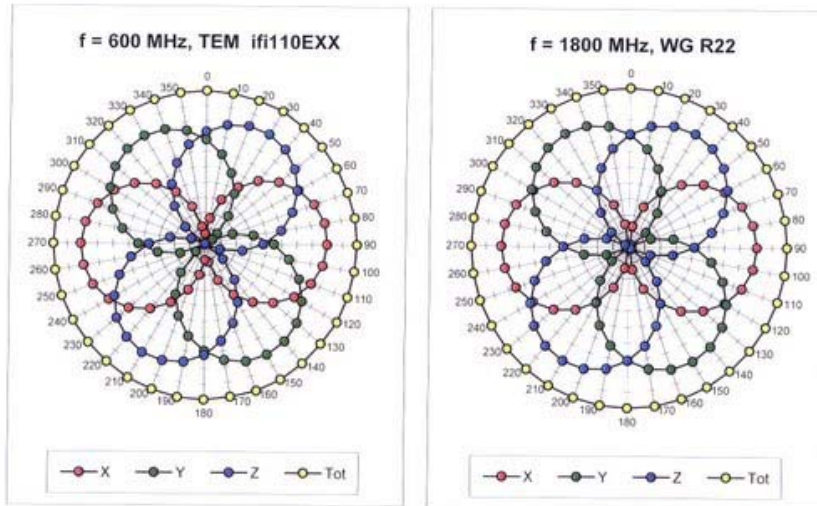

Uncertainty of Axial Isotropy Assessment: $\pm 0.5\%$ ($k=2$)

Dynamic Range $f(\text{SAR}_{\text{head}})$ (Waveguide R22, $f = 1800 \text{ MHz}$)

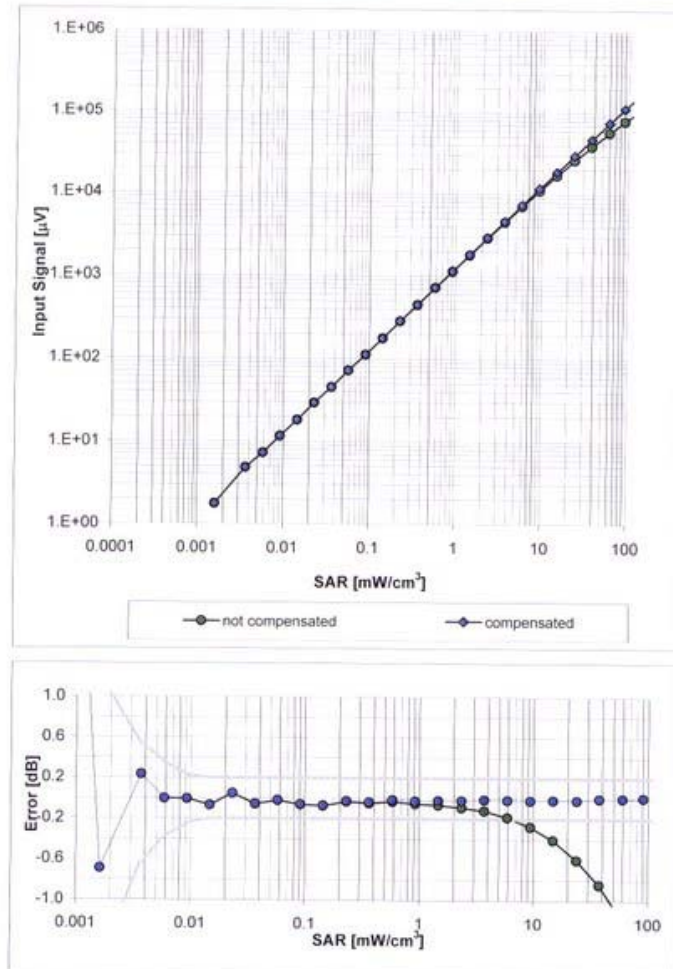

Uncertainty of Linearity Assessment: $\pm 0.6\%$ ($k=2$)

Conversion Factor Assessment

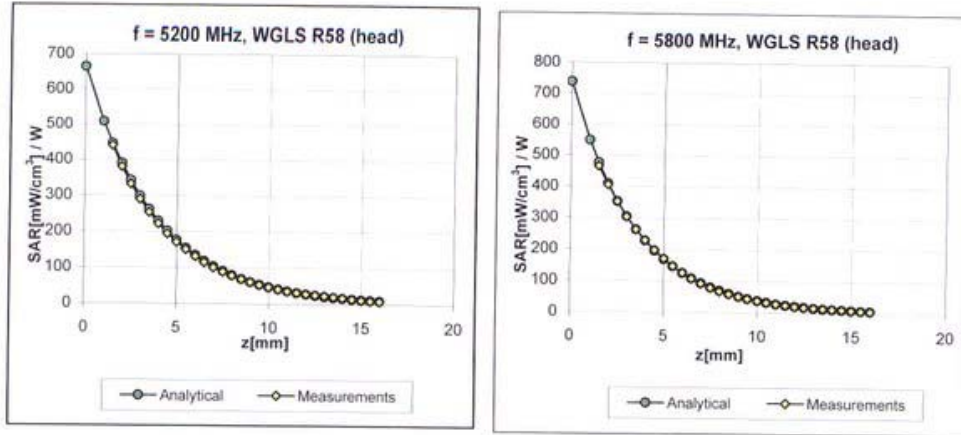

Deviation from Isotropy in HSL

Error (ϕ, θ), f = 900 MHz

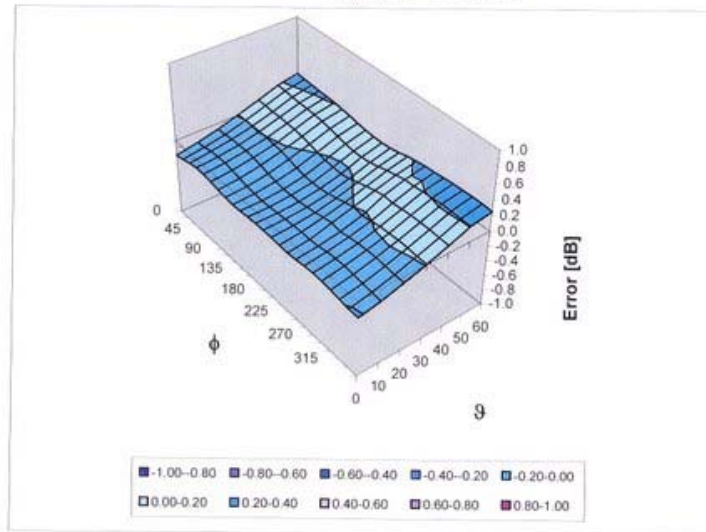

Uncertainty of Spherical Isotropy Assessment: $\pm 2.6\%$ (k=2)

Other Probe Parameters

Sensor Arrangement	Triangular
Connector Angle (°)	Not applicable
Mechanical Surface Detection Mode	enabled
Optical Surface Detection Mode	disabled
Probe Overall Length	337 mm
Probe Body Diameter	10 mm
Tip Length	9 mm
Tip Diameter	2.5 mm
Probe Tip to Sensor X Calibration Point	1 mm
Probe Tip to Sensor Y Calibration Point	1 mm
Probe Tip to Sensor Z Calibration Point	1 mm
Recommended Measurement Distance from Surface	2 mm

Calibration Laboratory of
Schmid & Partner
Engineering AG
Zeughausstrasse 43, 8004 Zurich, Switzerland



S Schweizerischer Kalibrierdienst
S Service suisse d'étalonnage
S Servizio svizzero di taratura
S Swiss Calibration Service

Accredited by the Swiss Accreditation Service (SAS)
The Swiss Accreditation Service is one of the signatories to the EA
Multilateral Agreement for the recognition of calibration certificates

Accreditation No.: SCS 108

Client **IMST**

Certificate No: EX3-3536_Sep11

CALIBRATION CERTIFICATE

Object **EX3DV4 - SN:3536**

Calibration procedure(s) **QA CAL-01.v8, QA CAL-14.v3, QA CAL-23.v4, QA CAL-25.v4
Calibration procedure for dosimetric E-field probes**

Calibration date: **September 26, 2011**

This calibration certificate documents the traceability to national standards, which realize the physical units of measurements (SI).
The measurements and the uncertainties with confidence probability are given on the following pages and are part of the certificate.

All calibrations have been conducted in the closed laboratory facility: environment temperature $(22 \pm 3)^\circ\text{C}$ and humidity $< 70\%$.

Calibration Equipment used (M&TE critical for calibration)

Primary Standards	ID	Cal Date (Certificate No.)	Scheduled Calibration
Power meter E4419B	GB41293874	31-Mar-11 (No. 217-01372)	Apr-12
Power sensor E4412A	MY41498087	31-Mar-11 (No. 217-01372)	Apr-12
Reference 3 dB Attenuator	SN: S5054 (3c)	29-Mar-11 (No. 217-01369)	Apr-12
Reference 20 dB Attenuator	SN: S5086 (20b)	29-Mar-11 (No. 217-01367)	Apr-12
Reference 30 dB Attenuator	SN: S5129 (30b)	29-Mar-11 (No. 217-01370)	Apr-12
Reference Probe ES3DV2	SN: 3013	29-Dec-10 (No. ES3-3013_Dec10)	Dec-11
DAE4	SN: 654	3-May-11 (No. DAE4-654_May11)	May-12
Secondary Standards	ID	Check Date (in house)	Scheduled Check
RF generator HP 8648C	US3642U01700	4-Aug-99 (in house check Oct-09)	In house check: Oct-11
Network Analyzer HP 8753E	US37390585	18-Oct-01 (in house check Oct-10)	In house check: Oct-11

Calibrated by:	Name Katja Pokovic	Function Technical Manager	Signature
Approved by:	Niels Kuster	Quality Manager	
			Issued: September 27, 2011
This calibration certificate shall not be reproduced except in full without written approval of the laboratory.			



Accredited by the Swiss Accreditation Service (SAS)

Accreditation No.: SCS 108

The Swiss Accreditation Service is one of the signatories to the EA
Multilateral Agreement for the recognition of calibration certificates

Glossary:

TSL	tissue simulating liquid
NORM _{x,y,z}	sensitivity in free space
ConvF	sensitivity in TSL / NORM _{x,y,z}
DCP	diode compression point
CF	crest factor (1/duty_cycle) of the RF signal
A, B, C	modulation dependent linearization parameters
Polarization φ	φ rotation around probe axis
Polarization ϑ	ϑ rotation around an axis that is in the plane normal to probe axis (at measurement center), i.e., $\vartheta = 0$ is normal to probe axis

Calibration is Performed According to the Following Standards:

- IEEE Std 1528-2003, "IEEE Recommended Practice for Determining the Peak Spatial-Averaged Specific Absorption Rate (SAR) in the Human Head from Wireless Communications Devices: Measurement Techniques", December 2003
- IEC 62209-1, "Procedure to measure the Specific Absorption Rate (SAR) for hand-held devices used in close proximity to the ear (frequency range of 300 MHz to 3 GHz)", February 2005

Methods Applied and Interpretation of Parameters:

- NORM_{x,y,z}**: Assessed for E-field polarization $\vartheta = 0$ ($f \leq 900$ MHz in TEM-cell; $f > 1800$ MHz: R22 waveguide). NORM_{x,y,z} are only intermediate values, i.e., the uncertainties of NORM_{x,y,z} does not affect the E^2 -field uncertainty inside TSL (see below ConvF).
- NORM(f)_{x,y,z} = NORM_{x,y,z} * frequency_response** (see Frequency Response Chart). This linearization is implemented in DASY4 software versions later than 4.2. The uncertainty of the frequency response is included in the stated uncertainty of ConvF.
- DCP_{x,y,z}**: DCP are numerical linearization parameters assessed based on the data of power sweep with CW signal (no uncertainty required). DCP does not depend on frequency nor media.
- PAR**: PAR is the Peak to Average Ratio that is not calibrated but determined based on the signal characteristics
- A_{x,y,z}; B_{x,y,z}; C_{x,y,z}; VR_{x,y,z}**: A, B, C are numerical linearization parameters assessed based on the data of power sweep for specific modulation signal. The parameters do not depend on frequency nor media. VR is the maximum calibration range expressed in RMS voltage across the diode.
- ConvF and Boundary Effect Parameters**: Assessed in flat phantom using E-field (or Temperature Transfer Standard for $f \leq 800$ MHz) and inside waveguide using analytical field distributions based on power measurements for $f > 800$ MHz. The same setups are used for assessment of the parameters applied for boundary compensation (alpha, depth) of which typical uncertainty values are given. These parameters are used in DASY4 software to improve probe accuracy close to the boundary. The sensitivity in TSL corresponds to NORM_{x,y,z} * ConvF whereby the uncertainty corresponds to that given for ConvF. A frequency dependent ConvF is used in DASY version 4.4 and higher which allows extending the validity from ± 50 MHz to ± 100 MHz.
- Spherical isotropy (3D deviation from isotropy)**: in a field of low gradients realized using a flat phantom exposed by a patch antenna.
- Sensor Offset**: The sensor offset corresponds to the offset of virtual measurement center from the probe tip (on probe axis). No tolerance required.

Probe EX3DV4

SN:3536

Manufactured: April 30, 2004
Calibrated: September 26, 2011

Calibrated for DASY/EASY Systems
(Note: non-compatible with DASY2 system!)

DASY/EASY - Parameters of Probe: EX3DV4 - SN:3536

Basic Calibration Parameters

	Sensor X	Sensor Y	Sensor Z	Unc (k=2)
Norm ($\mu\text{V}/(\text{V}/\text{m})^2$) ^A	0.44	0.43	0.36	$\pm 10.1\%$
DCP (mV) ^B	101.1	97.3	100.2	

Modulation Calibration Parameters

UID	Communication System Name	PAR		A dB	B dB	C dB	VR mV	Unc ^E (k=2)
10000	CW	0.00	X	0.00	0.00	1.00	108.8	$\pm 2.7\%$
			Y	0.00	0.00	1.00	101.4	
			Z	0.00	0.00	1.00	97.4	

The reported uncertainty of measurement is stated as the standard uncertainty of measurement multiplied by the coverage factor $k=2$, which for a normal distribution corresponds to a coverage probability of approximately 95%.

^A The uncertainties of NormX,Y,Z do not affect the E^2 -field uncertainty inside TSL (see Pages 5 and 6).

^B Numerical linearization parameter: uncertainty not required.

^E Uncertainty is determined using the max. deviation from linear response applying rectangular distribution and is expressed for the square of the field value.

DASY/EASY - Parameters of Probe: EX3DV4 - SN:3536

Calibration Parameter Determined in Head Tissue Simulating Media

f (MHz) ^C	Relative Permittivity ^F	Conductivity (S/m) ^F	ConvF X	ConvF Y	ConvF Z	Alpha	Depth (mm)	Unct. (k=2)
1950	40.0	1.40	8.07	8.07	8.07	0.80	0.60	± 12.0 %
2450	39.2	1.80	7.45	7.45	7.45	0.79	0.59	± 12.0 %
2600	39.0	1.96	7.28	7.28	7.28	0.71	0.63	± 12.0 %
3500	37.9	2.91	7.32	7.32	7.32	0.26	1.25	± 13.1 %
5200	36.0	4.66	5.27	5.27	5.27	0.38	1.80	± 13.1 %
5300	35.9	4.76	4.90	4.90	4.90	0.40	1.80	± 13.1 %
5600	35.5	5.07	4.61	4.61	4.61	0.50	1.80	± 13.1 %
5800	35.3	5.27	4.53	4.53	4.53	0.50	1.80	± 13.1 %

^C Frequency validity of ± 100 MHz only applies for DASY v4.4 and higher (see Page 2), else it is restricted to ± 50 MHz. The uncertainty is the RSS of the ConvF uncertainty at calibration frequency and the uncertainty for the indicated frequency band.

^F At frequencies below 3 GHz, the validity of tissue parameters (ϵ and σ) can be relaxed to ± 10% if liquid compensation formula is applied to measured SAR values. At frequencies above 3 GHz, the validity of tissue parameters (ϵ and σ) is restricted to ± 5%. The uncertainty is the RSS of the ConvF uncertainty for indicated target tissue parameters.

DASY/EASY - Parameters of Probe: EX3DV4 - SN:3536

Calibration Parameter Determined in Body Tissue Simulating Media

f (MHz) ^C	Relative Permittivity ^F	Conductivity (S/m) ^F	ConvF X	ConvF Y	ConvF Z	Alpha	Depth (mm)	Unct. (k=2)
1950	53.3	1.52	8.03	8.03	8.03	0.80	0.62	± 12.0 %
2450	52.7	1.95	7.42	7.42	7.42	0.80	0.50	± 12.0 %
2600	52.5	2.16	7.39	7.39	7.39	0.80	0.50	± 12.0 %
3500	51.3	3.31	6.82	6.82	6.82	0.34	1.21	± 13.1 %
5200	49.0	5.30	4.43	4.43	4.43	0.60	1.95	± 13.1 %
5300	48.9	5.42	4.18	4.18	4.18	0.60	1.95	± 13.1 %
5600	48.5	5.77	3.92	3.92	3.92	0.65	1.95	± 13.1 %
5800	48.2	6.00	4.03	4.03	4.03	0.65	1.95	± 13.1 %

^C Frequency validity of ± 100 MHz only applies for DASY v4.4 and higher (see Page 2), else it is restricted to ± 50 MHz. The uncertainty is the RSS of the ConvF uncertainty at calibration frequency and the uncertainty for the indicated frequency band.

^F At frequencies below 3 GHz, the validity of tissue parameters (ϵ and σ) can be relaxed to $\pm 10\%$ if liquid compensation formula is applied to measured SAR values. At frequencies above 3 GHz, the validity of tissue parameters (ϵ and σ) is restricted to $\pm 5\%$. The uncertainty is the RSS of the ConvF uncertainty for indicated target tissue parameters.

Frequency Response of E-Field (TEM-Cell:ifi110 EXX, Waveguide: R22)

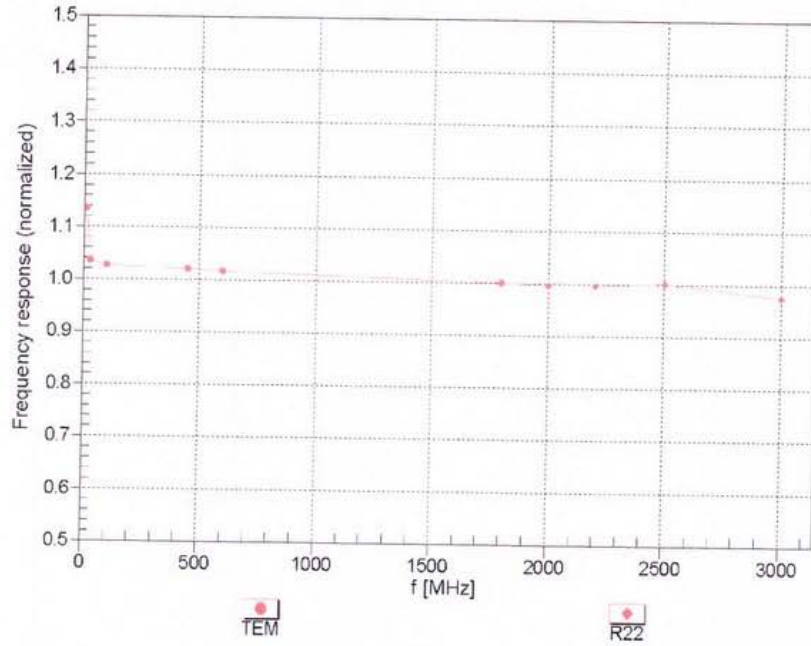

Uncertainty of Frequency Response of E-field: $\pm 6.3\%$ (k=2)

Receiving Pattern (ϕ), $\vartheta = 0^\circ$

f=600 MHz,TEM

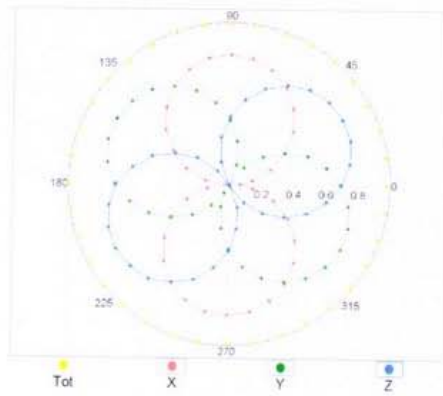

f=1800 MHz,R22

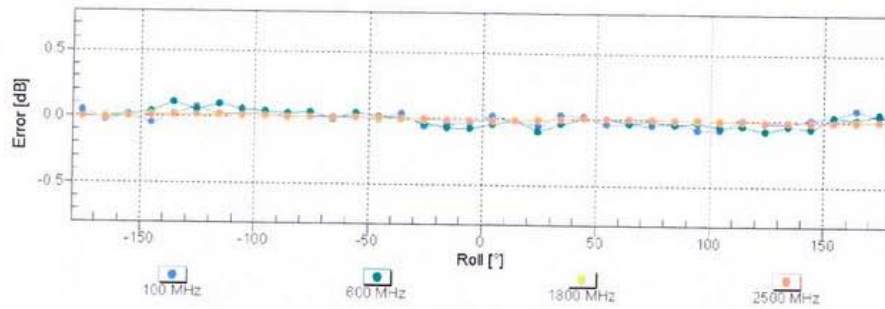
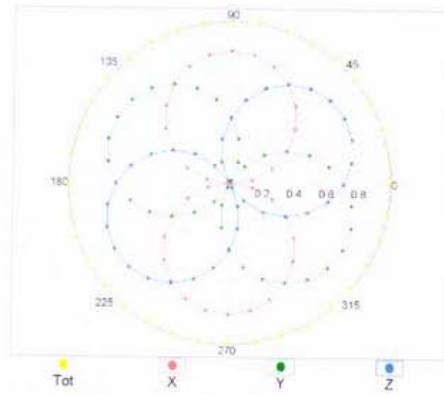

Uncertainty of Axial Isotropy Assessment: $\pm 0.5\%$ (k=2)

Dynamic Range f(SAR_{head}) (TEM cell , f = 900 MHz)

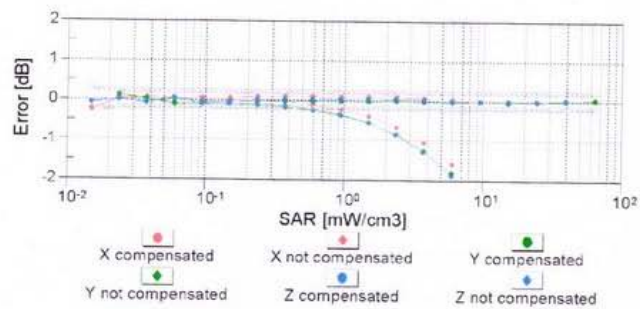
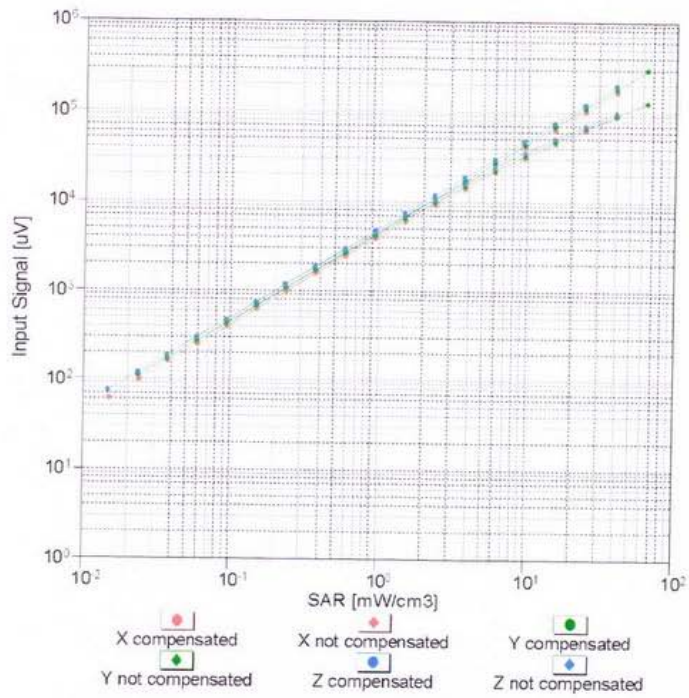

Uncertainty of Linearity Assessment: ± 0.6% (k=2)

Conversion Factor Assessment

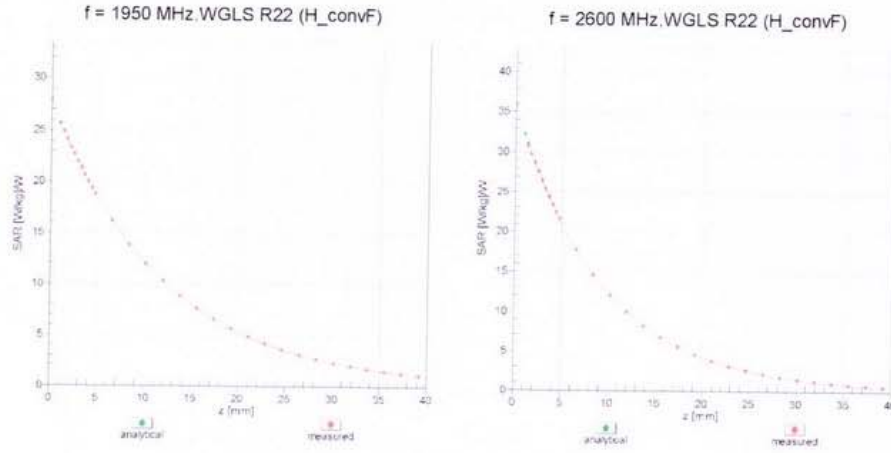

Deviation from Isotropy in Liquid

Error (ϕ, ϑ), f = 900 MHz

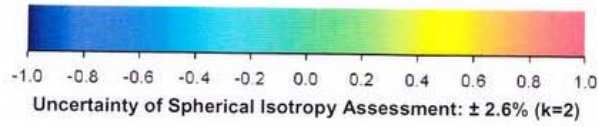
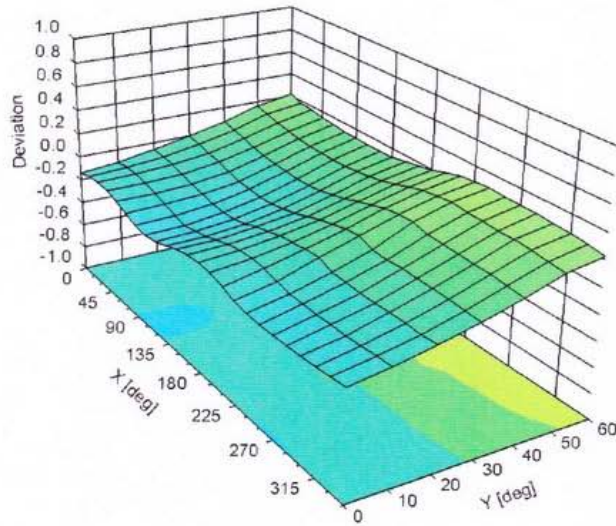

Uncertainty of Spherical Isotropy Assessment: $\pm 2.6\%$ (k=2)

DASY/EASY - Parameters of Probe: EX3DV4 - SN:3536**Other Probe Parameters**

Sensor Arrangement	Triangular
Connector Angle (°)	Not applicable
Mechanical Surface Detection Mode	enabled
Optical Surface Detection Mode	disabled
Probe Overall Length	337 mm
Probe Body Diameter	10 mm
Tip Length	9 mm
Tip Diameter	2.5 mm
Probe Tip to Sensor X Calibration Point	1 mm
Probe Tip to Sensor Y Calibration Point	1 mm
Probe Tip to Sensor Z Calibration Point	1 mm
Recommended Measurement Distance from Surface	2 mm



Accredited by the Swiss Accreditation Service (SAS)

Accreditation No.: **SCS 108**

The Swiss Accreditation Service is one of the signatories to the EA
Multilateral Agreement for the recognition of calibration certificates

Client **IMST**

Certificate No: **ET3-1669_Feb11**

CALIBRATION CERTIFICATE

Object **ET3DV6R - SN:1669**

Calibration procedure(s) **QA CAL-01.v7, QA CAL-12.v6, QA CAL-23.v4, QA CAL-25.v3
Calibration procedure for dosimetric E-field probes**

Calibration date: **February 21, 2011**

This calibration certificate documents the traceability to national standards, which realize the physical units of measurements (SI).
The measurements and the uncertainties with confidence probability are given on the following pages and are part of the certificate.

All calibrations have been conducted in the closed laboratory facility: environment temperature $(22 \pm 3)^\circ\text{C}$ and humidity $< 70\%$.

Calibration Equipment used (M&TE critical for calibration)

Primary Standards	ID	Cal Date (Certificate No.)	Scheduled Calibration
Power meter E4419B	GB41293874	01-Apr-10 (No. 217-01136)	Apr-11
Power sensor E4412A	MY41495277	01-Apr-10 (No. 217-01136)	Apr-11
Power sensor E4412A	MY41498087	01-Apr-10 (No. 217-01136)	Apr-11
Reference 3 dB Attenuator	SN: S5054 (3c)	30-Mar-10 (No. 217-01159)	Mar-11
Reference 20 dB Attenuator	SN: S5086 (20b)	30-Mar-10 (No. 217-01161)	Mar-11
Reference 30 dB Attenuator	SN: S5129 (30b)	30-Mar-10 (No. 217-01160)	Mar-11
Reference Probe ES3DV2	SN: 3013	29-Dec-10 (No. ES3-3013_Dec10)	Dec-11
DAE4	SN: 654	23-Apr-10 (No. DAE4-654_Apr10)	Apr-11
Secondary Standards	ID	Check Date (in house)	Scheduled Check
RF generator HP 8648C	US3642U01700	4-Aug-99 (in house check Oct-09)	In house check: Oct-11
Network Analyzer HP 8753E	US37390585	18-Oct-01 (in house check Oct-10)	In house check: Oct-11

	Name	Function	Signature
Calibrated by:	Jeton Kastrati	Laboratory Technician	
Approved by:	Katja Pokovic	Technical Manager	

Issued: February 22, 2011

This calibration certificate shall not be reproduced except in full without written approval of the laboratory.



Accredited by the Swiss Accreditation Service (SAS)

Accreditation No.: SCS 108

The Swiss Accreditation Service is one of the signatories to the EA
Multilateral Agreement for the recognition of calibration certificates

Glossary:

TSL	tissue simulating liquid
NORM _{x,y,z}	sensitivity in free space
ConvF	sensitivity in TSL / NORM _{x,y,z}
DCP	diode compression point
CF	crest factor (1/duty_cycle) of the RF signal
A, B, C	modulation dependent linearization parameters
Polarization Θ	Θ rotation around probe axis
Polarization ϑ	ϑ rotation around an axis that is in the plane normal to probe axis (at measurement center), i.e., $\vartheta = 0$ is normal to probe axis

Calibration is Performed According to the Following Standards:

- IEEE Std 1528-2003, "IEEE Recommended Practice for Determining the Peak Spatial-Averaged Specific Absorption Rate (SAR) in the Human Head from Wireless Communications Devices: Measurement Techniques", December 2003
- IEC 62209-1, "Procedure to measure the Specific Absorption Rate (SAR) for hand-held devices used in close proximity to the ear (frequency range of 300 MHz to 3 GHz)", February 2005

Methods Applied and Interpretation of Parameters:

- NORM_{x,y,z}**: Assessed for E-field polarization $\vartheta = 0$ ($f \leq 900$ MHz in TEM-cell; $f > 1800$ MHz: R22 waveguide). NORM_{x,y,z} are only intermediate values, i.e., the uncertainties of NORM_{x,y,z} does not affect the E²-field uncertainty inside TSL (see below ConvF).
- NORM(f)_{x,y,z} = NORM_{x,y,z} * frequency_response** (see Frequency Response Chart). This linearization is implemented in DASY4 software versions later than 4.2. The uncertainty of the frequency response is included in the stated uncertainty of ConvF.
- DCP_{x,y,z}**: DCP are numerical linearization parameters assessed based on the data of power sweep with CW signal (no uncertainty required). DCP does not depend on frequency nor media.
- PAR**: PAR is the Peak to Average Ratio that is not calibrated but determined based on the signal characteristics
- A_{x,y,z}; B_{x,y,z}; C_{x,y,z}** are numerical linearization parameters in dB assessed based on the data of power sweep for specific modulation signal. The parameters do not depend on frequency nor media.
- VR**: VR is the validity range of the calibration related to the average diode voltage or DAE voltage in mV.
- ConvF and Boundary Effect Parameters**: Assessed in flat phantom using E-field (or Temperature Transfer Standard for $f \leq 800$ MHz) and inside waveguide using analytical field distributions based on power measurements for $f > 800$ MHz. The same setups are used for assessment of the parameters applied for boundary compensation (alpha, depth) of which typical uncertainty values are given. These parameters are used in DASY4 software to improve probe accuracy close to the boundary. The sensitivity in TSL corresponds to NORM_{x,y,z} * ConvF whereby the uncertainty corresponds to that given for ConvF. A frequency dependent ConvF is used in DASY version 4.4 and higher which allows extending the validity from ± 50 MHz to ± 100 MHz.
- Spherical isotropy (3D deviation from isotropy)**: in a field of low gradients realized using a flat phantom exposed by a patch antenna.
- Sensor Offset**: The sensor offset corresponds to the offset of virtual measurement center from the probe tip (on probe axis). No tolerance required.

Probe ET3DV6R

SN:1669

Manufactured: February 8, 2002
Calibrated: February 21, 2011

Calibrated for DASYS/EASY Systems
(Note: non-compatible with DASYS2 system!)

DASY/EASY - Parameters of Probe: ET3DV6R - SN:1669

Basic Calibration Parameters

	Sensor X	Sensor Y	Sensor Z	Unc (k=2)
Norm ($\mu\text{V}/(\text{V}/\text{m})^2$) ^A	1.76	1.95	1.80	$\pm 10.1 \%$
DCP (mV) ^B	97.6	98.3	97.4	

Modulation Calibration Parameters

UID	Communication System Name	PAR		A dB	B dB	C dB	VR mV	Unc ^E (k=2)
10000	CW	0.00	X	0.00	0.00	1.00	145.7	$\pm 3.5 \%$
			Y	0.00	0.00	1.00	148.4	
			Z	0.00	0.00	1.00	142.7	

The reported uncertainty of measurement is stated as the standard uncertainty of measurement multiplied by the coverage factor k=2, which for a normal distribution corresponds to a coverage probability of approximately 95%.

^A The uncertainties of NormX,Y,Z do not affect the E²-field uncertainty inside TSL (see Pages 5 and 6).

^B Numerical linearization parameter: uncertainty not required.

^E Uncertainty is determined using the max. deviation from linear response applying rectangular distribution and is expressed for the square of the field value.

DASY/EASY - Parameters of Probe: ET3DV6R - SN:1669

Calibration Parameter Determined in Head Tissue Simulating Media

f (MHz) ^C	Relative Permittivity ^F	Conductivity (S/m) ^F	ConvF X	ConvF Y	ConvF Z	Alpha	Depth (mm)	Unct. (k=2)
450	43.5	0.87	7.24	7.24	7.24	0.19	2.22	± 13.4 %
750	41.9	0.89	6.67	6.67	6.67	0.82	1.72	± 12.0 %
900	41.5	0.97	6.23	6.23	6.23	0.70	1.91	± 12.0 %
1750	40.1	1.37	5.34	5.34	5.34	0.56	2.35	± 12.0 %
1900	40.0	1.40	5.12	5.12	5.12	0.56	2.36	± 12.0 %
1950	40.0	1.40	4.94	4.94	4.94	0.57	2.28	± 12.0 %

^C Frequency validity of ± 100 MHz only applies for DASY v4.4 and higher (see Page 2), else it is restricted to ± 50 MHz. The uncertainty is the RSS of the ConvF uncertainty at calibration frequency and the uncertainty for the indicated frequency band.

^F At frequencies below 3 GHz, the validity of tissue parameters (ϵ and σ) can be relaxed to ± 10% if liquid compensation formula is applied to measured SAR values. At frequencies above 3 GHz, the validity of tissue parameters (ϵ and σ) is restricted to ± 5%. The uncertainty is the RSS of the ConvF uncertainty for indicated target tissue parameters.

DASY/EASY - Parameters of Probe: ET3DV6R- SN:1669

Calibration Parameter Determined in Body Tissue Simulating Media

f (MHz) ^C	Relative Permittivity ^F	Conductivity (S/m) ^F	ConvF X	ConvF Y	ConvF Z	Alpha	Depth (mm)	Unct. (k=2)
450	56.7	0.94	7.53	7.53	7.53	0.14	2.31	± 13.4 %
750	55.5	0.96	6.32	6.32	6.32	0.81	1.79	± 12.0 %
900	55.0	1.05	6.15	6.15	6.15	0.70	1.98	± 12.0 %
1750	53.4	1.49	4.75	4.75	4.75	0.60	2.86	± 12.0 %
1900	53.3	1.52	4.54	4.54	4.54	0.58	2.75	± 12.0 %
1950	53.3	1.52	4.63	4.63	4.63	0.58	2.77	± 12.0 %

^C Frequency validity of ± 100 MHz only applies for DASY v4.4 and higher (see Page 2), else it is restricted to ± 50 MHz. The uncertainty is the RSS of the ConvF uncertainty at calibration frequency and the uncertainty for the indicated frequency band.

^F At frequencies below 3 GHz, the validity of tissue parameters (ϵ and σ) can be relaxed to ± 10% if liquid compensation formula is applied to measured SAR values. At frequencies above 3 GHz, the validity of tissue parameters (ϵ and σ) is restricted to ± 5%. The uncertainty is the RSS of the ConvF uncertainty for indicated target tissue parameters.

Frequency Response of E-Field (TEM-Cell:ifi110 EXX, Waveguide: R22)

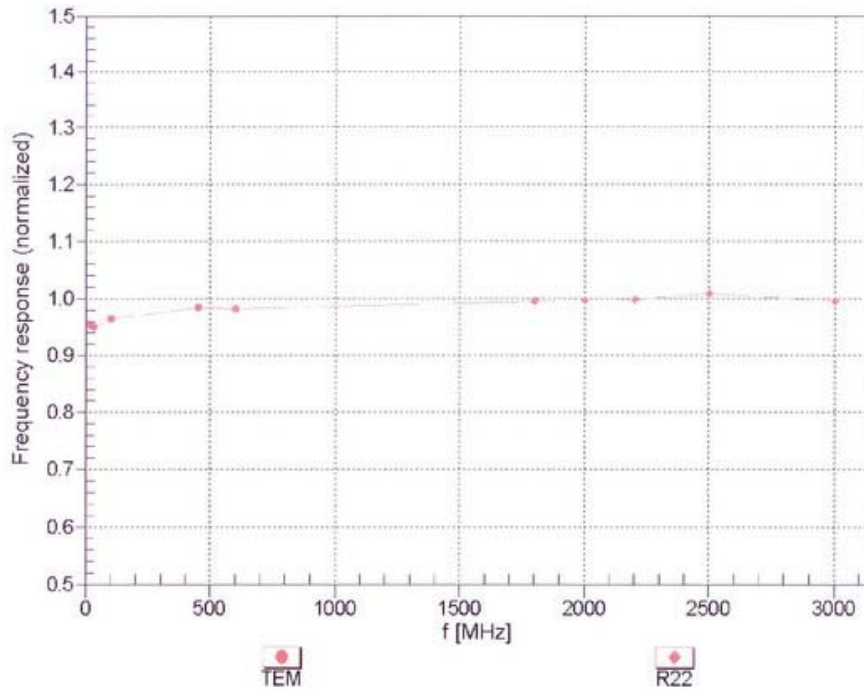

Uncertainty of Frequency Response of E-field: $\pm 6.3\%$ (k=2)

Receiving Pattern (ϕ), $\vartheta = 0^\circ$

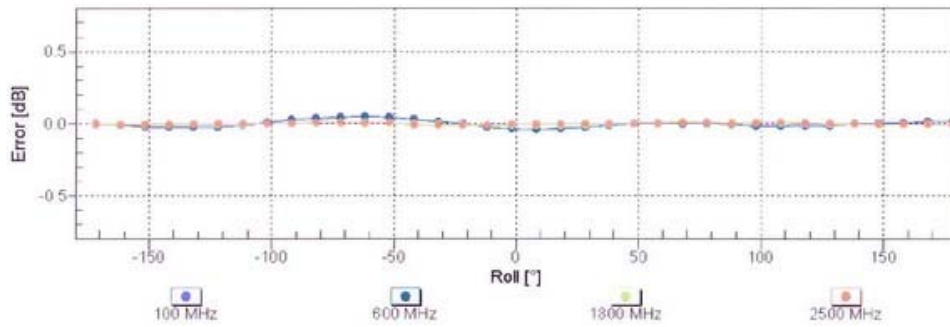
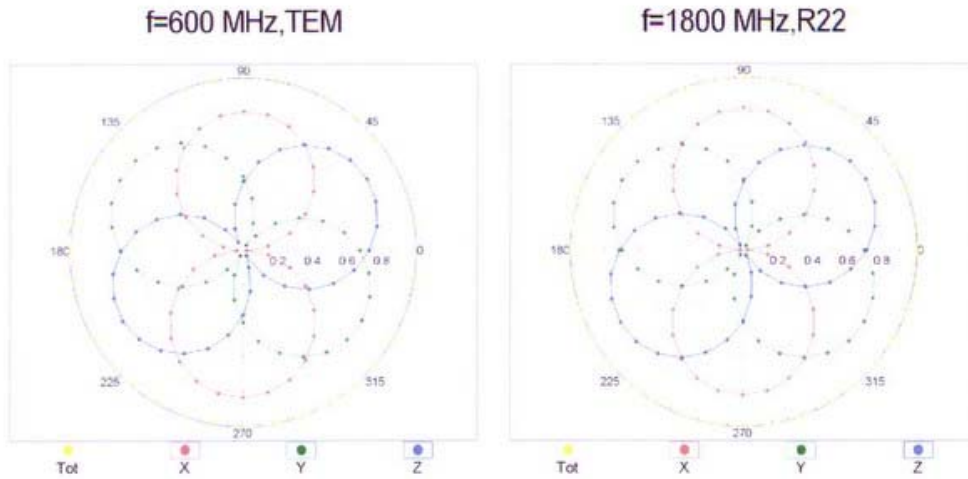

Uncertainty of Axial Isotropy Assessment: $\pm 0.5\%$ ($k=2$)

Dynamic Range f(SAR_{head}) (TEM cell , f = 900 MHz)

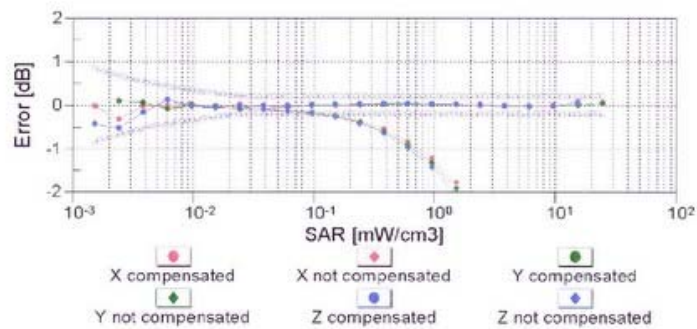
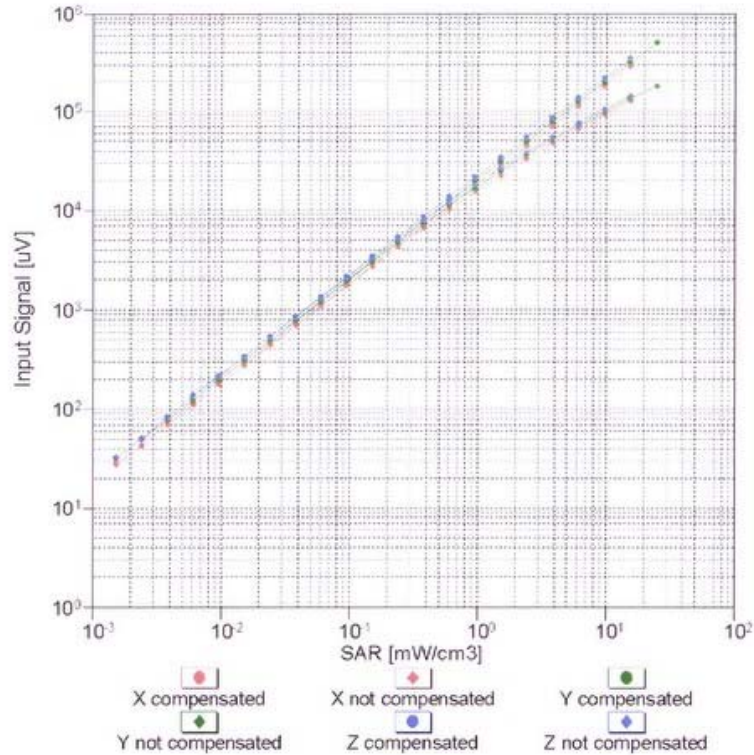

Uncertainty of Linearity Assessment: ± 0.6% (k=2)

Conversion Factor Assessment

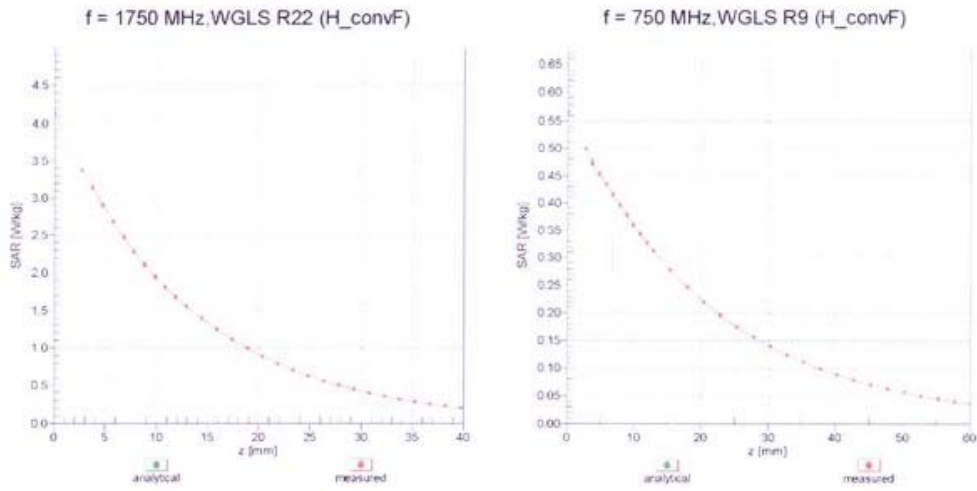

Deviation from Isotropy in Air Error (ϕ, θ), f = 900 MHz

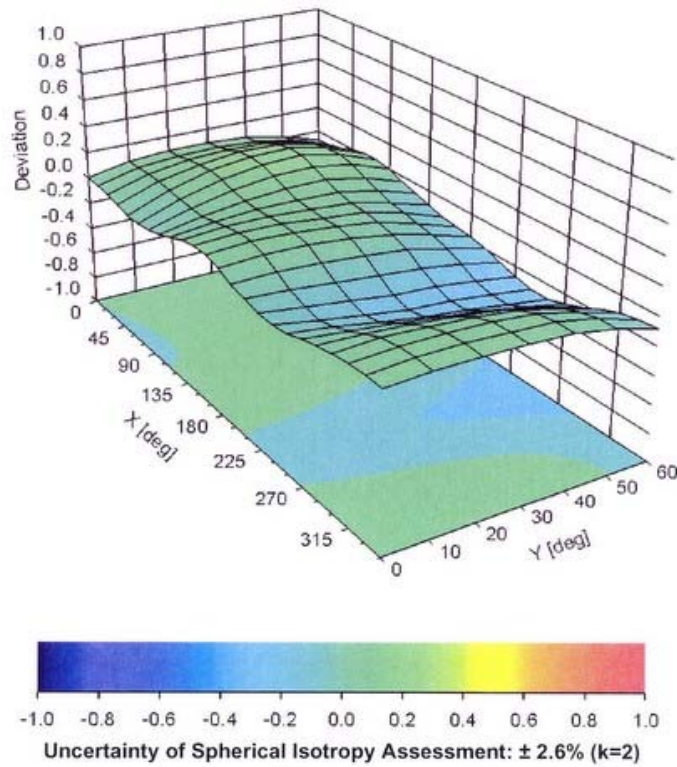

DASY/EASY - Parameters of Probe: ET3DV6R - SN:1669**Other Probe Parameters**

Sensor Arrangement	Triangular
Connector Angle (°)	Not applicable
Mechanical Surface Detection Mode	enabled
Optical Surface Detection Mode	disabled
Probe Overall Length	337 mm
Probe Body Diameter	10 mm
Tip Length	10 mm
Tip Diameter	6.8 mm
Probe Tip to Sensor X Calibration Point	2.7 mm
Probe Tip to Sensor Y Calibration Point	2.7 mm
Probe Tip to Sensor Z Calibration Point	2.7 mm
Recommended Measurement Distance from Surface	4 mm

DAT-P-152/98-01

Calibration Certificate

Certificate No: Cal_D835V2_SN437_0410
 Object: D835V2 SN: 437
 Date of Calibration: April 7, 2010
 Next Calibration: April 2012
 Object Condition: In Tolerance

Calibration Equipment used:

Test Equipment	Serial Number	Last calibration	Calibrated by	Next calibration
Powermeter E4416A	GB41050414	Dec 08	Agilent Techn. (ISO/IEC 17025, 1-1784162174-1)	Dec 10
Power Sensor E9301H	US40010212	Dec 08	Agilent Techn. (ISO/IEC 17025, 1-1784041195-1)	Dec 10
Powermeter E4417A	GB41050441	Dec 08	Agilent Techn. (ISO/IEC 17025, 1-1674038198-1)	Dec 10
Power Sensor E9301A	MY41495584	Dec 08	Agilent Techn. (ISO/IEC 17025, 1-1784041307-1)	Dec 10
Network Analyzer E5071C	MY46103220	Aug 09	Rohde& Schwarz (14967-DKD-00201- 2009-08)	Aug 10
Reference Probe EX3DV4	SN 1579	Jan 10	SPEAG, No ET3- 1579_Jan10	Jan 11
DAE3	SN 631	Sep 09	SPEAG, No DAE4- 631_Sep09	Sep 10

Calibration is performed according the following standards:

IEEE 1528-2003

"IEEE Recommended Practice for Determining the Peak Spatial - Averaged Specific Absorption Rate (SAR) in the Human Head from Wireless Communication Devices: Measurement Technique", December 2003

IEC 62209-1

"Procedure to measure the Specific Absorption Rate (SAR) for hand - held devices used in close proximity to the ear (frequency range of 300 MHz to 3GHz)", February 2005

Federal Communications Commission Office of Engineering & Technologies (FCCOET)

"Evaluating Compliance with FCC Guidelines for Human Exposure to Radiofrequency Electromagnetic Fields; Additional Information for Evaluating Compliance of Mobile and Portable Devices with FCC Limits for Human Exposure to Radiofrequency Emissions", Supplement C (Edition 01-01) to Bulletin 65

Additional Documentation: DASY 4 System Handbook

prepared by:



Alexander Rahn
test engineer

reviewed by:



André van den Bosch
quality assurance engineer

Measurement Conditions		
DASY Version:	Dasy 4;	V4.7
Phantom:	SAM Phantom	1059
Distance Dipole Center – TSL:	15mm	With spacer
Zoom Scan res.	dx, dy, dz = 5mm	
Frequency:	835 MHz \pm 1MHz	

Head TSL Parameters			
	Temperature	Permittivity	Conductivity
Nominal Body TSL Parameters	22.0	41.50	0.90
Measured Body TSL Parameters	22.0	41.10 \pm 6%	0.91 S/m \pm 6%

SAR result with Head TSL			
Averaged over 1g	SAR measured	250mW input power	2.56 mW/g
	SAR normalized	normalized to 1W	10.24 mW/g
	SAR for nominal Body TSL parameters	normalized to 1W	10.15 mW/g \pm 16.5 % (k=2)
Averaged over 10g	SAR measured	250mW input power	1.66 mW/g
	SAR normalized	normalized to 1W	6.64 mW/g
	SAR for nominal Body TSL parameters	normalized to 1W	6.60 mW/g \pm 16.5 % (k=2)

Body TSL Parameters			
	Temperature	Permittivity	Conductivity
Nominal Body TSL Parameters	22.0	55.20	0.97
Measured Body TSL Parameters	22.0	55.70 ± 6%	1.00 S/m ± 6%

SAR result with Body TSL			
Averaged over 1g	SAR measured	250mW input power	2.49 mW/g
	SAR normalized	normalized to 1W	9.96 mW/g
	SAR for nominal Body TSL parameters	normalized to 1W	9.83 mW/g ± 16.5 % (k=2)
Averaged over 10g	SAR measured	250mW input power	1.62 mW/g
	SAR normalized	normalized to 1W	6.48 mW/g
	SAR for nominal Body TSL parameters	normalized to 1W	6.44 mW/g ± 16.5 % (k=2)

General Antenna Parameters		
Antenna Parameter with Head TSL	Impedance, transformed to feed point	46.34 jΩ - 4.8 jΩ
	Return Loss	-24.06 dB
Antenna Parameter with Body TSL	Impedance, transformed to feed point	49.35 jΩ - 8.93 jΩ
	Return Loss	-20.94 dB

After long term use with 100W radiated power, only a slight warming of the dipole near the feedpoint can be measured. The dipole is made of standard semirigid coaxial cable. The center conductor of the feeding line is directly connected to the second arm of the dipole. The antenna is therefore short-circuited for DC signals.

Additional EUT Data	
Manufactured by:	SPEAG
Manufactured on:	December 15, 2000

SAR results with Head TSL

Test Laboratory: Imst GmbH, DASY Yellow (II); File Name: [070410_y_1579.da4](#)

DUT: Dipole 835 MHz SN437; Type: D835V2; Serial: D835V2 - SN:437

Program Name: System Performance Check at 835 MHz

Communication System: CW; Frequency: 835 MHz; Duty Cycle: 1:1

Medium parameters used: $f = 835$ MHz; $\sigma = 0.91$ mho/m; $\epsilon_r = 41.1$; $\rho = 1000$ kg/m³

Phantom section: Flat Section

DASY4 Configuration:

- Probe: ET3DV6R - SN1579; ConvF(6.34, 6.34, 6.34); Calibrated: 20.01.2010

- Sensor-Surface: 4mm (Mechanical Surface Detection)

- Electronics: DAE4 Sn631; Calibrated: 14.09.2009

- Phantom: SAM Sugar 1059; Type: Speag; Serial: 1059

- Measurement SW: DASY4, V4.7 Build 80; Postprocessing SW: SEMCAD, V1.8 Build 186

d=10mm, Pin=250mW/Area Scan (7x7x1): Measurement grid: dx=15mm, dy=15mm

Maximum value of SAR (measured) = 2.80 mW/g

d=10mm, Pin=250mW/Zoom Scan (7x7x7)/Cube 0: Measurement grid: dx=5mm, dy=5mm, dz=5mm

Reference Value = 57.5 V/m; Power Drift = -0.070 dB

Peak SAR (extrapolated) = 3.77 W/kg

SAR(1 g) = 2.56 mW/g; SAR(10 g) = 1.66 mW/g

Maximum value of SAR (measured) = 2.78 mW/g

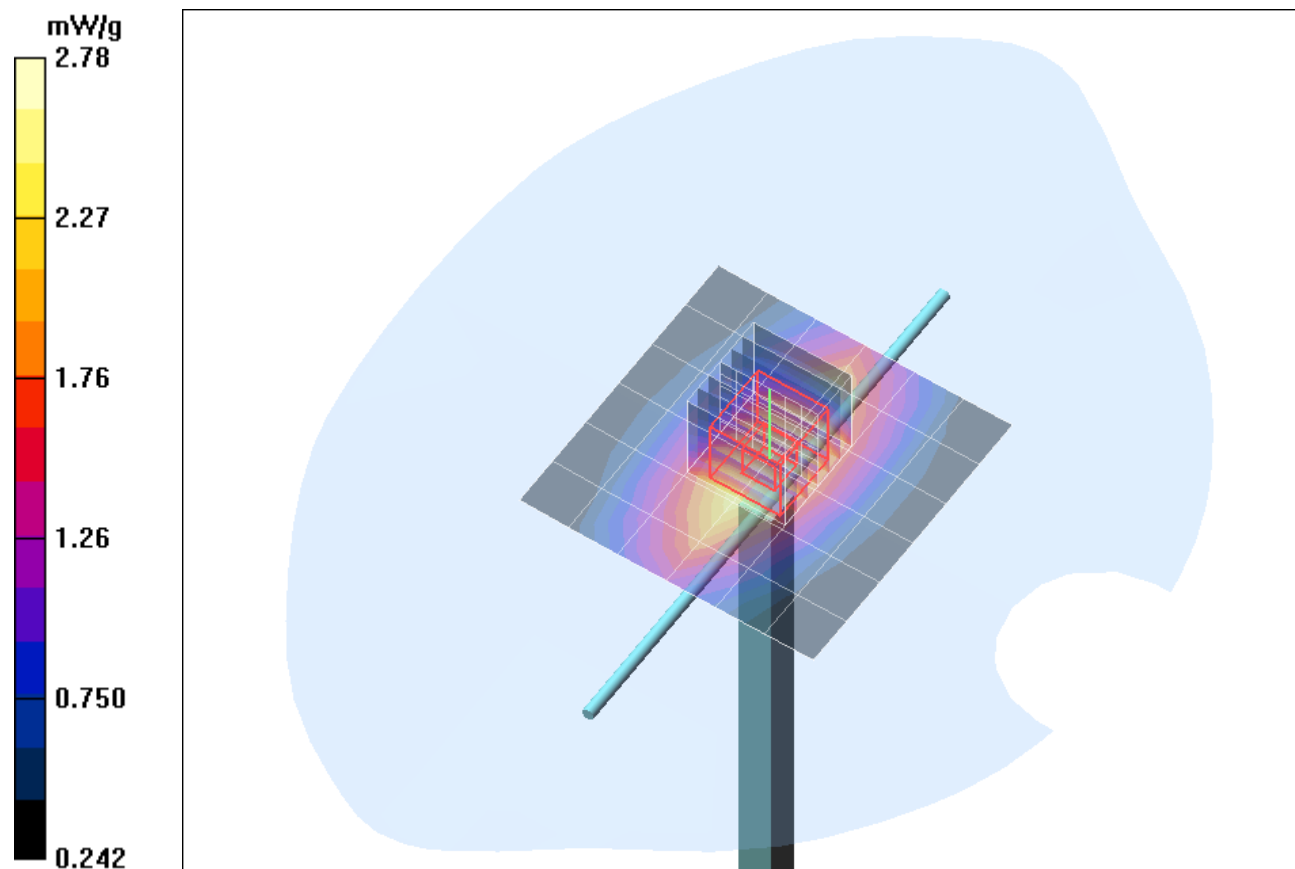

Impedance Measurements Plot for Head TSL

Tr1 S11 Smith (R+jX) scale 1.000u [F1]

>1 835.00000 MHz 46.342 Ω 4.8089 Ω 916.59 pF

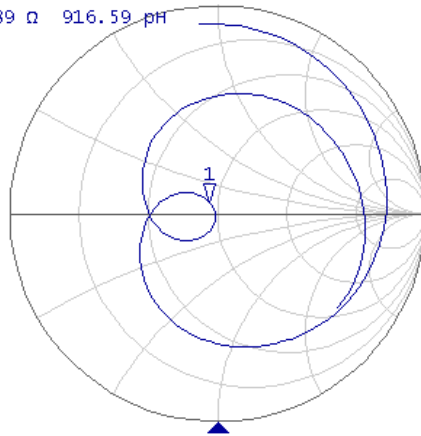

Tr2 S11 Log Mag 10.00dB/ Ref 0.000dB [F1]

>1 835.00000 MHz -24.064 dB

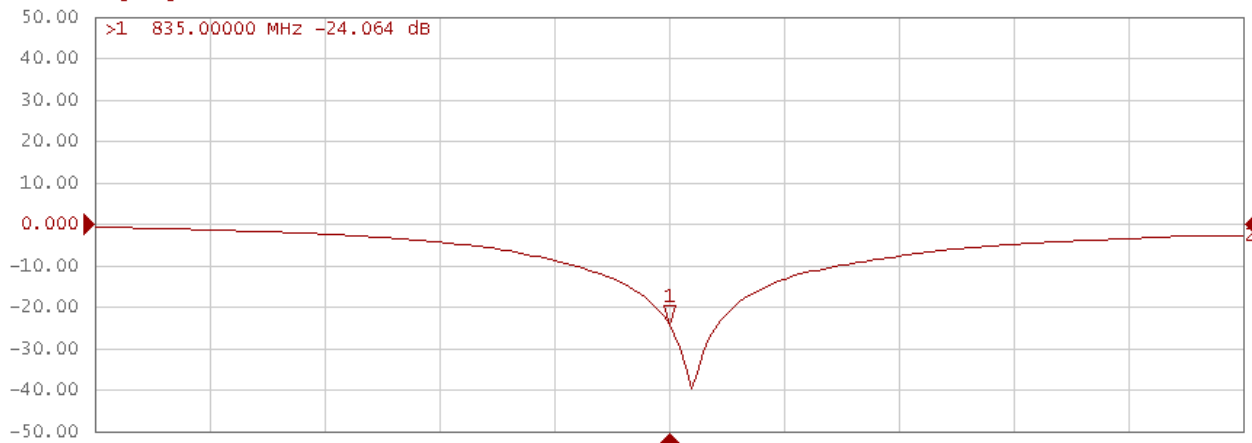

SAR results with Body TSL

Test Laboratory: IMST GmbH, DASY Blue (I); File Name: [070410_b_1579.da4](#)

DUT: Dipole 835 MHz SN437; Type: D835V2; Serial: D835V2 - SN:437

Program Name: System Performance Check at 835 MHz

Communication System: CW; Frequency: 835 MHz; Duty Cycle: 1:1
Medium parameters used: $f = 835$ MHz; $\sigma = 1$ mho/m; $\epsilon_r = 55.7$; $\rho = 1000$ kg/m³
Phantom section: Flat Section

DASY4 Configuration:

- Probe: ET3DV6R - SN1579; ConvF(6.21, 6.21, 6.21); Calibrated: 20.01.2010
- Sensor-Surface: 4mm (Mechanical Surface Detection)
- Electronics: DAE4 Sn631; Calibrated: 14.09.2009
- Phantom: SAM Sugar 1059; Type: Speag; Serial: 1059
- Measurement SW: DASY4, V4.7 Build 80; Postprocessing SW: SEMCAD, V1.8 Build 186

d=10mm, Pin=250mW/Area Scan (7x7x1): Measurement grid: dx=15mm, dy=15mm

Maximum value of SAR (measured) = 2.49 mW/g

d=10mm, Pin=250mW/Zoom Scan (7x7x7)/Cube 0: Measurement grid: dx=5mm, dy=5mm, dz=5mm

Reference Value = 52.7 V/m; Power Drift = -0.060 dB

Peak SAR (extrapolated) = 3.61 W/kg

SAR(1 g) = 2.49 mW/g; SAR(10 g) = 1.62 mW/g

Maximum value of SAR (measured) = 2.69 mW/g

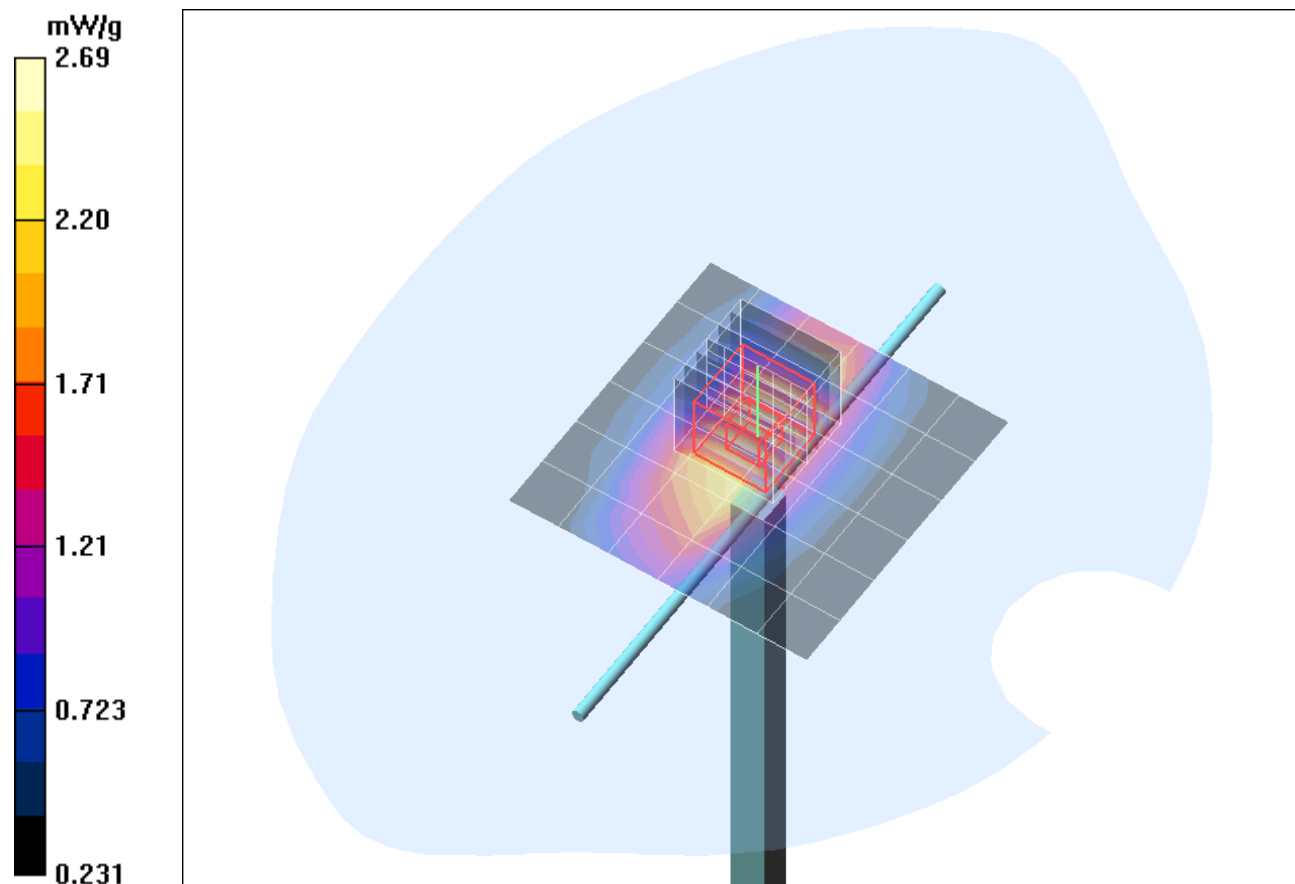

Impedance Measurements Plot for Body TSL

Tr1 S11 Smith (R+jX) scale 1.000U [F1]

>1 835.00000 MHz 49.352 Ω 8.9281 Ω 1.7017 nH

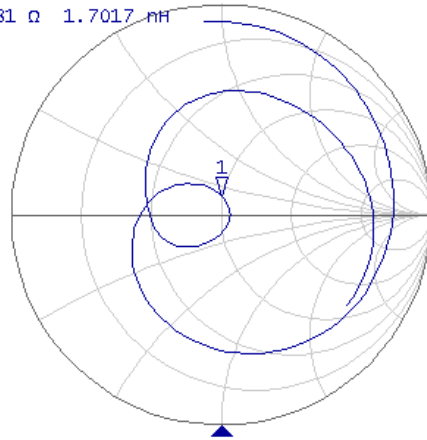

Tr2 S11 Log Mag 10.00dB/ Ref 0.000dB [F1]

>1 835.00000 MHz -20.941 dB

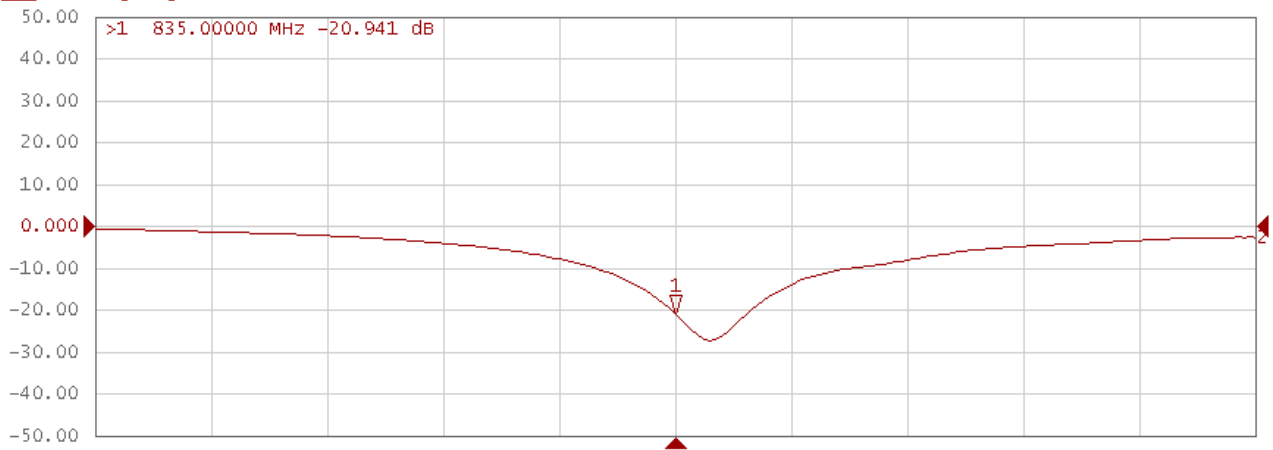

DAT-P-152/98-01

Calibration Certificate

Certificate No: Cal_D1900V2_SN5d051_0909
 Object: D1900V2 SN: 5d051
 Date of Calibration: September 09, 2009
 Next Calibration: September 2011
 Object Condition: In Tolerance

Calibration Equipment used:

Test Equipment	Serial Number	Last calibration	Calibrated by	Next calibration
Powermeter E4416A	GB41050414	Dec 08	Agilent Techn. (ISO/IEC 17025, 1-1784162174-1)	Dec 10
Power Sensor E9301H	US40010212	Dec 08	Agilent Techn. (ISO/IEC 17025, 1-1784041195-1)	Dec 10
Powermeter E4417A	GB41050441	Dec 08	Agilent Techn. (ISO/IEC 17025, 1-1674038198-1)	Dec 10
Power Sensor E9301A	MY41495584	Dec 08	Agilent Techn. (ISO/IEC 17025, 1-1784041307-1)	Dec 10
Network Analyzer E5071C	MY46103220	Aug 09	Rohde& Schwarz (14967-DKD-00201- 2009-08)	Aug 10
Reference Probe ET3DV6	SN 1669	Feb 09	SPEAG, No ET3- 1669_Feb09	Feb 10
DAE3	SN 335	Feb 09	SPEAG, No DAE3- 335_Feb09	Feb 10

Calibration is performed according the following standards:**IEEE 1528-2003**

"IEEE Recommended Practice for Determining the Peak Spatial - Averaged Specific Absorption Rate (SAR) in the Human Head from Wireless Communication Devices: Measurement Technique", December 2003

IEC 62209-1

"Procedure to measure the Specific Absorption Rate (SAR) for hand - held devices used in close proximity to the ear (frequency range of 300 MHz to 3GHz)", February 2005

Federal Communications Commission Office of Engineering & Technologies (FCCOET)

"Evaluating Compliance with FCC Guidelines for Human Exposure to Radiofrequency Electromagnetic Fields; Additional Information for Evaluating Compliance of Mobile and Portable Devices with FCC Limits for Human Exposure to Radiofrequency Emissions", Supplement C (Edition 01-01) to Bulletin 65

Additional Documentation: DASY 4 System Handbook

prepared by:



Alexander Rahn
test engineer

reviewed by:

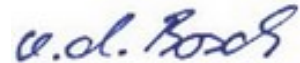

André van den Bosch
quality assurance engineer

Measurement Conditions		
DASY Version:	Dasy 4;	V4.7
Phantom:	SAM Phantom	1340
Distance Dipole Center – TSL:	10mm	With spacer
Zoom Scan res.	dx, dy, dz = 5mm	
Frequency:	1900 MHz \pm 1MHz	

Head TSL Parameters			
	Temperature	Permittivity	Conductivity
Nominal Head TSL Parameters	22.0	40.0	1.40
Measured Head TSL Parameters	22.0	40.3 \pm 6%	1.45 S/m \pm 6%

SAR result with Head TSL			
Averaged over 1g	SAR measured	250mW input power	9.10 mW/g
	SAR normalized	normalized to 1W	36.40 mW/g
	SAR for nominal Head TSL parameters	normalized to 1W	35.90 mW/g \pm 16.5 % (k=2)
Averaged over 10g	SAR measured	250mW input power	4.76 mW/g
	SAR normalized	normalized to 1W	19.04 mW/g
	SAR for nominal Head TSL parameters	normalized to 1W	18.96 mW/g \pm 16.5 % (k=2)

Body TSL Parameters			
	Temperature	Permittivity	Conductivity
Nominal Body TSL Parameters	22.0	53.30	1.52
Measured Body TSL Parameters	22.0	52.90 ± 6%	1.54 S/m ± 6%

SAR result with Body TSL			
Averaged over 1g	SAR measured	250mW input power	9.42 mW/g
	SAR normalized	normalized to 1W	37.68 mW/g
	SAR for nominal Body TSL parameters	normalized to 1W	37.28 mW/g ± 16.5 % (k=2)
Averaged over 10g	SAR measured	250mW input power	4.97 mW/g
	SAR normalized	normalized to 1W	19.88 mW/g
	SAR for nominal Body TSL parameters	normalized to 1W	19.77 mW/g ± 16.5 % (k=2)

General Antenna Parameters		
Antenna Parameters with Head TSL	Impedance, transformed to feed point	48.2 jΩ - 1.3 jΩ
	Return Loss	-33.0 dB
Antenna Parameter with Body TSL	Impedance, transformed to feed point	53.9 jΩ - 0.4 jΩ
	Return Loss	-28.3 dB

After long term use with 100W radiated power, only a slight warming of the dipole near the feedpoint can be measured. The dipole is made of standard semirigid coaxial cable. The center conductor of the feeding line is directly connected to the second arm of the dipole. The antenna is therefore short-circuited for DC signals.

Additional EUT Data	
Manufactured by:	SPEAG
Manufactured on:	January 15, 1998

SAR result with Head TSL

Test Laboratory: IMST GmbH, DASY Blue (I); File Name: [090909_b_1669.da4](#)

DUT: Dipole 1900 MHz SN: 5d051; Type: D1900V2; Serial: D1900V2 - SN5d051

Program Name: System Performance Check at 1900 MHz

Communication System: CW; Frequency: 1900 MHz; Duty Cycle: 1:1

Medium parameters used: $f = 1900$ MHz; $\sigma = 1.45$ mho/m; $\epsilon_r = 40.3$; $\rho = 1000$ kg/m³

Phantom section: Flat Section

DASY4 Configuration:

- Probe: ET3DV6R - SN1669; ConvF(5.11, 5.11, 5.11); Calibrated: 10.02.2009

- Sensor-Surface: 4mm (Mechanical Surface Detection)

- Electronics: DAE3 Sn335; Calibrated: 09.02.2009

- Phantom: SAM Glycol 1176; Type: Speag; Serial: 1176

- Measurement SW: DASY4, V4.7 Build 80; Postprocessing SW: SEMCAD, V1.8 Build 186

d=10mm, Pin=250mW/Area Scan (7x7x1): Measurement grid: dx=10mm, dy=10mm

Maximum value of SAR (measured) = 10.4 mW/g

d=10mm, Pin=250mW/Zoom Scan (7x7x7)/Cube 0: Measurement grid: dx=5mm, dy=5mm, dz=5mm

Reference Value = 91.3 V/m; Power Drift = -0.152 dB

Peak SAR (extrapolated) = 15.9 W/kg

SAR(1 g) = 9.1 mW/g; SAR(10 g) = 4.76 mW/g

Maximum value of SAR (measured) = 10.3 mW/g

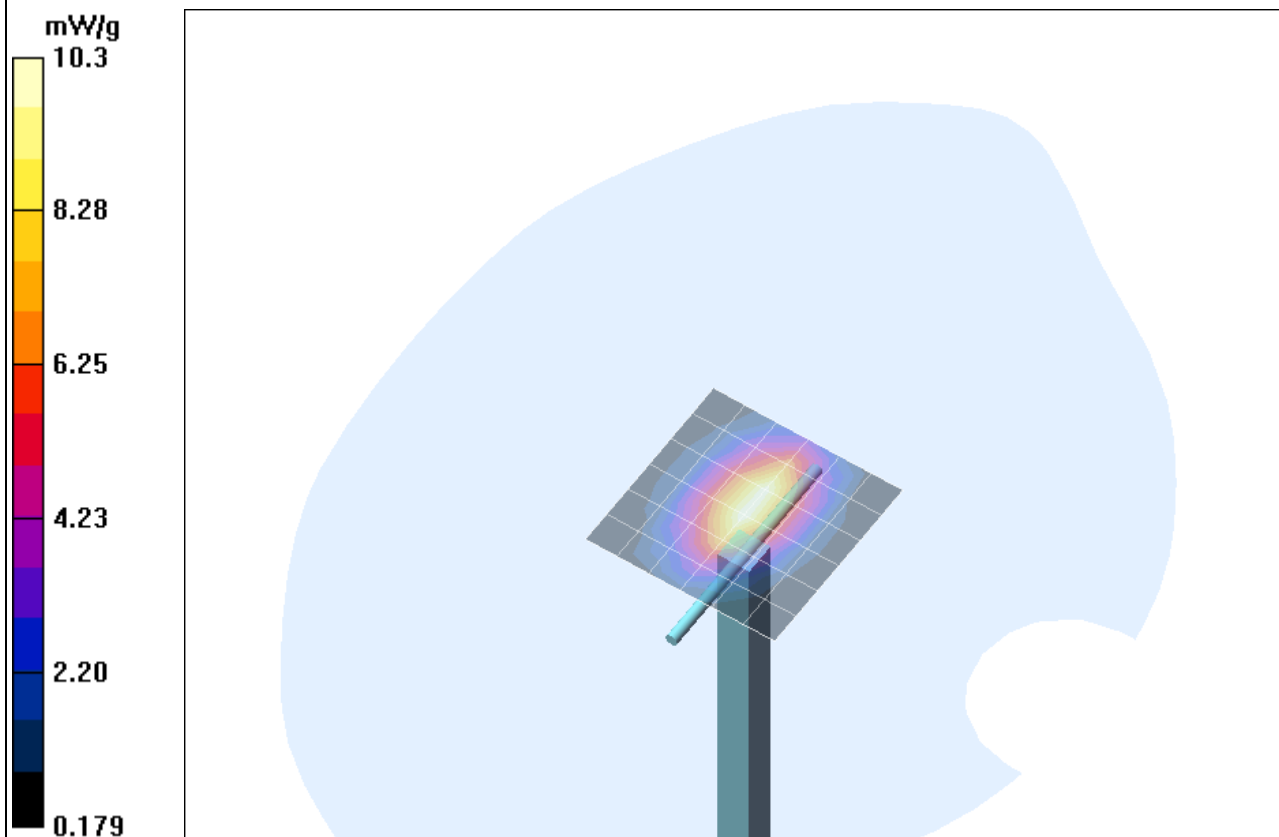

SAR result with Body TSL

Test Laboratory: IMST GmbH, DASY Blue (I); File Name: [090909_b_1669.da4](#)

DUT: Dipole 1900 MHz SN: 5d051; Type: D1900V2; Serial: D1900V2 - SN5d051
Program Name: System Performance Check at 1900 MHz

Communication System: CW; Frequency: 1900 MHz; Duty Cycle: 1:1
Medium parameters used: $f = 1900$ MHz; $\sigma = 1.54$ mho/m; $\epsilon_r = 52.9$; $\rho = 1000$ kg/m³
Phantom section: Flat Section

DASY4 Configuration:

- Probe: ET3DV6R - SN1669; ConvF(4.69, 4.69, 4.69); Calibrated: 10.02.2009
- Sensor-Surface: 4mm (Mechanical Surface Detection)
- Electronics: DAE3 Sn335; Calibrated: 09.02.2009
- Phantom: SAM Glycol 1176; Type: Speag; Serial: 1176
- Measurement SW: DASY4, V4.7 Build 80; Postprocessing SW: SEMCAD, V1.8 Build 186

d=10mm, Pin=250mW/Area Scan (7x7x1): Measurement grid: dx=10mm, dy=10mm

Maximum value of SAR (measured) = 10.1 mW/g

d=10mm, Pin=250mW/Zoom Scan (7x7x7)/Cube 0: Measurement grid: dx=5mm, dy=5mm, dz=5mm

Reference Value = 86.1 V/m; Power Drift = -0.064 dB

Peak SAR (extrapolated) = 16.5 W/kg

SAR(1 g) = 9.42 mW/g; SAR(10 g) = 4.97 mW/g

Maximum value of SAR (measured) = 10.7 mW/g

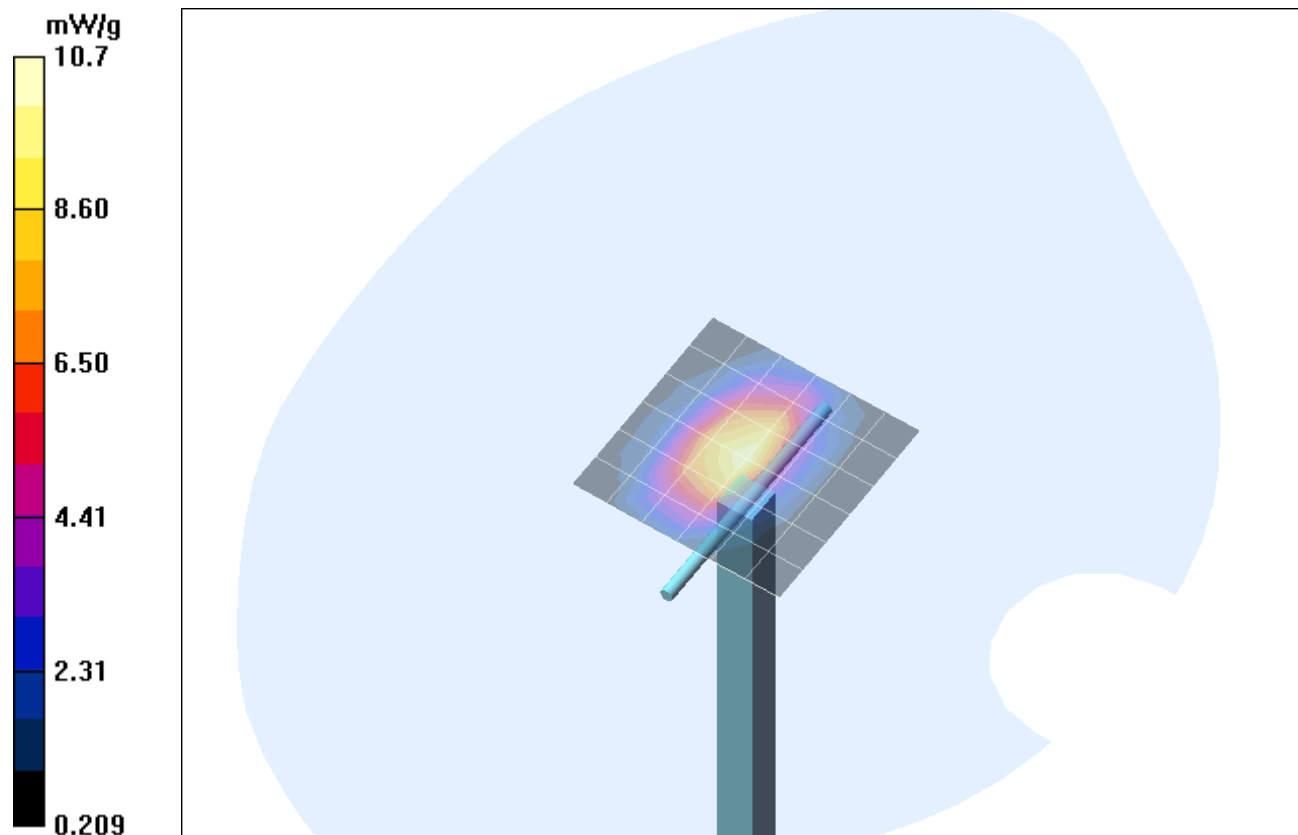

Impedance Measurements Plot for Head TSL

Tr1 S11 Log Mag 10.00dB/ Ref 0.000dB [F1]

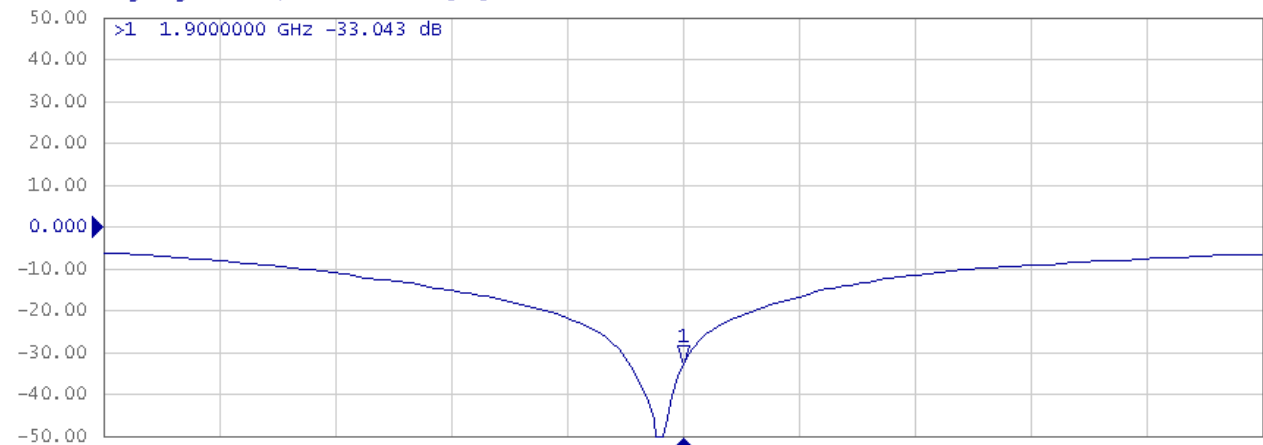

▶ Tr2 S11 Smith (R+jX) Scale 1.000U [F1]

>1 1.9000000 GHz 48.267 Ω -1.3384 Ω 62.586 pF

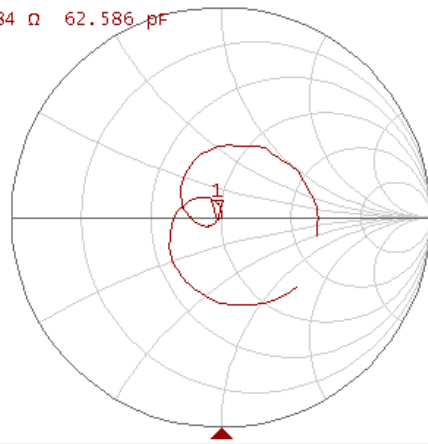

Impedance Measurements Plot for Body TSL

Tr1 S11 Log Mag 10.00dB/ Ref 0.000dB [F1]

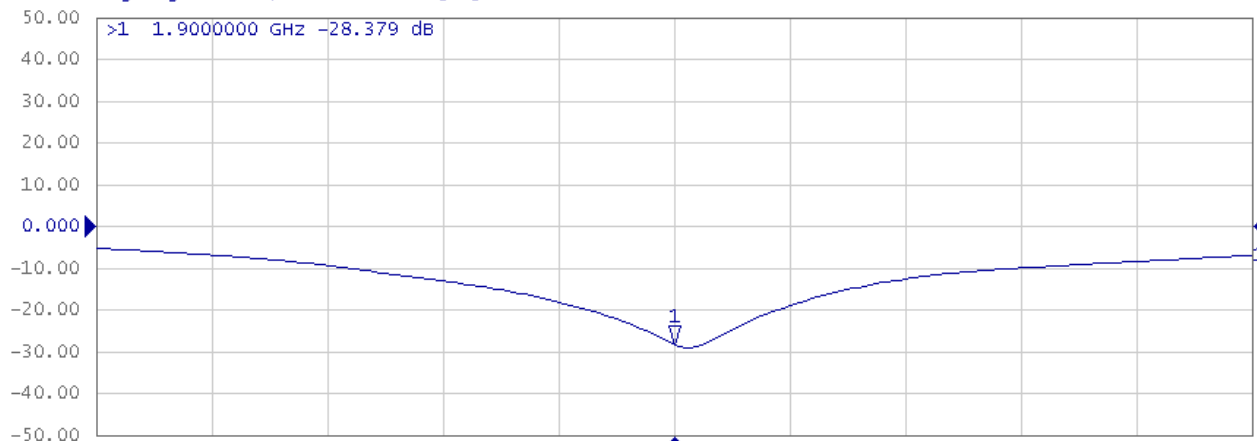

Tr2 S11 Smith (R+jX) scale 1.000u [F1]

>1 1.9000000 GHz 53.938 Ω -425.83 m Ω 196.71 pF

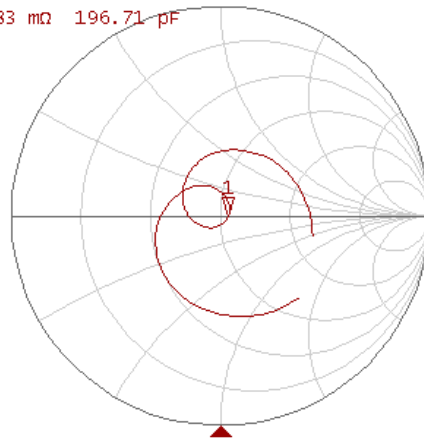

The Testcenter facility 'Dosimetric Test Lab' within IMST GmbH is accredited by the German National 'Deutsche Akkreditierungsstelle GmbH (DAkkS)' for testing according to the scope as listed in the accreditation certificate: D-PL-12139-01-01.

Calibration Certificate

Certificate No: Cal_D1900V2_SN5d051_Sep2011
 Object: D1900V2 SN: 5d051
 Date of Calibration: September 30, 2011
 Next Calibration: September 2013
 Object Condition: In Tolerance

Calibration Equipment used:

Test Equipment	Serial Number	Last calibration	Calibrated by	Next calibration
Powermeter E4416A	GB41050414	Dec 10	Agilent Techn. (ISO/IEC 17025, 1-1784162174-1)	Dec 12
Power Sensor E9301H	US40010212	Dec 10	Agilent Techn. (ISO/IEC 17025, 1-1784041195-1)	Dec 12
Powermeter E4417A	GB41050441	Dec 10	Agilent Techn. (ISO/IEC 17025, 1-1674038198-1)	Dec 12
Power Sensor E9301A	MY41495584	Dec 10	Agilent Techn. (ISO/IEC 17025, 1-1784041307-1)	Dec 12
Network Analyzer E5071C	MY46103220	Aug 11	Rohde& Schwarz (14967-DKD-00201- 2009-08)	Aug 12
Reference Probe ET3DV6	SN 1669	Feb 11	SPEAG, No ET3- 1669_Feb09	Feb 12
DAE3	SN 335	Feb 11	SPEAG, No DAE3- 335_Feb09	Feb 12

Calibration is performed according the following standards:**IEEE 1528-2003**

"IEEE Recommended Practice for Determining the Peak Spatial - Averaged Specific Absorption Rate (SAR) in the Human Head from Wireless Communication Devices: Measurement Technique", December 2003

EN 62209-1

"Procedure to measure the Specific Absorption Rate (SAR) for hand - held devices used in close proximity to the ear (frequency range of 300 MHz to 3GHz)", March 2007

Federal Communications Commission Office of Engineering & Technologies (FCCOET)

"Evaluating Compliance wit FCC Guidelines for Human Exposure to Radiofrequency Electromagnetic Fields; Additional Information for Evaluating Compliance of Mobile and Portable Devices with FCC Limits for Human Exposure to Radiofrequency Emissions", Supplement C (Edition 01-01) to Bulletin 65

Additional Documentation: DASY 4 System Handbook

prepared by:



Alexander Rahn
test engineer

reviewed by:



André van den Bosch
quality assurance engineer

Measurement Conditions		
DASY Version:	Dasy 4;	V4.7
Phantom:	SAM Phantom	1340
Distance Dipole Center – TSL:	10mm	With spacer
Zoom Scan res.	dx, dy, dz = 5mm	
Frequency:	1900 MHz \pm 1MHz	

Head TSL Parameters			
	Temperature	Permittivity	Conductivity
Nominal Head TSL Parameters	22.0	40.0	1.40
Measured Head TSL Parameters	22.8	39.4 \pm 6%	1.43 S/m \pm 6%

SAR Result with Head TSL			
Averaged over 1g	SAR measured	250mW input power	9.53 mW/g
	SAR normalized	normalized to 1W	38.12 mW/g
	SAR for nominal Head TSL parameters	normalized to 1W	37.51 mW/g \pm 16.5 % (k=2)
Averaged over 10g	SAR measured	250mW input power	4.93 mW/g
	SAR normalized	normalized to 1W	19.72 mW/g
	SAR for nominal Head TSL parameters	normalized to 1W	19.52 mW/g \pm 16.5 % (k=2)

Body TSL Parameters			
	Temperature	Permittivity	Conductivity
Nominal Body TSL Parameters	22.0	53.30	1.52
Measured Body TSL Parameters	23.3	52.10 ± 6%	1.54 S/m ± 6%

SAR Result with Body TSL			
Averaged over 1g	SAR measured	250mW input power	9.66 mW/g
	SAR normalized	normalized to 1W	38.64 mW/g
	SAR for nominal Body TSL parameters	normalized to 1W	38.14 mW/g ± 16.5 % (k=2)
Averaged over 10g	SAR measured	250mW input power	5.10 mW/g
	SAR normalized	normalized to 1W	20.40 mW/g
	SAR for nominal Body TSL parameters	normalized to 1W	20.23 mW/g ± 16.5 % (k=2)

General Antenna Parameters		
Antenna Parameters with Head TSL	Impedance, transformed to feed point	48.4 jΩ - 0.7 jΩ
	Return Loss	-35.2 dB
Antenna Parameter with Body TSL	Impedance, transformed to feed point	52.8 jΩ - 1.8 jΩ
	Return Loss	-29.9 dB

After long term use with 100W radiated power, only a slight warming of the dipole near the feedpoint can be measured. The dipole is made of standard semigrd coaxial cable. The center conductor of the feeding line is directly connected to the second arm of the dipole. The antenna is therefore short-circuited for DC signals.

Additional EUT Data	
Manufactured by:	SPEAG
Manufactured on:	January 15, 1998

SAR Result with Head TSL

Test Laboratory: Imst GmbH, DASYS Yellow (II); File Name: [300911_y_1669.da4](#)

DUT: Dipole 1900 MHz SN: 5d051; Type: D1900V2; Serial: D1900V2 - SN5d051
Program Name: System Performance Check at 1900 MHz

Communication System: CW; Frequency: 1900 MHz; Duty Cycle: 1:1
Medium parameters used: $f = 1900$ MHz; $\sigma = 1.43$ mho/m; $\epsilon_r = 39.4$; $\rho = 1000$ kg/m³
Phantom section: Flat Section

DASY4 Configuration:

- Probe: ET3DV6R - SN1669; ConvF(5.12, 5.12, 5.12); Calibrated: 21.02.2011
- Sensor-Surface: 4mm (Mechanical Surface Detection)
- Electronics: DAE3 Sn335; Calibrated: 22.02.2011
- Phantom: SAM Glycol 1340; Type: QD 000 P40 CB; Serial: TP-1340
- Measurement SW: DASY4, V4.7 Build 80; Postprocessing SW: SEMCAD, V1.8 Build 186

d=10mm, Pin=250mW/Area Scan (7x7x1): Measurement grid: dx=10mm, dy=10mm

Maximum value of SAR (measured) = 10.4 mW/g

d=10mm, Pin=250mW/Zoom Scan (7x7x7)/Cube 0: Measurement grid: dx=5mm, dy=5mm, dz=5mm

Reference Value = 90.3 V/m; Power Drift = -0.025 dB

Peak SAR (extrapolated) = 17.0 W/kg

SAR(1 g) = 9.53 mW/g; SAR(10 g) = 4.93 mW/g

Maximum value of SAR (measured) = 10.7 mW/g

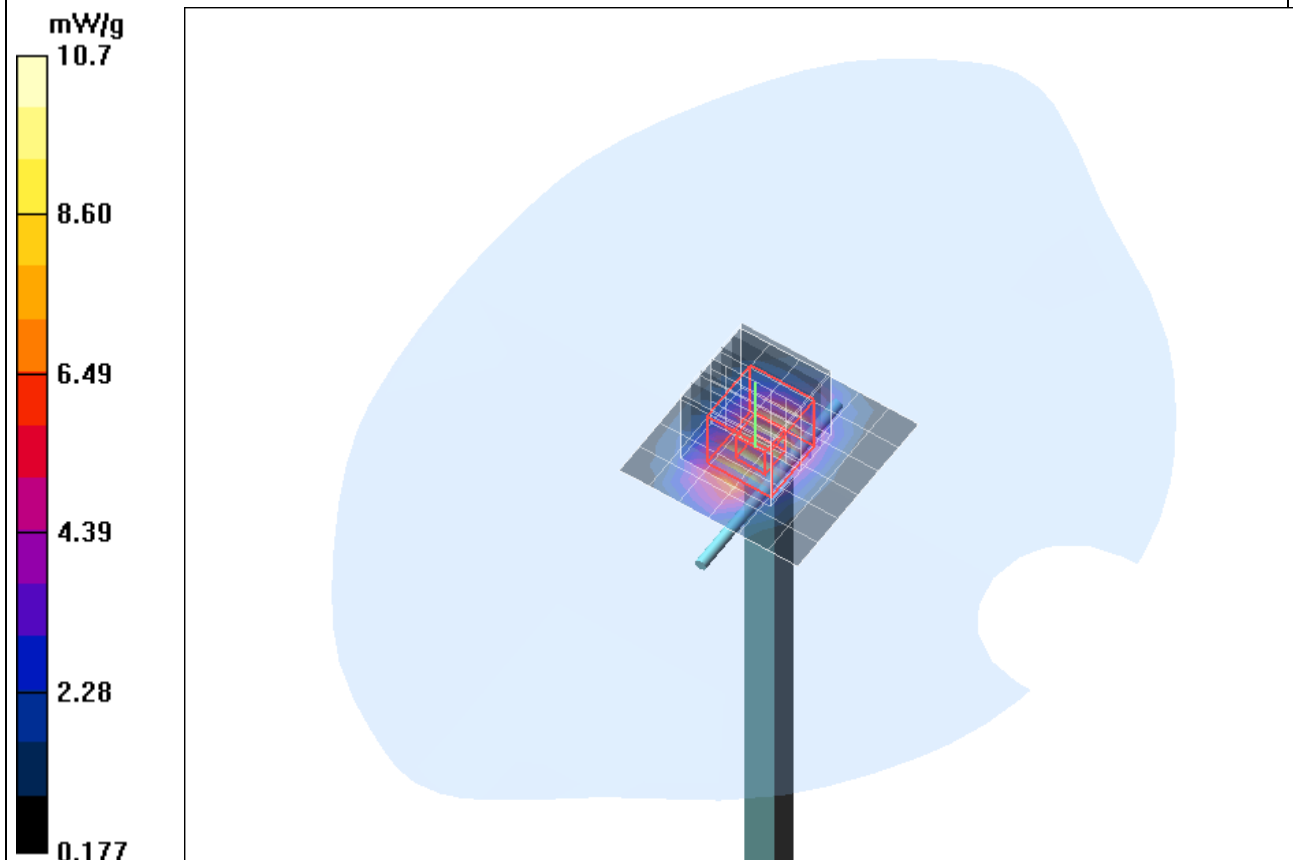

SAR Result with Body TSL

Test Laboratory: Imst GmbH, DASY Yellow (II); File Name: [300911_y_1669.da4](#)

DUT: Dipole 1900 MHz SN: 5d051; Type: D1900V2; Serial: D1900V2 - SN5d051
Program Name: System Performance Check at 1900 MHz

Communication System: CW; Frequency: 1900 MHz; Duty Cycle: 1:1
Medium parameters used: $f = 1900$ MHz; $\sigma = 1.54$ mho/m; $\epsilon_r = 52.1$; $\rho = 1000$ kg/m³
Phantom section: Flat Section

DASY4 Configuration:

- Probe: ET3DV6R - SN1669; ConvF(4.54, 4.54, 4.54); Calibrated: 21.02.2011
- Sensor-Surface: 4mm (Mechanical Surface Detection)
- Electronics: DAE3 Sn335; Calibrated: 22.02.2011
- Phantom: SAM Glycol 1340; Type: QD 000 P40 CB; Serial: TP-1340
- Measurement SW: DASY4, V4.7 Build 80; Postprocessing SW: SEMCAD, V1.8 Build 186

d=10mm, Pin=250mW/Area Scan (7x7x1): Measurement grid: dx=10mm, dy=10mm

Maximum value of SAR (measured) = 10.6 mW/g

d=10mm, Pin=250mW/Zoom Scan (7x7x7)/Cube 0: Measurement grid: dx=5mm, dy=5mm, dz=5mm

Reference Value = 89.6 V/m; Power Drift = 0.004 dB

Peak SAR (extrapolated) = 16.3 W/kg

SAR(1 g) = 9.66 mW/g; SAR(10 g) = 5.1 mW/g

Maximum value of SAR (measured) = 11.0 mW/g

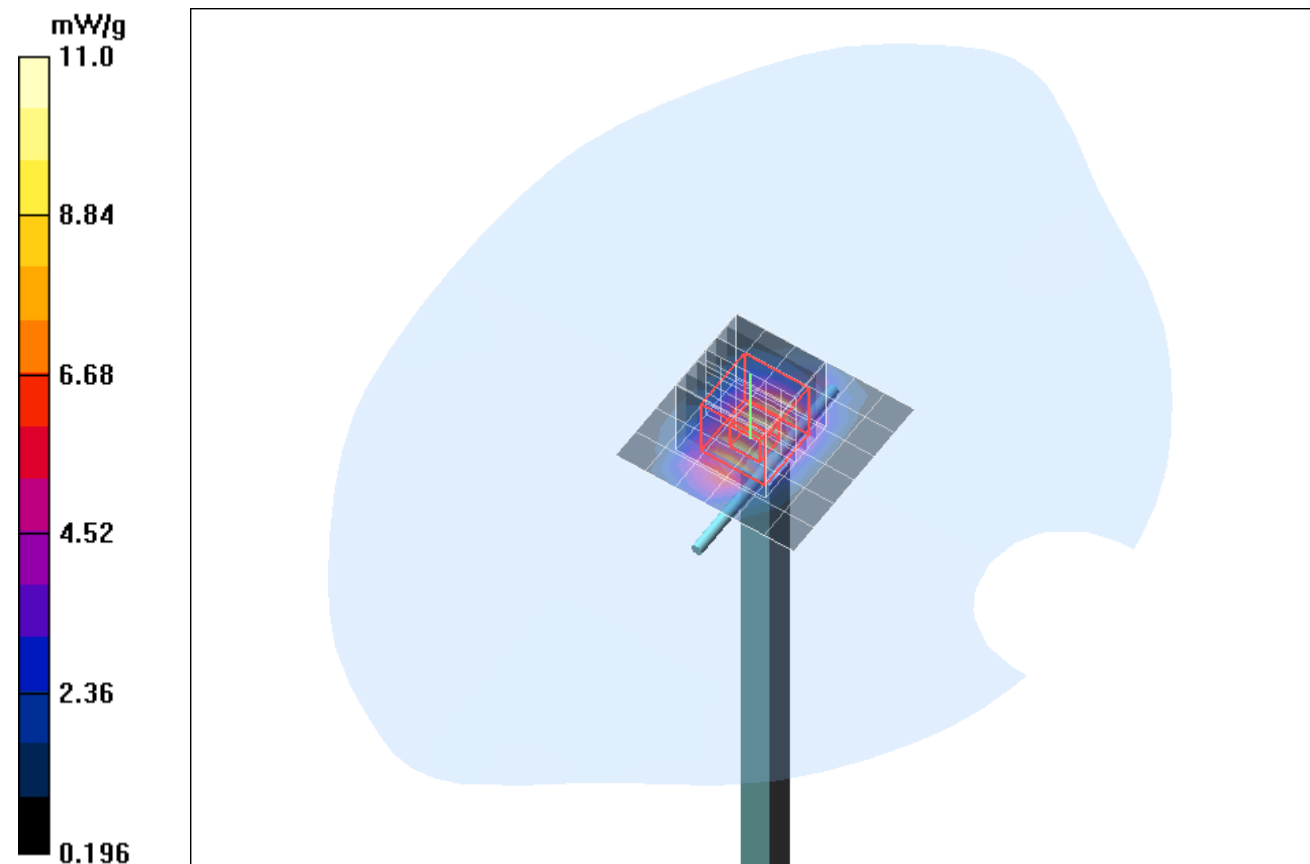

Impedance Measurements Plot for Head TSL

>1 1.9000000 GHz 48.454 Ω -710.06 m Ω 117.97 pF

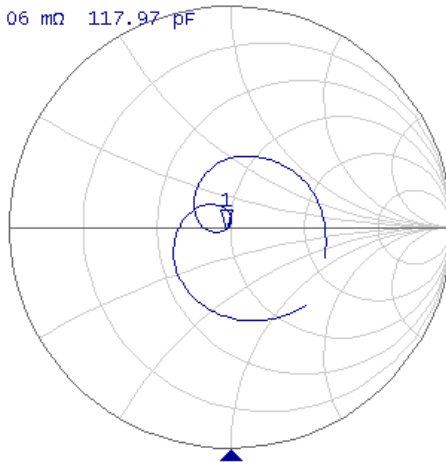

Tr2 S11 Log Mag 10.00dB/ Ref 0.000dB [F1]

>1 1.9000000 GHz -35.250 dB

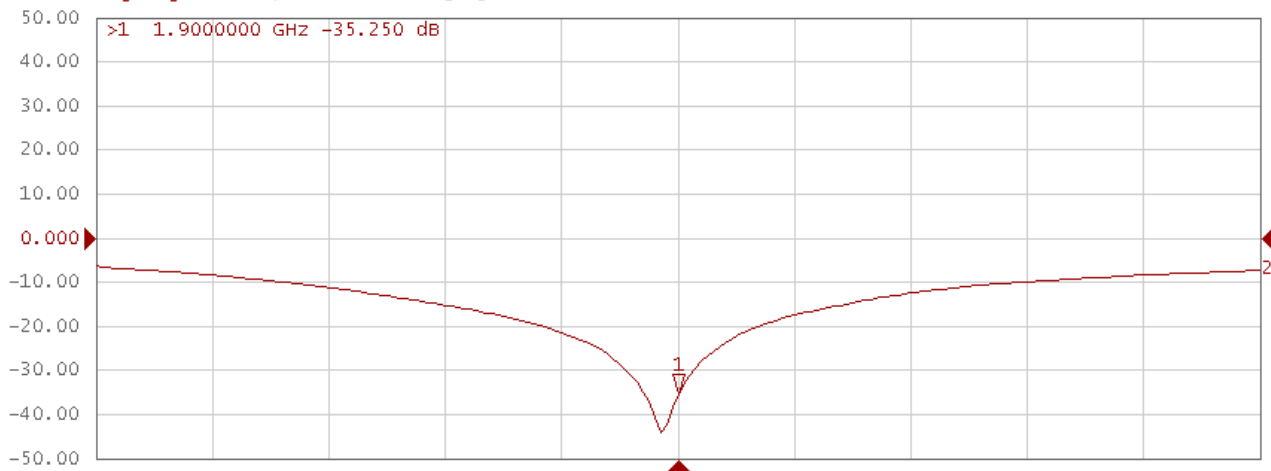

Impedance Measurements Plot for Body TSL

>1 1.9000000 GHz 52.766 Ω -1.7748 Ω 47.198 pF

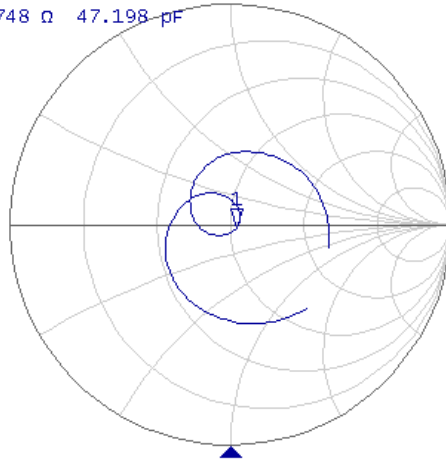

Tr2 S11 Log Mag 10.00dB/ Ref 0.000dB [F1]

>1 1.9000000 GHz -29.904 dB

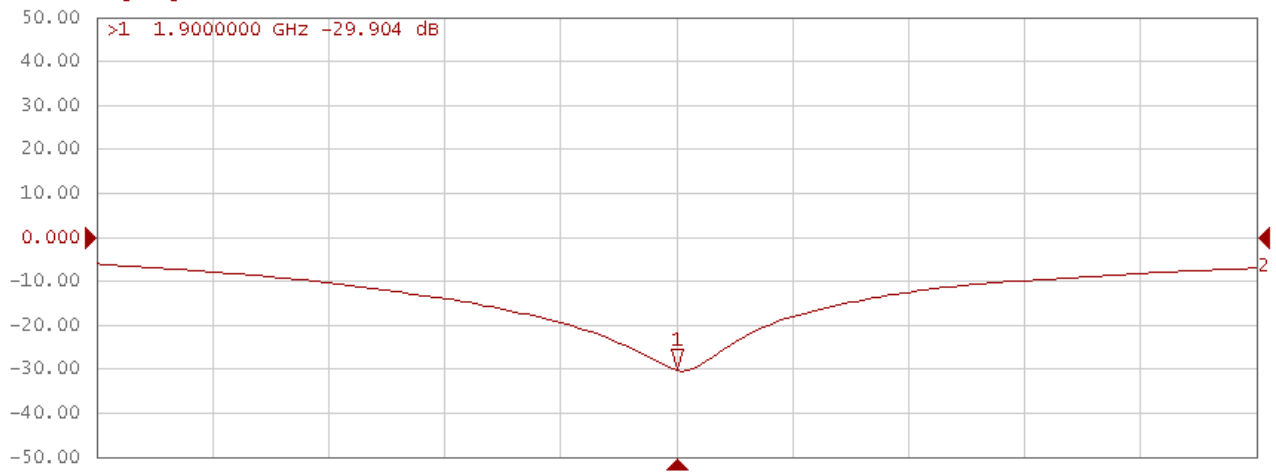

DAT-P-152/98-01

Calibration Certificate

Certificate No: Cal_D2450V2_SN709_1209
 Object: D2450V2 SN: 709
 Date of Calibration: December 09, 2009
 Next Calibration: December 2011
 Object Condition: In Tolerance

Calibration Equipment used:

Test Equipment	Serial Number	Last calibration	Calibrated by	Next calibration
Powermeter E4416A	GB41050414	Dec 08	Agilent Techn. (ISO/IEC 17025, 1-1784162174-1)	Dec 10
Power Sensor E9301H	US40010212	Dec 08	Agilent Techn. (ISO/IEC 17025, 1-1784041195-1)	Dec 10
Powermeter E4417A	GB41050441	Dec 08	Agilent Techn. (ISO/IEC 17025, 1-1674038198-1)	Dec 10
Power Sensor E9301A	MY41495584	Dec 08	Agilent Techn. (ISO/IEC 17025, 1-1784041307-1)	Dec 10
Network Analyzer E5071C	MY46103220	Aug 09	Rohde& Schwarz (14967-DKD-00201- 2009-08)	Aug 10
Reference Probe EX3DV4	SN 3536	Sep 09	SPEAG, No EX- 3536_Sep09	Sep 10
DAE4	SN 661	Sep 09	SPEAG, No DAE4- 661_Sep09	Sep 10

Calibration is performed according the following standards:**IEEE 1528-2003**

"IEEE Recommended Practice for Determining the Peak Spatial - Averaged Specific Absorption Rate (SAR) in the Human Head from Wireless Communication Devices: Measurement Technique", December 2003

IEC 62209-1

"Procedure to measure the Specific Absorption Rate (SAR) for hand - held devices used in close proximity to the ear (frequency range of 300 MHz to 3GHz)", February 2005

Federal Communications Commission Office of Engineering & Technologies (FCCOET)

"Evaluating Compliance with FCC Guidelines for Human Exposure to Radiofrequency Electromagnetic Fields; Additional Information for Evaluating Compliance of Mobile and Portable Devices with FCC Limits for Human Exposure to Radiofrequency Emissions", Supplement C (Edition 01-01) to Bulletin 65

Additional Documentation: DASY 4 System Handbook

prepared by:



Alexander Rahn
test engineer

reviewed by:



André van den Bosch
quality assurance engineer

Measurement Conditions		
DASY Version:	Dasy 4;	V4.7
Phantom:	SAM Phantom	1341
Distance Dipole Center – TSL:	10mm	With spacer
Zoom Scan res.	dx, dy, dz = 5mm	
Frequency:	2450 MHz ± 1MHz	

Head TSL Parameters			
	Temperature	Permittivity	Conductivity
Nominal Head TSL Parameters	22.0	39.20	1.80
Measured Head TSL Parameters	22.0	40.2 ± 6%	1.84 S/m ± 6%

SAR result with Head TSL			
Averaged over 1g	SAR measured	250mW input power	13.60 mW/g
	SAR normalized	normalized to 1W	54.40 mW/g
	SAR for nominal Head TSL parameters	normalized to 1W	54.58 mW/g ± 16.5 % (k=2)
Averaged over 10g	SAR measured	250mW input power	6.16 mW/g
	SAR normalized	normalized to 1W	24.64 mW/g
	SAR for nominal Head TSL parameters	normalized to 1W	24.78 mW/g ± 16.5 % (k=2)

Body TSL Parameters			
	Temperature	Permittivity	Conductivity
Nominal Body TSL Parameters	22.0	52.70	1.95
Measured Body TSL Parameters	22.0	51.70 ± 6%	2.00 S/m ± 6%

SAR result with Body TSL			
Averaged over 1g	SAR measured	250mW input power	13.20 mW/g
	SAR normalized	normalized to 1W	52.80 mW/g
	SAR for nominal Body TSL parameters	normalized to 1W	51.76 mW/g ± 16.5 % (k=2)
Averaged over 10g	SAR measured	250mW input power	6.01 mW/g
	SAR normalized	normalized to 1W	24.04 mW/g
	SAR for nominal Body TSL parameters	normalized to 1W	23.81 mW/g ± 16.5 % (k=2)

General Antenna Parameters		
Antenna Parameters with Head TSL	Impedance, transformed to feed point	49.7 jΩ - 1.23 jΩ
	Return Loss	-37.97 dB
Antenna Parameter with Body TSL	Impedance, transformed to feed point	50.8 jΩ - 1.27 jΩ
	Return Loss	-36.55 dB

After long term use with 100W radiated power, only a slight warming of the dipole near the feedpoint can be measured. The dipole is made of standard semirigid coaxial cable. The center conductor of the feeding line is directly connected to the second arm of the dipole. The antenna is therefore short-circuited for DC signals.

Additional EUT Data	
Manufactured by:	SPEAG
Manufactured on:	July 5, 2002

SAR result with Head TSL

Test Laboratory: Imst GmbH, DASY Yellow (II); File Name: [091209_y_3536.da4](#)

DUT: Dipole 2450 MHz SN: 709; Type: D2450V2; Serial: D2450V2 - SN:709

Program Name: System Performance Check at 2450 MHz

Communication System: CW; Frequency: 2450 MHz; Duty Cycle: 1:1

Medium parameters used: $f = 2450$ MHz; $\sigma = 1.84$ mho/m; $\epsilon_r = 40.2$; $\rho = 1000$ kg/m³

Phantom section: Flat Section

DASY4 Configuration:

- Probe: EX3DV4 - SN3536; ConvF(7.59, 7.59, 7.59); Calibrated: 18.09.2009

- Sensor-Surface: 4mm (Mechanical Surface Detection)

- Electronics: DAE4 Sn631; Calibrated: 14.09.2009

- Phantom: SAM Glycol 1340; Type: QD 000 P40 CB; Serial: TP-1340

- Measurement SW: DASY4, V4.7 Build 80; Postprocessing SW: SEMCAD, V1.8 Build 186

d=10mm, Pin=250mW/Area Scan (7x7x1): Measurement grid: dx=10mm, dy=10mm

Maximum value of SAR (measured) = 15.3 mW/g

d=10mm, Pin=250mW/Zoom Scan (7x7x7)/Cube 0: Measurement grid: dx=5mm, dy=5mm, dz=5mm

Reference Value = 91.4 V/m; Power Drift = 0.016 dB

Peak SAR (extrapolated) = 29.6 W/kg

SAR(1 g) = 13.6 mW/g; SAR(10 g) = 6.16 mW/g

Maximum value of SAR (measured) = 15.2 mW/g

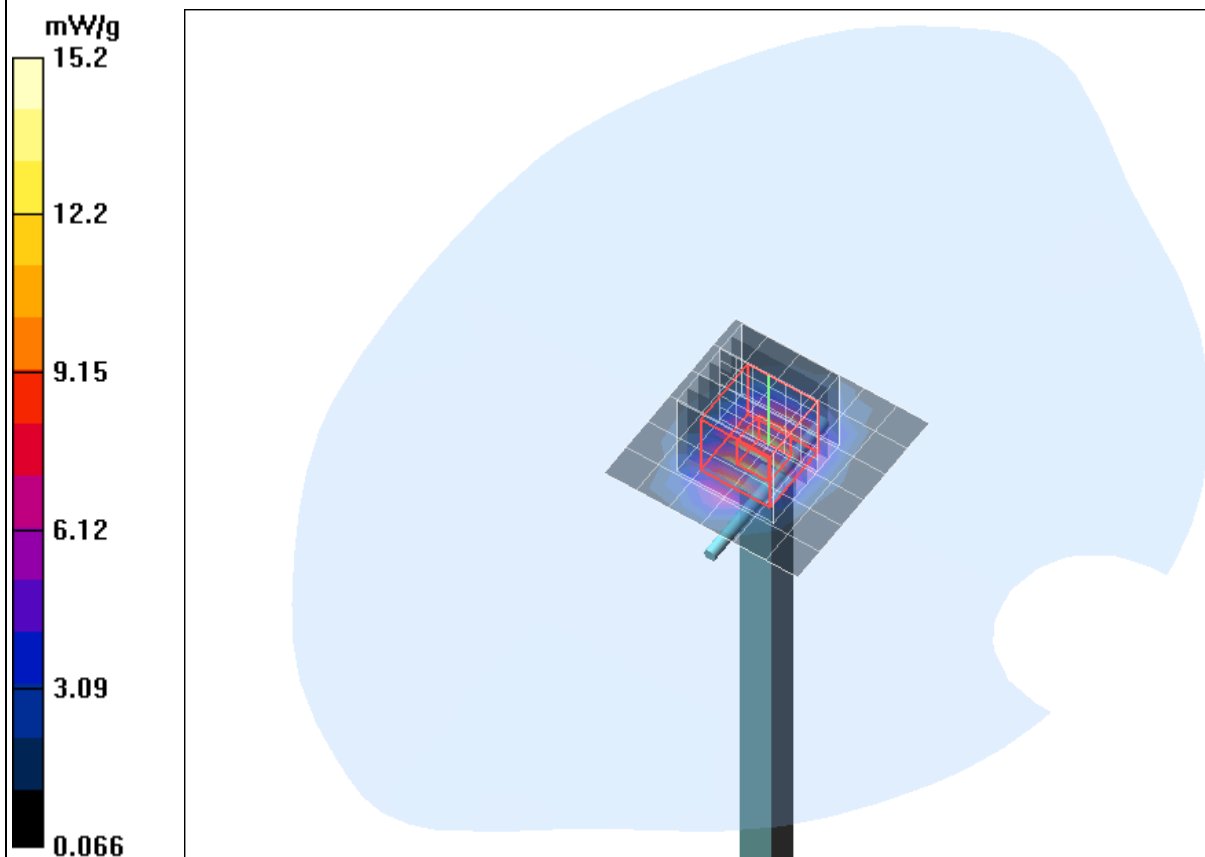

SAR result with Body TSL

Test Laboratory: Imst GmbH, DASY Yellow (II); File Name: [081209_y_3536.da4](#)

DUT: Dipole 2450 MHz SN: 709; Type: D2450V2; Serial: D2450V2 - SN:709
 Program Name: System Performance Check at 2450 MHz

Communication System: CW; Frequency: 2450 MHz; Duty Cycle: 1:1
 Medium parameters used: $f = 2450$ MHz; $\sigma = 2$ mho/m; $\epsilon_r = 51.7$; $\rho = 1000$ kg/m³
 Phantom section: Flat Section

DASY4 Configuration:

- Probe: EX3DV4 - SN3536; ConvF(7.57, 7.57, 7.57); Calibrated: 18.09.2009
- Sensor-Surface: 4mm (Mechanical Surface Detection)
- Electronics: DAE4 Sn631; Calibrated: 14.09.2009
- Phantom: SAM Glycol 1340; Type: QD 000 P40 CB; Serial: TP-1340
- Measurement SW: DASY4, V4.7 Build 80; Postprocessing SW: SEMCAD, V1.8 Build 186

d=10mm, Pin=250mW/Area Scan (7x7x1): Measurement grid: dx=10mm, dy=10mm

Maximum value of SAR (measured) = 15.0 mW/g

d=10mm, Pin=250mW/Zoom Scan (7x7x7)/Cube 0: Measurement grid: dx=5mm, dy=5mm, dz=5mm

Reference Value = 86.9 V/m; Power Drift = 0.016 dB

Peak SAR (extrapolated) = 28.0 W/kg

SAR(1 g) = 13.2 mW/g; SAR(10 g) = 6.01 mW/g

Maximum value of SAR (measured) = 15.1 mW/g

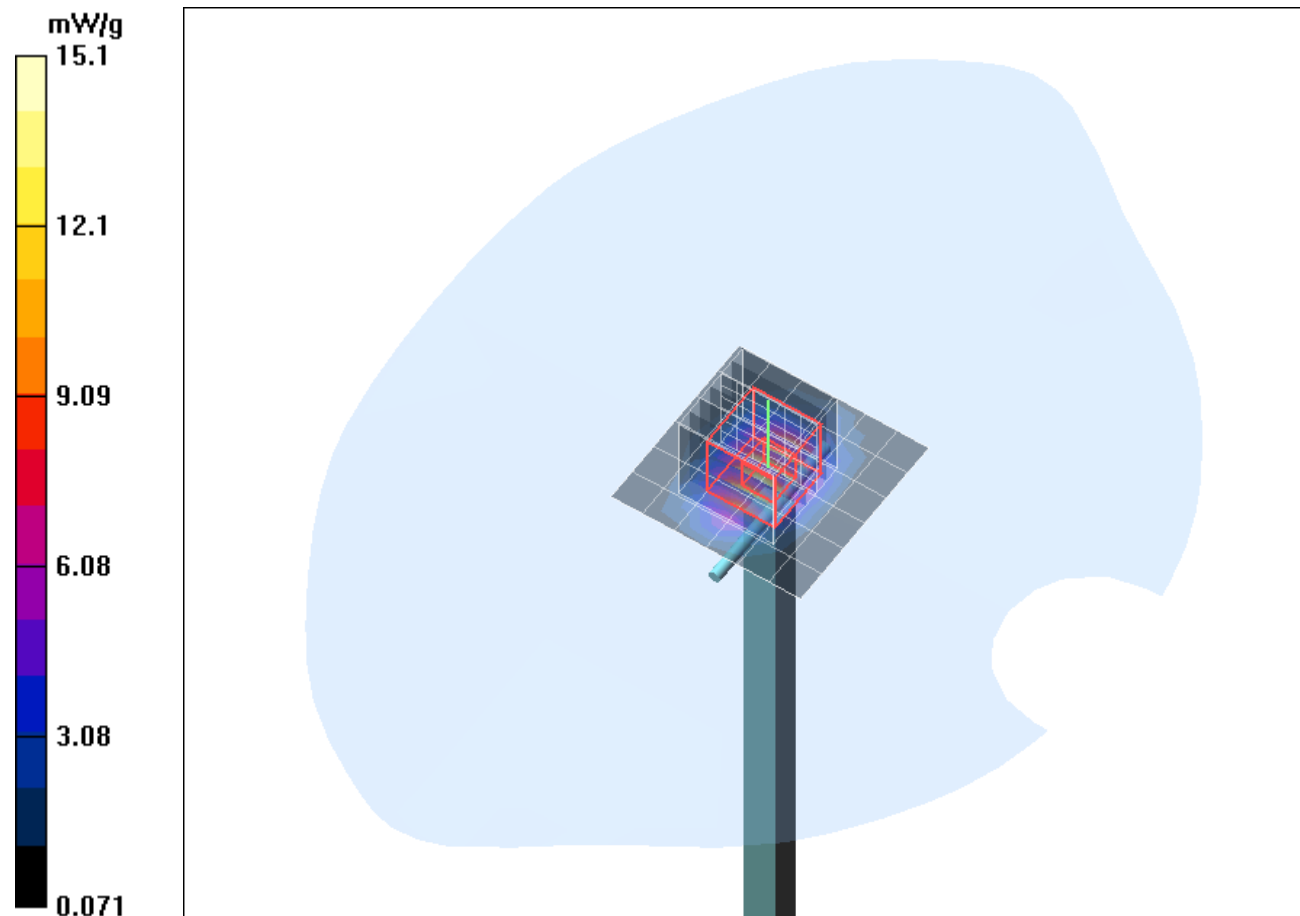

Impedance Measurements Plot for Head TSL

Tr1 S11 Log Mag 10.00dB/ Ref 0.000dB [F1]

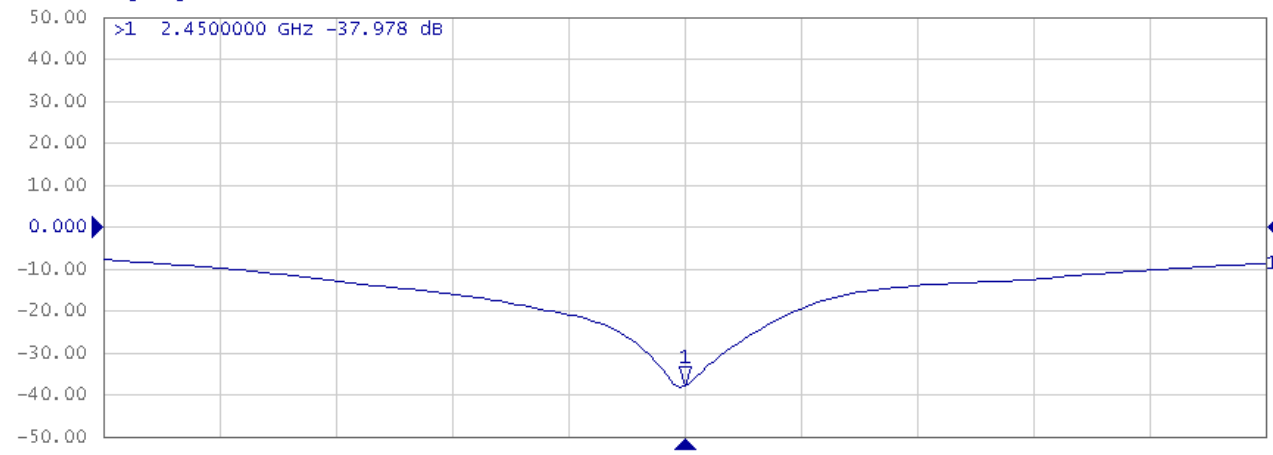

▶ Tr2 S11 Smith (R+jX) scale 1.000U [F1]

>1 2.4500000 GHz 49.747 Ω 1.2333 Ω 80.116 pF

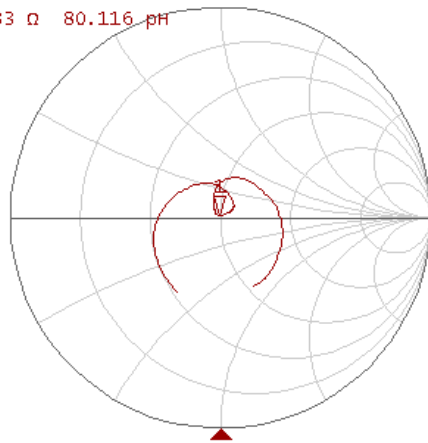

Impedance Measurements Plot for Body TSL

Tr1 S11 Smith (R+jX) scale 1.000U [F1]

>1 2.4500000 GHz 50.787 Ω -1.2761 Ω 50.906 pF

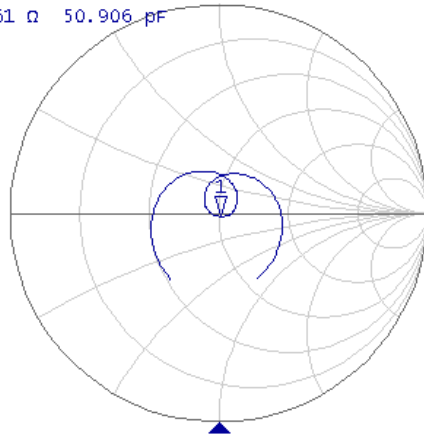

Tr2 S11 Log Mag 10.00dB/ Ref 0.000dB [F1]

>1 2.4500000 GHz -36.551 dB

