

HAC RF-Emission Test Report

Report No. : HF200605C24 R1
Applicant : Kyocera Corporation % Kyocera International, Inc.
Address : 8611 Balboa Avenue, San Diego, CA 92123
Product : Smart Phone
FCC ID : V65E7110
Brand : Kyocera
Model No. : E7110
Standards : FCC 47 CFR Part 20.19, ANSI C63.19-2011
KDB 285076 D01 v05, KDB 285076 D02 v03
Sample Received Date : Jun. 29, 2020
Date of Testing : Sep. 30, 2020 ~ Nov. 10, 2020
Summary M-Rating : M4
Lab Address : No. 47-2, 14th Ling, Chia Pau Vil., Lin Kou Dist., New Taipei City, Taiwan
Test Location : No. 19, Hwa Ya 2nd Rd., Wen Hwa Vil., Kwei Shan Dist., Taoyuan City, Taiwan

CERTIFICATION: The above equipment have been tested by **Bureau Veritas Consumer Products Services (H.K.) Ltd., Taoyuan Branch – Lin Kou Laboratories**, and found compliance with the requirement of the above standards. The test record, data evaluation & Equipment Under Test (EUT) configurations represented herein are true and accurate accounts of the measurements of the sample's HAC characteristics under the conditions specified in this report. It should not be reproduced except in full, without the written approval of our laboratory. The client should not use it to claim product certification, approval, or endorsement by TAF or any government agencies.

Prepared By : 
Gina Liu / Specialist

Approved By : 
Gordon Lin / Manager



FCC Accredited No.: TW0003

This report is for your exclusive use. Any copying or replication of this report to or for any other person or entity, or use of our name or trademark, is permitted only with our prior written permission. This report sets forth our findings solely with respect to the test samples identified herein. The results set forth in this report are not indicative or representative of the quality or characteristics of the lot from which a test sample was taken or any similar or identical product unless specifically and expressly noted. Our report includes all of the tests requested by you and the results thereof based upon the information that you provided to us. You have 60 days from date of issuance of this report to notify us of any material error or omission caused by our negligence, provided, however, that such notice shall be in writing and shall specifically address the issue you wish to raise. A failure to raise such issue within the prescribed time shall constitute your unqualified acceptance of the completeness of this report, the tests conducted and the correctness of the report contents. Unless specific mention, the uncertainty of measurement has been explicitly taken into account to declare the compliance or non-compliance to the specification.

Table of Contents

Release Control Record	3
1. Summary of Maximum M-Rating	4
2. Description of Equipment Under Test	5
3. HAC RF Emission Measurement System	7
3.1 SPEAG DASY6 System	7
3.1.1 Robot.....	8
3.1.2 Probes.....	8
3.1.3 Data Acquisition Electronics (DAE)	9
3.1.4 Phantoms.....	9
3.1.5 Device Holder.....	9
3.1.6 RF Emission Calibration Dipoles.....	9
3.2 DASY6 System Verification.....	10
3.3 EUT Measurements Reference and Plane.....	11
3.4 HAC RF Emission Measurement Procedure.....	12
3.5 Modulation Interference Factor	14
4. HAC Measurement Evaluation.....	16
4.1 M-Rating Category	16
4.2 EUT Configuration and Setting.....	16
4.3 System Verification.....	16
4.4 Maximum Target Conducted Power	17
4.5 Low Power Exemption Evaluation.....	19
4.6 Measured Conducted Power Results.....	21
4.7 HAC RF Emission Testing Results.....	22
5. Calibration of Test Equipment.....	23
6. Measurement Uncertainty.....	24
7. Information of the Testing Laboratories.....	25
Appendix A. Plots of System Verification	
Appendix B. Plots of HAC RF Emission Measurement	
Appendix C. Calibration Certificate for Probe and Dipole	
Appendix D. Photographs of EUT and Setup	

1. Summary of Maximum M-Rating

Mode	Band	Maximum Audio Interference Level (dBV/m)	M-Rating
GSM	GSM850	36.49	M4
	GSM1900	26.38	M4
WCDMA	Band II	N/A	M4
	Band V	N/A	M4
FDD-LTE	Band 2	N/A	M4
	Band 4	N/A	M4
	Band 5	N/A	M4
	Band 7	N/A	M4
	Band 12	N/A	M4
	Band 13	N/A	M4
	Band 66	N/A	M4
TDD-LTE	Band 48	18.10	M4
FDD-5G-FR1	5G NR n2	N/A	M4
	5G NR n5	N/A	M4
	5G NR n66	N/A	M4
WLAN	2.4G	21.55	M4
	5.2G	N/A	M4
	5.3G	N/A	M4
	5.6G	N/A	M4
	5.8G	N/A	M4
Summary		M4	

Note:

1. The HAC RF emission limit (**M-rating Category M3**) is specified in FCC 47 CFR part 20.19 and ANSI C63.19.
2. The device RF emission rating is determined by the minimum rating.

HAC RF-Emission Test Report

2. Description of Equipment Under Test

EUT Type	Smart Phone
FCC ID	V65E7110
Brand Name	Kyocera
Model Name	E7110
Tx Frequency Bands (Unit: MHz)	GSM GSM850 : 824.2 ~ 848.8 GSM1900 : 1850.2 ~ 1909.8 WCDMA Band II : 1852.4 ~ 1907.6 Band V : 826.4 ~ 846.6 FDD-LTE Band 2 : 1850.7 ~ 1909.3 (BW: 1.4M, 3M, 5M, 10M, 15M, 20M) Band 4 : 1710.7 ~ 1754.3 (BW: 1.4M, 3M, 5M, 10M, 15M, 20M) Band 5 : 824.7 ~ 848.3 (BW: 1.4M, 3M, 5M, 10M) Band 7 : 2502.5 ~ 2567.5 (BW: 5M, 10M, 15M, 20M) Band 12 : 699.7 ~ 715.3 (BW: 1.4M, 3M, 5M, 10M) Band 13 : 779.5 ~ 784.5 (BW: 5M, 10M) Band 66 : 1710.7 ~ 1779.3 (BW: 1.4M, 3M, 5M, 10M, 15M, 20M) TDD-LTE Band 48 : 3552.5 ~ 3697.5 (BW: 5M, 10M, 15M, 20M) 5G NR Band 5G NR n2_SCS15KHz : 1852.5 ~ 1907.5 (BW: 5M, 10M, 15M, 20M) 5G NR n5_SCS15KHz : 826.5 ~ 846.5 (BW: 5M, 10M, 15M, 20M) 5G NR n66_SCS15KHz : 1712.5 ~ 1777.5 (BW: 5M, 10M, 15M, 20M) WLAN 2412 ~ 2462, 5180 ~ 5240, 5260 ~ 5320, 5500 ~ 5700, 5745 ~ 5825 Bluetooth 2402 ~ 2480
Modulations Supported in Uplink	GSM & GPRS : GMSK EDGE : 8PSK WCDMA : QPSK LTE : QPSK, 16QAM, 64QAM 5G NR_FR1 : DFT-s- / CP-OFDM_PI/2 BPSK, QPSK, 16QAM, 64QAM, 256QAM 802.11b : DSSS 802.11a/g/n/ac : OFDM Bluetooth : GFSK, $\pi/4$ -DQPSK, 8-DPSK
Antenna Type	Fixed Internal Antenna
EUT Stage	Identical Prototype

Note:

- The above EUT information is declared by manufacturer and for more detailed features description please refers to the manufacturer's specifications or User's Manual.

Battery Information:

Battery	Brand Name	Kyocera
	Model Name	SCP-74LBPS
	Power Rating	3.85Vdc, 4500mAh
	Type	Li-ion embedded

HAC RF-Emission Test Report

Air Interface and Operational Mode:

Air Interface	Bands	Transport Type	HAC Tested	Simultaneous But Not Tested	Name of Voice Service	Power Reduction
GSM	850	VO	YES	WLAN or BT	CMRS Voice	No
	1900					No
	EGPRS	VD	YES	WLAN or BT	Google Duo	No
WCDMA	II	VO	No ⁽¹⁾	WLAN or BT	CMRS Voice	No
	V					No
	HSPA	VD	No ⁽¹⁾	WLAN or BT	Google Duo	No
FDD-LTE	2	VD	No ⁽¹⁾	WLAN or BT	VoLTE Google Duo	No
	4					No
	5					No
	7					No
	12					No
	13					No
	66					No
TDD-LTE	48	VD	YES	WLAN or BT	VoLTE Google Duo	No
FDD-5G-FR1	5G NR n2	VD	No ⁽¹⁾	WLAN or BT	Google Duo	No
	5G NR n5					No
	5G NR n66					No
WLAN	2.4G	VD	YES	WWAN	VoWiFi Google Duo	No
	5.3G			WWAN, BT		No
	5.6G					No
	5.8G					No
Bluetooth	2.4G	DT	No	WWAN or WLAN5G	N/A	No
Transport Type VO = Legacy Cellular Voice Service DT = Digital Transport Only (No Voice) VD = IP Voice Service over Digital Transport			Note 1. The low power exemption per ANSI C63.19-2011 applies.			

3. HAC RF Emission Measurement System

3.1 SPEAG DASY6 System

The SPEAG DASY6 system consists of high precision robot, probe alignment sensor, phantom, robot controller, controlled measurement server and near-field probe. The robot includes six axes that can move to the precision position of the DASY6 software defined. The DASY6 software can define the area that is detected by the probe. The robot is connected to controlled box. Controlled measurement server is connected to the controlled robot box. The DAE includes amplifier, signal multiplexing, AD converter, offset measurement and surface detection. It is connected to the Electro-optical coupler (ECO). The ECO performs the conversion form the optical into digital electric signal of the DAE and transfers data to the PC.

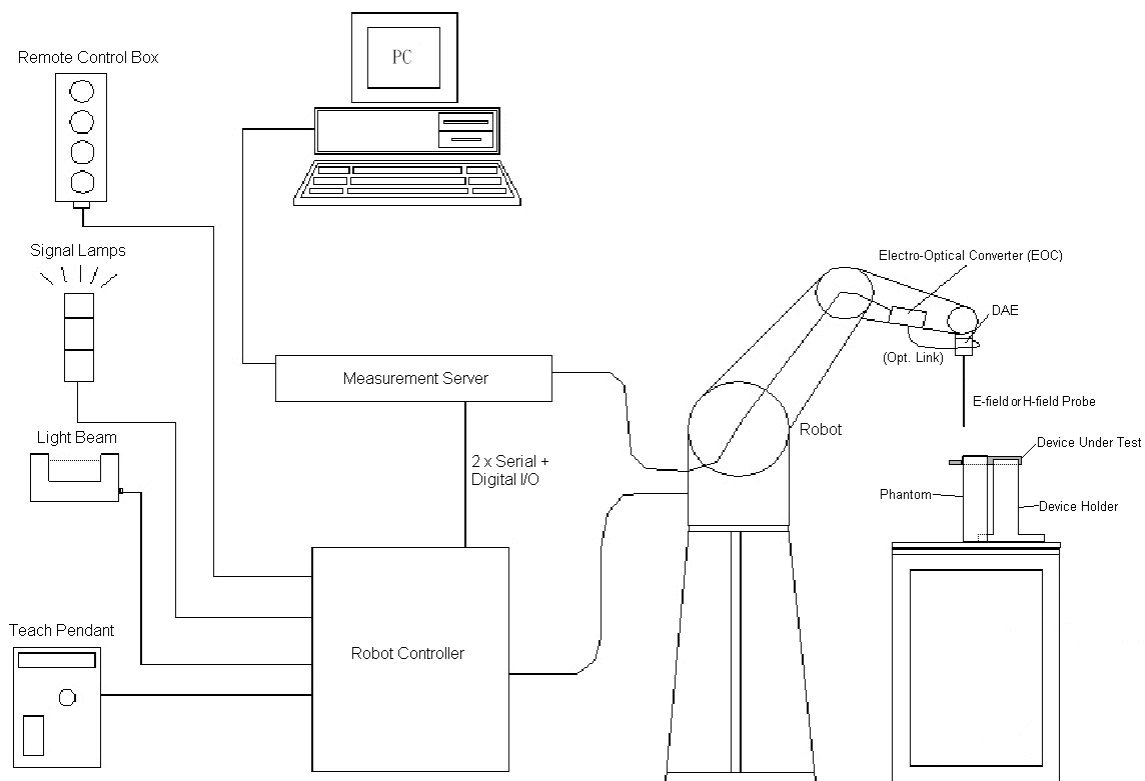

Fig-3.1 SPEAG DASY6 System Setup

HAC RF-Emission Test Report

3.1.1 Robot

The DASY6 system uses the high precision robots from Stäubli SA (France). For the 6-axis controller system, the robot controller version (DASY6: CS8c) from Stäubli is used. The Stäubli robot series have many features that are important for our application:

- High precision (repeatability ± 0.035 mm)
- High reliability (industrial design)
- Jerk-free straight movements
- Low ELF interference (the closed metallic construction shields against motor control fields)

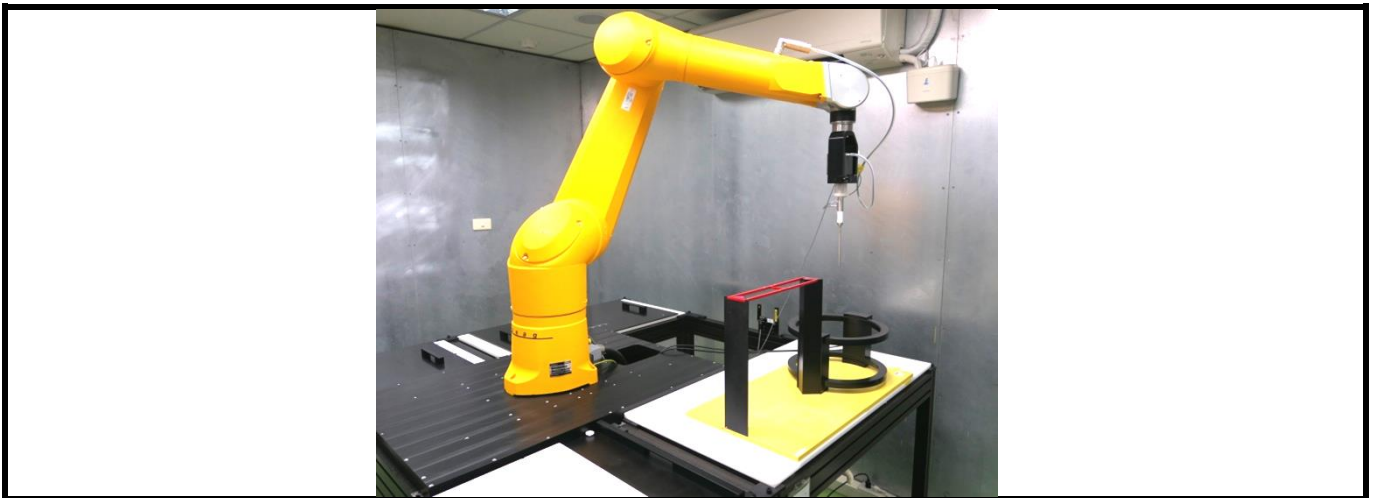



Fig-3.2 DASY6 Measurement System

3.1.2 Probes

Model	ER3DV6	
Construction	One dipole parallel, two dipoles normal to probe axis Built-in shielding against static charges	
Frequency	40 MHz to 3 GHz Linearity: ± 0.2 dB	
Directivity	± 0.2 dB in air (rotation around probe axis) ± 0.4 dB in air (rotation normal to probe axis)	
Dynamic Range	2 V/m to 1000 V/m Linearity: ± 0.2 dB	
Dimensions	Overall length: 337 mm (Tip: 16 mm) Tip diameter: 8 mm (Body: 12 mm) Distance from probe tip to dipole centers: 2.5 mm	

Model	EF3DV3	
Construction	One dipole parallel, two dipoles normal to probe axis Built-in shielding against static charges	
Frequency	40 MHz to 6 GHz Linearity: ± 0.2 dB	
Directivity	± 0.2 dB in air (rotation around probe axis) ± 0.4 dB in air (rotation normal to probe axis)	
Dynamic Range	2 V/m to 1000 V/m Linearity: ± 0.2 dB	
Dimensions	Overall length: 337 mm (Tip: 20 mm) Tip diameter: 3.9 mm (Body: 12 mm) Distance from probe tip to dipole centers: 1.5 mm	

HAC RF-Emission Test Report

3.1.3 Data Acquisition Electronics (DAE)

Model	DAE3, DAE4	
Construction	Signal amplifier, multiplexer, A/D converter and control logic. Serial optical link for communication with DASY embedded system (fully remote controlled). Two step probe touch detector for mechanical surface detection and emergency robot stop.	
Measurement Range	-100 to +300 mV (16 bit resolution and two range settings: 4mV, 400mV)	
Input Offset Voltage	< 5µV (with auto zero)	
Input Bias Current	< 50 fA	
Dimensions	60 x 60 x 68 mm	

3.1.4 Phantoms

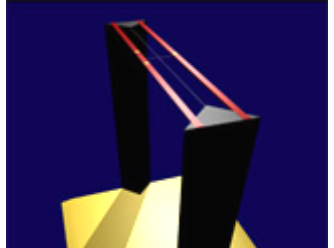
Model	Test Arch	
Construction	Enables easy and well defined positioning of the phone and validation dipoles as well as simple teaching of the robot.	
Dimensions	Length : 370 mm Width : 370 mm Height : 370 mm	

3.1.5 Device Holder

Model	Mounting Device	
Construction	The Mounting Device enables the rotation of the mounted transmitter device in spherical coordinates. Rotation point is the ear opening point. Transmitter devices can be easily and accurately positioned according to ANSI C63.19.	
Material	POM	

3.1.6 RF Emission Calibration Dipoles

Model	CD-Serial	
Construction	Free space antenna Hearing Aid susceptibility measurements according to ANSI C63.19. Validation of Hearing Aid RF setup for wireless device emission measurements according to ANSI C63.19	
Frequency	CD700V3 : 698 ~ 806 MHz CD835V3 : 800 ~ 960 MHz CD1880V3 : 1710 ~ 2000 MHz CD2450V3 : 2250 ~ 2650 MHz CD2600V3 : 2450 ~ 2750 MHz CD3500V3 : 3300 ~ 3950 MHz CD5500V3 : 5000 ~ 5900 MHz	
Return Loss	CD700V3 : > 15 dB (750 MHz > 20 dB) CD835V3 : > 15 dB (835 MHz > 25 dB) CD1880V3 : > 18 dB (1880 MHz > 20 dB) CD2450V3 : > 18 dB (2450 MHz > 25 dB) CD2600V3 : > 18 dB (2600 MHz > 20 dB) CD3500V3 : > 16 dB (3500 MHz > 20 dB) CD5500V3 : > 18 dB (5500 MHz > 20 dB)	
Power Capability	> 40 W continuous	

3.2 DASY6 System Verification

The system check verifies that the system operates within its specifications. It is performed before every E-field measurement. The system check uses normal measurements in the center section of the arch phantom with a matched dipole at a specified distance. The system verification setup is shown as below.

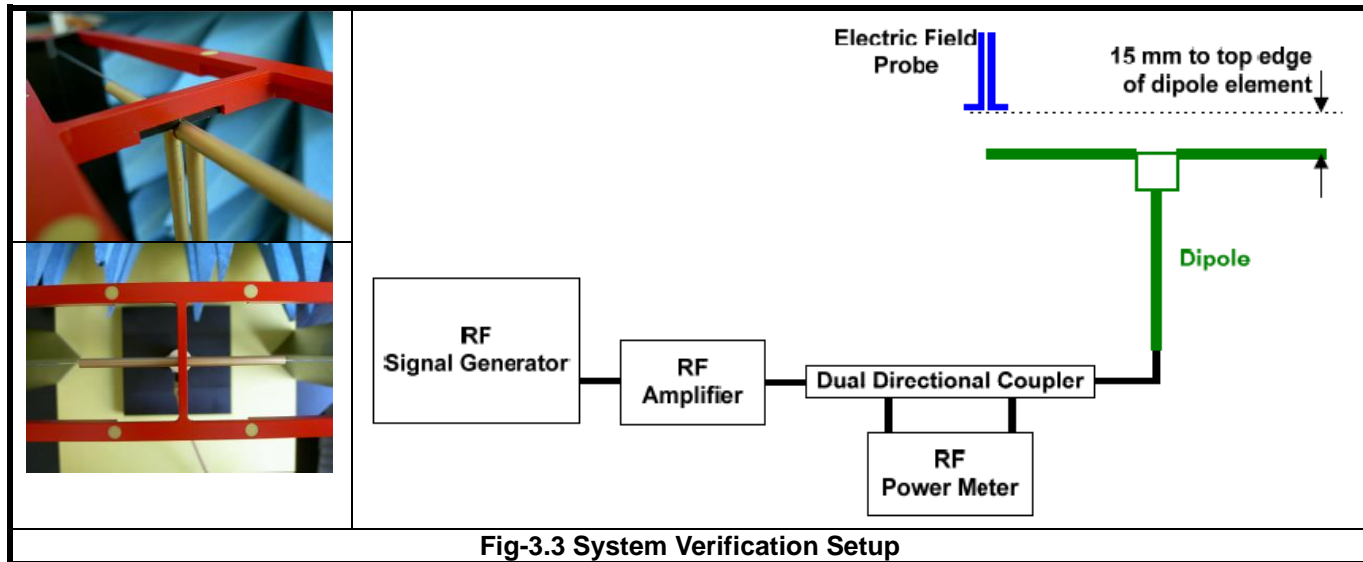

The validation dipole is placed beneath the center of arch phantom. The power meter measures the forward power at the location of the system check dipole connector. The signal generator is adjusted for the desired forward power, 100 mW (20 dBm) at the dipole connector and the RF power meter is read at that level. After connecting the cable to the dipole, the signal generator is readjusted for the same reading at RF power meter.

After system check testing, the E-field result will be compared with the reference value derived from validation dipole certificate report. The deviation of system check should be within 25 %.

The result of system verification is shown in section 4.3 of this report.

3.3 EUT Measurements Reference and Plane

The EUT is mounted in the device holder. The acoustic output of the EUT will coincide with the center point of the area formed by the dielectric wire and the middle bar of the arch's top frame. Then EUT will be moved vertically upwards until it touches the frame.

Fig-3.4 and Fig-3.5 illustrate the references and reference plane that is used in the RF emissions measurement.

- (a) The grid is 50 mm by 50 mm area that is divided into nine evenly sized blocks or sub-grids.
- (b) The grid is centered on the audio frequency output transducer of the EUT.
- (c) The grid is in a reference plane, which is defined as the planar area that contains the highest point in the area of the phone that normally rests against the user's ear. It is parallel to the centerline of the receiver area of the phone and is defined by the points of the receiver-end of the EUT handset, which in normal handset use rest against the ear.
- (d) The measurement plane is parallel to and 15 mm in front of the reference plane.



Fig-3.4 EUT Reference and Plane

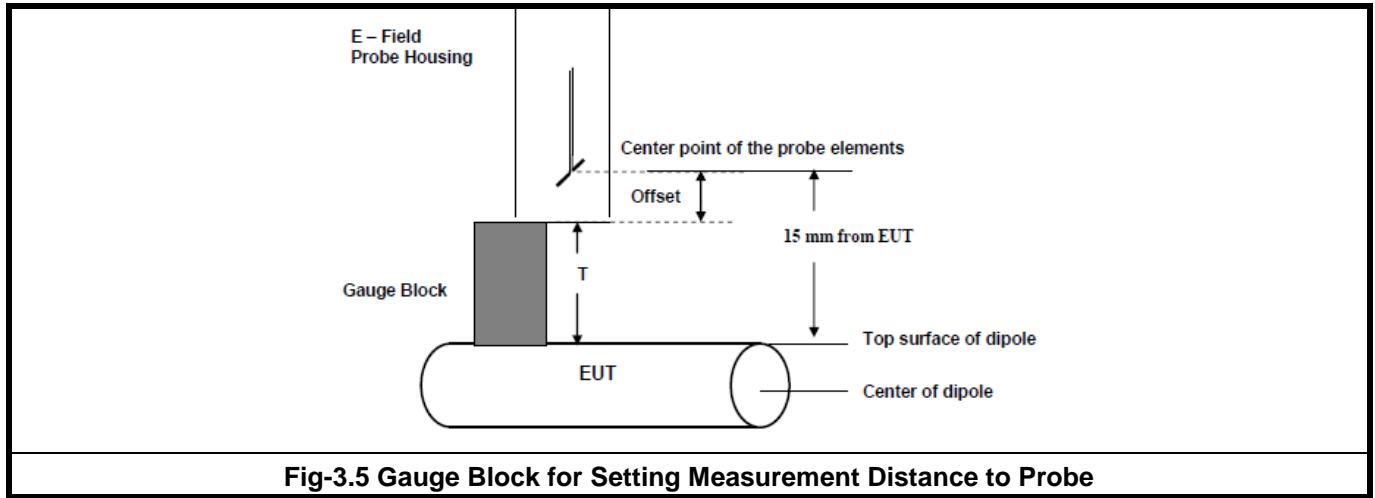

Fig-3.5 Gauge Block for Setting Measurement Distance to Probe

3.4 HAC RF Emission Measurement Procedure

The RF emissions test procedure for wireless communications device is as below.

1. Confirm the proper operation of the field probe, probe measurement system, and other instrumentation and the positioning system.
2. Position the WD in its intended test position.
3. Set the WD to transmit a fixed and repeatable combination of signal power and modulation characteristic that is representative of the worst case (highest interference potential) encountered in normal use. Transiently occurring start-up, changeover, or termination conditions, or other operations likely to occur less than 1% of the time during normal operation, may be excluded from consideration.
4. The center sub-grid shall be centered on the T-Coil mode perpendicular measurement point or the acoustic output, as appropriate. Locate the field probe at the initial test position in the 50 mm by 50 mm grid, which is contained in the measurement plane, illustrated in Fig-3.4. If the field alignment method is used, align the probe for maximum field reception.
5. Record the reading at the output of the measurement system.
6. Scan the entire 50 mm by 50 mm region in equally spaced increments and record the reading at each measurement point. The distance between measurement points shall be sufficient to assure the identification of the maximum reading.
7. Identify the five contiguous sub-grids around the center sub-grid whose maximum reading is the lowest of all available choices. This eliminates the three sub-grids with the maximum readings. Thus, the six areas to be used to determine the WD's highest emissions are identified.
8. Identify the maximum reading within the non-excluded sub-grids identified in step 7.
9. Indirect Measurement Method: The RF audio interference level in dB(V/m) is obtained by adding the MIF (in dB) to the maximum steady-state rms field-strength reading, in dB(V/m), from step 8. Use this result to determine the category rating.

10. Compare this RF audio interference level with the categories in section 4.1 and record the resulting WD category rating.
- 11 For the T-Coil mode M-rating assessment, determine whether the chosen perpendicular measurement point is contained in an included sub-grid of the first can. If so, then a second scan is not necessary. The first scan and resultant category rating may be used for the T-Coil mode M-rating. Otherwise, repeat step 1 through step 9, with the grid shifted so that it is centered on the perpendicular measurement point. Record the WD category rating.

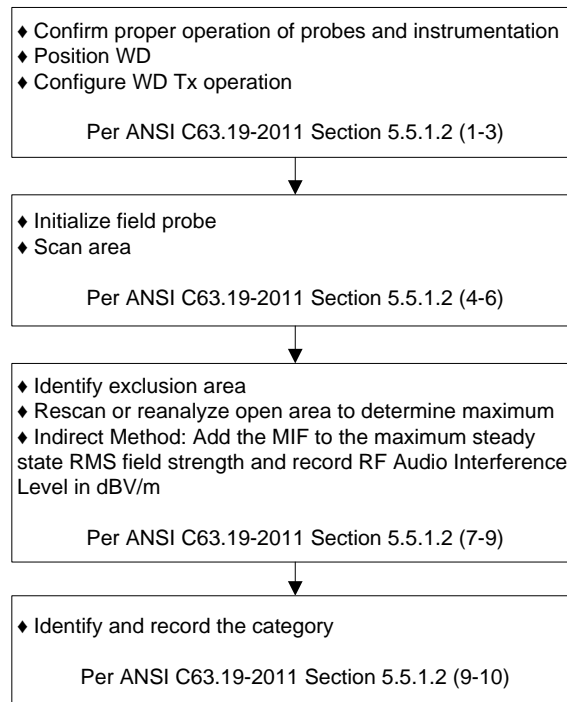

Fig-3.6 WD Near-Field Emission Test Flowchart

3.5 Modulation Interference Factor

The HAC Standard ANSI C63.19-2011 defines a new scaling using the Modulation Interference Factor (MIF) which replaces the need for the Articulation Weighting Factor (AWF) during the evaluation and is applicable to any modulation scheme.

The Modulation Interference Factor (MIF, in dB) is added to the measured average E-field (in dBV/m) and converts it to the RF audio interference potential (in dBV/m). This level considers the audible amplitude modulation components in the RF E-field. CW fields without amplitude modulation are assumed to not interfere with the hearing aid electronics. Modulations without time slots and low fluctuations at low frequencies have low MIF values, TDMA modulations with narrow transmission slots and repetition rates of few 100 Hz have high MIF values and give similar classification as ANSI C63.19-2007.

ER3D E-field probe have a bandwidth <10 kHz and can therefore not evaluate the RF envelope in the full audio band. DASY6 is therefore using the "indirect" measurement method according to ANSI C63.19-2011 which is the primary method. This near field probe read the averaged E-field. Especially for the new high peak-to-average (PAR) signal types, the probes shall be linearized by PMR calibration in order to not overestimate the field reading.

The evaluation method for the MIF is defined in ANSI C63.19-2011 section D.7. An RMS demodulated RF signal is fed to a spectral filter (similar to an A weighting filter) and forwarded to a temporal filter acting as a quasi-peak detector. The averaged output of these filtering is scaled to a 1 kHz 80% AM signal as reference. It may alternatively be determined through analysis and simulation, because it is constant and characteristic for a communication signal. DASY6 uses well-defined signals for PMR calibration. The MIF of these signals has been determined numerically. It allows a precise scaling and is therefore automatically applied.

The following table lists the MIF values evaluated by DASY6 manufacturer (SPEAG) issue on 2020/09/05, and the test result will be calculated with the MIF parameter automatically. The detailed parameters for E-field probe can be found in the probe calibration report in appendix C.

UID	Revision	Communication System Name	MIF (dB)
10021	DAC	GSM-FDD (TDMA, GMSK)	3.63
10025	DAC	EDGE-FDD (TDMA, 8PSK, TN 0)	3.75
10460	AAA	UMTS-FDD (WCDMA, AMR)	-25.43
10225	CAB	UMTS-FDD (HSPA+)	-20.39
10170	CAE	LTE-FDD (SC-FDMA, 1 RB, 20 MHz, 16-QAM)	-9.76
10172	CAG	LTE-TDD (SC-FDMA, 1 RB, 20 MHz, QPSK)	-1.62
10173	CAG	LTE-TDD (SC-FDMA, 1 RB, 20 MHz, 16-QAM)	-1.44
10174	CAG	LTE-TDD (SC-FDMA, 1 RB, 20 MHz, 64-QAM)	-1.54
10061	CAB	IEEE 802.11b WiFi 2.4 GHz (DSSS, 11 Mbps)	-2.02
10077	CAB	IEEE 802.11g WiFi 2.4 GHz (DSSS/OFDM, 54 Mbps)	0.12
10427	AAC	IEEE 802.11n (HT Greenfield, 150 Mbps, 64-QAM)	-13.44
10069	CAD	IEEE 802.11a/h WiFi 5 GHz (OFDM, 54 Mbps)	-3.15
10616	AAC	IEEE 802.11ac WiFi (40MHz, MCS0, 90pc duty cycle)	-5.57
10769	AAD	5G NR (CP-OFDM, 1 RB, 15 MHz, QPSK, 15 kHz) TDD	-12.08
10930	AAB	5G NR (DFT-s-OFDM, 1 RB, 15 MHz, QPSK, 15 kHz) FDD	-15.06

HAC RF-Emission Test Report

The MIF measurement uncertainty listed in following table is estimated by SPEAG.

MIF (dB)	MIF Measurement Uncertainty (dB)
-7 to +5	0.2
-13 to +11	0.5
> -20	1.0

4. HAC Measurement Evaluation

4.1 M-Rating Category

The HAC Standard ANSI C63.19-2011 represents performance requirements for acceptable interoperability of hearing aids with wireless communications devices. When these parameters are met, a hearing aid operates acceptably in close proximity to a wireless communications device.

Emission Categories	E-Field Emissions < 960 MHz (dB V/m)	E-Field Emissions > 960 MHz (dB V/m)
Category M1	50 - 55	40 - 45
Category M2	45 - 50	35 - 40
Category M3	40 - 45	30 - 35
Category M4	< 40	< 30

4.2 EUT Configuration and Setting

For HAC RF emission testing, the EUT was linked and controlled by base station emulator. Communication between the EUT and the emulator was established by air link. The distance between the EUT and the communicating antenna of the emulator is larger than 50 cm and the output power radiated from the emulator antenna is at least 30 dB smaller than the output power of EUT. The EUT was set from the emulator to radiate maximum output power during HAC testing.

4.3 System Verification

The measuring results for system check are shown as below.

Frequency (MHz)	Input Power (dBm)	Target Value (V/m)	E-Field 1 (V/m)	E-Field 2 (V/m)	Average E-Field (V/m)	Deviation (%)	Test Date
835	20.0	106.7	98.29	97.22	97.755	-8.38	Sep. 30, 2020
1880	20.0	88.20	86.30	87.24	86.77	-1.62	Sep. 30, 2020
2450	20.0	85.10	83.40	81.70	82.55	-3.00	Sep. 30, 2020
3500	20.0	82.3	88.18	89.67	88.925	8.05	Nov. 10, 2020

Note:

- Comparing to the reference target value provided by SPEAG, the validation data should be within its specification of 25 %. The result indicates the system check can meet the variation criterion and the plots can be referred to Appendix A of this report.
- For E-Field, the deviation is $[(E\text{-Field } 1 + E\text{-Field } 2) / 2 - \text{Target Value}] / \text{Target Value} \times 100\%$

4.4 Maximum Target Conducted Power

The maximum conducted average power (Unit: dBm) including tune-up tolerance is shown as below.

Air Interface		Max. Tune-up Power	
GSM	GSM850	33.9	
	EDGE850	27.9	
	GSM1900	30.9	
	EDGE1900	26.9	
WCDMA	Band II	AMR	24.7
		HSPA	23.7
	Band V	AMR	24.7
		HSPA	23.7
FDD-LTE	Band 2	25.2	
	Band 4	25.2	
	Band 5	25.2	
	Band 7	24.2	
	Band 12	24.2	
	Band 13	24.2	
	Band 66	25.2	
TDD-LTE	Band 48	25.2	
FDD-5G FR1	5G NR n2	25.2	
	5G NR n5	25.2	
	5G NR n66	24.5	

HAC RF-Emission Test Report

Air Interface		Max. Tune-up Power		
		Antenna 0	Antenna 1	Antenna 0+1
WLAN 2.4G	802.11b	16.0	16.0	19.0
	802.11g	14.0	14.0	17.0
	802.11n HT20	14.0	14.0	17.0
WLAN 5.2G	802.11a	15.5	15.5	18.5
	802.11n HT20	15.5	15.5	18.5
	802.11n HT40	13.0	13.0	16.0
	802.11ac VHT80	12.0	12.0	15.0
WLAN 5.3G	802.11a	15.5	15.5	18.5
	802.11n HT20	15.5	15.5	18.5
	802.11n HT40	13.0	13.0	16.0
	802.11ac VHT80	13.0	13.0	16.0
WLAN 5.6G	802.11a	13.7	13.7	16.7
	802.11n HT20	13.7	13.7	16.7
	802.11n HT40	13.0	13.0	16.0
	802.11ac VHT80	13.0	13.0	16.0
WLAN 5.8G	802.11a	13.7	13.7	16.7
	802.11n HT20	13.7	13.7	16.7
	802.11n HT40	13.0	13.0	16.0
	802.11ac VHT80	12.0	12.0	15.0

4.5 Low Power Exemption Evaluation

According to ANSI C63.19-2011 section 4, RF air interface technologies that have low power have been found to produce sufficiently low RF interference potential, so it is possible to exempt them from the product testing. An RF air interface technology of a device is exempt from testing when its average antenna input power plus its worst-case MIF is ≤ 17 dBm for any of its operating modes. If a device supports multiple RF air interfaces, each RF air interface shall be evaluated individually. An RF air interface technology that is exempted from testing by above method could be rated as M4.

The low power exemption for this device is analyzed in below.

Air Interface		Max. Tune-up Power (dBm)	Worst Case MIF (dB)	Power + MIF (dB)	C63.19 Testing Required	
GSM	GSM850	33.9	3.63	37.53	YES ⁽¹⁾	
	EDGE850	27.9	3.75	31.65	YES ⁽¹⁾	
	GSM1900	30.9	3.63	34.53	YES ⁽¹⁾	
	EDGE1900	26.9	3.75	30.65	YES ⁽¹⁾	
WCDMA	AMR	24.7	-25.43	-0.73	No	
	HSPA	23.7	-20.39	3.31	No	
FDD-LTE		25.2	-9.76	15.44	No	
TDD-LTE		25.2	-1.62	23.58	YES ⁽²⁾	
FDD-FR1		25.2	-15.06	10.14	No	
WLAN 2.4G	802.11b	ANT-0	16	-2.02	13.98	No
		ANT-1	16	-2.02	13.98	No
		ANT 0+1	19	-2.02	16.98	No
	802.11g	ANT-0	14	0.12	14.12	No
		ANT-1	14	0.12	14.12	No
		ANT 0+1	17	0.12	17.12	YES ⁽³⁾
	802.11n HT20	ANT-0	14	-13.44	0.56	No
		ANT-1	14	-13.44	0.56	No
		ANT 0+1	17	-13.44	3.56	No

Note:

1. The EDGE data modes were considered but not tested because GSM voice mode was worst case for the GSM air interface.
2. The TDD-LTE 16QAM/64QAM data modes were considered but not tested because QPSK mode was worst case for the TDD-LTE air interface.
3. The 802.11b modes were considered but not tested because 802.11g mode was worst case for the WLAN 2.4G air interface.

HAC RF-Emission Test Report

Air Interface		Max. Tune-up Power (dBm)	Worst Case MIF (dB)	Power + MIF (dB)	C63.19 Testing Required	
WLAN 5.2G	802.11a	ANT-0	15.5	-3.15	12.35	No
		ANT-1	15.5	-3.15	12.35	No
		ANT 0+1	18.5	-3.15	15.35	No
	802.11n HT20	ANT-0	15.5	-13.44	2.06	No
		ANT-1	15.5	-13.44	2.06	No
		ANT 0+1	18.5	-13.44	5.06	No
	802.11n HT40	ANT-0	13.0	-13.44	-0.44	No
		ANT-1	13.0	-13.44	-0.44	No
		ANT 0+1	16.0	-13.44	2.56	No
	802.11ac VHT80	ANT-0	12.0	-5.57	6.43	No
		ANT-1	12.0	-5.57	6.43	No
		ANT 0+1	15.0	-5.57	9.43	No
WLAN 5.3G	802.11a	ANT-0	15.5	-3.15	12.35	No
		ANT-1	15.5	-3.15	12.35	No
		ANT 0+1	18.5	-3.15	15.35	No
	802.11n HT20	ANT-0	15.5	-13.44	2.06	No
		ANT-1	15.5	-13.44	2.06	No
		ANT 0+1	18.5	-13.44	5.06	No
	802.11n HT40	ANT-0	13.0	-13.44	-0.44	No
		ANT-1	13.0	-13.44	-0.44	No
		ANT 0+1	16.0	-13.44	2.56	No
	802.11ac VHT80	ANT-0	12.0	-5.57	6.43	No
		ANT-1	12.0	-5.57	6.43	No
		ANT 0+1	15.0	-5.57	9.43	No
WLAN 5.6G	802.11a	ANT-0	13.7	-3.15	10.55	No
		ANT-1	13.7	-3.15	10.55	No
		ANT 0+1	16.7	-3.15	13.55	No
	802.11n HT20	ANT-0	13.7	-13.44	0.26	No
		ANT-1	13.7	-13.44	0.26	No
		ANT 0+1	16.7	-13.44	3.26	No
	802.11n HT40	ANT-0	13.0	-13.44	-0.44	No
		ANT-1	13.0	-13.44	-0.44	No
		ANT 0+1	16.0	-13.44	2.56	No
	802.11ac VHT80	ANT-0	13.0	-5.57	7.43	No
		ANT-1	13.0	-5.57	7.43	No
		ANT 0+1	16.0	-5.57	10.43	No
WLAN 5.8G	802.11a	ANT-0	13.7	-3.15	10.55	No
		ANT-1	13.7	-3.15	10.55	No
		ANT 0+1	16.7	-3.15	13.55	No
	802.11n HT20	ANT-0	13.7	-13.44	0.26	No
		ANT-1	13.7	-13.44	0.26	No
		ANT 0+1	16.7	-13.44	3.26	No
	802.11n HT40	ANT-0	13.0	-13.44	-0.44	No
		ANT-1	13.0	-13.44	-0.44	No
		ANT 0+1	16.0	-13.44	2.56	No
	802.11ac VHT80	ANT-0	12.0	-5.57	6.43	No
		ANT-1	12.0	-5.57	6.43	No
		ANT 0+1	15.0	-5.57	9.43	No

HAC RF-Emission Test Report

4.6 Measured Conducted Power Results

The measuring conducted average power (Unit: dBm) are shown as below.

Band	GSM850			GSM1900		
Channel	128	189	251	512	661	810
Frequency (MHz)	824.2	836.4	848.8	1850.2	1880.0	1909.8
GSM (GMSK, 1 Tx Slot)	32.12	32.47	32.35	30.59	30.54	30.19

Band	LTE Band 48						
BW	Modulation	RB Size	RB Offset	Low	Low-Mid	Mid	High-Mid
		Channel		55340	55773	56207	56640
		Frequency (MHz)		3560	3603.3	3646.7	3690
20M	QPSK	1	0	24.46	24.27	24.38	24.48
		1	50	24.45	24.21	24.38	24.46
		1	99	24.42	24.23	24.37	24.43
		50	0	23.67	23.42	23.54	23.68
		50	25	23.56	23.41	23.52	23.64
		50	50	23.53	23.31	23.46	23.62
		100	0	23.55	23.41	23.53	23.63

Band	WLAN 2.4G			
Mode	Data Rate	Channel	Frequency (MHz)	Power ANT0+1
802.11g	54Mbps	1	2412	16.86
		6	2437	16.82
		11	2462	16.93

HAC RF-Emission Test Report

4.7 HAC RF Emission Testing Results

Plot No.	Band	Mode	Channel	Transmit Antenna	Audio Interference Level (dB V/m)	FCC Limit (dB V/m)	FCC Margin (dB)	M-Rating
	GSM850	GSM Voice	128	0	34.42	45	-10.58	M4
	GSM850	GSM Voice	189	0	35.98	45	-9.02	M4
01	GSM850	GSM Voice	251	0	36.49	45	-8.51	M4
	GSM1900	GSM Voice	512	0	25.39	35	-9.61	M4
	GSM1900	GSM Voice	661	0	25.25	35	-9.75	M4
02	GSM1900	GSM Voice	810	0	26.38	35	-8.62	M4
	LTE B48	20M, QPSK, 1RB, OS0	55340	0	17.76	35	-17.24	M4
	LTE B48	20M, QPSK, 1RB, OS0	55780	0	17.86	35	-17.14	M4
	LTE B48	20M, QPSK, 1RB, OS0	56210	0	17.78	35	-17.22	M4
03	LTE B48	20M, QPSK, 1RB, OS0	56640	0	18.10	35	-16.9	M4
04	WLAN 2.4G	802.11g 54Mbps	1	0+1	21.55	35	-13.45	M4
	WLAN 2.4G	802.11g 54Mbps	6	0+1	20.08	35	-14.92	M4
	WLAN 2.4G	802.11g 54Mbps	11	0+1	20.23	35	-14.77	M4

Test Engineer : Willy Chang

HAC RF-Emission Test Report

5. Calibration of Test Equipment

Equipment	Manufacturer	Model	SN	Cal. Date	Cal. Interval
835MHz Calibration Dipole	SPEAG	CD835V3	1041	Jan. 22, 2020	3 Years
1880MHz Calibration Dipole	SPEAG	CD1880V3	1032	Jan. 22, 2020	3 Years
2450MHz Calibration Dipole	SPEAG	CD2450V3	1033	Jan. 22, 2020	3 Years
Isotropic E-Field Probe	SPEAG	EF3DV3	4049	Jan. 24, 2020	1 Year
Data Acquisition Electronics	SPEAG	DAE4	1585	May. 28, 2020	1 Year
Universal Radio Communication Tester	Anritsu	MT8821C	6201502978	Jul. 09, 2020	1 Year
Universal Radio Communication Tester	R&S	CMW500	164864	Apr. 16, 2020	1 Year
MXG Analog Signal Generator	Agilent	N5181A	MY50143868	Jun. 23, 2020	1 Year
Power Meter	Anritsu	ML2495A	1218009	Jun. 24, 2020	1 Year
Power Sensor	Anritsu	MA2411B	1207252	Jun. 24, 2020	1 Year
Test Arch Phantom	SPEAG	Arch	N/A	N/A	N/A

6. Measurement Uncertainty

Error Description	Uncertainty Value (±%)	Probability Distribution	Divisor	Ci (E)	Standard Uncertainty (E)
Measurement System					
Probe Calibration	5.05	Normal	1	1	± 5.1 %
Axial Isotropy	4.7	Rectangular	√3	1	± 2.7 %
Sensor Displacement	16.5	Rectangular	√3	1	± 9.5 %
Boundary Effects	2.4	Rectangular	√3	1	± 1.4 %
Phantom Boundary Effect	7.2	Rectangular	√3	1	± 4.2 %
Linearity	4.7	Rectangular	√3	1	± 2.7 %
Scaling with PMR Calibration	10.0	Rectangular	√3	1	± 5.8 %
System Detection Limit	0.25	Rectangular	√3	1	± 0.1 %
Readout Electronics	0.3	Normal	1	1	± 0.3 %
Response Time	0.0	Rectangular	√3	1	± 0.0 %
Integration Time	2.6	Rectangular	√3	1	± 1.5 %
RF Ambient Conditions	3.0	Rectangular	√3	1	± 1.7 %
RF Reflections	12.0	Rectangular	√3	1	± 6.9 %
Probe Positioner	1.2	Rectangular	√3	1	± 0.7 %
Probe Positioning	4.7	Rectangular	√3	1	± 2.7 %
Extrap. and Interpolation	2.0	Rectangular	√3	1	± 1.2 %
Test Sample Related					
Device Positioning Vertical	4.7	Rectangular	√3	1	± 2.7 %
Device Positioning Lateral	1.0	Rectangular	√3	1	± 0.6 %
Device Holder and Phantom	2.4	Rectangular	√3	1	± 1.4 %
Power Drift	5.0	Rectangular	√3	1	± 2.9 %
Phantom and Setup Related					
Phantom Thickness	2.4	Rectangular	√3	1	± 1.4 %
Combined Standard Uncertainty					± 16.3 %
Coverage Factor for 95 %					K = 2
Expanded Uncertainty					± 32.6 %

Uncertainty budget for HAC RF Emission

7. Information of the Testing Laboratories

We, Bureau Veritas Consumer Products Services (H.K.) Ltd., Taoyuan Branch, were founded in 1988 to provide our best service in EMC, Radio, Telecom and Safety consultation. Our laboratories are accredited and approved according to ISO/IEC 17025.

If you have any comments, please feel free to contact us at the following:

Taiwan Huaya Lab:

Add: No. 19, Huaya 2nd Rd., Guishan Dist., Taoyuan City 333, Taiwan
Tel: +886-(0)3-318-3232
Fax: +886-(0)3-211-5834

Taiwan Linkou Lab:

Add: No. 47-2, Baodoucuokeng, Linkou Dist., New Taipei City 244, Taiwan
Tel: +886-(0)2-2605-2180
Fax: +886-(0)2-2605-2943

Taiwan Hsinchu Lab1:

Add: E-2, No. 1, Lixing 1st Rd., East Dist., Hsinchu City 300, Taiwan
Tel: +886-(0)3-666-8565
Fax: +886-(0)3-666-8323

Taiwan Hsinchu Lab2:

Add: No. 49, Ln. 206, Wende Rd., Qionglin Township, Hsinchu County 307, Taiwan
Tel: +886-(0)3-512-0595
Fax: +886-(0)3-512-0568

Taiwan Xindian Lab:

Add: B2F., No. 215, Sec. 3, Beixin Rd., Xindian Dist., New Taipei City 231, Taiwan
Tel: +886-(0)2-8914-5882
Fax: +886-(0)2-8914-5840

Email: service.adt@tw.bureauveritas.com

Web Site: <https://ee.bureauveritas.com.tw/BVInternet/Default>

The road map of all our labs can be found in our web site also.

---END---

Appendix A. Plots of System Verification

The plots for system verification with largest deviation for each frequency band are shown as follows.

System Check_E-Field_835_200930

DUT: HAC Dipole 835 MHz; Type: CD835V3; SN: 1041

Communication System: UID 0, CW; Frequency: 835 MHz; Duty Cycle: 1:1

Medium: Air Medium parameters used: $\sigma = 0 \text{ S/m}$, $\epsilon_r = 1$; $\rho = 0 \text{ kg/m}^3$

Ambient Temperature : 23.7 °C

DASY5 Configuration:

- Probe: EF3DV3 - SN4049; ConvF(1, 1, 1) @ 835 MHz; Calibrated: 2020/01/24
- Sensor-Surface: (Fix Surface)
- Electronics: DAE4 Sn1585; Calibrated: 2020/05/28
- Phantom: HAC Test Arch with AMCC; Type: SD HAC P01 BA;
- Measurement SW: DASY52, Version 52.10 (4); SEMCAD X Version 14.6.14 (7483)

Hearing Aid Compatibility (41x361x1): Interpolated grid: dx=0.5000 mm, dy=0.5000 mm

Device Reference Point: 0, 0, -6.3 mm

Reference Value = 102.3 V/m; Power Drift = -0.05 dB

E-field emissions = 98.29 V/m

Grid 1 M4 97.90 V/m	Grid 2 M4 98.29 V/m	Grid 3 M4 94.99 V/m
Grid 4 M4 53.10 V/m	Grid 5 M4 53.19 V/m	Grid 6 M4 52.04 V/m
Grid 7 M4 96.62 V/m	Grid 8 M4 97.22 V/m	Grid 9 M4 94.26 V/m

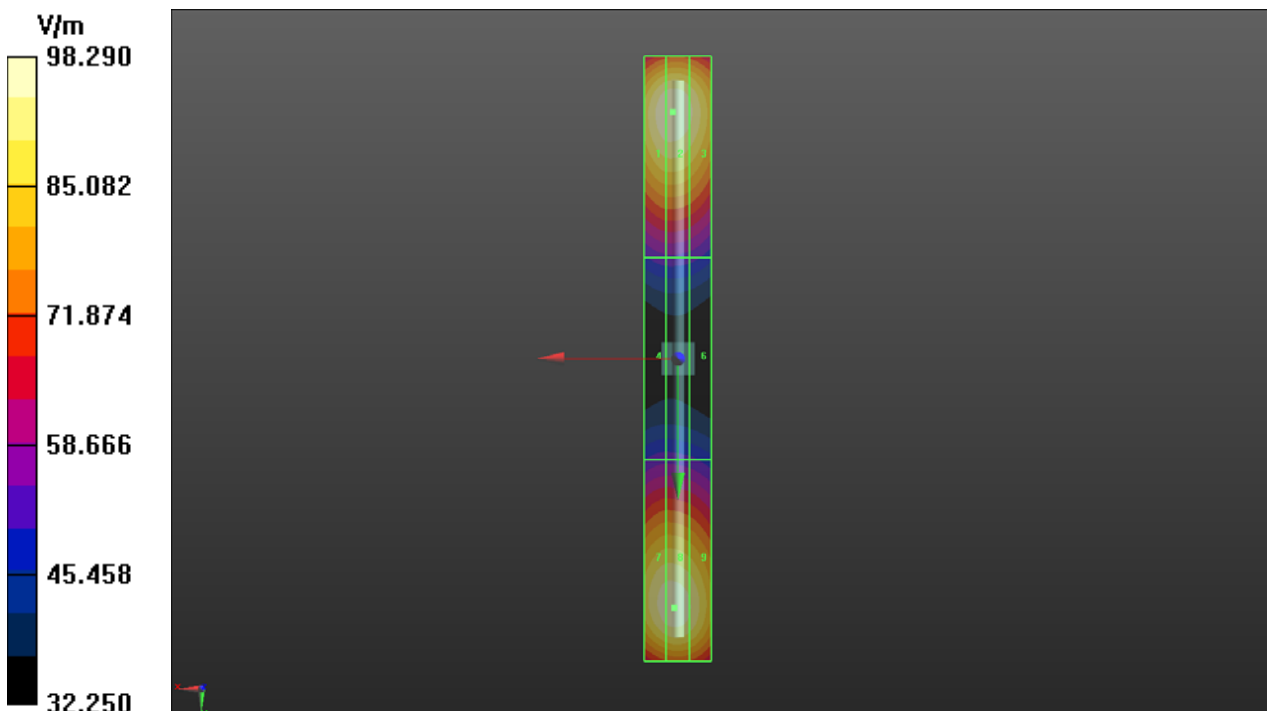

System Check_E-Field_1880_200930

DUT: HAC Dipole 1880 MHz; Type: CD1880V3; SN: 1032

Communication System: UID 0, CW; Frequency: 1880 MHz;Duty Cycle: 1:1

Medium: Air Medium parameters used: $\sigma = 0 \text{ S/m}$, $\epsilon_r = 1$; $\rho = 0 \text{ kg/m}^3$

Ambient Temperature : 23.7 °C

DASY5 Configuration:

- Probe: EF3DV3 - SN4049; ConvF(1, 1, 1) @ 1880 MHz; Calibrated: 2020/01/24
- Sensor-Surface: (Fix Surface)
- Electronics: DAE4 Sn1585; Calibrated: 2020/05/28
- Phantom: HAC Test Arch with AMCC; Type: SD HAC P01 BA;
- Measurement SW: DASY52, Version 52.10 (4); SEMCAD X Version 14.6.14 (7483)

Hearing Aid Compatibility (41x181x1): Interpolated grid: dx=0.5000 mm, dy=0.5000 mm

Device Reference Point: 0, 0, -6.3 mm

Reference Value = 141.9 V/m; Power Drift = 0.03 dB

E-field emissions = 87.24 V/m

Grid 1 M3 85.98 V/m	Grid 2 M3 86.30 V/m	Grid 3 M3 83.36 V/m
Grid 4 M3 64.09 V/m	Grid 5 M3 64.13 V/m	Grid 6 M4 62.59 V/m
Grid 7 M3 86.26 V/m	Grid 8 M3 87.24 V/m	Grid 9 M3 84.50 V/m

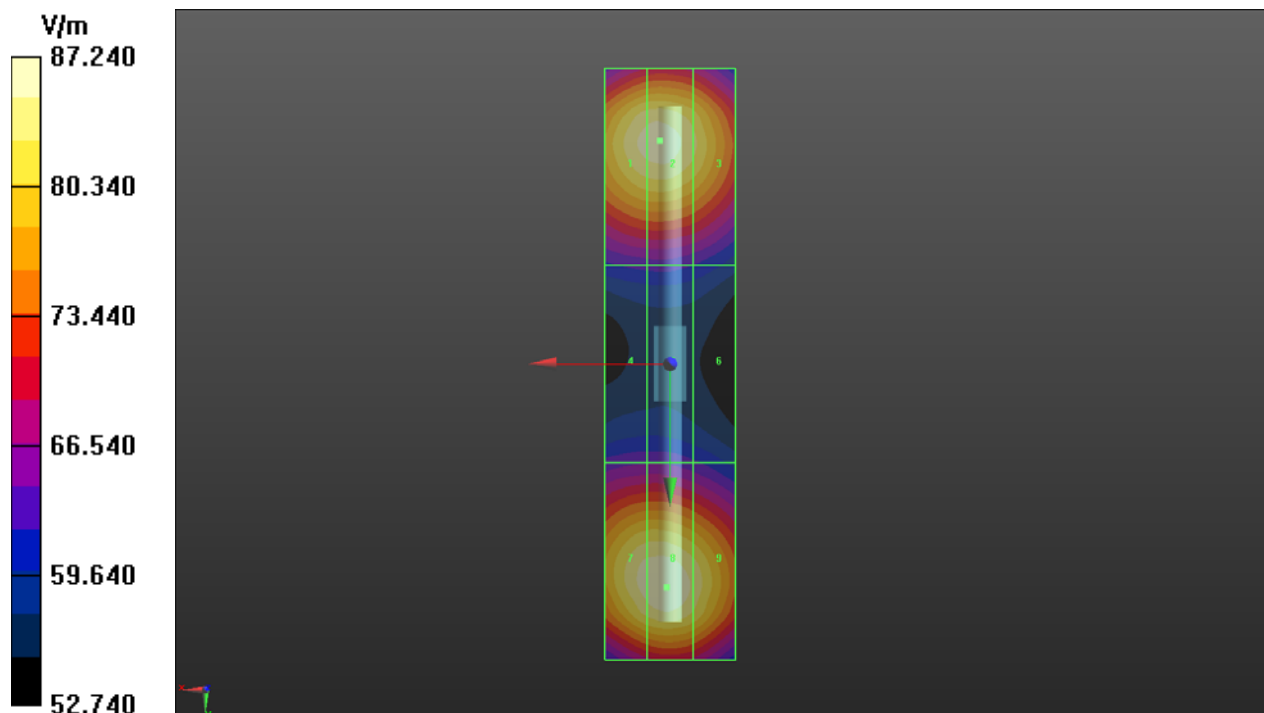

System Check_E-Field_2450_200930

DUT: HAC Dipole 2450 MHz; Type: CD2450V3; SN: 1033

Communication System: UID 0, CW; Frequency: 2450 MHz; Duty Cycle: 1:1

Medium: Air Medium parameters used: $\sigma = 0 \text{ S/m}$, $\epsilon_r = 1$; $\rho = 0 \text{ kg/m}^3$

Ambient Temperature : 23.7 °C

DASY5 Configuration:

- Probe: EF3DV3 - SN4049; ConvF(1, 1, 1) @ 2450 MHz; Calibrated: 2020/01/24
- Sensor-Surface: (Fix Surface)
- Electronics: DAE4 Sn1585; Calibrated: 2020/05/28
- Phantom: HAC Test Arch with AMCC; Type: SD HAC P01 BA;
- Measurement SW: DASY52, Version 52.10 (4); SEMCAD X Version 14.6.14 (7483)

Hearing Aid Compatibility (41x181x1): Interpolated grid: dx=0.5000 mm, dy=0.5000 mm

Device Reference Point: 0, 0, -6.3 mm

Reference Value = 71.22 V/m; Power Drift = 0.09 dB

E-field emissions = 83.40 V/m

Grid 1 M3 82.76 V/m	Grid 2 M3 83.40 V/m	Grid 3 M3 80.72 V/m
Grid 4 M3 73.38 V/m	Grid 5 M3 73.41 V/m	Grid 6 M3 71.99 V/m
Grid 7 M3 80.94 V/m	Grid 8 M3 81.70 V/m	Grid 9 M3 79.69 V/m

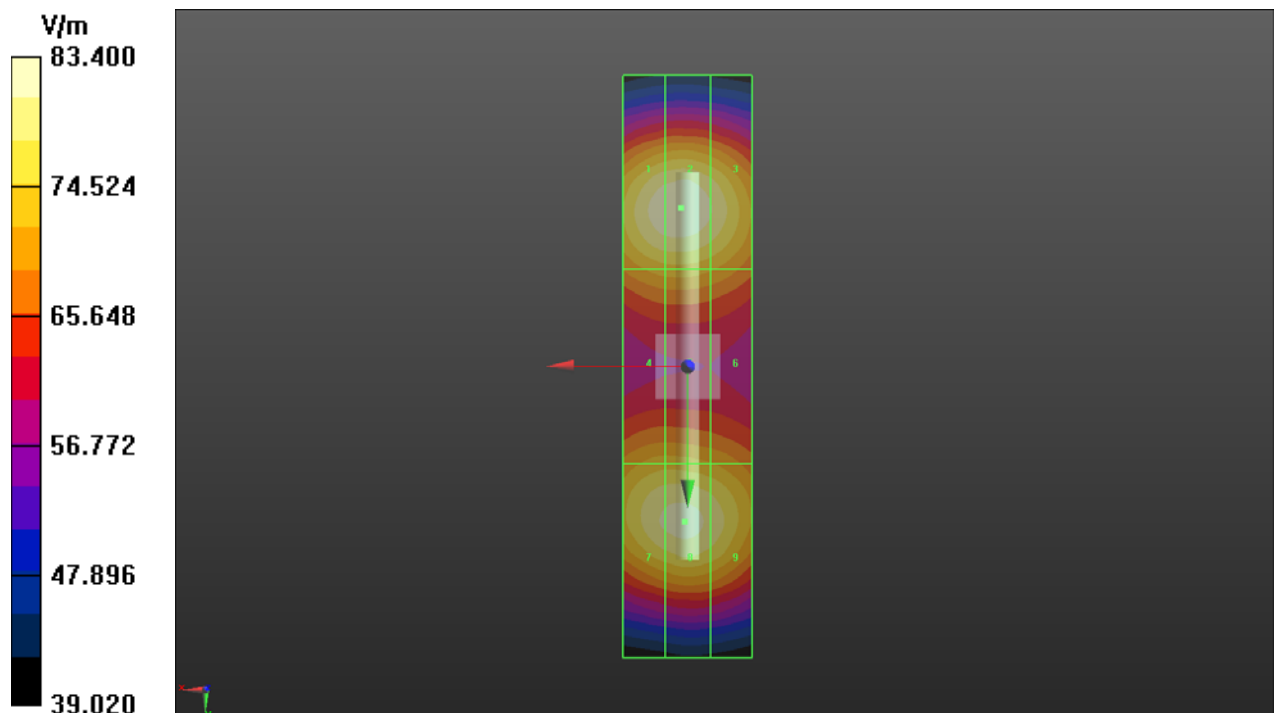

Appendix B. Plots of HAC RF Emission Measurement

The HAC plots for highest measured result in each wireless mode and frequency band combination are shown as follows.

P01 RF_E-Field_GSM850_GSM_Ch251

DUT: 200605C24

Communication System: UID 10021 - DAC, GSM-FDD (TDMA, GMSK); Frequency: 848.8 MHz; Duty Cycle: 1:8.7

Medium: Air Medium parameters used: $\sigma = 0$ S/m, $\epsilon_r = 1$; $\rho = 0$ kg/m³
 Ambient Temperature : 23.7 °C

DASY5 Configuration:

- Probe: EF3DV3 - SN4049; ConvF(1, 1, 1) @ 848.8 MHz; Calibrated: 2020/01/24
- Sensor-Surface: (Fix Surface)
- Electronics: DAE4 Sn1585; Calibrated: 2020/05/28
- Phantom: HAC Test Arch with AMCC; Type: SD HAC P01 BA;
- Measurement SW: DASY52, Version 52.10 (4); SEMCAD X Version 14.6.14 (7483)

Hearing Aid Compatibility (101x101x1): Interpolated grid: dx=0.5000 mm, dy=0.5000 mm

Device Reference Point: 0, 0, -6.3 mm

Reference Value = 48.59 V/m; Power Drift = 0.03 dB

MIF = 3.63 dB

RF audio interference level = 36.49 dBV/m

Emission category: M4

Grid 1 M4 36.75 dBV/m	Grid 2 M4 37.48 dBV/m	Grid 3 M4 37.4 dBV/m
Grid 4 M4 35.09 dBV/m	Grid 5 M4 36.49 dBV/m	Grid 6 M4 36.49 dBV/m
Grid 7 M4 33.2 dBV/m	Grid 8 M4 35.32 dBV/m	Grid 9 M4 35.43 dBV/m

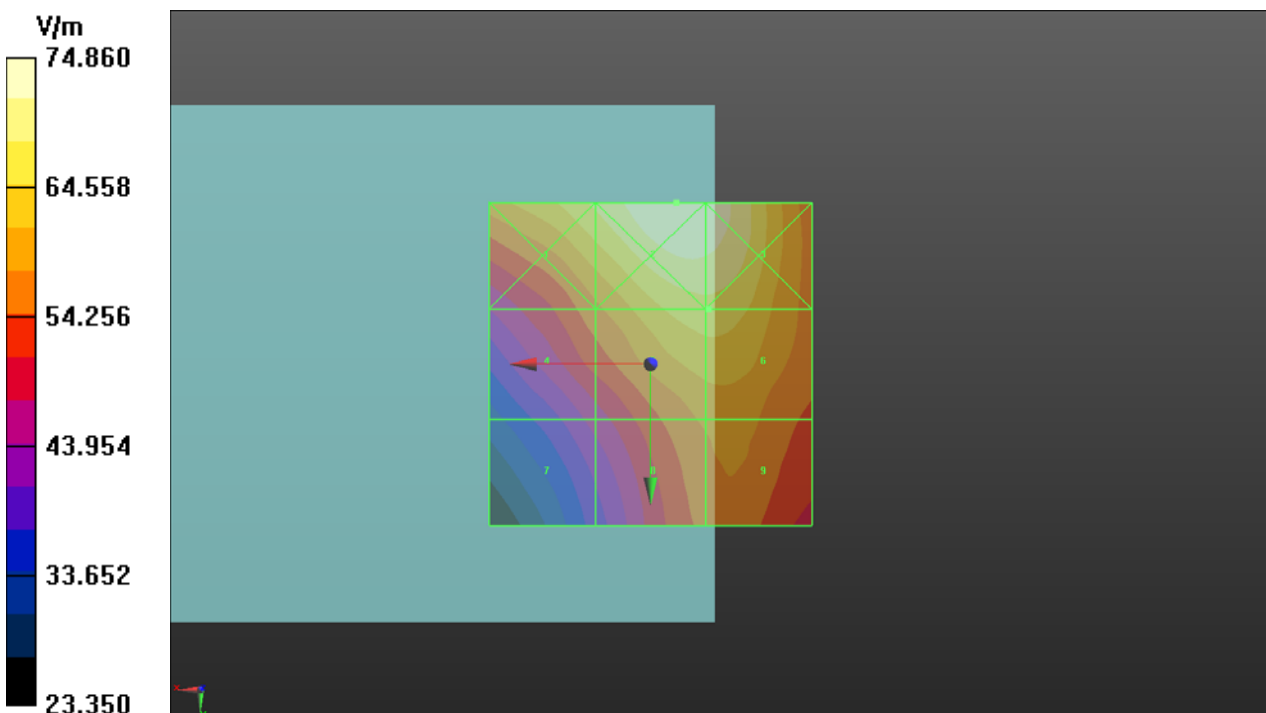

P02 RF_E-Field_GSM1900_GSM_Ch810

DUT: 200605C24

Communication System: UID 10021 - DAC, GSM-FDD (TDMA, GMSK); Frequency: 1909.8 MHz; Duty Cycle: 1:8.7

Medium: Air Medium parameters used: $\sigma = 0$ S/m, $\epsilon_r = 1$; $\rho = 0$ kg/m³

Ambient Temperature : 23.7 °C

DASY5 Configuration:

- Probe: EF3DV3 - SN4049; ConvF(1, 1, 1) @ 1909.8 MHz; Calibrated: 2020/01/24
- Sensor-Surface: (Fix Surface)
- Electronics: DAE4 Sn1585; Calibrated: 2020/05/28
- Phantom: HAC Test Arch with AMCC; Type: SD HAC P01 BA;
- Measurement SW: DASY52, Version 52.10 (4); SEMCAD X Version 14.6.14 (7483)

Hearing Aid Compatibility (101x101x1): Interpolated grid: dx=0.5000 mm, dy=0.5000 mm

Device Reference Point: 0, 0, -6.3 mm

Reference Value = 10.40 V/m; Power Drift = 0.03 dB

MIF = 3.63 dB

RF audio interference level = 26.38 dBV/m

Emission category: M4

Grid 1 M4 21.87 dBV/m	Grid 2 M4 21.08 dBV/m	Grid 3 M4 23.06 dBV/m
Grid 4 M4 24.03 dBV/m	Grid 5 M4 25.88 dBV/m	Grid 6 M4 26.38 dBV/m
Grid 7 M4 27.51 dBV/m	Grid 8 M4 28.49 dBV/m	Grid 9 M4 28.5 dBV/m

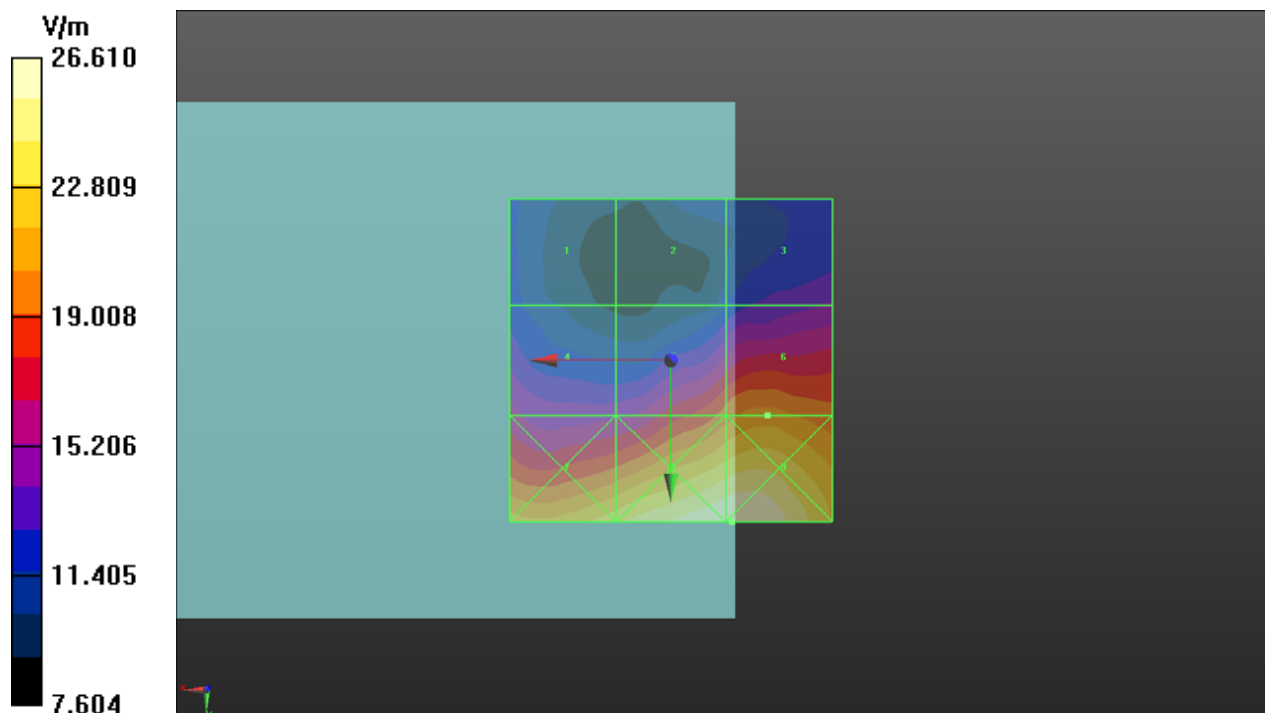

P03 RF_E-Field_LTE 48_QPSK20M_Ch56640_1RB_OS0

DUT: 200605C24

Communication System: UID 10172 - CAG, LTE-TDD (SC-FDMA, 1 RB, 20 MHz, QPSK);

Frequency: 3690 MHz; Duty Cycle: 1:8.33

Medium: Air Medium parameters used: $\sigma = 0$ S/m, $\epsilon_r = 1$; $\rho = 0$ kg/m³

Ambient Temperature : 23.8 °C

DASY5 Configuration:

- Probe: EF3DV3 - SN4049; ConvF(1, 1, 1) @ 3690 MHz; Calibrated: 2020/01/24

- Sensor-Surface: (Fix Surface)

- Electronics: DAE4 Sn1585; Calibrated: 2020/05/28

- Phantom: HAC Test Arch with AMCC; Type: SD HAC P01 BA;

- Measurement SW: DASY52, Version 52.10 (4); SEMCAD X Version 14.6.14 (7483)

Hearing Aid Compatibility (101x101x1): Interpolated grid: dx=0.5000 mm, dy=0.5000 mm

Device Reference Point: 0, 0, -6.3 mm

Reference Value = 7.570 V/m; Power Drift = 0.15 dB

MIF = -1.62 dB

RF audio interference level = 18.10 dBV/m

Emission category: M4

Grid 1 M4 20.41 dBV/m	Grid 2 M4 19.64 dBV/m	Grid 3 M4 18.45 dBV/m
Grid 4 M4 18.1 dBV/m	Grid 5 M4 17.97 dBV/m	Grid 6 M4 15.92 dBV/m
Grid 7 M4 17.7 dBV/m	Grid 8 M4 17.11 dBV/m	Grid 9 M4 16.57 dBV/m

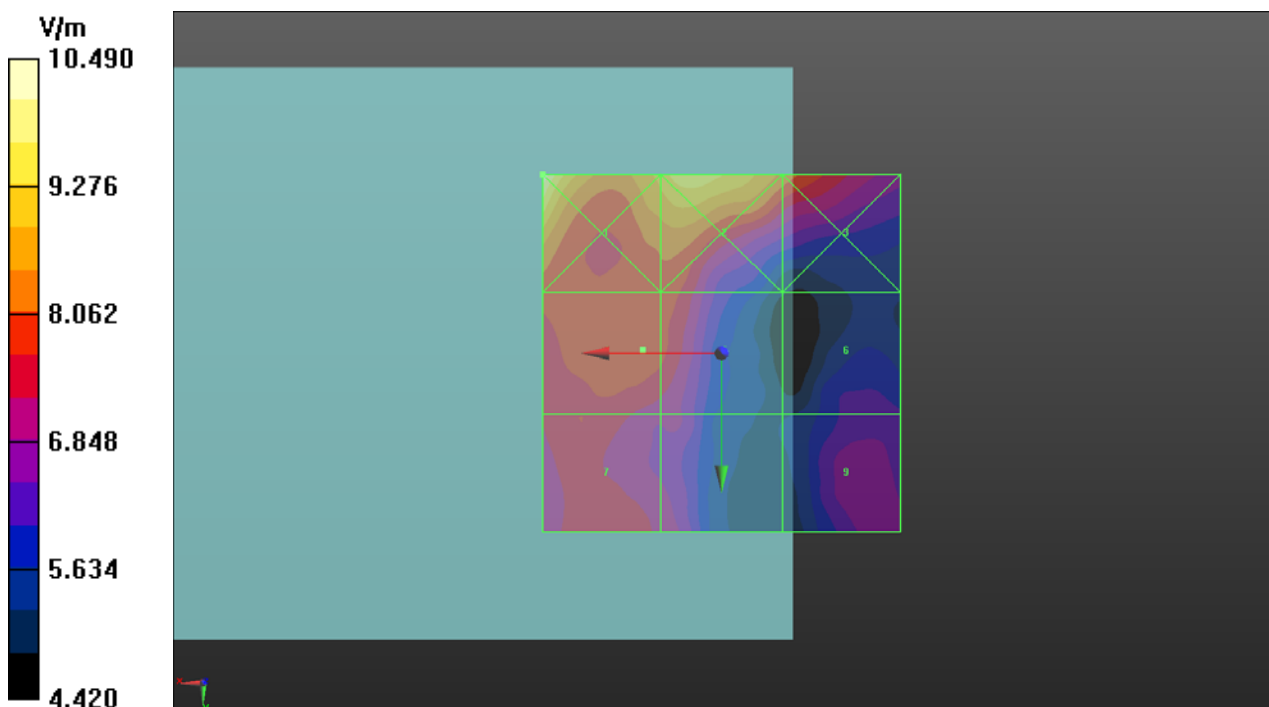

P04 RF_E-Field_WLAN2.4G_802.11g_Ch1_Ant 0+1

DUT: 200605C24

Communication System: UID 10077 - CAB, IEEE 802.11g WiFi 2.4 GHz (DSSS/OFDM, 54 Mbps); Frequency: 2412 MHz; Duty Cycle: 1:12.58

Medium: Air Medium parameters used: $\sigma = 0$ S/m, $\epsilon_r = 1$; $\rho = 0$ kg/m³

Ambient Temperature : 23.7 °C

DASY5 Configuration:

- Probe: EF3DV3 - SN4049; ConvF(1, 1, 1) @ 2412 MHz; Calibrated: 2020/01/24
- Sensor-Surface: (Fix Surface)
- Electronics: DAE4 Sn1585; Calibrated: 2020/05/28
- Phantom: HAC Test Arch with AMCC; Type: SD HAC P01 BA;
- Measurement SW: DASY52, Version 52.10 (4); SEMCAD X Version 14.6.14 (7483)

Hearing Aid Compatibility (101x101x1): Interpolated grid: dx=0.5000 mm, dy=0.5000 mm

Device Reference Point: 0, 0, -6.3 mm

Reference Value = 10.40 V/m; Power Drift = -0.10 dB

MIF = 0.12 dB

RF audio interference level = 21.55 dBV/m

Emission category: M4

Grid 1 M4 20.74 dBV/m	Grid 2 M4 21.59 dBV/m	Grid 3 M4 21.59 dBV/m
Grid 4 M4 18.03 dBV/m	Grid 5 M4 20.43 dBV/m	Grid 6 M4 20.47 dBV/m
Grid 7 M4 20.16 dBV/m	Grid 8 M4 21.55 dBV/m	Grid 9 M4 21.36 dBV/m

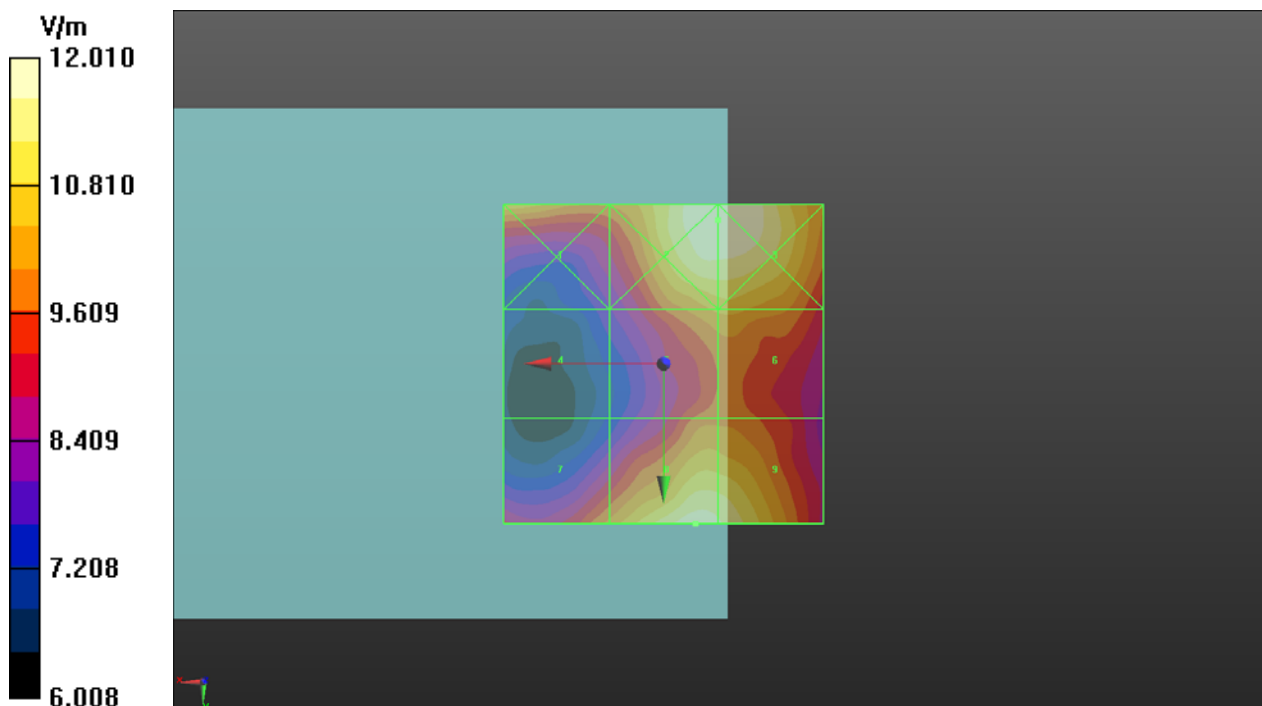

Appendix C. Calibration Certificate for Probe and Dipole

The SPEAG calibration certificates are shown as follows.



Accredited by the Swiss Accreditation Service (SAS)
The Swiss Accreditation Service is one of the signatories to the EA
Multilateral Agreement for the recognition of calibration certificates

Accreditation No.: **SCS 0108**

Client **B.V. ADT (Auden)**

Certificate No: **CD835V3-1041_Jan20**

CALIBRATION CERTIFICATE

Object **CD835V3 - SN: 1041**

Calibration procedure(s) **QA CAL-20.v7
Calibration Procedure for Validation Sources in air**

Calibration date: **January 22, 2020**

This calibration certificate documents the traceability to national standards, which realize the physical units of measurements (SI).
The measurements and the uncertainties with confidence probability are given on the following pages and are part of the certificate.

All calibrations have been conducted in the closed laboratory facility: environment temperature (22 ± 3)°C and humidity < 70%.

Calibration Equipment used (M&TE critical for calibration)

Primary Standards	ID #	Cal Date (Certificate No.)	Scheduled Calibration
Power meter NRP	SN: 104778	03-Apr-19 (No. 217-02892/02893)	Apr-20
Power sensor NRP-Z91	SN: 103244	03-Apr-19 (No. 217-02892)	Apr-20
Power sensor NRP-Z91	SN: 103245	03-Apr-19 (No. 217-02893)	Apr-20
Reference 20 dB Attenuator	SN: 5058 (20k)	04-Apr-19 (No. 217-02894)	Apr-20
Type-N mismatch combination	SN: 5047.2 / 06327	04-Apr-19 (No. 217-02895)	Apr-20
Probe EF3DV3	SN: 4013	31-Dec-19 (No. EF3-4013_Dec19)	Dec-20
DAE4	SN: 781	27-Dec-19 (No. DAE4-781_Dec19)	Dec-20

Secondary Standards	ID #	Check Date (in house)	Scheduled Check
Power meter Agilent 4419B	SN: GB42420191	09-Oct-09 (in house check Oct-17)	In house check: Oct-20
Power sensor HP E4412A	SN: US38485102	05-Jan-10 (in house check Oct-17)	In house check: Oct-20
Power sensor HP 8482A	SN: US37295597	09-Oct-09 (in house check Oct-17)	In house check: Oct-20
RF generator R&S SMT-06	SN: 837633/005	10-Jan-19 (in house check Jan-19)	In house check: Oct-20
Network Analyzer Agilent E8358A	SN: US41080477	31-Mar-14 (in house check Oct-19)	In house check: Oct-20

	Name	Function	Signature
Calibrated by:	Claudio Leubler	Laboratory Technician	
Approved by:	Katja Pokovic	Technical Manager	

Issued: January 23, 2020

This calibration certificate shall not be reproduced except in full without written approval of the laboratory.



Accredited by the Swiss Accreditation Service (SAS)

The Swiss Accreditation Service is one of the signatories to the EA
Multilateral Agreement for the recognition of calibration certificates

Accreditation No.: **SCS 0108**

References

- [1] ANSI-C63.19-2011
American National Standard, Methods of Measurement of Compatibility between Wireless Communications
Devices and Hearing Aids.

Methods Applied and Interpretation of Parameters:

- **Coordinate System:** y-axis is in the direction of the dipole arms. z-axis is from the basis of the antenna (mounted on the table) towards its feed point between the two dipole arms. x-axis is normal to the other axes. In coincidence with the standards [1], the measurement planes (probe sensor center) are selected to be at a distance of 15 mm above the top metal edge of the dipole arms.
- **Measurement Conditions:** Further details are available from the hardcopies at the end of the certificate. All figures stated in the certificate are valid at the frequency indicated. The forward power to the dipole connector is set with a calibrated power meter connected and monitored with an auxiliary power meter connected to a directional coupler. While the dipole under test is connected, the forward power is adjusted to the same level.
- **Antenna Positioning:** The dipole is mounted on a HAC Test Arch phantom using the matching dipole positioner with the arms horizontal and the feeding cable coming from the floor. The measurements are performed in a shielded room with absorbers around the setup to reduce the reflections. It is verified before the mounting of the dipole under the Test Arch phantom, that its arms are perfectly in a line. It is installed on the HAC dipole positioner with its arms parallel below the dielectric reference wire and able to move elastically in vertical direction without changing its relative position to the top center of the Test Arch phantom. The vertical distance to the probe is adjusted after dipole mounting with a DASY5 Surface Check job. Before the measurement, the distance between phantom surface and probe tip is verified. The proper measurement distance is selected by choosing the matching section of the HAC Test Arch phantom with the proper device reference point (upper surface of the dipole) and the matching grid reference point (tip of the probe) considering the probe sensor offset. The vertical distance to the probe is essential for the accuracy.
- **Feed Point Impedance and Return Loss:** These parameters are measured using a Vector Network Analyzer. The impedance is specified at the SMA connector of the dipole. The influence of reflections was eliminated by applying the averaging function while moving the dipole in the air, at least 70cm away from any obstacles.
- **E-field distribution:** E field is measured in the x-y-plane with an isotropic E-field probe with 100 mW forward power to the antenna feed point. In accordance with [1], the scan area is 20mm wide, its length exceeds the dipole arm length (180 or 90mm). The sensor center is 15 mm (in z) above the metal top of the dipole arms. Two 3D maxima are available near the end of the dipole arms. Assuming the dipole arms are perfectly in one line, the average of these two maxima (in subgrid 2 and subgrid 8) is determined to compensate for any non-parallelity to the measurement plane as well as the sensor displacement. The E-field value stated as calibration value represents the maximum of the interpolated 3D-E-field, in the plane above the dipole surface.

The reported uncertainty of measurement is stated as the standard uncertainty of measurement multiplied by the coverage factor $k=2$, which for a normal distribution corresponds to a coverage probability of approximately 95%.

Measurement Conditions

DASY system configuration, as far as not given on page 1.

DASY Version	DASY5	V52.10.3
Phantom	HAC Test Arch	
Distance Dipole Top - Probe Center	15 mm	
Scan resolution	dx, dy = 5 mm	
Frequency	835 MHz \pm 1 MHz	
Input power drift	< 0.05 dB	

Maximum Field values at 835 MHz

E-field 15 mm above dipole surface	condition	Interpolated maximum
Maximum measured above high end	100 mW input power	107.7 V/m = 40.64 dBV/m
Maximum measured above low end	100 mW input power	105.7 V/m = 40.48 dBV/m
Averaged maximum above arm	100 mW input power	106.7 V/m \pm 12.8 % (k=2)

Appendix (Additional assessments outside the scope of SCS 0108)

Antenna Parameters

Frequency	Return Loss	Impedance
800 MHz	15.6 dB	38.4 Ω - 9.1 j Ω
835 MHz	33.2 dB	50.1 Ω + 2.2 j Ω
880 MHz	18.1 dB	58.4 Ω - 10.6 j Ω
900 MHz	17.7 dB	50.3 Ω - 13.2 j Ω
945 MHz	21.7 dB	48.9 Ω + 8.0 j Ω

3.2 Antenna Design and Handling

The calibration dipole has a symmetric geometry with a built-in two stub matching network, which leads to the enhanced bandwidth.

The dipole is built of standard semirigid coaxial cable. The internal matching line is open ended. The antenna is therefore open for DC signals.

Do not apply force to dipole arms, as they are liable to bend. The soldered connections near the feedpoint may be damaged. After excessive mechanical stress or overheating, check the impedance characteristics to ensure that the internal matching network is not affected.

After long term use with 40W radiated power, only a slight warming of the dipole near the feedpoint can be measured.

Impedance Measurement Plot

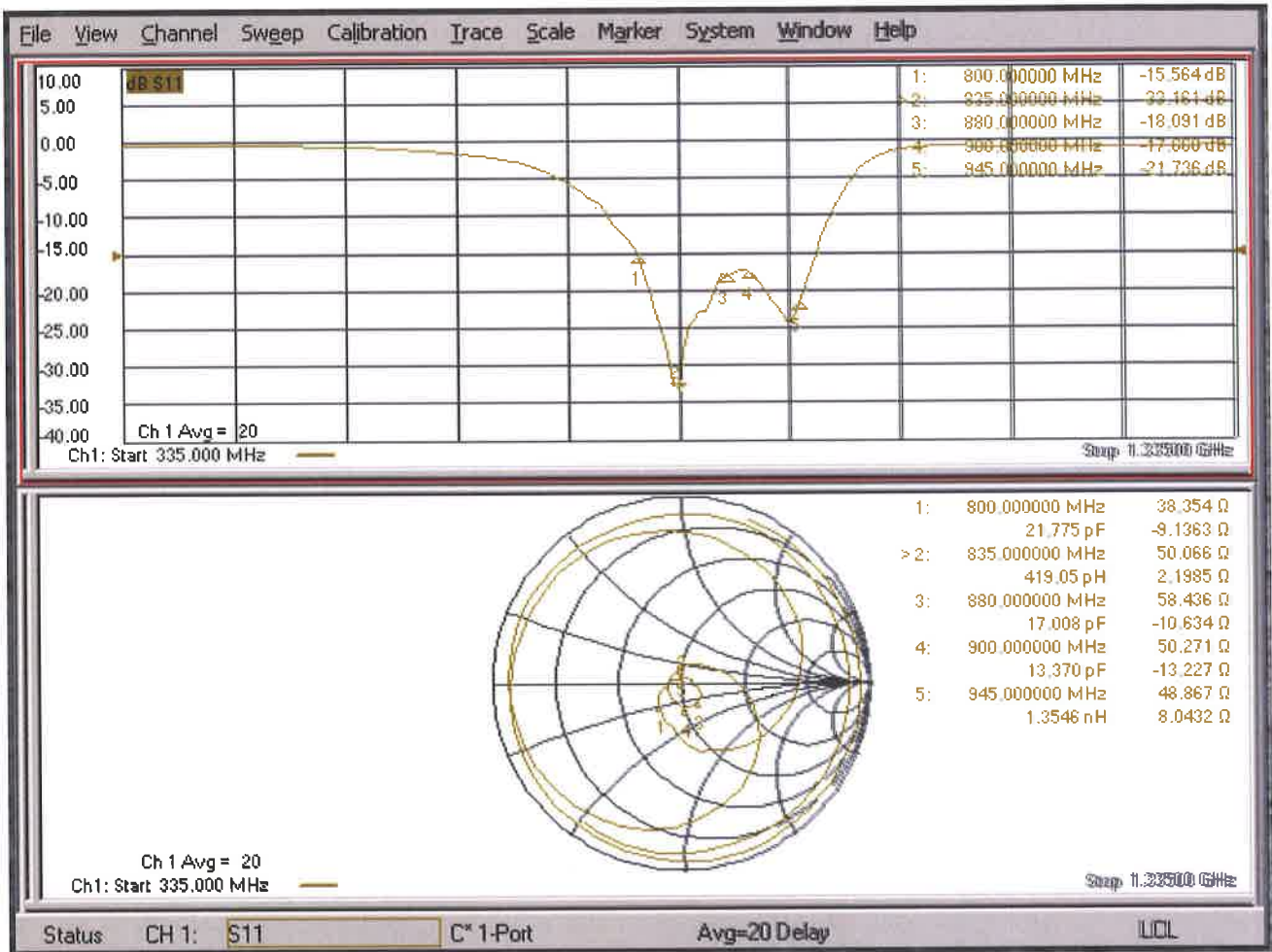

DASY5 E-field Result

Date: 22.01.2020

Test Laboratory: SPEAG Lab2

DUT: HAC-Dipole 835 MHz; Type: CD835V3; Serial: CD835V3 - SN: 1041

Communication System: UID 0 - CW; Frequency: 835 MHz

Medium parameters used: $\sigma = 0$ S/m, $\epsilon_r = 1$; $\rho = 0$ kg/m³

Phantom section: RF Section

Measurement Standard: DASY5 (IEEE/IEC/ANSI C63.19-2011)

DASY52 Configuration:

- Probe: EF3DV3 - SN4013; ConvF(1, 1, 1) @ 835 MHz; Calibrated: 31.12.2019
- Sensor-Surface: (Fix Surface)
- Electronics: DAE4 Sn781; Calibrated: 27.12.2019
- Phantom: HAC Test Arch with AMCC; Type: SD HAC P01 BA; Serial: 1070
- DASY52 52.10.3(1513); SEMCAD X 14.6.13(7474)

Dipole E-Field measurement @ 835MHz/E-Scan - 835MHz d=15mm/Hearing Aid Compatibility Test (41x361x1):

Interpolated grid: dx=0.5000 mm, dy=0.5000 mm

Device Reference Point: 0, 0, -6.3 mm

Reference Value = 125.0 V/m; Power Drift = -0.01 dB

Applied MIF = 0.00 dB

RF audio interference level = 40.64 dBV/m

Emission category: M3

MIF scaled E-field

Grid 1 M3 40.1 dBV/m	Grid 2 M3 40.64 dBV/m	Grid 3 M3 40.63 dBV/m
Grid 4 M4 35.29 dBV/m	Grid 5 M4 35.81 dBV/m	Grid 6 M4 35.81 dBV/m
Grid 7 M4 39.89 dBV/m	Grid 8 M3 40.48 dBV/m	Grid 9 M3 40.48 dBV/m

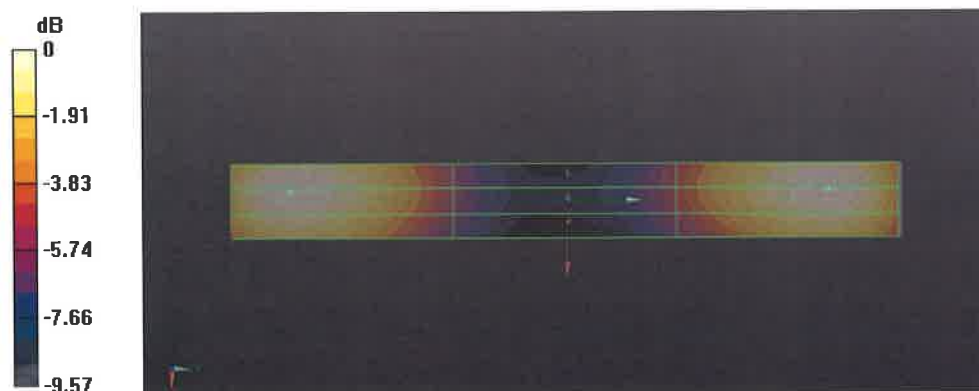

0 dB = 107.7 V/m = 40.64 dBV/m



Accredited by the Swiss Accreditation Service (SAS)
The Swiss Accreditation Service is one of the signatories to the EA
Multilateral Agreement for the recognition of calibration certificates

Accreditation No.: **SCS 0108**

Client **B.V. ADT (Auden)**

Certificate No: **CD1880V3-1032_Jan20**

CALIBRATION CERTIFICATE

Object **CD1880V3 - SN: 1032**

Calibration procedure(s) **QA CAL-20.v7
Calibration Procedure for Validation Sources in air**

Calibration date: **January 22, 2020**

This calibration certificate documents the traceability to national standards, which realize the physical units of measurements (SI).
The measurements and the uncertainties with confidence probability are given on the following pages and are part of the certificate.

All calibrations have been conducted in the closed laboratory facility: environment temperature (22 ± 3)°C and humidity < 70%.

Calibration Equipment used (M&TE critical for calibration)

Primary Standards	ID #	Cal Date (Certificate No.)	Scheduled Calibration
Power meter NRP	SN: 104778	03-Apr-19 (No. 217-02892/02893)	Apr-20
Power sensor NRP-Z91	SN: 103244	03-Apr-19 (No. 217-02892)	Apr-20
Power sensor NRP-Z91	SN: 103245	03-Apr-19 (No. 217-02893)	Apr-20
Reference 20 dB Attenuator	SN: 5058 (20k)	04-Apr-19 (No. 217-02894)	Apr-20
Type-N mismatch combination	SN: 5047.2 / 06327	04-Apr-19 (No. 217-02895)	Apr-20
Probe EF3DV3	SN: 4013	31-Dec-19 (No. EF3-4013_Dec19)	Dec-20
DAE4	SN: 781	27-Dec-19 (No. DAE4-781_Dec19)	Dec-20

Secondary Standards	ID #	Check Date (in house)	Scheduled Check
Power meter Agilent 4419B	SN: GB42420191	09-Oct-09 (in house check Oct-17)	In house check: Oct-20
Power sensor HP E4412A	SN: US38485102	05-Jan-10 (in house check Oct-17)	In house check: Oct-20
Power sensor HP 8482A	SN: US37295597	09-Oct-09 (in house check Oct-17)	In house check: Oct-20
RF generator R&S SMT-06	SN: 837633/005	10-Jan-19 (in house check Jan-19)	In house check: Oct-20
Network Analyzer Agilent E8358A	SN: US41080477	31-Mar-14 (in house check Oct-19)	In house check: Oct-20

Calibrated by: **Name** Claudio Leubler **Function** Laboratory Technician

Signature

Approved by: **Name** Katja Pokovic **Function** Technical Manager

Issued: January 23, 2020

This calibration certificate shall not be reproduced except in full without written approval of the laboratory.



Accredited by the Swiss Accreditation Service (SAS)

The Swiss Accreditation Service is one of the signatories to the EA
Multilateral Agreement for the recognition of calibration certificates

Accreditation No.: **SCS 0108**

References

- [1] ANSI-C63.19-2011
American National Standard, Methods of Measurement of Compatibility between Wireless Communications Devices and Hearing Aids.

Methods Applied and Interpretation of Parameters:

- **Coordinate System:** y-axis is in the direction of the dipole arms. z-axis is from the basis of the antenna (mounted on the table) towards its feed point between the two dipole arms. x-axis is normal to the other axes. In coincidence with the standards [1], the measurement planes (probe sensor center) are selected to be at a distance of 15 mm above the top metal edge of the dipole arms.
- **Measurement Conditions:** Further details are available from the hardcopies at the end of the certificate. All figures stated in the certificate are valid at the frequency indicated. The forward power to the dipole connector is set with a calibrated power meter connected and monitored with an auxiliary power meter connected to a directional coupler. While the dipole under test is connected, the forward power is adjusted to the same level.
- **Antenna Positioning:** The dipole is mounted on a HAC Test Arch phantom using the matching dipole positioner with the arms horizontal and the feeding cable coming from the floor. The measurements are performed in a shielded room with absorbers around the setup to reduce the reflections. It is verified before the mounting of the dipole under the Test Arch phantom, that its arms are perfectly in a line. It is installed on the HAC dipole positioner with its arms parallel below the dielectric reference wire and able to move elastically in vertical direction without changing its relative position to the top center of the Test Arch phantom. The vertical distance to the probe is adjusted after dipole mounting with a DASY5 Surface Check job. Before the measurement, the distance between phantom surface and probe tip is verified. The proper measurement distance is selected by choosing the matching section of the HAC Test Arch phantom with the proper device reference point (upper surface of the dipole) and the matching grid reference point (tip of the probe) considering the probe sensor offset. The vertical distance to the probe is essential for the accuracy.
- **Feed Point Impedance and Return Loss:** These parameters are measured using a Vector Network Analyzer. The impedance is specified at the SMA connector of the dipole. The influence of reflections was eliminated by applying the averaging function while moving the dipole in the air, at least 70cm away from any obstacles.
- **E-field distribution:** E field is measured in the x-y-plane with an isotropic E-field probe with 100 mW forward power to the antenna feed point. In accordance with [1], the scan area is 20mm wide, its length exceeds the dipole arm length (180 or 90mm). The sensor center is 15 mm (in z) above the metal top of the dipole arms. Two 3D maxima are available near the end of the dipole arms. Assuming the dipole arms are perfectly in one line, the average of these two maxima (in subgrid 2 and subgrid 8) is determined to compensate for any non-parallelity to the measurement plane as well as the sensor displacement. The E-field value stated as calibration value represents the maximum of the interpolated 3D-E-field, in the plane above the dipole surface.

The reported uncertainty of measurement is stated as the standard uncertainty of measurement multiplied by the coverage factor $k=2$, which for a normal distribution corresponds to a coverage probability of approximately 95%.

Measurement Conditions

DASY system configuration, as far as not given on page 1.

DASY Version	DASY5	V52.10.3
Phantom	HAC Test Arch	
Distance Dipole Top - Probe Center	15 mm	
Scan resolution	dx, dy = 5 mm	
Frequency	1880 MHz \pm 1 MHz	
Input power drift	< 0.05 dB	

Maximum Field values at 1880 MHz

E-field 15 mm above dipole surface	condition	Interpolated maximum
Maximum measured above high end	100 mW input power	89.8 V/m = 39.06 dBV/m
Maximum measured above low end	100 mW input power	86.6 V/m = 38.75 dBV/m
Averaged maximum above arm	100 mW input power	88.2 V/m \pm 12.8 % (k=2)

Appendix (Additional assessments outside the scope of SCS 0108)

Antenna Parameters

Frequency	Return Loss	Impedance
1730 MHz	25.6 dB	54.6 Ω + 3.0 j Ω
1880 MHz	22.4 dB	57.3 Ω + 3.5 j Ω
1900 MHz	22.7 dB	57.8 Ω + 1.0 j Ω
1950 MHz	28.5 dB	52.8 Ω - 2.6 j Ω
2000 MHz	24.9 dB	47.7 Ω + 5.0 j Ω

3.2 Antenna Design and Handling

The calibration dipole has a symmetric geometry with a built-in two stub matching network, which leads to the enhanced bandwidth.

The dipole is built of standard semirigid coaxial cable. The internal matching line is open ended. The antenna is therefore open for DC signals.

Do not apply force to dipole arms, as they are liable to bend. The soldered connections near the feedpoint may be damaged. After excessive mechanical stress or overheating, check the impedance characteristics to ensure that the internal matching network is not affected.

After long term use with 40W radiated power, only a slight warming of the dipole near the feedpoint can be measured.

Impedance Measurement Plot

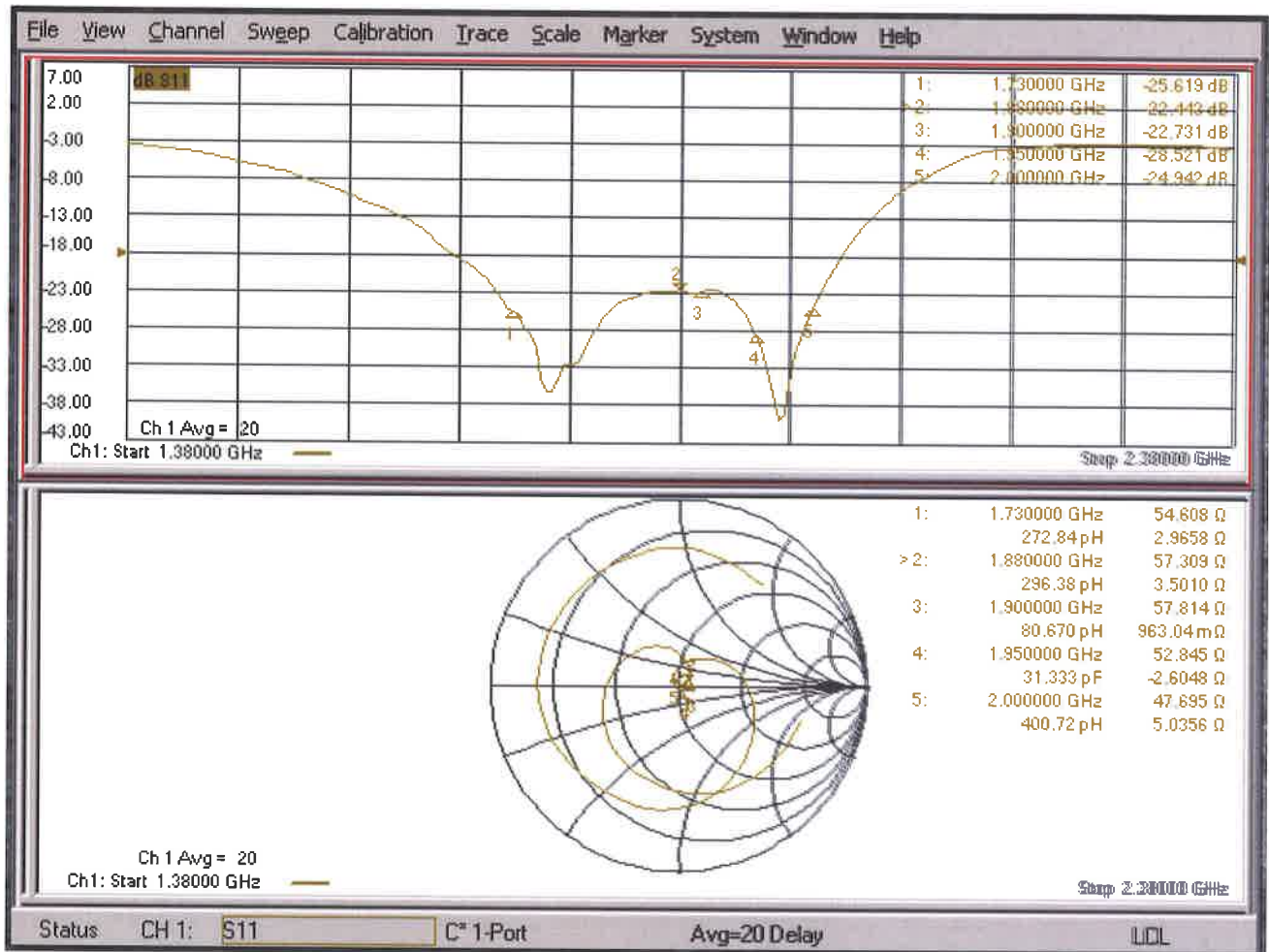

DASY5 E-field Result

Date: 22.01.2020

Test Laboratory: SPEAG Lab2

DUT: HAC Dipole 1880 MHz; Type: CD1880V3; Serial: CD1880V3 - SN: 1032

Communication System: UID 0 - CW; Frequency: 1880 MHz
Medium parameters used: $\sigma = 0$ S/m, $\epsilon_r = 1$; $\rho = 0$ kg/m³
Phantom section: RF Section
Measurement Standard: DASY5 (IEEE/IEC/ANSI C63.19-2011)

DASY52 Configuration:

- Probe: EF3DV3 - SN4013; ConvF(1, 1, 1) @ 1880 MHz; Calibrated: 31.12.2019
- Sensor-Surface: (Fix Surface)
- Electronics: DAE4 Sn781; Calibrated: 27.12.2019
- Phantom: HAC Test Arch with AMCC; Type: SD HAC P01 BA; Serial: 1070
- DASY52 52.10.3(1513); SEMCAD X 14.6.13(7474)

Dipole E-Field measurement @ 1880MHz/E-Scan - 1880MHz d=15mm/Hearing Aid Compatibility Test (41x181x1):

Interpolated grid: dx=0.5000 mm, dy=0.5000 mm
Device Reference Point: 0, 0, -6.3 mm
Reference Value = 147.5 V/m; Power Drift = -0.01 dB
Applied MIF = 0.00 dB
RF audio interference level = 39.06 dBV/m
Emission category: M2

MIF scaled E-field

Grid 1 M2 38.37 dBV/m	Grid 2 M2 39.06 dBV/m	Grid 3 M2 39.06 dBV/m
Grid 4 M2 35.95 dBV/m	Grid 5 M2 36.15 dBV/m	Grid 6 M2 36.12 dBV/m
Grid 7 M2 38.45 dBV/m	Grid 8 M2 38.75 dBV/m	Grid 9 M2 38.66 dBV/m

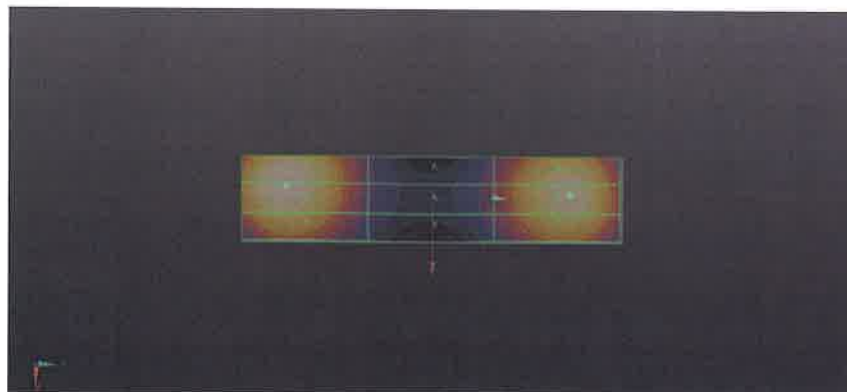
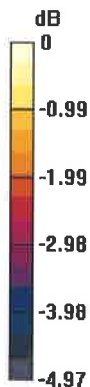

0 dB = 89.78 V/m = 39.06 dBV/m



Accredited by the Swiss Accreditation Service (SAS)
The Swiss Accreditation Service is one of the signatories to the EA
Multilateral Agreement for the recognition of calibration certificates

Accreditation No.: **SCS 0108**

Client **B.V. ADT (Auden)**

Certificate No: **CD2450V3-1033_Jan20**

CALIBRATION CERTIFICATE

Object **CD2450V3 - SN: 1033**

Calibration procedure(s) **QA CAL-20.v7
Calibration Procedure for Validation Sources in air**

Calibration date: **January 22, 2020**

This calibration certificate documents the traceability to national standards, which realize the physical units of measurements (SI).
The measurements and the uncertainties with confidence probability are given on the following pages and are part of the certificate.

All calibrations have been conducted in the closed laboratory facility: environment temperature (22 ± 3)°C and humidity < 70%.

Calibration Equipment used (M&TE critical for calibration)

Primary Standards	ID #	Cal Date (Certificate No.)	Scheduled Calibration
Power meter NRP	SN: 104778	03-Apr-19 (No. 217-02892/02893)	Apr-20
Power sensor NRP-Z91	SN: 103244	03-Apr-19 (No. 217-02892)	Apr-20
Power sensor NRP-Z91	SN: 103245	03-Apr-19 (No. 217-02893)	Apr-20
Reference 20 dB Attenuator	SN: 5058 (20k)	04-Apr-19 (No. 217-02894)	Apr-20
Type-N mismatch combination	SN: 5047.2 / 06327	04-Apr-19 (No. 217-02895)	Apr-20
Probe EF3DV3	SN: 4013	31-Dec-19 (No. EF3-4013_Dec19)	Dec-20
DAE4	SN: 781	27-Dec-19 (No. DAE4-781_Dec19)	Dec-20

Secondary Standards	ID #	Check Date (in house)	Scheduled Check
Power meter Agilent 4419B	SN: GB42420191	09-Oct-09 (in house check Oct-17)	In house check: Oct-20
Power sensor HP E4412A	SN: US38485102	05-Jan-10 (in house check Oct-17)	In house check: Oct-20
Power sensor HP 8482A	SN: US37295597	09-Oct-09 (in house check Oct-17)	In house check: Oct-20
RF generator R&S SMT-06	SN: 837633/005	10-Jan-19 (in house check Jan-19)	In house check: Oct-20
Network Analyzer Agilent E8358A	SN: US41080477	31-Mar-14 (in house check Oct-19)	In house check: Oct-20

	Name	Function	Signature
Calibrated by:	Claudio Leubler	Laboratory Technician	
Approved by:	Katja Pokovic	Technical Manager	

Issued: January 23, 2020

This calibration certificate shall not be reproduced except in full without written approval of the laboratory.



Accredited by the Swiss Accreditation Service (SAS)

The Swiss Accreditation Service is one of the signatories to the EA
Multilateral Agreement for the recognition of calibration certificates

References

- [1] ANSI-C63.19-2011
American National Standard, Methods of Measurement of Compatibility between Wireless Communications
Devices and Hearing Aids.

Methods Applied and Interpretation of Parameters:

- **Coordinate System:** y-axis is in the direction of the dipole arms. z-axis is from the basis of the antenna (mounted on the table) towards its feed point between the two dipole arms. x-axis is normal to the other axes. In coincidence with the standards [1], the measurement planes (probe sensor center) are selected to be at a distance of 15 mm above the top metal edge of the dipole arms.
- **Measurement Conditions:** Further details are available from the hardcopies at the end of the certificate. All figures stated in the certificate are valid at the frequency indicated. The forward power to the dipole connector is set with a calibrated power meter connected and monitored with an auxiliary power meter connected to a directional coupler. While the dipole under test is connected, the forward power is adjusted to the same level.
- **Antenna Positioning:** The dipole is mounted on a HAC Test Arch phantom using the matching dipole positioner with the arms horizontal and the feeding cable coming from the floor. The measurements are performed in a shielded room with absorbers around the setup to reduce the reflections. It is verified before the mounting of the dipole under the Test Arch phantom, that its arms are perfectly in a line. It is installed on the HAC dipole positioner with its arms parallel below the dielectric reference wire and able to move elastically in vertical direction without changing its relative position to the top center of the Test Arch phantom. The vertical distance to the probe is adjusted after dipole mounting with a DASY5 Surface Check job. Before the measurement, the distance between phantom surface and probe tip is verified. The proper measurement distance is selected by choosing the matching section of the HAC Test Arch phantom with the proper device reference point (upper surface of the dipole) and the matching grid reference point (tip of the probe) considering the probe sensor offset. The vertical distance to the probe is essential for the accuracy.
- **Feed Point Impedance and Return Loss:** These parameters are measured using a Vector Network Analyzer. The impedance is specified at the SMA connector of the dipole. The influence of reflections was eliminated by applying the averaging function while moving the dipole in the air, at least 70cm away from any obstacles.
- **E-field distribution:** E field is measured in the x-y-plane with an isotropic E-field probe with 100 mW forward power to the antenna feed point. In accordance with [1], the scan area is 20mm wide, its length exceeds the dipole arm length (180 or 90mm). The sensor center is 15 mm (in z) above the metal top of the dipole arms. Two 3D maxima are available near the end of the dipole arms. Assuming the dipole arms are perfectly in one line, the average of these two maxima (in subgrid 2 and subgrid 8) is determined to compensate for any non-parallelity to the measurement plane as well as the sensor displacement. The E-field value stated as calibration value represents the maximum of the interpolated 3D-E-field, in the plane above the dipole surface.

The reported uncertainty of measurement is stated as the standard uncertainty of measurement multiplied by the coverage factor $k=2$, which for a normal distribution corresponds to a coverage probability of approximately 95%.

Measurement Conditions

DASY system configuration, as far as not given on page 1.

DASY Version	DASY5	V52.10.3
Phantom	HAC Test Arch	
Distance Dipole Top - Probe Center	15 mm	
Scan resolution	dx, dy = 5 mm	
Frequency	2450 MHz \pm 1 MHz	
Input power drift	< 0.05 dB	

Maximum Field values at 2450 MHz

E-field 15 mm above dipole surface	condition	Interpolated maximum
Maximum measured above high end	100 mW input power	85.1 V/m = 38.59 dBV/m
Maximum measured above low end	100 mW input power	85.0 V/m = 38.59 dBV/m
Averaged maximum above arm	100 mW input power	85.1 V/m \pm 12.8 % (k=2)

Appendix (Additional assessments outside the scope of SCS 0108)

Antenna Parameters

Frequency	Return Loss	Impedance
2250 MHz	17.7 dB	65.0 Ω - 1.3 j Ω
2350 MHz	29.9 dB	51.8 Ω - 2.7 j Ω
2450 MHz	31.2 dB	52.3 Ω - 1.7 j Ω
2550 MHz	37.2 dB	51.0 Ω - 0.9 j Ω
2650 MHz	18.3 dB	58.2 Ω - 10.5 j Ω

3.2 Antenna Design and Handling

The calibration dipole has a symmetric geometry with a built-in two stub matching network, which leads to the enhanced bandwidth.

The dipole is built of standard semirigid coaxial cable. The internal matching line is open ended. The antenna is therefore open for DC signals.

Do not apply force to dipole arms, as they are liable to bend. The soldered connections near the feedpoint may be damaged. After excessive mechanical stress or overheating, check the impedance characteristics to ensure that the internal matching network is not affected.

After long term use with 40W radiated power, only a slight warming of the dipole near the feedpoint can be measured.

Impedance Measurement Plot

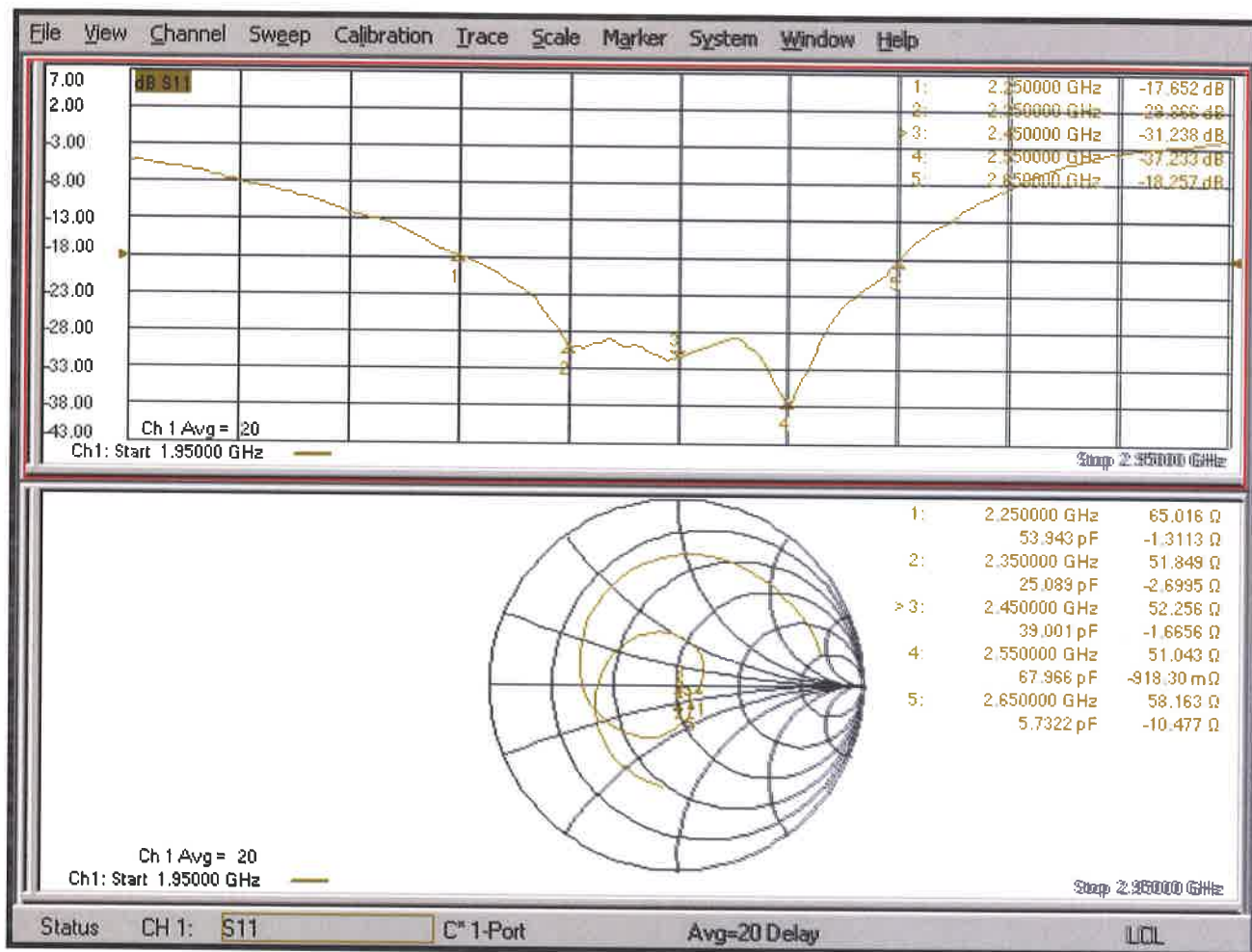

DASY5 E-field Result

Date: 22.01.2020

Test Laboratory: SPEAG Lab2

DUT: HAC Dipole 2450 MHz; Type: CD2450V3; Serial: CD2450V3 - SN: 1033

Communication System: UID 0 - CW; Frequency: 2450 MHz
Medium parameters used: $\sigma = 0 \text{ S/m}$, $\epsilon_r = 1$; $\rho = 0 \text{ kg/m}^3$
Phantom section: RF Section
Measurement Standard: DASY5 (IEEE/IEC/ANSI C63.19-2011)

DASY52 Configuration:

- Probe: EF3DV3 - SN4013; ConvF(1, 1, 1) @ 2450 MHz; Calibrated: 31.12.2019
- Sensor-Surface: (Fix Surface)
- Electronics: DAE4 Sn781; Calibrated: 27.12.2019
- Phantom: HAC Test Arch with AMCC; Type: SD HAC P01 BA; Serial: 1070
- DASY52 52.10.3(1513); SEMCAD X 14.6.13(7474)

Dipole E-Field measurement @ 2450MHz/E-Scan - 2450MHz d=15mm/Hearing Aid Compatibility Test (41x181x1):

Interpolated grid: dx=0.5000 mm, dy=0.5000 mm

Device Reference Point: 0, 0, -6.3 mm

Reference Value = 71.71 V/m; Power Drift = -0.02 dB

Applied MIF = 0.00 dB

RF audio interference level = 38.59 dBV/m

Emission category: M2

MIF scaled E-field

Grid 1 M2 38 dBV/m	Grid 2 M2 38.59 dBV/m	Grid 3 M2 38.59 dBV/m
Grid 4 M2 37.53 dBV/m	Grid 5 M2 37.76 dBV/m	Grid 6 M2 37.71 dBV/m
Grid 7 M2 38.32 dBV/m	Grid 8 M2 38.59 dBV/m	Grid 9 M2 38.5 dBV/m

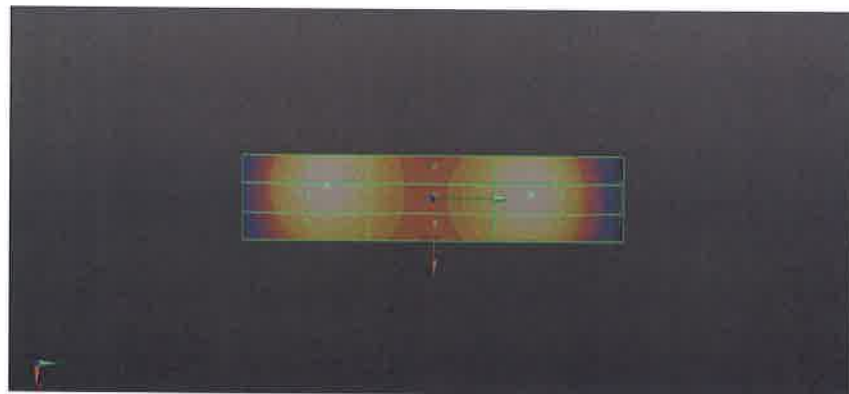
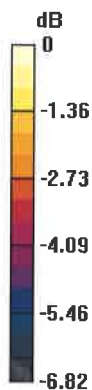

0 dB = 85.02 V/m = 38.59 dBV/m



Accredited by the Swiss Accreditation Service (SAS)
The Swiss Accreditation Service is one of the signatories to the EA
Multilateral Agreement for the recognition of calibration certificates

Accreditation No.: **SCS 0108**

Client **B.V. ADT (Auden)**

Certificate No: **EF3-4049_Jan20**

CALIBRATION CERTIFICATE

Object **EF3DV3- SN:4049**

Calibration procedure(s) **QA CAL-02.v9, QA CAL-25.v7
Calibration procedure for E-field probes optimized for close near field
evaluations in air**

Calibration date: **January 24, 2020**

This calibration certificate documents the traceability to national standards, which realize the physical units of measurements (SI).
The measurements and the uncertainties with confidence probability are given on the following pages and are part of the certificate.

All calibrations have been conducted in the closed laboratory facility: environment temperature (22 ± 3)°C and humidity < 70%.

Calibration Equipment used (M&TE critical for calibration)

Primary Standards	ID	Cal Date (Certificate No.)	Scheduled Calibration
Power meter NRP	SN: 104778	03-Apr-19 (No. 217-02892/02893)	Apr-20
Power sensor NRP-Z91	SN: 103244	03-Apr-19 (No. 217-02892)	Apr-20
Power sensor NRP-Z91	SN: 103245	03-Apr-19 (No. 217-02893)	Apr-20
Reference 20 dB Attenuator	SN: S5277 (20x)	04-Apr-19 (No. 217-02894)	Apr-20
DAE4	SN: 789	27-Dec-19 (No. DAE4-789_Dec19)	Dec-20
Reference Probe ER3DV6	SN: 2328	05-Oct-19 (No. ER3-2328_Oct19)	Oct-20
Secondary Standards	ID	Check Date (in house)	Scheduled Check
Power meter E4419B	SN: GB41293874	06-Apr-16 (in house check Jun-18)	In-house check: Jun-20
Power sensor E4412A	SN: MY41498087	06-Apr-16 (in house check Jun-18)	In house check: Jun-20
Power sensor E4412A	SN: 000110210	06-Apr-16 (in house check Jun-18)	In house check: Jun-20
RF generator HP 8648C	SN: US3642U01700	04-Aug-99 (in house check Jun-18)	In house check: Jun-20
Network Analyzer E8358A	SN: US41080477	31-Mar-14 (in house check Oct-19)	In house check: Oct-20

	Name	Function	Signature
Calibrated by:	Jeton Kastrati	Laboratory Technician	
Approved by:	Katja Pokovic	Technical Manager	

Issued: January 30, 2020

This calibration certificate shall not be reproduced except in full without written approval of the laboratory.



Accredited by the Swiss Accreditation Service (SAS)

Accreditation No.: **SCS 0108**

The Swiss Accreditation Service is one of the signatories to the EA
Multilateral Agreement for the recognition of calibration certificates

Glossary:

NORM _{x,y,z}	sensitivity in free space
DCP	diode compression point
CF	crest factor (1/duty_cycle) of the RF signal
A, B, C, D	modulation dependent linearization parameters
E _n	incident E-field orientation normal to probe axis
E _p	incident E-field orientation parallel to probe axis
Polarization φ	φ rotation around probe axis
Polarization ϑ	ϑ rotation around an axis that is in the plane normal to probe axis (at measurement center), i.e., $\vartheta = 0$ is normal to probe axis
Connector Angle	information used in DASY system to align probe sensor X to the robot coordinate system

Calibration is Performed According to the Following Standards:

- IEEE Std 1309-2005, "IEEE Standard for calibration of electromagnetic field sensors and probes, excluding antennas, from 9 kHz to 40 GHz", December 2005
- CTIA Test Plan for Hearing Aid Compatibility, Rev 3.1.1, May 2017

Methods Applied and Interpretation of Parameters:

- NORM_{x,y,z}**: Assessed for E-field polarization $\vartheta = 0$ for XY sensors and $\vartheta = 90$ for Z sensor ($f \leq 900$ MHz in TEM-cell; $f > 1800$ MHz: R22 waveguide).
- NORM(f)_{x,y,z}** = NORM_{x,y,z} * frequency_response (see Frequency Response Chart).
- DCP_{x,y,z}**: DCP are numerical linearization parameters assessed based on the data of power sweep with CW signal (no uncertainty required). DCP does not depend on frequency nor media.
- PAR**: PAR is the Peak to Average Ratio that is not calibrated but determined based on the signal characteristics
- A_{x,y,z}; B_{x,y,z}; C_{x,y,z}; D_{x,y,z}; VR_{x,y,z}**: A, B, C, D are numerical linearization parameters assessed based on the data of power sweep for specific modulation signal. The parameters do not depend on frequency nor media. VR is the maximum calibration range expressed in RMS voltage across the diode.
- Spherical isotropy (3D deviation from isotropy)**: in a locally homogeneous field realized using an open waveguide setup.
- Sensor Offset**: The sensor offset corresponds to the offset of virtual measurement center from the probe tip (on probe axis). No tolerance required.
- Connector Angle**: The angle is assessed using the information gained by determining the NORM_x (no uncertainty required).

DASY/EASY - Parameters of Probe: EF3DV3 - SN:4049

Basic Calibration Parameters

	Sensor X	Sensor Y	Sensor Z	Unc (k=2)
Norm ($\mu\text{V}/(\text{V/m})^2$)	0.76	1.02	1.09	$\pm 10.1 \%$
DCP (mV) ^B	100.0	93.5	98.0	

Calibration results for Frequency Response (30 MHz – 6 GHz)

Frequency MHz	Target E-Field V/m	Measured E-field (En) V/m	Deviation E-normal in %	Measured E-field (Ep) V/m	Deviation E-normal in %	Unc (k=2) %
30	77.3	77.5	0.1%	77.4	0.1%	$\pm 5.1 \%$
100	77.3	78.2	1.1%	77.8	0.6%	$\pm 5.1 \%$
450	77.1	78.0	1.1%	77.8	0.9%	$\pm 5.1 \%$
600	77.2	77.7	0.7%	77.5	0.5%	$\pm 5.1 \%$
750	77.1	77.6	0.5%	77.4	0.3%	$\pm 5.1 \%$
1800	143.2	139.3	-2.7%	139.6	-2.5%	$\pm 5.1 \%$
2000	135.2	131.6	-2.6%	131.8	-2.5%	$\pm 5.1 \%$
2200	127.8	123.8	-3.1%	124.9	-2.2%	$\pm 5.1 \%$
2500	125.6	122.7	-2.3%	123.6	-1.5%	$\pm 5.1 \%$
3000	79.4	75.8	-4.6%	76.9	-3.2%	$\pm 5.1 \%$
3500	256.1	247.7	-3.3%	245.1	-4.3%	$\pm 5.1 \%$
3700	249.7	238.9	-4.3%	237.5	-4.9%	$\pm 5.1 \%$
5200	50.4	51.0	1.1%	50.9	0.9%	$\pm 5.1 \%$
5500	49.7	49.4	-0.5%	48.0	-3.3%	$\pm 5.1 \%$
5800	48.8	48.6	-0.5%	49.5	1.3%	$\pm 5.1 \%$

The reported uncertainty of measurement is stated as the standard uncertainty of measurement multiplied by the coverage factor $k=2$, which for a normal distribution corresponds to a coverage probability of approximately 95%.

^B Numerical linearization parameter: uncertainty not required.

^E Uncertainty is determined using the max. deviation from linear response applying rectangular distribution and is expressed for the square of the field value.

DASY/EASY - Parameters of Probe: EF3DV3 - SN:4049

Calibration Results for Modulation Response

UID	Communication System Name		A dB	B dB√μV	C	D dB	VR mV	Max dev.	Max Unc ^E (k=2)
0	CW	X	0.00	0.00	1.00	0.00	169.7	± 3.5 %	± 4.7 %
		Y	0.00	0.00	1.00		146.5		
		Z	0.00	0.00	1.00		162.1		
10352-AAA	Pulse Waveform (200Hz, 10%)	X	3.28	67.04	10.89	10.00	60.0	± 2.4 %	± 9.6 %
		Y	16.94	91.42	23.57		60.0		
		Z	5.80	74.45	14.74		60.0		
10353-AAA	Pulse Waveform (200Hz, 20%)	X	1.72	64.27	8.58	6.99	80.0	± 0.9 %	± 9.6 %
		Y	20.00	93.41	22.61		80.0		
		Z	8.26	79.72	15.42		80.0		
10354-AAA	Pulse Waveform (200Hz, 40%)	X	0.84	62.80	6.83	3.98	95.0	± 0.9 %	± 9.6 %
		Y	20.00	94.43	21.38		95.0		
		Z	20.00	88.49	16.51		95.0		
10355-AAA	Pulse Waveform (200Hz, 60%)	X	0.48	62.34	5.87	2.22	120.0	± 1.3 %	± 9.6 %
		Y	20.00	96.58	20.87		120.0		
		Z	20.00	88.63	15.35		120.0		
10387-AAA	QPSK Waveform, 1 MHz	X	0.83	64.61	10.15	0.00	150.0	± 2.1 %	± 9.6 %
		Y	1.43	69.28	14.81		150.0		
		Z	0.98	65.84	11.59		150.0		
10388-AAA	QPSK Waveform, 10 MHz	X	2.73	72.45	18.28	0.00	150.0	± 0.9 %	± 9.6 %
		Y	2.96	72.14	17.87		150.0		
		Z	2.70	71.70	17.78		150.0		
10396-AAA	64-QAM Waveform, 100 kHz	X	3.49	75.99	21.53	3.01	150.0	± 1.4 %	± 9.6 %
		Y	4.15	75.27	21.52		150.0		
		Z	2.58	69.24	18.53		150.0		
10399-AAA	64-QAM Waveform, 40 MHz	X	3.70	68.50	16.79	0.00	150.0	± 1.4 %	± 9.6 %
		Y	3.87	68.49	16.76		150.0		
		Z	3.66	68.08	16.54		150.0		
10414-AAA	WLAN CCDF, 64-QAM, 40MHz	X	4.79	65.84	15.89	0.00	150.0	± 2.9 %	± 9.6 %
		Y	5.08	65.64	15.83		150.0		
		Z	4.94	65.98	15.95		150.0		

Note: For details on UID parameters see Appendix

The reported uncertainty of measurement is stated as the standard uncertainty of measurement multiplied by the coverage factor k=2, which for a normal distribution corresponds to a coverage probability of approximately 95%.

^B Numerical linearization parameter: uncertainty not required.

^E Uncertainty is determined using the max. deviation from linear response applying rectangular distribution and is expressed for the square of the field value.

DASY/EASY - Parameters of Probe: EF3DV3 - SN:4049

Sensor Frequency Model Parameters

	Sensor X	Sensor Y	Sensor Z
Frequency Corr. (LF)	0.00	-0.13	5.48
Frequency Corr. (HF)	2.82	2.82	2.82

Sensor Model Parameters

	C1 fF	C2 fF	α V^{-1}	T1 $ms.V^{-2}$	T2 $ms.V^{-1}$	T3 ms	T4 V^{-2}	T5 V^{-1}	T6
X	44.4	290.24	36.30	6.46	0.51	4.94	1.63	0.06	1.00
Y	77.7	531.09	39.12	24.98	1.60	5.10	0.00	0.70	1.01
Z	53.6	355.42	37.12	11.91	0.50	5.02	0.00	0.37	1.00

Other Probe Parameters

Sensor Arrangement	Rectangular
Connector Angle (°)	110.7
Mechanical Surface Detection Mode	enabled
Optical Surface Detection Mode	disabled
Probe Overall Length	337 mm
Probe Body Diameter	12 mm
Tip Length	25 mm
Tip Diameter	4 mm
Probe Tip to Sensor X Calibration Point	1.5 mm
Probe Tip to Sensor Y Calibration Point	1.5 mm
Probe Tip to Sensor Z Calibration Point	1.5 mm

Receiving Pattern (ϕ), $\vartheta = 0^\circ$

f=600 MHz, TEM, 0°

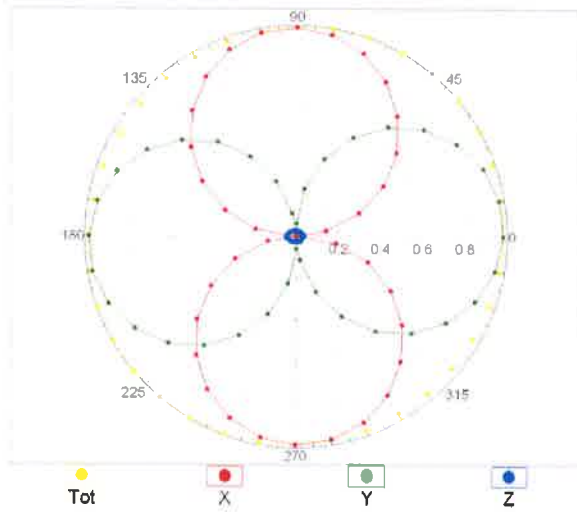

f=1800 MHz, R22, 0°

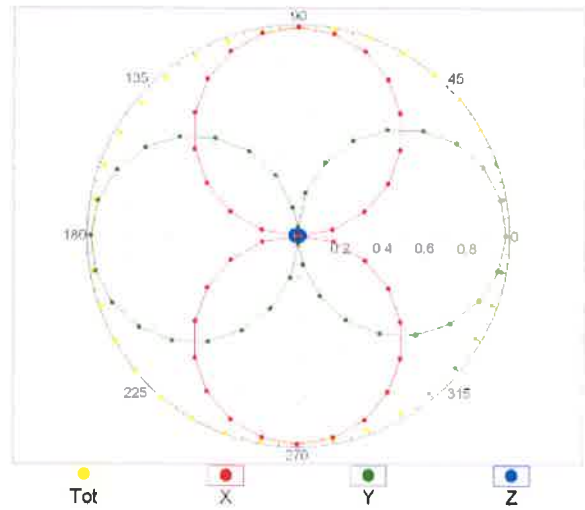

Receiving Pattern (ϕ), $\vartheta = 90^\circ$

f=600 MHz, TEM, 90°

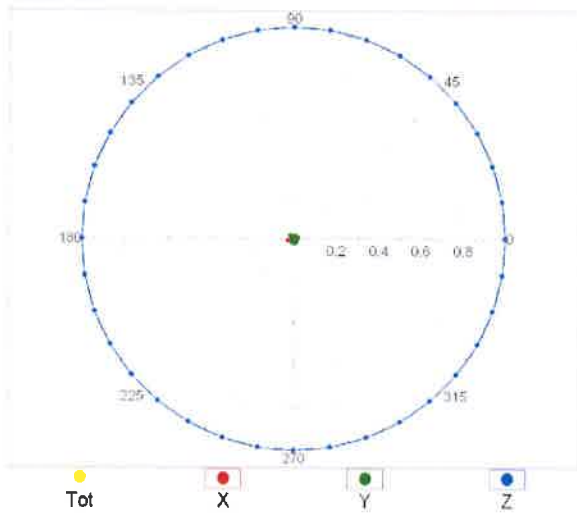

f=1800 MHz, R22, 90°

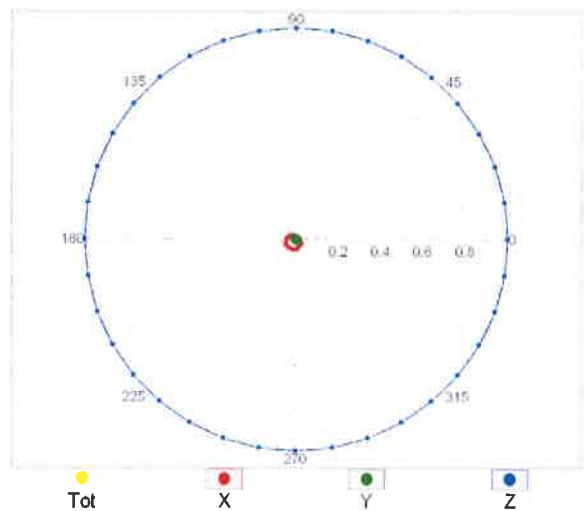

Receiving Pattern (ϕ), $\vartheta = 0^\circ$

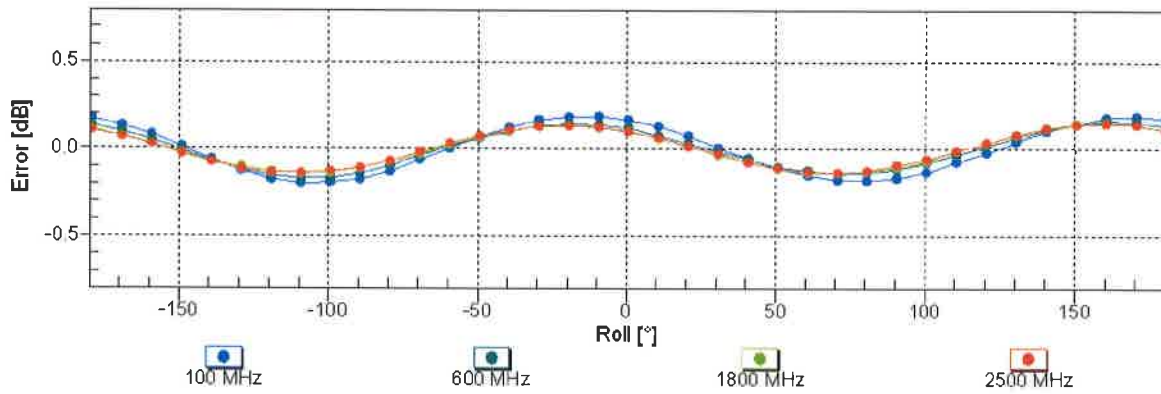

Uncertainty of Axial Isotropy Assessment: $\pm 0.5\%$ (k=2)

Receiving Pattern (ϕ), $\vartheta = 90^\circ$

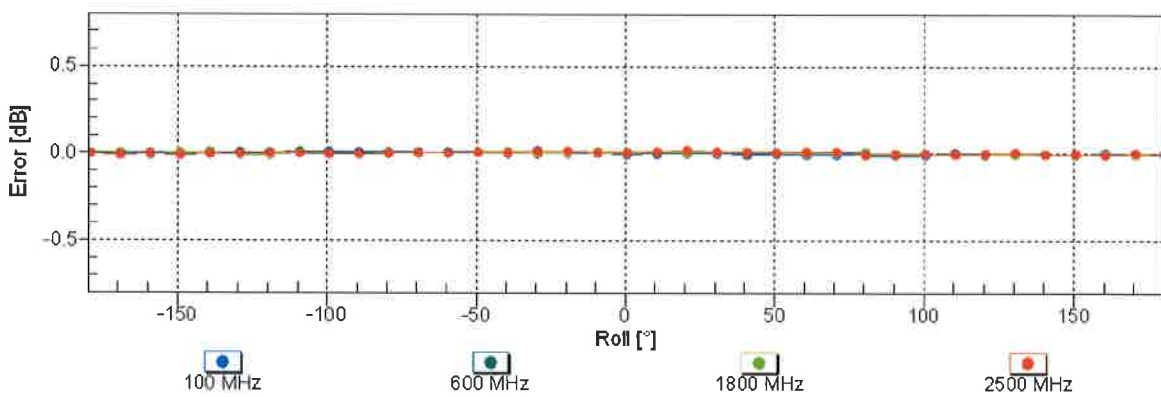

Uncertainty of Axial Isotropy Assessment: $\pm 0.5\%$ (k=2)

Dynamic Range f(E-field) (TEM cell, f = 900 MHz)

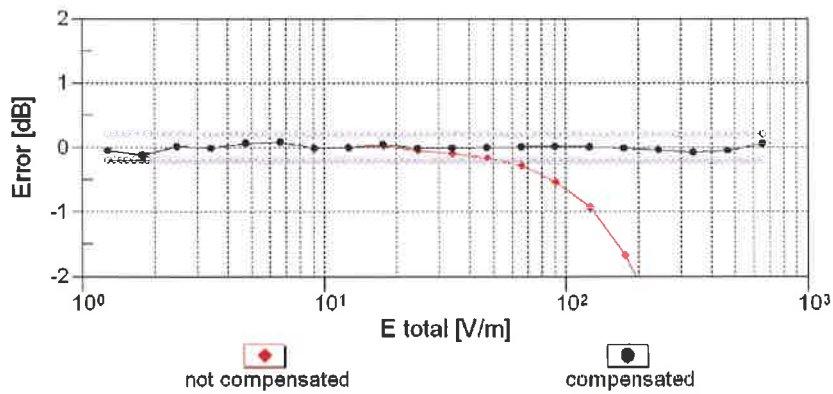
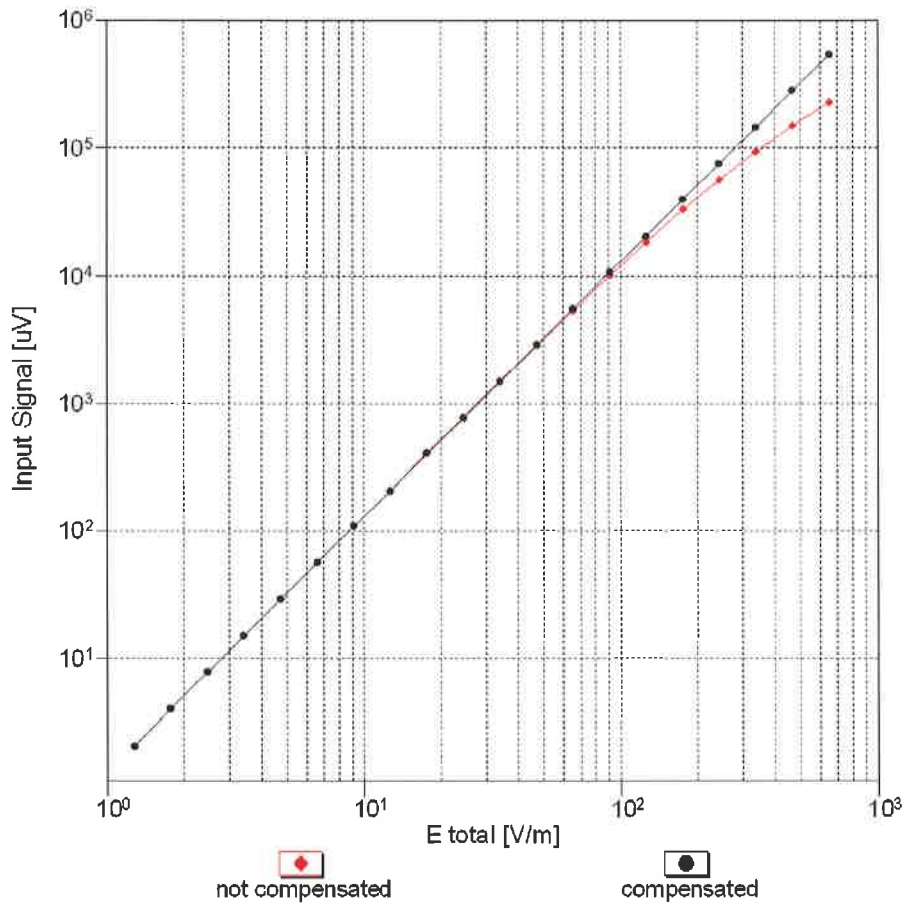

Uncertainty of Linearity Assessment: ± 0.6% (k=2)

Deviation from Isotropy in Air Error (ϕ , ϑ), $f = 900$ MHz

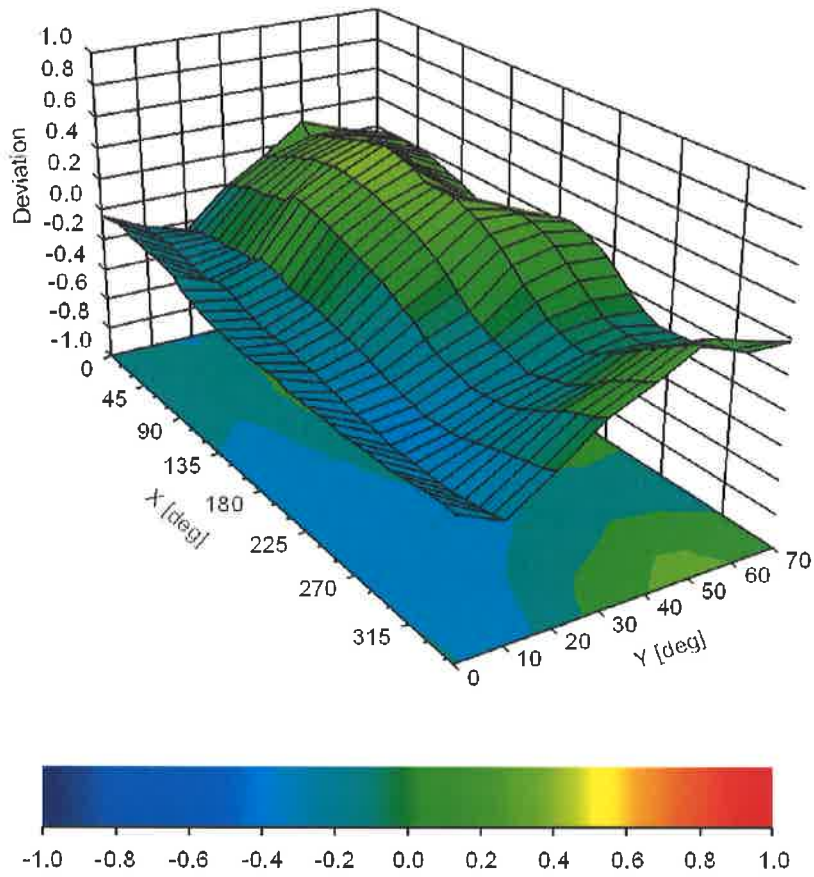

Uncertainty of Spherical Isotropy Assessment: $\pm 2.6\%$ ($k=2$)

Appendix: Modulation Calibration Parameters

UID	Rev	Communication System Name	Group	PAR (dB)	Unc [±] (k=2)
0		CW	CW	0.00	± 4.7 %
10010	CAA	SAR Validation (Square, 100ms, 10ms)	Test	10.00	± 9.6 %
10011	CAB	UMTS-FDD (WCDMA)	WCDMA	2.91	± 9.6 %
10012	CAB	IEEE 802.11b WiFi 2.4 GHz (DSSS, 1 Mbps)	WLAN	1.87	± 9.6 %
10013	CAB	IEEE 802.11g WiFi 2.4 GHz (DSSS-OFDM, 6 Mbps)	WLAN	9.46	± 9.6 %
10021	DAC	GSM-FDD (TDMA, GMSK)	GSM	9.39	± 9.6 %
10023	DAC	GPRS-FDD (TDMA, GMSK, TN 0)	GSM	9.57	± 9.6 %
10024	DAC	GPRS-FDD (TDMA, GMSK, TN 0-1)	GSM	6.56	± 9.6 %
10025	DAC	EDGE-FDD (TDMA, 8PSK, TN 0)	GSM	12.62	± 9.6 %
10026	DAC	EDGE-FDD (TDMA, 8PSK, TN 0-1)	GSM	9.55	± 9.6 %
10027	DAC	GPRS-FDD (TDMA, GMSK, TN 0-1-2)	GSM	4.80	± 9.6 %
10028	DAC	GPRS-FDD (TDMA, GMSK, TN 0-1-2-3)	GSM	3.55	± 9.6 %
10029	DAC	EDGE-FDD (TDMA, 8PSK, TN 0-1-2)	GSM	7.78	± 9.6 %
10030	CAA	IEEE 802.15.1 Bluetooth (GFSK, DH1)	Bluetooth	5.30	± 9.6 %
10031	CAA	IEEE 802.15.1 Bluetooth (GFSK, DH3)	Bluetooth	1.87	± 9.6 %
10032	CAA	IEEE 802.15.1 Bluetooth (GFSK, DH5)	Bluetooth	1.16	± 9.6 %
10033	CAA	IEEE 802.15.1 Bluetooth (PI/4-DQPSK, DH1)	Bluetooth	7.74	± 9.6 %
10034	CAA	IEEE 802.15.1 Bluetooth (PI/4-DQPSK, DH3)	Bluetooth	4.53	± 9.6 %
10035	CAA	IEEE 802.15.1 Bluetooth (PI/4-DQPSK, DH5)	Bluetooth	3.83	± 9.6 %
10036	CAA	IEEE 802.15.1 Bluetooth (8-DPSK, DH1)	Bluetooth	8.01	± 9.6 %
10037	CAA	IEEE 802.15.1 Bluetooth (8-DPSK, DH3)	Bluetooth	4.77	± 9.6 %
10038	CAA	IEEE 802.15.1 Bluetooth (8-DPSK, DH5)	Bluetooth	4.10	± 9.6 %
10039	CAB	CDMA2000 (1xRTT, RC1)	CDMA2000	4.57	± 9.6 %
10042	CAB	IS-54 / IS-136 FDD (TDMA/FDM, PI/4-DQPSK, Halfrate)	AMPS	7.78	± 9.6 %
10044	CAA	IS-91/EIA/TIA-553 FDD (FDMA, FM)	AMPS	0.00	± 9.6 %
10048	CAA	DECT (TDD, TDMA/FDM, GFSK, Full Slot, 24)	DECT	13.80	± 9.6 %
10049	CAA	DECT (TDD, TDMA/FDM, GFSK, Double Slot, 12)	DECT	10.79	± 9.6 %
10056	CAA	UMTS-TDD (TD-SCDMA, 1.28 Mcps)	TD-SCDMA	11.01	± 9.6 %
10058	DAC	EDGE-FDD (TDMA, 8PSK, TN 0-1-2-3)	GSM	6.52	± 9.6 %
10059	CAB	IEEE 802.11b WiFi 2.4 GHz (DSSS, 2 Mbps)	WLAN	2.12	± 9.6 %
10060	CAB	IEEE 802.11b WiFi 2.4 GHz (DSSS, 5.5 Mbps)	WLAN	2.83	± 9.6 %
10061	CAB	IEEE 802.11b WiFi 2.4 GHz (DSSS, 11 Mbps)	WLAN	3.60	± 9.6 %
10062	CAC	IEEE 802.11a/h WiFi 5 GHz (OFDM, 6 Mbps)	WLAN	8.68	± 9.6 %
10063	CAC	IEEE 802.11a/h WiFi 5 GHz (OFDM, 9 Mbps)	WLAN	8.63	± 9.6 %
10064	CAC	IEEE 802.11a/h WiFi 5 GHz (OFDM, 12 Mbps)	WLAN	9.09	± 9.6 %
10065	CAC	IEEE 802.11a/h WiFi 5 GHz (OFDM, 18 Mbps)	WLAN	9.00	± 9.6 %
10066	CAC	IEEE 802.11a/h WiFi 5 GHz (OFDM, 24 Mbps)	WLAN	9.38	± 9.6 %
10067	CAC	IEEE 802.11a/h WiFi 5 GHz (OFDM, 36 Mbps)	WLAN	10.12	± 9.6 %
10068	CAC	IEEE 802.11a/h WiFi 5 GHz (OFDM, 48 Mbps)	WLAN	10.24	± 9.6 %
10069	CAC	IEEE 802.11a/h WiFi 5 GHz (OFDM, 54 Mbps)	WLAN	10.56	± 9.6 %
10071	CAB	IEEE 802.11g WiFi 2.4 GHz (DSSS/OFDM, 9 Mbps)	WLAN	9.83	± 9.6 %
10072	CAB	IEEE 802.11g WiFi 2.4 GHz (DSSS/OFDM, 12 Mbps)	WLAN	9.62	± 9.6 %
10073	CAB	IEEE 802.11g WiFi 2.4 GHz (DSSS/OFDM, 18 Mbps)	WLAN	9.94	± 9.6 %
10074	CAB	IEEE 802.11g WiFi 2.4 GHz (DSSS/OFDM, 24 Mbps)	WLAN	10.30	± 9.6 %
10075	CAB	IEEE 802.11g WiFi 2.4 GHz (DSSS/OFDM, 36 Mbps)	WLAN	10.77	± 9.6 %
10076	CAB	IEEE 802.11g WiFi 2.4 GHz (DSSS/OFDM, 48 Mbps)	WLAN	10.94	± 9.6 %
10077	CAB	IEEE 802.11g WiFi 2.4 GHz (DSSS/OFDM, 54 Mbps)	WLAN	11.00	± 9.6 %
10081	CAB	CDMA2000 (1xRTT, RC3)	CDMA2000	3.97	± 9.6 %
10082	CAB	IS-54 / IS-136 FDD (TDMA/FDM, PI/4-DQPSK, Fullrate)	AMPS	4.77	± 9.6 %
10090	DAC	GPRS-FDD (TDMA, GMSK, TN 0-4)	GSM	6.56	± 9.6 %
10097	CAB	UMTS-FDD (HSDPA)	WCDMA	3.98	± 9.6 %
10098	CAB	UMTS-FDD (HSUPA, Subtest 2)	WCDMA	3.98	± 9.6 %
10099	DAC	EDGE-FDD (TDMA, 8PSK, TN 0-4)	GSM	9.55	± 9.6 %
10100	CAE	LTE-FDD (SC-FDMA, 100% RB, 20 MHz, QPSK)	LTE-FDD	5.67	± 9.6 %
10101	CAE	LTE-FDD (SC-FDMA, 100% RB, 20 MHz, 16-QAM)	LTE-FDD	6.42	± 9.6 %
10102	CAE	LTE-FDD (SC-FDMA, 100% RB, 20 MHz, 64-QAM)	LTE-FDD	6.60	± 9.6 %
10103	CAG	LTE-TDD (SC-FDMA, 100% RB, 20 MHz, QPSK)	LTE-TDD	9.29	± 9.6 %
10104	CAG	LTE-TDD (SC-FDMA, 100% RB, 20 MHz, 16-QAM)	LTE-TDD	9.97	± 9.6 %
10105	CAG	LTE-TDD (SC-FDMA, 100% RB, 20 MHz, 64-QAM)	LTE-TDD	10.01	± 9.6 %
10108	CAG	LTE-FDD (SC-FDMA, 100% RB, 10 MHz, QPSK)	LTE-FDD	5.80	± 9.6 %

10109	CAG	LTE-FDD (SC-FDMA, 100% RB, 10 MHz, 16-QAM)	LTE-FDD	6.43	± 9.6 %
10110	CAG	LTE-FDD (SC-FDMA, 100% RB, 5 MHz, QPSK)	LTE-FDD	5.75	± 9.6 %
10111	CAG	LTE-FDD (SC-FDMA, 100% RB, 5 MHz, 16-QAM)	LTE-FDD	6.44	± 9.6 %
10112	CAG	LTE-FDD (SC-FDMA, 100% RB, 10 MHz, 64-QAM)	LTE-FDD	6.59	± 9.6 %
10113	CAG	LTE-FDD (SC-FDMA, 100% RB, 5 MHz, 64-QAM)	LTE-FDD	6.62	± 9.6 %
10114	CAC	IEEE 802.11n (HT Greenfield, 13.5 Mbps, BPSK)	WLAN	8.10	± 9.6 %
10115	CAC	IEEE 802.11n (HT Greenfield, 81 Mbps, 16-QAM)	WLAN	8.46	± 9.6 %
10116	CAC	IEEE 802.11n (HT Greenfield, 135 Mbps, 64-QAM)	WLAN	8.15	± 9.6 %
10117	CAC	IEEE 802.11n (HT Mixed, 13.5 Mbps, BPSK)	WLAN	8.07	± 9.6 %
10118	CAC	IEEE 802.11n (HT Mixed, 81 Mbps, 16-QAM)	WLAN	8.59	± 9.6 %
10119	CAC	IEEE 802.11n (HT Mixed, 135 Mbps, 64-QAM)	WLAN	8.13	± 9.6 %
10140	CAE	LTE-FDD (SC-FDMA, 100% RB, 15 MHz, 16-QAM)	LTE-FDD	6.49	± 9.6 %
10141	CAE	LTE-FDD (SC-FDMA, 100% RB, 15 MHz, 64-QAM)	LTE-FDD	6.53	± 9.6 %
10142	CAE	LTE-FDD (SC-FDMA, 100% RB, 3 MHz, QPSK)	LTE-FDD	5.73	± 9.6 %
10143	CAE	LTE-FDD (SC-FDMA, 100% RB, 3 MHz, 16-QAM)	LTE-FDD	6.35	± 9.6 %
10144	CAE	LTE-FDD (SC-FDMA, 100% RB, 3 MHz, 64-QAM)	LTE-FDD	6.65	± 9.6 %
10145	CAF	LTE-FDD (SC-FDMA, 100% RB, 1.4 MHz, QPSK)	LTE-FDD	5.76	± 9.6 %
10146	CAF	LTE-FDD (SC-FDMA, 100% RB, 1.4 MHz, 16-QAM)	LTE-FDD	6.41	± 9.6 %
10147	CAF	LTE-FDD (SC-FDMA, 100% RB, 1.4 MHz, 64-QAM)	LTE-FDD	6.72	± 9.6 %
10149	CAE	LTE-FDD (SC-FDMA, 50% RB, 20 MHz, 16-QAM)	LTE-FDD	6.42	± 9.6 %
10150	CAE	LTE-FDD (SC-FDMA, 50% RB, 20 MHz, 64-QAM)	LTE-FDD	6.60	± 9.6 %
10151	CAG	LTE-TDD (SC-FDMA, 50% RB, 20 MHz, QPSK)	LTE-TDD	9.28	± 9.6 %
10152	CAG	LTE-TDD (SC-FDMA, 50% RB, 20 MHz, 16-QAM)	LTE-TDD	9.92	± 9.6 %
10153	CAG	LTE-TDD (SC-FDMA, 50% RB, 20 MHz, 64-QAM)	LTE-TDD	10.05	± 9.6 %
10154	CAG	LTE-FDD (SC-FDMA, 50% RB, 10 MHz, QPSK)	LTE-FDD	5.75	± 9.6 %
10155	CAG	LTE-FDD (SC-FDMA, 50% RB, 10 MHz, 16-QAM)	LTE-FDD	6.43	± 9.6 %
10156	CAG	LTE-FDD (SC-FDMA, 50% RB, 5 MHz, QPSK)	LTE-FDD	5.79	± 9.6 %
10157	CAG	LTE-FDD (SC-FDMA, 50% RB, 5 MHz, 16-QAM)	LTE-FDD	6.49	± 9.6 %
10158	CAG	LTE-FDD (SC-FDMA, 50% RB, 10 MHz, 64-QAM)	LTE-FDD	6.62	± 9.6 %
10159	CAG	LTE-FDD (SC-FDMA, 50% RB, 5 MHz, 64-QAM)	LTE-FDD	6.56	± 9.6 %
10160	CAE	LTE-FDD (SC-FDMA, 50% RB, 15 MHz, QPSK)	LTE-FDD	5.82	± 9.6 %
10161	CAE	LTE-FDD (SC-FDMA, 50% RB, 15 MHz, 16-QAM)	LTE-FDD	6.43	± 9.6 %
10162	CAE	LTE-FDD (SC-FDMA, 50% RB, 15 MHz, 64-QAM)	LTE-FDD	6.58	± 9.6 %
10166	CAF	LTE-FDD (SC-FDMA, 50% RB, 1.4 MHz, QPSK)	LTE-FDD	5.46	± 9.6 %
10167	CAF	LTE-FDD (SC-FDMA, 50% RB, 1.4 MHz, 16-QAM)	LTE-FDD	6.21	± 9.6 %
10168	CAF	LTE-FDD (SC-FDMA, 50% RB, 1.4 MHz, 64-QAM)	LTE-FDD	6.79	± 9.6 %
10169	CAE	LTE-FDD (SC-FDMA, 1 RB, 20 MHz, QPSK)	LTE-FDD	5.73	± 9.6 %
10170	CAE	LTE-FDD (SC-FDMA, 1 RB, 20 MHz, 16-QAM)	LTE-FDD	6.52	± 9.6 %
10171	AAE	LTE-FDD (SC-FDMA, 1 RB, 20 MHz, 64-QAM)	LTE-FDD	6.49	± 9.6 %
10172	CAG	LTE-TDD (SC-FDMA, 1 RB, 20 MHz, QPSK)	LTE-TDD	9.21	± 9.6 %
10173	CAG	LTE-TDD (SC-FDMA, 1 RB, 20 MHz, 16-QAM)	LTE-TDD	9.48	± 9.6 %
10174	CAG	LTE-TDD (SC-FDMA, 1 RB, 20 MHz, 64-QAM)	LTE-TDD	10.25	± 9.6 %
10175	CAG	LTE-FDD (SC-FDMA, 1 RB, 10 MHz, QPSK)	LTE-FDD	5.72	± 9.6 %
10176	CAG	LTE-FDD (SC-FDMA, 1 RB, 10 MHz, 16-QAM)	LTE-FDD	6.52	± 9.6 %
10177	CAI	LTE-FDD (SC-FDMA, 1 RB, 5 MHz, QPSK)	LTE-FDD	5.73	± 9.6 %
10178	CAG	LTE-FDD (SC-FDMA, 1 RB, 5 MHz, 16-QAM)	LTE-FDD	6.52	± 9.6 %
10179	CAG	LTE-FDD (SC-FDMA, 1 RB, 10 MHz, 64-QAM)	LTE-FDD	6.50	± 9.6 %
10180	CAG	LTE-FDD (SC-FDMA, 1 RB, 5 MHz, 64-QAM)	LTE-FDD	6.50	± 9.6 %
10181	CAE	LTE-FDD (SC-FDMA, 1 RB, 15 MHz, QPSK)	LTE-FDD	5.72	± 9.6 %
10182	CAE	LTE-FDD (SC-FDMA, 1 RB, 15 MHz, 16-QAM)	LTE-FDD	6.52	± 9.6 %
10183	AAD	LTE-FDD (SC-FDMA, 1 RB, 15 MHz, 64-QAM)	LTE-FDD	6.50	± 9.6 %
10184	CAE	LTE-FDD (SC-FDMA, 1 RB, 3 MHz, QPSK)	LTE-FDD	5.73	± 9.6 %
10185	CAE	LTE-FDD (SC-FDMA, 1 RB, 3 MHz, 16-QAM)	LTE-FDD	6.51	± 9.6 %
10186	AAE	LTE-FDD (SC-FDMA, 1 RB, 3 MHz, 64-QAM)	LTE-FDD	6.50	± 9.6 %
10187	CAF	LTE-FDD (SC-FDMA, 1 RB, 1.4 MHz, QPSK)	LTE-FDD	5.73	± 9.6 %
10188	CAF	LTE-FDD (SC-FDMA, 1 RB, 1.4 MHz, 16-QAM)	LTE-FDD	6.52	± 9.6 %
10189	AAF	LTE-FDD (SC-FDMA, 1 RB, 1.4 MHz, 64-QAM)	LTE-FDD	6.50	± 9.6 %
10193	CAC	IEEE 802.11n (HT Greenfield, 6.5 Mbps, BPSK)	WLAN	8.09	± 9.6 %
10194	CAC	IEEE 802.11n (HT Greenfield, 39 Mbps, 16-QAM)	WLAN	8.12	± 9.6 %
10195	CAC	IEEE 802.11n (HT Greenfield, 65 Mbps, 64-QAM)	WLAN	8.21	± 9.6 %
10196	CAC	IEEE 802.11n (HT Mixed, 6.5 Mbps, BPSK)	WLAN	8.10	± 9.6 %
10197	CAC	IEEE 802.11n (HT Mixed, 39 Mbps, 16-QAM)	WLAN	8.13	± 9.6 %
10198	CAC	IEEE 802.11n (HT Mixed, 65 Mbps, 64-QAM)	WLAN	8.27	± 9.6 %
10219	CAC	IEEE 802.11n (HT Mixed, 7.2 Mbps, BPSK)	WLAN	8.03	± 9.6 %

10220	CAC	IEEE 802.11n (HT Mixed, 43.3 Mbps, 16-QAM)	WLAN	8.13	± 9.6 %
10221	CAC	IEEE 802.11n (HT Mixed, 72.2 Mbps, 64-QAM)	WLAN	8.27	± 9.6 %
10222	CAC	IEEE 802.11n (HT Mixed, 15 Mbps, BPSK)	WLAN	8.06	± 9.6 %
10223	CAC	IEEE 802.11n (HT Mixed, 90 Mbps, 16-QAM)	WLAN	8.48	± 9.6 %
10224	CAC	IEEE 802.11n (HT Mixed, 150 Mbps, 64-QAM)	WLAN	8.08	± 9.6 %
10225	CAB	UMTS-FDD (HSPA+)	WCDMA	5.97	± 9.6 %
10226	CAB	LTE-TDD (SC-FDMA, 1 RB, 1.4 MHz, 16-QAM)	LTE-TDD	9.49	± 9.6 %
10227	CAB	LTE-TDD (SC-FDMA, 1 RB, 1.4 MHz, 64-QAM)	LTE-TDD	10.26	± 9.6 %
10228	CAB	LTE-TDD (SC-FDMA, 1 RB, 1.4 MHz, QPSK)	LTE-TDD	9.22	± 9.6 %
10229	CAD	LTE-TDD (SC-FDMA, 1 RB, 3 MHz, 16-QAM)	LTE-TDD	9.48	± 9.6 %
10230	CAD	LTE-TDD (SC-FDMA, 1 RB, 3 MHz, 64-QAM)	LTE-TDD	10.25	± 9.6 %
10231	CAD	LTE-TDD (SC-FDMA, 1 RB, 3 MHz, QPSK)	LTE-TDD	9.19	± 9.6 %
10232	CAG	LTE-TDD (SC-FDMA, 1 RB, 5 MHz, 16-QAM)	LTE-TDD	9.48	± 9.6 %
10233	CAG	LTE-TDD (SC-FDMA, 1 RB, 5 MHz, 64-QAM)	LTE-TDD	10.25	± 9.6 %
10234	CAG	LTE-TDD (SC-FDMA, 1 RB, 5 MHz, QPSK)	LTE-TDD	9.21	± 9.6 %
10235	CAG	LTE-TDD (SC-FDMA, 1 RB, 10 MHz, 16-QAM)	LTE-TDD	9.48	± 9.6 %
10236	CAG	LTE-TDD (SC-FDMA, 1 RB, 10 MHz, 64-QAM)	LTE-TDD	10.25	± 9.6 %
10237	CAG	LTE-TDD (SC-FDMA, 1 RB, 10 MHz, QPSK)	LTE-TDD	9.21	± 9.6 %
10238	CAF	LTE-TDD (SC-FDMA, 1 RB, 15 MHz, 16-QAM)	LTE-TDD	9.48	± 9.6 %
10239	CAF	LTE-TDD (SC-FDMA, 1 RB, 15 MHz, 64-QAM)	LTE-TDD	10.25	± 9.6 %
10240	CAF	LTE-TDD (SC-FDMA, 1 RB, 15 MHz, QPSK)	LTE-TDD	9.21	± 9.6 %
10241	CAB	LTE-TDD (SC-FDMA, 50% RB, 1.4 MHz, 16-QAM)	LTE-TDD	9.82	± 9.6 %
10242	CAB	LTE-TDD (SC-FDMA, 50% RB, 1.4 MHz, 64-QAM)	LTE-TDD	9.86	± 9.6 %
10243	CAB	LTE-TDD (SC-FDMA, 50% RB, 1.4 MHz, QPSK)	LTE-TDD	9.46	± 9.6 %
10244	CAD	LTE-TDD (SC-FDMA, 50% RB, 3 MHz, 16-QAM)	LTE-TDD	10.06	± 9.6 %
10245	CAD	LTE-TDD (SC-FDMA, 50% RB, 3 MHz, 64-QAM)	LTE-TDD	10.06	± 9.6 %
10246	CAD	LTE-TDD (SC-FDMA, 50% RB, 3 MHz, QPSK)	LTE-TDD	9.30	± 9.6 %
10247	CAG	LTE-TDD (SC-FDMA, 50% RB, 5 MHz, 16-QAM)	LTE-TDD	9.91	± 9.6 %
10248	CAG	LTE-TDD (SC-FDMA, 50% RB, 5 MHz, 64-QAM)	LTE-TDD	10.09	± 9.6 %
10249	CAG	LTE-TDD (SC-FDMA, 50% RB, 5 MHz, QPSK)	LTE-TDD	9.29	± 9.6 %
10250	CAG	LTE-TDD (SC-FDMA, 50% RB, 10 MHz, 16-QAM)	LTE-TDD	9.81	± 9.6 %
10251	CAG	LTE-TDD (SC-FDMA, 50% RB, 10 MHz, 64-QAM)	LTE-TDD	10.17	± 9.6 %
10252	CAG	LTE-TDD (SC-FDMA, 50% RB, 10 MHz, QPSK)	LTE-TDD	9.24	± 9.6 %
10253	CAF	LTE-TDD (SC-FDMA, 50% RB, 15 MHz, 16-QAM)	LTE-TDD	9.90	± 9.6 %
10254	CAF	LTE-TDD (SC-FDMA, 50% RB, 15 MHz, 64-QAM)	LTE-TDD	10.14	± 9.6 %
10255	CAF	LTE-TDD (SC-FDMA, 50% RB, 15 MHz, QPSK)	LTE-TDD	9.20	± 9.6 %
10256	CAB	LTE-TDD (SC-FDMA, 100% RB, 1.4 MHz, 16-QAM)	LTE-TDD	9.96	± 9.6 %
10257	CAB	LTE-TDD (SC-FDMA, 100% RB, 1.4 MHz, 64-QAM)	LTE-TDD	10.08	± 9.6 %
10258	CAB	LTE-TDD (SC-FDMA, 100% RB, 1.4 MHz, QPSK)	LTE-TDD	9.34	± 9.6 %
10259	CAD	LTE-TDD (SC-FDMA, 100% RB, 3 MHz, 16-QAM)	LTE-TDD	9.98	± 9.6 %
10260	CAD	LTE-TDD (SC-FDMA, 100% RB, 3 MHz, 64-QAM)	LTE-TDD	9.97	± 9.6 %
10261	CAD	LTE-TDD (SC-FDMA, 100% RB, 3 MHz, QPSK)	LTE-TDD	9.24	± 9.6 %
10262	CAG	LTE-TDD (SC-FDMA, 100% RB, 5 MHz, 16-QAM)	LTE-TDD	9.83	± 9.6 %
10263	CAG	LTE-TDD (SC-FDMA, 100% RB, 5 MHz, 64-QAM)	LTE-TDD	10.16	± 9.6 %
10264	CAG	LTE-TDD (SC-FDMA, 100% RB, 5 MHz, QPSK)	LTE-TDD	9.23	± 9.6 %
10265	CAG	LTE-TDD (SC-FDMA, 100% RB, 10 MHz, 16-QAM)	LTE-TDD	9.92	± 9.6 %
10266	CAG	LTE-TDD (SC-FDMA, 100% RB, 10 MHz, 64-QAM)	LTE-TDD	10.07	± 9.6 %
10267	CAG	LTE-TDD (SC-FDMA, 100% RB, 10 MHz, QPSK)	LTE-TDD	9.30	± 9.6 %
10268	CAF	LTE-TDD (SC-FDMA, 100% RB, 15 MHz, 16-QAM)	LTE-TDD	10.06	± 9.6 %
10269	CAF	LTE-TDD (SC-FDMA, 100% RB, 15 MHz, 64-QAM)	LTE-TDD	10.13	± 9.6 %
10270	CAF	LTE-TDD (SC-FDMA, 100% RB, 15 MHz, QPSK)	LTE-TDD	9.58	± 9.6 %
10274	CAB	UMTS-FDD (HSUPA, Subtest 5, 3GPP Rel8.10)	WCDMA	4.87	± 9.6 %
10275	CAB	UMTS-FDD (HSUPA, Subtest 5, 3GPP Rel8.4)	WCDMA	3.96	± 9.6 %
10277	CAA	PHS (QPSK)	PHS	11.81	± 9.6 %
10278	CAA	PHS (QPSK, BW 884MHz, Rolloff 0.5)	PHS	11.81	± 9.6 %
10279	CAA	PHS (QPSK, BW 884MHz, Rolloff 0.38)	PHS	12.18	± 9.6 %
10290	AAB	CDMA2000, RC1, SO55, Full Rate	CDMA2000	3.91	± 9.6 %
10291	AAB	CDMA2000, RC3, SO55, Full Rate	CDMA2000	3.46	± 9.6 %
10292	AAB	CDMA2000, RC3, SO32, Full Rate	CDMA2000	3.39	± 9.6 %
10293	AAB	CDMA2000, RC3, SO3, Full Rate	CDMA2000	3.50	± 9.6 %
10295	AAB	CDMA2000, RC1, SO3, 1/8th Rate 25 fr.	CDMA2000	12.49	± 9.6 %
10297	AAD	LTE-FDD (SC-FDMA, 50% RB, 20 MHz, QPSK)	LTE-FDD	5.81	± 9.6 %
10298	AAD	LTE-FDD (SC-FDMA, 50% RB, 3 MHz, QPSK)	LTE-FDD	5.72	± 9.6 %
10299	AAD	LTE-FDD (SC-FDMA, 50% RB, 3 MHz, 16-QAM)	LTE-FDD	6.39	± 9.6 %

10300	AAD	LTE-FDD (SC-FDMA, 50% RB, 3 MHz, 64-QAM)	LTE-FDD	6.60	± 9.6 %
10301	AAA	IEEE 802.16e WiMAX (29:18, 5ms, 10MHz, QPSK, PUSC)	WiMAX	12.03	± 9.6 %
10302	AAA	IEEE 802.16e WiMAX (29:18, 5ms, 10MHz, QPSK, PUSC, 3 CTRL symbols)	WiMAX	12.57	± 9.6 %
10303	AAA	IEEE 802.16e WiMAX (31:15, 5ms, 10MHz, 64QAM, PUSC)	WiMAX	12.52	± 9.6 %
10304	AAA	IEEE 802.16e WiMAX (29:18, 5ms, 10MHz, 64QAM, PUSC)	WiMAX	11.86	± 9.6 %
10305	AAA	IEEE 802.16e WiMAX (31:15, 10ms, 10MHz, 64QAM, PUSC, 15 symbols)	WiMAX	15.24	± 9.6 %
10306	AAA	IEEE 802.16e WiMAX (29:18, 10ms, 10MHz, 64QAM, PUSC, 18 symbols)	WiMAX	14.67	± 9.6 %
10307	AAA	IEEE 802.16e WiMAX (29:18, 10ms, 10MHz, QPSK, PUSC, 18 symbols)	WiMAX	14.49	± 9.6 %
10308	AAA	IEEE 802.16e WiMAX (29:18, 10ms, 10MHz, 16QAM, PUSC)	WiMAX	14.46	± 9.6 %
10309	AAA	IEEE 802.16e WiMAX (29:18, 10ms, 10MHz, 16QAM, AMC 2x3, 18 symbols)	WiMAX	14.58	± 9.6 %
10310	AAA	IEEE 802.16e WiMAX (29:18, 10ms, 10MHz, QPSK, AMC 2x3, 18 symbols)	WiMAX	14.57	± 9.6 %
10311	AAD	LTE-FDD (SC-FDMA, 100% RB, 15 MHz, QPSK)	LTE-FDD	6.06	± 9.6 %
10313	AAA	iDEN 1:3	iDEN	10.51	± 9.6 %
10314	AAA	iDEN 1:6	iDEN	13.48	± 9.6 %
10315	AAB	IEEE 802.11b WiFi 2.4 GHz (DSSS, 1 Mbps, 96pc duty cycle)	WLAN	1.71	± 9.6 %
10316	AAB	IEEE 802.11g WiFi 2.4 GHz (ERP-OFDM, 6 Mbps, 96pc duty cycle)	WLAN	8.36	± 9.6 %
10317	AAC	IEEE 802.11a WiFi 5 GHz (OFDM, 6 Mbps, 96pc duty cycle)	WLAN	8.36	± 9.6 %
10352	AAA	Pulse Waveform (200Hz, 10%)	Generic	10.00	± 9.6 %
10353	AAA	Pulse Waveform (200Hz, 20%)	Generic	6.99	± 9.6 %
10354	AAA	Pulse Waveform (200Hz, 40%)	Generic	3.98	± 9.6 %
10355	AAA	Pulse Waveform (200Hz, 60%)	Generic	2.22	± 9.6 %
10356	AAA	Pulse Waveform (200Hz, 80%)	Generic	0.97	± 9.6 %
10387	AAA	QPSK Waveform, 1 MHz	Generic	5.10	± 9.6 %
10388	AAA	QPSK Waveform, 10 MHz	Generic	5.22	± 9.6 %
10396	AAA	64-QAM Waveform, 100 kHz	Generic	6.27	± 9.6 %
10399	AAA	64-QAM Waveform, 40 MHz	Generic	6.27	± 9.6 %
10400	AAD	IEEE 802.11ac WiFi (20MHz, 64-QAM, 99pc duty cycle)	WLAN	8.37	± 9.6 %
10401	AAD	IEEE 802.11ac WiFi (40MHz, 64-QAM, 99pc duty cycle)	WLAN	8.60	± 9.6 %
10402	AAD	IEEE 802.11ac WiFi (80MHz, 64-QAM, 99pc duty cycle)	WLAN	8.53	± 9.6 %
10403	AAB	CDMA2000 (1xEV-DO, Rev. 0)	CDMA2000	3.76	± 9.6 %
10404	AAB	CDMA2000 (1xEV-DO, Rev. A)	CDMA2000	3.77	± 9.6 %
10406	AAB	CDMA2000, RC3, SO32, SCH0, Full Rate	CDMA2000	5.22	± 9.6 %
10410	AAG	LTE-TDD (SC-FDMA, 1 RB, 10 MHz, QPSK, UL Subframe=2,3,4,7,8,9, Subframe Conf=4)	LTE-TDD	7.82	± 9.6 %
10414	AAA	WLAN CCDF, 64-QAM, 40MHz	Generic	8.54	± 9.6 %
10415	AAA	IEEE 802.11b WiFi 2.4 GHz (DSSS, 1 Mbps, 99pc duty cycle)	WLAN	1.54	± 9.6 %
10416	AAA	IEEE 802.11g WiFi 2.4 GHz (ERP-OFDM, 6 Mbps, 99pc duty cycle)	WLAN	8.23	± 9.6 %
10417	AAB	IEEE 802.11a/h WiFi 5 GHz (OFDM, 6 Mbps, 99pc duty cycle)	WLAN	8.23	± 9.6 %
10418	AAA	IEEE 802.11g WiFi 2.4 GHz (DSSS-OFDM, 6 Mbps, 99pc duty cycle, Long preamble)	WLAN	8.14	± 9.6 %
10419	AAA	IEEE 802.11g WiFi 2.4 GHz (DSSS-OFDM, 6 Mbps, 99pc duty cycle, Short preamble)	WLAN	8.19	± 9.6 %
10422	AAB	IEEE 802.11n (HT Greenfield, 7.2 Mbps, BPSK)	WLAN	8.32	± 9.6 %
10423	AAB	IEEE 802.11n (HT Greenfield, 43.3 Mbps, 16-QAM)	WLAN	8.47	± 9.6 %
10424	AAB	IEEE 802.11n (HT Greenfield, 72.2 Mbps, 64-QAM)	WLAN	8.40	± 9.6 %
10425	AAB	IEEE 802.11n (HT Greenfield, 15 Mbps, BPSK)	WLAN	8.41	± 9.6 %
10426	AAB	IEEE 802.11n (HT Greenfield, 90 Mbps, 16-QAM)	WLAN	8.45	± 9.6 %
10427	AAB	IEEE 802.11n (HT Greenfield, 150 Mbps, 64-QAM)	WLAN	8.41	± 9.6 %
10430	AAD	LTE-FDD (OFDMA, 5 MHz, E-TM 3.1)	LTE-FDD	8.28	± 9.6 %
10431	AAD	LTE-FDD (OFDMA, 10 MHz, E-TM 3.1)	LTE-FDD	8.38	± 9.6 %
10432	AAC	LTE-FDD (OFDMA, 15 MHz, E-TM 3.1)	LTE-FDD	8.34	± 9.6 %
10433	AAC	LTE-FDD (OFDMA, 20 MHz, E-TM 3.1)	LTE-FDD	8.34	± 9.6 %
10434	AAA	W-CDMA (BS Test Model 1, 64 DPCH)	WCDMA	8.60	± 9.6 %
10435	AAF	LTE-TDD (SC-FDMA, 1 RB, 20 MHz, QPSK, UL Subframe=2,3,4,7,8,9)	LTE-TDD	7.82	± 9.6 %
10447	AAD	LTE-FDD (OFDMA, 5 MHz, E-TM 3.1, Clipping 44%)	LTE-FDD	7.56	± 9.6 %
10448	AAD	LTE-FDD (OFDMA, 10 MHz, E-TM 3.1, Clipping 44%)	LTE-FDD	7.53	± 9.6 %
10449	AAC	LTE-FDD (OFDMA, 15 MHz, E-TM 3.1, Clipping 44%)	LTE-FDD	7.51	± 9.6 %
10450	AAC	LTE-FDD (OFDMA, 20 MHz, E-TM 3.1, Clipping 44%)	LTE-FDD	7.48	± 9.6 %

10451	AAA	W-CDMA (BS Test Model 1, 64 DPCH, Clipping 44%)	WCDMA	7.59	± 9.6 %
10453	AAD	Validation (Square, 10ms, 1ms)	Test	10.00	± 9.6 %
10456	AAB	IEEE 802.11ac WiFi (160MHz, 64-QAM, 99pc duty cycle)	WLAN	8.63	± 9.6 %
10457	AAA	UMTS-FDD (DC-HSDPA)	WCDMA	6.62	± 9.6 %
10458	AAA	CDMA2000 (1xEV-DO, Rev. B, 2 carriers)	CDMA2000	6.55	± 9.6 %
10459	AAA	CDMA2000 (1xEV-DO, Rev. B, 3 carriers)	CDMA2000	8.25	± 9.6 %
10460	AAA	UMTS-FDD (WCDMA, AMR)	WCDMA	2.39	± 9.6 %
10461	AAB	LTE-TDD (SC-FDMA, 1 RB, 1.4 MHz, QPSK, UL Subframe=2,3,4,7,8,9)	LTE-TDD	7.82	± 9.6 %
10462	AAB	LTE-TDD (SC-FDMA, 1 RB, 1.4 MHz, 16-QAM, UL Subframe=2,3,4,7,8,9)	LTE-TDD	8.30	± 9.6 %
10463	AAB	LTE-TDD (SC-FDMA, 1 RB, 1.4 MHz, 64-QAM, UL Subframe=2,3,4,7,8,9)	LTE-TDD	8.56	± 9.6 %
10464	AAC	LTE-TDD (SC-FDMA, 1 RB, 3 MHz, QPSK, UL Subframe=2,3,4,7,8,9)	LTE-TDD	7.82	± 9.6 %
10465	AAC	LTE-TDD (SC-FDMA, 1 RB, 3 MHz, 16-QAM, UL Subframe=2,3,4,7,8,9)	LTE-TDD	8.32	± 9.6 %
10466	AAC	LTE-TDD (SC-FDMA, 1 RB, 3 MHz, 64-QAM, UL Subframe=2,3,4,7,8,9)	LTE-TDD	8.57	± 9.6 %
10467	AAF	LTE-TDD (SC-FDMA, 1 RB, 5 MHz, QPSK, UL Subframe=2,3,4,7,8,9)	LTE-TDD	7.82	± 9.6 %
10468	AAF	LTE-TDD (SC-FDMA, 1 RB, 5 MHz, 16-QAM, UL Subframe=2,3,4,7,8,9)	LTE-TDD	8.32	± 9.6 %
10469	AAF	LTE-TDD (SC-FDMA, 1 RB, 5 MHz, 64-QAM, UL Subframe=2,3,4,7,8,9)	LTE-TDD	8.56	± 9.6 %
10470	AAF	LTE-TDD (SC-FDMA, 1 RB, 10 MHz, QPSK, UL Subframe=2,3,4,7,8,9)	LTE-TDD	7.82	± 9.6 %
10471	AAF	LTE-TDD (SC-FDMA, 1 RB, 10 MHz, 16-QAM, UL Subframe=2,3,4,7,8,9)	LTE-TDD	8.32	± 9.6 %
10472	AAF	LTE-TDD (SC-FDMA, 1 RB, 10 MHz, 64-QAM, UL Subframe=2,3,4,7,8,9)	LTE-TDD	8.57	± 9.6 %
10473	AAE	LTE-TDD (SC-FDMA, 1 RB, 15 MHz, QPSK, UL Subframe=2,3,4,7,8,9)	LTE-TDD	7.82	± 9.6 %
10474	AAE	LTE-TDD (SC-FDMA, 1 RB, 15 MHz, 16-QAM, UL Subframe=2,3,4,7,8,9)	LTE-TDD	8.32	± 9.6 %
10475	AAE	LTE-TDD (SC-FDMA, 1 RB, 15 MHz, 64-QAM, UL Subframe=2,3,4,7,8,9)	LTE-TDD	8.57	± 9.6 %
10477	AAF	LTE-TDD (SC-FDMA, 1 RB, 20 MHz, 16-QAM, UL Subframe=2,3,4,7,8,9)	LTE-TDD	8.32	± 9.6 %
10478	AAF	LTE-TDD (SC-FDMA, 1 RB, 20 MHz, 64-QAM, UL Subframe=2,3,4,7,8,9)	LTE-TDD	8.57	± 9.6 %
10479	AAB	LTE-TDD (SC-FDMA, 50% RB, 1.4 MHz, QPSK, UL Subframe=2,3,4,7,8,9)	LTE-TDD	7.74	± 9.6 %
10480	AAB	LTE-TDD (SC-FDMA, 50% RB, 1.4 MHz, 16-QAM, UL Subframe=2,3,4,7,8,9)	LTE-TDD	8.18	± 9.6 %
10481	AAB	LTE-TDD (SC-FDMA, 50% RB, 1.4 MHz, 64-QAM, UL Subframe=2,3,4,7,8,9)	LTE-TDD	8.45	± 9.6 %
10482	AAC	LTE-TDD (SC-FDMA, 50% RB, 3 MHz, QPSK, UL Subframe=2,3,4,7,8,9)	LTE-TDD	7.71	± 9.6 %
10483	AAC	LTE-TDD (SC-FDMA, 50% RB, 3 MHz, 16-QAM, UL Subframe=2,3,4,7,8,9)	LTE-TDD	8.39	± 9.6 %
10484	AAC	LTE-TDD (SC-FDMA, 50% RB, 3 MHz, 64-QAM, UL Subframe=2,3,4,7,8,9)	LTE-TDD	8.47	± 9.6 %
10485	AAF	LTE-TDD (SC-FDMA, 50% RB, 5 MHz, QPSK, UL Subframe=2,3,4,7,8,9)	LTE-TDD	7.59	± 9.6 %
10486	AAF	LTE-TDD (SC-FDMA, 50% RB, 5 MHz, 16-QAM, UL Subframe=2,3,4,7,8,9)	LTE-TDD	8.38	± 9.6 %
10487	AAF	LTE-TDD (SC-FDMA, 50% RB, 5 MHz, 64-QAM, UL Subframe=2,3,4,7,8,9)	LTE-TDD	8.60	± 9.6 %
10488	AAF	LTE-TDD (SC-FDMA, 50% RB, 10 MHz, QPSK, UL Subframe=2,3,4,7,8,9)	LTE-TDD	7.70	± 9.6 %
10489	AAF	LTE-TDD (SC-FDMA, 50% RB, 10 MHz, 16-QAM, UL Subframe=2,3,4,7,8,9)	LTE-TDD	8.31	± 9.6 %
10490	AAF	LTE-TDD (SC-FDMA, 50% RB, 10 MHz, 64-QAM, UL Subframe=2,3,4,7,8,9)	LTE-TDD	8.54	± 9.6 %

10491	AAE	LTE-TDD (SC-FDMA, 50% RB, 15 MHz, QPSK, UL Subframe=2,3,4,7,8,9)	LTE-TDD	7.74	± 9.6 %
10492	AAE	LTE-TDD (SC-FDMA, 50% RB, 15 MHz, 16-QAM, UL Subframe=2,3,4,7,8,9)	LTE-TDD	8.41	± 9.6 %
10493	AAE	LTE-TDD (SC-FDMA, 50% RB, 15 MHz, 64-QAM, UL Subframe=2,3,4,7,8,9)	LTE-TDD	8.55	± 9.6 %
10494	AAF	LTE-TDD (SC-FDMA, 50% RB, 20 MHz, QPSK, UL Subframe=2,3,4,7,8,9)	LTE-TDD	7.74	± 9.6 %
10495	AAF	LTE-TDD (SC-FDMA, 50% RB, 20 MHz, 16-QAM, UL Subframe=2,3,4,7,8,9)	LTE-TDD	8.37	± 9.6 %
10496	AAF	LTE-TDD (SC-FDMA, 50% RB, 20 MHz, 64-QAM, UL Subframe=2,3,4,7,8,9)	LTE-TDD	8.54	± 9.6 %
10497	AAB	LTE-TDD (SC-FDMA, 100% RB, 1.4 MHz, QPSK, UL Subframe=2,3,4,7,8,9)	LTE-TDD	7.67	± 9.6 %
10498	AAB	LTE-TDD (SC-FDMA, 100% RB, 1.4 MHz, 16-QAM, UL Subframe=2,3,4,7,8,9)	LTE-TDD	8.40	± 9.6 %
10499	AAB	LTE-TDD (SC-FDMA, 100% RB, 1.4 MHz, 64-QAM, UL Subframe=2,3,4,7,8,9)	LTE-TDD	8.68	± 9.6 %
10500	AAC	LTE-TDD (SC-FDMA, 100% RB, 3 MHz, QPSK, UL Subframe=2,3,4,7,8,9)	LTE-TDD	7.67	± 9.6 %
10501	AAC	LTE-TDD (SC-FDMA, 100% RB, 3 MHz, 16-QAM, UL Subframe=2,3,4,7,8,9)	LTE-TDD	8.44	± 9.6 %
10502	AAC	LTE-TDD (SC-FDMA, 100% RB, 3 MHz, 64-QAM, UL Subframe=2,3,4,7,8,9)	LTE-TDD	8.52	± 9.6 %
10503	AAF	LTE-TDD (SC-FDMA, 100% RB, 5 MHz, QPSK, UL Subframe=2,3,4,7,8,9)	LTE-TDD	7.72	± 9.6 %
10504	AAF	LTE-TDD (SC-FDMA, 100% RB, 5 MHz, 16-QAM, UL Subframe=2,3,4,7,8,9)	LTE-TDD	8.31	± 9.6 %
10505	AAF	LTE-TDD (SC-FDMA, 100% RB, 5 MHz, 64-QAM, UL Subframe=2,3,4,7,8,9)	LTE-TDD	8.54	± 9.6 %
10506	AAF	LTE-TDD (SC-FDMA, 100% RB, 10 MHz, QPSK, UL Subframe=2,3,4,7,8,9)	LTE-TDD	7.74	± 9.6 %
10507	AAF	LTE-TDD (SC-FDMA, 100% RB, 10 MHz, 16-QAM, UL Subframe=2,3,4,7,8,9)	LTE-TDD	8.36	± 9.6 %
10508	AAF	LTE-TDD (SC-FDMA, 100% RB, 10 MHz, 64-QAM, UL Subframe=2,3,4,7,8,9)	LTE-TDD	8.55	± 9.6 %
10509	AAE	LTE-TDD (SC-FDMA, 100% RB, 15 MHz, QPSK, UL Subframe=2,3,4,7,8,9)	LTE-TDD	7.99	± 9.6 %
10510	AAE	LTE-TDD (SC-FDMA, 100% RB, 15 MHz, 16-QAM, UL Subframe=2,3,4,7,8,9)	LTE-TDD	8.49	± 9.6 %
10511	AAE	LTE-TDD (SC-FDMA, 100% RB, 15 MHz, 64-QAM, UL Subframe=2,3,4,7,8,9)	LTE-TDD	8.51	± 9.6 %
10512	AAF	LTE-TDD (SC-FDMA, 100% RB, 20 MHz, QPSK, UL Subframe=2,3,4,7,8,9)	LTE-TDD	7.74	± 9.6 %
10513	AAF	LTE-TDD (SC-FDMA, 100% RB, 20 MHz, 16-QAM, UL Subframe=2,3,4,7,8,9)	LTE-TDD	8.42	± 9.6 %
10514	AAF	LTE-TDD (SC-FDMA, 100% RB, 20 MHz, 64-QAM, UL Subframe=2,3,4,7,8,9)	LTE-TDD	8.45	± 9.6 %
10515	AAA	IEEE 802.11b WiFi 2.4 GHz (DSSS, 2 Mbps, 99pc duty cycle)	WLAN	1.58	± 9.6 %
10516	AAA	IEEE 802.11b WiFi 2.4 GHz (DSSS, 5.5 Mbps, 99pc duty cycle)	WLAN	1.57	± 9.6 %
10517	AAA	IEEE 802.11b WiFi 2.4 GHz (DSSS, 11 Mbps, 99pc duty cycle)	WLAN	1.58	± 9.6 %
10518	AAB	IEEE 802.11a/h WiFi 5 GHz (OFDM, 9 Mbps, 99pc duty cycle)	WLAN	8.23	± 9.6 %
10519	AAB	IEEE 802.11a/h WiFi 5 GHz (OFDM, 12 Mbps, 99pc duty cycle)	WLAN	8.39	± 9.6 %
10520	AAB	IEEE 802.11a/h WiFi 5 GHz (OFDM, 18 Mbps, 99pc duty cycle)	WLAN	8.12	± 9.6 %
10521	AAB	IEEE 802.11a/h WiFi 5 GHz (OFDM, 24 Mbps, 99pc duty cycle)	WLAN	7.97	± 9.6 %
10522	AAB	IEEE 802.11a/h WiFi 5 GHz (OFDM, 36 Mbps, 99pc duty cycle)	WLAN	8.45	± 9.6 %
10523	AAB	IEEE 802.11a/h WiFi 5 GHz (OFDM, 48 Mbps, 99pc duty cycle)	WLAN	8.08	± 9.6 %
10524	AAB	IEEE 802.11a/h WiFi 5 GHz (OFDM, 54 Mbps, 99pc duty cycle)	WLAN	8.27	± 9.6 %
10525	AAB	IEEE 802.11ac WiFi (20MHz, MCS0, 99pc duty cycle)	WLAN	8.36	± 9.6 %
10526	AAB	IEEE 802.11ac WiFi (20MHz, MCS1, 99pc duty cycle)	WLAN	8.42	± 9.6 %
10527	AAB	IEEE 802.11ac WiFi (20MHz, MCS2, 99pc duty cycle)	WLAN	8.21	± 9.6 %
10528	AAB	IEEE 802.11ac WiFi (20MHz, MCS3, 99pc duty cycle)	WLAN	8.36	± 9.6 %
10529	AAB	IEEE 802.11ac WiFi (20MHz, MCS4, 99pc duty cycle)	WLAN	8.36	± 9.6 %
10531	AAB	IEEE 802.11ac WiFi (20MHz, MCS6, 99pc duty cycle)	WLAN	8.43	± 9.6 %
10532	AAB	IEEE 802.11ac WiFi (20MHz, MCS7, 99pc duty cycle)	WLAN	8.29	± 9.6 %
10533	AAB	IEEE 802.11ac WiFi (20MHz, MCS8, 99pc duty cycle)	WLAN	8.38	± 9.6 %

10534	AAB	IEEE 802.11ac WiFi (40MHz, MCS0, 99pc duty cycle)	WLAN	8.45	± 9.6 %
10535	AAB	IEEE 802.11ac WiFi (40MHz, MCS1, 99pc duty cycle)	WLAN	8.45	± 9.6 %
10536	AAB	IEEE 802.11ac WiFi (40MHz, MCS2, 99pc duty cycle)	WLAN	8.32	± 9.6 %
10537	AAB	IEEE 802.11ac WiFi (40MHz, MCS3, 99pc duty cycle)	WLAN	8.44	± 9.6 %
10538	AAB	IEEE 802.11ac WiFi (40MHz, MCS4, 99pc duty cycle)	WLAN	8.54	± 9.6 %
10540	AAB	IEEE 802.11ac WiFi (40MHz, MCS6, 99pc duty cycle)	WLAN	8.39	± 9.6 %
10541	AAB	IEEE 802.11ac WiFi (40MHz, MCS7, 99pc duty cycle)	WLAN	8.46	± 9.6 %
10542	AAB	IEEE 802.11ac WiFi (40MHz, MCS8, 99pc duty cycle)	WLAN	8.65	± 9.6 %
10543	AAB	IEEE 802.11ac WiFi (40MHz, MCS9, 99pc duty cycle)	WLAN	8.65	± 9.6 %
10544	AAB	IEEE 802.11ac WiFi (80MHz, MCS0, 99pc duty cycle)	WLAN	8.47	± 9.6 %
10545	AAB	IEEE 802.11ac WiFi (80MHz, MCS1, 99pc duty cycle)	WLAN	8.55	± 9.6 %
10546	AAB	IEEE 802.11ac WiFi (80MHz, MCS2, 99pc duty cycle)	WLAN	8.35	± 9.6 %
10547	AAB	IEEE 802.11ac WiFi (80MHz, MCS3, 99pc duty cycle)	WLAN	8.49	± 9.6 %
10548	AAB	IEEE 802.11ac WiFi (80MHz, MCS4, 99pc duty cycle)	WLAN	8.37	± 9.6 %
10550	AAB	IEEE 802.11ac WiFi (80MHz, MCS6, 99pc duty cycle)	WLAN	8.38	± 9.6 %
10551	AAB	IEEE 802.11ac WiFi (80MHz, MCS7, 99pc duty cycle)	WLAN	8.50	± 9.6 %
10552	AAB	IEEE 802.11ac WiFi (80MHz, MCS8, 99pc duty cycle)	WLAN	8.42	± 9.6 %
10553	AAB	IEEE 802.11ac WiFi (80MHz, MCS9, 99pc duty cycle)	WLAN	8.45	± 9.6 %
10554	AAC	IEEE 802.11ac WiFi (160MHz, MCS0, 99pc duty cycle)	WLAN	8.48	± 9.6 %
10555	AAC	IEEE 802.11ac WiFi (160MHz, MCS1, 99pc duty cycle)	WLAN	8.47	± 9.6 %
10556	AAC	IEEE 802.11ac WiFi (160MHz, MCS2, 99pc duty cycle)	WLAN	8.50	± 9.6 %
10557	AAC	IEEE 802.11ac WiFi (160MHz, MCS3, 99pc duty cycle)	WLAN	8.52	± 9.6 %
10558	AAC	IEEE 802.11ac WiFi (160MHz, MCS4, 99pc duty cycle)	WLAN	8.61	± 9.6 %
10560	AAC	IEEE 802.11ac WiFi (160MHz, MCS6, 99pc duty cycle)	WLAN	8.73	± 9.6 %
10561	AAC	IEEE 802.11ac WiFi (160MHz, MCS7, 99pc duty cycle)	WLAN	8.56	± 9.6 %
10562	AAC	IEEE 802.11ac WiFi (160MHz, MCS8, 99pc duty cycle)	WLAN	8.69	± 9.6 %
10563	AAC	IEEE 802.11ac WiFi (160MHz, MCS9, 99pc duty cycle)	WLAN	8.77	± 9.6 %
10564	AAA	IEEE 802.11g WiFi 2.4 GHz (DSSS-OFDM, 9 Mbps, 99pc duty cycle)	WLAN	8.25	± 9.6 %
10565	AAA	IEEE 802.11g WiFi 2.4 GHz (DSSS-OFDM, 12 Mbps, 99pc duty cycle)	WLAN	8.45	± 9.6 %
10566	AAA	IEEE 802.11g WiFi 2.4 GHz (DSSS-OFDM, 18 Mbps, 99pc duty cycle)	WLAN	8.13	± 9.6 %
10567	AAA	IEEE 802.11g WiFi 2.4 GHz (DSSS-OFDM, 24 Mbps, 99pc duty cycle)	WLAN	8.00	± 9.6 %
10568	AAA	IEEE 802.11g WiFi 2.4 GHz (DSSS-OFDM, 36 Mbps, 99pc duty cycle)	WLAN	8.37	± 9.6 %
10569	AAA	IEEE 802.11g WiFi 2.4 GHz (DSSS-OFDM, 48 Mbps, 99pc duty cycle)	WLAN	8.10	± 9.6 %
10570	AAA	IEEE 802.11g WiFi 2.4 GHz (DSSS-OFDM, 54 Mbps, 99pc duty cycle)	WLAN	8.30	± 9.6 %
10571	AAA	IEEE 802.11b WiFi 2.4 GHz (DSSS, 1 Mbps, 90pc duty cycle)	WLAN	1.99	± 9.6 %
10572	AAA	IEEE 802.11b WiFi 2.4 GHz (DSSS, 2 Mbps, 90pc duty cycle)	WLAN	1.99	± 9.6 %
10573	AAA	IEEE 802.11b WiFi 2.4 GHz (DSSS, 5.5 Mbps, 90pc duty cycle)	WLAN	1.98	± 9.6 %
10574	AAA	IEEE 802.11b WiFi 2.4 GHz (DSSS, 11 Mbps, 90pc duty cycle)	WLAN	1.98	± 9.6 %
10575	AAA	IEEE 802.11g WiFi 2.4 GHz (DSSS-OFDM, 6 Mbps, 90pc duty cycle)	WLAN	8.59	± 9.6 %
10576	AAA	IEEE 802.11g WiFi 2.4 GHz (DSSS-OFDM, 9 Mbps, 90pc duty cycle)	WLAN	8.60	± 9.6 %
10577	AAA	IEEE 802.11g WiFi 2.4 GHz (DSSS-OFDM, 12 Mbps, 90pc duty cycle)	WLAN	8.70	± 9.6 %
10578	AAA	IEEE 802.11g WiFi 2.4 GHz (DSSS-OFDM, 18 Mbps, 90pc duty cycle)	WLAN	8.49	± 9.6 %
10579	AAA	IEEE 802.11g WiFi 2.4 GHz (DSSS-OFDM, 24 Mbps, 90pc duty cycle)	WLAN	8.36	± 9.6 %
10580	AAA	IEEE 802.11g WiFi 2.4 GHz (DSSS-OFDM, 36 Mbps, 90pc duty cycle)	WLAN	8.76	± 9.6 %
10581	AAA	IEEE 802.11g WiFi 2.4 GHz (DSSS-OFDM, 48 Mbps, 90pc duty cycle)	WLAN	8.35	± 9.6 %
10582	AAA	IEEE 802.11g WiFi 2.4 GHz (DSSS-OFDM, 54 Mbps, 90pc duty cycle)	WLAN	8.67	± 9.6 %
10583	AAB	IEEE 802.11a/h WiFi 5 GHz (OFDM, 6 Mbps, 90pc duty cycle)	WLAN	8.59	± 9.6 %
10584	AAB	IEEE 802.11a/h WiFi 5 GHz (OFDM, 9 Mbps, 90pc duty cycle)	WLAN	8.60	± 9.6 %
10585	AAB	IEEE 802.11a/h WiFi 5 GHz (OFDM, 12 Mbps, 90pc duty cycle)	WLAN	8.70	± 9.6 %
10586	AAB	IEEE 802.11a/h WiFi 5 GHz (OFDM, 18 Mbps, 90pc duty cycle)	WLAN	8.49	± 9.6 %

10587	AAB	IEEE 802.11a/h WiFi 5 GHz (OFDM, 24 Mbps, 90pc duty cycle)	WLAN	8.36	± 9.6 %
10588	AAB	IEEE 802.11a/h WiFi 5 GHz (OFDM, 36 Mbps, 90pc duty cycle)	WLAN	8.76	± 9.6 %
10589	AAB	IEEE 802.11a/h WiFi 5 GHz (OFDM, 48 Mbps, 90pc duty cycle)	WLAN	8.35	± 9.6 %
10590	AAB	IEEE 802.11a/h WiFi 5 GHz (OFDM, 54 Mbps, 90pc duty cycle)	WLAN	8.67	± 9.6 %
10591	AAB	IEEE 802.11n (HT Mixed, 20MHz, MCS0, 90pc duty cycle)	WLAN	8.63	± 9.6 %
10592	AAB	IEEE 802.11n (HT Mixed, 20MHz, MCS1, 90pc duty cycle)	WLAN	8.79	± 9.6 %
10593	AAB	IEEE 802.11n (HT Mixed, 20MHz, MCS2, 90pc duty cycle)	WLAN	8.64	± 9.6 %
10594	AAB	IEEE 802.11n (HT Mixed, 20MHz, MCS3, 90pc duty cycle)	WLAN	8.74	± 9.6 %
10595	AAB	IEEE 802.11n (HT Mixed, 20MHz, MCS4, 90pc duty cycle)	WLAN	8.74	± 9.6 %
10596	AAB	IEEE 802.11n (HT Mixed, 20MHz, MCS5, 90pc duty cycle)	WLAN	8.71	± 9.6 %
10597	AAB	IEEE 802.11n (HT Mixed, 20MHz, MCS6, 90pc duty cycle)	WLAN	8.72	± 9.6 %
10598	AAB	IEEE 802.11n (HT Mixed, 20MHz, MCS7, 90pc duty cycle)	WLAN	8.50	± 9.6 %
10599	AAB	IEEE 802.11n (HT Mixed, 40MHz, MCS0, 90pc duty cycle)	WLAN	8.79	± 9.6 %
10600	AAB	IEEE 802.11n (HT Mixed, 40MHz, MCS1, 90pc duty cycle)	WLAN	8.88	± 9.6 %
10601	AAB	IEEE 802.11n (HT Mixed, 40MHz, MCS2, 90pc duty cycle)	WLAN	8.82	± 9.6 %
10602	AAB	IEEE 802.11n (HT Mixed, 40MHz, MCS3, 90pc duty cycle)	WLAN	8.94	± 9.6 %
10603	AAB	IEEE 802.11n (HT Mixed, 40MHz, MCS4, 90pc duty cycle)	WLAN	9.03	± 9.6 %
10604	AAB	IEEE 802.11n (HT Mixed, 40MHz, MCS5, 90pc duty cycle)	WLAN	8.76	± 9.6 %
10605	AAB	IEEE 802.11n (HT Mixed, 40MHz, MCS6, 90pc duty cycle)	WLAN	8.97	± 9.6 %
10606	AAB	IEEE 802.11n (HT Mixed, 40MHz, MCS7, 90pc duty cycle)	WLAN	8.82	± 9.6 %
10607	AAB	IEEE 802.11ac WiFi (20MHz, MCS0, 90pc duty cycle)	WLAN	8.64	± 9.6 %
10608	AAB	IEEE 802.11ac WiFi (20MHz, MCS1, 90pc duty cycle)	WLAN	8.77	± 9.6 %
10609	AAB	IEEE 802.11ac WiFi (20MHz, MCS2, 90pc duty cycle)	WLAN	8.57	± 9.6 %
10610	AAB	IEEE 802.11ac WiFi (20MHz, MCS3, 90pc duty cycle)	WLAN	8.78	± 9.6 %
10611	AAB	IEEE 802.11ac WiFi (20MHz, MCS4, 90pc duty cycle)	WLAN	8.70	± 9.6 %
10612	AAB	IEEE 802.11ac WiFi (20MHz, MCS5, 90pc duty cycle)	WLAN	8.77	± 9.6 %
10613	AAB	IEEE 802.11ac WiFi (20MHz, MCS6, 90pc duty cycle)	WLAN	8.94	± 9.6 %
10614	AAB	IEEE 802.11ac WiFi (20MHz, MCS7, 90pc duty cycle)	WLAN	8.59	± 9.6 %
10615	AAB	IEEE 802.11ac WiFi (20MHz, MCS8, 90pc duty cycle)	WLAN	8.82	± 9.6 %
10616	AAB	IEEE 802.11ac WiFi (40MHz, MCS0, 90pc duty cycle)	WLAN	8.82	± 9.6 %
10617	AAB	IEEE 802.11ac WiFi (40MHz, MCS1, 90pc duty cycle)	WLAN	8.81	± 9.6 %
10618	AAB	IEEE 802.11ac WiFi (40MHz, MCS2, 90pc duty cycle)	WLAN	8.58	± 9.6 %
10619	AAB	IEEE 802.11ac WiFi (40MHz, MCS3, 90pc duty cycle)	WLAN	8.86	± 9.6 %
10620	AAB	IEEE 802.11ac WiFi (40MHz, MCS4, 90pc duty cycle)	WLAN	8.87	± 9.6 %
10621	AAB	IEEE 802.11ac WiFi (40MHz, MCS5, 90pc duty cycle)	WLAN	8.77	± 9.6 %
10622	AAB	IEEE 802.11ac WiFi (40MHz, MCS6, 90pc duty cycle)	WLAN	8.68	± 9.6 %
10623	AAB	IEEE 802.11ac WiFi (40MHz, MCS7, 90pc duty cycle)	WLAN	8.82	± 9.6 %
10624	AAB	IEEE 802.11ac WiFi (40MHz, MCS8, 90pc duty cycle)	WLAN	8.96	± 9.6 %
10625	AAB	IEEE 802.11ac WiFi (40MHz, MCS9, 90pc duty cycle)	WLAN	8.96	± 9.6 %
10626	AAB	IEEE 802.11ac WiFi (80MHz, MCS0, 90pc duty cycle)	WLAN	8.83	± 9.6 %
10627	AAB	IEEE 802.11ac WiFi (80MHz, MCS1, 90pc duty cycle)	WLAN	8.88	± 9.6 %
10628	AAB	IEEE 802.11ac WiFi (80MHz, MCS2, 90pc duty cycle)	WLAN	8.71	± 9.6 %
10629	AAB	IEEE 802.11ac WiFi (80MHz, MCS3, 90pc duty cycle)	WLAN	8.85	± 9.6 %
10630	AAB	IEEE 802.11ac WiFi (80MHz, MCS4, 90pc duty cycle)	WLAN	8.72	± 9.6 %
10631	AAB	IEEE 802.11ac WiFi (80MHz, MCS5, 90pc duty cycle)	WLAN	8.81	± 9.6 %
10632	AAB	IEEE 802.11ac WiFi (80MHz, MCS6, 90pc duty cycle)	WLAN	8.74	± 9.6 %
10633	AAB	IEEE 802.11ac WiFi (80MHz, MCS7, 90pc duty cycle)	WLAN	8.83	± 9.6 %
10634	AAB	IEEE 802.11ac WiFi (80MHz, MCS8, 90pc duty cycle)	WLAN	8.80	± 9.6 %
10635	AAB	IEEE 802.11ac WiFi (80MHz, MCS9, 90pc duty cycle)	WLAN	8.81	± 9.6 %
10636	AAC	IEEE 802.11ac WiFi (160MHz, MCS0, 90pc duty cycle)	WLAN	8.83	± 9.6 %
10637	AAC	IEEE 802.11ac WiFi (160MHz, MCS1, 90pc duty cycle)	WLAN	8.79	± 9.6 %
10638	AAC	IEEE 802.11ac WiFi (160MHz, MCS2, 90pc duty cycle)	WLAN	8.86	± 9.6 %
10639	AAC	IEEE 802.11ac WiFi (160MHz, MCS3, 90pc duty cycle)	WLAN	8.85	± 9.6 %
10640	AAC	IEEE 802.11ac WiFi (160MHz, MCS4, 90pc duty cycle)	WLAN	8.98	± 9.6 %
10641	AAC	IEEE 802.11ac WiFi (160MHz, MCS5, 90pc duty cycle)	WLAN	9.06	± 9.6 %
10642	AAC	IEEE 802.11ac WiFi (160MHz, MCS6, 90pc duty cycle)	WLAN	9.06	± 9.6 %
10643	AAC	IEEE 802.11ac WiFi (160MHz, MCS7, 90pc duty cycle)	WLAN	8.89	± 9.6 %
10644	AAC	IEEE 802.11ac WiFi (160MHz, MCS8, 90pc duty cycle)	WLAN	9.05	± 9.6 %
10645	AAC	IEEE 802.11ac WiFi (160MHz, MCS9, 90pc duty cycle)	WLAN	9.11	± 9.6 %
10646	AAG	LTE-TDD (SC-FDMA, 1 RB, 5 MHz, QPSK, UL Subframe=2,7)	LTE-TDD	11.96	± 9.6 %
10647	AAF	LTE-TDD (SC-FDMA, 1 RB, 20 MHz, QPSK, UL Subframe=2,7)	LTE-TDD	11.96	± 9.6 %
10648	AAA	CDMA2000 (1x Advanced)	CDMA2000	3.45	± 9.6 %
10652	AAE	LTE-TDD (OFDMA, 5 MHz, E-TM 3.1, Clipping 44%)	LTE-TDD	6.91	± 9.6 %
10653	AAE	LTE-TDD (OFDMA, 10 MHz, E-TM 3.1, Clipping 44%)	LTE-TDD	7.42	± 9.6 %

10654	AAD	LTE-TDD (OFDMA, 15 MHz, E-TM 3.1, Clipping 44%)	LTE-TDD	6.96	± 9.6 %
10655	AAE	LTE-TDD (OFDMA, 20 MHz, E-TM 3.1, Clipping 44%)	LTE-TDD	7.21	± 9.6 %
10658	AAA	Pulse Waveform (200Hz, 10%)	Test	10.00	± 9.6 %
10659	AAA	Pulse Waveform (200Hz, 20%)	Test	6.99	± 9.6 %
10660	AAA	Pulse Waveform (200Hz, 40%)	Test	3.98	± 9.6 %
10661	AAA	Pulse Waveform (200Hz, 60%)	Test	2.22	± 9.6 %
10662	AAA	Pulse Waveform (200Hz, 80%)	Test	0.97	± 9.6 %
10670	AAA	Bluetooth Low Energy	Bluetooth	2.19	± 9.6 %
10671	AAA	IEEE 802.11ax (20MHz, MCS0, 90pc duty cycle)	WLAN	9.09	± 9.6 %
10672	AAA	IEEE 802.11ax (20MHz, MCS1, 90pc duty cycle)	WLAN	8.57	± 9.6 %
10673	AAA	IEEE 802.11ax (20MHz, MCS2, 90pc duty cycle)	WLAN	8.78	± 9.6 %
10674	AAA	IEEE 802.11ax (20MHz, MCS3, 90pc duty cycle)	WLAN	8.74	± 9.6 %
10675	AAA	IEEE 802.11ax (20MHz, MCS4, 90pc duty cycle)	WLAN	8.90	± 9.6 %
10676	AAA	IEEE 802.11ax (20MHz, MCS5, 90pc duty cycle)	WLAN	8.77	± 9.6 %
10677	AAA	IEEE 802.11ax (20MHz, MCS6, 90pc duty cycle)	WLAN	8.73	± 9.6 %
10678	AAA	IEEE 802.11ax (20MHz, MCS7, 90pc duty cycle)	WLAN	8.78	± 9.6 %
10679	AAA	IEEE 802.11ax (20MHz, MCS8, 90pc duty cycle)	WLAN	8.89	± 9.6 %
10680	AAA	IEEE 802.11ax (20MHz, MCS9, 90pc duty cycle)	WLAN	8.80	± 9.6 %
10681	AAA	IEEE 802.11ax (20MHz, MCS10, 90pc duty cycle)	WLAN	8.62	± 9.6 %
10682	AAA	IEEE 802.11ax (20MHz, MCS11, 90pc duty cycle)	WLAN	8.83	± 9.6 %
10683	AAA	IEEE 802.11ax (20MHz, MCS0, 99pc duty cycle)	WLAN	8.42	± 9.6 %
10684	AAA	IEEE 802.11ax (20MHz, MCS1, 99pc duty cycle)	WLAN	8.26	± 9.6 %
10685	AAA	IEEE 802.11ax (20MHz, MCS2, 99pc duty cycle)	WLAN	8.33	± 9.6 %
10686	AAA	IEEE 802.11ax (20MHz, MCS3, 99pc duty cycle)	WLAN	8.28	± 9.6 %
10687	AAA	IEEE 802.11ax (20MHz, MCS4, 99pc duty cycle)	WLAN	8.45	± 9.6 %
10688	AAA	IEEE 802.11ax (20MHz, MCS5, 99pc duty cycle)	WLAN	8.29	± 9.6 %
10689	AAA	IEEE 802.11ax (20MHz, MCS6, 99pc duty cycle)	WLAN	8.55	± 9.6 %
10690	AAA	IEEE 802.11ax (20MHz, MCS7, 99pc duty cycle)	WLAN	8.29	± 9.6 %
10691	AAA	IEEE 802.11ax (20MHz, MCS8, 99pc duty cycle)	WLAN	8.25	± 9.6 %
10692	AAA	IEEE 802.11ax (20MHz, MCS9, 99pc duty cycle)	WLAN	8.29	± 9.6 %
10693	AAA	IEEE 802.11ax (20MHz, MCS10, 99pc duty cycle)	WLAN	8.25	± 9.6 %
10694	AAA	IEEE 802.11ax (20MHz, MCS11, 99pc duty cycle)	WLAN	8.57	± 9.6 %
10695	AAA	IEEE 802.11ax (40MHz, MCS0, 90pc duty cycle)	WLAN	8.78	± 9.6 %
10696	AAA	IEEE 802.11ax (40MHz, MCS1, 90pc duty cycle)	WLAN	8.91	± 9.6 %
10697	AAA	IEEE 802.11ax (40MHz, MCS2, 90pc duty cycle)	WLAN	8.61	± 9.6 %
10698	AAA	IEEE 802.11ax (40MHz, MCS3, 90pc duty cycle)	WLAN	8.89	± 9.6 %
10699	AAA	IEEE 802.11ax (40MHz, MCS4, 90pc duty cycle)	WLAN	8.82	± 9.6 %
10700	AAA	IEEE 802.11ax (40MHz, MCS5, 90pc duty cycle)	WLAN	8.73	± 9.6 %
10701	AAA	IEEE 802.11ax (40MHz, MCS6, 90pc duty cycle)	WLAN	8.86	± 9.6 %
10702	AAA	IEEE 802.11ax (40MHz, MCS7, 90pc duty cycle)	WLAN	8.70	± 9.6 %
10703	AAA	IEEE 802.11ax (40MHz, MCS8, 90pc duty cycle)	WLAN	8.82	± 9.6 %
10704	AAA	IEEE 802.11ax (40MHz, MCS9, 90pc duty cycle)	WLAN	8.56	± 9.6 %
10705	AAA	IEEE 802.11ax (40MHz, MCS10, 90pc duty cycle)	WLAN	8.69	± 9.6 %
10706	AAA	IEEE 802.11ax (40MHz, MCS11, 90pc duty cycle)	WLAN	8.66	± 9.6 %
10707	AAA	IEEE 802.11ax (40MHz, MCS0, 99pc duty cycle)	WLAN	8.32	± 9.6 %
10708	AAA	IEEE 802.11ax (40MHz, MCS1, 99pc duty cycle)	WLAN	8.55	± 9.6 %
10709	AAA	IEEE 802.11ax (40MHz, MCS2, 99pc duty cycle)	WLAN	8.33	± 9.6 %
10710	AAA	IEEE 802.11ax (40MHz, MCS3, 99pc duty cycle)	WLAN	8.29	± 9.6 %
10711	AAA	IEEE 802.11ax (40MHz, MCS4, 99pc duty cycle)	WLAN	8.39	± 9.6 %
10712	AAA	IEEE 802.11ax (40MHz, MCS5, 99pc duty cycle)	WLAN	8.67	± 9.6 %
10713	AAA	IEEE 802.11ax (40MHz, MCS6, 99pc duty cycle)	WLAN	8.33	± 9.6 %
10714	AAA	IEEE 802.11ax (40MHz, MCS7, 99pc duty cycle)	WLAN	8.26	± 9.6 %
10715	AAA	IEEE 802.11ax (40MHz, MCS8, 99pc duty cycle)	WLAN	8.45	± 9.6 %
10716	AAA	IEEE 802.11ax (40MHz, MCS9, 99pc duty cycle)	WLAN	8.30	± 9.6 %
10717	AAA	IEEE 802.11ax (40MHz, MCS10, 99pc duty cycle)	WLAN	8.48	± 9.6 %
10718	AAA	IEEE 802.11ax (40MHz, MCS11, 99pc duty cycle)	WLAN	8.24	± 9.6 %
10719	AAA	IEEE 802.11ax (80MHz, MCS0, 90pc duty cycle)	WLAN	8.81	± 9.6 %
10720	AAA	IEEE 802.11ax (80MHz, MCS1, 90pc duty cycle)	WLAN	8.87	± 9.6 %
10721	AAA	IEEE 802.11ax (80MHz, MCS2, 90pc duty cycle)	WLAN	8.76	± 9.6 %
10722	AAA	IEEE 802.11ax (80MHz, MCS3, 90pc duty cycle)	WLAN	8.55	± 9.6 %
10723	AAA	IEEE 802.11ax (80MHz, MCS4, 90pc duty cycle)	WLAN	8.70	± 9.6 %
10724	AAA	IEEE 802.11ax (80MHz, MCS5, 90pc duty cycle)	WLAN	8.90	± 9.6 %
10725	AAA	IEEE 802.11ax (80MHz, MCS6, 90pc duty cycle)	WLAN	8.74	± 9.6 %
10726	AAA	IEEE 802.11ax (80MHz, MCS7, 90pc duty cycle)	WLAN	8.72	± 9.6 %

10727	AAA	IEEE 802.11ax (80MHz, MCS8, 90pc duty cycle)	WLAN	8.66	± 9.6 %
10728	AAA	IEEE 802.11ax (80MHz, MCS9, 90pc duty cycle)	WLAN	8.65	± 9.6 %
10729	AAA	IEEE 802.11ax (80MHz, MCS10, 90pc duty cycle)	WLAN	8.64	± 9.6 %
10730	AAA	IEEE 802.11ax (80MHz, MCS11, 90pc duty cycle)	WLAN	8.67	± 9.6 %
10731	AAA	IEEE 802.11ax (80MHz, MCS0, 99pc duty cycle)	WLAN	8.42	± 9.6 %
10732	AAA	IEEE 802.11ax (80MHz, MCS1, 99pc duty cycle)	WLAN	8.46	± 9.6 %
10733	AAA	IEEE 802.11ax (80MHz, MCS2, 99pc duty cycle)	WLAN	8.40	± 9.6 %
10734	AAA	IEEE 802.11ax (80MHz, MCS3, 99pc duty cycle)	WLAN	8.25	± 9.6 %
10735	AAA	IEEE 802.11ax (80MHz, MCS4, 99pc duty cycle)	WLAN	8.33	± 9.6 %
10736	AAA	IEEE 802.11ax (80MHz, MCS5, 99pc duty cycle)	WLAN	8.27	± 9.6 %
10737	AAA	IEEE 802.11ax (80MHz, MCS6, 99pc duty cycle)	WLAN	8.36	± 9.6 %
10738	AAA	IEEE 802.11ax (80MHz, MCS7, 99pc duty cycle)	WLAN	8.42	± 9.6 %
10739	AAA	IEEE 802.11ax (80MHz, MCS8, 99pc duty cycle)	WLAN	8.29	± 9.6 %
10740	AAA	IEEE 802.11ax (80MHz, MCS9, 99pc duty cycle)	WLAN	8.48	± 9.6 %
10741	AAA	IEEE 802.11ax (80MHz, MCS10, 99pc duty cycle)	WLAN	8.40	± 9.6 %
10742	AAA	IEEE 802.11ax (80MHz, MCS11, 99pc duty cycle)	WLAN	8.43	± 9.6 %
10743	AAA	IEEE 802.11ax (160MHz, MCS0, 90pc duty cycle)	WLAN	8.94	± 9.6 %
10744	AAA	IEEE 802.11ax (160MHz, MCS1, 90pc duty cycle)	WLAN	9.16	± 9.6 %
10745	AAA	IEEE 802.11ax (160MHz, MCS2, 90pc duty cycle)	WLAN	8.93	± 9.6 %
10746	AAA	IEEE 802.11ax (160MHz, MCS3, 90pc duty cycle)	WLAN	9.11	± 9.6 %
10747	AAA	IEEE 802.11ax (160MHz, MCS4, 90pc duty cycle)	WLAN	9.04	± 9.6 %
10748	AAA	IEEE 802.11ax (160MHz, MCS5, 90pc duty cycle)	WLAN	8.93	± 9.6 %
10749	AAA	IEEE 802.11ax (160MHz, MCS6, 90pc duty cycle)	WLAN	8.90	± 9.6 %
10750	AAA	IEEE 802.11ax (160MHz, MCS7, 90pc duty cycle)	WLAN	8.79	± 9.6 %
10751	AAA	IEEE 802.11ax (160MHz, MCS8, 90pc duty cycle)	WLAN	8.82	± 9.6 %
10752	AAA	IEEE 802.11ax (160MHz, MCS9, 90pc duty cycle)	WLAN	8.81	± 9.6 %
10753	AAA	IEEE 802.11ax (160MHz, MCS10, 90pc duty cycle)	WLAN	9.00	± 9.6 %
10754	AAA	IEEE 802.11ax (160MHz, MCS11, 90pc duty cycle)	WLAN	8.94	± 9.6 %
10755	AAA	IEEE 802.11ax (160MHz, MCS0, 99pc duty cycle)	WLAN	8.64	± 9.6 %
10756	AAA	IEEE 802.11ax (160MHz, MCS1, 99pc duty cycle)	WLAN	8.77	± 9.6 %
10757	AAA	IEEE 802.11ax (160MHz, MCS2, 99pc duty cycle)	WLAN	8.77	± 9.6 %
10758	AAA	IEEE 802.11ax (160MHz, MCS3, 99pc duty cycle)	WLAN	8.69	± 9.6 %
10759	AAA	IEEE 802.11ax (160MHz, MCS4, 99pc duty cycle)	WLAN	8.58	± 9.6 %
10760	AAA	IEEE 802.11ax (160MHz, MCS5, 99pc duty cycle)	WLAN	8.49	± 9.6 %
10761	AAA	IEEE 802.11ax (160MHz, MCS6, 99pc duty cycle)	WLAN	8.58	± 9.6 %
10762	AAA	IEEE 802.11ax (160MHz, MCS7, 99pc duty cycle)	WLAN	8.49	± 9.6 %
10763	AAA	IEEE 802.11ax (160MHz, MCS8, 99pc duty cycle)	WLAN	8.53	± 9.6 %
10764	AAA	IEEE 802.11ax (160MHz, MCS9, 99pc duty cycle)	WLAN	8.54	± 9.6 %
10765	AAA	IEEE 802.11ax (160MHz, MCS10, 99pc duty cycle)	WLAN	8.54	± 9.6 %
10766	AAA	IEEE 802.11ax (160MHz, MCS11, 99pc duty cycle)	WLAN	8.51	± 9.6 %
10767	AAB	5G NR (CP-OFDM, 1 RB, 5 MHz, QPSK, 15 kHz)	5G NR FR1 TDD	7.99	± 9.6 %
10768	AAB	5G NR (CP-OFDM, 1 RB, 10 MHz, QPSK, 15 kHz)	5G NR FR1 TDD	8.01	± 9.6 %
10769	AAB	5G NR (CP-OFDM, 1 RB, 15 MHz, QPSK, 15 kHz)	5G NR FR1 TDD	8.01	± 9.6 %
10770	AAB	5G NR (CP-OFDM, 1 RB, 20 MHz, QPSK, 15 kHz)	5G NR FR1 TDD	8.02	± 9.6 %
10771	AAB	5G NR (CP-OFDM, 1 RB, 25 MHz, QPSK, 15 kHz)	5G NR FR1 TDD	8.02	± 9.6 %
10772	AAB	5G NR (CP-OFDM, 1 RB, 30 MHz, QPSK, 15 kHz)	5G NR FR1 TDD	8.23	± 9.6 %
10773	AAB	5G NR (CP-OFDM, 1 RB, 40 MHz, QPSK, 15 kHz)	5G NR FR1 TDD	8.03	± 9.6 %
10774	AAB	5G NR (CP-OFDM, 1 RB, 50 MHz, QPSK, 15 kHz)	5G NR FR1 TDD	8.02	± 9.6 %
10776	AAB	5G NR (CP-OFDM, 50% RB, 10 MHz, QPSK, 15 kHz)	5G NR FR1 TDD	8.30	± 9.6 %
10778	AAB	5G NR (CP-OFDM, 50% RB, 20 MHz, QPSK, 15 kHz)	5G NR FR1 TDD	8.34	± 9.6 %
10780	AAB	5G NR (CP-OFDM, 50% RB, 30 MHz, QPSK, 15 kHz)	5G NR FR1 TDD	8.38	± 9.6 %
10781	AAB	5G NR (CP-OFDM, 50% RB, 40 MHz, QPSK, 15 kHz)	5G NR FR1 TDD	8.38	± 9.6 %

10782	AAB	5G NR (CP-OFDM, 50% RB, 50 MHz, QPSK, 15 kHz)	5G NR FR1 TDD	8.43	± 9.6 %
10783	AAB	5G NR (CP-OFDM, 100% RB, 5 MHz, QPSK, 15 kHz)	5G NR FR1 TDD	8.31	± 9.6 %
10784	AAB	5G NR (CP-OFDM, 100% RB, 10 MHz, QPSK, 15 kHz)	5G NR FR1 TDD	8.29	± 9.6 %
10785	AAB	5G NR (CP-OFDM, 100% RB, 15 MHz, QPSK, 15 kHz)	5G NR FR1 TDD	8.40	± 9.6 %
10786	AAB	5G NR (CP-OFDM, 100% RB, 20 MHz, QPSK, 15 kHz)	5G NR FR1 TDD	8.35	± 9.6 %
10787	AAB	5G NR (CP-OFDM, 100% RB, 25 MHz, QPSK, 15 kHz)	5G NR FR1 TDD	8.44	± 9.6 %
10788	AAB	5G NR (CP-OFDM, 100% RB, 30 MHz, QPSK, 15 kHz)	5G NR FR1 TDD	8.39	± 9.6 %
10789	AAB	5G NR (CP-OFDM, 100% RB, 40 MHz, QPSK, 15 kHz)	5G NR FR1 TDD	8.37	± 9.6 %
10790	AAB	5G NR (CP-OFDM, 100% RB, 50 MHz, QPSK, 15 kHz)	5G NR FR1 TDD	8.39	± 9.6 %
10791	AAB	5G NR (CP-OFDM, 1 RB, 5 MHz, QPSK, 30 kHz)	5G NR FR1 TDD	7.83	± 9.6 %
10792	AAB	5G NR (CP-OFDM, 1 RB, 10 MHz, QPSK, 30 kHz)	5G NR FR1 TDD	7.92	± 9.6 %
10793	AAB	5G NR (CP-OFDM, 1 RB, 15 MHz, QPSK, 30 kHz)	5G NR FR1 TDD	7.95	± 9.6 %
10794	AAB	5G NR (CP-OFDM, 1 RB, 20 MHz, QPSK, 30 kHz)	5G NR FR1 TDD	7.82	± 9.6 %
10795	AAB	5G NR (CP-OFDM, 1 RB, 25 MHz, QPSK, 30 kHz)	5G NR FR1 TDD	7.84	± 9.6 %
10796	AAB	5G NR (CP-OFDM, 1 RB, 30 MHz, QPSK, 30 kHz)	5G NR FR1 TDD	7.82	± 9.6 %
10797	AAB	5G NR (CP-OFDM, 1 RB, 40 MHz, QPSK, 30 kHz)	5G NR FR1 TDD	8.01	± 9.6 %
10798	AAB	5G NR (CP-OFDM, 1 RB, 50 MHz, QPSK, 30 kHz)	5G NR FR1 TDD	7.89	± 9.6 %
10799	AAB	5G NR (CP-OFDM, 1 RB, 60 MHz, QPSK, 30 kHz)	5G NR FR1 TDD	7.93	± 9.6 %
10801	AAB	5G NR (CP-OFDM, 1 RB, 80 MHz, QPSK, 30 kHz)	5G NR FR1 TDD	7.89	± 9.6 %
10802	AAB	5G NR (CP-OFDM, 1 RB, 90 MHz, QPSK, 30 kHz)	5G NR FR1 TDD	7.87	± 9.6 %
10803	AAB	5G NR (CP-OFDM, 1 RB, 100 MHz, QPSK, 30 kHz)	5G NR FR1 TDD	7.93	± 9.6 %
10805	AAB	5G NR (CP-OFDM, 50% RB, 10 MHz, QPSK, 30 kHz)	5G NR FR1 TDD	8.34	± 9.6 %
10806	AAB	5G NR (CP-OFDM, 50% RB, 15 MHz, QPSK, 30 kHz)	5G NR FR1 TDD	8.37	± 9.6 %
10809	AAB	5G NR (CP-OFDM, 50% RB, 30 MHz, QPSK, 30 kHz)	5G NR FR1 TDD	8.34	± 9.6 %
10810	AAB	5G NR (CP-OFDM, 50% RB, 40 MHz, QPSK, 30 kHz)	5G NR FR1 TDD	8.34	± 9.6 %
10812	AAB	5G NR (CP-OFDM, 50% RB, 60 MHz, QPSK, 30 kHz)	5G NR FR1 TDD	8.35	± 9.6 %
10817	AAB	5G NR (CP-OFDM, 100% RB, 5 MHz, QPSK, 30 kHz)	5G NR FR1 TDD	8.35	± 9.6 %
10818	AAB	5G NR (CP-OFDM, 100% RB, 10 MHz, QPSK, 30 kHz)	5G NR FR1 TDD	8.34	± 9.6 %
10819	AAB	5G NR (CP-OFDM, 100% RB, 15 MHz, QPSK, 30 kHz)	5G NR FR1 TDD	8.33	± 9.6 %
10820	AAB	5G NR (CP-OFDM, 100% RB, 20 MHz, QPSK, 30 kHz)	5G NR FR1 TDD	8.30	± 9.6 %
10821	AAB	5G NR (CP-OFDM, 100% RB, 25 MHz, QPSK, 30 kHz)	5G NR FR1 TDD	8.41	± 9.6 %
10822	AAB	5G NR (CP-OFDM, 100% RB, 30 MHz, QPSK, 30 kHz)	5G NR FR1 TDD	8.41	± 9.6 %
10823	AAB	5G NR (CP-OFDM, 100% RB, 40 MHz, QPSK, 30 kHz)	5G NR FR1 TDD	8.36	± 9.6 %

10824	AAB	5G NR (CP-OFDM, 100% RB, 50 MHz, QPSK, 30 kHz)	5G NR FR1 TDD	8.39	± 9.6 %
10825	AAB	5G NR (CP-OFDM, 100% RB, 60 MHz, QPSK, 30 kHz)	5G NR FR1 TDD	8.41	± 9.6 %
10827	AAB	5G NR (CP-OFDM, 100% RB, 80 MHz, QPSK, 30 kHz)	5G NR FR1 TDD	8.42	± 9.6 %
10828	AAB	5G NR (CP-OFDM, 100% RB, 90 MHz, QPSK, 30 kHz)	5G NR FR1 TDD	8.43	± 9.6 %
10829	AAB	5G NR (CP-OFDM, 100% RB, 100 MHz, QPSK, 30 kHz)	5G NR FR1 TDD	8.40	± 9.6 %
10830	AAB	5G NR (CP-OFDM, 1 RB, 10 MHz, QPSK, 60 kHz)	5G NR FR1 TDD	7.63	± 9.6 %
10831	AAB	5G NR (CP-OFDM, 1 RB, 15 MHz, QPSK, 60 kHz)	5G NR FR1 TDD	7.73	± 9.6 %
10832	AAB	5G NR (CP-OFDM, 1 RB, 20 MHz, QPSK, 60 kHz)	5G NR FR1 TDD	7.74	± 9.6 %
10833	AAB	5G NR (CP-OFDM, 1 RB, 25 MHz, QPSK, 60 kHz)	5G NR FR1 TDD	7.70	± 9.6 %
10834	AAB	5G NR (CP-OFDM, 1 RB, 30 MHz, QPSK, 60 kHz)	5G NR FR1 TDD	7.75	± 9.6 %
10835	AAB	5G NR (CP-OFDM, 1 RB, 40 MHz, QPSK, 60 kHz)	5G NR FR1 TDD	7.70	± 9.6 %
10836	AAB	5G NR (CP-OFDM, 1 RB, 50 MHz, QPSK, 60 kHz)	5G NR FR1 TDD	7.66	± 9.6 %
10837	AAB	5G NR (CP-OFDM, 1 RB, 60 MHz, QPSK, 60 kHz)	5G NR FR1 TDD	7.68	± 9.6 %
10839	AAB	5G NR (CP-OFDM, 1 RB, 80 MHz, QPSK, 60 kHz)	5G NR FR1 TDD	7.70	± 9.6 %
10840	AAB	5G NR (CP-OFDM, 1 RB, 90 MHz, QPSK, 60 kHz)	5G NR FR1 TDD	7.67	± 9.6 %
10841	AAB	5G NR (CP-OFDM, 1 RB, 100 MHz, QPSK, 60 kHz)	5G NR FR1 TDD	7.71	± 9.6 %
10843	AAB	5G NR (CP-OFDM, 50% RB, 15 MHz, QPSK, 60 kHz)	5G NR FR1 TDD	8.49	± 9.6 %
10844	AAB	5G NR (CP-OFDM, 50% RB, 20 MHz, QPSK, 60 kHz)	5G NR FR1 TDD	8.34	± 9.6 %
10846	AAB	5G NR (CP-OFDM, 50% RB, 30 MHz, QPSK, 60 kHz)	5G NR FR1 TDD	8.41	± 9.6 %
10854	AAB	5G NR (CP-OFDM, 100% RB, 10 MHz, QPSK, 60 kHz)	5G NR FR1 TDD	8.34	± 9.6 %
10855	AAB	5G NR (CP-OFDM, 100% RB, 15 MHz, QPSK, 60 kHz)	5G NR FR1 TDD	8.36	± 9.6 %
10856	AAB	5G NR (CP-OFDM, 100% RB, 20 MHz, QPSK, 60 kHz)	5G NR FR1 TDD	8.37	± 9.6 %
10857	AAB	5G NR (CP-OFDM, 100% RB, 25 MHz, QPSK, 60 kHz)	5G NR FR1 TDD	8.35	± 9.6 %
10858	AAB	5G NR (CP-OFDM, 100% RB, 30 MHz, QPSK, 60 kHz)	5G NR FR1 TDD	8.36	± 9.6 %
10859	AAB	5G NR (CP-OFDM, 100% RB, 40 MHz, QPSK, 60 kHz)	5G NR FR1 TDD	8.34	± 9.6 %
10860	AAB	5G NR (CP-OFDM, 100% RB, 50 MHz, QPSK, 60 kHz)	5G NR FR1 TDD	8.41	± 9.6 %
10861	AAB	5G NR (CP-OFDM, 100% RB, 60 MHz, QPSK, 60 kHz)	5G NR FR1 TDD	8.40	± 9.6 %
10863	AAB	5G NR (CP-OFDM, 100% RB, 80 MHz, QPSK, 60 kHz)	5G NR FR1 TDD	8.41	± 9.6 %
10864	AAB	5G NR (CP-OFDM, 100% RB, 90 MHz, QPSK, 60 kHz)	5G NR FR1 TDD	8.37	± 9.6 %
10865	AAB	5G NR (CP-OFDM, 100% RB, 100 MHz, QPSK, 60 kHz)	5G NR FR1 TDD	8.41	± 9.6 %
10866	AAB	5G NR (DFT-s-OFDM, 1 RB, 100 MHz, QPSK, 30 kHz)	5G NR FR1 TDD	5.68	± 9.6 %
10868	AAB	5G NR (DFT-s-OFDM, 100% RB, 100 MHz, QPSK, 30 kHz)	5G NR FR1 TDD	5.89	± 9.6 %
10869	AAC	5G NR (DFT-s-OFDM, 1 RB, 100 MHz, QPSK, 120 kHz)	5G NR FR2 TDD	5.75	± 9.6 %

10870	AAC	5G NR (DFT-s-OFDM, 100% RB, 100 MHz, QPSK, 120 kHz)	5G NR FR2 TDD	5.86	± 9.6 %
10871	AAC	5G NR (DFT-s-OFDM, 1 RB, 100 MHz, 16QAM, 120 kHz)	5G NR FR2 TDD	5.75	± 9.6 %
10872	AAC	5G NR (DFT-s-OFDM, 100% RB, 100 MHz, 16QAM, 120 kHz)	5G NR FR2 TDD	6.52	± 9.6 %
10873	AAC	5G NR (DFT-s-OFDM, 1 RB, 100 MHz, 64QAM, 120 kHz)	5G NR FR2 TDD	6.61	± 9.6 %
10874	AAC	5G NR (DFT-s-OFDM, 100% RB, 100 MHz, 64QAM, 120 kHz)	5G NR FR2 TDD	6.65	± 9.6 %
10875	AAC	5G NR (CP-OFDM, 1 RB, 100 MHz, QPSK, 120 kHz)	5G NR FR2 TDD	7.78	± 9.6 %
10876	AAC	5G NR (CP-OFDM, 100% RB, 100 MHz, QPSK, 120 kHz)	5G NR FR2 TDD	8.39	± 9.6 %
10877	AAC	5G NR (CP-OFDM, 1 RB, 100 MHz, 16QAM, 120 kHz)	5G NR FR2 TDD	7.95	± 9.6 %
10878	AAC	5G NR (CP-OFDM, 100% RB, 100 MHz, 16QAM, 120 kHz)	5G NR FR2 TDD	8.41	± 9.6 %
10879	AAC	5G NR (CP-OFDM, 1 RB, 100 MHz, 64QAM, 120 kHz)	5G NR FR2 TDD	8.12	± 9.6 %
10880	AAC	5G NR (CP-OFDM, 100% RB, 100 MHz, 64QAM, 120 kHz)	5G NR FR2 TDD	8.38	± 9.6 %
10881	AAC	5G NR (DFT-s-OFDM, 1 RB, 50 MHz, QPSK, 120 kHz)	5G NR FR2 TDD	5.75	± 9.6 %
10882	AAC	5G NR (DFT-s-OFDM, 100% RB, 50 MHz, QPSK, 120 kHz)	5G NR FR2 TDD	5.96	± 9.6 %
10883	AAC	5G NR (DFT-s-OFDM, 1 RB, 50 MHz, 16QAM, 120 kHz)	5G NR FR2 TDD	6.57	± 9.6 %
10884	AAC	5G NR (DFT-s-OFDM, 100% RB, 50 MHz, 16QAM, 120 kHz)	5G NR FR2 TDD	6.53	± 9.6 %
10885	AAC	5G NR (DFT-s-OFDM, 1 RB, 50 MHz, 64QAM, 120 kHz)	5G NR FR2 TDD	6.61	± 9.6 %
10886	AAC	5G NR (DFT-s-OFDM, 100% RB, 50 MHz, 64QAM, 120 kHz)	5G NR FR2 TDD	6.65	± 9.6 %
10887	AAC	5G NR (CP-OFDM, 1 RB, 50 MHz, QPSK, 120 kHz)	5G NR FR2 TDD	7.78	± 9.6 %
10888	AAC	5G NR (CP-OFDM, 100% RB, 50 MHz, QPSK, 120 kHz)	5G NR FR2 TDD	8.35	± 9.6 %
10889	AAC	5G NR (CP-OFDM, 1 RB, 50 MHz, 16QAM, 120 kHz)	5G NR FR2 TDD	8.02	± 9.6 %
10890	AAC	5G NR (CP-OFDM, 100% RB, 50 MHz, 16QAM, 120 kHz)	5G NR FR2 TDD	8.40	± 9.6 %
10891	AAC	5G NR (CP-OFDM, 1 RB, 50 MHz, 64QAM, 120 kHz)	5G NR FR2 TDD	8.13	± 9.6 %
10892	AAC	5G NR (CP-OFDM, 100% RB, 50 MHz, 64QAM, 120 kHz)	5G NR FR2 TDD	8.41	± 9.6 %

^E Uncertainty is determined using the max. deviation from linear response applying rectangular distribution and is expressed for the square of the field value.

Appendix D. Photographs of EUT and Setup

The photographs of EUT and setup for HAC measurement are shown as follows.