

User Guide

DURA **FORCE**
PRO 2

with SAPPHIRE SHIELD

by  **KYOCERA**

Table of Contents

Introduction	1
Get Started	2
Your Phone at a Glance.....	2
Set Up Your Phone.....	4
Charge the Battery.....	4
Your SIM Card.....	5
Charge the Battery Wirelessly	7
Turn Your Phone On and Off	7
Turn Your Screen On and Off.....	8
Setup Wizard.....	9
Set Up Voice Mail	10
Phone Basics.....	11
Touchscreen Navigation	11
Function Buttons.....	13
Your Home Screen	13
Home Screen Overview.....	13
Extended Home Screens.....	14
Manage the Home Screens	15
Weather.....	17
Quick Shortcuts	18
Dura Grid.....	18
Launcher Screens.....	19
Status Bar.....	20
Notifications Panel.....	20
Quick Settings	21
Enter Text.....	22
Touchscreen Keyboards.....	22
Gboard	22
Glide Typing	25
Google Voice Typing	25

Copy and Paste Text	26
Phone Calls	27
Make Phone Calls.....	27
Call Using the Phone Dialpad	27
Call from Recents	28
Call from Contacts	28
Call Using a Speed Dial Number	28
Call Emergency Numbers	28
Call Numbers with Pauses.....	29
Call Using the Plus (+) Code.....	29
Receive Phone Calls.....	30
Voice Mail	30
Review Voice Mail	31
Configure Voice Mail Settings.....	32
Voice Mail (Traditional)	32
Set Up Voice Mail	32
Voice Mail Notification	32
Retrieve Your Voice Mail Messages	32
Phone Call Options.....	33
In-call Options.....	33
Caller Name ID	34
Call Waiting	34
3-Way Calling	34
Call Forwarding	35
Set Up Speed Dialing.....	35
Recent Calls	36
Call Settings	38
Call Rejection	38
Quick Responses.....	38
Auto Answer	39
Power Key Ends Call	39
Noise Reduction	39
Additional Settings.....	39

Video Calling	40
Phone Ringtone.....	40
Vibrate When Ringing.....	40
Dial Pad Touch Tones	40
Voicemail.....	40
Assisted Dialing	40
TTY Mode.....	41
Hearing Aids.....	41
Call Timer	42
Push To Talk Plus (PTT+).....	42
Contacts.....	44
Contacts List.....	44
Add a Contact.....	45
Save a Phone Number.....	46
Edit a Contact	46
Add a Group Contact	50
Edit a Group Contact	50
ICE (In Case of Emergency)	51
Synchronize Contacts	52
Accounts and Messaging	53
Gmail / Google.....	53
Create a Google Account.....	53
Sign In to Your Google Account.....	54
Access Gmail.....	54
Send a Gmail Message	54
Read and Reply to Gmail Messages.....	55
Gmail Account Settings	55
Delete a Gmail Account	56
Email	56
Set up Email Account	56
Access Email.....	56
Message+	57
Save and Resume a Draft Message	57

Social Networking Accounts.....	58
YouTube.....	58
Apps and Entertainment.....	59
Google Play Store App	59
Find and Install an App	59
Google Play Store Options	60
Open an Installed App	60
Uninstall an App	60
Google Maps	61
Music	63
Play Music	63
Web and Data.....	65
Wi-Fi.....	65
Turn Wi-Fi On and Connect to a Wireless Network.....	65
Check the Wireless Network Status.....	66
Connect to a Different Wi-Fi Network.....	66
The Wi-Fi Settings Menu	66
Data Services	67
Launch a Web Connection.....	67
Data Connection Status and Indicators.....	67
Virtual Private Networks (VPN)	68
Prepare Your Phone for VPN Connection.....	68
Install Security Certificates.....	68
Add a VPN Connection.....	69
Connect to or Disconnect from a VPN	69
Browser	69
Launch Chrome	69
Learn to Navigate Chrome.....	70
Chrome Menu.....	71
Select Text on a Web Page	72
Manage Bookmarks.....	72
Mobile Hotspot.....	73
Tethering	73

Camera and Camcorder.....	74
Use the Camera App	74
Open or Close the Camera App.....	74
Viewfinder Screen.....	74
Take a Picture or Record a Video	75
Review Screen	76
Action Overlay Mode	77
Underwater Mode	78
Camera and Camcorder Settings.....	79
View Pictures and Videos Using Photos	80
Open or Close Photos	81
View Pictures and Videos	81
Zoom In or Out on a Picture.....	82
Work with Pictures	82
Picture Options Menu	82
Edit a Picture	82
Share Pictures and Videos.....	83
Send Pictures or Videos by Gmail	83
Send Pictures or Videos by Message+	84
Send Pictures or Videos Using Bluetooth	84
Share Videos on YouTube.....	84
Tools and Calendar.....	85
Calendar	85
Add an Event to the Calendar.....	85
Invite Guests to Your Calendar Event.....	86
Calendar Event Alerts.....	86
Add Reminders in the Calendar	87
Create a Goal in the Calendar	87
View Calendar Events	88
Edit Calendar Events, Reminders, or Goals.....	88
Delete Calendar Events, Reminders, or Goals.....	89
Quickly Hide or Show Events.....	89
Calendar Settings	89

Synchronize Calendars with Your Phone	90
Clock	90
World Clock	90
Alarm	91
Timer	92
Stopwatch.....	92
Calculator	93
Flashlight	93
Sound Recorder.....	94
Voice Services	95
Text-to-Speech	95
Voice Search	95
Eco Mode	96
Bluetooth	97
Turn Bluetooth On or Off.....	97
The Bluetooth Settings Menu.....	97
Change the Phone Name	97
Connect a Bluetooth Headset or Car Kit	98
Reconnect a Headset or Car Kit	98
Unpair from a Bluetooth Device	99
Send and Receive Information Using Bluetooth.....	99
Supported Bluetooth Profiles	100
Near Field Communication (NFC) Technology.....	101
Turn NFC On or Off	101
Android Beam.....	102
microSD Card	103
Insert or Remove a microSD Card	103
View the microSD Card Memory.....	105
Format the microSD Card	105
Unmount the microSD Card.....	105
Use the Phone's microSD Card as a Media Device	106
File Commander	106
Supported Formats	107

Outdoor Portal	107
Settings.....	109
Network & Internet	109
Wi-Fi Settings	109
Cellular network settings.....	109
Data Usage Settings.....	111
Mobile Hotspot & tethering.....	113
VPN Settings	115
Airplane mode	115
Wireless emergency alerts.....	115
Advanced Calling	116
Video Calling	116
Wi-Fi Calling	116
Connected devices	117
Bluetooth	117
Cast.....	117
NFC.....	117
Android Beam.....	117
Printing.....	117
USB.....	118
Display.....	118
Brightness level	118
Adaptive brightness	118
Night Light	118
Wallpaper	118
Sleep	118
Glove touch mode.....	119
Auto-rotate screen	119
Font size.....	119
Display size	119
Screen saver	119
Show battery percentage.....	120
Display quick settings	120

Sound	120
Volume	120
Also vibrate for calls.....	120
Do Not Disturb preferences	120
Phone ringtone	121
Vibrate pattern	121
Vibrate intensity	121
Default notification sound.....	122
Default alarm sound.....	122
Other sounds and vibrations	123
Programmable keys	123
Apps & notifications	124
Battery	126
Storage	126
Device storage.....	126
SD Card.....	126
Security & location	127
Security status	127
Screen lock.....	127
Screen lock settings.....	127
Fingerprint	129
Location.....	130
Show passwords	131
Device admin apps	132
SIM card lock.....	132
Encryption & credentials	132
Trust agents.....	134
Screen pinning.....	134
Apps with usage access	134
Accounts.....	134
Accessibility	135
Volume key shortcut	135
Downloaded services.....	136

Select to Speak	136
TalkBack.....	136
Text-to-speech output.....	136
Font size.....	136
Magnification	136
Color correction	137
Color inversion.....	137
Large mouse pointer.....	137
Switch Access	137
Click after pointer stops moving	137
Power key ends call.....	137
Auto-rotate screen	138
Touch & hold delay	138
Mono audio.....	138
Captions	138
Sound balance.....	138
Hearing aids	138
High contrast text.....	139
Google	139
System.....	139
Languages & Input.....	139
Date & time.....	140
Backup	141
Reset options.....	141
About phone	142
System updates	142
Drying Procedures	144
Drying Your Phone	144
Notes	145
Copyright & Trademarks	146

Introduction

Thank you for purchasing this Kyocera product. Please read this user guide carefully before using the device to ensure safe and proper use.

Descriptions in the User Guide

Most descriptions in this user guide are based on your phone's setup at the time of purchase. Instructions to perform tasks in this guide may change depending on the version of software or application on your phone. Certain menus as to option settings are not displayed or visible depending on each setting status.

All screens in this guide are simulated. Actual displays may vary. Certain features, services, and applications are network dependent and may not be available in all areas; additional terms, conditions and/or charges may apply. Contact your service provider about feature availability and functionality.

All features, functionality, and other specifications, as well as the information contained in this guide are based upon the latest available information and are believed to be accurate at the time of issuing. Kyocera International, Inc. reserves the right to change or modify any information or specifications without notice or obligation.

For warranty service information, please refer to the Safety and Warranty Information linked from your phone or call the following telephone number from anywhere in the continental United States and Canada: 1-800-349-4478.

This phone can determine its/your geographical location (location information) and can associate location information with other data. For some services and applications, location information must be turned on and you have to agree to its collection. Additionally, certain services, applications, and programs are capable of accessing, collecting, storing, and using location information and disclosing it to others. You should decide carefully when determining whether location information should be made available to others.

©2018 Kyocera Corporation. KYOCERA is a registered trademark of Kyocera Corporation. All other trademarks are the property of their respective owners.

Get Started

The following topics give you all the information you need to set up your phone and service the first time.

Your Phone at a Glance

The following illustration outlines your phone's primary external features and buttons.



Key Functions

- **Earpiece** lets you hear the caller and automated prompts.
- **Front camera** takes pictures and records videos while facing the screen and allows you to video conference.
- **Touchscreen** displays all the information needed to operate your phone. Use finger gestures to navigate and interact with items on the screen. In Underwater mode, the touch operation will be disabled.
- **Quaternary microphone** suppresses background noise improving audio quality for the other party during voice calls.
- **Speakers** let you hear different ringtones and sounds. The speakers also let you hear the caller's voice in speakerphone mode.
- **Primary microphone** transmits your voice for phone calls and is used for voice-activated functions. It is disabled in speakerphone mode.
- **Tertiary microphone** suppresses background noise improving audio quality for the other party during voice calls.
- **Proximity/Light sensor** detects how close an object is to the surface of the screen. This is typically used to detect when your face is pressed up against the screen, such as during a phone call.
- **LED indicator** displays a phone notification, charging status, or alert.
- **Headset jack** allows you to plug in an optional headset for convenient, hands-free conversations or for listening to music.
- **USB/Charger port** allows you to connect the phone and the micro-USB cable for use with the charger adapter, or other compatible accessories.

CAUTION! Inserting an accessory into the incorrect jack may damage the phone.

- **Volume buttons** allow you to adjust the ringtone or media volume when you are not on a call, or adjust the voice volume during a call.
- **PTT/Programmable button** allows you to assign a frequently used function for quick access. By installing PTT application, this button can also act as a PTT button. See [Programmable keys](#).
- **Power button** lets you turn the phone on or off or turn the screen on or off, restart the phone, or capture screenshots. This button also works as the fingerprint sensor.
- **SIM/microSD card slot** allows you to insert a SIM card and a microSD card placed on the SIM/microSD card tray.

Note: microSD cards are sold separately.

- **Camera button** lets you activate the front camera, the back camera or the wide view camera.
- **Secondary microphone** suppresses background noise improving audio quality for the other party during voice calls. In speakerphone mode, it is used as a main microphone.
- **Flash** helps illuminate subjects in low-light environments when taking a picture or recording a video. It can also work as an LED flashlight. See [Flashlight](#).
- **Wide view camera** lets you take pictures and videos in wide angle.
- **Back camera** lets you take pictures and videos.

Set Up Your Phone

You need to charge the battery to begin setting up your phone.

Charge the Battery

Fully charge the battery before powering on the phone.

Note: The battery cannot be removed from the phone. For replacing or disposing the battery, contact a KYOCERA authorized service center.

Important: Unplug the AC adapter from the electrical outlet when not in use to reduce the environmental impact of charging.

1. Open the cover to the USB/Charger port on the bottom of the phone.
2. Plug the smaller end of the USB cable into the phone's USB/Charger port.
3. Plug the other end of the USB cable into the AC adapter, and then plug the adapter into an electrical outlet. Be sure to use the AC adapter that came with your phone.



4. When charging is complete, remove the cable from the port and close the cover.

Note: Make sure all ports and covers are properly sealed to maintain your phone's waterproof seal.



Your SIM Card

Your phone comes with a preinstalled SIM card. If you need to reinstall your SIM card, follow the instructions below.

1. With the phone facing down, open the SIM/microSD card slot cover.

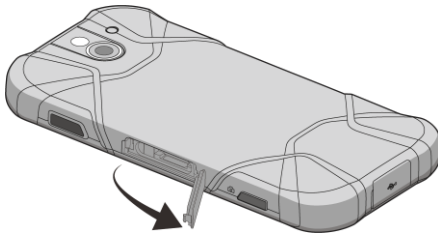

2. Hook your fingernail on the rib on the tray's top edge and pull it out.

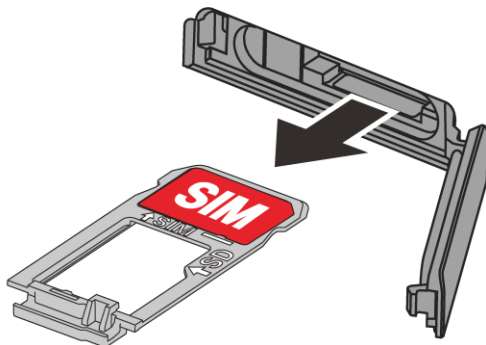

- Put the tray onto a flat surface and remove the original SIM card from the tray and place your new SIM card into the tray with the gold contacts facing down as shown.

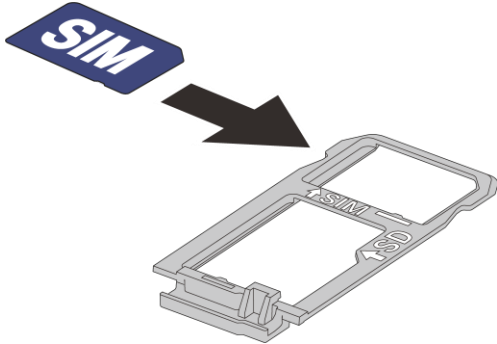

- Insert the tray into the phone, being careful not to let the card slide out. Then gently push the tray in until it clicks.

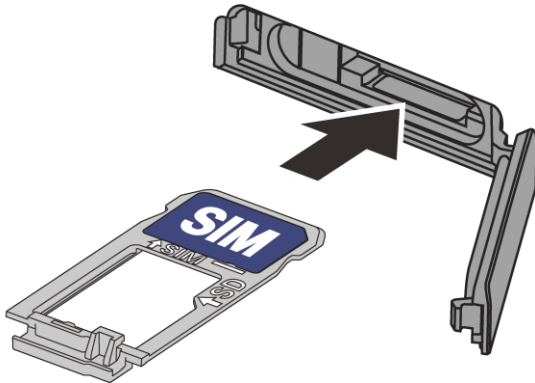

- After the tray is all the way back in your phone, securely close the card slot cover.

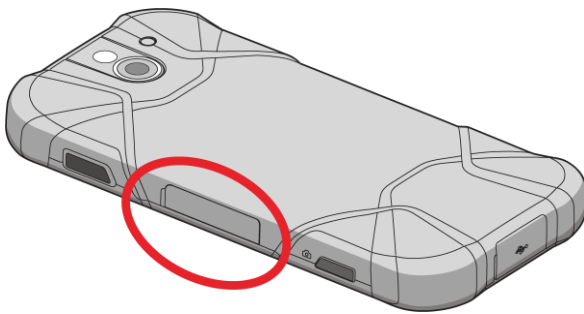

Note: Make sure the SIM/microSD card slot cover is securely closed to maintain your phone's waterproof seal.

Warning: Do not use the phone under water with a broken or open SIM/microSD card slot cover, USB/Charger port cover or headset jack cover.

Charge the Battery Wirelessly

Your phone supports Qi and works with Qi-enabled chargers. Follow the steps below to charge the battery using a wireless charger (sold separately).

1. Locate the charging area on your wireless charger by referring to the charger documentation.
2. Place your phone ensuring that the charging area of your phone touches the charging area of your wireless charger.



Before starting wireless charging, please note the following:

- If the charging areas are not touching, the charging results will be poor.
- Make sure there is nothing between your phone and wireless charger.
- Your phone may become hot while charging the battery.
- If charging doesn't start after positioning your phone correctly, please use the AC adapter that came with your phone.

For more information on wireless charging, see your wireless charger documentation.

Turn Your Phone On and Off

The instructions below explain how to turn your phone on and off.

Turn Your Phone On

- ▶ Press and hold the **Power button** until the screen lights up.

Turn Your Phone Off

1. Press and hold the **Power button** until the phone options are displayed.
2. Tap **Power off** to turn the phone off.

Restart Your Phone

1. Press and hold the **Power button** until the phone options are displayed.
2. Tap **Restart** to restart the phone.

Turn Your Screen On and Off

Your phone allows you to quickly turn the screen off when not in use and to turn it back on when you need it.

Turn the Screen Off When Not in Use

- ▶ To quickly turn the screen off, press the **Power button**. Pressing the **Power button** again or receiving an incoming call will turn on your phone screen.

To save battery power, the phone screen automatically turns off after a certain period of time when left idle. You will still be able to receive messages and calls while the phone screen is off.

Note: For information on how to adjust the time before the screen turns off, see [Sleep](#).



Turn the Screen On and Start with Swipe

1. Press the **Power button** to turn the screen on. The below screen appears by default.

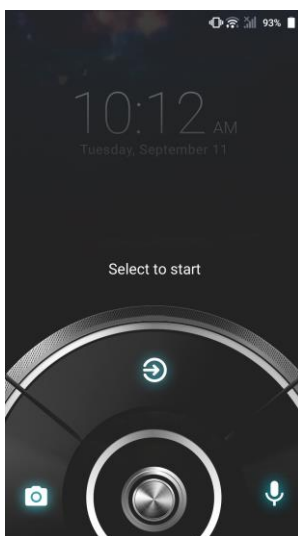
Note: To set up a screen lock for security, see [Screen Lock](#).



2. On the screen, swipe  toward:

-  to access the Home screen or the screen displayed before it was turned off.
-  to launch the Camera app.
-  to launch Google Assistant.

Setup Wizard

Your phone has a Setup Wizard to set up your phone quickly and easily. When you turn on your phone for the first time, the Setup Wizard starts automatically.

The Setup Wizard consists of the following sections:

- Language
- Phone Activation
- Set Up Wi-Fi
- Protect your phone
- Google services
- Email accounts
- Security & Privacy

Follow the onscreen instructions to quickly set up your phone.

Language Selection

- ▶ Select your language from **English**, **Español**, 简体中文, 繁體中文, 한국어, or **Tiếng Việt** and tap **START**.

Phone Activation

Confirmation screen appears if you have not inserted your SIM card yet or it may be inserted incorrectly. Follow the instructions onscreen.

Set Up Wi-Fi

Select a network if you want to connect to Wi-Fi. Follow the instructions onscreen.

Protect your phone

Choose the device protection features from the list. Follow the instructions onscreen.

Google services

Instruction screen about Google appears. Follow the instructions onscreen.

Email accounts

Choose the type of email accounts you want to set up and configure them. Follow the instructions onscreen.

Security & Privacy

Confirmation screen of Security & Privacy appears and follow the instructions onscreen.

Set Up Voice Mail



Your phone comes with the Voice Mail application. Voice Mail allows you to manage your Voice Mail directly from your phone rather than calling in to your Voice Mail. Voice Mail displays a list of your messages and allows you to choose which message(s) to listen or delete. You can also choose the traditional Voice Mail service. See [Voice Mail \(Traditional\)](#).

Note: Voice Mail is a subscription based service.

Set Up Voice Mail

1. From the Home screen, tap **Apps**  > **Voice Mail**.
2. Read the message and tap **Continue**.
3. Terms & Conditions may appear. Read it and tap **Accept**, if you agree to it.
4. Tap **Continue** and follow the onscreen instructions for setting language, password, greetings, etc.

Set Up Traditional Voice Mail

1. From the Home screen, tap **Apps**  > **Phone** > **DIALPAD**.
2. Touch and hold **1** or dial ***86** and then tap .
3. When you hear the greeting, tap **#** to interrupt, and follow the prompts.

Phone Basics

Your phone is packed with features that simplify your life and expand your ability to stay connected to the people and information that are important to you. The following topics will introduce the basic functions and features of your phone.

Touchscreen Navigation

Your phone's touchscreen lets you control actions through a variety of tap gestures.

Tap



Tap the screen with your finger to select or launch a menu, option, or application. A light tap works best.

Touch and Hold

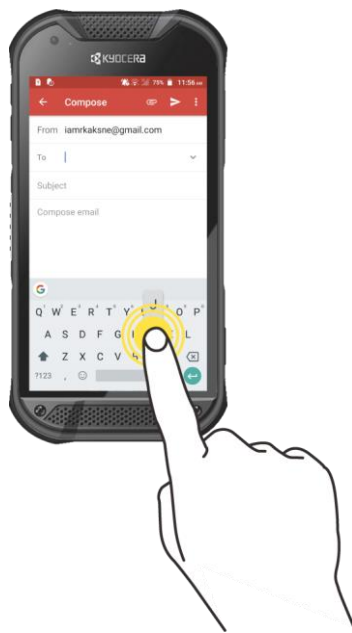

To open the available options for an item (for example, a keyboard), touch and hold the item.

Drag

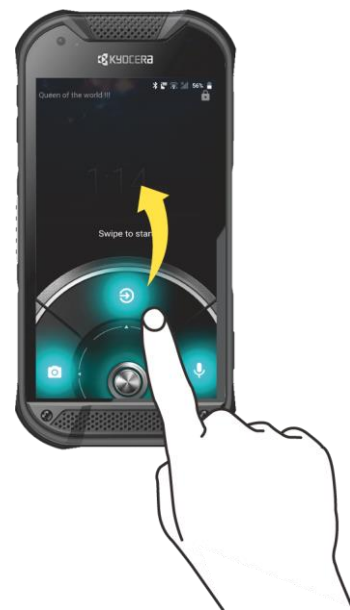

Touch and hold your finger before you start to move it. Do not release your finger until you have reached the target position.

Swipe or Slide



To swipe or slide means to quickly drag your finger vertically or horizontally across the screen.

Flick

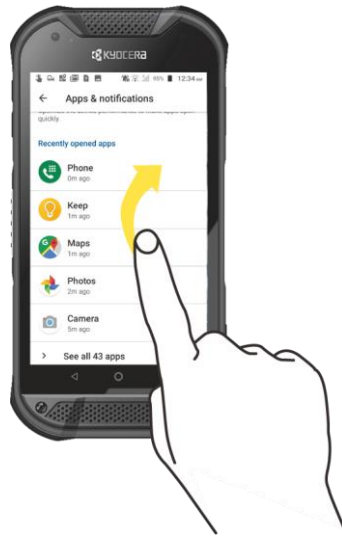

Flicking the screen is similar to swiping, except that you need to swipe your finger in light, quick strokes.

Pinch and Spread



Pinch the screen using your thumb and forefinger to zoom out, or spread the screen to zoom in when viewing a picture or a Web page. (Move fingers inward to zoom out and outward to zoom in.)

Rotate

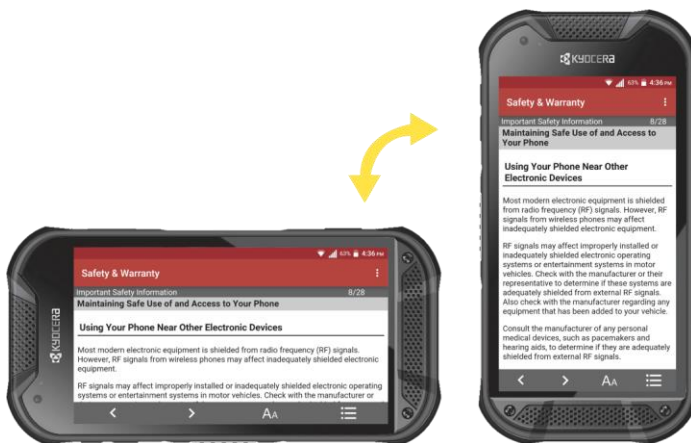





For most screens, you can automatically change the screen orientation from portrait to landscape by turning the phone sideways. When entering text, you can turn the phone sideways to bring up a bigger keyboard. See [Touchscreen Keyboards](#).

Note: Rotate the contents of the screen needs to be selected for the screen orientation to automatically change. From the Home screen, tap **Apps**  > **Settings** > **Display** > **Auto-rotate screen**.

Function Buttons

You will find a row of three buttons that let you perform specific functions as below.



- **Back** () - Tap to return to the previous screen, or close a dialog box, options menu, the Notifications panel, or onscreen keyboard.
- **Home** () - Tap to open the Home screen.
 - Touch and hold to launch Google Assistant.
- **Recent** () - Tap to open a list of thumbnail images of screens you have worked with recently. To open one, tap it. To remove a screen from the list, swipe it left or right or tap on the **X**. To close all screens, tap .

Your Home Screen

The Home screen is the starting point for your phone's applications, functions, and menus. You can customize your Home screen by adding application icons, shortcuts, folders, widgets, wallpapers and more.

Home Screen Overview

The following illustration describes the basics of the Home screen.

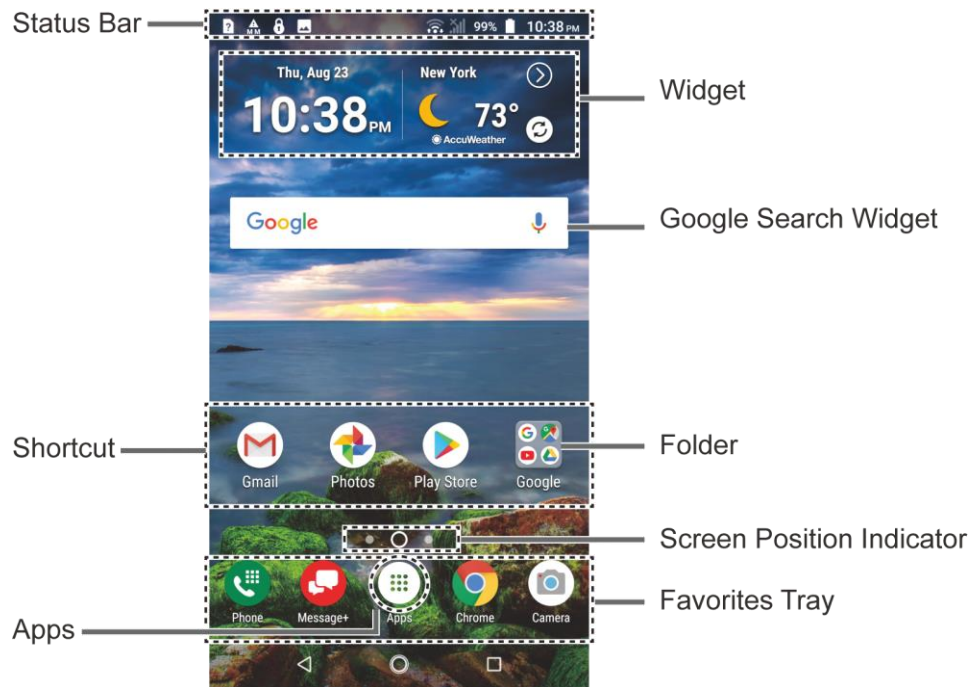

- **Status Bar:** Displays the time, notification icons, and phone status icons. Slide down to display the Notifications panel. See [Status Bar](#).
- **Widget:** Allows users to access various useful programs.
- **Google Search Widget:** Allows you to enter text or spoken keywords for a quick search on the phone or on the Internet. Tap to enter text or tap  to speak your keyword.
- **Folder:** Allows you to organize screen items. You can store multiple application icons as a group. See [Use Folder](#).
- **Screen Position Indicator:** Indicates where you are among the Home screens. Tap an icon to select a Home screen.
- **Favorites Tray:** Contains up to five icons and appears on every Home screen. You can customize these icons except the Apps icon in the center of the tray.
- **Apps:** Displays all of your apps.
- **Shortcut:** Allows you to quickly launch applications.

Extended Home Screens

The Home screen extends beyond the initial screen. In addition to the main Home screen, your phone can have up to ten extended Home screens to provide more space for adding icons and widgets.

- ▶ On the Home screen, swipe across the screen to move from the main Home screen to an extended Home screen.

– or –

On the screen position indicator, tap Home button to access the main Home screen, or tap  to access each extended Home screen.

Manage the Home Screens

Learn how to customize the Home screens.

Add or Reduce the Home Screens

You can have up to eleven Home screens.

1. Touch and hold any empty area on the Home screen to display the Home screen thumbnails.
2. The following options are available:
 - Tap a thumbnail to access the Home screen.
 - Tap  to add a new Home screen.
 - Touch and hold a thumbnail and drag it to rearrange the positions of the Home screens. Release the thumbnail where you want to place it.
 - Touch and hold a thumbnail, drag it to "**REMOVE**" and release it when it turns red to remove the Home screen.
 - Tap the Home icon at the top of each screen to set that screen as the main Home screen.

Add App Shortcuts or Widgets to the Home Screen

1. Touch and hold any empty area on the Home screen.
2. Tap **APPS** or **WIDGETS**.
3. Slide the screen to find the item you want to add to the Home screen.
4. Touch and hold the item and move your finger to one of the Home screen thumbnails displayed at the top of the screen.
5. When you find the position to place the item, release your finger.

Tip: You can also select a Home screen thumbnail where you want to place the item and then simply tap the item.

Move or Remove Items on the Home Screen

- ▶ Touch and hold the item you want to move or remove from the Home screen.

- To move the item, drag it to a new area and release it.
- To remove the item, drag it to "**REMOVE**" at the top of the screen and release it.

Favorites Tray

The favorites tray takes up to five icons and appears on every Home screen. You can replace those icons except the Apps icon in the center of the tray.

To add a new icon to the favorites tray:

1. Remove the current icon on the tray. See [Move or Remove Items on the Home Screen](#).
2. Touch and hold an app icon and drag it to the favorites tray.
3. Release your finger.

Use Folders

You can place up to 16 app icons in a folder. Drop an app icon over another on the Home screen, and the two icons will be placed in a new folder.

To create a folder:

1. Touch and hold an app icon and drag it over another on the Home screen.
2. Release your finger. Both icons are in a newly created folder.
3. Tap the folder > **Unnamed Folder**. The keyboard opens and you can name the folder. To rename it, tap the name.

To add app icons to a folder:

- ▶ Touch and hold an app icon, drag it over a folder and release your finger.

– or –

1. Tap a folder on the Home screen.
2. Tap  and select the icons you want to add to the folder.
3. Tap **OK**.

Change the Wallpaper

1. Touch and hold any empty area on the Home screen and then tap **WALLPAPERS**.

– or –

From the Home screen, tap **Apps**  > **Settings** > **Display** > **Wallpaper**.

2. Tap **My photos** to use your own image or browse through the preset choices.
3. Select an image.
4. Tap **Set wallpaper**.
5. Select **Home screen**, **Lock screen** or **Home screen and Lock screen**.



Weather

Your Weather widget can display a large quantity of weather information.



Retrieve the Current Location Information

1. Tap **Tap to start** on the widget.
2. Read the message and tap **OK** to enable data connection.
3. Your phone will display the weather forecast for your current location.

Add a Location

1. Tap the weather image on the widget and then tap  > .
2. Enter a location in the Search location field and tap . The matching location(s) will be listed.
3. Tap the location you want to add to the location list.
4. Tap the added location to access the details screen.

Delete a Location

1. Tap the weather image on the widget and then tap  > .
2. Select the check box next to the location you want to delete.
 - Tap **SELECT ALL** to select all the locations.
3. Tap **DONE**.

Configure the Settings

1. Tap the weather image on the widget and then tap  > **Settings**.
2. The following options are available:
 - **Temperature scale:** Select **Fahrenheit** or **Celsius**.
 - **Refresh time:** Select the frequency of auto update.

- **When launching:** Update the weather information when the application is opened.
- **When the current location changes:** Update the weather information when your current location changes. Data usage may increase when this is on.

Quick Shortcuts

By touching and holding an application icon, Quick shortcuts will be displayed on the Home screen.



1. Touch and hold an application icon.
2. When the Quick shortcut options appear, touch and hold the option you want to create a Quick shortcut, and put it where you want it to show.

- or -

Tap a Quick shortcut option to go directly the shortcut menu you want.

Dura Grid

The Dura Grid widget offers popular settings and apps uniquely designed with high contrast, large icons for easy access with gloved hands or while on the move. The Dura Grid widget can also be customized with most frequently used apps and settings and is available in a six or nine-position layout.

Access the nine-position Dura Grid widget

1. From the main Home screen, swipe to the right.
2. Tap on individual icons to turn them on or to adjust settings.

Change an Icon on the Dura Grid widget

1. Tap  **EDIT** on Dura Grid.  appears in the right hand corner of each of the icons.

2. Tap the setting or feature to be changed. The icon disappears.
3. Tap **Add** and tap on an icon from the **CONTROLLER** or **APPS** tabs.
4. Tap  **DONE**.





Add a six or nine-position Dura Grid widget to the Home Screen

1. Touch and hold any empty area on the Home screen.
2. Tap **WIDGETS** and slide the Widgets screen to find the six or nine-position Dura Grid widget.
3. Touch and hold the Dura Grid widget and move your finger to one of the Home screen thumbnails displayed at the top of the screen.
4. When you find the position you prefer, release your finger.



Launcher Screens

You can access all your apps on your phone from the launcher screens. You can also customize the view of your launcher screens.

Access the Launcher Screens

1. From the Home screen, tap **Apps** .
2. Following options are available:
 - Tap  > **All (Customize)** to customize the order of apps. See [Rearrange Your Apps on the Launcher Screens](#) to follow.
 - Tap  > **All (Alphabetical)** to reset the order of apps in alphabetical order.
 - Tap  > **Frequently used** to display the apps you have used most frequently.
 - Tap  > **Installed** to display the apps installed on your phone.

Rearrange Your Apps on the Launcher Screens

1. From the Home screen, tap **Apps** .
2. Tap  > **All (Customize)** >  > **Edit**.
3. Touch and hold an app, drag it to a new position and release it.
4. Tap **OK**.

Status Bar

The status bar at the top of the screen provides phone and service status information on the right side and notification alerts on the left.

Notifications Panel

You can open the Notifications panel to view the list of notifications you received, Wi-Fi connection status, and more.

To open the Notifications panel:

- ▶ Slide the status bar down to the bottom of the touchscreen.

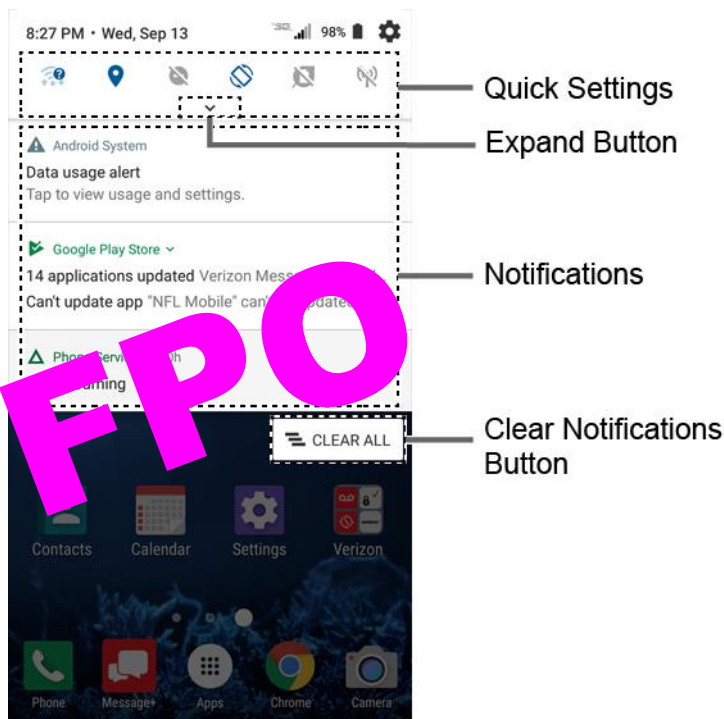

- When you are finished with a notification, swipe it away to the left or right.
- To clear all notifications, tap  **CLEAR ALL** at the very bottom of the notifications list.
- To select a notification method, touch and hold a notification. Select from the options displayed.

Tip: You can control what notifications show on your screen when your phone is locked.

- To open the main Settings app, tap the settings icon , or touch and hold a notification, and then tap **MORE SETTINGS**. For details, see [Settings](#).

- When you have multiple emails (like Gmail), you can see each email individually on Notifications. Tapping the email takes you to the message details screen directly.

To close the Notifications panel:

- ▶ Swipe up from the bottom of the screen.

– or –

Tap **Back** ◀.

Quick reply to the message

When you receive a new message, you can reply to the message from the Notifications panel without opening the message.

- ▶ Tap **Reply** shown below the message notification, write a message and send it.

To close the Notifications panel:

- ▶ Swipe up from the bottom of the screen.

– or –



Tap **Back** ◀.

Quick Settings

The quick settings screen enables you to quickly access useful menu items. Tap ▼ to expand the Quick Settings panel.

Note: When you expand the Quick Settings panel, you will see 6 entries. To show more entries, tap ▼.

1. Slide the status bar down to the bottom of the touchscreen.
2. Tap on a quick setting panel icon to enable or disable the feature:
 - **Wi-Fi** to enable or disable the Wi-Fi function.
 - **Location** to enable or disable the location feature.
 - **Do not disturb** to change the sound and notification settings. You can switch between **Vibrate**, **Total silence**, **Alarms only**, or **Priority only**.
 - **Rotation** to enable or disable the auto-rotate screen feature.
 - **Eco Mode** to enable or disable the Eco Mode feature.
 - **Hotspot** to turn Hotspot feature on or off.

- **Airplane** to enable or disable the Airplane Mode.
- **Bluetooth** to enable or disable the Bluetooth function.
- **Flashlight** to turn the Flashlight on or off.
- To change the positions of items, tap  and then tap  **EDIT**. Touch and hold the item you want to move, and then drag it to a different location and release your finger. You have six more items here to drag it up to add tiles:
 - **Invert colors** to turn the Color inversion on or off.
 - **Data saver** to enable or disable the Data saver feature.
 - **Night light** to turn the Night Light on or off.
 - **Nearby** to enable or disable the Nearby feature.

Note: Use of Nearby service requires a subscription. Follow the onscreen instructions to subscribe this service.
 - **PC File Transfer** to enable or disable the PC File Transfer feature.
 - **NFC** to enable or disable the NFC feature.

Note: To open the settings for a specific Quick settings menu, touch and hold it.
- To adjust the screen brightness, drag the knob on the brightness slider left or right, or tap **AUTO** to adjust automatically.

Enter Text

You can type on your phone using one of the available touchscreen keyboards or using your voice.

Touchscreen Keyboards

The keyboard appears automatically onscreen when you tap a text entry field, and they can be used in either portrait or landscape mode.

Gboard

Gboard offers a traditional QWERTY keyboard setup for entering text by tapping keys (like on a computer), along with enhancements and options that allow you to enter text faster and more accurately, such as continuous key input, personalized usage dictionaries, and more.

Gboard Overview

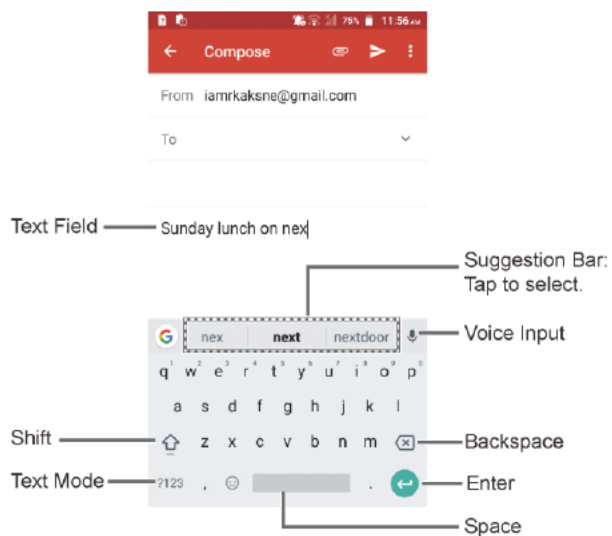

Note: Key appearance may vary depending on the selected application or text field.





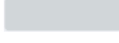



Some of the keys on the Gboard are given below:

Key	Description
	Shift: Tap to toggle between lower case and upper case.
	Caps lock: Double-tap the lower case or upper case shift key.
	Text mode: Tap to toggle between the Alphabet keyboard and Number & Symbol keyboard.
	Voice input mode: Tap to enter text using your voice.
	Backspace: Tap to delete a character. Touch and hold to delete multiple characters.
	Enter: Tap to confirm your entry or move to a new line.
	Next: Tap to go to the next text entry field.
	Alternate: Tap to toggle between the default Number & Symbol keyboard and additional Number & Symbol keyboard.
	Go: Tap to go to a Web address.

Key	Description
	Space: Tap to insert a space. Touch and hold to select the input method.





Text Mode

ABC mode is primarily used for entering letters while Number & Symbol mode for numbers and symbols.

- ▶ Tap  to select ABC mode. Tap  to select Number & Symbol mode.
 - In ABC mode, tap  to alter the capitalization:
 -  (Unshifted) to enter all letters in lowercase.
 -  (One-character-shifted) to capitalize only the first letter of a word.
 - You can select the caps lock by double-tapping  or  to make all letters in uppercase.
 -  (Caps lock) to enter all letters in uppercase.
 - In Number & Symbol mode, tap  to display more symbols.
 - Some keys have alternate characters. In either mode, if a key displays an extra character at the upper right corner, touch and hold the key to enter the character. Or, touch and long hold a key to call up a list of all the characters available on that key, and slide your finger to the character you want to enter on the list.

Add a Word to the User Dictionary

You can use the user dictionary option to add new words to the dictionary.

1. From the Home screen, tap **Apps**  > **Settings** > System > **Languages & input** > **Personal dictionary**.
2. Select a language.
3. Tap .
4. Type the word you want to add.
5. Type the shortcut to bring up the typed word if you want, and tap .
6. Tap **Back** . A list of words you have added to the dictionary is displayed.
 - Tap a word to edit it.

- Tap a word >  to delete it.

For more information about Gboard, see [Gboard Settings](#).

Glide Typing

Glide typing lets you enter words by drawing a path from letter to letter in one continuous motion.

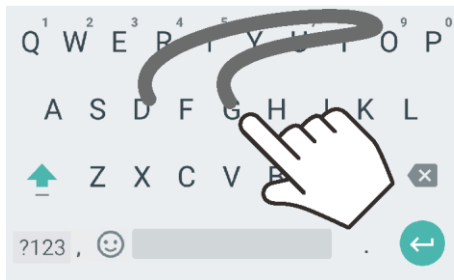

Example: dog
Place your finger on the key with the first letter of the word and glide to the following letters. Lift your finger after the last letter.

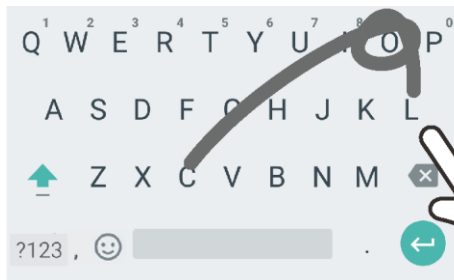

Example: cool
For double letters, circle the letter.

To enable Glide typing input feature:

1. From the Home screen, tap **Apps**  > **Settings** > **System** > **Languages & input**.
2. Tap **Virtual keyboard** > **Gboard** > **Glide typing**.
3. Tap **Enable glide typing** to on.

Google Voice Typing

Google voice typing uses Google voice recognition to convert speech to text.

If Gboard does not display the microphone icon , the voice input feature is not enabled.



To enable the voice input feature:

1. From the Home screen, tap **Apps**  > **Settings** > **System** > **Languages & input**.
2. Tap **Virtual keyboard** > **Gboard** > **Preferences**.
3. Tap **Voice input key** to on.

To enter text by speaking:

1. Tap the microphone icon  on the keyboard.

Tip: The keyboard appears automatically onscreen when you tap a text entry field.

Note: When using the Message+ application, there are two microphone icons:  and . You can tap the second microphone icon  to use Google Voice Typing.

2. If you see **Speak now**, say the text you wish to enter into the microphone.

For more information about the settings of Google voice typing, see [Gboard](#).

Copy and Paste Text

In applications that require text entry, such as Message+, use the copy and paste functions to copy and paste text from one application to another.

To copy and paste the text:

1. Open the application or received message that you want to copy text from.
2. Touch and hold the text body. Selection tabs appear, and the currently selected words or characters are highlighted. Drag the tabs to expand or reduce the range of the selected text.

2012. The conference's press release also hinted at Missouri's imminent departure, as it was not listed among the "expected" ten

Tabs



2012. The conference's press release also hinted at Missouri's imminent departure, as it was not listed among the "expected" ten

Tip: Tap **SELECT ALL** to select all the text.

3. Tap **COPY**.
4. Open the application into which you want to paste the text.
5. Touch and hold the text box where you want to paste the text to, and tap **PASTE**.
 - If you want to add the selected text to the current text, place a cursor to the position where you want to insert the selected words or characters. Touch and hold the text box, and tap **PASTE**, and select the text you want to paste from the **Paste list**.

Phone Calls

With the _____ network and your phone's calling features, you can enjoy clear phone calls across the country.

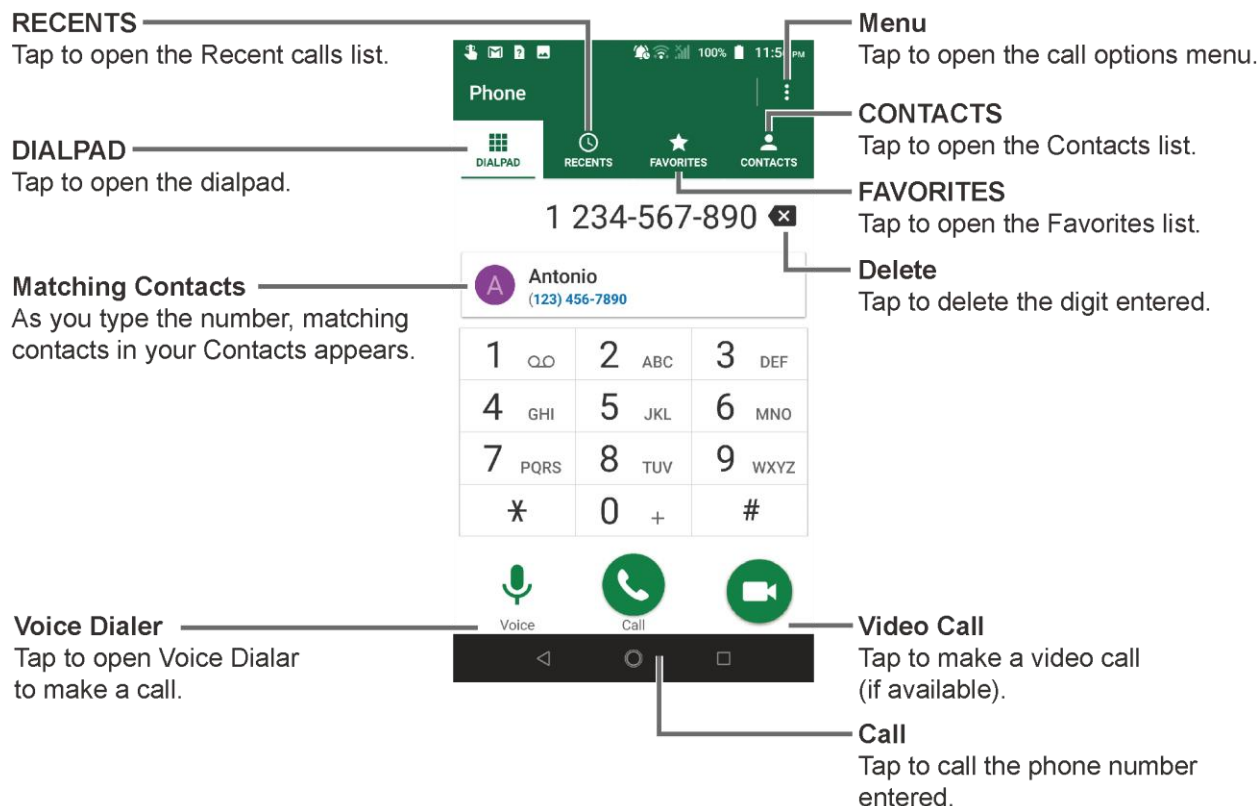

Make Phone Calls

There are several convenient ways to place calls from your phone.



Call Using the Phone Dialpad

The most "traditional" way to place a call is by using the phone dialpad.

1. From the Home screen, tap **Phone** > **DIALPAD** to display the dialpad.
2. Tap the number keys on the dialpad to enter the phone number.
3. Tap  to call the number.
4. To end the call, tap .
 - For additional options, tap  and select an option.



Call from Recents

The Recent calls list lets you quickly place calls to recent incoming, outgoing, or missed numbers.

1. From the Home screen, tap **Phone** > **RECENTS** to display the recent calls list.
2. Tap the phone icon  next to the number or contact to place a call.
 - For additional options, tap the name or number.

Call from Contacts

You can place phone calls directly from entries in your contacts list.

1. From the Home screen, tap **Phone**.
2. Tap **CONTACTS** to display your contacts list.
 - Tap  to search your contacts.
3. Tap the contact you want to call.
4. Tap .
 - For additional information on Contacts, see Contacts.

Call Using a Speed Dial Number

Speed dialing lets you numbers that you call frequently more easily. See Set Up Speed Dialing for information on assigning speed dial numbers.

1. From the Home screen, tap **Phone** > **DIALPAD**.
2. For speed dial numbers 2-9, touch and hold the number on the dialpad.

– or –

For speed dial numbers 10-999999, tap the first digit and then touch and hold the last digit on the dialpad.

Call Emergency Numbers

You can place calls to 911 even if the phone screen is locked or your account is restricted.

To call the 911 emergency number:

1. From the Home screen, tap **Phone** > **DIALPAD**.

2. Enter **911** and tap .

To call the 911 emergency number when the screen is locked:

1. Tap **EMERGENCY** on the screen.
2. Enter **911** and tap .

Enhanced 911 (E911) Information

This phone features an embedded Global Positioning System (GPS) chip necessary for utilizing E911 emergency location services where available.



When you place an emergency 911 call, the GPS feature of your phone seeks information to calculate your approximate location. Depending on several variables, including availability and access to satellite signals, it may take up to 30 seconds or more to determine and report your approximate location.

Important: Always report your location to the 911 operator when placing an emergency call. Some designated emergency call takers, known as Public Safety Answering Points (PSAPs), may not be equipped to receive GPS location information from your phone.

Call Numbers with Pauses

You can dial phone numbers with pauses for use with automated systems, such as Voice Mail or credit card billing numbers.

There are two types of pauses available on your phone:

- **Add 2-sec pause:** Automatically sends the next set of numbers after two seconds.
 - **Add wait:** Sends the next set of numbers when you tap **YES** in the pop-up window.
1. From the Home screen, tap **Phone** > **DIALPAD**.
 2. Enter all or part of a number.
 3. Tap  > **Add 2-sec pause** or **Add wait**.
 4. Enter additional numbers.
 5. Tap  to dial the number.

Call Using the Plus (+) Code

When placing international calls, Plus Code Dialing automatically enters the international access code for your location (for example, 011 for international calls made from the U.S.).

1. From the Home screen, tap **Phone** > **DIALPAD**.
2. Touch and hold **0** until you see a "+" on the display screen.
3. Enter the country code and phone number, and then tap . The phone automatically prepends the access code for international dialing, followed by the country code and phone number.

Receive Phone Calls

The following information lets you know how to answer incoming calls, mute the ringtone on incoming calls, reject incoming calls, and more.

When you receive a phone call from a contact, the Incoming call screen appears and displays the caller ID icon, name, and phone number of the calling party. When you receive a phone call from someone who is not saved in Contacts, only the default caller ID icon and phone number appear on the Incoming call screen.

Note: If your phone is turned off, all calls automatically go to Voice Mail.

Answer an Incoming Call

- ▶ On the Incoming call screen, swipe .

Mute the Ringing Sound

To mute the ringtone without rejecting the call:

- ▶ Press the volume button down.

Send an Incoming Call to Voice Mail

- ▶ Swipe  to send the call to your Voice Mail inbox.

Reject a Call and Send a Text Message

You can reject an incoming call and automatically send a text message to the caller.

- ▶ Tap  to ignore the call and send a message to the caller.

Note: You can edit the preset text messages through the Call settings menu. See [Quick Responses](#).

Voice Mail





Your phone comes with the Voice Mail application. Voice Mail allows you to manage your Voice Mail directly from your phone rather than calling to your Voice Mail box. Voice Mail displays a

list of your messages and allows you to choose which message(s) to listen to or delete. Or you can choose the traditional Voice Mail service.

You must subscribe to Voice Mail before using this feature. As a subscription based service, there is a charge for using Voice Mail. See [Set Up Voice Mail](#).

Review Voice Mail



Voice Mail lets you easily access and select which messages you want to review.

1. From the Home screen, tap **Apps**  > **Voice Mail**.
2. From the Voice Mail inbox, tap a message. The following options may be available while reviewing a Voice Mail message:
 - Tap **Play** to start playing.
 - Tap **Stop** to stop playing.
 - The bar  provides a visual timeline for the current message. Drag the bar to rewind or fast-forward the message.
 - Tap **Pause** to pause the playback. Tap **Play** to resume.
 - Tap **Speaker** to turn the speakerphone on or off during playback.
 - Tap **Delete** to delete the current Voice Mail message.
 - Tap **Call Back** to call the number from which the message came.
 - Tap **Save** to move the message to the saved Voice Mail folder. Tap  > **View Saved Voice Mail on the Inbox** screen to view the saved messages.
 - Tap **Add Note** to add a note to the message.
 - Tap **View Note** to display the attached note.
 - Tap  to display the option menu.
 - **Reply** to reply to the message via text or voice message. This feature is a part of the Premium Voice Mail service.
 - **Share** to forward the message. This feature is a part of the Premium Voice Mail service.
 - **Mark as Heard** to mark the message as heard.
 - **Add to Contacts** to store the sender information to Contacts.
 - **Contacts details** to display the sender information saved in Contacts.

You may see more options such as **Play All Unheard Message**, **Sort By**, **View Saved Voice Mail** and **Settings** by tapping  on the inbox screen.

Configure Voice Mail Settings

You can access the settings for notifications and greetings as well as the store location of the messages.

1. From the Home screen, tap **Apps**  > **Voice Mail** >  > **Settings**.
2. Select an option:
 - **Notifications** to display the notification when you receive Voice Mail messages.
 - **Set Voice Mail Greeting** to create a greeting to answer the Voice Mail messages.
 - **Set Caller Dependent Greetings** to create personalized greetings for each caller. This feature is a part of the Premium Voice Mail service.
 - **Saved Voice Mail Location** to view the location where the Voice Mail messages are stored.
 - **Storage for Saved Voice Mail** to select where to store the Voice Mail messages.

Voice Mail (Traditional)

In addition to [Voice Mail](#), you can also access your Voice Mail regularly through the Voice Mail application.

Set Up Voice Mail

You should set up your Voice Mail and personal greeting as soon as your phone is activated. Always use a password to protect against unauthorized access. Your phone automatically transfers all unanswered calls to your Voice Mail, even if your phone is in use or turned off. See [Set Up Voice Mail](#) for setting it up.

Voice Mail Notification

There are several different ways your phone may alert you to a new Voice Mail message.

- By sounding the assigned notification sound.
- By vibrating the phone.
- By displaying  within the Notifications area of the Status bar when new Voice Mail Messages are received.

Retrieve Your Voice Mail Messages

You can review your messages directly from your wireless phone (using either traditional Voice Mail or Voice Mail) or from any other touch-tone phone.

Use Your Phone to Access Your Messages

1. From the Home screen, tap **Phone** > **DIALPAD**.
2. Touch and hold **1** or dial ***86** and then tap . If prompted, enter your Voice Mail password.
3. If you hear a greeting, tap **#** to interrupt, and follow the prompts.

Use Another Phone to Access Messages

1. Dial your wireless phone number.
2. If you hear a greeting, press **#** to interrupt, and follow the prompts.

Phone Call Options

Your phone application provides many useful features and options to help you make the most of your calling experience.

In-call Options

While you're on a call, you will see a number of onscreen options. Tap an option to select it.

- **Add call:** Tap to initiate a 3-way call.
- **End call:** End the current call.
- **Dialpad/Hide:** Toggle the appearance of the onscreen dialpad to enter additional numbers such as an extension or access code.
 - For example: When you call your bank's toll-free number, use your dialpad to enter your account number and PIN.
- **Mute:** Mute or unmute the microphone during an active call.
- **Speaker:** Turn the speaker on or off.

Warning: Because of higher volume levels, do not place the phone near your ear during speakerphone use.
- **Bluetooth:** Route the phone's audio through a connected Bluetooth headset or through the speaker.
- **Camera:** Tap to initiate two-way video calls.
- **One-way Camera:** Tap to initiate a one-way video call.

Caller Name ID

Caller ID identifies a caller before you answer the phone by displaying the number of the incoming call. If you do not want your number displayed when you make a call, follow these steps.

1. From the Home screen, tap **Phone** > **DIALPAD**.
2. Enter ***67**.
3. Enter a phone number.
4. Tap .

Call Waiting

When you're on a call, Call Waiting alerts you to incoming calls by sounding beeps. Your phone screen informs you that another call is coming in and displays the caller's phone number (if available).

To respond to an incoming call while you're on a call:

- ▶ Swipe . This puts the first caller on hold and answers the second call.



To switch back to the first caller:

- ▶ Tap **Swap call**.

Note: For those calls where you don't want to be interrupted, you can temporarily disable Call Waiting by entering ***70** before placing your call.

3-Way Calling

With 3-way calling, you can talk to two people at the same time. When using this feature, the normal airtime rates will be charged for each of the two calls.

1. Enter a number on the dialpad and tap  (or place a call from recent calls or contacts).
2. Once you have established the connection, tap **Add call**, and dial the second number (or place the call from Recents or Contacts). This puts the first caller on hold and dials the second number.
3. When you're connected to the second party, tap **Merge calls**. Your conference call is now in session.
4. To end the 3-way call, tap .

Note: If one of the parties you called hangs up during your call, you and the remaining party stay connected. If you initiated the call and are the first to hang up, all parties are disconnected.

Call Forwarding

Call Forwarding lets you forward all your incoming calls to another phone number – even when your phone is turned off. You can continue to make calls from your phone when you have activated Call Forwarding.

Note: You may be charged a higher rate for calls you have forwarded.

To activate Call Forwarding:

1. From the Home screen, tap **Phone** > **DIALPAD**.
2. Enter ***72**.
3. Enter the area code and phone number to which you want your calls forwarded.
4. Tap . You will see the message if the call forwarding is activated.
5. Confirm the message and tap **Forward Calls** to forward your call or tap **Cancel** to cancel forwarding.



To deactivate Call Forwarding:

1. From the Home screen, tap **Phone** > **DIALPAD**.
2. Enter ***73**.
3. Tap .

Set Up Speed Dialing

You can save up to 999997 phone numbers in your phone's speed dial memory.

To assign a speed dial number to a contact:

1. From the Home screen, tap **Phone** > **DIALPAD** >  > **Speed dial setup** > .
2. Enter a speed dial number (up to 6 digits) you want to add.
3. Tap **Unassigned** to choose a contact.
4. Tap the contact to assign the speed dial number to, and tap **SAVE**.

– or –

1. From the Home screen, tap **Phone** > **DIALPAD**.

2. For the speed dial number 2-9, touch and hold the number on the dialpad you want to assign.



– or –

For the speed dial number 10-999999, tap the number up to the fifth digit and then touch and hold the last number on the dialpad.

3. Tap **OK**, and then tap a contact to assign.

Note: 0, 1 and 911 cannot be a speed dial number. You cannot assign saved speed dial numbers to a contact.



To delete the assigned speed dial(s):

1. From the Home screen, tap **Phone** > **DIALPAD** >  > **Speed dial setup** > .
2. Select the check box next to the contact with the speed dial to delete.
 - Tap **SELECT ALL** to select all the assigned contacts.
3. Tap **OK**.

– or –

1. From the Home screen, tap **Phone** > **DIALPAD** >  > **Speed dial setup**.
2. Tap the contact with the speed dial to delete.
3. Tap **Delete** > **OK**.

To edit the assigned speed dial:

1. From the Home screen, tap **Phone** > **DIALPAD** >  > **Speed dial setup**.
2. Tap the assigned contact with the speed dial to edit.
3. Tap **Edit**.
4. Edit the speed dial number (up to 6 digits) and tap  > **SAVE**.

Recent Calls

The Recents tab of the Phone application lists up to 500 recent incoming, outgoing, and missed calls.

View Recent Calls

- ▶ From the Home screen, tap **Phone** > **RECENTS**.

- You can determine if an entry was an incoming, outgoing, or a missed call from the icons shown below.

 = Incoming Call







 = Incoming Video Call

 = Outgoing Call

 = Outgoing Video Call

 = Missed Call

Recent Calls Options

1. From the Home screen, tap **Phone > RECENTS**.
2. Tap an entry to view the contact.
 - Tap  to call the number.
 - Tap  to send a text message.
 - Tap  to add the number to Contacts.
 - Tap  > **Delete from recent call** to delete the call.
 - Tap  > **Edit number before call** to edit the number before calling.
 - Tap  > **Add to reject call list** to add the number to the reject call list.

Filter Recent Calls

1. From the Home screen, tap **Phone > RECENTS**.
2. Tap  > **Filter by**.
3. Select **All calls, Missed calls, Outgoing calls, Incoming calls, Voice calls, or Video calls**.

Delete Recent Calls

Use the menu option to delete your recent calls.

1. From the Home screen, tap **Phone > RECENTS**.
2. Tap  > **Delete recent calls**.
3. Tap the check box next to the calls you want to delete or tap **SELECT ALL**.







4. Tap **OK** > **OK**.

Call Settings



Your phone's Call settings menu lets you configure your settings for the phone application.

Call Rejection

You can set your phone to reject incoming calls as follows:

- ▶ From the Home screen, tap **Phone** >  > **Call settings** > **Call rejection**.
 - Tap **Unknown number** to turn on to reject calls from unknown number.
 - Tap  and enter a phone number you want to reject, and then tap **ADD**.
 - Tap  >  > a contact on Choose a contact screen > **ADD**.
 - Tap  >  > a recent call on Choose log(s) screen > **ADD**.



To delete the rejected number(s):

1. From the Home screen, tap **Phone** >  > **Call settings** > **Call rejection** > .
2. Select the check box next to the rejected number you want to delete.
 - Tap **SELECT ALL** to select all the rejected numbers.
3. Tap **DELETE** > **OK**.

– or –





1. From the Home screen, tap **Phone** >  > **Call settings** > **Call rejection**.
2. Tap the rejected number you want to delete.
3. Tap **DELETE** > **OK**.

To edit the rejected number:

1. From the Home screen, tap **Phone** >  > **Call settings** > **Call rejection**.
2. Tap the rejected number you want to edit.
3. Edit the rejected number and tap  > **ADD**.

Quick Responses

You can add, delete, or modify the preset text messages to send when you select to reject an incoming call and send a text message. Your phone can register up to seven messages.

1. From the Home screen, tap **Phone** >  > **Call settings** > **Quick responses**.
2. Following options are available:
 - To edit a message, tap a message, edit it, and tap **OK**.
 - To add a new message, tap , enter text, and tap **OK**.
 - To delete a message, tap  > **Delete**, select a message, and then tap **DONE**.
 - To restore the default messages, tap  > **Reset to default**.

Auto Answer

Select when to answer incoming calls automatically with the headset.

1. From the Home screen, tap **Phone** >  > **Call settings** > **Auto answer**.
2. Select **Hands free** or **Speakerphone**.
3. Select the delay time to automatically answer the phone.

You can set the delay time to: 2 seconds, 5 seconds, 10 seconds or Off.

Power Key Ends Call

Set your phone to end call by pressing the Power button.

1. From the Home screen, tap **Phone** >  > **Call settings**.
2. Tap **Power key ends call** to turn on.

Noise Reduction

Your phone can suppress the background noise to improve audio quality for the other party during voice calls.

1. From the Home screen, tap **Phone** >  > **Call settings**.
2. Tap **Noise reduction** to turn on.

Additional Settings

Caller ID

1. From the Home screen, tap **Phone** >  > **Call settings** > **Additional settings**.
2. Tap **Caller ID**.
3. Select from **Network default**, **Hide number**, or **Show number**.

Note: **Additional settings** is only available on GSM networks.

Video Calling

With this feature on, you can make or receive video calls with your contacts.

1. From the Home screen, tap **Phone** >  > **Call settings**.
2. Tap **Video calling** to turn on.

Phone Ringtone

Assign a ringtone to your incoming calls.

1. From the Home screen, tap **Phone** >  > **Call settings** > **Phone ringtone**.
2. Select the file and tap **OK** to assign the ringtone.

Vibrate When Ringing

Set your phone to ring and vibrate simultaneously.

1. From the Home screen, tap **Phone** >  > **Call settings**.
2. Tap **Vibrate when ringing** to turn on.

Dial Pad Touch Tones

Play tones when using the dialpad.

1. From the Home screen, tap **Phone** >  > **Call settings**.
2. Tap **Dial pad touch tones** to turn on.

Voicemail



You can configure the Voicemail settings.

1. From the Home screen, tap **Phone** >  > **Call settings** > **Voicemail**.
2. Configure the following settings:
 - **Service** to review the Voicemail service carrier.
 - **Voicemail number** to configure the Voice Mail number if necessary.
 - **Notifications** to configure the Notification category of Voicemails by tapping **Voicemails** on the Settings screen.

Assisted Dialing

Assisted dialing allows easy dialing of international calls while roaming in another countries.

Your default reference country is set to the United States.

1. From the Home screen, tap **Phone** >  > **Call settings** > **Assisted dialing**.
2. Tap **Assisted dialing** to turn on.
3. Tap **Reference country**.
4. Tap  to the right of the country name and edit the settings if needed.

TTY Mode

A TTY (teletypewriter, also known as a TDD or Text Telephone) is a telecommunications device that allows people who are deaf, hard of hearing, or who have speech or language disabilities, to communicate by telephone.

Your phone is compatible with select TTY devices. Please check with the manufacturer of your TTY device to ensure that it supports digital wireless transmission. Your phone and TTY device will connect using a special cable that plugs into your phone's headset jack. If this cable was not provided with your TTY device, contact your TTY device manufacturer to purchase the connector cable.

To turn TTY Mode on or off:

1. From the Home screen, tap **Phone** >  > **Call settings** > **TTY mode**.
2. Tap **TTY Full**, **TTY HCO**, or **TTY VCO** to turn TTY mode on.

– or –

Tap **TTY Off** to turn TTY mode off.

Note: When enabled, TTY mode may impair the audio quality of non-TTY devices connected to the headset jack.

Warning: **911 Emergency Calling**

It is recommended that TTY users make emergency calls by other means, including Telecommunications Relay Services (TRS), analog cellular, and landline communications. Wireless TTY calls to 911 may be corrupted when received by public safety answering points (PSAPs), rendering some communications unintelligible. The problem encountered appears related to TTY equipment or software used by PSAPs. This matter has been brought to the attention of the FCC, and the wireless industry and the PSAP community are currently working to resolve this.

Hearing Aids

Set to turn on hearing aid compatibility.

1. From the Home screen, tap **Phone** >  > **Call settings**.

2. Tap **Hearing aids** to turn on.

Call Timer

To view the call timer and call duration:

1. From the Home screen, tap **Phone** >  > **Call settings**.
2. Tap **Call timer**.

Push To Talk Plus (PTT+)

With PTT+, you can quickly and reliably connect to an individual or group instantly with a push of a button. See [PTT key](#).



Note: This service requires a subscription.

Note: By installing PTT application, the Programmable button will be a dedicated PTT button.

Set Up PTT+

1. Download and install the PTT+ app from Play Store. See [Google Play Store App](#) for details.
2. Tap the installed app to open it.
3. Read Terms & Conditions and tap .
4. Tap **Yes** to confirm the activation.
5. Tap **View tutorial** to display the tutorials to learn how to start using the PTT+ app or **Skip tutorial**.

Create a PTT+ Contact

1. From the Home screen, tap **Apps**  > **Push To Talk+** > .
2. Tap  at the bottom of the screen.
3. Tap **New Contact** and manually enter the contact's information.

- or -

Tap **Import Contact**, select the contact source, and select the contact.

4. Tap .

Make a PTT+ Call

1. From the Home screen, tap **Apps**  > **Push To Talk+** > .

2. Tap the check box next to the contact you want to call on the contact list and tap .
3. Touch and hold the on-screen PTT+ button and speak after the chirp tone. A PTT+ call is started when the button turns blue. While holding the button, your voice can be heard by the other person on the call.
4. Release the PTT+ button to allow other people on the call to take the floor and speak.
5. Tap **End Call** button to end the conversation.

- or -

The call will end automatically if no one takes the floor for a period of time.







For more information on PTT+, visit business.com/content/b2b/en/solutions/mobility/push-to-talk-plus.html.

Contacts

The Contacts application lets you store and manage contacts from a variety of sources, including contacts you enter and save directly in your phone as well as contacts synchronized with your Google Account, your PC, and compatible email programs.



Contacts List

Scroll through the list to view all your contacts. To see a specific entry, tap it.

- ▶ From the Home screen, tap **Apps**  > **Contacts**.
 - **CONTACTS:** Tap to display the individual contacts.
 -  **Add new contact:** Tap to add a new individual contact. See Add a Contact.
 - **GROUPS:** Tap to display the group contacts.
 -  **Add new group:** Tap to add a new group contact. See Add a Group Contact.
 - **FAVORITES:** Tap to display your favorite contacts.
 -  **Add new favorite:** Tap to add a new favorite contact. See Add a Contact to Favorites.
 -  : Tap to search a contact.
 -  : Tap to display the contacts list options. See Contacts List Options to follow.

Tip: You will see letters in alphabetical order when you drag the slider on the right of the screen. Release your finger to display the entries starting with a specific letter when you see it.

Contacts List Options



- ▶ From the Home screen, tap **Apps**  > **Contacts** > .
 - **Cloud:** Displays the contacts in the Cloud app.
 - **Delete:** Allows you to select and delete the contacts.
 - **Import/export:** Imports/exports contacts from/to Phone, the SIM card or microSD card.
 - **Share:** Shares contacts using Cloud, Android Beam, Bluetooth, Drive, etc.
 - **Settings:** Opens the Settings screen related to Contacts. See the following options.

The menus in the above settings are:

- **Contacts to display:** Selects which contacts to be displayed on Contacts.
- **Position of index tab:** Chooses the position to place the index tab.
- **Sort by:** Selects how your contacts are sorted.
- **Name format:** Selects how your contact's names are displayed.
- **Accounts:** Adds contacts as emergency contacts. See [ICE \(In Case of Emergency\)](#) and [Accounts](#).
- **Call rejection:** Saves the phone number(s) in Contacts as Rejected numbers.

Add a Contact

Enter details such as name, phone numbers, email addresses, mailing addresses, and more.

1. From the Home screen, tap **Apps**  > **Contacts** > **CONTACTS** > .
2. You may be prompted to select an account to save your new contact to. Select one of the following options:
 - **Phone:** Stores your contact to your phone.
 - **SIM:** Stores your contact to the SIM card.
 - Select an account from the displayed list.
3. Use the keyboard to enter as much information as you want.
 - Tap  to assign a picture to the contact. See [Assign a Stored Picture to a Contact](#) or [Assign a New Picture to a Contact](#).
 - Tap the location/account above name and select an option to change where to save the contact.
 - **Name**
 - **Phone**
 - **Email**
 - **More Fields:** Tap to include additional information such as **Company**, **IM**, **Website**, **DATE**, etc.

Note: To select a type (label) for a phone number, email address, or postal address (such as **Mobile**, **Home**, **Work**, etc.), tap ▼ to the right of the field and select the appropriate type.

4. When you have finished adding information, tap **SAVE**.

Save a Phone Number

You can save a phone number to Contacts directly from the phone dialpad.

1. From the Home screen, tap **Apps**  > **Phone** > **DIALPAD**.
2. Enter a phone number and tap **Add to contacts**.
3. To add the number to an existing contact, tap the contact, select a number type for the new number, and then tap **SAVE**.

– or –



To add the number as a new contact, tap **Create contact**, enter the name and any additional information, and then tap **SAVE**. See [Add a Contact](#).

Edit a Contact

Once you've added a contact, you can add or edit any of the information in the entry, assign a caller ID picture, customize with a unique ringtone, and more.

Add or Edit Information for a Contact



Follow the instructions to add or edit information for an existing contact.

1. From the Home screen, tap **Apps**  > **Contacts** > **CONTACTS**.
2. Tap a contact to display it, and tap .
3. Tap any field you want to change or add. See [Add a Contact](#).
4. Add or edit the information, and then tap **SAVE**.

Note: To select a type (label) for a phone number, email address, or postal address (such as **Mobile**, **Home**, **Work**, etc.), tap ▼ to the right of the field and select the appropriate type.

Assign a Stored Picture to a Contact





Follow the instructions to assign a picture stored in your phone's internal memory or SD card to a contact.

1. From the Home screen, tap **Apps**  > **Contacts** > **CONTACTS**.
2. Tap a contact to display it, and tap .
3. Tap  to the right of the contact icon.

4. Tap **Choose photo**.
5. Tap a picture to select it, and tap **Done**.
 - You may be prompted to size the picture for use with contacts. Drag the square to frame the portion of the picture to use. Tap and drag the side of the square to resize the square and complete the action.
6. Tap **SAVE** to save the contact.



Assign a New Picture to a Contact

Follow the instructions to take a new picture and assign it directly to an existing contact.

1. From the Home screen, tap **Apps**  > **Contacts** > **CONTACTS**.
2. Tap a contact to display it, and tap .
3. Tap  to the right of the contact icon.
4. Tap **Take photo**.
5. Tap  to take a picture, and tap **Done**.
 - You may be prompted to size the picture for use with contacts. Drag the square to frame the portion of the picture to use. Tap and drag the side of the square to resize the square and complete the action.
6. Tap **SAVE** to save the contact.



Refresh

You can manually refresh the displayed contact information.

1. From the Home screen, tap **Apps**  > **Contacts** > **CONTACTS**.
2. Tap the contact you want to refresh, and tap  > **Refresh**.



Share

You can quickly share contacts using Bluetooth, Email, Gmail, or text messaging.

1. From the Home screen, tap **Apps**  > **Contacts** > **CONTACTS**.
2. Tap a contact to display it, and tap  > **Share**.
3. In the **Share contact via** menu, select a method and follow the onscreen instructions.

Delete

You can delete contacts from the contacts details screen.



1. From the Home screen, tap **Apps**  > **Contacts** > **CONTACTS**.
2. Tap  > **Delete**, select the check box next to the contact(s) you want to delete, or tap **SELECT ALL**.
3. Tap **DONE** > **OK**.

- or -

Tap a contact to display it, and tap  > **Delete** > **OK**.



Join

You can merge the contact you wish to join with the primary contact.

1. From the Home screen, tap **Apps**  > **Contacts** > **CONTACTS**.
2. Select the contact you want to appear as the primary contact.
3. Tap  > **Join**.
4. Tap the contact you want to join with the primary contact.

Add shortcut to Home screen

You can make a shortcut of a contact to the Home screen.

1. From the Home screen, tap **Apps**  > **Contacts** > **CONTACTS**.
2. Select the contact you want to make a shortcut for.
3. Tap  > **Add shortcut to Home screen**.
4. Touch and hold a thumbnail, and drag and drop it to the Home screen.



- or -

Tap > **ADD AUTOMATICALLY**.



Set ringtone

Know who's calling without looking at your phone by assigning a specific ringtone and a vibration pattern to a contact.

For Ringtone:



1. From the Home screen, tap **Apps**  > **Contacts** > **CONTACTS**.
2. Tap a contact to display it, and tap  > **Set ringtone** > **Ringtone**.
3. Tap a ringtone in the available list, and then tap **OK**.

For Vibration pattern:

1. From the Home screen, tap **Apps**  > **Contacts** > **CONTACTS**.
2. Tap a contact to display it, and tap  > **Set ringtone** > **Vibration pattern**.
3. Tap a vibration pattern in the available list, and then tap **OK**.



All calls to voicemail

With this feature on, calls from the contact saved in Contacts automatically go to Voice Mail box.

1. From the Home screen, tap **Apps**  > **Contacts** > **CONTACTS**.
2. Tap a contact to display it, and tap  > **All calls to voicemail**.



Change account

You can change the account you stored the contact in.

1. From the Home screen, tap **Apps**  > **Contacts** > **CONTACTS**.
2. Tap a contact to display it, and tap  > **Change account**.
3. Tap the account you want to change to and tap **OK**.

Add a Contact to Favorites

The Favorites tab of the Phone menu is a listing that can help you quickly access your most used or preferred contacts entries.

1. From the Home screen, tap **Apps**  > **Contacts** > **CONTACTS**.
2. Tap a contact.
3. Tap . The icon changes to  when the contact is added to Favorites.

– or –



1. From the Home screen, tap **Apps**  > **Contacts** > **FAVORITES**.

2. Tap  and select the check box next to the contact(s) that you want to add to your Favorites list.
3. Tap **DONE**.

Add a Group Contact

Create a group contact with your individual contact entries in Contacts.



Note: In order to create a group contact, you may first sync your phone with a Google or corporate account. See [Synchronize Contacts](#) for instructions on how to sync your phone to an account.

1. From the Home screen, tap **Apps**  > **Contacts** > **GROUPS** > .
2. Select the account in which you want to create a group contact.
3. Enter the group's name.
4. Tap **Add/remove contacts** and tap the entries you want to add.
5. Tap **DONE** > **SAVE**.

Edit a Group Contact



Manage the group contacts that you have created.

Add or Remove a Group Contact Entry, or Rename a Group

1. From the Home screen, tap **Apps**  > **Contacts** > **GROUPS**.
2. Tap a group contact and tap .
3. The following options are available:
 - Tap the group's name to rename it.
 - Tap **Add/remove contacts** to add or remove entries.
4. Tap **DONE** > **SAVE**.

Assign a Ringtone to a Group Contact



You can assign a ringtone to a group contact.

1. From the Home screen, tap **Apps**  > **Contacts** > **GROUPS**.
2. Tap a group contact to display it and then tap  > **Ringtone**.
3. Select a ringtone to use.



4. Tap **OK** > **SAVE**.

Assign a Vibration Pattern to a Group Contact



You can assign a vibration pattern to a group contact.

1. From the Home screen, tap **Apps**  > **Contacts** > **GROUPS**.
2. Tap a group contact to display it and then tap  > **Vibration pattern**.
3. Select a vibration pattern to use.
4. Tap **OK** > **SAVE**.

Delete a Group Contact

1. From the Home screen, tap **Apps**  > **Contacts** > **GROUPS**.
2. Tap a group you want to delete, and tap  > **Delete**.
3. Tap **OK**.

- or -



1. From the Home screen, tap **Apps**  > **Contacts** > **GROUPS**.
2. Tap  > **Delete**.
3. Tap a group you want to delete.
4. Tap **DONE** > **OK**.

ICE (In Case of Emergency)

Registering ICE information might help rescue workers, such as paramedics, police and hospital personnel identify your primary contact. You can register up to three contacts.



Note: You can quickly access to your Emergency information by tapping **ICE – In Case of Emergency** shown at the top of the contact list.

To register an ICE contact:

1. From the Home screen, tap **Apps**  > **Contacts** > **CONTACTS**.
2. Tap  > **Settings** > **Accounts** > **Emergency information**.
3. Tap a **CONTACTS** tab > **Add contacts**. Choose and tap a contact you want to register as the emergency contact.

Tip: You can edit your Emergency info if you tap a MY INFO tab and tap the item you want to edit.



To remove an ICE contact:

1. From the Home screen, tap **Apps**  > **Contacts** > **CONTACTS**.
2. Tap  > Settings > Accounts > Emergency information.
3. Tap a **CONTACTS** tab and tap  of the contact you want to remove.
4. Tap **OK**.

Synchronize Contacts

Syncing data from your managed accounts lets you add and manage new or existing contacts from your online or remote accounts to your phone. Prior to syncing, you must have an active Google or corporate account with associated contacts, and be signed into your account with the phone.

With syncing, any contacts (with phone numbers, email addresses, pictures, etc.) are updated and synced with your phone.

1. From the Home screen, tap **Apps**  > **Contacts**.
2. Tap  > **Settings** > **Accounts**.
3. Tap **Automatically sync data** to turn on if you set Contacts to sync on under Account sync settings.

- or -

Tap **Accounts for My Info** > **Account sync** and turn the **ON/OFF** icon on next to Contacts if you set Contacts to sync off under Account sync settings.

Your Contacts then reflects any updated contact information.

- This update process works both ways. For example, any changes on the phone are updated to your account contacts list after sync.

Accounts and Messaging

With _____ service and your phone's messaging capabilities, you have the opportunity to share information through many different channels and accounts, including Gmail (Google), personal and corporate email, text and multimedia messaging, and social networking accounts.

Gmail / Google

You will need a Google Account to access several phone features such as Gmail, and the Google Play Store applications. Before you are able to access Google applications, you must enter your account information. These applications sync between your phone and your online Google Account.

Create a Google Account

If you do not already have a Google Account, you can create one online or using your phone.

Note: Although you need a Gmail account to use certain features on your phone, such as Google Play Store, you do not need to use Gmail as the default account for your phone.

Create a Google Account Online

1. From a computer, launch a Web browser and navigate to google.com.
2. On the main page, click **Sign in > Create account**.
3. Follow the onscreen prompts to create your free account.

Create a Google Account Using Your Phone

1. From the Home screen, tap **Apps**  > **Settings > Accounts > Add account > Google**.
2. Tap **Create account**.
3. Follow the onscreen prompts to create your free account.

Note: When setting up a new Google Account, either on your phone or online, you are recommended to add a secondary phone number or email address. Enter a second phone number or email address from which you currently send and receive message or email. This number or address is used to authenticate your account should you ever encounter problems or forget your password. It is strongly encouraged for Android users so you can regain access to Google Mobile™ services and purchases on your phone.

Sign In to Your Google Account



If you have a Google Account but have not yet signed in with your phone, follow these instructions.

1. From the Home screen, tap **Apps**  > **Settings** > **Accounts** > **Add account** > **Google**.
2. Enter your email address, and tap **NEXT**.
3. Enter the password, and tap **NEXT**.
4. Read the message, and tap **I AGREE**.
5. Select the backup options, if prompted, and tap **NEXT**.
6. Select if you save your credit card information now to enable purchases at Google Play Store.
7. Select the items you would like to sync with your phone, if necessary. Your account is displayed in **Google** under Accounts in the Settings menu.

Access Gmail

1. From the Home screen, tap **Gmail**.
2. Do any of the following:
 - View more email messages: If the screen is full, swipe your finger up the screen to view more messages and conversations.
 - Read a new email message: Tap the unread message or the conversation with an unread message (just-arrived items display in bold).
 - Select messages and conversations: Touch and hold the email or conversation.
 - View the inbox of your other Gmail or Email account: If you have more than one Google account or other Email account set up on your phone, tap  at the top left of the screen and then choose an account to view.

Send a Gmail Message





1. From the Home screen, tap **Gmail**.
2. In any folder, tap .
3. Enter the message recipient's email address in the **To** field.
4. If you want to send a carbon copy (CC) or a blind carbon copy (BCC) of the email to other recipients, tap  on the right side of the **To** field.

5. Enter the subject and then compose your message.

Note: If you want to add a file as attachment, tap , select **Attach file** or **Insert from Drive** and then locate and choose the file you want to attach.

6. After composing your message, tap .

Read and Reply to Gmail Messages

1. From the Home screen, tap **Gmail**.
2. Tap a message to display it.
3. To reply to or forward a message:
 - Tap  to reply to the message.
 - Tap  > **Reply all** to reply to all recipients.
 - Tap  > **Forward** to forward the message.
4. After composing your message, tap .

Gmail Account Settings

1. From the Home screen, tap **Gmail**.
2. Tap  at the top left of the screen to display menu.
3. Tap **Settings** > **General settings**.
4. Configure the following settings:

Note: Depending on the email account type, the available options may vary.

 - **Default notification action:** Switch between Archive and Delete.
 - **Manage notifications:** Configure the settings under Notification category.
 - **Conversation view:** Check to turn Conversation view on.
 - **Swipe actions:** Check to archive a conversation when you swipe it.
 - **Sender image:** Check to display an image of the sender in conversation list.
 - **Default reply action:** Choose between **Reply** or **Reply all** to display as default.
 - **Auto-fit messages:** Check to shrink the messages to fit the screen and allow zooming.
 - **Open web links in Gmail:** Check to allow open web links in Gmail.

- **Auto-advance:** Choose which screen to show after you delete a message.
- **Confirm before deleting:** Check to display a confirmation before deleting a message.
- **Confirm before archiving:** Check to display a confirmation before archiving a message
- **Confirm before sending:** Check to display a confirmation before sending a message.

Delete a Gmail Account



1. From the Home screen, tap **Apps**  > **Settings** > **Accounts** > **Google**.
2. Tap the account you want to delete.
3. Tap **REMOVE ACCOUNT** > **REMOVE ACCOUNT**.

Email



Use the Gmail application to send and receive email from your webmail or other accounts.

Set up Email Account

Note: If you have not set up any email account yet, create or set up your favorite email account first. Depending on the account type you want to set up, you will be asked to enter more details.

1. From the Home screen, tap **Apps**  > **Settings** > **Accounts** > **Add account**.
- or -
From the Home screen, tap **Gmail** >  at the top left of the screen to display menus > **Settings** > **Add account**.
2. Tap a desired email account.
3. Enter your email address and password and tap **NEXT**.
4. Enter any other necessary information and follow the onscreen instructions.

Access Email

1. From the Home screen, tap **Gmail**.
2. Tap  > your email account icon or  to tap your email address you want to access.

See [Access Gmail](#) for further instructions.

Note: For such basic email functions, see [Send a Gmail Message, Read and Reply to Gmail Messages, Gmail Account Settings, and Delete a Gmail Account](#).

Message+

Message+ provides an improved text and multimedia (i.e., picture and video) messaging experience. You can send and receive text and multimedia messages seamlessly from your phone, tablet, or the web using your primary phone number.

1. From the Home screen, tap **Message+**.
2. On the Messaging screen, tap . The Compose screen opens.
3. Enter a phone number in the **To** field.
 - As you type, any matching phone numbers from your contacts list are displayed. Tap a match to enter that number.
 - If you're sending the message to several recipients, separate the phone numbers with a semicolon.

Tip: You can type a name saved in your Contacts to call up the phone number, or tap  to access your Contacts.

4. If you add multiple recipients in the **To** field, select how you want them to reply to the message: **Just Me** to reply to you only or **MMS** to replay all.
5. Tap the text entry field next to  and compose your message.

Tip: Tap  to display the menus for adding a postcard, picture, audio recording, etc.

6. When you finish composing the message, tap .

Save and Resume a Draft Message

You can save the message and send it later.

To save a message as draft:

- ▶ While composing a message, tap **Back**  until you go back to the messaging list screen. The text "Message saved as draft." briefly appears and your message is saved as draft.

To resume composing the message:

1. From the Home screen, tap **Message+**.
2. On the messaging list screen, tap the message with "Draft" in red.

3. When you finish editing the message, tap  to send it.

For more information on Message+, visit

com/wcms/consumer/products

messages.html.

Social Networking Accounts

Stay in touch while on the go with all your social networking accounts.

YouTube

YouTube™ is a video sharing website on which users can upload and share videos. The site is used to display a wide variety of user-generated video content, including movie clips, TV clips, and music videos, as well as video content such as video blogging, informational shorts and other original videos.

Open YouTube

- ▶ From the Home screen, tap **Apps**  > **Google** > **YouTube**.

Note: **Terms of Service** may appear. Tap **ACCEPT**, if you agree to the **Terms of Service**.

Watch YouTube Videos

1. On the YouTube screen, tap a video.
2. Tap the screen to show the progress bar at the bottom. Tap the screen while the bar is displayed to pause/play the video. Move the slider on the bar to the left or right to rewind or fast-forward the video.

Search for Videos

1. On the YouTube screen, tap  on the screen to open the search box.
2. Enter the keyword to search. Search results appear below the status bar.
3. Tap a video to watch it.

Apps and Entertainment

All your phone's features are accessible through the Apps list.

Google Play Store App

Google Play™ is your digital content destination to discover Android apps, books, movies, music and much more. Choose from a wide variety of free and paid content ranging from productivity apps and games to bestselling books and blockbuster movies and music. When you find what you want, you can easily download and install it on your phone.

To access the Google Play Store app, you must first connect to the Internet using your phone's Wi-Fi, 4G LTE, or data connection and sign in to your Google Account. See [Web and Data](#) and [Sign In to Your Google Account](#).

Find and Install an App

When you install apps from the Google Play Store app and use them on your phone, they may require access to your personal information (such as your location, contact data, and more) or access to certain functions or settings of your phone. Download and install only apps that you trust.

1. From the Home screen, tap **Play Store**.
2. When you open the Google Play Store app for the first time, the Terms of Service window will appear. Tap **ACCEPT** to continue.
3. Find an app you want and tap it to open its details screen.

Note: Your Google Play Store app will update automatically when available.

4. Tap an app to read a description about the app and user reviews.
5. Tap **INSTALL** (for free applications) or the price button (for paid applications).

Note: If you have not set up your payment method on your Google account, you are prompted to add a payment option to complete your account setup.

6. Read the message thoroughly every time it appears and follow the onscreen instructions to complete the installation or purchase.

Warning: **Read the notification carefully!** Be especially cautious with applications that have access to many functions or a significant amount of your data. Once you tap **ACCEPT** on this screen, you are responsible for the results of using this item on your phone.

Google Play Store Options

Some convenient options are available with the Google Play Store app.

- ▶ In the Google Play Store app, tap  on the top left of the screen.

You can check and get the latest apps information you installed, search apps you have been looking for, or view more options. Available options may vary.

Tip: You can also touch and hold the left end of the screen and slide it to the right to display the options, and touch the empty area on the right side of the options screen to return to the Google Play Store homepage.

Open an Installed App

There are options for opening an installed app.

1. From the Home screen, tap **Play Store**.
2. Tap  on the top left of the screen, or touch and hold the left end of the screen and slide it to the right, and tap **My apps & games**.
3. Locate the app and tap the icon.
4. Tap **OPEN**.

Uninstall an App

You can uninstall any app that you have downloaded and installed from the Google Play Store app.

1. From the Home screen, tap Apps  > **Settings** > **Apps & notifications**.
2. Tap **See all apps**.
3. Tap the app you want to uninstall and tap **UNINSTALL**.
4. When prompted, tap **OK** to remove the app from your phone.

- or -

1. From the Home screen, tap **Play Store**.
2. Tap  on the top left of the screen, or touch and hold the left end of the screen and slide it to the right and tap **My apps & games**.
3. Tap the app you want to uninstall and tap **UNINSTALL**.
4. When prompted, tap **OK** to remove the app from your phone.

Google Maps

Use the Google Maps app to determine your location, find directions, browse local businesses and attractions, rate and review places, and more.

Enable Location Services on Your Phone

Before using any location-based services, you must enable your phone's GPS location feature. See [Location Settings](#).

Open Google Maps

- ▶ From the Home screen, tap **Apps**  > **Google** > **Maps**.

Note: When you open the Google Maps apps for the first time, the Welcome to Google Maps screen will appear. Tap **ACCEPT & CONTINUE** if you agree to the Terms of Service and Privacy Policy.

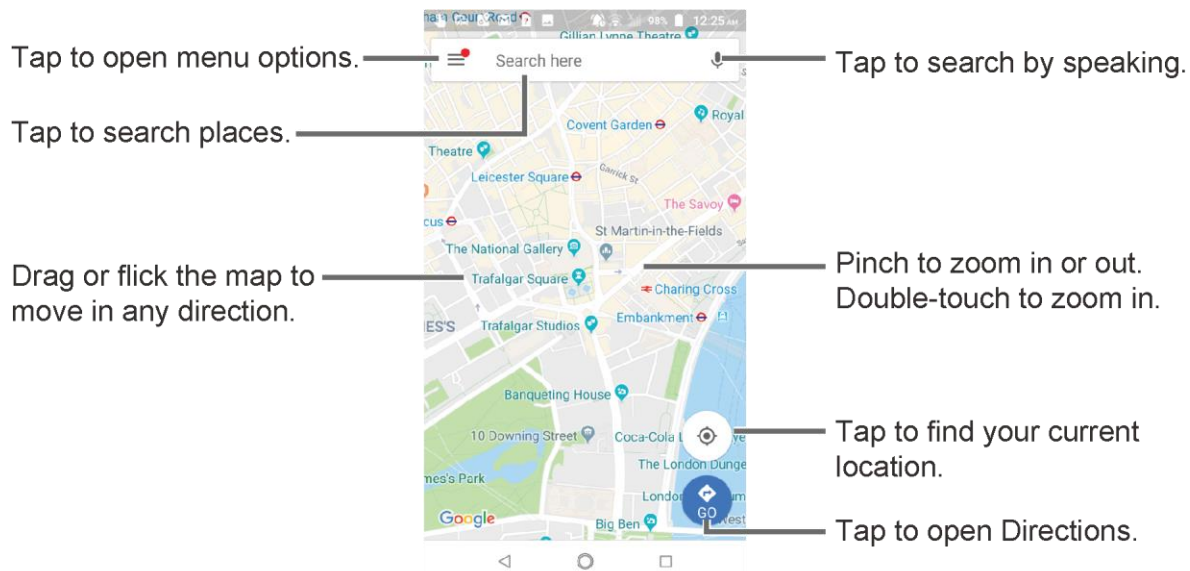

Find Your Current Location

Note: Don't forget to set your location sources.

On the Google Maps screen, tap . A blinking blue arrow indicates your current location on the map. This feature is available when the location setting is enabled. See [Location Settings](#).

Search Maps

1. On the Google Maps screen, tap inside the Search bar at the top of the screen.

2. Type the place that you want to search. You can enter an address, a city, or type of establishment.

Tip: Tap  to enter the location by speaking.

3. Tap a matching result on the drop-down list, or tap  on the keyboard. A red marker appears on the map to indicate the location together with a label at the bottom of the screen.
4. Tap the marker or the label to open the menu for the location.

Add Map Layers

Layers allow you to view locations and additional info overlaid on the map. Some of the layers are available in selected areas only.

- ▶ On the Google Maps screen, tap  on the top left of the screen, or touch and hold the left end of the screen and slide it to the right:
 - **Traffic:** Provides real-time traffic information. The colors on the roads indicate the traffic conditions.
 - **Public Transit:** Provides available transit information.
 - **Bicycling:** Provides possible cycling routes.
 - **Satellite:** Provides the hybrid view of road labels overlaid on a satellite image.
 - **Terrain:** Provides a shaded relief view of topographic features.
 - **Google Earth:** Launches the Google Earth app and displays your location in Google Earth.



Note: Tap **Tips & tricks**, **Settings**, **Help** or **Send feedback** for additional options.

Get Directions

1. On the Google Maps screen, tap .
2. Specify the starting point and the destination:

Tip: To display your Home and Work as options, tap  at the top left of the Google Maps screen, select **Your places**, and then enter their addresses.

- The starting point is set to your current location as default. To change it, tap **Your location** and type a new point in the **Choose starting point** field or select a point from the list.

- Tap **Choose destination** and type your destination or select a destination from the list.
 - Tap  to switch the starting point and the destination.
3. Select the method to get to the destination (by car, by public transit, or by foot).
 - You may tap  or **OPTIONS** to configure available settings options.
 4. Tap the result to see the details.

Music

You can play digital audio files saved on the phone or the storage card using music apps. See [Use the Phone's microSD Card as a Media Device](#) for copying files.

Play Music

Access the Play Music app to enjoy your favorite music.

Access the Play Music App

1. From the Home screen, tap **Apps**  > **Google** > **Play Music**. The Google Play Music screen appears.



Note: If you have signed up for Google Music™, the first time you open the Play Music application you will be prompted to select the account whose online music library you want to access from the Google Play Music application. Follow the onscreen instructions to continue.



2. Tap  on the top left of the screen, or touch and hold the left side of the screen and slide it to the right, to display the screen options.
 - **Listen Now:** Your starting point to play music. See The Listen Now Screen below.
 - **Recents:** Displays your music recently played or added.
 - **Top charts:** Displays Google Play Music best hit charts.
 - **New releases:** Displays Google Play Music newly released music.
 - **Music library:** Your music is sorted by **PLAYLISTS, ARTISTS, ALBUMS, SONGS** and **GENRES**.
 - **Shop:** Allows you to visit the Play Music store and obtain music.
 - **Downloaded only:** Allows you to show only the downloaded music on your device. Tap the switch to turn the feature on or off.
 - **Settings:** Allows you to change your settings on the Google Play Music.

- **Help & Feedback:** Displays Google Play Music help page.

The Listen Now Screen

Learn the basics to use the Play Music application.

- ▶ Tap **Shuffle all** to play the music on your phone in shuffle mode.
- ▶ Tap an album image and then tap a song in the album to play it.
- ▶ Tap  for available options.
- ▶ Tap  to search for music.

The label of the currently played song appears at the bottom of the screen when you play music. Simply tap  or  on the label or tap the label to display a screen with more control menus to manage.

Web and Data

Your phone's data capabilities let you wirelessly access the Internet or your corporate network through a variety of connections, including Wi-Fi, 4G LTE, 4G, 3G, and Virtual Private Networks (VPN).

The following topics address your phone's data connections and the built-in Web browser. Additional data-related features can be found in [Accounts and Messaging](#), [Apps and Entertainment](#), and [Tools and Calendar](#).

Wi-Fi

Wi-Fi provides wireless Internet access. To use your phone's Wi-Fi, you need access to a wireless access point or "hotspot."

The availability and range of the Wi-Fi signal depends on several factors, including infrastructure and other objects through which the signal passes.

Turn Wi-Fi On and Connect to a Wireless Network

Use the Wireless & networks setting menu to enable your phone's Wi-Fi radio and connect to an available Wi-Fi network.

1. From the Home screen, tap **Apps**  > **Settings** > **Network & Internet**.
2. Tap **Wi-Fi** and tap the **ON/OFF** icon to turn Wi-Fi on. Tap the available network to connect.
3. If you selected an open network, you will be automatically connected to the network. If you selected a network that is secured with a password, enter the password and then tap **CONNECT**.

Depending on the network type and its security settings, you may also need to enter more information or choose a security certificate.

When your phone is connected to a wireless network, the Wi-Fi icon  appears in the status bar and tells you the approximate signal strength. (The above icon indicates maximum signal strength.)

Note: The next time your phone connects to a previously accessed secured wireless network, you will not be prompted to enter the password again, unless you reset your phone to its factory default settings or you instruct the phone to forget the network.

Note: Wi-Fi networks are self-discoverable, which means no additional steps are required for your phone to connect to a Wi-Fi network. It may be necessary to provide a user name and password for certain closed wireless networks.

Check the Wireless Network Status

Check the status of your current wireless network, including speed and signal strength, through the Wi-Fi settings menu.

1. From the Home screen, tap **Apps**  > **Settings** > **Network & Internet** > **Wi-Fi**.
2. Tap the wireless network that the phone is currently connected to. You will see Network info showing the Wi-Fi network name, status, signal strength, frequency, and other details.

Note: If you want to remove the phone's wireless network settings, tap **FORGET** on this window. You need to enter the settings again if you want to connect to this wireless network.

Connect to a Different Wi-Fi Network

Use the Wireless & networks settings menu to scan for and connect to a different Wi-Fi network.

1. From the Home screen, tap **Apps**  > **Settings** > **Network & Internet** > **Wi-Fi**.
 - Tap the **ON/OFF** icon to turn on the Wi-Fi.
 - Detected Wi-Fi networks are displayed in the Wi-Fi networks section.
2. Tap another Wi-Fi network to connect to it.

Note: If the wireless network you want to connect to is not in the list of detected networks, tap **Add network** at the bottom of the list. Enter the wireless network settings and tap **SAVE**.

The Wi-Fi Settings Menu

The Wi-Fi settings menu lets you turn Wi-Fi on or off, set up and connect to available Wi-Fi networks, and configure advanced Wi-Fi options.

- ▶ From the Home screen, tap **Apps**  > **Settings** > **Network & Internet** > **Wi-Fi**.
 - **Add network** to add networks to the network list.
 - **Wi-Fi preferences** consists of the following menus:
 - **Show Wi-Fi pop-up** with the **ON/OFF** icon to show or not show a pop-up window when Wi-Fi is available.
 - **Wi-Fi notifications** with the **ON/OFF** icon to notify when Wi-Fi is available.
 - **Avoid bad Wi-Fi connections** with the **ON/OFF** icon to use mobile network whenever the Wi-Fi network has no internet connection. (Data usage may apply.)
 - **Install certificates** to install the certificates for communicating via Wi-Fi.

- **Network rating provider** to let you select one of the listed items.
- **Wi-Fi Direct** to use a peer-to-peer Wi-Fi connection. The Wi-Fi client and the hotspot operation will be disabled while Wi-Fi direct is enabled.
- **WPS Push Button** to set up a Wi-Fi Protected Setup connection by pressing the set up button on the router.
- **WPS Pin Entry** to set up a Wi-Fi Protected Setup connection by entering the PIN on your router.
- At the bottom of the list, you can check your phone's **MAC address** and **IP address**.
- **Saved networks** to view the saved networks. You can also see **Add network** to add networks to the network list.

Data Services

The following topics will help you learn the basics of using your data services, including managing your user name, launching a data connection, and navigating the Web with your phone.

Important: Certain data services requests may require additional time to process. While your phone is loading the requested service, the touchscreen may appear unresponsive when in fact they are functioning properly. Allow the phone some time to process your data usage request.

Launch a Web Connection

Launching a Web connection is as simple as opening the browser on your phone.





- From the Home screen, tap **Chrome**.

Note: The Chrome browser automatically launches when a Web link is tapped from within either an email or text message.

Data Connection Status and Indicators

Your phone displays the current status of your data connection through indicators at the top of the screen. The following symbols are used:

Icon	Description
	Your phone is connected to the high-speed 4G LTE network.

Icon	Description
	Your phone is connected to the 3G network.
	Your phone is connected to the EDGE network.
	Your phone is connected to the HSPA network.
	Your phone is connected to the GPRS network.

When the arrows are animated, your phone is transferring data (for example, when you are opening a Web page); when the arrows are gray, your phone is connected to the network but is not currently transferring data (for example, when you are viewing a Web page that is completely open). In either state, you can receive incoming calls.

If you do not see an indicator, your phone does not have a current data connection. To launch a connection, see [Launch a Web Connection](#).

Virtual Private Networks (VPN)

From your phone, you can add, set up, and manage virtual private networks (VPNs) that allow you to connect and access resources inside a secured local network, such as your corporate network.

Prepare Your Phone for VPN Connection

Depending on the type of VPN you are using at work, you may be required to enter your login credentials or install security certificates before you can connect to your company's local network. You can get this information from your network administrator.

Before you can initiate a VPN connection, your phone must first establish a Wi-Fi or data connection. For information about setting up and using these connections on your phone, see [Launch a Web Connection](#) and [Turn Wi-Fi On and Connect to a Wireless Network](#).

Install Security Certificates

Your network administrator may instruct you to download and install security certificates to connect to the network.

1. Download and install the certificates needed to access your local network into a microSD card. Your network administrator can tell you how to do this.
2. Insert the microSD card into your phone. See [Insert or Remove a microSD Card](#).

3. From the Home screen, tap **Apps**  > **Settings** > **Security & location** > **Encryption & credentials** > **Install from Storage**, and install the necessary security certificates.

Add a VPN Connection

Use the Wireless & networks settings menu to add a VPN connection to your phone.

1. From the Home screen, tap **Apps**  > **Settings** > **Network & Internet** > **VPN**.
2. Tap **+** and enter VPN profile > **SAVE**.

The VPN is then added to the VPNs section of the VPN settings screen.

Connect to or Disconnect from a VPN

Once you have set up a VPN connection, connecting and disconnecting from the VPN is easy.

Connect to a VPN

1. From the Home screen, tap **Apps**  > **Settings** > **Network & Internet** > **VPN**.
2. In the VPNs section, tap the VPN that you want to connect to.
3. When prompted, enter your login credentials, and then tap **CONNECT**. When you are connected, a VPN connected icon appears in the notification area.
4. Open the Web browser to access resources such as intranet sites on your corporate network. For more information about browsing the Web, see [Learn to Navigate Chrome](#).

Disconnect from a VPN

1. Slide the status bar down to open the Notifications panel.
2. Tap the VPN connection to return to the VPN settings screen, and then tap the VPN connection to disconnect from it.

When your phone has disconnected from the VPN, a VPN disconnected icon briefly appears in the notification area.

Browser

Your phone's Web browser gives you full access to both mobile and traditional websites on the go, using data services or Wi-Fi data connections.

Launch Chrome

Launching Chrome is as easy as tapping an icon.

- ▶ From the Home screen, tap **Chrome**.

Learn to Navigate Chrome

Navigating through menus and websites during a data session is easy once you have learned a few basics.

Scrolling

As with other parts of your phone's menu, you'll have to drag up and down to see everything on some websites.

To scroll through a website's page:

- ▶ In a single motion, touch and drag across or up and down a page.

Selecting

To select onscreen items or links:

- ▶ Scroll across a page, and then tap an item or onscreen link.

Links, which are displayed as underlined text, allow you to jump to Web pages, select special functions, or even place phone calls.

Pinching and Zooming

Zooming in and out on a Web page can be done without the need of an onscreen zoom tool. Just use your fingers to pinch in or spread out on the screen.

To zoom in:

1. Place your thumb and index finger on the screen.
2. Expand them outward (spread) to zoom in.

To zoom out:

1. Place your thumb and index finger on the screen.
2. Bring them together (pinch) to zoom out.

Go Back

To go back one page:

- ▶ Tap **Back**  on your phone. Repeat this process to keep going back through your Web page history of recently visited pages.

Go to a Specific Website

1. Tap the search/address field at the top of the browser window and enter a new Web address.

- As you enter the address, possible matches are displayed within an onscreen list. Tap an entry to launch the desired website.

Tip: You can also enter a search term into the field to perform a Web search.

2. Tap  on the keyboard to launch the new page.

Chrome Menu





The Chrome menu offers additional options to expand your use of the Web on your phone.

Open the Chrome Menu

The Chrome menu may be opened anytime you have an active data session, from any page you are viewing.

- ▶ From the Home screen, tap **Chrome** > .

Options available within the Chrome menu may include:

-  : Returns you to the previously viewed page.
-  : Adds the currently viewed page to a bookmark.
-  : Downloads files.
-  : Show information about the currently viewed page.
-  : Reloads the currently viewed page.
- **New tab:** Opens a new page as a new tab.
- **New incognito tab:** Opens a new incognito page. Those pages you view in incognito tab will not appear in your browser history or search history, and they will not leave other traces on your phone like cookies after you close all open incognito tabs. Any bookmarks you create will be preserved.
- **Bookmarks:** Allows you to access and manage your bookmarks.
- **Recent tabs:** When you sign into Chrome, allows you to refer to the open tabs, bookmarks, and data from other devices logged in with the same account.
- **History:** Displays the browsing history.
- **Downloads:** Displays downloaded file list.
- **Share...:** Allows you to share the current Web page via Bluetooth, Gmail, Message+, etc.

- **Find in page:** Searches the current Web page for a word.
- **Add to Home screen:** Creates a shortcut icon of the current page on the Home screen.
- **Desktop site:** Displays the PC site of the current Web page.
- **Settings:** Lets you configure and manage your Chrome settings.
- **Help & feedback:** Opens a support page for Chrome.

Note: The Chrome menu options may vary depending on the version installed on your phone.

Select Text on a Web Page

You can highlight text on a Web page and copy it, search for it, or share it.

1. Scroll to the area of the Web page containing the text you want to select.
2. Touch and hold the text you want to copy. Drag the tabs to expand or reduce the range of the selected text. Any selected text will appear highlighted.

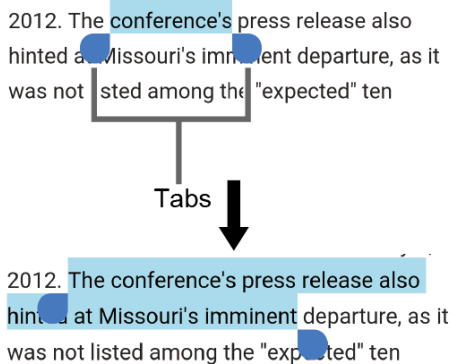

3. Select an option:
 - **COPY** to copy the selected text.
 - **SHARE** to share the selected text via Bluetooth, Gmail, Message+, etc.
 - **SELECT ALL** to select all the text on the Web page.
 - **WEB SEARCH** to launch a Web search for the selected text.

Tip: If you don't see **WEB SEARCH** in the list, tap  to show the menu.



Manage Bookmarks

Make browsing easier by setting up and using custom bookmarks.



View Bookmarks

- ▶ From the Home screen, tap **Chrome** >  > **Bookmarks**.



Create Bookmarks

1. From the Home screen, tap **Chrome**.
2. Open the Web page you want to bookmark.
3. Tap  > .

Edit Bookmarks

1. From the Home screen, tap **Chrome** >  > **Bookmarks**.
2. Touch and hold the bookmark you want to edit and tap .

– or –

1. From the Home screen, tap **Chrome**.
2. Tap  >  on the Web page you want to edit.
3. Edit the bookmark. Tap  to remove the bookmark.

Mobile Hotspot

Mobile Hotspot allows you to turn your phone into a Wi-Fi hotspot. The feature works best when used in conjunction with 4G LTE data services. See [Mobile Hotspot & tethering](#).

Tethering

USB tethering

You can tether your phone to your computer with a USB cable and share your phone's Internet connection with your computer. See [Mobile Hotspot & tethering](#).

Bluetooth tethering

You can share your phone's Internet connection with Bluetooth devices via Bluetooth. See [Mobile Hotspot & tethering](#) and [Bluetooth](#).

Camera and Camcorder

You can use the camera or camcorder to take and share pictures and videos. Your phone comes with a 13.0 megapixel back camera with a phase detection autofocus feature and 5.0 megapixel front camera that let you take sharp pictures and videos and also has the Super Wide-View 4K 8.3 megapixel Action Camera that allows you to take wide angle shots.

Use the Camera App

The following topics teach you how to take pictures and record videos.

Open or Close the Camera App

The first step to take a picture or record a video is to open the camera app.

Open the Camera App

- ▶ Press and hold the camera button on the lower right side of the phone.
- or –
- From the Home screen, tap **Apps**  > **Camera**.

Close the Camera App

- ▶ On the camera screen, tap **Home**  or **Back** .

Viewfinder Screen

The viewfinder screen lets you view your subject and provides controls and options for taking pictures or recording videos.



- **Zoom Slider:** Adjusts your zoom level. Pinch the screen with two fingers to display the zoom slider.
- **Thumbnail:** Displays the thumbnail of the latest image. Tap to view and manage.

- **Shutter Key:** Takes a picture.
- **Record Key:** Records a video.
- **MENU Key:** Opens the camera and camcorder settings menu. For more information, see [Camera and Camcorder Settings](#).
- **Flash Key:** Helps illuminate subjects in low-light environments.
- **Switch Key:** Switches between the back camera and the front camera.
- **Wide View Key:** Switches between the back camera and the Wide-View Action Camera.

Take a Picture or Record a Video

You can record high quality images with your phone's camera and camcorder.

1. Press and hold the camera button on the lower right side of the phone and tap **OPEN CAMERA**.

– or –

From the Home screen, tap **Apps**  > **Camera**.

2. Do the following to change the settings:
 - Tap  to switch between the front camera and the back camera.
 - Tap **MENU** to change the camera and camcorder settings as desired. See [Camera and Camcorder Settings](#).
 - Pinch or spread to display the slider and zoom in or out on the slider, to zoom in or out on your subject. You can also press the Volume button up or down to zoom in or out.
 - Tap any point to focus the area.
3. Frame your subject on the screen.

Tip: Hold the phone vertically when taking portrait shots or hold the phone horizontally when taking landscape shots.

4. Tap , or press the camera button, to take a picture.

– or –

Tap  to record a video. Tap  or  to pause or resume recording. To stop recording, tap .

5. Choose what you want to do with the image you've just taken or recorded. See [Review Screen](#) to follow.

Review Screen

After taking a picture or video, tap the thumbnail image to see the item in the review screen. From there, you can instantly share your photos or videos (see [Share Pictures and Videos](#)) or tap the Photos icon to edit your photos or replay your videos (see [View Pictures and Videos Using Photos](#)).

To review the image:

- ▶ Tap the thumbnail image on the screen.

To display options for the displayed image:

- ▶ Tap the image to display available options.

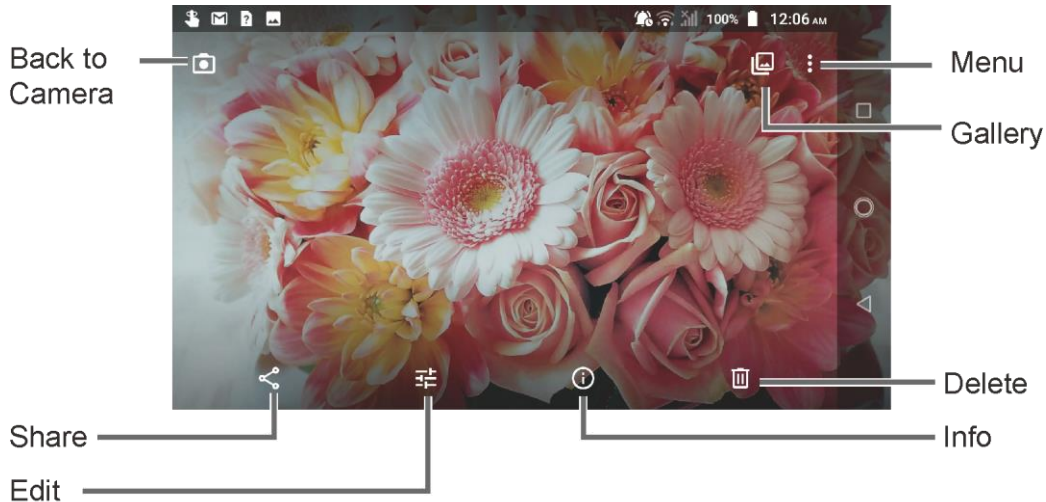

- **Menu:** Displays available menus for the image. Available menus may vary:
 - **Slideshow:** Starts the slideshow of the pictures stored in the Photos application.
 - **Loop video:** Select this option to see a video repeatedly. This menu displays only when reviewing a video.
 - **Use as:** Sets the picture as the contact photo or wallpaper.
 - **Print:** Prints the selected picture.
 - **Edit in:** Opens the image by other apps.
 - **Delete from device:** Deletes the image from the device.
 - **Help & Feedback:** Opens the Help window with the Feedback action.

- **Gallery:** Opens the Photos.
- **Back to Camera:** Returns to the Camera.
- **Share:** Displays available applications to share your image.
- **Edit:** Displays the editing options. For details, see [Edit a Picture](#).
- **Info:** Shows the photo's information and lets you add a description if desired.
- **Delete:** Deletes the currently displayed image. Tap **DELETE** to confirm the deletion.

Action Overlay Mode

You can take a photo or record a video with additional information such as elapsed time, travel distance, speed, G-force, altitude, date and time, or route.

Warning: Do not operate the app while driving or riding a bicycle or motorcycle. Please stop moving and take particular care of your safety if you want to operate the app.

- ▶ From the Home screen, tap **Apps**  > **Camera** > **MENU** > **Action Overlay**.

Note: Action Overlay mode uses location information. You will be prompted to enable the Location settings if they are disabled. High accuracy must be selected under the Location settings. Read the onscreen information and follow the instructions to proceed.

- **Review Key:** Opens the review screen. See [Review Screen](#).
- **Camera Key:** Takes a picture.
- **Record Key:** Records a video.
- **Settings Key:** Opens the settings screen for the Action Overlay mode.
- **Wide View Key:** Switches between the normal camera mode and the Wide-View Action Camera mode.
- **MENU Key:** Opens the camera and camcorder settings menu. For more information, see [Camera and Camcorder Settings](#).

Action Overlay Mode Settings

You can configure the Action Overlay mode settings by tapping . The following options are available:

- **Altitude settings:** Select **Feet (ft)** or **Meter (m)**. Tap **Altitude correction** to set the desired altitude.

- **Speedometer settings:** Select **Mile (mi)**, **Kilometer (km)** or **Nautical mile (nm)** for Units and choose **25mph**, **50mph**, **100mph**, or **150mph** for Max speed.
- **Select display data:** Check or uncheck the checkbox for **Speedometer**, **Elapsed time**, **Distance**, **Altitude**, **G-force**, **Date & time**, and **Route**.
- **Screen rotation:** Switch Screen rotation **On** and **Off**.
- **Screen lock:** Switch Screen lock **On** and **Off**.

Note: Screen will lock after recording begins to avoid accidental operations.

Underwater Mode

You can take a picture or record video also in the water. Your phone is immersible in water for up to 30 minutes at a depth not exceeding two meters (about 6.56 ft.).

Warning: Avoid using phone in saltwater. It is highly corrosive and can damage internal components and degrade the audio performance over time.

1. From the Home screen, tap **Apps**  > **Camera** > **MENU** > **Mode** > **Underwater**.
2. In Underwater mode, the following physical buttons are used instead of touch screen icons.

The touchscreen is unavailable except thumbnail area.

- For Viewfinder screen:
 - Camera button (pressing once) to take photos or record videos.
 - Camera button (pressing twice) to switch between Camera and Camcorder.
 - Volume button to zoom.
 - PTT/Programmable button to open menu. (Long press to exit Underwater.)
- For Menu screen:
 - Camera button to switch or select value.
 - Volume button to choose item.
 - PTT/Programmable button to close menu. (Long press to exit Underwater.)

Warning: Before immersing your phone in the water, make sure all ports and covers are properly seated, with no foreign objects obstructing the seals, to maintain the waterproof capability. The phone should never be used under water with broken or open SIM/microSD slot cover.

Note: After using your phone in the Underwater Mode, immediately rinse the phone gently in clean fresh water. The phone should be dried using a very specific procedure. See [Drying Your Phone](#).

Camera and Camcorder Settings

You can adjust the settings of your camera and camcorder by tapping  on the viewfinder screen. Some options are available for the back camera or camcorder only.

- **Auto:** Takes a picture or records a video using the recommended settings.
- **Action Overlay:** Adds additional data to your recording.
- **Mode:** Select from **Effect**, **Panorama**, **Manual**, **Underwater**, **Slow motion**, **Time lapse**, **Night view**, or **Sports**.
 - **Effect:** Adds an effect to the picture or video.
 - **Panorama:** Takes a panorama picture as you pan the phone sideways.
 - **Manual:** Customizes settings for taking photos and videos.
 - **Underwater:** Allows you to take a picture or record a video under water.
 - **Slow motion:** Records a video or view in slow motion.
 - **Time lapse:** Select the time lapse recording setting from 1s, 2s, 3s, 5s, or 10s.
 - **Night view:** Takes a picture or records a video with the night effect.
 - **Sports:** Takes a picture or records a video of sports action.
- **Size:** Select from **16:9**, **4:3**, or **1:1**.
- **Stabilization/HDR:** Select **Off**, **Stabilization** or **Auto HDR**.
 - Stabilization to reduce camera shake.
 - AutoHDR to combine images automatically to prevent white spots or blackouts. By selecting “Save original photo”, you can save the photo before combining.
- **Quick SNS:** Switch **On** or **Off**.
- **Change layout:** Select from Default, Left hand, Right hand, or Customize style.
- **Self timer:** Select from **Off**, **2 sec.**, **5 sec.**, or **10 sec.**.
- **Other settings:**
 - **Add location info:** Stores the location information of the image. Switch **On** or **Off**.

- **Shutter sound:** Switch **On** or **Off**.
- **Key:** Select a function to assign to
 - Volume key from **Take Photos**, **Record video**, **Zoom** or **Volume**.
 - Camera key from **Take Photos** or **Record video**.
 - PTT key (long press) from : **Same as PTT key setting** or **Toggle camera mode**.

Note: For further details, tap **?** displayed next to PTT key (long press) on this screen.

- **Audio recording:** Switch to **Unmute** or **Mute**.
- **Storage:** Select where to store your pictures and videos from **Phone** or **SD card** (only available when the microSD card is inserted).
- **Grid:** Switch **On** or **Off**.
- **Preserve last mode:** Switch **On** or **Off**.

Note: **On** to preserve the mode you are in and launch Camera application next time with the preserved mode. **Off** to launch Camera application every time with Auto mode.

- **Reset settings:** Restores all the camera and camcorder settings to original state. Tap **OK** to confirm.
- **Help:** Displays the help information for camera.

Note: Available options may vary according to the subject and shooting/recording mode.

View Pictures and Videos Using Photos

Using the Photos application, you can view pictures and watch videos that you've taken with your phone's camera, downloaded, or copied onto your microSD card or phone's internal memory.

For pictures that are on your microSD card or phone's internal memory, you can do basic editing such as rotating and cropping. You can also easily assign a picture as your contact picture or wallpaper and share pictures with your friends.

Open or Close Photos

Open the Photos App

- ▶ From the Home screen, tap **Photos**.

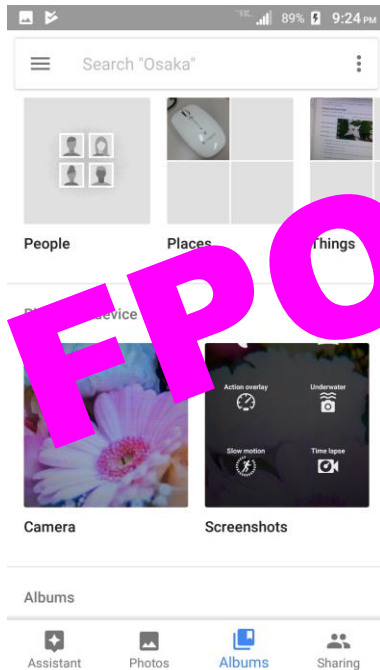

When viewing pictures in Photos, scroll up or down to view more photos. When viewing Albums, simply tap an album to view the pictures or videos in that album.



Note: Depending on the number of pictures stored, it may take some time for Photos to load all your albums on the screen.

Close the Photos App

- ▶ While in the Photos screen, tap **Home** .

View Pictures and Videos

After selecting an album, you can browse through the pictures and videos in grid view. Tap a picture or video to view.

1. From the Home screen, tap **Photos**.
2. Tap an image to view a picture or video.
 - For the video, tap the thumbnail to play. After start playing, tapping the screen will display the control options. Tap  to pause the video or drag the dot on the timeline to rewind or forward the video. Tap  to resume.

Zoom In or Out on a Picture

There are two ways you can zoom in or out on a picture.

- ▶ Tap the screen twice quickly to zoom in, and then tap the screen twice quickly again to zoom out.

– or –

Pinch the screen using your thumb and forefinger to zoom out or spread the screen to zoom in.

Work with Pictures

You can manage your pictures.



Picture Options Menu

Various options are available while viewing a picture. For details, see [Review Screen](#).



Edit a Picture

Your phone has a built in editing tool and you can alter your pictures easily.

Adjust lightning, color, etc.



1. Tap a picture and tap .
2. Tap .





- **Light:** Move the slider to the left or right to adjust the lighting. For more options, tap .
- **Color:** Move the slider to the left or right to adjust the color. For more options, tap .

- **Pop:** Move the level correction slider to the left or right.
3. When finished, tap **SAVE** at the top right of the screen to apply the changes to the picture.

Rotate a Picture

1. Tap the picture you want to rotate.
2. Tap  >  > .
3. Tap **DONE**.
4. Tap **SAVE** at the top right of the screen to apply the changes to the picture.

Crop a Picture

1. Tap the picture you want to crop.
2. Tap  > . A crop box appears on the picture.
3. To adjust the crop box size, touch and hold the edge of the box, and drag your finger inward or outward to resize the crop box.
4. To move the crop box to the part of the picture that you want to crop, drag the crop box to the desired position.
5. Tap **DONE**.
6. Tap **SAVE** at the top right of the screen to apply the changes to the picture.

The cropped picture is saved in the album as a copy. The original picture remains unedited.

Share Pictures and Videos

The Photos application lets you send pictures and videos using email or multimedia messages. You can share pictures on your social networks. You can also send them to another phone or your computer using Bluetooth. You can see some of the examples to share your pictures and videos below.

Send Pictures or Videos by Gmail

You can send several pictures, videos, or both in a Gmail message. They are added as file attachments to your email.

1. Touch and hold the picture or video to place a check mark on it. Tap multiple pictures and videos to select them.
2. Tap  > **Gmail**.



3. Enter **To** field, and compose your message and send a message.

Note: If you have multiple accounts, the default account will be used.

For more information about sending Gmail, see [Send a Gmail Message](#).

Send Pictures or Videos by Message+

You can send pictures and videos using the Message+ app. Although you can send several pictures or videos, it may be better to just send one at a time, especially if the files are large in size.

1. Touch and hold the picture or video to place a check mark on it. Tap multiple pictures and videos to select them.
2. Tap  > **Message+**.
3. Enter **To:** field, and compose your message and then tap .

For more information about multimedia messages, see [Message+](#).



Send Pictures or Videos Using Bluetooth

You can select several pictures, videos, or both and send them to another phone or your computer using Bluetooth.

1. Touch and hold the picture or video to place a check mark on it. Tap multiple pictures and videos to select them.
2. Tap  > **Bluetooth**.
3. You'll be asked to turn on Bluetooth on your phone and connect to the receiving Bluetooth device so the files can be sent. For more information, see [Bluetooth](#).

Share Videos on YouTube

You can share your videos by uploading them to YouTube™. Before you do this, you must create a YouTube account and sign in to that account on your phone.

1. Touch and hold the video to place a check mark on it. Tap multiple videos to select them.
2. Tap  > **YouTube**.
3. Enter the prompted information, such as title, description and tags, and select a privacy option.
4. Tap .

Tools and Calendar

Learn how to use many of your phone's productivity-enhancing features.



Calendar

Use Calendar to create and manage events, meetings, and appointments. Your Calendar helps organize your time and reminds you of important events. Depending on your synchronization settings, your phone's Calendar stays in sync with your Calendar on the Web.

Add an Event to the Calendar

Add events to your calendar directly from the Calendar application.

Add an Event

1. From the Home screen, tap **Apps**  > **Calendar**.
2. On any Calendar view, tap  > **Event**.
3. Enter an event title.
4. Specify the date and time of the event:
 - If the event is a special occasion such as a birthday or an all-day event, tap **All day** to turn it on.
 - If there is a time frame for the event, tap the times below **All day** switch to set them.
 - To change the time zone, tap **More options**, tap the time zone field and select an option from the displayed list.
5. If the event occurs on a regular basis, tap the **Does not repeat** field and set the frequency.
6. Enter the event location.
7. Set the event notification time and select how you are notified.
 - If you do not want any reminder, tap **X** next to the notification field.
 - Tap **Add another notification** to add another notification.
8. Enter email addresses to invite guests to your event and add the event descriptions. See [Invite Guests to Your Calendar Event](#).
9. Select the default color to show your calendar.
10. Tap **Add note** and enter a note.

11. Tap **Add attachment**, choose an item and tap **Select**.
12. Tap **SAVE** to save the event in the calendar.

Invite Guests to Your Calendar Event

If you want to invite guests to your event, you need to create and add the event.

An email invitation will be sent to your guests using your account.

1. Open Calendar and create a new event. See [Add an Event to the Calendar](#).
2. In the **Invite people** field, enter the email addresses of everyone you want to invite to the event. Separate multiple addresses with commas.
3. Tap the **Guests can add others** field to allow the guests to add others or not.
4. Tap **DONE**.
5. Tap **SAVE** to add the event to your calendar.
6. Tap **SEND** to send invitations to guests.

People whom you have sent invitations to will receive it by email and in Calendar.

Calendar Event Alerts

When your phone is turned on and you have an event alarm scheduled, your phone alerts you and displays the event summary. There are several ways your phone alerts you to scheduled events:

- By playing the assigned ringtone or vibration type.
- By showing  on the status bar.
- By showing the Pop-up notification screen.

Event Reminders

If you have set at least one reminder for an event, the upcoming event icon  will appear in the notifications area of the status bar to remind you of the upcoming event.

To view the reminder:



1. Slide the status bar down to open the Notifications panel.

Note: If you have other pending event reminders, these events will also appear on the screen.

2. Tap the event name to see the event.

Add Reminders in the Calendar

You can add reminders in the Calendar application. Reminders carry over to the next day until you mark them as done. Your reminders are private and can't be shared with anyone else.

1. From the Home screen, tap **Apps**  > **Calendar**.
2. On any Calendar view, tap  > **Reminder**.
3. Type your reminder title and tap **DONE**.
4. Choose a date, time, and frequency.
5. Tap **SAVE**.



Note: You will see the reminder in the Calendar application. When you mark a reminder as done, it will be crossed out in the Calendar application, and will stay on the date you marked it as done.

Marking a Reminder as Done

1. From the Home screen, tap **Apps**  > **Calendar**.
2. Tap the reminder.
3. Tap **MARK AS DONE**.

Create a Goal in the Calendar

When you create a goal, you choose how much time you want to spend on it each week. Calendar automatically schedules time to work on your goal.

1. From the Home screen, tap **Apps**  > **Calendar**.
2. On any Calendar view, tap  > **Goal**.
3. Choose a category, like **Exercise** or **Build a skill**. To create a custom goal, pick a category, then tap **Custom**.
4. Follow the directions on your screen to set up your goal.
5. Tap .

Note: Goals will be automatically added to your calendar, starting with the first of four weeks. You can adjust the time or length of these events at any time.

Marking a Goal as Done

1. From the Home screen, tap **Apps**  > **Calendar**.

2. Tap the goal.
3. Tap **DID IT**.

View Calendar Events

You can display the Calendar in monthly, weekly, each 3 days, daily or schedule view. To change the Calendar view, tap  displayed at the upper left corner, and tap **Schedule, Day, 3 Day, Week** or **Month**.

- **Schedule:** Schedule view shows a list of all your events in chronological order.
- **Day:** Day view displays a list of the events of one day.
 - Touch two times on a time slot to create a new event at that time.
 - Tap an event to view its details.
 - Slide right or left across the screen to view earlier or later days.
- **3 Day:** 3 Day view displays a chart of the events of 3 days.
 - Touch two times on a time slot to create a new event at that time.
 - Tap an event to view its details.
 - Slide right or left across the screen, to view earlier or later days.
- **Week:** Week view displays a chart of the events of one week.
 - Touch two times on a time slot to create a new event at that time.
 - Tap an event to view its details.
 - Slide right or left across the screen, to view earlier or later weeks.
- **Month:** Month view displays markers on days that have events.
 - Tap the today icon on the top right to highlight the current day.
 - Tap a day to view the events of that day.
 - Slide right or left across the screen, to view earlier or later months.

Edit Calendar Events, Reminders, or Goals



Edit your calendar events, reminders, or goals to keep your calendar up to date.

1. From the Home screen, tap **Apps**  > **Calendar**.
2. Tap the event (or reminder or goal) you want to edit.

3. Tap .
4. Make changes to your event, then tap **SAVE**.



Delete Calendar Events, Reminders, or Goals

It's easy to delete scheduled events, reminders, or goals from your calendar.

1. From the Home screen, tap **Apps**  > **Calendar**.
2. Tap the event (or reminder or goal) you want to delete.
3. Tap  > **Delete**.
4. If the calendar event (or reminder or goal) is recurring, select **This event** (or **reminder** or **session**), **This and following events** (or **reminders** or **sessions**), or **All events** (or **reminders** or **sessions**).
5. Tap **DELETE**.

Quickly Hide or Show Events



You can easily hide or show calendar events if you don't need to see them all the time.

1. From the Home screen, tap **Apps**  > **Calendar**.
2. In any Calendar view, tap .
3. Tap each item (such as Events or Holidays) to hide.

Note: The checkmark changes to an empty box outline. The item will be hidden on the calendar.

Calendar Settings

You can change your settings for Calendar, including your display, notifications, and time zone.

1. From the Home screen, tap **Apps**  > **Calendar**.
2. In any Calendar view, tap  > **Settings**.
3. Tap **General** to access general settings, **Events from Gmail** to add events from Gmail messages, or tap each calendar item to configure it.
 - **General:** Start of the week, Use device time zone, Time zone, Alternate calendar, Show week number, Show declined events, Default event duration, Notify on this device, Calendar notifications, and Quick responses.

- **Events from Gmail:** When you get an email about event like a flight, concert, or restaurant reservation, it will be added to your calendar automatically. To deactivate this, tap the switch to turn off.
- Tap **Events, Reminders, Birthdays** or **Holidays** to customize its settings, such as color code or notifications.

Synchronize Calendars with Your Phone

You can choose which Google Calendars to keep synchronized on your phone or which ones to stop synchronizing.

Synchronize a Google Calendar





1. From the Home screen, tap **Apps**  > **Settings** > **Accounts**.
2. Tap the account you want to sync with.
3. Tap **Account sync**.
4. Tap **Calendar** to turn on.

Clock



The Clock application functions as a world clock that shows the date and time. You can also use it to turn your phone into an alarm clock, a countdown timer, or a stopwatch.

World Clock

You can add the time from around the globe on the World Clock screen.

1. From the Home screen, tap **Apps**  > **Clock**.
2. Tap **WORLD CLOCK** > , and select the check box next to the city you want to display on the Clock screen.
3. Tap **Back**  or tap  in the top-left corner of the screen to confirm.
 - The selected cities will be displayed at the top of the city list.

World Clock Settings

1. From the Home screen, tap **Apps**  > **Clock** > **WORLD CLOCK** > .
2. The following options are available:
 - **World Clock Style:** Select the style of the clock to display. Choose from: **Analog** or **Digital**.

- **Automatic home clock:** Check to add a clock with your home time to the screen while traveling in a different time zone.
- **Home time zone:** Select the time zone for your home time.

Alarm

You can use your phone as an alarm clock. Simply tap the **ON** or **OFF** icon next to an alarm to turn it on or off.

Set an Alarm

1. From the Home screen, tap **Apps**  > **Clock**.

2. Tap the **ALARM** tab to display the Alarms screen, if necessary.

Note: When you first open the alarms, three alarms are set up by default and ready for you to customize. These alarms are turned off by default.

3. Tap an existing alarm time to change the settings.

– or –

Tap  to add a new alarm.

4. Set the time to set off the alarm and tap **OK**. You will see the **ON** icon displayed next to the time you have set.

5. Tap **Add label** to add a description to the alarm.

6. To set the alarm on a regular basis, select the **Repeat** check box and select the day(s) of the week to repeat the alarm.

7. Tap  to select a ringtone that will play as an alarm.

8. Select the **Vibrate** check box to add a vibration feature to the alarm.

9. Tap **Snooze** to set the snooze interval.

Tip: Set it to **Do not snooze** if not necessary.

Delete an Alarm



1. From the Home screen, tap **Apps**  > **Clock**.

2. Tap the **ALARM** tab to display the Alarms screen, if necessary.

3. Tap  on the alarm you want to delete.





4. Tap **DELETE**  on the alarm you want to delete.

Alarms Settings

1. From the Home screen, tap **Apps**  > **Clock** > .
2. The following options are available:
 - **Alarm volume:** Set the volume of the alarm.
 - **Silence after:** Select the duration of the alarm to sound.
 - **Key behavior:** Select the behavior of the RECENT/HOME/BACK/CAMERA/Volume key when pressed while the alarm sounds. Choose from: **Silence**, **Snooze**, **Dismiss**, or **Do nothing**.
 - **Default alarm sound:** Select the default alarm sounds.
 - **Start week on:** Select the day that the week starts on the alarm.





Timer

You can use your phone as a countdown timer.

1. From the Home screen, tap **Apps**  > **Clock**.
2. Tap the **TIMER** tab to display the Timer screen, if necessary.
3. Set the countdown time and tap  to start the countdown.
4. The following options are available:
 - **Add label** to add a description to the timer.
 -  to stop the countdown.
 -  to resume the countdown.
 - **+10 min** to add an extra minute to the remaining time.
 - **+1 min** to add an extra minute to the remaining time.
 - **+10 sec** to add an extra second to the remaining time.
 - **RESET** to return to the start of the countdown.
 - **CLEAR** to turn to 0:00:00.



Stopwatch

You can use your phone as a stopwatch.

1. From the Home screen, tap **Apps**  > **Clock**.
2. Tap the **STOPWATCH** tab to display the Stopwatch screen, if necessary.
3. Tap  to start the stopwatch.
4. The following options are available:
 - **LAP** to record the lap time.
 -  to stop timing.
 -  to resume timing.
 - **SHARE** to share the recorded time via Message+, Bluetooth, etc.
 - **RESET** to reset the stopwatch.

Calculator

Your phone has a convenient calculator that lets you perform basic mathematical equations.

1. From the Home screen, tap **Apps**  > **Calculator**.
2. Enter numbers by tapping the onscreen keys.
3. Tap **DEL** to clear a number. Touch and hold to clear an entire number.
 - To access more advanced features, flick the screen left.
4. Tap **Back**  to close the calculator.

Tip: Tap  for more options.

Flashlight

Your phone's camera flash can work as a flashlight.

Warning: Do not shine the flashlight into anyone's eyes, as doing so may compromise their vision and cause an accident.







1. From the Home screen, tap **Apps**  > **Tools** > **Flashlight**.
2. Tap the **ON/OFF** icon to turn on or off.
3. The following options are available:
 - **Blink speed:** Set the blink speed of Flashlight.
 - **Brightness:** Set the Flashlight brightness.

- **Light time setting:** Set the Flashlight interval. Select from **Always on, 1 minute, 3 minutes, 5 minutes** and **10 minutes**. Tap  at the top left of the screen to display menu.

Sound Recorder

The Sound Recorder app lets you record sound and save it as an audio file on your phone or the inserted microSD card.



Record Sound

1. From the Home screen, tap **Apps**  > **Tools** > **Sound Recorder**.
2. Tap  > **File format** to select the format type. Select **Normal** or **High quality**.
3. Tap  > **Storage** to select where to save the recorded data. Select **Phone** or **SD card**.
4. Tap  to start recording.
 - Tap  to pause recording. Tap  to resume recording.
5. Tap  to stop recording.



Play Audio Data

1. On the screen where you finished recording, tap .

– or –

From the Home screen, tap **Apps**  > **Tools** > **Sound Recorder** >  and then tap a file.
2. The following options are available:
 - Drag the bar to rewind or fast-forward the data.
 - Tap  to display the list of the stored files. See [Stored Sound List Options](#) to follow.

Stored Sound List Options

1. From the Home screen, tap **Apps**  > **Tools** > **Sound Recorder**.
2. Tap  to display the list of the stored files.
3. The following options are available:
 - Tap  to delete a file or files. Tap a file or files to select the file(s) you want to delete and tap **OK**. To select all files on the list, tap **SELECT ALL**.

- Tap  next to each file:
 - **Share** to share the file via **Bluetooth**, **Gmail**, **Message+**, etc.
 - **Delete** to delete the file.
 - **Edit file name** to rename the file.
 - **Details** to display the information about the audio file.

Voice Services

Your phone's voice services let you place calls using your voice, convert text into speech, and more.

Text-to-Speech

Your phone can convert text into speech in certain downloaded applications. You may select the language you hear or adjust its speed.

1. From the Home screen, tap **Apps**  > **Settings** > **System** > **Languages & input**.

– or –

From the Home screen, tap **Apps**  > **Settings** > **Accessibility**.

2. Tap **Text-to-speech output**.
3. The following options are available:
 - **Preferred engine:** Select your preferred engine. Tap  to configure its settings.
 - **Language:** Shows the status of language support for voice recognition.
 - **Speech rate:** Choose a comfortable speed of the spoken text.
 - **Pitch:** Choose a comfortable tone of the spoken text.
 - **PLAY:** Play a short demonstration of the set speech synthesis.
 - **RESET:** Reset both Speech rate and Pitch to default.

Voice Search





Voice Search allows you to find information on the web as well as items and information on your phone by speaking your search terms.



1. Tap  on the Google Search Widget.
2. Speak clearly into the phone's microphone when you see **Listening...** on the screen. If an error occurs, try again.

3. Tap a matching item from the onscreen list.

Eco Mode

The Eco Mode allows you to save battery life while using your phone.

1. From the Home screen, tap **Apps**  > **Tools** > **Eco Mode**.
2. Tap an option to enable or disable the Eco Mode:
 - **ON:** Enables the Eco Mode. The Eco Mode On icon  appears on the status bar when selected.
 - **OFF:** Disables the Eco Mode.
3. Tap  to configure the following options. Tap the following items to place or clear a check mark in the adjacent check box:
 - **Sleep** to sleep after 15 seconds. Tap  to change the time to elapse before entering sleep mode.
 - **Brightness** to decrease the display brightness. Tap  to change the Brightness settings.
 - **Auto-rotate screen** to turn off automatic screen rotation.
 - **Wi-Fi** to set it OFF.
 - **Bluetooth** to disable it.
 - **Location access** to disable it.
 - **NFC (Reader/Writer, P2P)** to disable it.
 - **CPU clock** to restrict it.
 - **Data communication** to disable mobile data communication.
 - **Exchange account** to disable Sync settings in Exchange account.

Note: Tap  > **Auto set** to set the time of the day and battery level at which Eco Mode turns on automatically. Tap  to display the information for Eco Mode.

Configured settings in the Eco Mode are automatically reflected in the respective Settings menu, and vice versa.

Bluetooth

Bluetooth is a short-range communications technology that allows you to connect wirelessly to a number of Bluetooth devices, such as headsets and hands-free car kits, and Bluetooth-enabled handhelds, computers, printers, and wireless phones. The Bluetooth communication range is usually approximately 30 feet.

Turn Bluetooth On or Off

Use the settings menu to enable or disable your phone's Bluetooth capabilities.

1. From the Home screen, tap **Apps**  > **Settings** > **Connected devices** > **Bluetooth**.
2. Tap the **OFF** icon next to **Bluetooth** to turn Bluetooth on.

– or –

Tap the **ON** icon next to **Bluetooth** to turn Bluetooth off.

Note: Turn off Bluetooth when not in use to conserve battery power, or in places where using a wireless phone is prohibited, such as aboard an aircraft and in hospitals.

The Bluetooth Settings Menu

The Bluetooth settings menu gives you access to information and controls for your phone's Bluetooth feature.

- ▶ From the Home screen, tap **Apps**  > **Settings** > **Connected devices** > **Bluetooth**.
 - Tap **Pair new device** to try pairing with a new device.
 - Tap **Device name** to rename your phone.
 - Tap **Received files** to see Bluetooth received Transfer history.
 - Phone's Bluetooth address is shown at the bottom of this screen.

Change the Phone Name

The phone name identifies your phone to other devices.

1. From the Home screen, tap **Apps**  > **Settings** > **Connected devices**.
2. If Bluetooth is not switched on, tap the **OFF** icon to turn Bluetooth on.
3. Tap > **Bluetooth** > **Device name**.
4. Enter the name for your phone in the dialog box, and then tap **RENAME**.



Connect a Bluetooth Headset or Car Kit

You can listen to music over a Bluetooth stereo headset, or have hands-free conversations using a compatible Bluetooth headset or car kit. It's the same procedure to set up stereo audio and hands-free devices.

To listen to music with your headset or car kit, the headset or car kit must support the A2DP Bluetooth profile.

Important: Perform the pairing process at a secure location.

Important: It is recommended to use a passcode of at least eight digits for pairing with a device without a pre-defined PIN.

1. From the Home screen, tap **Apps**  > **Settings** > **Connected devices** > **Bluetooth**.
2. If Bluetooth is not switched on, tap the **OFF** icon to turn Bluetooth on. Your phone will show a list of nearby Bluetooth devices.
3. Tap > **Pair new device**.
 - Make sure that the headset is discoverable, so that your phone can find the headset. Refer to the instructions that came with the headset to find out how to set it to discoverable mode.
4. When you see the name of your headset displayed on the **Available devices** list, tap the name. Your phone then automatically tries to pair with the headset.
5. If necessary, tap **PAIR** or enter the passcode supplied with your headset.
 - Tap  next to the paired device to display the information of the device. To change the name, edit the name and then tap **OK**.

The pairing and connection status is displayed below the hands-free headset or car kit name in the Bluetooth devices section. When the Bluetooth headset or car kit is connected to your phone, the Bluetooth connected icon  is displayed in the status bar. Depending on the type of headset or car kit you have connected, you can then start using the headset or car kit to listen to music or make and receive phone calls.

Note: Due to different specifications and features of other Bluetooth-compatible devices, display and operations may be different, and functions such as transfer or exchange may not be possible with all Bluetooth-compatible devices.



Reconnect a Headset or Car Kit

When you have paired a headset with your phone, you should be able to reconnect it automatically by turning on Bluetooth on your phone and then turning on the headset. However, sometimes you will need to reconnect manually, for example if you have been using your headset with another Bluetooth device.

1. From the Home screen, tap **Apps**  > **Settings** > **Connected devices** > **Bluetooth**.
2. If Bluetooth is not switched on, tap the **OFF** icon to turn Bluetooth on.
3. Make sure that the headset is discoverable.
4. Tap the headset's name in the Paired devices list.
5. If prompted to enter a passcode, try 0000 or 1234, or consult the headset or car kit documentation to find the passcode.
6. If you still cannot reconnect to the headset or car kit, follow the instructions in [Unpair from a Bluetooth Device](#) to follow, and then follow the instructions in [Connect a Bluetooth Headset or Car Kit](#).

Unpair from a Bluetooth Device

You can make your phone forget its pairing connection with another Bluetooth device. To connect to the other device again, you may need to enter or confirm a passcode again.

1. From the Home screen, tap **Apps**  > **Settings** > **Connected devices** > **Bluetooth**.
2. On the **Paired devices** list, tap  next to the device to unpair.
3. Tap **FORGET**.



Send and Receive Information Using Bluetooth

You can use Bluetooth to transfer information between your phone and another Bluetooth-enabled device such as a phone or notebook computer. The first time you transfer information between your phone and another device, you need to enter or confirm a security passcode. After that, your phone and the other device are paired, and you will not need to exchange passcodes to transfer information in the future.

Send Information from Your Phone to Another Device

You can send the following types of information, depending on the device you are sending to:

- Images and videos
 - Contacts
1. Set the receiving device to discoverable mode. You may also need to set it to "Receive Beams" or "Receive Files". Refer to the device's documentation for instructions on receiving information over Bluetooth.
 2. On the phone, open the application that contains the information or file you want to send.
 3. Follow the steps for the type of item you want to send:

- **Picture or video** (in Camera): After taking a picture or video, tap the thumbnail and then tap  > **Bluetooth**.
 - **Pictures and videos** (in Photos): On the Albums screen, tap an album. Touch and hold a picture or video to place a check mark on it. Tap multiple pictures and videos to select them. Tap  > **Bluetooth**.
 - **Contacts**: Display a contact and tap  > **Share** > **Bluetooth**.
4. If you are prompted to turn on Bluetooth, tap **TURN ON**.
 5. Tap the name of the receiving device.
 6. If prompted, accept the connection on the receiving device, and enter the same passcode on both your phone and the other device, or confirm the auto-generated passcode.
 7. On the receiving device, accept the file.

Receive Information from Another Device

Your phone is capable of receiving a wide variety of file types with Bluetooth, including pictures, videos, or contacts.

1. From the Home screen, tap **Apps**  > **Settings** > **Connected devices** > **Bluetooth**.
2. If Bluetooth is not switched on, tap the **OFF** icon to turn Bluetooth on.
3. Keep this screen open to make your phone visible to unpaired devices.
4. On the sending device, send one or more files to your phone. Refer to the device's documentation for instructions on sending information over Bluetooth.
5. If prompted, enter the same passcode on both your phone and the other device, or confirm the auto-generated passcode. A Bluetooth authorization request is displayed on your phone. Tap **OK**.
6. When your phone receives a file transfer request notification, slide down the Notifications panel, tap the notification, and then tap **ACCEPT**.
7. When a file is transferred, a notification is displayed. To open the file immediately, slide down the Notifications panel, and then tap the relevant notification.

Supported Bluetooth Profiles

Following Bluetooth profiles are supported.

- **HSP**: Headset Profile

- **HFP:** Hand-free Profile
- **SPP:** Serial Port Profile
- **OPP:** Object Push Profile
- **PBAP:** Phone Book Access Profile
- **AVRCP:** Audio Video Remote Control Profile
- **GOEP:** Generic Object Exchange Profile
- **MAP:** Message Access Profile
- **HID:** Human Interface Device Profile
- **PAN:** Personal Area Networking Profile
- **A2DP:** Advanced Audio Distribution Profile
- **GATT:** Generic Attribute Profile
- **AVDTP:** Audio/Video Distribution Profile
- **AVCTP:** Audio/Video Control Transport Protocol Profile
- **GAVDP:** Generic Audio/Video Distribution Profile
- **HOGP:** HID over GATT Profile
- **DID:** Device ID Profile

Near Field Communication (NFC) Technology

NFC (Near Field Communication) technology is a short-range, wireless technology that lets you quickly and wirelessly exchange information between your phone and other NFC-enabled smartphones, smart accessories, and NFC-enabled access points. You can also use NFC technology to save, view, create, or change smart tags.

Depending on the applications that you have added to your phone, you might be able to use your phone as a transit pass or as an access pass, by tapping the back of your phone against an NFC-enabled access point, subject to applicable terms and conditions from the particular vendor.

Turn NFC On or Off

Use the settings menu to enable or disable your phone's NFC capabilities.

1. From the Home screen, tap **Apps**  > **Settings** > **Connected devices**.

2. Tap the **OFF** icon next to **NFC** to turn NFC on. If a security reminder appears, read it and tap **OK**.

– or –

Tap the **ON** icon next to **NFC** to turn NFC off.

The NFC Settings Menus

1. From the Home screen, tap **Apps**  > **Settings** > **Connected devices** > **NFC**.
2. Tap > **Security reminders about NFC** or check the checkbox next to Security reminders about NFC to display security reminders for using the NFC feature.

Warning: Turning off security reminders will allow any NFC touchpoint your phone taps to send you information or change your phone settings without asking you for permission.

Android Beam

With Android Beam you can beam app content such as Browser pages, YouTube videos, and Contacts entries, to another NFC-capable device by holding the devices close together.

To turn Android Beam on or off:

1. From the Home screen, tap **Apps**  > **Settings** > **Connected devices**.
2. Tap the **OFF** icon next to **NFC** to turn NFC on, if it is off.
3. Tap > **Android Beam**.
4. Tap the **OFF** icon to turn Android Beam on.

– or –

Tap the **ON** icon to turn Android Beam off.

To share app contents:

1. With Android Beam turned on, display the contents you want to share on your screen.
2. Bring your phone close to another NFC-enabled device, typically back to back aiming the NFC antenna, and then tap your screen. The app determines what gets beamed.



microSD Card

A microSD™ card is an optional accessory that allows you to store images, videos, music, documents, and voice data on your phone. Your phone supports a microSD card up to 400 GB.

Insert or Remove a microSD Card

Inserting a compatible microSD card into your phone will increase the storage capacity.

Note: microSD cards are sold separately.

To insert a microSD card:

1. With the phone facing down, open the SIM/microSD card slot cover.

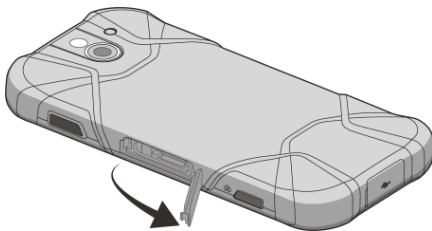

2. Hook your fingernail on the rib on the tray's top edge and pull it out.

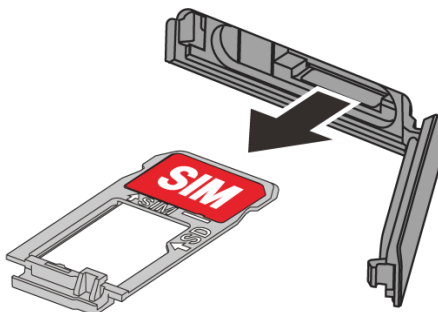

3. Put the tray onto a flat surface and place a microSD card into the tray with the gold contacts facing down as shown.

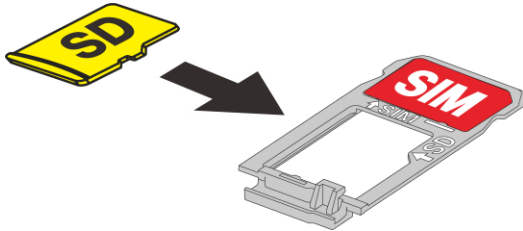

4. Insert the tray into the phone, being careful not to let the cards slide out. Then gently push the tray in until it clicks.

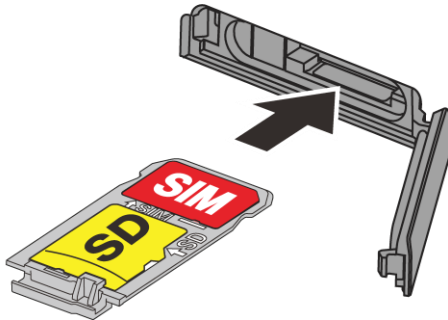

5. After the tray is all the way back in your phone, securely close the card slot cover.

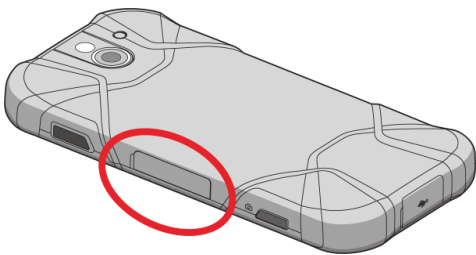

Note: Make sure the SIM/microSD card slot cover is securely closed to maintain your phone's waterproof seal.

Warning: Do not use the phone under water with a broken or open SIM/microSD card slot cover, USB/Charger port cover or headset jack cover.

To remove a microSD card:

1. With the phone facing down, open the SIM/microSD card slot cover.
2. Hook your fingernail on the rib on the tray's top edge and pull it out.

3. Put the tray onto a flat surface and remove the microSD card from the tray.
4. Insert the tray into the phone, being careful not to let the card slide out. Then gently push the tray in until it clicks.
5. Securely close the card slot cover.

Note: You can easily damage the microSD card by improper operation. Please be careful when inserting, removing, or handling the microSD card.

Note: Make sure your battery is fully charged before using the microSD card. Your data may become damaged or unusable if the battery runs out while using the microSD card.

Note: Make sure the SIM/microSD card slot cover is securely closed to maintain your phone's waterproof seal.

Warning: Do not use the phone under water with a broken or open SIM/microSD card slot cover, USB/Charger port cover or headset jack cover.



View the microSD Card Memory

The Storage settings menu gives you access to your microSD card memory information.

1. With the microSD card installed, tap **Apps**  > **Settings** > **Storage** > **SD card**.
2. The information of the SD card is displayed.

Format the microSD Card



Formatting a microSD card permanently removes all files stored on the card.

1. From the Home screen, tap **Apps**  > **Settings** > **Storage**.
2. Tap **SD card** >  > **Storage Settings** > **Format** or **Format as internal** > **ERASE & FORMAT** > **OK**.
 - **Format:** Select to format your SD card.
 - **Format as internal:** Select to use as internal storage for this device only. After formatting, the SD card will only work in this device.

Note: The formatting procedure erases all the data on the microSD card, after which the files CANNOT be retrieved. To prevent the loss of important data, please check the contents before you format the card.

Unmount the microSD Card

Unmount the microSD card to prevent corrupting the data stored on it or damaging the microSD card.

1. From the Home screen, tap **Apps**  > **Settings** > **Storage**.
2. Tap the eject icon .

Use the Phone's microSD Card as a Media Device

You can connect your phone as a media device to your computer.

1. Connect the phone to your computer using the supplied USB cable.
2. Tap **ALLOW** when displayed the message asking for the access to your data.
3. On your computer, the connected phone is recognized as a portable media device. Navigate to the device and select **SD card**.

Note: Once you format your SD card as internal storage, **SD card** may not be displayed.



4. Manage the data as you wish, unmount the phone as required by your computer's operating system to safely remove your phone, and disconnect the phone from the computer.

File Commander

With the File Commander application, you can manage the contents stored in the phone or on the microSD card (optional) quickly and easily.

Note: This feature is not available on all models.

To open the File Commander:

1. From the Home screen, tap **Apps**  > **Tools** > **File Commander**.
2. The following options are available.
 - **Pictures:** Stores still image files.
 - **Music:** Stores the audio files.
 - **Videos:** Stores video files.
 - **Documents:** Stores document files.
 - **Downloads:** Stores downloaded files.
 - **PC File transfer:** Transfers files to the PC through Wi-Fi.
 - : Opens Add Category list where you can choose which categories to be shown on the Home screen. Tap the category to check or uncheck it. If a category is

checked, it will be shown on the home screen. If not checked, it won't appear on home screen.

- **Internal storage:** Displays the current status of the internal storage.
- **SD card:** Displays the current status of the microSD card.

Note: Once you format your SD card as internal storage, **Internal storage** or **SD card** may not be displayed.

To manage the contents (available options may vary):

- ▶ Tap a folder or file to access it. You can search or sort in the folder and file lists.
- ▶ Tap  for available options.

Supported Formats

Following image, video and audio formats are supported by the phone.

Image	Video	Audio	
• BMP	• H.263	• AAC	• MP3
• GIF	• H.264	• AAC+	• Vorbis
• JPEG	• MPEG-4	• eAAC+	• PCM (WAVE)
• PNG	• VP8	• AMR-WB	• Opus
• WEBP	• VP9	• AMR-NB	• QCELP
		• FLAC	
		• MIDI	

Outdoor Portal

The Outdoor Portal offers useful apps which provide important and interesting information for your outdoor activities. It also has shortcut buttons to access handy tools, such as compass, barometer or altimeter.

Note: This feature is not available on all models.

1. From the Home screen, tap **Apps**  > **Outdoor** > **Outdoor Portal**.
2. Tap **NEXT** on the welcome screen and follow the on-screen prompts.
3. The following information is available:
 - **WEATHER:** Displays the weather information in 6 hour increments.
 - **COMPASS:** Displays detailed Compass information.

- **BAROMETER:** Displays detailed Barometer information.
- **BAROMETER WEATHER:** Displays detailed Barometer weather information.
- **TIDE:** Displays the tide level according to the Moon phases.
- **FISH INDEX:** Displays the peak activities of fish according to the Moon phases.
- **SUNRISE/SUNSET:** Displays the sunrise/sunset time at the current location.
- **MOONRISE/MOONSET:** Displays the moonrise/moonset time at the current location.
- **SOLUNAR:** Displays the peak activities of animals and wildlife according to the Moon phases.

Settings

The following topics provide an overview of items you can change using your phone's **Settings** menus.

Network & Internet

You can set up a function or change the settings of the features related to Network and Internet such as Wi-Fi, mobile, data usage, and so on.

Wi-Fi Settings

The Wi-Fi settings menu lets you turn Wi-Fi on or off, set up and connect to available Wi-Fi networks, and configure advanced Wi-Fi options. For more information about the Wi-Fi settings, see [Wi-Fi](#).

Cellular network settings

The Cellular networks options let you enable your phone's mobile data access, set your preferred network mode, and select network operators for international use.

Data roaming access

You can select the way in which your phone uses the data service while you are outside the US.

1. From the Home screen, tap **Apps**  > **Settings** > **Network & Internet** > **Cellular networks** > **Data roaming access**.
2. Read the message carefully and select an option:
 - **Deny data roaming access:** Select if you never use data while you are roaming outside the US.
 - **Allow access only for this trip:** Select if you use data only on this occasion.
 - **Allow access for all trips:** Select if you use data while you are roaming outside the US.
3. Tap **OK**.

Roaming

You can view your roaming status.

- ▶ From the Home screen, tap **Apps**  > **Settings** > **Network & Internet** > **Cellular networks** > **Roaming**.

Network mode

You can review your preferred network mode with this menu.

1. From the Home screen, tap **Apps**  > **Settings** > **Network & Internet** > **Cellular networks** > **Network mode**.
2. See **LTE/UMTS/GSM** is displayed and tap **CANCEL** to close the message window.

Signal strength

You can view the type and the strength of the signal your phone is receiving.

- ▶ From the Home screen, tap **Apps**  > **Settings** > **Network & Internet** > **Cellular networks** > **Signal strength**.

Automatically select network

1. From the Home screen, tap **Apps**  > **Settings** > **Network & Internet** > **Cellular networks**.
2. Tap the **ON/OFF** icon to turn Automatically select network on.

- or -

Tap **Automatically select network**.

Network



You can select how your phone roams in the CDMA network when Automatically select network is set to OFF.

1. From the Home screen, tap **Apps**  > **Settings** > **Network & Internet** > **Cellular networks** > **Network**.
2. Select a roaming network.

Access Point Names

You can edit existing access points or add a new point.

To edit an existing access point:

1. From the Home screen, tap **Apps**  > **Settings** > **Network & Internet** > **Cellular networks** > **Access Point Names**.
2. Tap  next to an access point you want to edit.
3. Edit the necessary fields and tap  > **Save**.

To restore the default settings:

1. From the Home screen, tap **Apps**  > **Settings** > **Network & Internet** > **Cellular networks** > **Access Point Names**.
2. Tap **⋮** > **Reset to default** > **CONTINUE**.

Data Usage Settings

The Data usage menu lets you view and manage your phone's data usage.

Set data usage warning

1. From the Home screen, tap **Apps**  > **Settings** > **Network & Internet** > **Data usage**.
2. Tap **Usage** to set data usage warning and tap **SET**.

Data Saver

To help reduce data usage, Data saver prevents some apps from sending or receiving data in the background.

1. From the Home screen, tap **Apps**  > **Settings** > **Network & Internet** > **Data usage** > **Data saver**.
2. Tap the **ON/OFF** icon to turn on.
3. If you want, tap **Unrestricted data access** to select apps to use unrestricted data when Data Saver is on.
 - When your data usage reaches the limit, mobile data will be turned off automatically.

Turn Mobile Data On or Off

1. From the Home screen, tap **Apps**  > **Settings** > **Network & Internet** > **Data usage**.
2. Tap the **ON/OFF** icon next to **Mobile data access** to turn it on or off.

Mobile data usage

Shows the used gigabyte/megabyte in a billing cycle.

Billing cycle

Set a targeting date of each month to reset date for the usage cycle, data warning, and data limit.

Warning: The usage displayed is measured by your phone. Your carrier's data usage accounting may differ and the usage in excess of your data limit plan can result

in charges. The data usage limit set in this menu is not guaranteed to prevent additional charges.

To set Usage cycle reset date:

1. From the Home screen, tap **Apps**  > **Settings** > **Network & Internet** > **Data usage** > **Billing cycle** > **Billing cycle**.
2. Select Usage cycle reset date and tap **SET**.



To set data warning: When your cellular data usage reaches the warning amount, your phone will alert you.

1. From the Home screen, tap **Apps**  > **Settings** > **Network & Internet** > **Data usage** > **Billing cycle**.
2. Tap the **ON/OFF** icon next to **Set data warning** to turn it on. Read the message and tap **OK**.
3. Tap **Data warning**.
4. Input the value and then tap **SET**.

To set data limit: When your data usage reaches the limit, mobile data connection will be turned off automatically.

1. From the Home screen, tap **Apps**  > **Settings** > **Network & Internet** > **Data usage** > **Billing cycle**.
2. Tap the **ON/OFF** icon next to **Set data limit** to turn it on. Read the message and tap **OK**.
3. Tap **Data limit**.
4. Input the value and then tap **SET**.

Data Usage Options

1. From the Home screen, tap **Apps**  > **Settings** > **Network & Internet** > **Data usage**.
2. Tap  for the following options:
 - **Cellular networks** to configure cellular network settings.
 - **Display in MB** or **Display in GB** to display the memory in MB or GB.

Wi-Fi data usage

Shows the used gigabyte/megabyte.

1. From the Home screen, tap **Apps**  > **Settings** > **Network & Internet** > **Data usage**.
2. Tap **Wi-Fi data usage** to show you that in graph form.

Note: Carrier data accounting may differ from device accounting.

Network restrictions

Shows the number of network restrictions.

1. From the Home screen, tap **Apps**  > **Settings** > **Network & Internet** > **Data usage**.
2. Tap **Network restrictions** to show you Metered Wi-Fi networks.

Tip: Metered networks are treated like cellular when background data is restricted. Apps may warn before using these networks for large downloads.

Mobile Hotspot & tethering

Mobile Hotspot allows you to turn your phone into a Wi-Fi hotspot. The feature works best when used in conjunction with 4G LTE data services. For details on your phone's Mobile Hotspot settings, see [Mobile Hotspot settings](#).

USB tethering

You can tether your phone to your computer with a USB cable and share your phone's Internet connection with your computer via USB.

1. From the Home screen, tap **Apps**  > **Settings** > **Network & Internet** > **Mobile Hotspot & tethering**.
2. Tap the **ON/OFF** icon next to **USB tethering** to turn it on.



Note: Use of this service requires a subscription. Follow the onscreen instructions to subscribe this service.

Mobile Hotspot

1. From the Home screen, tap **Apps**  > **Settings** > **Network & Internet** > **Mobile Hotspot & tethering**.
2. Tap the **ON/OFF** icon next to **Mobile Hotspot** to turn it on.
 - If your phone's mobile data access is not enabled, you will be prompted to turn it on. Follow the onscreen instructions.
 - The first time you turn it on, you will be prompted to set up Mobile Hotspot.
3. Follow the onscreen instructions.

Note: Use of this service requires a subscription. Follow the onscreen instructions to subscribe this service.

Mobile Hotspot settings

1. From the Home screen, tap **Apps**  > **Settings** > **Network & Internet** > **Mobile Hotspot & tethering** > **Mobile Hotspot settings**.
2. Tap **Set up Mobile Hotspot**.
3. Edit the **Network SSID** (Service Set Identifier) field and then create a new Network SSID name.
4. Tap ▼ in the Security field and verify the security level is set to **WPA2 PSK**.
5. Edit the **Password** field and then enter a new password.
6. Tap ▼ in the Broadcast channel field and select the channel number from the list.
7. Tap **SAVE**.
8. Tap the **ON/OFF** icon next to **Mobile Hotspot** to turn it on, if it is not already enabled.
9. Confirm the Hotspot active icon () appears at the top of the screen.

Note: The best way to keep using the phone as a hotspot is to have it connected to a power supply.

Tip: Once Mobile Hotspot has been turned on, your SSID and password will be displayed under "Mobile Hotspot."

Bluetooth tethering

You can share your phone's Internet connection with Bluetooth devices via Bluetooth.

1. From the Home screen, tap **Apps**  > **Settings** > **Network & Internet** > **Mobile Hotspot & tethering**.
2. Tap the **ON/OFF** icon next to **Bluetooth tethering** to turn it on.
3. Pair your phone with a Bluetooth device. If they are already paired, establish their connection. See [Connect a Bluetooth Headset or Car Kit](#) or [Reconnect a Headset or Car Kit](#) for details. See also [Bluetooth](#).



VPN Settings

A virtual private network (VPN) is a network that uses a public telecommunication infrastructure, such as the Internet, to provide remote offices or individual users with secure access to their organization's network. For more information about the VPN settings, see [Virtual Private Networks \(VPN\)](#).



Airplane mode

Airplane Mode allows you to use many of your phone's features, such as Photos, Camera, and Music, when you are on an airplane or in any other area where making or receiving calls or data is prohibited. When you set your phone to Airplane Mode, it cannot send or receive any calls or access online information.

To turn Airplane Mode on or off from Quick Settings:

1. Slide the status bar down to the bottom of the touchscreen. If necessary, tap  to expand the Quick Settings panel.
2. Tap **Airplane** to turn Airplane mode on or off. To turn on Airplane Mode, read the message and tap **OK**. While in Airplane Mode, the status bar will display .

To turn Airplane Mode on or off in Settings:

1. From the Home screen, tap **Apps**  > **Settings** > **Network & Internet** > **Airplane mode**.
2. Tap the **ON/OFF** icon to turn Airplane mode on or off. To turn on Airplane Mode, read the message and tap **OK**. While in Airplane Mode, the status bar will display .



Wireless emergency alerts

Your phone is compatible with the federally supervised cell phone alert services to send out broadcast SMS messages for public warning:

To display the Emergency Alerts:

- ▶ From the Home screen, tap **Apps**  > **Settings** > **Network & Internet** > **Wireless emergency alerts**.

To configure the Wireless emergency alerts settings:

1. From the Home screen, tap **Apps**  > **Settings** > **Network & Internet** > **Wireless emergency alerts** >  > **Settings**.
2. Following options are available:
 - **Presidential:** Receives an emergency presidential alert. (Presidential is always grayed out [not selectable] and cannot be excluded.)

- **Extreme Alert:** Receives emergency alerts in an extreme emergency situation (an extraordinary threat to life or property).
- **Severe Alert:** Receives emergency alerts in a severe emergency situation (a significant threat to life or property).
- **Amber:** Receives alerts related to missing or endangered children.
- **Spanish Alert:** Receives alerts in Spanish when Spanish alert is issued.
- **Help:** Displays the help information for Emergency Alerts.
- **Cellbroadcast Message:** Receives cellbroadcast message other than Emergency Alerts.
- **Notifications:** Receives notifications when you receive an emergency alert.
- **Sound:** Plays a sound when you receive an emergency alert.
- **Vibrate:** Vibrates your phone when you receive an emergency alert.
- **Cellbroadcast message notification:** Set the sound and vibrate of cellbroadcast message other than wireless emergency alerts.
- **Alert reminder:** Sets how often your phone alerts you: Choose from **Once**, **Every 2 minutes**, **Every 15 minutes**, or **Off**.
- **Emergency notification preview:** Plays a sample emergency alert tone. Tap **STOP** to stop the sound.
- **Speak alert message:** Uses the text-to-speech feature to read out the emergency alert messages.

Advanced Calling

To make Video and Wi-Fi calls with your phone, you must first turn these on.

Video Calling

To turn Video Calling on or off:

1. From the Home screen, tap **Apps**  > **Settings** > **Advanced Calling**.
2. Tap the **ON/OFF** icon or **Video Calling**.
3. Read the message and tap **OK**.

Wi-Fi Calling

To turn Video Calling on or off:

1. From the Home screen, tap **Apps**  > **Settings** > **Advanced Calling** > **Wi-Fi Calling**.
2. Tap the **ON/OFF** icon.

Wi-Fi Calling options:

- **Update Current Emergency Address:** This address will be used by emergency services as your location if you make an emergency (E911) call over Wi-Fi from this phone within the US.
- **When Roaming:** Choose the connection you prefer when outside the (Wi-Fi or Cellular).

Connected devices



Your phone can connect to other devices as follows.

Bluetooth

Your phone's Bluetooth capabilities let you use wireless headsets, send and receive pictures and files, and more. For details on your phone's Bluetooth settings, see [The Bluetooth Settings Menu](#).

Cast

You can connect your phone to devices that support Miracast to share the displayed images via Wi-Fi connection.

1. From the Home screen, tap **Apps**  > **Settings** > **Connected devices** > **Cast**.
2. If Wireless display is not switched on, tap  and select the **Enable wireless display** check box to turn it on. Available devices will be displayed.
3. Select a device you want to connect to from the list.

Note: For more information about wireless display, see the documentation that comes with the Miracast-certified device you wish to use with your phone.

NFC

The NFC (Near Field Communication) settings menu lets you turn NFC on or off. For more information about the NFC settings, see [Near Field Communication \(NFC\) Technology](#).

Android Beam

Android Beam uses the NFC technology. For more information about the Android Beam settings, see [Android Beam](#).

Printing

You can print the data on your phone.

1. From the Home screen, tap **Apps**  > **Settings** > **Connected devices** > **Printing**.
2. Select an available print service and follow the online instructions.

USB

When the USB cable connected, select to use USB for Charging, Supply power, File Transfer (MTP), System Update or Tethering. See [USB Tethering](#).

Display

Adjusting your phone's display settings not only helps you see what you want, but it can also help increase battery life.

Brightness level

1. From the Home screen, tap **Apps**  > **Settings** > **Display**.
2. Drag left or right the brightness slider to adjust the screen brightness.

Adaptive brightness

Adjust your screen's brightness to suit your surroundings.

1. From the Home screen, tap **Apps**  > **Settings** > **Display**.
2. Tap the **ON/OFF** icon next to **Adaptive brightness** to turn it on or off.

Night Light

Tints your screen amber. This makes it easier to look at your screen or read in dim light, and may help you fall asleep more easily.

1. From the Home screen, tap **Apps**  > **Settings** > **Display** > **Night Light**.
2. Tap the **ON/OFF** to turn Night Light on or off.

You can also adjust the intensity by moving a slider from right to left and vice versa.

Tap **Schedule** to set Start time and End time for Night Light.

Wallpaper

Select and assign your phone's background wallpaper. See [Change the Wallpaper](#).

Sleep

Select the delay time before the screen automatically turns off.

1. From the Home screen, tap **Apps**  > **Settings** > **Display** > **Sleep**.
2. Select a time to elapse before entering sleep mode.

Glove touch mode

Glove touch mode automatically detects when you are wearing gloves. In this mode the sensitivity of the screen is increased to improve touch detection through the glove material.

1. From the Home screen, tap **Apps**  > **Settings** > **Display**.
2. Tap the **Glove touch mode** and tap the **ON/OFF** icon to turn it on or off.

Auto-rotate screen

Your phone is capable of automatically changing the orientation of some onscreen content. With this feature, you can view the screen in either portrait or landscape orientation by turning the phone sideways. By default, the screen orientation automatically changes when the phone is rotated.

To deactivate the Auto-rotate screen feature:

1. From the Home screen, tap **Apps**  > **Settings** > **Display**.
2. Tap **ON/OFF** icon to turn **Auto-rotate screen off**.

Font size

Choose the font size of the screen as you like.



1. From the Home screen, tap **Apps**  > **Settings** > **Display** > **Font size**.
2. Select your favorite size.

Display size

1. From the Home screen, tap **Apps**  > **Settings** > **Display** > **Display size**.
2. Drag left or right the slider to adjust the display size.

Screen saver

You can select a screen saver for your phone.

1. From the Home screen, tap **Apps**  > **Settings** > **Display** > **Screen saver**.
 - Tap **Current screen saver** to choose **Clock** or **Photos**.
 - **Clock** to display the phone's analog or digital clock. Tap  and tap **Style** to select the clock style or select the **Night mode** option.
 - **Photos** to display selected images as a slide show. Tap  and select the images to display.
 - Tap **When to start** to choose **While charging** or **Never**.

- Tap **START NOW** to start the screen saver.

Note: You cannot tap **START NOW** if you set to **Never** in **When to start**.

Show battery percentage

Set your phone to display the battery percentage on the status bar.

1. From the Home screen, tap **Apps**  > **Settings** > **Display**.
2. Tap **Show battery percentage** to turn on.

Display quick settings

Set to enable or disable your phone to display the quick settings panel.

1. From the Home screen, tap **Apps**  > **Settings** > **Display**.
2. Tap **Display quick settings** to turn on.

Sound

The Sound settings menu lets you control your phone's sound.

Volume

Configure your phone's volume settings.

1. From the Home screen, tap **Apps**  > **Settings** > **Sound**.
2. Use the sliders to set the volume level for **Media volume**, **Alarm volume**, **Ring volume**, or **Notification volume**.

Tip: You can adjust the ring volume in standby mode (or the hearing volume during a call) using the volume buttons on the left side of your phone.

Also vibrate for calls



Set your phone to ring and vibrate simultaneously.

1. From the Home screen, tap **Apps**  > **Settings** > **Sound**.
2. Tap **Also vibrate for calls** to turn on.

Do Not Disturb preferences

Set the notification function.

1. From the Home screen, tap **Apps**  > **Settings** > **Sound** > **Do Not Disturb preferences**.
2. The following options are available:

- **Priority only allows** to set your priority notification that will make a sound or vibrate based on your current settings.
- **Block visual disturbances** has two settings:
 - **Block when screen is on** to prevent notifications silenced by Do Not Disturb from peeking or popping on the screen. Tap the **ON/OFF** icon to turn on or turn off.
 - **Block when screen is off** to prevent notifications silenced by Do Not Disturb from turning up on the screen. Tap the **ON/OFF** icon to turn on or turn off.
- Automatic rules to set up rules so that your device is automatically silenced during certain times. **Weekend**, **Weeknight**, and **Event** are set up by default and ready for you to customize. **Add more** is also here to create a new automatic rule.
 - To turn it on or off: Tap a rule name and tap the **ON/OFF** icon shown below .
 - To delete: Tap  > **DELETE**.
 - To create a new rule: Tap **Add more** and follow the onscreen prompt.

Phone ringtone

Assign a ringtone to your incoming calls.

1. From the Home screen, tap **Apps**  > **Settings** > **Sound** > **Phone ringtone**.
2. Tap a ringtone from the available list. The ringtone briefly plays when selected.

– or –

Tap **+ Add ringtone** and select a sound data.

3. Tap **OK** to assign the ringtone.

Vibrate pattern

Select a vibrate pattern.

1. From the Home screen, tap **Apps**  > **Settings** > **Sound** > **Vibrate pattern**.
2. Tap a vibrate pattern from the available list. Your phone briefly vibrates when selected.
3. Tap **OK** to assign the vibrate pattern.

Vibrate intensity

Select your phone's vibrate intensity.

1. From the Home screen, tap **Apps**  > **Settings** > **Sound** > **Vibrate intensity**.

2. Tap a vibrate intensity from the list.
 - **Incoming call** to set the vibrate intensity of incoming call.
 - **Notification** to set the vibrate intensity of notification.
 - **Touch and keypress** to set the vibrate intensity of when you touch or press the screen.
3. Tap **OK**.

Default notification sound

Select a sound for notifications.

1. From the Home screen, tap **Apps**  > **Settings** > **Sound** > **Default notification sound**.
2. If the dialog “Complete action using” appears at the bottom of the screen, tap **File Commander** or **Media Storage** > **JUST ONCE** or **ALWAYS**.
3. Select a notification sound:
 - If you select **Media Storage** in step 2, tap a notification sound from the available list. The sound briefly plays when selected. Then tap **OK** to assign the sound.

-- or --

Tap **+ Add ringtone** and select a sound. Then tap **OK** to assign the sound.
 - If you select **File Commander** in step 2, browse sound files from the hierarchy list, and tap the file you want to assign the sound.

Tip: If you choose **JUST ONCE** in step 2, the dialog “Complete action using” will appear the next time. If you choose **ALWAYS** in step 2, then step 2 is skipped the next time.

Default alarm sound

Select a sound for alarms.

1. From the Home screen, tap **Apps**  > **Settings** > **Sound** > **Default alarm sound**.
2. If the dialog “Complete action using” appears at the bottom of the screen, tap **Media Storage** or **File Commander** > **JUST ONCE** or **ALWAYS**.
3. Select an alarm sound:
 - If you select **Media Storage** in step 2, tap an alarm from the available list. The sound briefly plays when selected. Then tap **OK** to assign the sound.

-- or --

Tap **+** **Add ringtone** and select a sound. Then tap **OK** to assign the sound.

- If you select **File Commander** in step 2, browse sound files from the hierarchy list, and tap the file you want to assign the sound.

Tip: If you choose **JUST ONCE** in step 2, the dialog “Complete action using” will appear the next time. If you choose **ALWAYS** in step 2, then step 2 is skipped the next time.

Other sounds and vibrations

Set your phone's notification tone feature with various options.

- ▶ From the Home screen, tap **Apps**  > **Settings** > **Sound**.
 - To turn on or off the listed other sounds and vibrations:
 - Tap the **ON/OFF** icon of the sounds and vibrations name such as **Dial pad tones**, **Screen locking sounds**, etc.
 - To set Emergency tone:
 - Tap **Emergency tone** > **Alert**, **Vibrate**, or **Silent**.

Programmable keys

You can choose what the programmable button and the camera button do for a long press.

PTT key

To assign a function to Programmable button:

1. You may press and hold the programmable button on the side of the phone.

Note: For the first trial to do this, read the message and tap **ASSIGN**.

Tip: Tap **CANCEL** if you do not want to assign any function to the button.

– or –

From the Home screen, tap **Apps**  > **Settings** > **Programmable keys** > **PTT key**.

2. Select a function you want to assign to the button. The assigned function works when you press and hold the button.

Tip: Tap **Do nothing** if you do not want to assign any function to the button.

Note: You can set the Programmable button to wake up your phone by tapping the **ON/OFF** icon next to **Wake up device**. This function will not be available when you select **Do nothing** in step 2.

Camera key

To assign a function to Camera button:

- ▶ From the Home screen, tap **Apps**  > **Settings** > **Programmable keys** > **Camera key**. See [PTT key](#).

Wake up device

1. From the Home screen, tap **Apps**  > **Settings** > **Programmable keys**.
2. Tap the **ON/OFF** icon next to **Wake up device** to turn it on or off.

Apps & notifications

You can configure the settings for the applications and the notifications.

App launch optimization

Automatically optimize the device performance to make your frequently used or favorite apps open quickly.

- ▶ From the Home screen, tap **Apps**  > **Settings** > **Apps & notifications** > **Apps launch optimization**.

- Tap the **ON/OFF** icon to turn App launch optimization on or off.
- Select how to be optimized:

Tap **Learning** if you want it to be optimized based on your daily use.

Note: The apps will be listed as the **Learned apps list**.

- or -

Tap **Manual** if you want it to be optimized based on your favorite apps > your favorite apps > **DONE**.

Note: The apps will be listed as the **Manual selected apps list**.

Notifications

You can modify the notification settings individually for apps.

- ▶ From the Home screen, tap **Apps**  > **Settings** > **Apps & notifications** > **Notifications**.
 - Tap **App notifications** and tap apps you want so that you can modify the notification settings.
 - Tap **On the lock screen** > **Show all notification content** or **Don't show notifications at all**.
 - Tap **Allow notification dots** or the **ON/OFF** icon to turn it on or off.
 - Tap **Default notification sound** to set the default notification sound. See [Default notification sound](#).

App permissions

You can change the permissions that apps can access at any time. Keep in mind turning off permissions may cause apps on your device to lose functionality.

1. From the Home screen, tap **Apps**  > **Settings** > **Apps & notifications** > **App permissions**.
2. Tap the apps permissions you want.
3. Tap the apps that you want to turn the permissions on or off.

Default apps

If you have more than one app that does the same thing, you can pick which app to use by default.

1. From the Home screen, tap **Apps**  > **Settings** > **Apps & notifications** > **Default apps**.
2. Tap the default that you want to change.
3. Tap the apps that you want to use by default.



Special apps access

This menu allows you to access special settings on some apps.

1. From the Home screen, tap **Apps**  > **Settings** > **Apps & notifications** > **Special apps access**.
2. Tap the setting you want.
3. Change the setting as you want.

Battery

Monitor your phone's battery usage through this settings menu. View which functions are consuming your battery's charge and at what percentage.

- ▶ From the Home screen, tap **Apps**  > **Settings** > **Battery**.
 - Tap the large battery picture to see the history details of the battery usage.
 - **Last full charge** shows how long ago the battery was fully charged.
 - **Screen usage since full charge** shows how long the screen has been using the battery since full charge of the battery.
 - Tap **Eco Mode** to access the Eco Mode app screen. See [Eco Mode](#).
 - **Show battery percentage** to display the remaining battery level in percentage next to the battery icon on the status bar. Turn **ON/OFF** by tapping **Show battery percentage** or the **ON/OFF** icon.
 - Tap  for the following menus:
 - **Battery optimization** to reduce the energy needs of your app.
 - **Show full device usage** or **Show app usage** to show the displayed item's battery usage.
 - **Battery charged tone** to sound a notification tone when the battery is fully charged.

Storage

The Storage settings menu lets you manage the storage on your phone and provides options for your microSD card.

Device storage

You can see the availability of the storage space on your phone.

- ▶ From the Home screen, tap **Apps**  > **Settings** > **Storage**.
 - View your phone's total space and the space used by specific features under Internal storage.
 - You may tap an itemized category for additional details.

SD Card

The SD card options let you view the card's size and available space, unmount the card for data protection, and format (erase) the SD card. See [microSD Card](#).

Security & location

The security settings menus let you set encryption options, password visibility, administrator settings, and credential storage options.

Security status

Showing you your apps and device are protected by regularly checks.

Screen lock

The lock screen settings menus allow you to lock your phone's screen and enhance the security feature through various options.

- **None** – No security
- **Swipe** – No security
- **Pattern** – Medium security
- **PIN** – Medium to high security
- **Password** – High security
- **Fingerprint** – Medium security



Important: Highest security level protection (password protection) and frequent change of password are recommended to protect your phone and data from unauthorized access.

Screen lock settings

You can increase the security of your phone by creating a screen lock.

Make pattern visible

You can hide the trace of your pattern as you draw it. This setting appears only when you set **Screen lock type** to **Pattern**.

1. From the Home screen, tap **Apps**  > **Settings** > **Security & location** >  next to **Screen lock**.
2. Tap the **ON/OFF** icon or **Make pattern visible** to turn it on or off.

Automatically lock



Set the time delay to activate the screen lock feature after the device enters sleep mode. This setting is available only when you have enabled one of the lock settings.

1. From the Home screen, tap **Apps**  > **Settings** > **Settings** > **Security & location** >  next to **Screen lock** > **Automatically lock**.

2. Select a time to elapse before the screen locks.



Power key instantly locks

Activate the screen lock feature by pressing the Power button. This setting appears only when you set one of the lock settings.

1. From the Home screen, tap **Apps**  > **Settings** > **Security & location** >  next to **Screen lock**.
2. Tap the **ON/OFF** icon or **Power key instantly locks** to turn Power key instantly locks on or off.



Secure start-up

Set further protect your phone by requiring your **Pattern**, **PIN**, or **Password** before it starts up.

1. From the Home screen, tap **Apps**  > **Settings** > **Security & location** >  next to **Screen lock** > **Secure start-up**.
2. Tap **YES** if prompted and unlock the screen lock if it is set.



On the lock screen

Your phone is capable of showing the notifications on the screen when the phone is locked. See [Apps & notifications](#).

1. From the Home screen, tap **Apps**  > **Settings** > **Security & location** >  next to **Screen lock** > **On the lock screen**.
2. Tap one of the following options: **Show all notification content**, **Hide sensitive notification content**, or **Don't show notifications at all**.



Lock screen message

You can create a desired message to display on the locked screen.

1. From the Home screen, tap **Apps**  > **Settings** > **Security & location** >  next to **Screen lock** > **Lock screen message**.
2. Enter the message into the provided field and tap **SAVE**.



Emergency information

Information you enter here can help first aid and contact with family in an emergency. It is stored on your device only. In addition to from Contacts and anyone can read it from the emergency dialer without unlocking your phone. See [ICE \(In Case of Emergency\)](#).

1. From the Home screen, tap **Apps**  > **Settings** > **Security & location** >  next to **Screen lock** > **Emergency information**.
2. Tap **MY INFO** tab and input your information.

Smart Lock

You can automatically unlock your phone without using your PIN, pattern or password.

1. From the Home screen, tap **Apps**  > **Settings** > **Security & location** >  next to **Screen lock** > **Smart Lock**.
2. The following options are available:
 - **On-body detection:** Allows you to keep your phone unlocked while it's on you.
 - **Trusted places:** Allows you to add a trusted place to keep this device unlocked when you stay in there.
 - **Trusted devices:** Allows you to add a trusted device to keep this device unlocked when connected.
 - **Trusted face:** Allows you to set up Face matching as an option to unlock this device.
 - **Voice Match:** Allows you to have your phone unlock when you do a search with "Ok Google."

Note: The available settings may vary depending on your phone and version of Android.

Fingerprint

Enabling this option requires you to touch the fingerprint sensor to unlock the screen.

Note: Please remove the USB cable prior to registering your fingerprint for authentication.

Note: If you fail fingerprint authentication five times, input your backup PIN, pattern, or password.

Note: Fingerprint cannot be used to unlock the screen after restarting the phone. You must use your backup method, such as pattern, PIN, or password.

Note: The fingerprint sensor is on the Power button. Before using the fingerprint sensor, make sure the Power button and your finger are clean and dry.

Note: The fingerprint recognition performance depends on your usage. The phone may have an issue in registering or recognizing fingerprints that have scars or worn down ridges, or if you have scratches on the sensor surface.

Tip: To improve fingerprint recognition performance, register the fingerprints that are used most often to perform tasks on the phone.

1. From the Home screen, tap **Apps**  > **Settings** > **Security & location** > **Fingerprint**.
2. Read the message and tap **CONTINUE**.
3. Choose your backup screen lock method and tap.
4. Read the message and tap **NEXT**.
5. Touch the tip of your finger on the sensor and lift after you feel a vibration. Repeat it 20 times.
6. If required, name the fingerprint and tap **DONE**.

- or -

Tap **ADD MORE** to add more fingerprint. Repeat the same procedure as above and tap **DONE**.

Location

The location services settings menu lets you decide whether you allow your phone to collect and use the location information.

Important: Your wireless phone can determine its (and your) physical, geographical location ("Location Information") and can associate Location Information with other data. Additionally, certain applications, services and programs are capable of accessing, collecting, storing and using Location Information and disclosing Location Information to others. You should use caution when determining whether or not Location Information should be made available to others and you should review any applicable third party privacy policies before providing access. To limit potential unauthorized access to your Location Information, Wireless phones are preset to E911 only, which will only allow emergency response personnel to locate you if you dial 9-1-1 from your phone. Other wireless devices (such as Broadband Data Cards or devices without a keypad or user interface) may or may not have such limitations and location settings available. By enabling location settings you are permitting third party access to Location Information through software, widgets or peripheral components you choose to download, add or attach to your wireless device or through web access, messaging capabilities or other means and you are authorizing Wireless to collect, use and disclose your Location Information as appropriate to provide you with any location services that you enabled.

1. From the Home screen, tap **Apps**  > **Settings** > **Security & location** > **Location**.
2. Tap the **ON/OFF** icon to turn location on or off.

3. Read the message in the **Location consent** dialog box and, if you agree to it, tap **AGREE**.
4. The following options are available:
 - **Mode** to select the method your phone uses to determine your location.
 - **High accuracy:** Uses GPS, Wi-Fi, Bluetooth or cellular networks to determine location.
 - **Battery saving:** Uses Wi-Fi, Bluetooth or cellular networks to determine location.
 - **Device only:** Uses GPS and device sensors to determine location.

App-level permissions

You can set app level permissions.

1. From the Home screen, tap **Apps**  > **Settings** > **Security & location** > **Location**.
2. Tap **App-level permissions** and tap the app name to set Location permissions.

Note: The app names to be displayed may vary depending on the apps your phone has installed.

Scanning

To improve location by allowing system apps and services to detect Wi-Fi networks or Bluetooth devices at any time.

For Wi-Fi scanning:

1. From the Home screen, tap **Apps**  > **Settings** > **Security & location** > **Location** > **Scanning**.
2. Tap the **ON/OFF** icon or **Wi-Fi scanning** to turn Wi-Fi-scanning on or off.

For Bluetooth scanning:

1. From the Home screen, tap **Apps**  > **Settings** > **Security & location** > **Location** > **Scanning**.
2. Tap the **ON/OFF** icon or **Bluetooth scanning** to turn Bluetooth scanning on or off.

Show passwords

You can display unlock instructions on the locked screen.

1. From the Home screen, tap **Apps**  > **Settings** > **Security & location**.

2. Tap the **ON/OFF** icon or **Show passwords** to turn Show passwords on or off.

Device admin apps

You can enable or disable the authority to be a device administrator of certain applications. If disabled, you will typically lose some functionality in those applications, such as the ability to sync new email or calendar events with your phone.

1. From the Home screen, tap **Apps**  > **Settings** > **Security & location** > **Device admin apps**.
2. To enable or disable the authority to be a device administrator, tap the application and tap **Activate this device admin app** or **Deactivate this device admin app**.

SIM card lock

You can configure your SIM card lock settings.

To lock the SIM card with a PIN:

1. From the Home screen, tap **Apps**  > **Settings** > **Security & location** > **SIM card lock**.
2. Tap the **ON/OFF** icon or **Lock SIM card** to turn Lock SIM card on or off.
3. Enter your SIM PIN and tap **OK**.

To change the SIM PIN:

1. From the Home screen, tap **Apps**  > **Settings** > **Security & location** > **SIM card lock** > **Change SIM PIN**.
2. Enter your current SIM PIN and tap **OK**.
3. Enter a new SIM PIN, tap **OK**, re-enter the new SIM PIN, and tap **OK**.

Encryption & credentials

You can encrypt the data in the SD card installed in your phone. You need to enter the PIN or password for the screen lock for the operation. To set up a PIN or password, see [Screen lock settings](#).

Warning: Do not use the phone or remove the SD card during the encryption and decryption processes as some or all of your data will be lost.

Encrypt Phone

Displays the phone's encryption status.

SD card encryption

You can set your phone to encrypt the data each time it is added to the SD card inserted in your phone.

1. From the Home screen, tap **Apps**  > **Settings** > **Security & location** > **Encryption & credentials** > **SD Card encryption**.
2. Read the message and tap **NEXT**.

Note: Depending on your security settings, the following steps may vary.

3. Enter a PIN or password and tap .
4. Read the message and tap **ENCRYPT**. The data saved in the SD card will be encrypted.
 - Read the message and tap **CANCEL** to cancel the setting.

Credential Storage

These options let you control how your phone accesses and stores secure certificates, passwords, and other credentials.

Storage type

You can see the supported credentials storage type.

Trusted credentials

You can see the trusted credentials on your phone's system.

1. From the Home screen, tap **Apps**  > **Settings** > **Security & location** > **Encryption & credentials** > **Trusted credentials**.
2. Tap an item to read the information.

User credentials

You can view and modify stored credentials.

1. From the Home screen, tap **Apps**  > **Settings** > **Security & location** > **Encryption & credentials** > **User credentials**.
2. Tap an item to read the information.

Install from storage

You can install encrypted certificates from the SD card.

1. From the Home screen, tap **Apps**  > **Settings** > **Security & location** > **Encryption & credentials** > **Install from storage**.
2. Tap an available certificate.
3. Follow the onscreen instructions.

Clear credentials

You can remove all the credentials on your phone.

- ▶ From the Home screen, tap **Apps**  > **Settings** > **Security & location** > **Encryption & credentials** > **Clear credentials** > **OK**.

Trust agents

Manage trust agents for features like Smart Lock.

1. From the Home screen, tap **Apps**  > **Settings** > **Security & location** > **Trust agents**.
2. Tap the **ON/OFF** icon to turn on or off.

Screen pinning

Turn on to keep your current screen in view on your phone.

1. From the Home screen, tap **Apps**  > **Settings** > **Security & location** > **Screen pinning**.
2. Tap the **ON/OFF** icon to turn on or off.

Apps with usage access

Manage what apps have access to app-usage data on your device.

1. From the Home screen, tap **Apps**  > **Settings** > **Security & location** > **Apps with usage access**.
2. Tap an app > Tap **Permit usage access** to turn on.

Accounts

Add and manage all your email, social networking, and picture and video sharing accounts.

Set Up a New Account

1. From the Home screen, tap **Apps**  > **Settings** > **Accounts** > **Add account**
2. Tap an account type such as **Google**, etc.

3. Follow the instructions on the screen to set up an account.
 - Depending on the account type, you may need to enter an email address or user address, password, domain name, or other information. For Corporate accounts, contact your server administrator to determine what information you will need.

Manage Existing Accounts

1. From the Home screen, tap **Apps**  > **Settings** > **Accounts**.
2. Tap the existing accounts shown as Accounts for My info.

Note: Available settings menus vary according to the account type.

- Tap **Account sync** to sync immediately.
- Tap **REMOVE ACCOUNT** to delete the account from your phone.
-

Emergency information

See [ICE \(In Case of Emergency\)](#).

Automatically sync data

1. From the Home screen, tap **Apps**  > **Settings** > **Accounts**.
2. Tap the **ON/OFF** icon or **Automatically sync data** to turn it on or off.
3. Tap **OK**.

Accessibility

The Accessibility menu lets you enable and manage accessibility-related applications.

Volume key shortcut

With this feature on, you can quickly turn on or off one of the available accessibility services by pressing both volume buttons for 3 seconds.

- ▶ From the Home screen, tap **Apps**  > **Settings** > **Accessibility** > **Volume key shortcut**.
 - Tap the **ON/OFF** icon to turn it on or off.
 - Tap **Shortcut service** to select the accessibility service you want to assign.
 - Tap **Allow from lock screen** or the **ON/OFF** icon next to it to turn it on or off.

Downloaded services

This menu provides you with the list of accessibility-related applications. The applications to be displayed may vary depending on the applications your phone installed.

1. From the Home screen, tap **Apps**  > **Settings** > **Accessibility**.
2. Tap the application name and the **ON/OFF** icon to turn it on or off.
3. Tap **OK**.

Select to Speak

Select to Speak reads aloud any text that you can tap on such as documents, emails, text messages, text on websites and text labels throughout the device interface.

1. From the Home screen, tap **Apps**  > **Settings** > **Accessibility** > **Select to Speak**.
2. Tap the **ON/OFF** icon to turn on, read the confirmation message and tap **OK**.
3. Tap **Settings** > **Help & feedback** to show the Help information or to send a feedback.

TalkBack

TalkBack provides spoken feedback to help visually impaired users.

1. From the Home screen, tap **Apps**  > **Settings** > **Accessibility** > **TalkBack**.
2. To turn it on, tap the **OFF** icon, read the confirmation message and tap **OK**.
3. Tap **Settings** to configure its settings.

Note: When TalkBack is turned on, you need to double tap or slide with two fingers, instead of single tap or slide with one finger, to operate the touchscreen.

Text-to-speech output

See [Text-to-Speech](#).

Font size

Select the font size on the screen.

1. From the Home screen, tap **Apps**  > **Settings** > **Accessibility** > **Font size**.
2. Select from **Small**, **Medium**, **Large**, or **Magni**.

Magnification

You can zoom in and out by triple-tapping the screen.

- ▶ From the Home screen, tap **Apps**  > **Settings** > **Accessibility** > **Magnification**.

- Tap **Magnify with triple-tap** > the **ON/OFF** icon to turn it on or off.
- Tap **Magnify with button** > the **ON/OFF** icon to turn it on or off.

Color correction

1. From the Home screen, tap **Apps**  > **Settings** > **Accessibility** > **Color correction**.
2. Tap the **ON/OFF** icon to turn on or off.
3. Tap **Correction mode** to select the mode option.

Color inversion

1. From the Home screen, tap **Apps**  > **Settings** > **Accessibility**.
2. Tap **Color inversion** or the **ON/OFF** icon to turn it on or off.

Large mouse pointer

1. From the Home screen, tap **Apps**  > **Settings** > **Accessibility**.
2. Tap **Large mouse pointer** or the **ON/OFF** icon to turn it on or off.

Switch Access

Switch Access allows you to control your device using configurable key combinations. You can move focus to clickable items and select them.

1. From the Home screen, tap **Apps**  > **Settings** > **Accessibility** > **Switch Access**.
2. To turn it on, tap the **OFF** icon, read the confirmation message and tap **OK**.
3. Tap **Settings** to configure its settings.

Click after pointer stops moving

1. From the Home screen, tap **Apps**  > **Settings** > **Accessibility** > **Click after pointer stops moving**.
2. Tap **ON/OFF** icon to turn on.
3. Tap left or right side of the **Delay before click** slider to set the delay time slower or faster.

Power key ends call

Set the Power button ends call function on or off.

1. From the Home screen, tap **Apps**  > **Settings** > **Accessibility**.
2. Tap **Power key ends call** or the **ON/OFF** icon next to it to turn it on or off.

Auto-rotate screen

1. From the Home screen, tap **Apps**  > **Settings** > **Accessibility**.
2. Tap **Auto-rotate screen** or the **ON/OFF** icon to turn it on or off.

Touch & hold delay

Set the delay time when the screen recognizes the touch and hold operation.

1. From the Home screen, tap **Apps**  > **Settings** > **Accessibility** > **Touch & hold delay**.
2. Select **Short**, **Medium**, or **Long**.

Mono audio

Set the Mono audio on or off.

1. From the Home screen, tap **Apps**  > **Settings** > **Accessibility**.
2. Tap **Mono audio** or the **ON/OFF** icon to turn it on or off.

Captions

You can customize the language and the style of the displayed captions.

1. From the Home screen, tap **Apps**  > **Settings** > **Accessibility** > **Captions**.
2. Tap the **ON/OFF** icon to turn on.
3. Configure the following settings:
 - **Standard options:** Set the standard option for caption, such as **Language**, **Text size**, and **Caption style**.
 - **Custom options:** Set the custom option for texts, background color, or display.

Sound balance

Adjust the sound balance.

1. From the Home screen, tap **Apps**  > **Settings** > **Accessibility** > **Sound balance**.
2. Use the slider to adjust the balance. A sound clip will play when you tap on the slider to adjust the balance.
3. Tap **OK**.

Hearing aids

Set to turn on or off hearing aid compatibility.

1. From the Home screen, tap **Apps**  > **Settings** > **Accessibility**.
2. Tap **Hearing aids** or the **ON/OFF** icon next to it to turn it on or off.

High contrast text

Set the high contrast text function on or off.

1. From the Home screen, tap **Apps**  > **Settings** > **Accessibility**.
2. Tap **High contrast text** to turn on.

Google

You can see your Google Account and various information, such as security, personalization, services related to Google services. See [Apps & Entertainment](#).

System

You can configure the settings for languages, time, and backup.

Languages & Input

Your phone's language and input settings let you select a language for the phone's menus and keyboards, select and configure keyboard settings, configure speech input settings, and more. For details, see [Enter Text](#).

This menu also provides the settings when using voice functions. See [Text-to-Speech](#).

Languages

The language settings menu lets you select an onscreen language and add custom words to your phone's user dictionary.

1. From the Home screen, tap **Apps**  > **Settings** > **System** > **Languages & input** > **Languages**.
2. Select an available language.

Virtual keyboard

You can select the default method you will use when accessing the keyboard.

1. From the Home screen, tap **Apps**  > **Settings** > **System** > **Languages & input** > **Virtual keyboard**.
2. Choose from the following options: Gboard, Google voice typing or Manage keyboards. See [Gboard](#), [Glide Typing](#) and [Google Voice Typing](#).

Note: The settings available may vary depending on your phone and version of Android.



Physical keyboard

You can obtain some keyboard assistance.

1. From the Home screen, tap **Apps**  > **Settings** > **System** > **Languages & input** > **Physical keyboard**.
2. The following options are available:
 - **Show virtual keyboard** to turn it **ON** if you want to keep the virtual keyboard on screen while the physical keyboard is active.
 - **Keyboard shortcuts helper** to display available keyboard shortcuts.

Spell checker

This feature allows you to spell check text as you type it.

1. From the Home screen, tap **Apps**  > **Settings** > **System** > **Languages & input** > **Spell checker**.
2. Tap the **ON/OFF** icon to turn on.
3. Tap **Languages** and choose which language to use for spell-checking.
4. Tap  to configure the settings.

Personal dictionary

You can use the user dictionary option to add new words to the dictionary. See [Add a Word to the User Dictionary](#).

Text-to-speech output

Your phone can convert text into speech in certain downloaded applications. You may select the language you hear or adjust its speed. See [Text-to-Speech](#).

Date & time

Use the Date & time settings menu either to automatically use the network-provided date and time or manually set these values, as well as select time and date format options.

1. From the Home screen, tap **Apps**  > **Settings** > **System** > **Date & time**.
2. Tap **Automatic date & time** to turn off if necessary.
 - If set to **ON**, you cannot set the date or time values manually.
3. Tap **Automatic time zone** to turn off if necessary.

- If set to **ON**, you cannot set the time zone values manually.
- 4. Tap **Set date**. Adjust the month, date, and year by scrolling each value. Tap **OK** when finished.
- 5. Tap **Set time**. Adjust the hour and minute, and select AM or PM by scrolling each value. Tap **OK** when finished.
- 6. Tap **Select time zone**, and then select a time zone from the onscreen list. Scroll down the list to view additional time zones.
- 7. Tap **Use 24-hour format** to turn on to use the 24-hour format.

Backup

Back up your phone's data and settings before resetting your phone.

To set your backup and restore options:

1. From the Home screen, tap **Apps**  > **Settings** > **System** > **Backup**.
2. Tap **Back up to Google Drive** to turn it on.
3. Select your backup and restore options.
 - **Back up to Google Drive:**
 - **Account:** Allows you to set a Google Account for your phone backup.

Reset options

All the data in your phone's internal storage will be reset to default.

Tip: Before performing a factory data reset on your phone, you may want to unmount the microSD card to avoid losing any data you may have stored on it.

For the following reset options:

- **Reset Wi-Fi, mobile & Bluetooth**
 - **Reset app preferences**
1. From the Home screen, tap **Apps**  > **Settings** > **System** > **Reset options**.
 2. Follow the onscreen instruction.

For **Erase all data (factory reset)**: All the data in your phone's internal storage will be reset to default.

1. From the Home screen, tap **Apps**  > **Settings** > **System** > **Reset options** > **Erase all data (factory reset)**

2. Read the factory data reset information, select the **Erase SD card** check box if necessary, and tap **RESET PHONE**.
3. Tap **ERASE EVERYTHING**. Your phone will power down and reset itself, which may take up to 10 minutes.

Note: Deleted data **CANNOT** be retrieved.

Tip: Before performing a factory data reset on your phone, you may want to unmount the microSD card to avoid losing any data you may have stored on it. From the Home screen, tap Apps > Settings > Storage > ▲ to unmount the storage card.

About phone

The About phone menu lets you access important phone information including your phone number, battery status, and view legal information.

- ▶ From the Home screen, tap **Apps**  > **Settings** > **About phone**.
 - **Status:** Battery level, My phone number, IMEI (International Mobile Equipment ID), Up time, etc.
 - **Network:** Signal strength, Service state, IP address, etc.
 - **Hardware info:** Model number, Bluetooth address, Serial number, etc.
 - **Software info:** OS, Software version, Build number etc.
 - **Legal information:** Copyright, license and other legal informations.
 - **Compliance Information:** FCC ID etc.
 - **Safety & Warranty**
 - **User guide**

System updates

You can check for any software updates or the updates status of your phone. You can download and apply updates through the System update menu.

- ▶ From the Home screen, tap **Apps**  > **Settings** > **System updates**.
 - **Check for new system update:** Checks if there is any update for your phone.
 - **Show system update history:** Checks the update history.
 - **Use Software Upgrade Assistant:** Update the software by using Software Upgrade Assistant via USB cable.

- **System Update Status:** Shows whether the updates applied or not.

Drying Procedures

Please see the proper procedures below.

Drying Your Phone

CAUTION! If your phone has been submerged in water, for example to use the camera in Underwater Mode, rinse all surfaces of the phone thoroughly with clean, fresh water before drying.

1. Wipe down all outside surfaces of your phone with a clean lint-free cloth.
2. Pat with a clean dry cloth to remove moisture from speakers, microphones and earpiece. Repeat patting each area about 20 times.

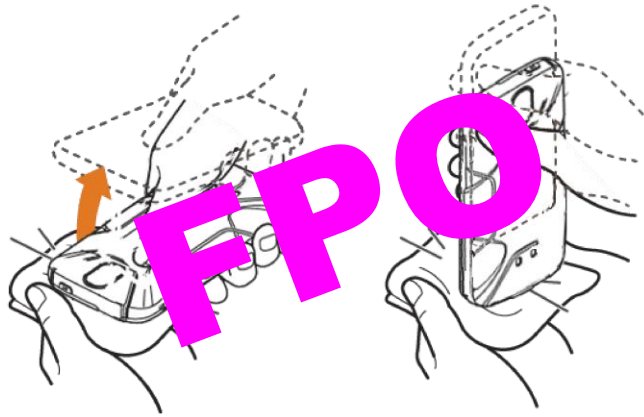

3. After removing all the water, let the phone dry completely at room temperature.

CAUTION! Excessive heat may damage your phone; never use a hair dryer, an oven or any other appliance to dry out your phone.

Note: If your phone still retains some moisture, audio quality and speaker performance may be affected. Dry your phone completely before using it again.

Notes

- Instructions to perform tasks in this guide may change depending on the version of software or application on your phone.
- All screens in this guide are simulated. Actual displays may vary.
- Certain features, services and applications are network dependent and may not be available in all areas; additional terms, conditions and/or charges may apply. Contact your service provider about feature availability and functionality.
- All features, functionality and other specifications, as well as the information contained in this guide are based upon the latest available information and are believed to be accurate at the time of issuing. Kyocera International, Inc. reserves the right to change or modify any information or specifications without notice or obligation.
- For warranty service information, please refer to the Safety and Warranty Information installed in the phone or call the following telephone number from anywhere in the continental United States and Canada: 1-800-349-4478.
- Fingerprint authentication technology does not guarantee completely accurate personal authentication and identification. Kyocera assumes no responsibility for any damages resulting from using your device by a third party or inability to use your device.

Copyright & Trademarks

© 2018 Kyocera Corporation. All rights reserved. KYOCERA is a registered trademark of Kyocera Corporation. All other trademarks are the property of their respective owners.

Android, Google Play, Google Maps, Gmail, YouTube and other marks are trademarks of Google Inc.

The Bluetooth® word mark and logos are registered trademarks owned by Bluetooth SIG, Inc. and any use of such marks by Kyocera Corporation is under license. Other trademarks and trade names are those of their respective owners.

Bluetooth QD ID (Qualified Design ID): 83110

"PhotoSolid®", the image stabilization technology product, is a product of Morpho, Inc.

"PhotoSolid®" is a registered trademark of Morpho, Inc.

"MovieSolid®", the motion video stabilizing technology product, is a product of Morpho, Inc.

"MovieSolid®" is a registered trademark of Morpho, Inc.

"Morpho HDR"™, the high dynamic range technology product, is a product of Morpho, Inc.

"Morpho HDR"™ is a trademark of Morpho, Inc.

"Morpho Panorama Giga Pixel"™, a high resolution panorama image generation technology product, is a product of Morpho, Inc.

"Morpho Panorama Giga Pixel"™ is a trademark of Morpho, Inc.

"Morpho Rapid Effect"™, a visual effect technology product, is a product of Morpho, Inc.

"Morpho Rapid Effect"™ is a trademark of Morpho, Inc.

The biometric fingerprint sensor in this phone is provided by Fingerprint Cards AB containing FPC OneTouch®.



The 'Qi' symbol is a trademark of the Wireless Power Consortium.



microSD, microSDHC and microSDXC Logos are trademarks of SD-3C, LLC.

Index

- 3-Way calling, 34
- Accessibility
 - settings, 135
- Account, 134
 - create, 134
 - manage, 135
- Airplane Mode, 115
- Alarm, 91
- Android Beam, 102
- Application Launcher, 14
- Apps
 - add shortcuts to the Home screen, 15
- Apps & notifications, 124
 - notifications, 124
- Backup, 141
- Battery
 - charge, 4
 - charge wirelessly, 7
 - status information, 126
- Bluetooth, 97
 - change phone name, 97
 - connect, 98
 - receive information, 100
 - reconnect, 98
 - send information, 99
 - settings, 97
 - share pictures and videos, 84
 - supported profiles, 100
 - turn on or off, 97
 - unpair, 99
- Browser, 69
 - bookmarks, 72
 - Chrome menu, 71
 - launch, 67, 69
 - navigation, 70
 - select text on a Web page, 72
- Calculator, 93
- Calendar, 85
 - add an event, 85
 - add reminders, 87
 - create goals, 87
 - delete events, reminders, or goals, 89
 - edit events, reminders, or goals, 88
 - event alerts, 86
 - hide or show, 89
 - invite guests, 86
 - settings, 89
 - synchronize, 90
 - view events, 88
- Call
 - 3-way calling, 34
 - additional settings, 39
 - answer, 30
 - assisted dialing, 40
 - auto answer on headset, 39
 - call forwarding, 35
 - call rejection, 38
 - call timer, 42
 - call waiting, 34
 - caller name ID, 34
 - emergency numbers, 28
 - end, 139
 - from Contacts, 28
 - from the phone dialpad, 27
 - from the Recent calls list, 28
 - hearing aids, 41
 - make, 27
 - numbers with pauses, 29
 - options, 33
 - plus (+) code dialing, 29
 - quick response, 38
 - receive, 30
 - recent calls (call log), 36
 - reject and send a message, 30
 - ringtone, 40
 - send to Voice Mail, 30

- speed dial numbers, 28
- TTY mode, 41
- vibrate, 40
- video calling, 40
- voice mail settings, 40
- Call forwarding, 35
- Call Waiting, 34
- Caller Name ID, 34
- Camera
 - action overlay mode, 77
 - back, 4
 - button, 4
 - flash, 4
 - front, 3
 - settings, 79
 - take picture, 74
 - underwater mode, 78
- Cellular networks, 109
- Charger
 - port, 3
- Cleaning Procedure, 144
 - drying, 144
- Clock, 90
- Contacts, 44
 - add, 45
 - add to Favorites, 49
 - assign message ringtone, 47
 - assign new picture, 47
 - assign phone ringtone, 48
 - assign stored picture, 46
 - delete, 48
 - edit, 46
 - edit group, 50
 - group, 50
 - ICE (in case of emergency), 51
 - list, 44
 - make call from, 28
 - save a phone number, 46
 - share, 47
 - synchronize, 52
- Data services, 67
 - connection status and indicators, 67
- Data usage settings, 111
- Date & Time, 140
- Display
 - adaptive brightness, 118
 - Android Beam, 117
 - battery percentage, 120
 - brightness level, 118
 - cast, 117
 - display size, 119
 - font size, 119, 136
 - glove touch mode, 119
 - quick settings, 120
 - screen saver, 119
 - settings, 118
 - sleep, 118
 - wallpaper, 16
 - when device is rotated, 119
- Drag, 11
- Drying, 144
- Dura Grid, 18
- Eco Mode, 96
- Email, 56
 - access, 56
 - add an account, 56
- Emergency alerts, 115
- Emergency call, 28
- Favorites Tray, 14, 16
- File Commander, 106
- Flashlight, 93
- Flick, 12
- Gboard, 22
 - text mode, 24
 - user dictionary, 24
- Gmail
 - access, 54
 - account settings, 55
 - read and reply, 55
 - send, 54
 - send pictures or videos, 83
- Google Account, 53
 - create, 53
 - sign in to, 54
- Google Maps, 61
- Google Play, 59
 - install apps, 59
 - open apps, 60

- options, 60
- Play Store, 59
- uninstall apps, 60
- Google voice typing, 25
- Headset jack, 3
- Home screen, 13
 - extended, 14, 21
 - manage, 15
 - overview, 13
- Keyboard, 22
 - Gboard, 22
 - glide typing, 25
- Language, 139
- Languages & input settings, 139
- Launcher screens, 19
- LED indicator, 3
- Light sensor, 3
- Location
 - settings, 130
- Message+, 57
 - draft message, 57
- Microphone
 - primary, 3
 - secondary, 3, 4
- microSD card, 103
 - format, 105
 - insert, 103
 - remove, 104
 - unmount, 105
 - use as a media device, 106
 - view the memory, 105
- Mobile Hotspot, 73, 113
- Music, 18, 63
 - Play Music, 63
- NFC, 117
- NFC (Near field communication), 101
 - Android Beam, 102
- Notification
 - icon, 20
 - panel, 20
- Outdoor Portal, 107
- Phone
 - back up, 141
 - illustration, 2
 - information, 142
 - restart, 8
 - restore, 141
 - turn off, 8
 - turn on, 7
- Phone number
 - save to Contacts, 46
- Photos, 80
 - edit pictures, 82
 - open, 81
 - options, 82
 - share pictures and videos, 83
 - view pictures and videos, 81
 - zoom on a picture, 82
- Picture
 - view, 80
- Pinch, 12
- Play Music
 - play, 64
- Plus (+) Code Dialing, 29
- Power button, 3
- Print, 117
- Programmable button, 3
- Programmable keys, 123
- Proximity sensor, 3
- Push To Talk Plus (PTT+), 42
- Quick settings, 21
- Recent calls, 36
 - clear, 37
 - filter, 37
 - view, 36
- Ringtone, 121
 - mute, 30
- Rotate, 12, 119
- Screen lock, 127
 - fingerprint, 129
 - settings, 127
- Security, 127
 - credential storage, 133
 - device administrators, 132
 - encryption, 132
 - SIM card lock, 132
- Settings, 109
- Setup Wizard, 9

- SIM card
 - insert, 5
 - lock, 132
- Slide, 12
- Sound
 - alarm sound, 122
 - also vibrate for calls, 120
 - do not disturb, 120
 - notification sound, 122
 - other sounds and vibrations, 123
 - settings, 120
 - touch dialpad, 40
- Sound & Notification
 - when device is locked, 128
- Sound Recorder, 94
- Speaker, 3
- Speed dialing, 28
 - set up, 35
- Spread, 12
- Status bar, 20
- Status icons, 20
- Stopwatch, 92
- Storage, 126
 - microSD, 105
 - phone, 126
- Swipe, 12
- TalkBack, 136
- Tap, 11
- Tethering, 73
- Text
 - copy and paste, 26
 - enter, 22
- Text Messaging and MMS, 57
 - draft message, 57
 - send pictures or videos, 84
- Text-to-speech, 95
- Timer, 92
- Touch and hold, 11
- Touchscreen, 3
 - keyboards, 22
 - navigation, 11
 - turn off, 8
 - turn on and start, 8
- TTY mode, 41
- Update phone, 142
- USB
 - port, 3
- Vibrate
 - intensity, 121
 - pattern, 121
- Video
 - record video, 74
 - settings, 79
 - view, 80
- Virtual Private Networks (VPN), 68
 - add a connection, 69
 - connect or disconnect, 69
 - install security certificates, 68
 - prepare for a connection, 68
- Voice Mail, 10, 30
 - review, 31
 - set up, 10
 - settings, 32
- Voice Mail (Traditional), 10, 32
 - notification, 32
 - retrieve, 32
 - set up, 10
- Voice search, 95
- Volume, 120
- Volume button, 3
- Wallpaper, 16
- Weather, 17
- Widget
 - add to the Home screen, 15
- Wi-Fi, 65
 - check status, 66
 - connect, 65, 66
 - settings, 66
 - turn on, 65
- World clock, 90
- YouTube, 58
 - share videos, 84