

FCC Test Report

(PART 90R)

Report No.: RF180821C20-11

FCC ID: V65E6910

Test Model: E6910

Received Date: Aug. 21, 2018

Test Date: Sep. 13, 2018 ~ Sep. 19, 2018

Issued Date: Sep. 28, 2018

Applicant: Kyocera Corporation c/o Kyocera International, Inc.

Address: 8611 Balboa Avenue, San Diego, CA 92123

Issued By: Bureau Veritas Consumer Products Services (H.K.) Ltd., Taoyuan Branch

Lab Address: No. 47-2, 14th Ling, Chia Pau Vil., Lin Kou Dist., New Taipei City, Taiwan (R.O.C)

Test Location (1): No. 19, Hwa Ya 2nd Rd, Wen Hwa Vil, Kwei Shan Dist., Taoyuan City 33383, Taiwan (R.O.C)

Test Location (2): No.215, Sec. 3, Beixin Rd., Xindian Dist., New Taipei City 231, Taiwan, R.O.C

**FCC Registration /
Designation Number:** 427177 / TW0011



This report is for your exclusive use. Any copying or replication of this report to or for any other person or entity, or use of our name or trademark, is permitted only with our prior written permission. This report sets forth our findings solely with respect to the test samples identified herein. The results set forth in this report are not indicative or representative of the quality or characteristics of the lot from which a test sample was taken or any similar or identical product unless specifically and expressly noted. Our report includes all of the tests requested by you and the results thereof based upon the information that you provided to us. You have 60 days from date of issuance of this report to notify us of any material error or omission caused by our negligence, provided, however, that such notice shall be in writing and shall specifically address the issue you wish to raise. A failure to raise such issue within the prescribed time shall constitute your unqualified acceptance of the completeness of this report, the tests conducted and the correctness of the report contents. Unless specific mention, the uncertainty of measurement has been explicitly taken into account to declare the compliance or non-compliance to the specification. The report must not be used by the client to claim product certification, approval, or endorsement by TAF or any government agencies

Table of Contents

Release Control Record	4
1 Certificate of Conformity	5
2 Summary of Test Results	6
2.1 Measurement Uncertainty	6
2.2 Test Site and Instruments	7
3 General Information	8
3.1 General Description of EUT	8
3.2 Configuration of System under Test	9
3.2.1 Description of Support Units	9
3.3 Test Mode Applicability and Tested Channel Detail	10
3.4 EUT Operating Conditions	11
3.5 General Description of Applied Standards	11
4 Test Types and Results	12
4.1 Output Power Measurement	12
4.1.1 Limits of Output Power Measurement	12
4.1.2 Test Procedures	12
4.1.3 Test Setup	13
4.1.4 Test Results	14
4.2 Modulation Characteristics Measurement	17
4.2.1 Limits of Modulation Characteristics	17
4.2.2 Test Setup	17
4.2.3 Test Procedure	17
4.2.4 Test Results	18
4.3 Frequency Stability Measurement	19
4.3.1 Limits of Frequency Stability Measurement	19
4.3.2 Test Procedure	19
4.3.3 Test Setup	19
4.3.4 Test Results	20
4.4 Occupied Bandwidth Measurement	22
4.4.1 Limits of Occupied Bandwidth Measurement	22
4.4.2 Test Procedure	22
4.4.3 Test Setup	22
4.4.4 Test Results	23
4.5 Emission Mask Measurement	24
4.5.1 Limits of Band Edge Measurement	24
4.5.2 Test Setup	24
4.5.3 Test Procedures	24
4.5.4 Test Results	25
4.6 Band Edge Measurement	27
4.6.1 Limits of Band Edge Measurement	27
4.6.2 Test Setup	27
4.6.3 Test Procedures	27
4.6.4 Test Results	28
4.7 Conducted Spurious Emissions	34
4.7.1 Limits of Conducted Spurious Emissions Measurement	34
4.7.2 Test Setup	34
4.7.3 Test Procedure	34
4.7.4 Test Results	35
4.8 Radiated Emission Measurement	37
4.8.1 Limits of Radiated Emission Measurement	37
4.8.2 Test Procedure	37
4.8.3 Deviation from Test Standard	37
4.8.4 Test Setup	38

4.8.5 Test Results	39
5 Pictures of Test Arrangements.....	47
Appendix – Information on the Testing Laboratories	48

Release Control Record

Issue No.	Description	Date Issued
RF180821C20-11	Original Release	Sep. 28, 2018

1 Certificate of Conformity

Product: Smart Phone

Brand: Kyocera

Test Model: E6910

Sample Status: Identical Prototype

Applicant: Kyocera Corporation c/o Kyocera International, Inc.

Test Date: Sep. 13, 2018 ~ Sep. 19, 2018

Standards: FCC Part 90, Subpart R
FCC Part 2

The above equipment has been tested by **Bureau Veritas Consumer Products Services (H.K.) Ltd., Taoyuan Branch**, and found compliance with the requirement of the above standards. The test record, data evaluation & Equipment Under Test (EUT) configurations represented herein are true and accurate accounts of the measurements of the sample's RF characteristics under the conditions specified in this report.

Prepared by : , **Date:** Sep. 28, 2018
Ivonne Wu / Supervisor

Approved by : , **Date:** Sep. 28, 2018
Dylan Chiou / Project Engineer

2 Summary of Test Results

Applied Standard: FCC Part 90 & Part 2 (LTE 14)			
FCC Clause	Test Item	Result	Remarks
2.1046 90.542 (a)(7)	Effective Radiated Power	Pass	Meet the requirement of limit.
2.1047	Modulation Characteristics	Pass	Meet the requirement.
2.1055 90.539(e)	Frequency Stability	Pass	Meet the requirement of limit.
2.1049	Occupied Bandwidth (*)	Pass	Meet the requirement of limit.
90.210 (n)	Emission Masks	Pass	Meet the requirement of limit.
2.1053 90.543 (e)(2)(3)	Band Edge Measurements	Pass	Meet the requirement of limit.
2.1051 90.543 (e)(3)	Conducted Spurious Emissions	Pass	Meet the requirement of limit.
2.1053 90.543 (e)(f)	Radiated Spurious Emissions	Pass	Meet the requirement of limit. Minimum passing margin is -16.66 dB at 1586.00 MHz.

2.1 Measurement Uncertainty

Where relevant, the following measurement uncertainty levels have been estimated for tests performed on the EUT as specified in CISPR 16-4-2:

Measurement	Frequency	Expanded Uncertainty (k=2) (±)
Radiated Emissions up to 1 GHz	30 MHz ~ 200 MHz	2.0153 dB
	200 MHz ~ 1000 MHz	2.0224 dB
Radiated Emissions above 1 GHz	1 GHz ~ 18 GHz	1.0121 dB
	18 GHz ~ 40 GHz	1.1508 dB

2.2 Test Site and Instruments

Description & Manufacturer	Model No.	Serial No.	Date of Calibration	Due Date of Calibration
Test Receiver Agilent Technologies	N9038A	MY52260177	Aug. 20, 2018	Aug. 19, 2019
Spectrum Analyzer ROHDE & SCHWARZ	FSU43	101261	Jan. 11, 2018	Jan. 10, 2019
HORN Antenna ETS-Lindgren	3117	00143293	Dec. 13, 2017	Dec. 12, 2018
BILOG Antenna SCHWARZBECK	VULB 9168	9168-616	Dec. 14, 2017	Dec. 13, 2018
HORN Antenna SCHWARZBECK	BBHA 9170	9170-480	Dec. 01, 2017	Nov. 30, 2018
Fixed Attenuator Woken	00801A1GGAM02Y	NA	May 17, 2018	May 16, 2019
MXG Vector signal generator Agilent	N5182B	MY53050430	Oct. 24, 2017	Oct. 23, 2018
Preamplifier Agilent	310N	187226	Jun. 19, 2018	Jun. 18, 2019
Preamplifier Agilent	83017A	MY39501357	Jun. 19, 2018	Jun. 18, 2019
RF signal cable ETS-LINDGREN	5D-FB	Cable-CH1-01(RF C-SMS-100-SMS- 120+RFC-SMS-1 00-SMS-400)	Jun. 19, 2018	Jun. 18, 2019
RF signal cable ETS-LINDGREN	8D-FB	Cable-CH1-02(RF C-SMS-100-SMS- 24)	Jun. 19, 2018	Jun. 18, 2019
Boresight Antenna Fixture	FBA-01	FBA-SIP01	NA	NA
Software BV ADT	E3 8.130425b	NA	NA	NA
Antenna Tower MF	NA	NA	NA	NA
Turn Table MF	NA	NA	NA	NA
Antenna Tower & Turn Table Controller MF	MF-7802	NA	NA	NA
Communications Tester-Wireless Agilent	8960 Series 10	MY53201073	Jun. 28, 2017	Jun. 27, 2019
Radio Communication Analyzer Anritsu	MT8820C	6201010284	Dec. 28, 2017	Dec. 27, 2018

- Note: 1. The calibration interval of the above test instruments is 12 / 24 months and the calibrations are traceable to NML/ROC and NIST/USA.
2. The test was performed in HsinTien Chamber 1.
3. The horn antenna and preamplifier (model: 83017A) are used only for the measurement of emission frequency above 1 GHz if tested.
4. The IC Site Registration No. is IC7450I-1.

3 General Information

3.1 General Description of EUT

Product	Smart Phone	
Brand	Kyocera	
Test Model	E6910	
Status of EUT	Identical Prototype	
Power Supply Rating	3.8 Vdc (Battery) 5 Vdc or 9 Vdc or 12 Vdc (Adapter) 5 Vdc (Host equipment)	
Modulation Type	LTE	QPSK, 16QAM, 64QAM
Frequency Range	LTE Band 14 (Channel Bandwidth: 5 MHz)	790.5 ~ 795.5 MHz
	LTE Band 14 (Channel Bandwidth: 10 MHz)	793 MHz
Emission Designator	LTE Band 14 (Channel Bandwidth: 5 MHz)	4M50W7D
	LTE Band 14 (Channel Bandwidth: 10 MHz)	8M97G7D
Max. ERP Power	LTE Band 14 (Channel Bandwidth: 5 MHz)	128.56 mW
	LTE Band 14 (Channel Bandwidth: 10 MHz)	129.93 mW
Antenna Type	Fixed Internal Antenna with -0.6 dBi gain	
Accessory Device	Refer to Note as below	
Data Cable Supplied	Refer to Note as below	

Note:

1. The EUT's accessories list refers to Ext. Pho.
2. The above EUT information is declared by manufacturer and for more detailed features description, please refers to the manufacturer's specifications or user's manual.

3.2 Configuration of System under Test

<Radiated Emission Test>

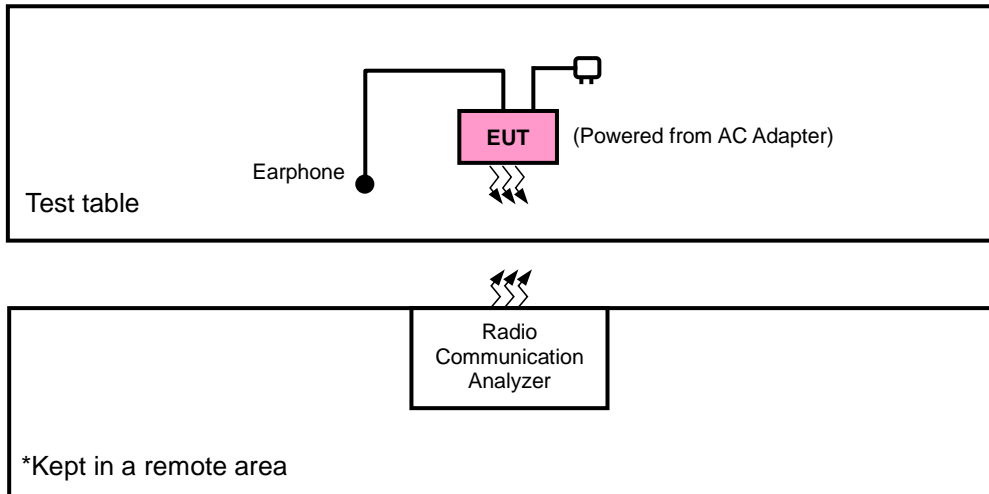

<E.R.P. Test>

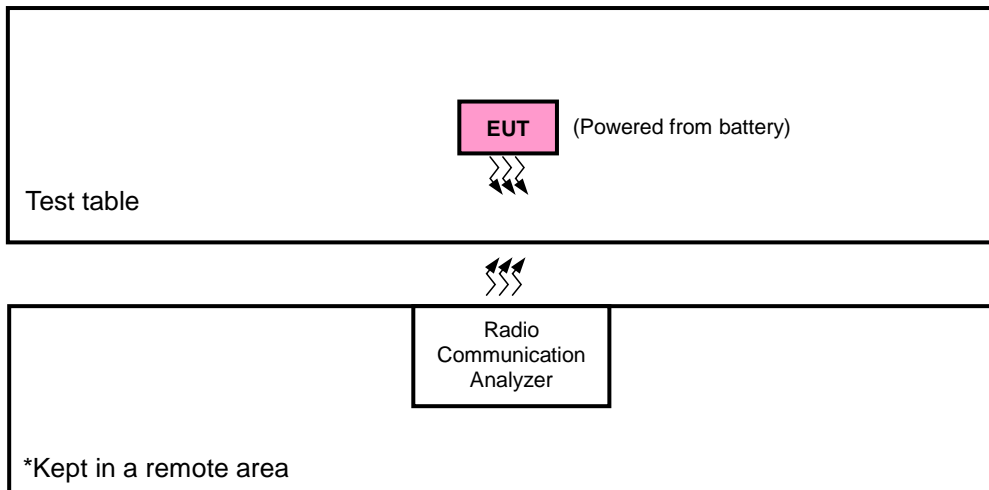

3.2.1 Description of Support Units

The EUT has been tested as an independent unit together with other necessary accessories or support units. The following support units or accessories were used to form a representative test configuration during the tests.

No.	Product	Brand	Model No.	Serial No.	FCC ID
1.	Earphone	Funkey	FK130102	N/A	N/A

No.	Signal Cable Description Of The Above Support Units
1.	N/A

Note:

1. All power cords of the above support units are non-shielded (1.8m).

3.3 Test Mode Applicability and Tested Channel Detail

Pre-Scan has been conducted to determine the worst-case mode from all possible combinations between available modulations, data rates, XYZ axis, and antenna ports

The worst case was found when positioned as the table below. Following channel(s) was (were) selected for the final test as listed below:

Band	ERP	Radiated Emission
LTE Band 14	X-plane	Z-axis

LTE Band 14

EUT Configure Mode	Test Item	Available Channel	Tested Channel	Channel Bandwidth	Modulation	Mode
-	ERP	23305 to 23355	23305, 23330, 23355	5 MHz	QPSK, 16QAM, 64QAM	1 RB / 0 RB Offset
		23330	23330	10 MHz	QPSK, 16QAM, 64QAM	1 RB / 0 RB Offset
-	Modulation Characteristics	23305 to 23355	23330	10 MHz	QPSK, 16QAM, 64QAM	1 RB / 0 RB Offset
-	Frequency Stability	23305 to 23355	23305, 23355	5 MHz	QPSK	1 RB / 0 RB Offset
		23330	23330	10 MHz	QPSK	1 RB / 0 RB Offset
-	Occupied Bandwidth	23305 to 23355	23305, 23330, 23355	5 MHz	QPSK, 16QAM, 64QAM	25 RB / 0 RB Offset
		23330	23330	10 MHz	QPSK, 16QAM, 64QAM	50 RB / 0 RB Offset
-	Emission Mask	23305 to 23355	23305, 23330, 23355	5 MHz	QPSK, 16QAM, 64QAM	25 RB / 0 RB Offset
		23330	23330	10 MHz	QPSK, 16QAM, 64QAM	50 RB / 0 RB Offset
-	Band Edge	23305 to 23355	23305, 23355	5 MHz	QPSK, 16QAM, 64QAM	1 RB / 0 RB Offset 25 RB / 0 RB Offset
		23330	23330	10 MHz	QPSK, 16QAM, 64QAM	1 RB / 0 RB Offset 50 RB / 0 RB Offset
-	Conducted Emission	23305 to 23355	23305, 23330, 23355	5 MHz	QPSK	1 RB / 0 RB Offset
		23330	23330	10 MHz	QPSK	1 RB / 0 RB Offset
-	Radiated Emission	23305 to 23355	23305, 23330, 23355	5 MHz	QPSK	1 RB / 0 RB Offset
		23330	23330	10 MHz	QPSK	1 RB / 0 RB Offset

Note: This device was tested under all bandwidths, RB configurations and modulations. The worst case was found in QPSK modulation.

Test Condition:

Test Item	Environmental Conditions	Input Power	Tested By
ERP	25 deg. C, 65 % RH	3.8 Vdc	Harry Hsueh
Frequency Stability	25 deg. C, 65 % RH	3.8 Vdc	Wayne Lin
Occupied Bandwidth	25 deg. C, 65 % RH	3.8 Vdc	Wayne Lin
Peak to Average Ratio	25 deg. C, 65 % RH	3.8 Vdc	Wayne Lin
Emission Mask	25 deg. C, 65 % RH	3.8 Vdc	Wayne Lin
Band Edge	25 deg. C, 65 % RH	3.8 Vdc	Wayne Lin
Conducted Emission	25 deg. C, 65 % RH	3.8 Vdc	Wayne Lin
Radiated Emission	25 deg. C, 65 % RH	120 Vac, 60 Hz	Harry Hsueh

3.4 EUT Operating Conditions

The EUT makes a call to the communication simulator. The communication simulator station system controlled a EUT to export maximum output power under transmission mode and specific channel frequency

3.5 General Description of Applied Standards

The EUT is a RF Product. According to the specifications of the manufacturer, it must comply with the requirements of the following standards:

FCC 47 CFR Part 2

FCC 47 CFR Part 90

KDB 971168 D01 Power Meas License Digital Systems v03r01

ANSI/TIA/EIA-603-E 2016

ANSI 63.26-2015

Note: All test items have been performed and recorded as per the above standards.

4 Test Types and Results

4.1 Output Power Measurement

4.1.1 Limits of Output Power Measurement

Portable stations (hand-held devices) transmitting in the 758-768 MHz band and the 788-798 MHz band are limited to 3 watts ERP.

4.1.2 Test Procedures

EIRP / ERP Measurement:

- a. All measurements were done at low, middle and high operational frequency range. RBW and VBW is 5 MHz for CDMA and 10 MHz for LTE mode.
- b. Substitution method is used for E.I.R.P measurement. In the semi-anechoic chamber, EUT placed on the 0.8 m (below or equal 1 GHz) and/or 1.5 m (above 1 GHz) height of Turn Table, rotated the table around 360 degrees to search the maximum radiation power and receiver antenna shall be rotated vertical and horizontal polarization and moved height from 1 m to 4 m to find the maximum polar radiated power. The "Read Value" is the spectrum reading the maximum power value.
- c. The substitution horn antenna is substituted for EUT at the same position and signals generator export the CW signal to the substitution antenna via a tx cable. Rotated the Turn Table and moved receiving antenna to find the maximum radiation power. Adjust output power level of S.G to get a Value of spectrum reading equal to "Read Value" of step b. Record the power level of S.G.
- d. $EIRP = \text{Output power level of S.G} - \text{TX cable loss} + \text{Antenna gain of substitution horn}$. E.R.P power can be calculated form E.I.R.P power by subtracting the gain of dipole, $E.R.P \text{ power} = E.I.P.R \text{ power} - 2.15 \text{ dB}$.

Conducted Power Measurement:

- a. The EUT was set up for the maximum power with LTE link data modulation and link up with simulator.
- b. Set the EUT to transmit under low, middle and high channel and record the power level shown on simulator.

4.1.3 Test Setup

EIRP / ERP Measurement:

<Radiated Emission below or equal 1 GHz>

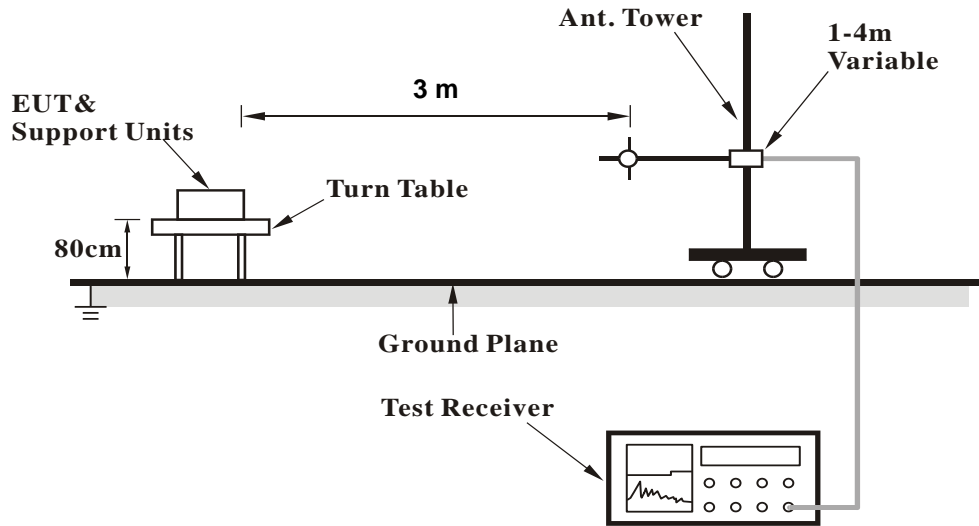

<Radiated Emission above 1 GHz>

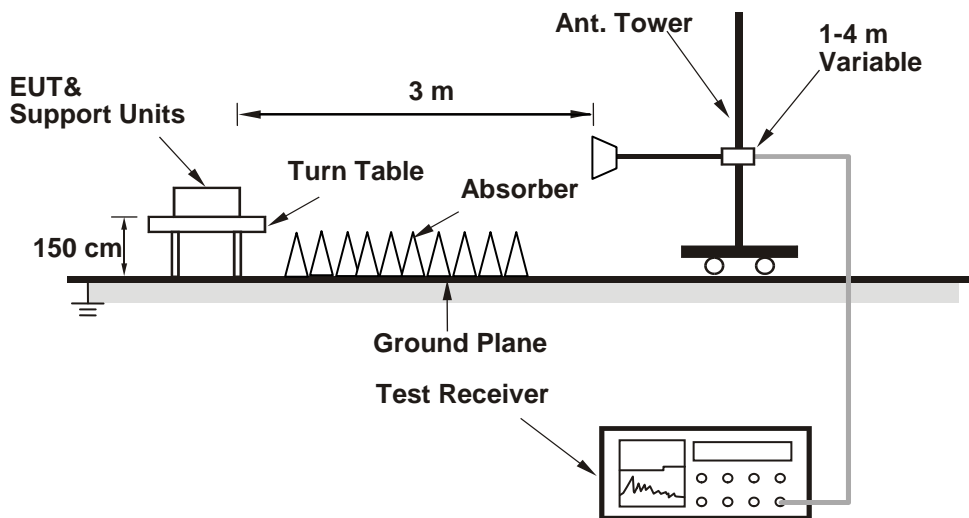

For the actual test configuration, please refer to the attached file (Test Setup Photo).

Conducted Power Measurement:

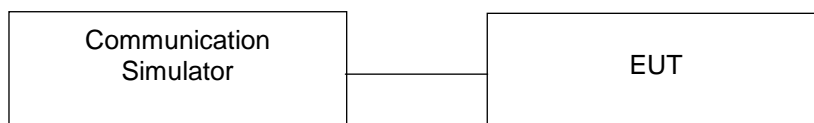

4.1.4 Test Results

Conducted Output Power (dBm)

LTE Band 14																		
BW	MCS Index	RB Size	RB Offset	Mid	3GPP MPR (dB)	BW	MCS Index	RB Size	RB Offset	Low	Mid	High	3GPP MPR (dB)					
														Channel	23330	23355	23330	23355
														Frequency (MHz)	793	795.5	793	795.5
10M	QPSK	1	0	23.47	0	5M	QPSK	1	0	23.46	23.48	23.47	0					
		1	24	23.46	0			1	12	23.46	23.46	23.46	0					
		1	49	23.39	0			1	24	23.42	23.42	23.42	0					
		25	0	22.47	1			12	0	22.42	22.42	22.42	1					
		25	12	22.43	1			12	6	22.46	22.46	22.46	1					
		25	25	22.42	1			12	13	22.42	22.42	22.42	1					
	16QAM	50	0	22.42	1		25	0	22.43	22.43	22.43	1						
		1	0	22.40	1		16QAM	1	0	22.44	22.38	22.45	1					
		1	24	22.39	1			1	12	22.39	22.42	22.45	1					
		1	49	22.39	1			1	24	22.36	22.42	22.36	1					
		25	0	21.48	2			12	0	21.44	21.41	21.44	2					
		25	12	21.48	2			12	6	21.44	21.42	21.46	2					
	25	25	21.44	2	12			13	21.41	21.50	21.42	2						
	64QAM	50	0	21.49	2		25	0	21.45	21.43	21.47	2						
		1	0	21.41	2		64QAM	1	0	21.45	21.38	21.38	2					
		1	24	21.45	2			1	12	21.41	21.38	21.43	2					
		1	49	21.37	2			1	24	21.39	21.35	21.32	2					
		25	0	20.43	3			12	0	20.50	20.46	20.42	3					
		25	12	20.41	3			12	6	20.47	20.45	20.46	3					
	25	25	20.36	3	12			13	20.45	20.46	20.49	3						
	50	0	20.41	3	25		0	20.41	20.50	20.42	3							

ERP Power (dBm)

LTE Band 14							
Channel Bandwidth: 5 MHz / QPSK							
Plane	Channel	Frequency (MHz)	Reading (dBm)	Correction Factor (dB)	ERP (dBm)	ERP (mW)	Polarization (H/V)
X	23305	790.5	-9.54	32.771	21.08	128.26	H
	23330	793.0	-9.50	32.741	21.09	128.56	
	23355	795.5	-9.64	32.854	21.06	127.76	
	23305	790.5	-12.26	32.5	18.09	64.42	V
	23330	793.0	-12.26	32.52	18.11	64.71	
	23355	795.5	-12.40	32.62	18.07	64.12	
Channel Bandwidth: 5 MHz / 16QAM							
X	23305	790.5	-10.55	32.771	20.07	101.65	H
	23330	793.0	-10.50	32.741	20.09	102.12	
	23355	795.5	-10.65	32.854	20.05	101.25	
	23305	790.5	-13.27	32.5	17.08	51.05	V
	23330	793.0	-13.27	32.52	17.10	51.29	
	23355	795.5	-13.42	32.62	17.05	50.70	
Channel Bandwidth: 5 MHz / 64QAM							
X	23305	790.5	-11.56	32.771	19.06	80.56	H
	23330	793.0	-11.51	32.741	19.08	80.93	
	23355	795.5	-11.66	32.854	19.04	80.24	
	23305	790.5	-14.27	32.5	16.08	40.55	V
	23330	793.0	-14.28	32.52	16.09	40.64	
	23355	795.5	-14.43	32.62	16.04	40.18	

Note: ERP (dBm) = Reading (dBm) + Correction Factor (dB) – 2.15

LTE Band 14							
Channel Bandwidth: 10 MHz / QPSK							
Plane	Channel	Frequency (MHz)	Reading (dBm)	Correction Factor (dB)	ERP (dBm)	ERP (mW)	Polarization (H/V)
X	23330	793.0	-9.45	32.737	21.14	129.93	H
	23330	793.0	-13.20	32.52	17.17	52.12	V
Channel Bandwidth: 10 MHz / 16QAM							
X	23330	793.0	-10.46	32.737	20.13	102.97	H
	23330	793.0	-14.21	32.52	16.16	41.30	V
Channel Bandwidth: 10 MHz / 64QAM							
X	23330	793.0	-11.46	32.737	19.13	81.79	H
	23330	793.0	-15.22	32.52	15.15	32.73	V

Note: ERP (dBm) = Reading (dBm) + Correction Factor (dB) – 2.15

4.2 Modulation Characteristics Measurement

4.2.1 Limits of Modulation Characteristics

N/A

4.2.2 Test Setup



4.2.3 Test Procedure

Connect the EUT to Communication Simulator via the antenna connector. The frequency band is set as EUT supported Modulation and Channels, the EUT output is matched with 50 ohm load, the waveform quality and constellation of the EUT was tested.

4.2.4 Test Results

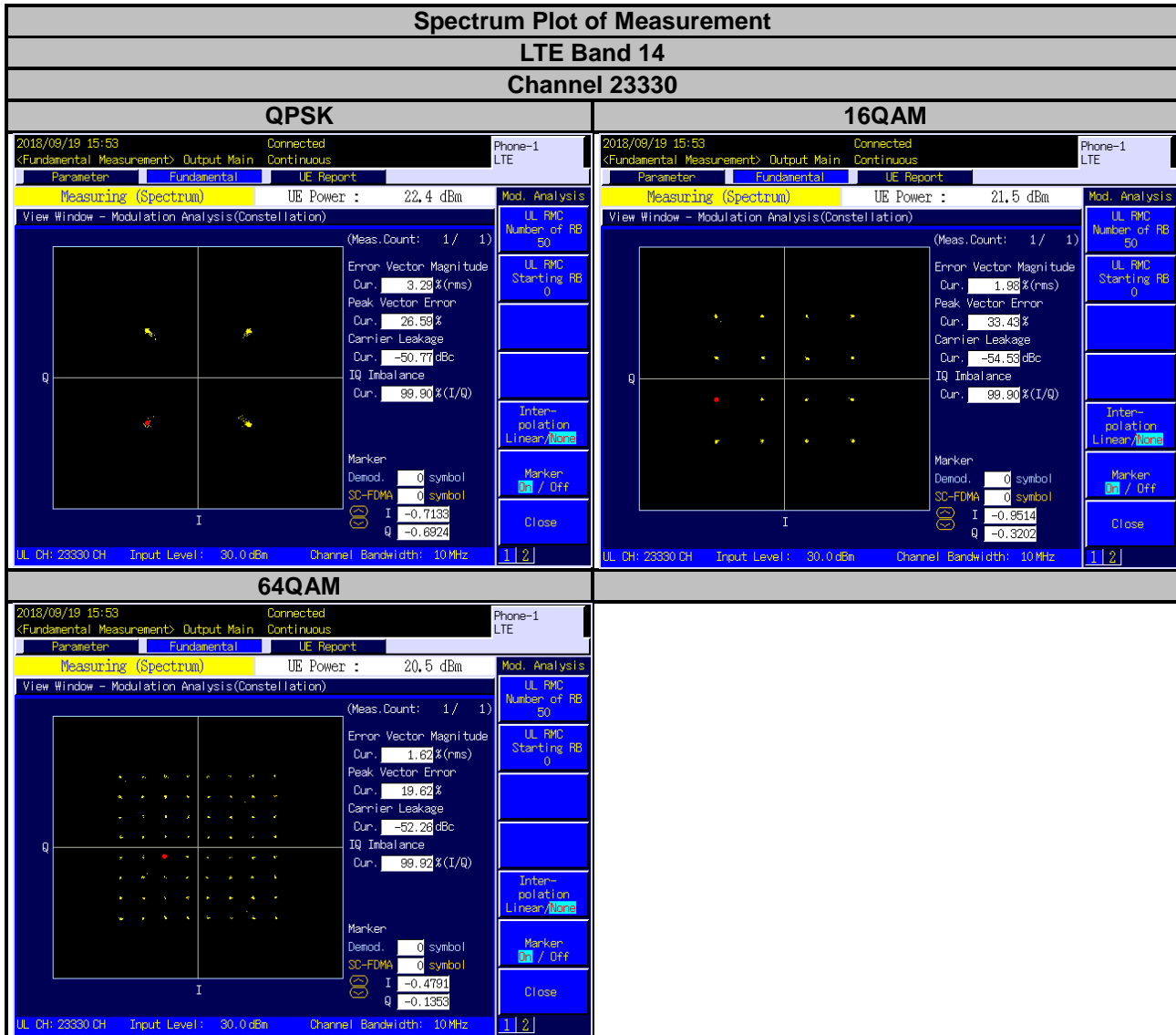

4.3 Frequency Stability Measurement

4.3.1 Limits of Frequency Stability Measurement

LTE Band 14

The frequency stability of mobile, portable and control transmitters operating in the wideband segment must be 1.25 parts per million or better when AFC is locked to a base station, and 5 parts per million or better when AFC is not locked.

4.3.2 Test Procedure

- a. Device is placed at the oven room. The oven room could control the temperatures and humidity. Power warm up is at least 15 min and power applied should perform before recording frequency error.
- b. EUT is connected the external power supply to control the DC input power. The test voltage range is from minimum to maximum working voltage. Each step shall be record the frequency error rate.
- c. The temperature range step is 10 degrees in this test items. All temperature levels shall be hold the ± 0.5 °C during the measurement testing. The each temperature step shall be at least 0.5 hours, consider the EUT could be test under the stability condition.

NOTE: The frequency error was recorded frequency error from the communication simulator.

4.3.3 Test Setup

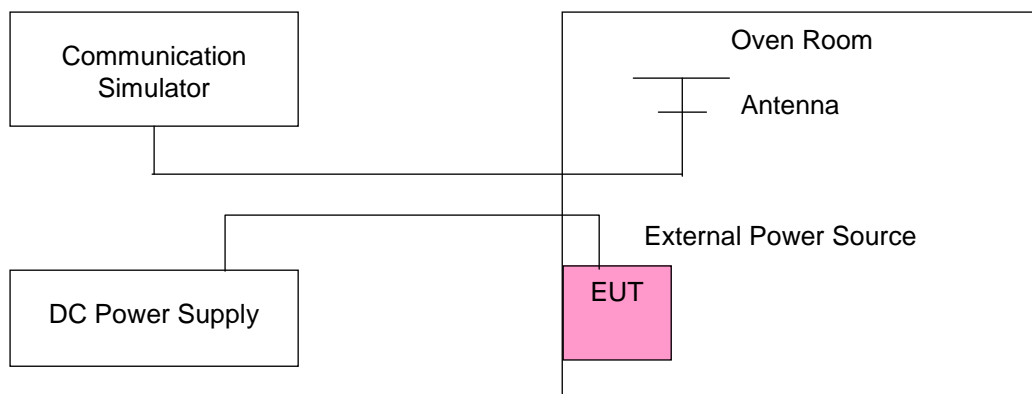

4.3.4 Test Results

Frequency Error vs. Voltage

Voltage (Volts)	LTE Band 14				Limit (ppm)
	Channel Bandwidth: 5 MHz				
	Low Channel		High Channel		
	Frequency (MHz)	Frequency Error (ppm)	Frequency (MHz)	Frequency Error (ppm)	
3.8	790.500003	0.003	795.500003	0.004	2.5
3.23	790.500004	0.005	795.500002	0.002	2.5
4.37	790.500003	0.003	795.500004	0.005	2.5

Note: The applicant defined the normal working voltage of the battery is from 3.23 Vdc to 4.37 Vdc.

Frequency Error vs. Temperature

Temp. (°C)	LTE Band 14				Limit (ppm)
	Channel Bandwidth: 5 MHz				
	Low Channel		High Channel		
	Frequency (MHz)	Frequency Error (ppm)	Frequency (MHz)	Frequency Error (ppm)	
-30	790.500001	0.002	795.500004	0.005	2.5
-20	790.500002	0.002	795.500002	0.003	2.5
-10	790.500002	0.002	795.500001	0.002	2.5
0	790.500002	0.002	795.500003	0.004	2.5
10	790.500003	0.004	795.500004	0.005	2.5
20	790.499997	-0.004	795.499998	-0.002	2.5
30	790.499997	-0.004	795.499999	-0.001	2.5
40	790.499998	-0.002	795.499998	-0.003	2.5
50	790.499997	-0.003	795.499997	-0.003	2.5
60	790.499998	-0.003	795.499998	-0.003	2.5

Frequency Error vs. Voltage

Voltage (Volts)	LTE Band 14		Limit (ppm)
	Channel Bandwidth: 10 MHz		
	Frequency (MHz)	Frequency Error (ppm)	
3.8	793.000002	0.002	2.5
3.23	793.000004	0.005	2.5
4.37	793.000001	0.002	2.5

Note: The applicant defined the normal working voltage of the battery is from 3.23 Vdc to 4.37 Vdc.

Frequency Error vs. Temperature

Temp. (°C)	LTE Band 14		Limit (ppm)
	Channel Bandwidth: 10 MHz		
	Frequency (MHz)	Frequency Error (ppm)	
-30	793.000003	0.003	2.5
-20	793.000002	0.002	2.5
-10	793.000003	0.004	2.5
0	793.000004	0.005	2.5
10	793.000002	0.002	2.5
20	792.999997	-0.004	2.5
30	792.999999	-0.002	2.5
40	792.999997	-0.004	2.5
50	792.999998	-0.002	2.5
60	792.999998	-0.002	2.5

4.4 Occupied Bandwidth Measurement

4.4.1 Limits of Occupied Bandwidth Measurement

The width of a frequency band such that, below the lower and above the upper frequency limits, the mean powers emitted are each equal to a specified percentage 0.5 %of the total mean power of a given emission.

4.4.2 Test Procedure

The EUT makes a call to the communication simulator. All measurements were done at low, middle and high operational frequency range. The communication simulator station system controlled a EUT to export maximum output power under transmission mode and specific channel frequency. Use OBW measurement function of Spectrum analyzer to measure 99 % occupied bandwidth.

4.4.3 Test Setup

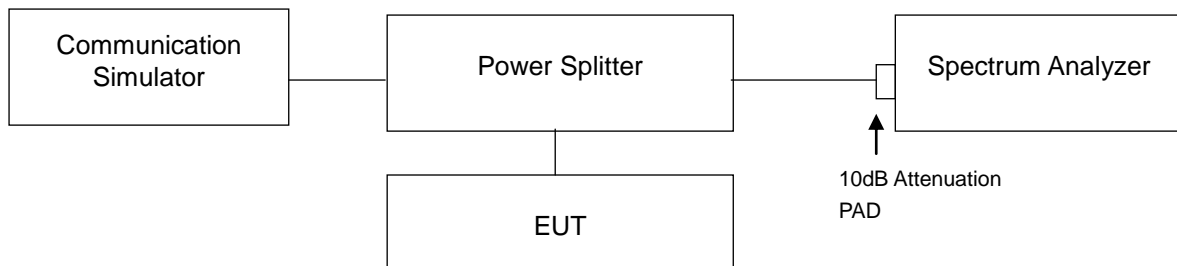

4.4.4 Test Results

LTE Band 14									
Channel Bandwidth: 5 MHz					Channel Bandwidth: 10 MHz				
Channel	Frequency (MHz)	99 % Occupied Bandwidth (MHz)			Channel	Frequency (MHz)	99 % Occupied Bandwidth (MHz)		
		QPSK	16QAM	64QAM			QPSK	16QAM	64QAM
23305	790.5	4.4905	4.4921	4.4899	23330	793.0	8.9724	8.9715	8.9666
23330	793.0	4.4914	4.4938	4.4967					
23355	795.5	4.4940	4.4943	4.4988					

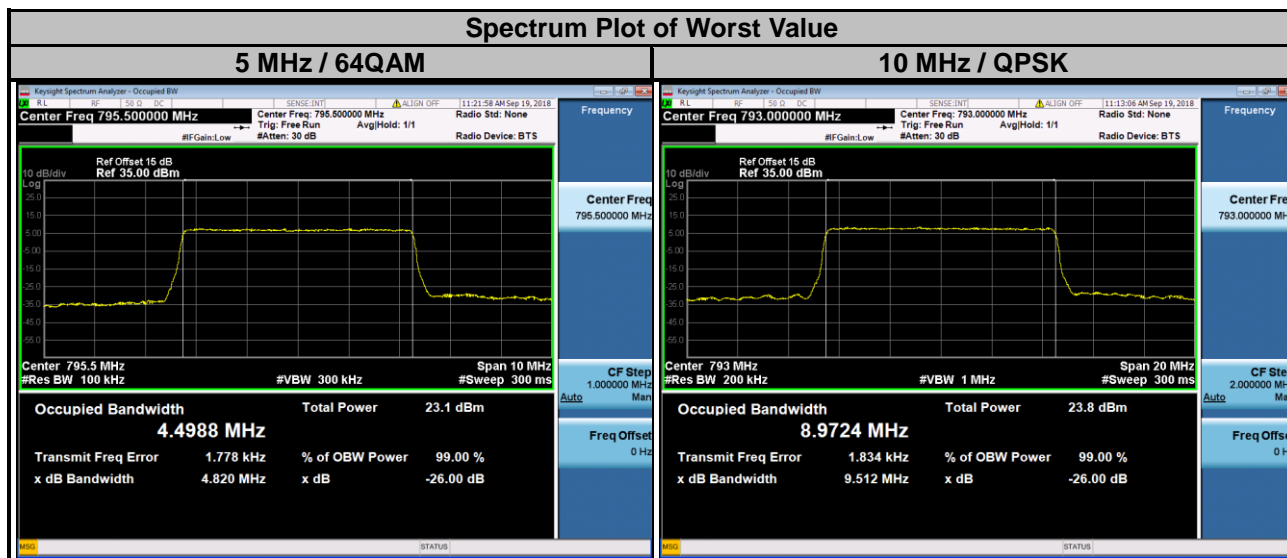

4.5 Emission Mask Measurement

4.5.1 Limits of Band Edge Measurement

LTE Band 14

- (1) On any frequency removed from the assigned frequency by more than 50 percent, but not more than 100 percent of the authorized bandwidth: At least 25 dB.
- (2) On any frequency removed from the assigned frequency by more than 100 percent, but not more than 250 percent of the authorized bandwidth: At least 35 dB.
- (3) On any frequency removed from the assigned frequency by more than 250 percent of the authorized bandwidth: At least $43 + 10 \log (P)$ Db

4.5.2 Test Setup

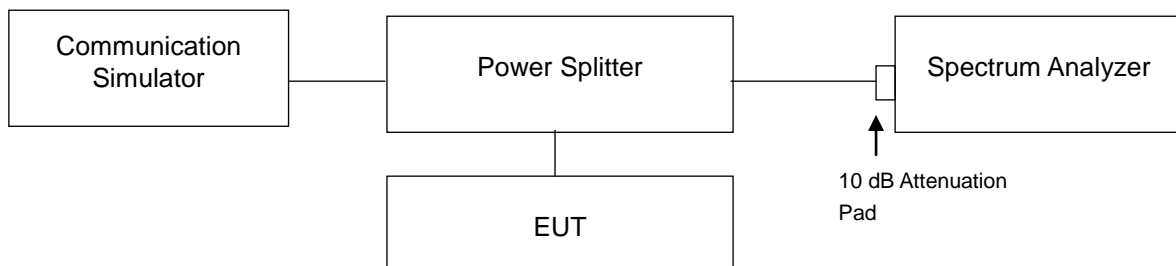

4.5.3 Test Procedures

- a. The measurement used the power splitter via EUT RF power connector between simulation base station and spectrum analyzer.
- b. Record the test plot.

4.5.4 Test Results

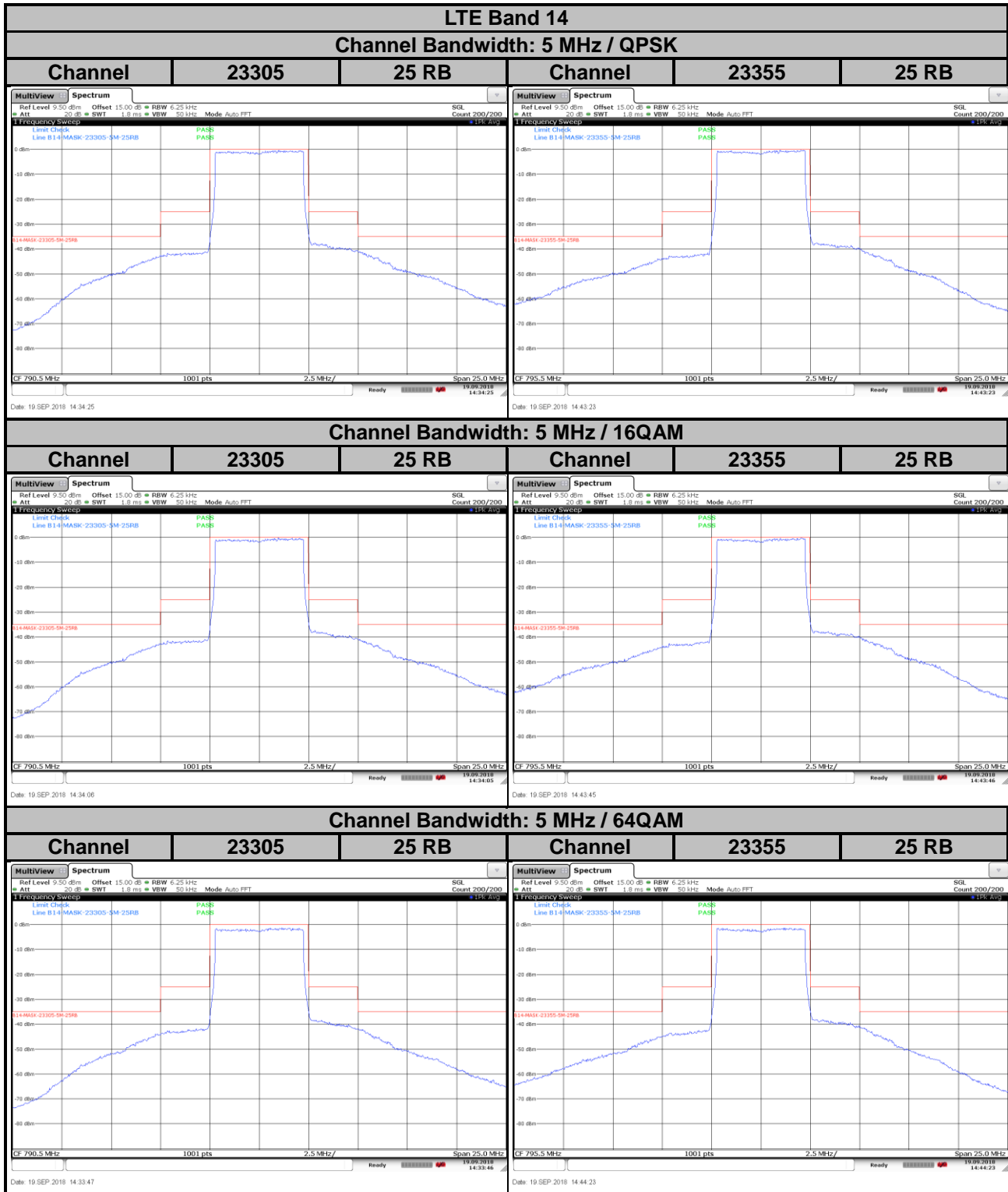

LTE Band 14

Channel Bandwidth: 10 MHz / QPSK

Channel Bandwidth: 10 MHz / 16QAM

Channel 23330 50 RB

Channel 23330 50 RB

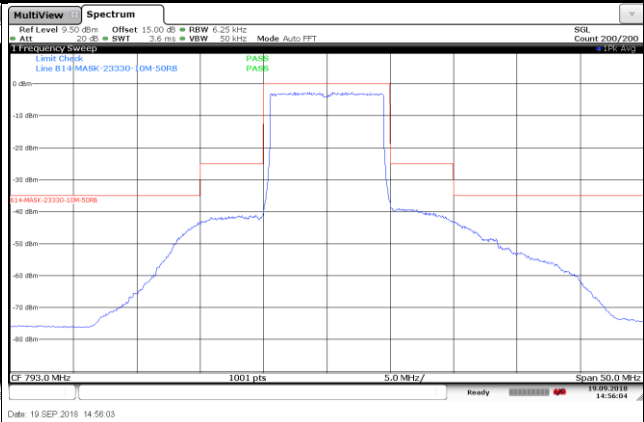
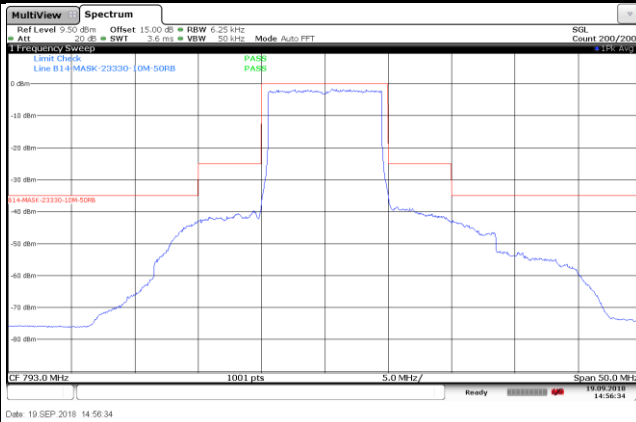

Channel Bandwidth: 10 MHz / 64QAM

Channel 23330 50 RB

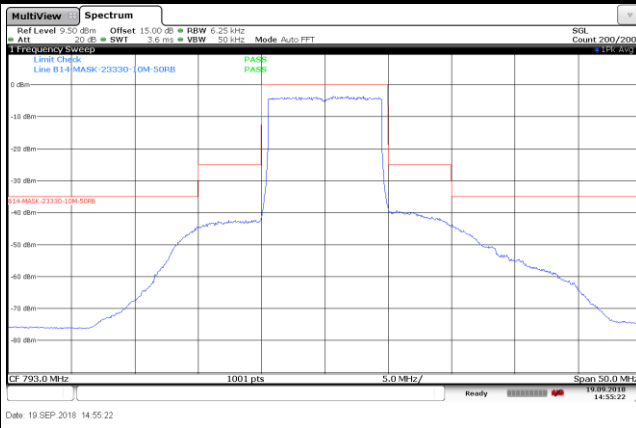

4.6 Band Edge Measurement

4.6.1 Limits of Band Edge Measurement

- (1) On all frequencies between 769 – 775 MHz and 799 – 805 MHz, by a factor not less than $76 + 10 \log (P)$ dB in a 6.25 kHz band segment, for base and fixed stations.
- (2) On all frequencies between 769 – 775 MHz and 799 – 805 MHz, by a factor not less than $65 + 10 \log (P)$ dB in a 6.25 kHz band segment, for mobile and portable stations.
- (3) On any frequency between 775–788MHz, above 805 MHz, and below 758MHz, by at least $43 + 10 \log (P)$ dB

4.6.2 Test Setup

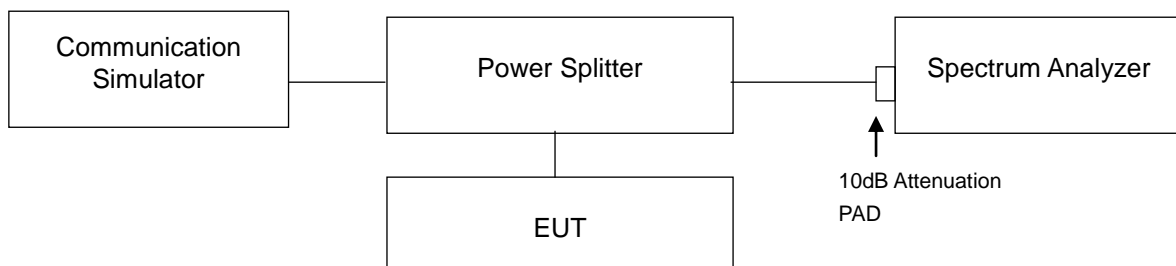

4.6.3 Test Procedures

- a. All measurements were done at low and high operational frequency range.
- b. The band edge measurement used the power splitter via EUT RF power connector between signal generator and spectrum analyzer. This splitter loss, attenuator loss and cable loss are the worst loss 15 dB in the transmitted path track.
- c. Record the max trace plot into the test report.

4.6.4 Test Results

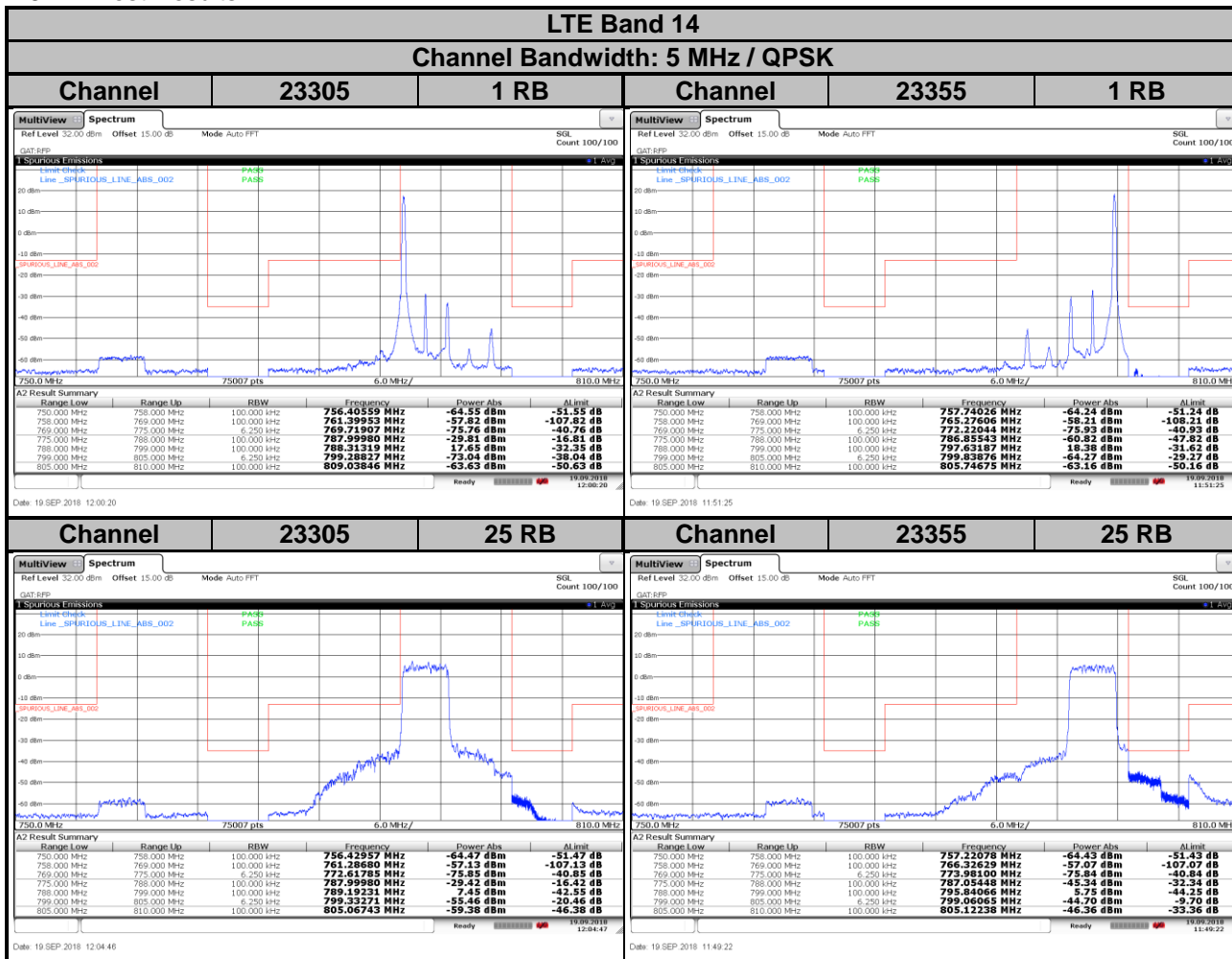

LTE Band 14

Channel Bandwidth: 5 MHz / 16QAM

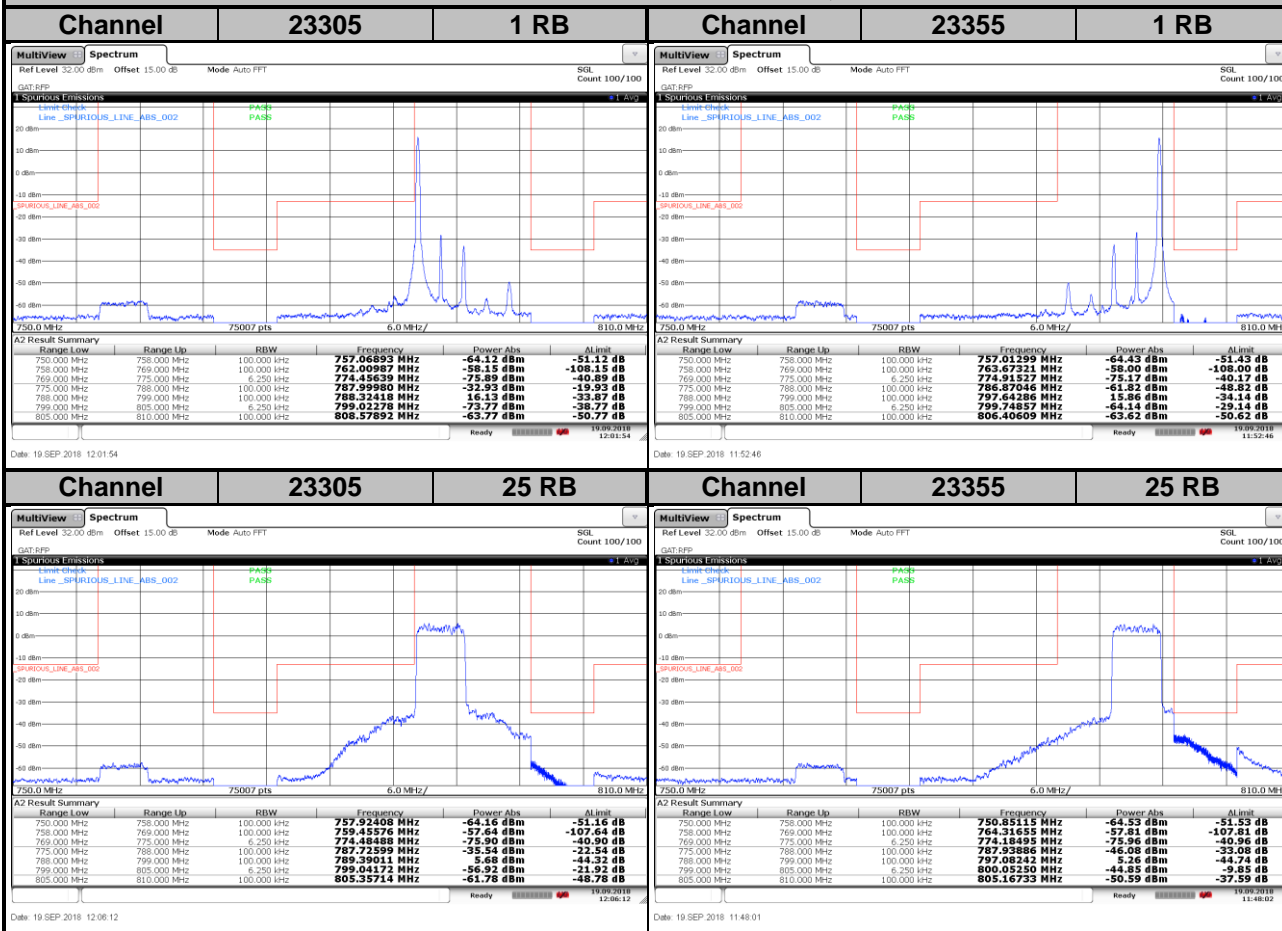

LTE Band 14

Channel Bandwidth: 5 MHz / 64QAM

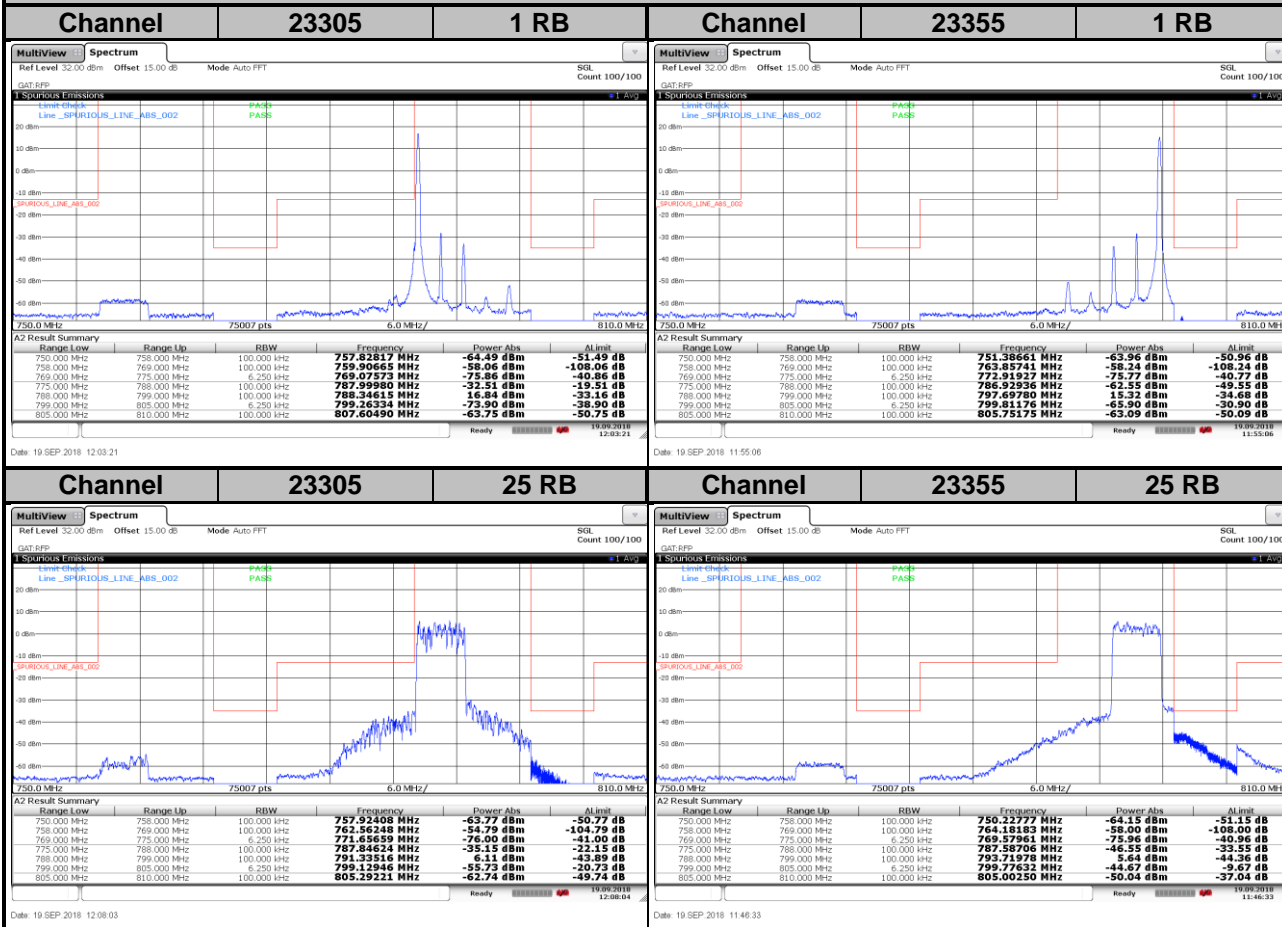

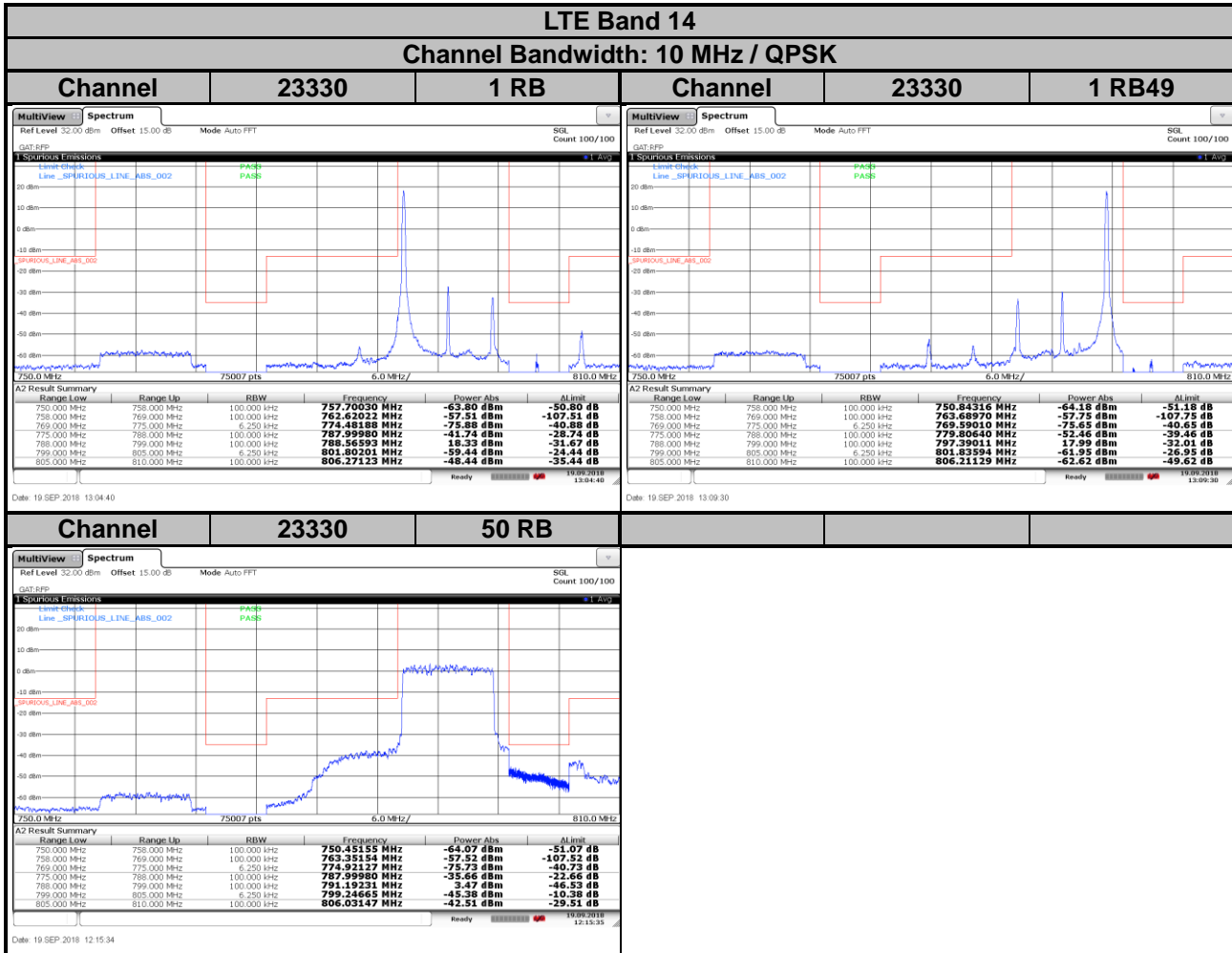

LTE Band 14

Channel Bandwidth: 10 MHz / 16QAM

Channel 23330 1 RB

Channel 23330 1 RB49

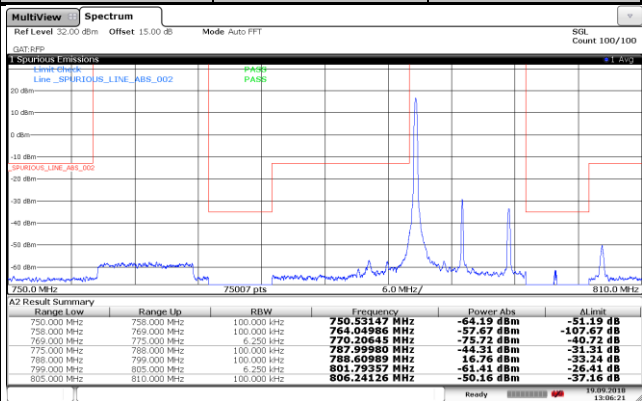

Date: 19 SEP 2018 13:06:21

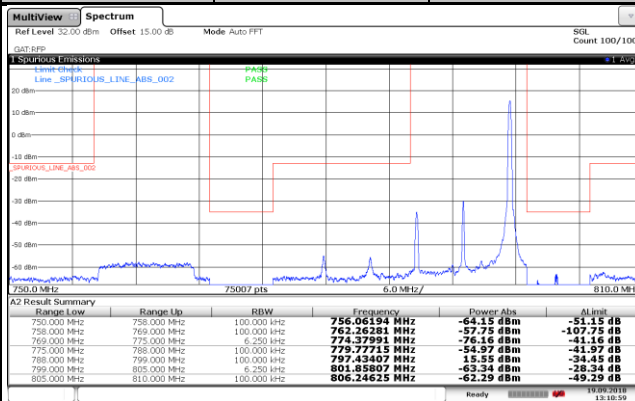

Date: 19 SEP 2018 13:10:58

Channel 23330 50 RB

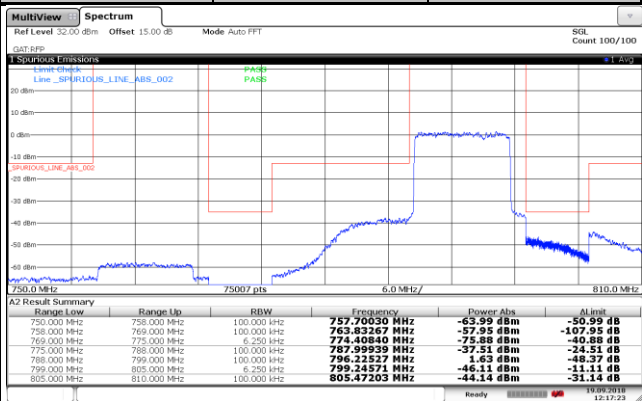

Date: 19 SEP 2018 12:17:23

LTE Band 14

Channel Bandwidth: 10 MHz / 64QAM

Channel 23330 1 RB Channel 23330 1 RB49

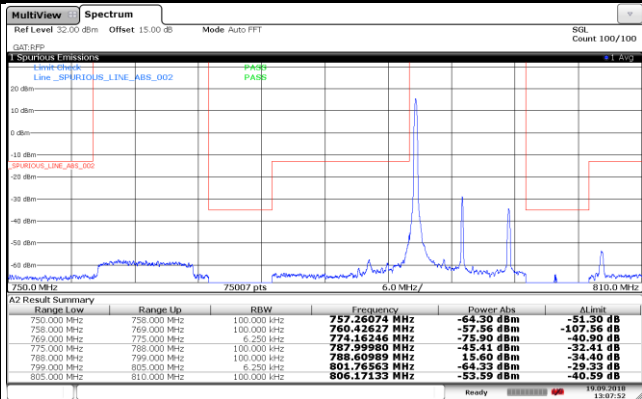

Date: 19 SEP 2018 13:07:51

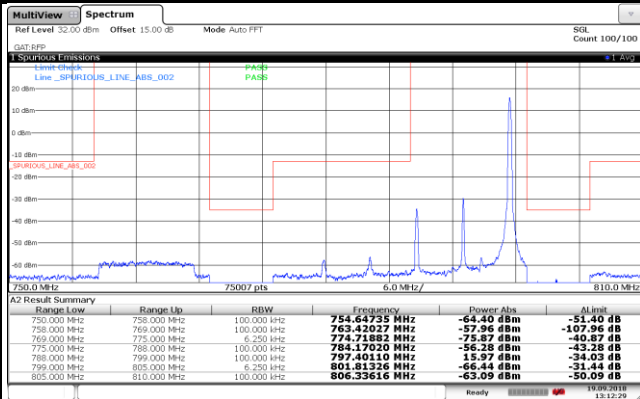

Date: 19 SEP 2018 13:12:29

Channel 23330 50 RB

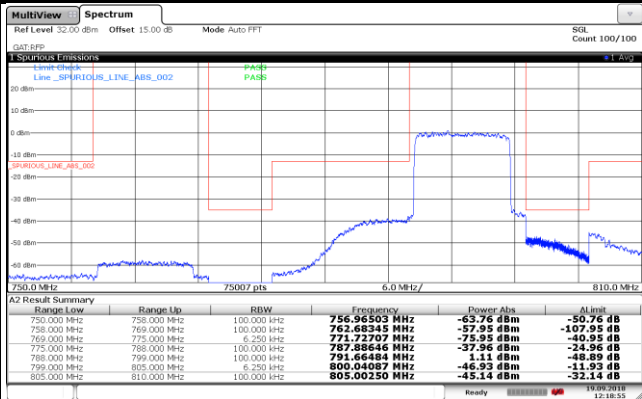

Date: 19 SEP 2018 12:18:54

4.7 Conducted Spurious Emissions

4.7.1 Limits of Conducted Spurious Emissions Measurement

The power of any emission outside a licensee's frequency block shall be attenuated below the transmitter power (P) by at least $43 + 10 \log_{10}(P)$ dB. The limit of emission is equal to -13 dBm.

4.7.2 Test Setup

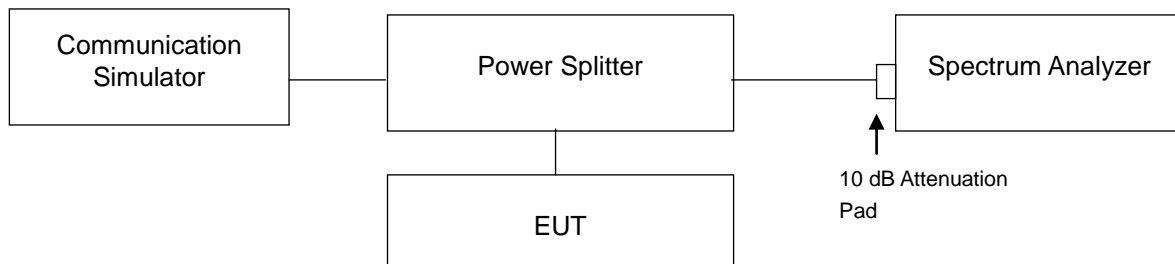

4.7.3 Test Procedure

- The EUT makes a phone call to the communication simulator. All measurements were done at low, middle and high operational frequency range.
- Measuring frequency range is from 9 kHz to 10 GHz. 10 dB attenuation pad is connected with spectrum. RBW = 100 kHz and VBW = 300 kHz are used for conducted emission measurement.

4.7.4 Test Results

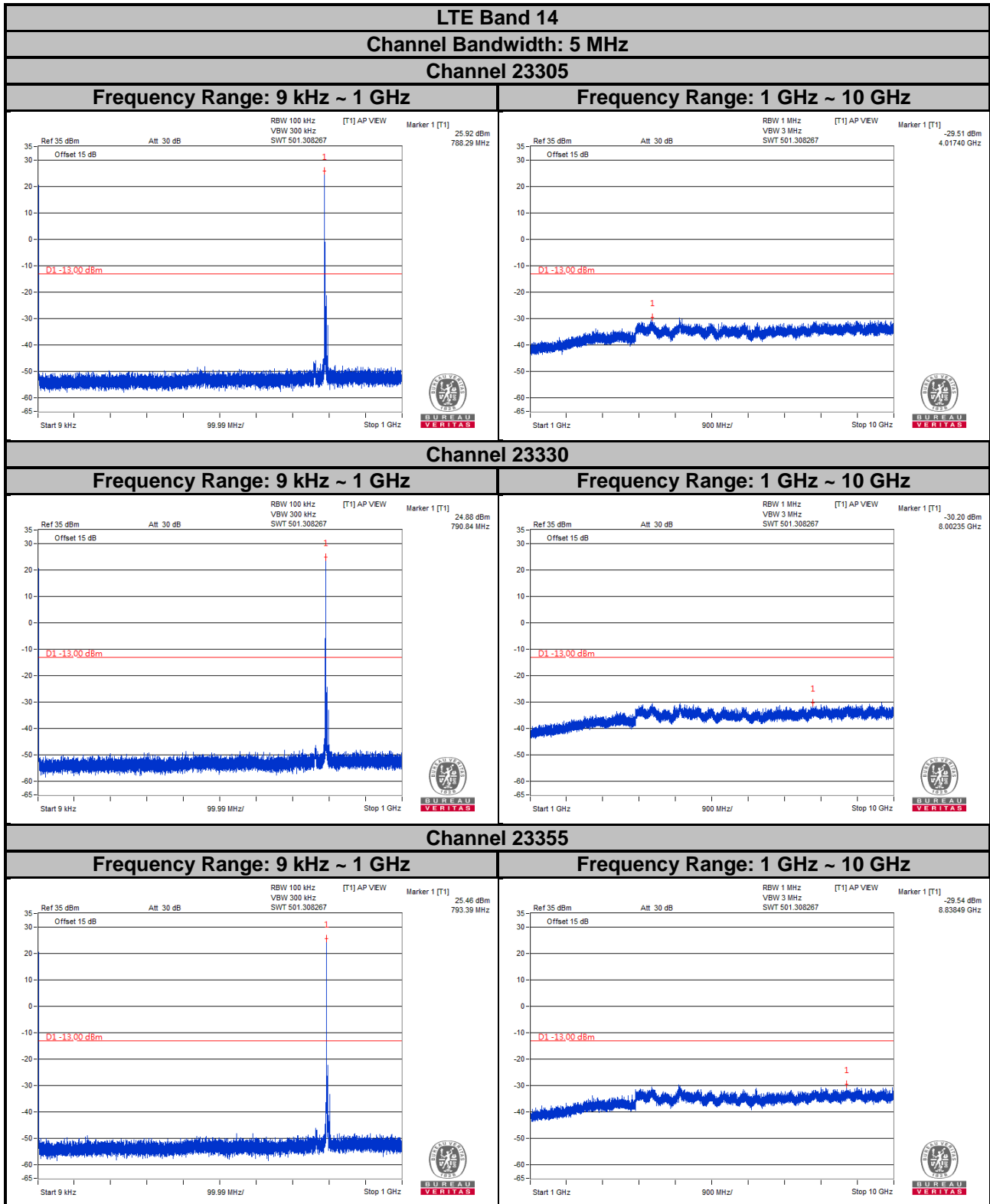

LTE Band 14

Channel Bandwidth: 10 MHz

Channel 23330

Frequency Range: 9 kHz ~ 1 GHz

Frequency Range: 1 GHz ~ 10 GHz

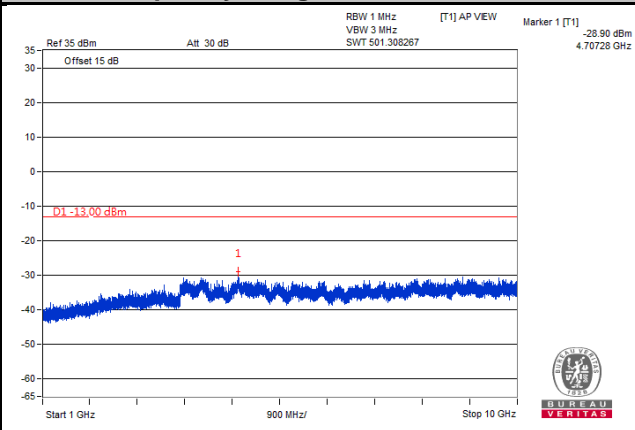
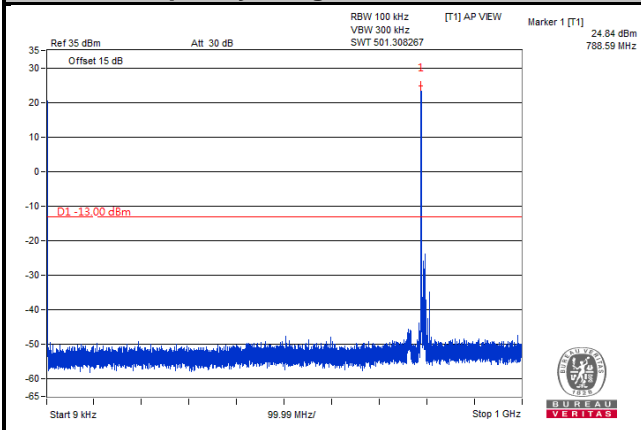

4.8 Radiated Emission Measurement

4.8.1 Limits of Radiated Emission Measurement

- (1) The power of any emission outside a licensee's frequency block shall be attenuated below the transmitter power (P) by at least $43 + 10 \log_{10}(P)$ dB. The limit of emission is equal to -13 dBm.
- (2) For operations in the 758-775 MHz and 788-805 MHz bands, all emissions including harmonics in the band 1559-1610 MHz shall be limited to -70 dBW/MHz equivalent isotropically radiated power (EIRP) for wideband signals, and -80 dBW EIRP for discrete emissions of less than 700 Hz bandwidth.

4.8.2 Test Procedure

- a. Substitution method is used for E.I.R.P measurement. In the semi-anechoic chamber, EUT placed on the 0.8 m (below or equal 1 GHz) and/or 1.5 m (above 1 GHz) height of Turn Table, rotated the table around 360 degrees to search the maximum radiation power and receiver antenna shall be rotated vertical and horizontal polarization and moved height from 1 m to 4 m to find the maximum polar radiated power. The "Read Value" is the spectrum reading the maximum power value.
- b. The substitution horn antenna is substituted for EUT at the same position and signals generator export the CW signal to the substitution antenna via a TX cable. Rotated the Turn Table and moved receiving antenna to find the maximum radiation power. Adjust output power level of S.G to get a Value of spectrum reading equal to "Read Value" of step a. Record the power level of S.G.
- c. $EIRP = \text{Output power level of S.G} - \text{TX cable loss} + \text{Antenna gain of substitution horn}$.
- d. E.R.P power can be calculated form E.I.R.P power by subtracting the gain of dipole, $E.R.P \text{ power} = E.I.P.R \text{ power} - 2.15 \text{ dB}$.

Note: The resolution bandwidth of spectrum analyzer is 1 MHz and the video bandwidth is 3 MHz.

4.8.3 Deviation from Test Standard

No deviation.

4.8.4 Test Setup

<Radiated Emission below or equal 1 GHz>

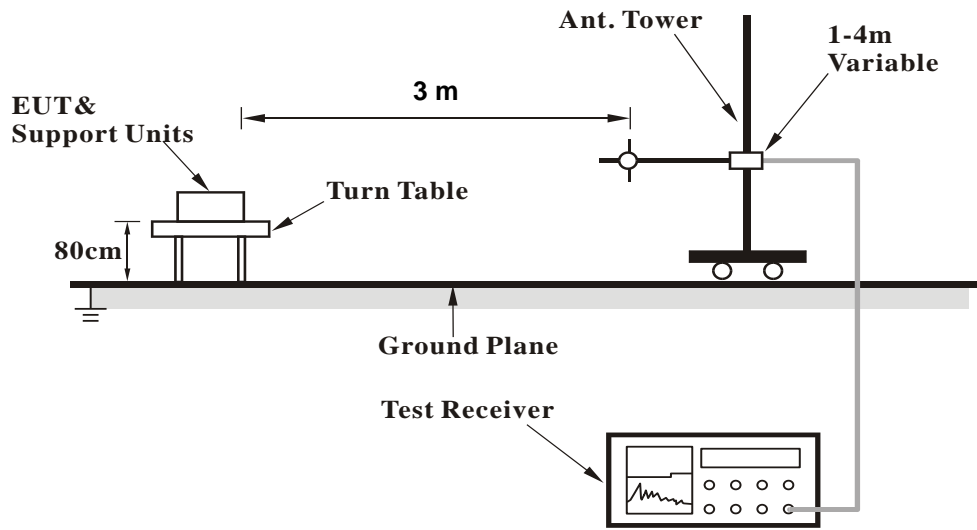

<Radiated Emission above 1 GHz>

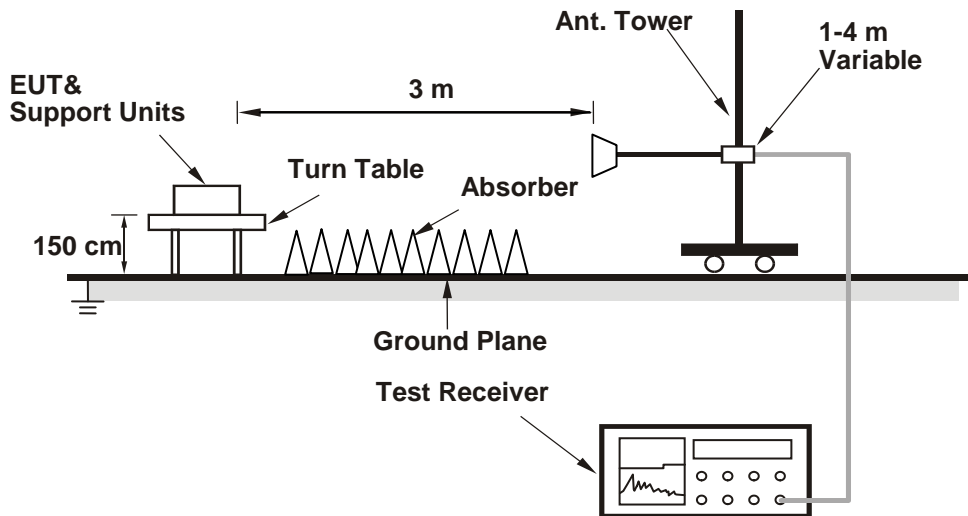

For the actual test configuration, please refer to the attached file (Test Setup Photo).

4.8.5 Test Results

LTE Band 14

Channel Bandwidth: 5 MHz / QPSK

Low Channel



Bureau Veritas Consumer Products Services Ltd., Taoyuan Branch

A D T

Data: 5

Date: 2018-09-13

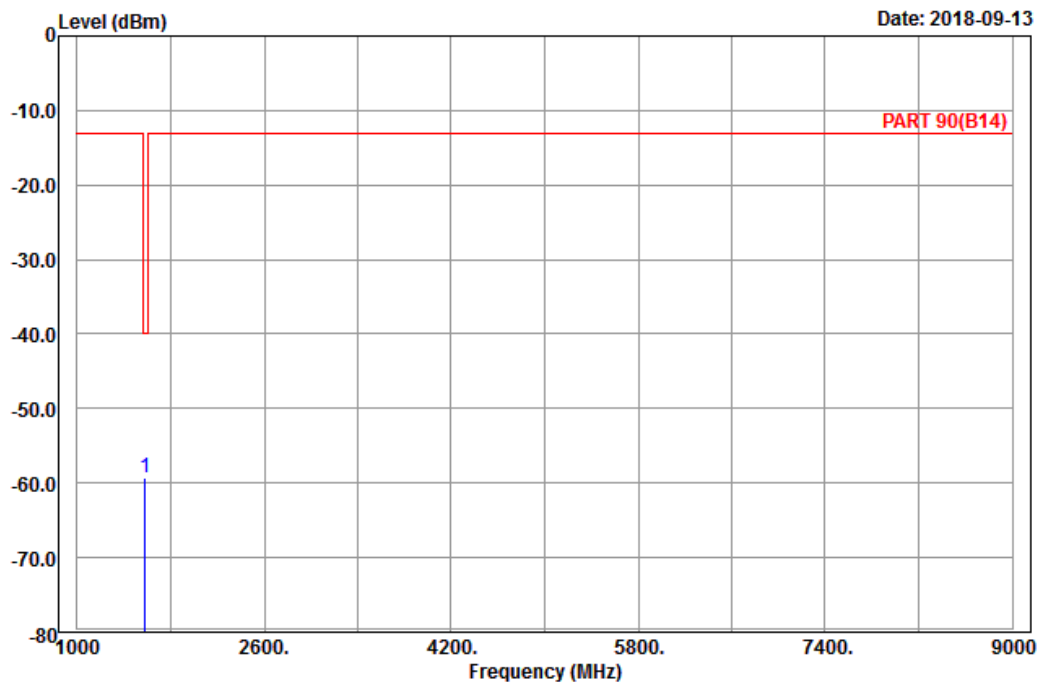

Site : 966 chamber 1
 Condition: PART 90(B14) Horizontal
 Remark : LTE_Band 14_Link_CH23330
 Tested by: Karl Lee

	Freq	Level	Read Level	Limit Line	Over Limit	Factor	Remark
	MHz	dBm	dBm	dBm	dB	dB	
1	pp 1581.00	-59.27	-66.31	-40.00	-19.27	7.04	Peak



A D T

Data: 6

Date: 2018-09-13

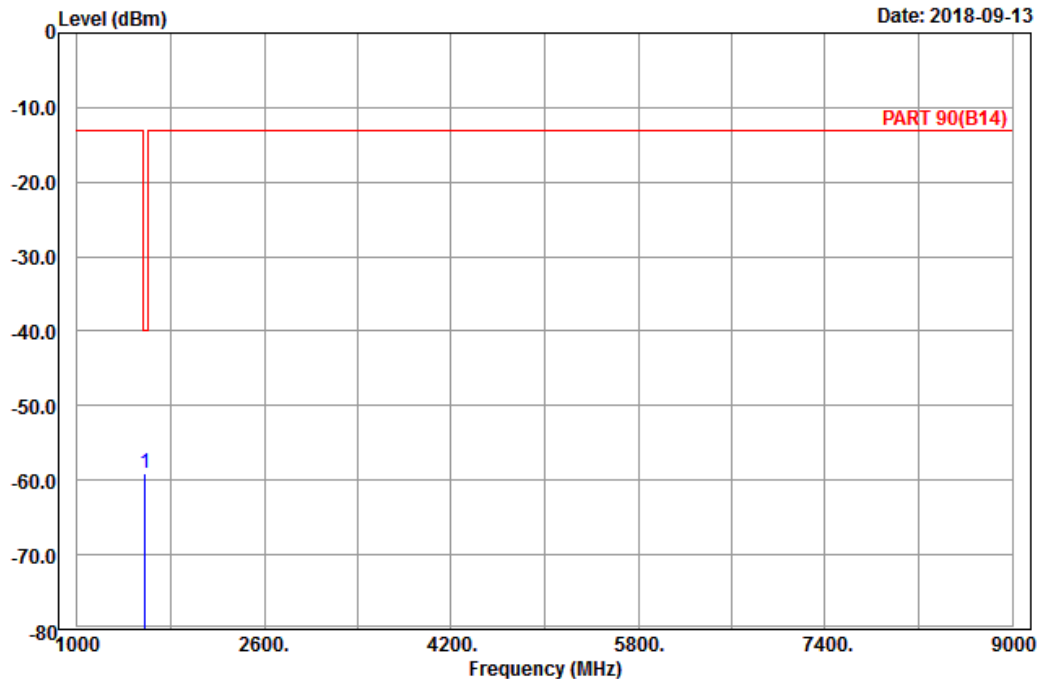

Site : 966 chamber 1
 Condition: PART 90(B14) Vertical
 Remark : LTE_Band 14_Link_CH23330
 Tested by: Karl Lee

	Freq	Level	Read Level	Limit Line	Over Limit	Factor	Remark
	MHz	dBm	dBm	dBm	dB	dB	
1	pp 1581.00	-59.01	-66.05	-40.00	-19.01	7.04	Peak

Middle Channel



Bureau Veritas Consumer Products Services Ltd., Taoyuan Branch

A D T

Data: 5

Date: 2018-09-13

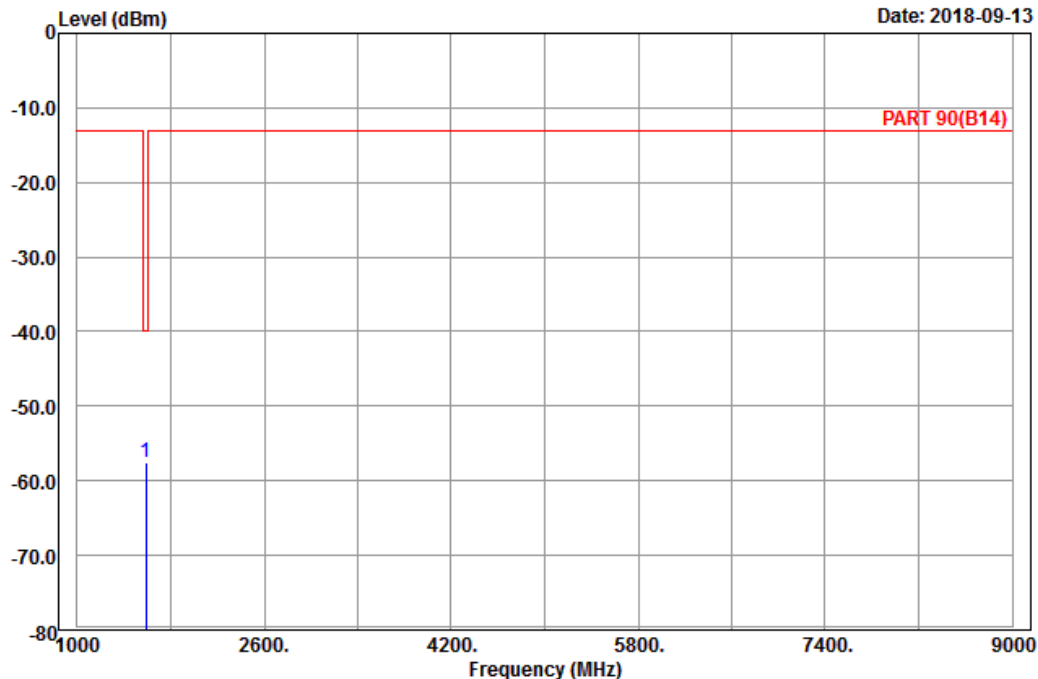

Site : 966 chamber 1
 Condition: PART 90(B14) Horizontal
 Remark : LTE_Band 14_Link_CH23330
 Tested by: Karl Lee
 Plane : NB

	Freq	Level	Read Level	Limit Line	Over Limit	Factor	Remark
	MHz	dBm	dBm	dBm	dB	dB	
1 pp	1586.00	-57.57	-64.78	-40.00	-17.57	7.21	Peak



Bureau Veritas Consumer Products Services Ltd., Taoyuan Branch

A D T

Data: 6

Date: 2018-09-13

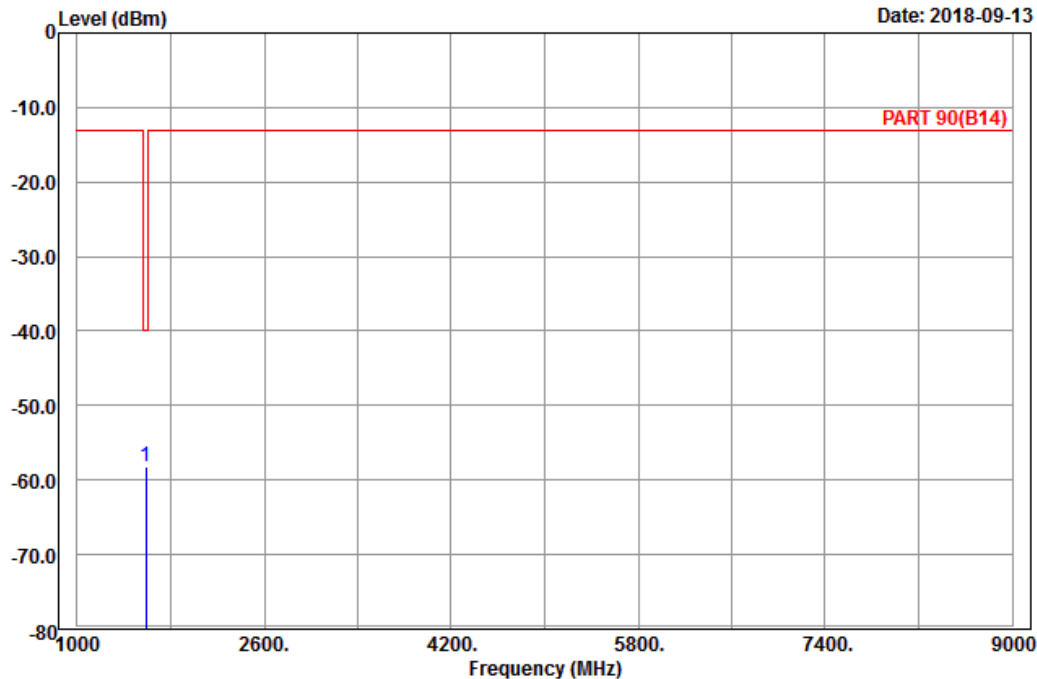

Site : 966 chamber 1
 Condition: PART 90(B14) Vertical
 Remark : LTE_Band 14_Link_CH23330
 Tested by: Karl Lee
 Plane : NB

	Freq	Level	Read Level	Limit Line	Over Limit	Factor	Remark
	MHz	dBm	dBm	dBm	dB	dB	
1 pp	1586.00	-58.10	-65.31	-40.00	-18.10	7.21	Peak

High Channel



Bureau Veritas Consumer Products Services Ltd., Taoyuan Branch

A D T

Data: 5

Date: 2018-09-13

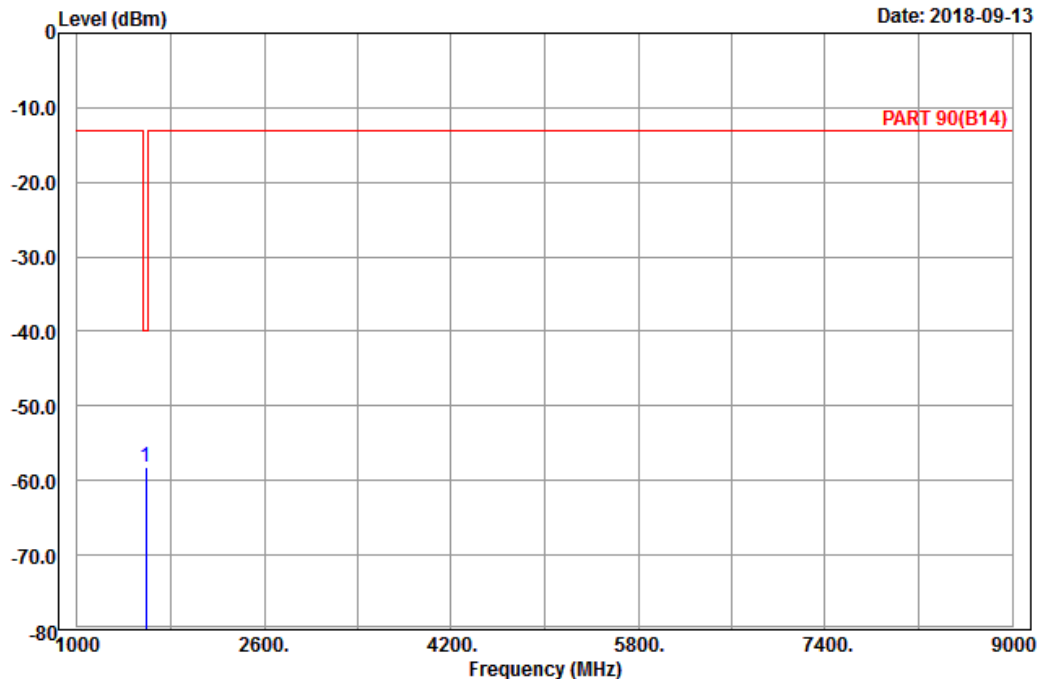

Site : 966 chamber 1
 Condition: PART 90(B14) Horizontal
 Remark : LTE_Band 14_Link_CH23355
 Tested by: Karl Lee

	Read	Limit	Over			
Freq	Level	Level	Line	Limit	Factor	Remark
MHz	dBm	dBm	dBm	dB	dB	
1 pp 1591.00	-58.10	-65.31	-40.00	-18.10	7.21	Peak



Bureau Veritas Consumer Products Services Ltd., Taoyuan Branch

A D T

Data: 6

Date: 2018-09-13

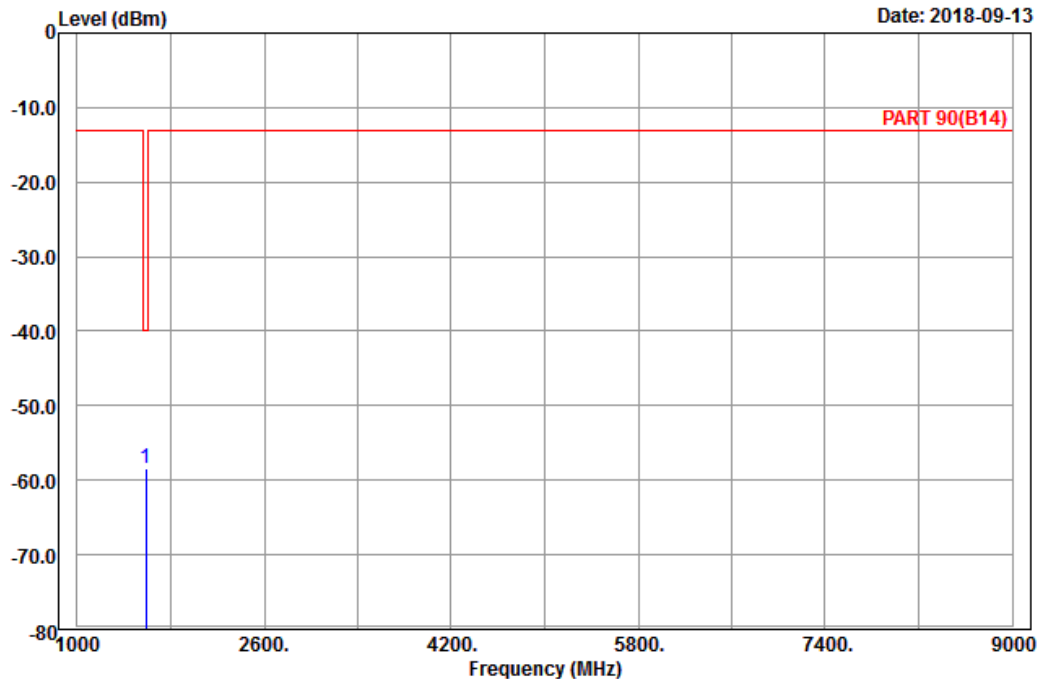

Site : 966 chamber 1
 Condition: PART 90(B14) Vertical
 Remark : LTE_Band 14_Link_CH23355
 Tested by: Karl Lee

	Freq	Level	Read Level	Limit Line	Over Limit	Factor	Remark
	MHz	dBm	dBm	dBm	dB	dB	
1	pp 1591.00	-58.35	-65.56	-40.00	-18.35	7.21	Peak

Channel Bandwidth: 10 MHz / QPSK
Middle Channel



Bureau Veritas Consumer Products Services Ltd., Taoyuan Branch

A D T

Data: 9

Date: 2018-09-13

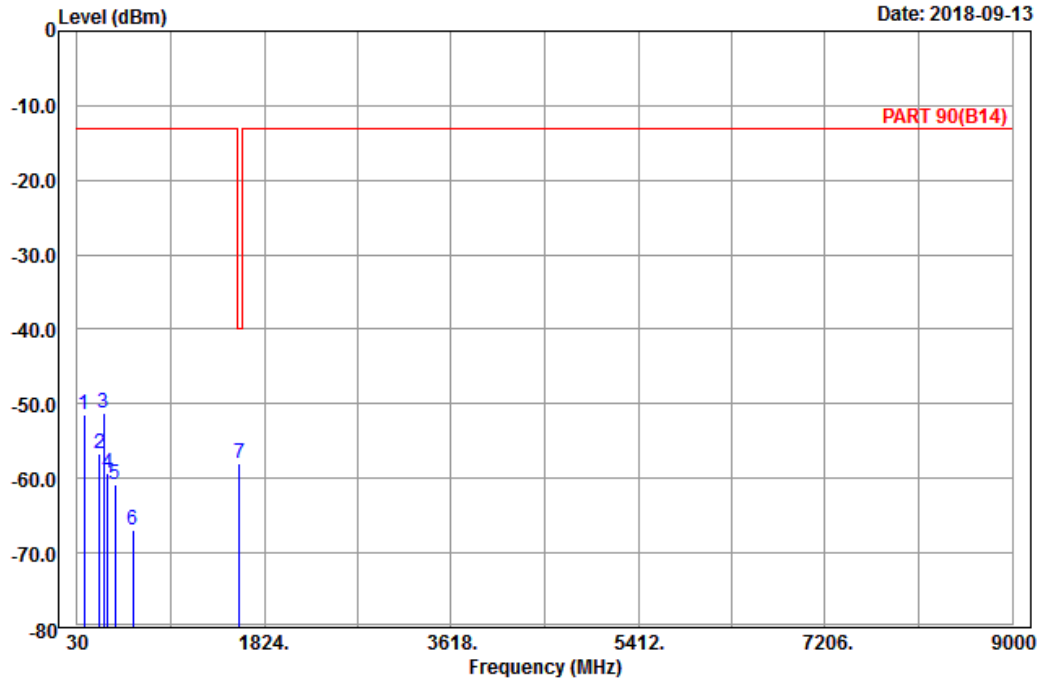

Site : 966 chamber 1
Condition: PART 90(B14) Horizontal
Remark : LTE_Band 14_Link_CH23330
Tested by: Karl Lee

	Freq	Level	Read Level	Limit Line	Over Limit	Factor	Remark
	MHz	dBm	dBm	dBm	dB	dB	
1	97.77	-51.38	-41.15	-13.00	-38.38	-10.23	Peak
2	241.68	-56.59	-50.97	-13.00	-43.59	-5.62	Peak
3	281.37	-51.17	-45.38	-13.00	-38.17	-5.79	Peak
4	318.90	-59.20	-53.46	-13.00	-46.20	-5.74	Peak
5	396.60	-60.92	-58.02	-13.00	-47.92	-2.90	Peak
6	561.10	-66.88	-65.70	-13.00	-53.88	-1.18	Peak
7 pp	1586.00	-58.01	-65.22	-40.00	-18.01	7.21	Peak



Bureau Veritas Consumer Products Services Ltd., Taoyuan Branch

A D T

Data: 10

Date: 2018-09-13

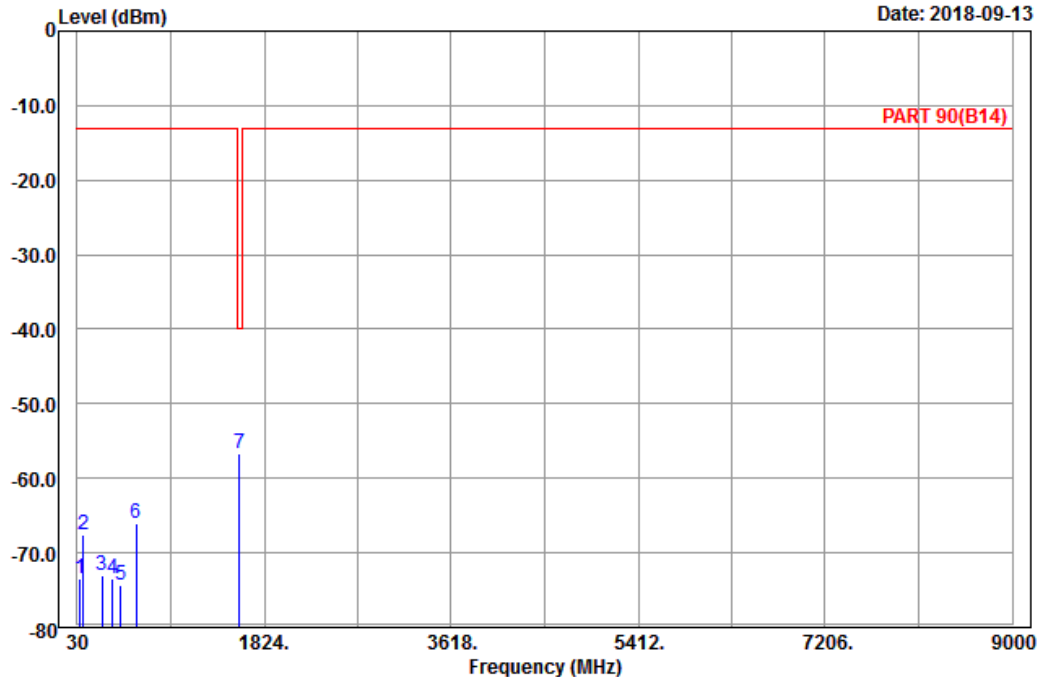

Site : 966 chamber 1
 Condition: PART 90(B14) Vertical
 Remark : LTE_Band 14_Link_CH23330
 Tested by: Karl Lee

	Freq	Level	Read Level	Limit Line	Over Limit	Factor	Remark
	MHz	dBm	dBm	dBm	dB	dB	
1	54.03	-73.39	-59.33	-13.00	-60.39	-14.06	Peak
2	92.37	-67.68	-57.12	-13.00	-54.68	-10.56	Peak
3	267.60	-73.13	-67.46	-13.00	-60.13	-5.67	Peak
4	372.80	-73.50	-69.31	-13.00	-60.50	-4.19	Peak
5	449.80	-74.27	-70.42	-13.00	-61.27	-3.85	Peak
6	598.20	-66.00	-66.35	-13.00	-53.00	0.35	Peak
7 pp	1586.00	-56.66	-63.87	-40.00	-16.66	7.21	Peak

5 Pictures of Test Arrangements

Please refer to the attached file (Test Setup Photo).

Appendix – Information on the Testing Laboratories

We, Bureau Veritas Consumer Products Services (H.K.) Ltd., Taoyuan Branch, were founded in 1988 to provide our best service in EMC, Radio, Telecom and Safety consultation. Our laboratories are FCC recognized accredited test firms and accredited according to ISO/IEC 17025.

If you have any comments, please feel free to contact us at the following:

Linko EMC/RF Lab

Tel: 886-2-26052180

Fax: 886-2-26051924

Hsin Chu EMC/RF/Telecom Lab

Tel: 886-3-6668565

Fax: 886-3-6668323

Hwa Ya EMC/RF/Safety

Tel: 886-3-3183232

Fax: 886-3-3270892

Email: service.adt@tw.bureauveritas.com

Web Site: www.bureauveritas-adt.com

The address and road map of all our labs can be found in our web site also.

--- END ---