

FCC Test Report

(PART 27)

Report No.: RF180821C20-10

FCC ID: V65E6910

Test Model: E6910

Received Date: Aug. 21, 2018

Test Date: Sep. 12, 2018 ~ Sep. 13, 2018

Issued Date: Sep. 28, 2018

Applicant: Kyocera Corporation c/o Kyocera International, Inc.

Address: 8611 Balboa Avenue, San Diego, CA 92123

Issued By: Bureau Veritas Consumer Products Services (H.K.) Ltd., Taoyuan Branch

Lab Address: No. 47-2, 14th Ling, Chia Pau Vil., Lin Kou Dist., New Taipei City, Taiwan
(R.O.C)

Test Location (1): No. 19, Hwa Ya 2nd Rd, Wen Hwa Vil, Kwei Shan Dist., Taoyuan City
33383, Taiwan (R.O.C)

Test Location (2): No.215, Sec. 3, Beixin Rd., Xindian Dist., New Taipei City 231, Taiwan,
R.O.C

**FCC Registration /
Designation Number:** 427177 / TW0011



This report is for your exclusive use. Any copying or replication of this report to or for any other person or entity, or use of our name or trademark, is permitted only with our prior written permission. This report sets forth our findings solely with respect to the test samples identified herein. The results set forth in this report are not indicative or representative of the quality or characteristics of the lot from which a test sample was taken or any similar or identical product unless specifically and expressly noted. Our report includes all of the tests requested by you and the results thereof based upon the information that you provided to us. You have 60 days from date of issuance of this report to notify us of any material error or omission caused by our negligence, provided, however, that such notice shall be in writing and shall specifically address the issue you wish to raise. A failure to raise such issue within the prescribed time shall constitute your unqualified acceptance of the completeness of this report, the tests conducted and the correctness of the report contents. Unless specific mention, the uncertainty of measurement has been explicitly taken into account to declare the compliance or non-compliance to the specification. The report must not be used by the client to claim product certification, approval, or endorsement by TAF or any government agencies

Table of Contents

Release Control Record	3
1 Certificate of Conformity	4
2 Summary of Test Results	5
2.1 Measurement Uncertainty	5
2.2 Test Site and Instruments	6
3 General Information	7
3.1 General Description of EUT	7
3.2 Configuration of System under Test	8
3.2.1 Description of Support Units	8
3.3 Test Mode Applicability and Tested Channel Detail	9
3.4 EUT Operating Conditions	10
3.5 General Description of Applied Standards	10
4 Test Types and Results	11
4.1 Output Power Measurement	11
4.1.1 Limits of Output Power Measurement	11
4.1.2 Test Procedures	11
4.1.3 Test Setup	12
4.1.4 Test Results	13
4.2 Frequency Stability Measurement	20
4.2.1 Limits of Frequency Stability Measurement	20
4.2.2 Test Procedure	20
4.2.3 Test Setup	20
4.2.4 Test Results	21
4.3 Occupied Bandwidth Measurement	25
4.3.1 Limits of Occupied Bandwidth Measurement	25
4.3.2 Test Procedure	25
4.3.3 Test Setup	25
4.3.4 Test Result	26
4.4 Out-of-Band Emissions Measurement	28
4.4.1 Limits of Out-of-Band Emissions Measurement	28
4.4.2 Test Setup	28
4.4.3 Test Procedures	28
4.4.4 Test Results	29
4.5 Peak to Average Ratio	41
4.5.1 Limits of Peak to Average Ratio Measurement	41
4.5.2 Test Setup	41
4.5.3 Test Procedures	41
4.5.4 Test Results	42
4.6 Conducted Spurious Emissions	44
4.6.1 Limits of Conducted Spurious Emissions Measurement	44
4.6.2 Test Setup	44
4.6.3 Test Procedure	44
4.6.4 Test Results	45
4.7 Radiated Emission Measurement	57
4.7.1 Limits of Radiated Emission Measurement	57
4.7.2 Test Procedure	57
4.7.3 Deviation from Test Standard	57
4.7.4 Test Setup	58
4.7.5 Test Results	59
5 Pictures of Test Arrangements	71
Appendix – Information on the Testing Laboratories	72

Release Control Record

Issue No.	Description	Date Issued
RF180821C20-10	Original Release	Sep. 28, 2018

1 Certificate of Conformity

Product: Smart Phone

Brand: Kyocera

Test Model: E6910

Sample Status: Identical Prototype

Applicant: Kyocera Corporation c/o Kyocera International, Inc.

Test Date: Sep. 12, 2018 ~ Sep. 13, 2018

Standards: FCC Part 27, Subpart C, M

The above equipment has been tested by **Bureau Veritas Consumer Products Services (H.K.) Ltd., Taoyuan Branch**, and found compliance with the requirement of the above standards. The test record, data evaluation & Equipment Under Test (EUT) configurations represented herein are true and accurate accounts of the measurements of the sample's RF characteristics under the conditions specified in this report.

Prepared by : , **Date:** Sep. 28, 2018
Ivonne Wu / Supervisor

Approved by : , **Date:** Sep. 28, 2018
Dylan Chiou / Project Engineer

2 Summary of Test Results

Applied Standard: FCC Part 27 & Part 2			
FCC Clause	Test Item	Result	Remarks
2.1046 27.50(h)(2)	Equivalent Isotropic Radiated Power	Pass	Meet the requirement of limit.
2.1047	Modulation Characteristics	Pass	Meet the requirement.
2.1055 27.54	Frequency Stability	Pass	Meet the requirement of limit.
2.1049 27.53(m)(6)	Occupied Bandwidth	Pass	Meet the requirement of limit.
--	Peak to Average Ratio	Pass	Meet the requirement of limit.
2.1051 27.53(l)(m)	Out-of-Band Emissions Measurements	Pass	Meet the requirement of limit.
2.1051 27.53(m)	Conducted Spurious Emissions	Pass	Meet the requirement of limit.
2.1053 27.53(m)	Radiated Spurious Emissions	Pass	Meet the requirement of limit. Minimum passing margin is -21.47 dB at 5120.00 MHz.

2.1 Measurement Uncertainty

Where relevant, the following measurement uncertainty levels have been estimated for tests performed on the EUT as specified in CISPR 16-4-2:

Measurement	Frequency	Expanded Uncertainty (k=2) (\pm)
Radiated Emissions up to 1 GHz	30 MHz ~ 200 MHz	2.0153 dB
	200 MHz ~ 1000 MHz	2.0224 dB
Radiated Emissions above 1 GHz	1 GHz ~ 18 GHz	1.0121 dB
	18 GHz ~ 40 GHz	1.1508 dB

2.2 Test Site and Instruments

Description & Manufacturer	Model No.	Serial No.	Date of Calibration	Due Date of Calibration
Test Receiver Agilent Technologies	N9038A	MY52260177	Aug. 20, 2018	Aug. 19, 2019
Spectrum Analyzer ROHDE & SCHWARZ	FSU43	101261	Jan. 11, 2018	Jan. 10, 2019
HORN Antenna ETS-Lindgren	3117	00143293	Dec. 13, 2017	Dec. 12, 2018
BILOG Antenna SCHWARZBECK	VULB 9168	9168-616	Dec. 14, 2017	Dec. 13, 2018
HORN Antenna SCHWARZBECK	BBHA 9170	9170-480	Dec. 01, 2017	Nov. 30, 2018
HORN Antenna SCHWARZBECK	BBHA 9120D	9120D-969	Dec. 12, 2017	Dec. 11, 2018
Fixed Attenuator Woken	00801A1GGAM02Y	NA	May 17, 2018	May 16, 2019
MXG Vector signal generator Agilent	N5182B	MY53050430	Oct. 24, 2017	Oct. 23, 2018
Preamplifier Agilent	310N	187226	Jun. 19, 2018	Jun. 18, 2019
Preamplifier Agilent	83017A	MY39501357	Jun. 19, 2018	Jun. 18, 2019
RF signal cable ETS-LINDGREN	5D-FB	Cable-CH1-01(RF C-SMS-100-SMS- 120+RFC-SMS-1 00-SMS-400)	Jun. 19, 2018	Jun. 18, 2019
RF signal cable ETS-LINDGREN	8D-FB	Cable-CH1-02(RF C-SMS-100-SMS- 24)	Jun. 19, 2018	Jun. 18, 2019
Boresight Antenna Fixture	FBA-01	FBA-SIP01	NA	NA
Software BV ADT	E3 8.130425b	NA	NA	NA
Antenna Tower MF	NA	NA	NA	NA
Turn Table MF	NA	NA	NA	NA
Antenna Tower & Turn Table Controller MF	MF-7802	NA	NA	NA
Radio Communication Analyzer Anritsu	MT8820C	6201010284	Dec. 28, 2017	Dec. 27, 2018

Note: 1. The calibration interval of the above test instruments is 12 / 24 months and the calibrations are traceable to NML/ROC and NIST/USA.

2. The test was performed in HsinTien Chamber 1.

3. The horn antenna and preamplifier (model: 83017A) are used only for the measurement of emission frequency above 1 GHz if tested.

4. The IC Site Registration No. is IC7450I-1.

3 General Information

3.1 General Description of EUT

Product	Smart Phone	
Brand	Kyocera	
Test Model	E6910	
Status of EUT	Identical Prototype	
Power Supply Rating	3.8 Vdc (Battery) 5 Vdc or 9 Vdc or 12 Vdc (Adapter) 5 Vdc (Host equipment)	
Modulation Type	QPSK, 16QAM, 64QAM	
Frequency Range	LTE Band 7 (Channel Bandwidth: 5 MHz)	2502.5 ~ 2567.5 MHz
	LTE Band 7 (Channel Bandwidth: 10 MHz)	2505 ~ 2565 MHz
	LTE Band 7 (Channel Bandwidth: 15 MHz)	2507.5 ~ 2562.5 MHz
	LTE Band 7 (Channel Bandwidth: 20 MHz)	2510 ~ 2560 MHz
Max. EIRP Power	LTE Band 7 (Channel Bandwidth: 5 MHz)	282.29 mW
	LTE Band 7 (Channel Bandwidth: 10 MHz)	284.90 mW
	LTE Band 7 (Channel Bandwidth: 15 MHz)	286.88 mW
	LTE Band 7 (Channel Bandwidth: 20 MHz)	289.53 mW
Emission Designator	LTE Band 7 (Channel Bandwidth: 5 MHz)	4M49G7D
	LTE Band 7 (Channel Bandwidth: 10 MHz)	8M92W7D
	LTE Band 7 (Channel Bandwidth: 15 MHz)	13M4G7D
	LTE Band 7 (Channel Bandwidth: 20 MHz)	17M8W7D
Antenna Type	Fixed Internal Antenna with -1.1 dBi gain	
Accessory Device	Refer to Note as below	
Data Cable Supplied	Refer to Note as below	

Note:

1. The EUT's accessories list refers to Ext. Pho.
2. The above EUT information is declared by manufacturer and for more detailed features description, please refers to the manufacturer's specifications or user's manual.

3.2 Configuration of System under Test

<Radiated Emission Test>

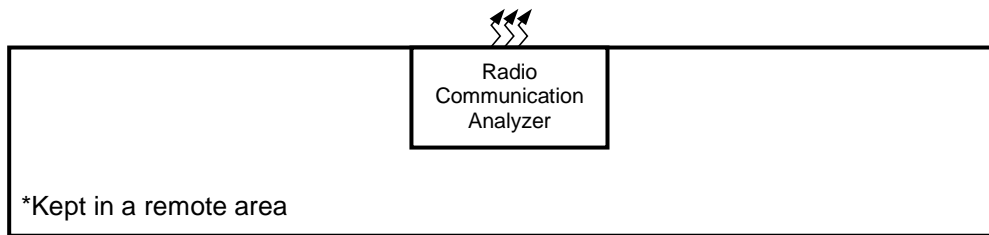
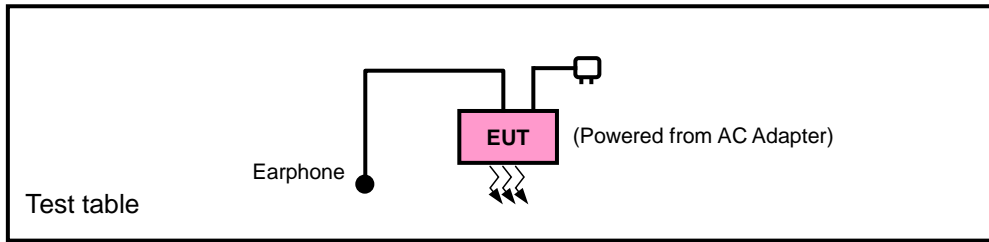

<E.I.R.P. Test>

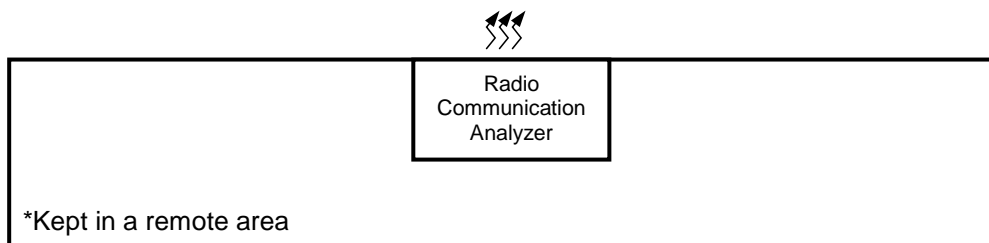
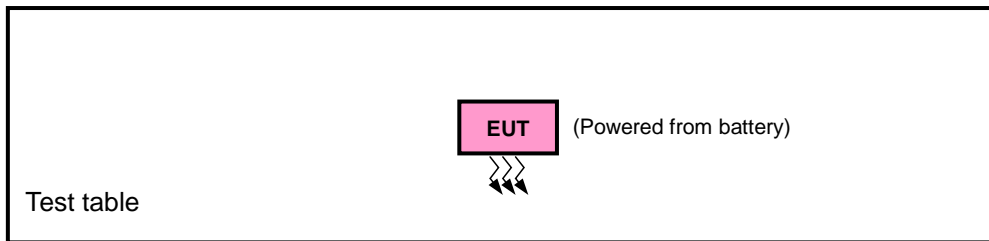

3.2.1 Description of Support Units

The EUT has been tested as an independent unit together with other necessary accessories or support units. The following support units or accessories were used to form a representative test configuration during the tests.

No.	Product	Brand	Model No.	Serial No.	FCC ID
1.	Earphone	Funkey	FK130102	N/A	N/A

No.	Signal Cable Description Of The Above Support Units
1.	N/A

Note:

1. All power cords of the above support units are non-shielded (1.8m).

3.3 Test Mode Applicability and Tested Channel Detail

Pre-Scan has been conducted to determine the worst-case mode from all possible combinations between available modulations, data rates, XYZ axis, and antenna ports.

The worst case was found when positioned as the table below. Following channel(s) was (were) selected for the final test as listed below:

Band	EIRP	Radiated Emission
LTE Band 7	X-plane	Y-axis

LTE Band 7

EUT Configure Mode	Test Item	Available Channel	Tested Channel	Channel Bandwidth	Modulation	Mode
-	EIRP	20775 to 21425	20775, 21100, 21425	5 MHz	QPSK, 16QAM, 64QAM	1 RB / 0 RB Offset
		20800 to 21400	20800, 21100, 21400	10 MHz	QPSK, 16QAM, 64QAM	1 RB / 0 RB Offset
		20825 to 21375	20825, 21100, 21375	15 MHz	QPSK, 16QAM, 64QAM	1 RB / 0 RB Offset
		20850 to 21350	20850, 21100 21350	20 MHz	QPSK, 16QAM, 64QAM	1 RB / 0 RB Offset
-	Modulation Characteristics	20850 to 21350	21100	5 MHz	QPSK, 16QAM, 64QAM	1 RB / 0 RB Offset
-	Frequency Stability	20775 to 21425	20775, 21425	5 MHz	QPSK	1 RB / 0 RB Offset
		20800 to 21400	20800, 21400	10 MHz	QPSK	1 RB / 0 RB Offset
		20825 to 21375	20825, 21375	15 MHz	QPSK	1 RB / 0 RB Offset
		20850 to 21350	20850, 21350	20 MHz	QPSK	1 RB / 0 RB Offset
-	Occupied Bandwidth	20775 to 21425	20775, 21100, 21425	5 MHz	QPSK, 16QAM, 64QAM	25 RB / 0 RB Offset
		20800 to 21400	20800, 21100, 21400	10 MHz	QPSK, 16QAM, 64QAM	50 RB / 0 RB Offset
		20825 to 21375	20825, 21100, 21375	15 MHz	QPSK, 16QAM, 64QAM	75 RB / 0 RB Offset
		20850 to 21350	20850, 21100 21350	20 MHz	QPSK, 16QAM, 64QAM	100 RB / 0 RB Offset
-	Peak to Average Ratio	20775 to 21425	20775, 21100, 21425	5 MHz	QPSK, 16QAM, 64QAM	1 RB / 0 RB Offset
		20800 to 21400	20800, 21100, 21400	10 MHz	QPSK, 16QAM, 64QAM	1 RB / 0 RB Offset
		20825 to 21375	20825, 21100, 21375	15 MHz	QPSK, 16QAM, 64QAM	1 RB / 0 RB Offset
		20850 to 21350	20850, 21100 21350	20 MHz	QPSK, 16QAM, 64QAM	1 RB / 0 RB Offset
-	Out-of-Band Emissions	20775 to 21425	20775, 21425	5 MHz	QPSK, 16QAM, 64QAM	25 RB / 0 RB Offset
		20800 to 21400	20800, 21400	10 MHz	QPSK, 16QAM, 64QAM	50 RB / 0 RB Offset
		20825 to 21375	20825, 21375	15 MHz	QPSK, 16QAM, 64QAM	75 RB / 0 RB Offset
		20850 to 21350	20850, 21350	20 MHz	QPSK, 16QAM, 64QAM	100 RB / 0 RB Offset

EUT Configure Mode	Test Item	Available Channel	Tested Channel	Channel Bandwidth	Modulation	Mode
-	Conducted Emission	20775 to 21425	20775, 21100, 21425	5 MHz	QPSK	1 RB / 0 RB Offset
		20800 to 21400	20800, 21100, 21400	10 MHz	QPSK	1 RB / 0 RB Offset
		20825 to 21375	20825, 21100, 21375	15 MHz	QPSK	1 RB / 0 RB Offset
		20850 to 21350	20850, 21100 21350	20 MHz	QPSK	1 RB / 0 RB Offset
-	Radiated Emission	20775 to 21425	20775, 21100, 21425	5 MHz	QPSK	1 RB / 0 RB Offset
		20850 to 21350	20850, 21100 21350	20 MHz	QPSK	1 RB / 0 RB Offset

Note: This device was tested under all bandwidths, RB configurations and modulations. The worst case was found in QPSK modulation.

Test Condition:

Test Item	Environmental Conditions	Input Power	Tested By
EIRP	25 deg. C, 65 % RH	3.8 Vdc	Harry Hsueh
Modulation Characteristics	25 deg. C, 65 % RH	3.8 Vdc	Wayne Lin
Frequency Stability	25 deg. C, 65 % RH	3.8 Vdc	Wayne Lin
Occupied Bandwidth	25 deg. C, 65 % RH	3.8 Vdc	Wayne Lin
Out-of-Band Emissions	25 deg. C, 65 % RH	3.8 Vdc	Wayne Lin
Peak to Average Ratio	25 deg. C, 65 % RH	3.8 Vdc	Wayne Lin
Conducted Emission	25 deg. C, 65 % RH	3.8 Vdc	Wayne Lin
Radiated Emission	25 deg. C, 65 % RH	120 Vac, 60 Hz	Harry Hsueh

3.4 EUT Operating Conditions

The EUT makes a call to the communication simulator. The communication simulator station system controlled a EUT to export maximum output power under transmission mode and specific channel frequency

3.5 General Description of Applied Standards

The EUT is a RF Product. According to the specifications of the manufacturer, it must comply with the requirements of the following standards:

FCC 47 CFR Part 2

FCC 47 CFR Part 27

KDB 971168 D01 Power Meas License Digital Systems v03r01

ANSI/TIA/EIA-603-E 2016

ANSI 63.26-2015

Note: All test items have been performed and recorded as per the above standards.

4 Test Types and Results

4.1 Output Power Measurement

4.1.1 Limits of Output Power Measurement

The radiated peak output power shall be according to the specific rule Part 27.50(h)(2) that “User stations are limited to 2 watts” and 27.50(i) specific that “Peak transmit power must be measure over any interval of continuous transmission using instrumentation calibration in terms of rms-equivalent voltage.”

4.1.2 Test Procedures

EIRP Measurement:

- a. All measurements were done at low, middle and high operational frequency range. RBW and VBW is 10 MHz for LTE mode.
- b. Substitution method is used for E.I.R.P measurement. In the semi-anechoic chamber, EUT placed on the 0.8 m (below or equal 1 GHz) and/or 1.5 m (above 1 GHz) height of Turn Table, rotated the table around 360 degrees to search the maximum radiation power and receiver antenna shall be rotated vertical and horizontal polarization and moved height from 1 m to 4 m to find the maximum polar radiated power. The “Read Value” is the spectrum reading the maximum power value.
- c. The substitution horn antenna is substituted for EUT at the same position and signals generator export the CW signal to the substitution antenna via a tx cable. Rotated the Turn Table and moved receiving antenna to find the maximum radiation power. Adjust output power level of S.G to get a Value of spectrum reading equal to “Read Value“ of step b. Record the power level of S.G.
- d. $EIRP = \text{Output power level of S.G} - \text{TX cable loss} + \text{Antenna gain of substitution horn}.$

Conducted Power Measurement:

- a. The EUT was set up for the maximum power with LTE link data modulation and link up with simulator.
- b. Set the EUT to transmit under low, middle and high channel and record the power level shown on simulator.

4.1.3 Test Setup

EIRP / ERP Measurement:
<Radiated Emission below or equal 1 GHz>

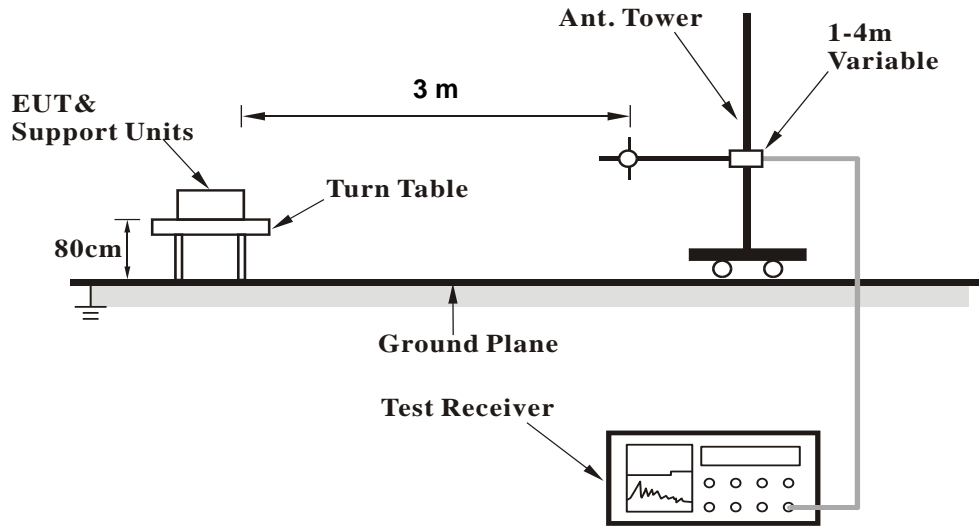

<Radiated Emission above 1 GHz>

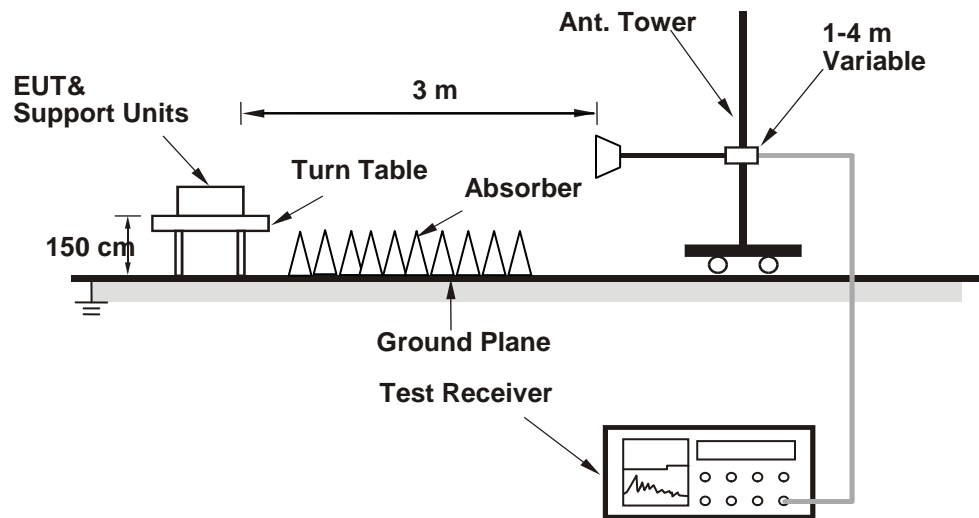

For the actual test configuration, please refer to the attached file (Test Setup Photo).

Conducted Power Measurement:



4.1.4 Test Results

Conducted Output Power (dBm)

LTE Band 7															
BW	MCS Index	RB Size	RB Offset	Low	Mid	High	3GPP MPR (dB)	BW	MCS Index	RB Size	RB Offset	Low	Mid	High	3GPP MPR (dB)
				20850	21100	21350						20825	21100	21375	
				Channel Frequency (MHz)	2510.0	2535.0						2560.0	Channel Frequency (MHz)	2507.5	
20M	QPSK	1	0	23.61	23.62	23.51	0	15M	QPSK	1	0	23.22	23.29	23.12	0
		1	50	23.54	23.55	23.44	0			1	37	23.24	23.15	23.06	0
		1	99	23.52	23.53	23.42	0			1	74	23.14	23.13	23.07	0
		50	0	22.64	22.65	22.54	1			36	0	22.16	22.23	22.11	1
		50	25	22.60	22.61	22.50	1			36	19	22.21	22.31	22.13	1
		50	50	22.53	22.54	22.43	1			36	39	22.29	22.35	22.15	1
	16QAM	100	0	22.61	22.62	22.51	1		75	0	22.28	22.32	22.14	1	
		1	0	22.59	22.57	22.41	1		16QAM	1	0	22.16	22.16	22.06	1
		1	50	22.45	22.53	22.39	1			1	37	22.21	22.13	21.99	1
		1	99	22.42	22.50	22.33	1			1	74	22.08	22.15	22.03	1
		50	0	21.49	21.44	21.34	2			36	0	21.22	21.21	20.98	2
		50	25	21.56	21.59	21.42	2			36	19	21.17	21.23	21.07	2
	50	50	21.61	21.64	21.49	2	36			39	21.24	21.18	21.14	2	
	64QAM	100	0	21.57	21.52	21.47	2		75	0	21.17	21.27	21.07	2	
		1	0	21.58	21.54	21.43	2		64QAM	1	0	21.27	21.24	21.08	2
		1	50	21.44	21.46	21.34	2			1	37	21.07	21.21	21.02	2
		1	99	21.47	21.52	21.42	2			1	74	21.13	21.18	20.99	2
		50	0	20.49	20.46	20.42	3			36	0	20.08	20.12	20.04	3
		50	25	20.60	20.52	20.50	3			36	19	20.16	20.23	20.08	3
	50	50	20.57	20.63	20.44	3	36			39	20.28	20.21	20.11	3	
	10M	QPSK	100	0	20.52	20.57	20.51		3	75	0	20.27	20.18	20.14	3
1			0	23.14	23.20	23.12	0	5M	QPSK	1	0	23.31	23.24	22.98	0
1			24	23.04	23.17	23.02	0			1	12	23.06	23.15	22.83	0
1			49	23.17	23.20	23.03	0			1	24	23.03	23.16	22.89	0
25			0	22.15	22.20	21.94	1			12	0	22.13	22.20	21.89	1
25			12	22.13	22.12	22.00	1			12	6	22.18	22.17	21.95	1
25		25	22.18	22.26	22.09	1	12			13	22.22	22.23	22.10	1	
16QAM		50	0	22.14	22.11	22.08	1		25	0	22.25	22.18	22.02	1	
		1	0	22.21	22.24	21.98	1		16QAM	1	0	22.18	22.20	22.03	1
		1	24	22.10	22.14	21.95	1			1	12	21.96	22.05	21.99	1
		1	49	21.99	22.18	22.04	1			1	24	22.10	22.06	21.93	1
		25	0	20.90	20.98	20.88	2			12	0	20.91	21.14	21.05	2
		25	12	21.03	21.23	21.04	2			12	6	21.10	21.19	21.09	2
25		25	21.03	21.28	21.10	2	12			13	21.12	21.07	21.13	2	
64QAM		50	0	21.15	21.08	21.12	2		25	0	21.19	21.26	21.09	2	
		1	0	21.09	21.05	21.15	2		64QAM	1	0	21.08	21.18	21.10	2
		1	24	21.05	20.96	21.03	2			1	12	21.13	21.03	20.99	2
		1	49	21.02	21.14	20.91	2			1	24	21.00	21.18	20.95	2
		25	0	20.09	20.15	20.05	3			12	0	20.09	19.99	19.99	3
		25	12	20.12	20.18	20.10	3			12	6	20.16	20.21	20.05	3
25		25	20.24	20.04	20.07	3	12			13	20.10	20.25	20.18	3	
		50	0	20.12	20.11	20.05	3		25	0	20.08	20.17	20.03	3	

EIRP Power (dBm)

LTE Band 7							
Channel Bandwidth: 5 MHz / QPSK							
Plane	Channel	Frequency (MHz)	Reading (dBm)	Correction Factor (dB)	EIRP (dBm)	EIRP (mW)	Polarization (H/V)
X	20775	2502.5	-19.80	44.24	24.44	277.84	H
	21100	2535.0	-19.69	44.20	24.51	282.29	
	21425	2567.5	-20.38	44.80	24.42	276.76	
	20775	2502.5	-23.74	44.19	20.45	110.94	V
	21100	2535.0	-23.61	44.09	20.48	111.63	
	21425	2567.5	-24.09	44.50	20.41	109.88	
Channel Bandwidth: 5 MHz / 16QAM							
X	20775	2502.5	-20.81	44.24	23.43	220.19	H
	21100	2535.0	-20.70	44.20	23.50	223.72	
	21425	2567.5	-21.39	44.80	23.41	219.33	
	20775	2502.5	-24.74	44.19	19.45	88.13	V
	21100	2535.0	-24.62	44.09	19.47	88.47	
	21425	2567.5	-25.10	44.50	19.40	87.08	
Channel Bandwidth: 5 MHz / 64QAM							
X	20775	2502.5	-21.82	44.24	22.42	174.50	H
	21100	2535.0	-21.71	44.20	22.49	177.30	
	21425	2567.5	-22.40	44.80	22.40	173.82	
	20775	2502.5	-25.75	44.19	18.44	69.84	V
	21100	2535.0	-25.62	44.09	18.47	70.27	
	21425	2567.5	-26.11	44.50	18.39	69.01	

Note: EIRP (dBm) = Reading (dBm) + Correction Factor (dB)

LTE Band 7							
Channel Bandwidth: 10 MHz / QPSK							
Plane	Channel	Frequency (MHz)	Reading (dBm)	Correction Factor (dB)	EIRP (dBm)	EIRP (mW)	Polarization (H/V)
X	20800	2505.0	-19.86	44.34	24.48	280.61	H
	21100	2535.0	-19.65	44.20	24.55	284.90	
	21400	2565.0	-20.27	44.72	24.45	278.80	
	20800	2505.0	-23.74	44.23	20.49	111.84	V
	21100	2535.0	-23.57	44.09	20.52	112.67	
	21400	2565.0	-23.96	44.41	20.45	110.82	
Channel Bandwidth: 10 MHz / 16QAM							
X	20800	2505.0	-20.86	44.34	23.48	222.89	H
	21100	2535.0	-20.66	44.20	23.54	225.79	
	21400	2565.0	-21.27	44.72	23.45	221.46	
	20800	2505.0	-24.75	44.23	19.48	88.63	V
	21100	2535.0	-24.58	44.09	19.51	89.29	
	21400	2565.0	-24.96	44.41	19.45	88.02	
Channel Bandwidth: 10 MHz / 64QAM							
X	20800	2505.0	-21.86	44.34	22.48	177.05	H
	21100	2535.0	-21.67	44.20	22.53	178.94	
	21400	2565.0	-22.28	44.72	22.44	175.51	
	20800	2505.0	-25.76	44.23	18.47	70.24	V
	21100	2535.0	-25.58	44.09	18.51	70.93	
	21400	2565.0	-25.97	44.41	18.44	69.76	

Note: EIRP (dBm) = Reading (dBm) + Correction Factor (dB)

LTE Band 7							
Channel Bandwidth: 15 MHz / QPSK							
Plane	Channel	Frequency (MHz)	Reading (dBm)	Correction Factor (dB)	EIRP (dBm)	EIRP (mW)	Polarization (H/V)
X	20825	2507.5	-19.81	44.32	24.51	282.36	H
	21100	2535.0	-19.62	44.20	24.58	286.88	
	21375	2562.5	-20.36	44.85	24.49	281.06	
	20825	2507.5	-23.47	43.99	20.52	112.77	V
	21100	2535.0	-23.53	44.09	20.56	113.71	
	21375	2562.5	-24.02	44.51	20.49	111.94	
Channel Bandwidth: 15 MHz / 16QAM							
X	20825	2507.5	-20.82	44.32	23.50	223.77	H
	21100	2535.0	-20.63	44.20	23.57	227.35	
	21375	2562.5	-21.37	44.85	23.48	222.74	
	20825	2507.5	-24.47	43.99	19.52	89.58	V
	21100	2535.0	-24.54	44.09	19.55	90.12	
	21375	2562.5	-25.03	44.51	19.48	88.72	
Channel Bandwidth: 15 MHz / 64QAM							
X	20825	2507.5	-21.82	44.32	22.50	177.75	H
	21100	2535.0	-21.63	44.20	22.57	180.59	
	21375	2562.5	-22.38	44.85	22.47	176.52	
	20825	2507.5	-25.47	43.99	18.52	71.15	V
	21100	2535.0	-25.54	44.09	18.55	71.58	
	21375	2562.5	-26.03	44.51	18.48	70.47	

Note: EIRP (dBm) = Reading (dBm) + Correction Factor (dB)

LTE Band 7							
Channel Bandwidth: 20 MHz / QPSK							
Plane	Channel	Frequency (MHz)	Reading (dBm)	Correction Factor (dB)	EIRP (dBm)	EIRP (mW)	Polarization (H/V)
X	20850.0	2510.0	-19.61	44.16	24.55	285.10	H
	21100.0	2535.0	-19.58	44.20	24.62	289.53	
	21350.0	2560.0	-20.29	44.81	24.52	282.94	
	20850.0	2510.0	-24.22	44.78	20.56	113.76	V
	21100.0	2535.0	-23.49	44.09	20.60	114.76	
	21350.0	2560.0	-24.19	44.72	20.53	112.98	
Channel Bandwidth: 20 MHz / 16QAM							
X	20850.0	2510.0	-20.62	44.16	23.54	225.94	H
	21100.0	2535.0	-20.59	44.20	23.61	229.46	
	21350.0	2560.0	-21.29	44.81	23.52	224.75	
	20850.0	2510.0	-25.23	44.78	19.55	90.16	V
	21100.0	2535.0	-24.50	44.09	19.59	90.95	
	21350.0	2560.0	-25.19	44.72	19.53	89.74	
Channel Bandwidth: 20 MHz / 64QAM							
X	20850.0	2510.0	-21.62	44.16	22.54	179.47	H
	21100.0	2535.0	-21.60	44.20	22.60	181.84	
	21350.0	2560.0	-22.30	44.81	22.51	178.11	
	20850.0	2510.0	-26.24	44.78	18.54	71.45	V
	21100.0	2535.0	-25.51	44.09	18.58	72.08	
	21350.0	2560.0	-26.20	44.72	18.52	71.12	

Note: EIRP (dBm) = Reading (dBm) + Correction Factor (dB)

4.2 Modulation Characteristics Measurement

4.2.1 Limits of Modulation Characteristics

N/A

4.2.2 Test Setup



4.2.3 Test Procedure

Connect the EUT to Communication Simulator via the antenna connector. The frequency band is set as EUT supported Modulation and Channels, the EUT output is matched with 50 ohm load, the waveform quality and constellation of the EUT was tested.

4.2.4 Test Results



4.3 Frequency Stability Measurement

4.3.1 Limits of Frequency Stability Measurement

According to the FCC part 2.1055 shall be tested the frequency stability. The rule is defined that "The frequency stability shall be sufficient to ensure that the fundamental emission stays within the authorized frequency block." The test extreme voltage is according to the 2.1055(d)(1) Vary primary supply voltage from 85 to 115 percent of the nominal value for other than hand carried battery equipment and the extreme temperature rule is comply with specification of EUT $-30^{\circ}\text{C} \sim 50^{\circ}\text{C}$.

4.3.2 Test Procedure

- Device is placed at the oven room. The oven room could control the temperatures and humidity. Power warm up is at least 15 min and power applied should perform before recording frequency error.
- EUT is connected the external power supply to control the DC input power. The test voltage range is from minimum to maximum working voltage. Each step shall be record the frequency error rate.
- The temperature range step is 10 degrees in this test items. All temperature levels shall be hold the $\pm 0.5^{\circ}\text{C}$ during the measurement testing. The each temperature step shall be at least 0.5 hours, consider the EUT could be test under the stability condition.

NOTE: The frequency error was recorded frequency error from the communication simulator.

4.3.3 Test Setup

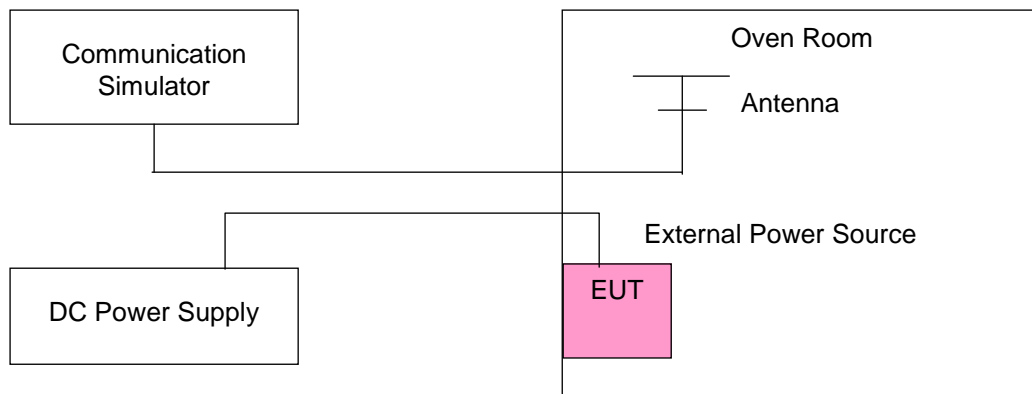

4.3.4 Test Results

Frequency Error vs. Voltage

Voltage (Volts)	LTE Band 7				Limit (ppm)
	Channel Bandwidth: 5 MHz				
	Low Channel		High Channel		
	Frequency (MHz)	Frequency Error (ppm)	Frequency (MHz)	Frequency Error (ppm)	
3.8	2502.500004	0.001	2567.500003	0.001	2.5
3.23	2502.500002	0.001	2567.500001	0.000	2.5
4.37	2502.500003	0.001	2567.500004	0.002	2.5

Note: The applicant defined the normal working voltage of the battery is from 3.23 Vdc to 4.37 Vdc.

Frequency Error vs. Temperature

Temp. (°C)	LTE Band 7				Limit (ppm)
	Channel Bandwidth: 5 MHz				
	Low Channel		High Channel		
	Frequency (MHz)	Frequency Error (ppm)	Frequency (MHz)	Frequency Error (ppm)	
-30	2502.500004	0.001	2567.500004	0.002	2.5
-20	2502.500002	0.001	2567.500002	0.001	2.5
-10	2502.500004	0.001	2567.500002	0.001	2.5
0	2502.500001	0.000	2567.500003	0.001	2.5
10	2502.500001	0.001	2567.500003	0.001	2.5
20	2502.499998	-0.001	2567.499997	-0.001	2.5
30	2502.499996	-0.001	2567.499999	-0.001	2.5
40	2502.499998	-0.001	2567.499997	-0.001	2.5
50	2502.499998	-0.001	2567.499999	-0.001	2.5
60	2502.499998	-0.001	2567.499999	-0.001	2.5

Frequency Error vs. Voltage

Voltage (Volts)	LTE Band 7				Limit (ppm)
	Channel Bandwidth: 10 MHz				
	Low Channel		High Channel		
	Frequency (MHz)	Frequency Error (ppm)	Frequency (MHz)	Frequency Error (ppm)	
3.8	2505.000002	0.001	2565.000003	0.001	2.5
3.23	2505.000002	0.001	2565.000003	0.001	2.5
4.37	2505.000003	0.001	2565.000004	0.002	2.5

Note: The applicant defined the normal working voltage of the battery is from 3.23 Vdc to 4.37 Vdc.

Frequency Error vs. Temperature

Temp. (°C)	LTE Band 7				Limit (ppm)
	Channel Bandwidth: 10 MHz				
	Low Channel		High Channel		
	Frequency (MHz)	Frequency Error (ppm)	Frequency (MHz)	Frequency Error (ppm)	
-30	2505.000002	0.001	2565.000003	0.001	2.5
-20	2505.000004	0.002	2565.000004	0.001	2.5
-10	2505.000004	0.002	2565.000001	0.001	2.5
0	2505.000002	0.001	2565.000002	0.001	2.5
10	2505.000004	0.001	2565.000003	0.001	2.5
20	2504.999996	-0.002	2564.999999	-0.001	2.5
30	2504.999997	-0.001	2564.999998	-0.001	2.5
40	2504.999996	-0.001	2564.999999	-0.001	2.5
50	2504.999998	-0.001	2564.999998	-0.001	2.5
60	2504.999998	-0.001	2564.999998	-0.001	2.5

Frequency Error vs. Voltage

Voltage (Volts)	LTE Band 7				Limit (ppm)
	Channel Bandwidth: 15 MHz				
	Low Channel		High Channel		
	Frequency (MHz)	Frequency Error (ppm)	Frequency (MHz)	Frequency Error (ppm)	
3.8	2507.500003	0.001	2562.500004	0.001	2.5
3.23	2507.500003	0.001	2562.500003	0.001	2.5
4.37	2507.500002	0.001	2562.500001	0.001	2.5

Note: The applicant defined the normal working voltage of the battery is from 3.23 Vdc to 4.37 Vdc.

Frequency Error vs. Temperature

Temp. (°C)	LTE Band 7				Limit (ppm)
	Channel Bandwidth: 15 MHz				
	Low Channel		High Channel		
	Frequency (MHz)	Frequency Error (ppm)	Frequency (MHz)	Frequency Error (ppm)	
-30	2507.500004	0.002	2562.500004	0.002	2.5
-20	2507.500003	0.001	2562.500001	0.001	2.5
-10	2507.500002	0.001	2562.500004	0.001	2.5
0	2507.500001	0.000	2562.500003	0.001	2.5
10	2507.500004	0.001	2562.500001	0.000	2.5
20	2507.499998	-0.001	2562.499997	-0.001	2.5
30	2507.499998	-0.001	2562.499996	-0.001	2.5
40	2507.499998	-0.001	2562.499997	-0.001	2.5
50	2507.499998	-0.001	2562.499998	-0.001	2.5
60	2507.499998	-0.001	2562.499997	-0.001	2.5

Frequency Error vs. Voltage

Voltage (Volts)	LTE Band 7				Limit (ppm)
	Channel Bandwidth: 20 MHz				
	Low Channel		High Channel		
	Frequency (MHz)	Frequency Error (ppm)	Frequency (MHz)	Frequency Error (ppm)	
3.8	2510.000002	0.001	2560.000003	0.001	2.5
3.23	2510.000003	0.001	2560.000001	0.000	2.5
4.37	2510.000003	0.001	2560.000003	0.001	2.5

Note: The applicant defined the normal working voltage of the battery is from 3.23 Vdc to 4.37 Vdc.

Frequency Error vs. Temperature

Temp. (°C)	LTE Band 7				Limit (ppm)
	Channel Bandwidth: 20 MHz				
	Low Channel		High Channel		
	Frequency (MHz)	Frequency Error (ppm)	Frequency (MHz)	Frequency Error (ppm)	
-30	2510.000002	0.001	2560.000002	0.001	2.5
-20	2510.000003	0.001	2560.000001	0.000	2.5
-10	2510.000002	0.001	2560.000002	0.001	2.5
0	2510.000004	0.002	2560.000002	0.001	2.5
10	2510.000003	0.001	2560.000002	0.001	2.5
20	2509.999999	0.000	2559.999997	-0.001	2.5
30	2509.999997	-0.001	2559.999997	-0.001	2.5
40	2509.999999	0.000	2559.999999	-0.001	2.5
50	2509.999999	-0.001	2559.999997	-0.001	2.5
60	2509.999999	-0.001	2559.999999	-0.001	2.5

4.4 Occupied Bandwidth Measurement

4.4.1 Limits of Occupied Bandwidth Measurement

The width of a frequency band such that, below the lower and above the upper frequency limits, the mean powers emitted are each equal to a specified percentage 0.5 % of the total mean power of a given emission.

4.4.2 Test Procedure

- The conducted occupied bandwidth used the power splitter via EUT RF power connector between simulation base station and spectrum analyzer.
- Use OBW measurement function of Spectrum analyzer to measure 99 % occupied bandwidth.

4.4.3 Test Setup

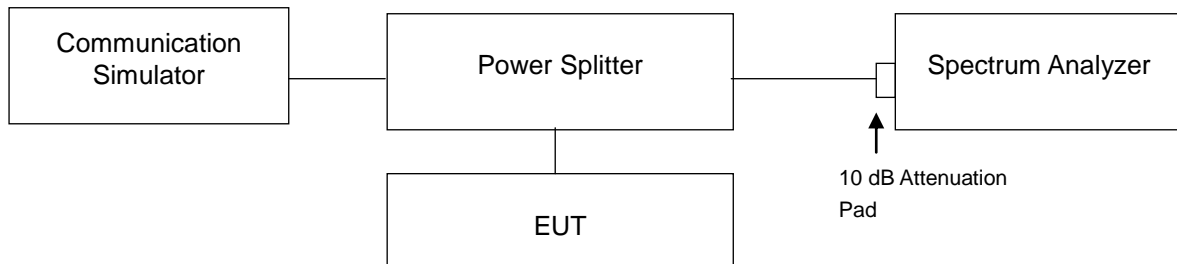

4.4.4 Test Results

LTE Band 7									
Channel Bandwidth: 5 MHz					Channel Bandwidth: 10 MHz				
Channel	Frequency (MHz)	99 % Occupied Bandwidth (MHz)			Channel	Frequency (MHz)	99 % Occupied Bandwidth (MHz)		
		QPSK	16QAM	64QAM			QPSK	16QAM	64QAM
20775	2502.5	4.4914	4.4932	4.4983	20800	2505.0	8.9638	8.9712	8.9727
21100	2535.0	4.4923	4.4935	4.5027	21100	2535.0	8.9716	8.9733	8.9808
21425	2567.5	4.4935	4.4939	4.5025	21400	2565.0	8.9738	8.9760	8.9774

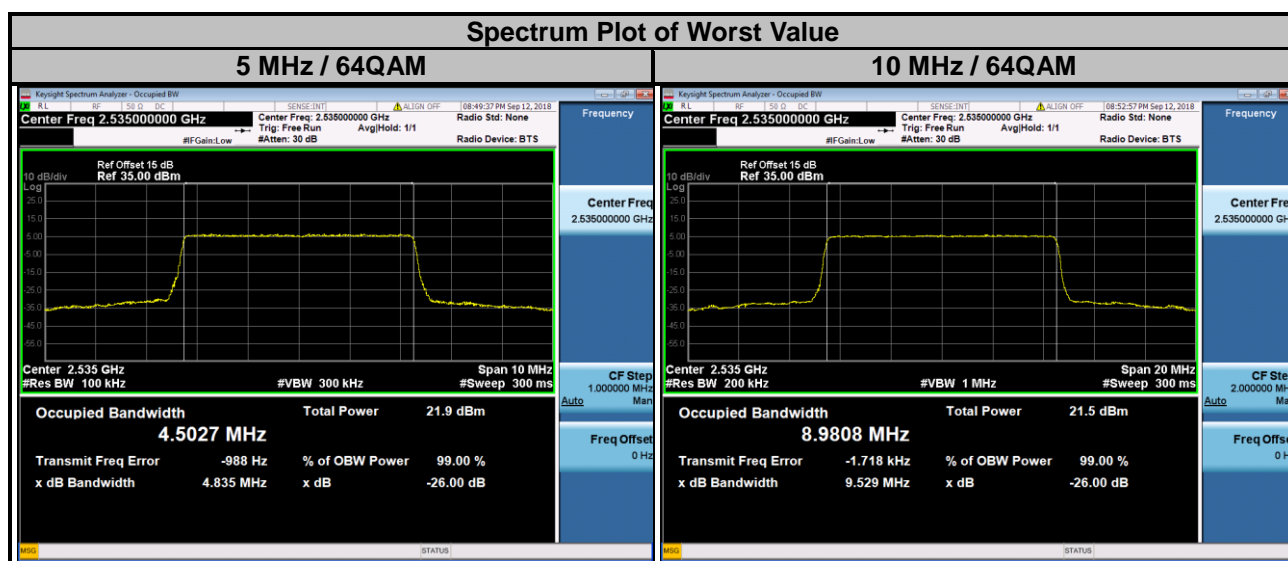

LTE Band 7									
Channel Bandwidth: 15 MHz					Channel Bandwidth: 20 MHz				
Channel	Frequency (MHz)	99 % Occupied Bandwidth (MHz)			Channel	Frequency (MHz)	99 % Occupied Bandwidth (MHz)		
		QPSK	16QAM	64QAM			QPSK	16QAM	64QAM
20825	2507.5	13.436	13.426	13.424	20850	2510.0	17.894	17.910	17.910
21100	2535.0	13.453	13.445	13.442	21100	2535.0	17.923	17.954	17.950
21375	2562.5	13.454	13.448	13.441	21350	2560.0	17.928	17.952	17.945

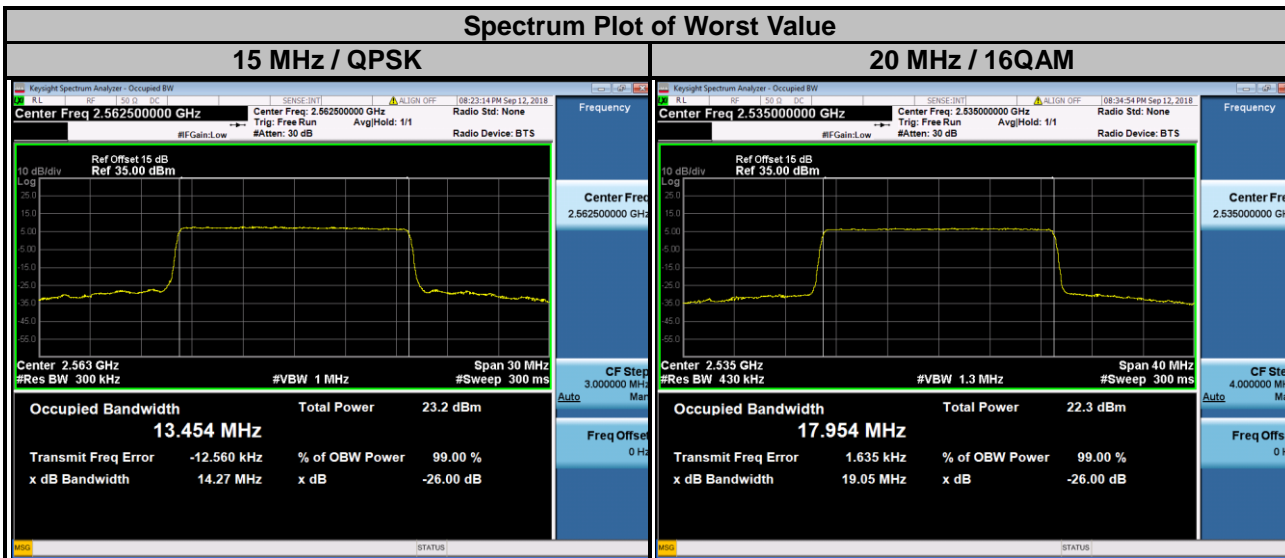

4.5 Out-of-Band Emissions Measurement

4.5.1 Limits of Out-of-Band Emissions Measurement

According to FCC 27.53(l)(4) specified that power of any emission outside of the channel edge must be attenuated below the transmitting power (P) by a factor shall be not less than $40 + 10 \log (P)$ dB on all frequencies between the channel edge and 5 megahertz from the channel edge, $43 + 10 \log (P)$ dB on all frequencies between 5 megahertz and X megahertz from the channel edge, and $55 + 10 \log (P)$ dB on all frequencies more than X megahertz from the channel edge, where X is the greater of 6 megahertz or the actual emission bandwidth. In addition, the attenuation factor shall not be less that $43 + 10 \log (P)$ dB on all frequencies between 2490.5 MHz and 2496 MHz and $55 + 10 \log (P)$ dB at or below 2490.5 MHz. In the 1 MHz bands immediately outside and adjacent to the frequency block a resolution bandwidth of at least two percent may be employed, except when the 1 megahertz band is 2495-2496 MHz, in which case a resolution bandwidth of at least one percent may be employed.

4.5.2 Test Setup

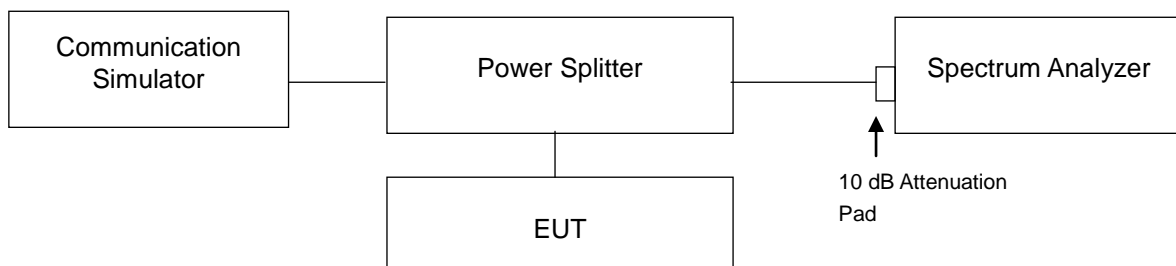

4.5.3 Test Procedures

- The EUT was set up for the maximum peak power with LTE link data modulation. The power was measured with R&S Spectrum Analyzer. All measurements were done at 2 channels (low and high operational frequency range.).
- The out-of-band emissions measurement used the power splitter via EUT RF power connector between simulation base station and spectrum analyzer.
- Record the max. trace plot into the test report.

4.5.4 Test Results

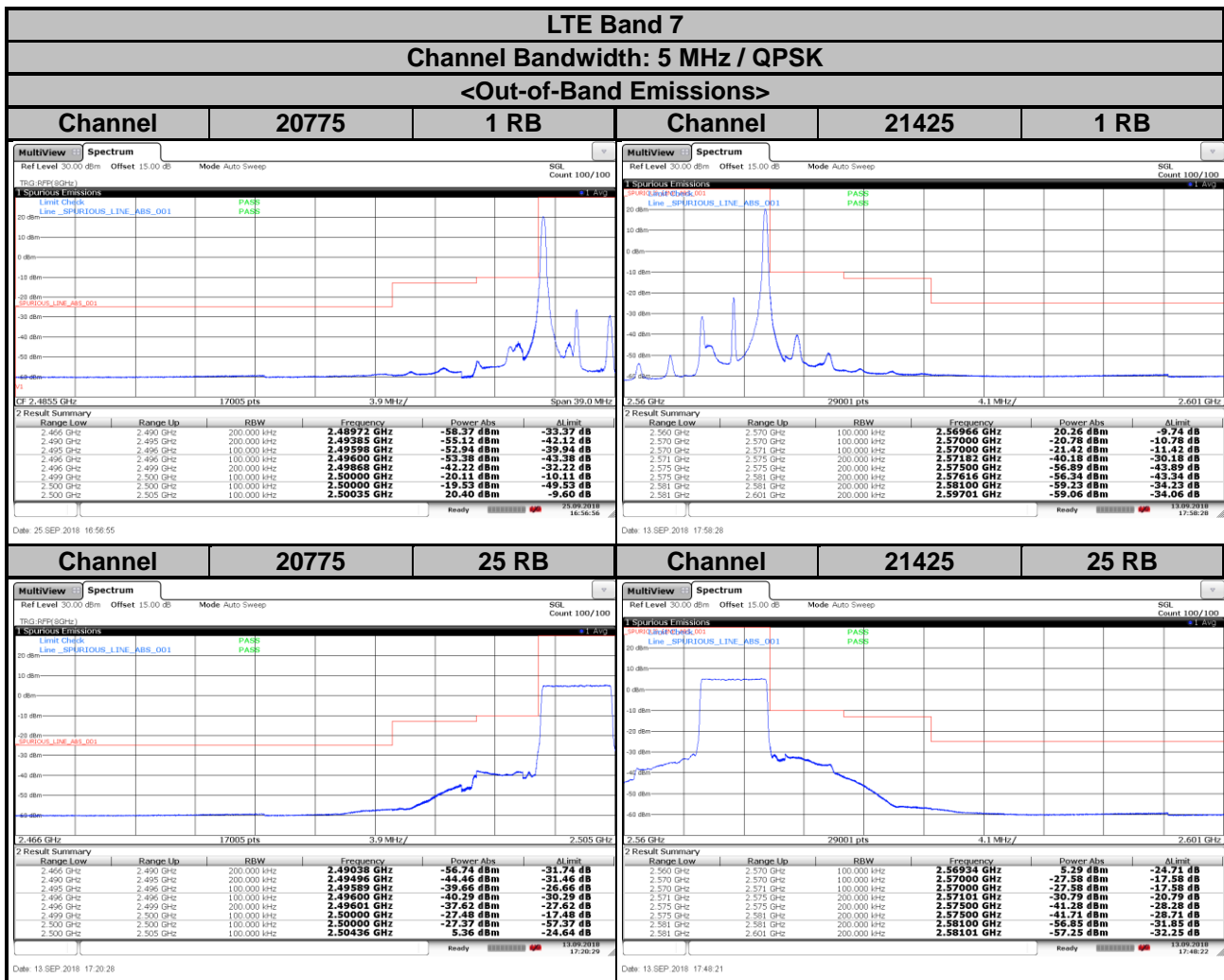

LTE Band 7
Channel Bandwidth: 5 MHz / 16QAM

<Out-of-Band Emissions>

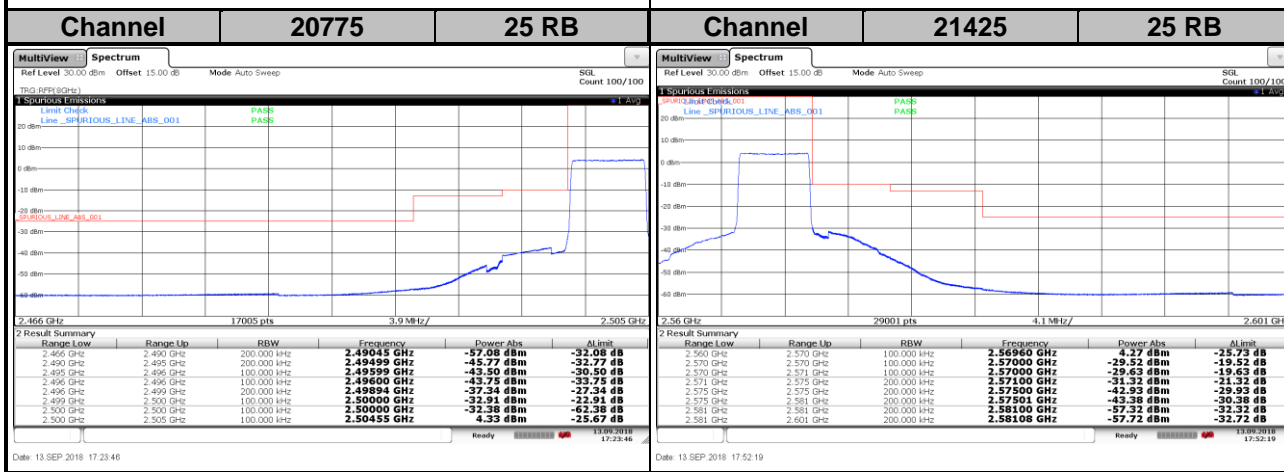
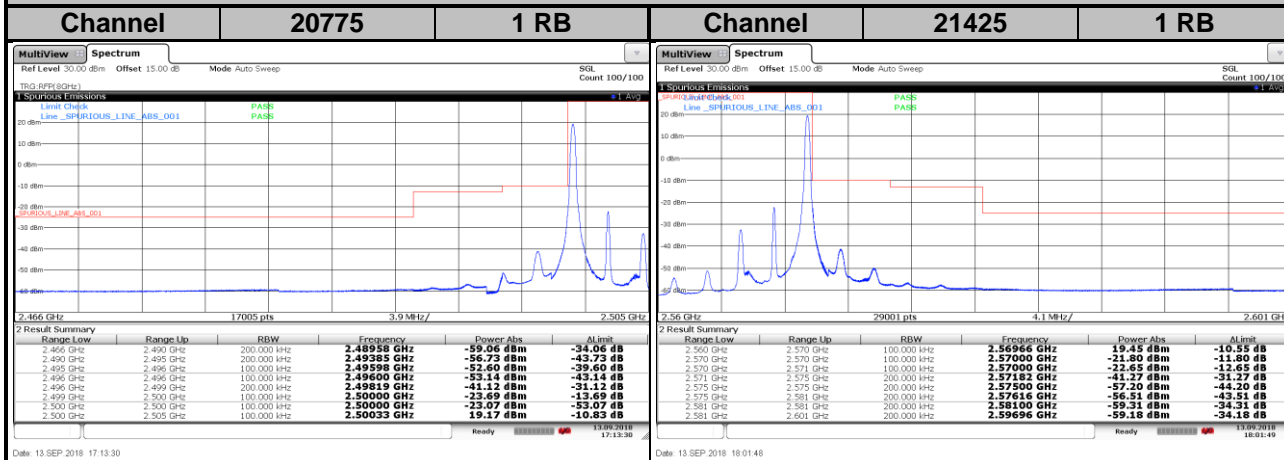

LTE Band 7
Channel Bandwidth: 5 MHz / 64QAM

<Out-of-Band Emissions>

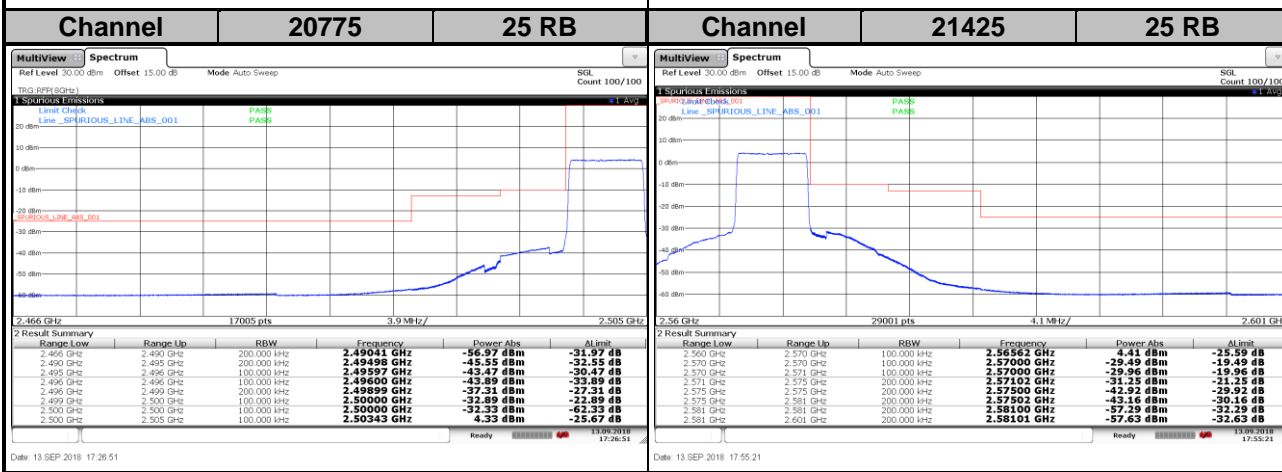
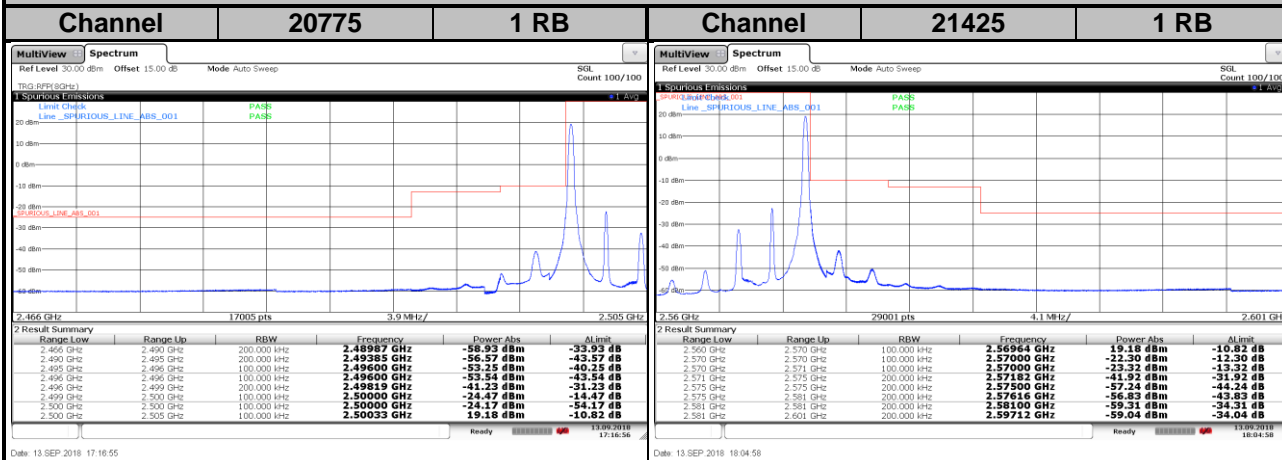

LTE Band 7
Channel Bandwidth: 10 MHz / QPSK

<Out-of-Band Emissions>

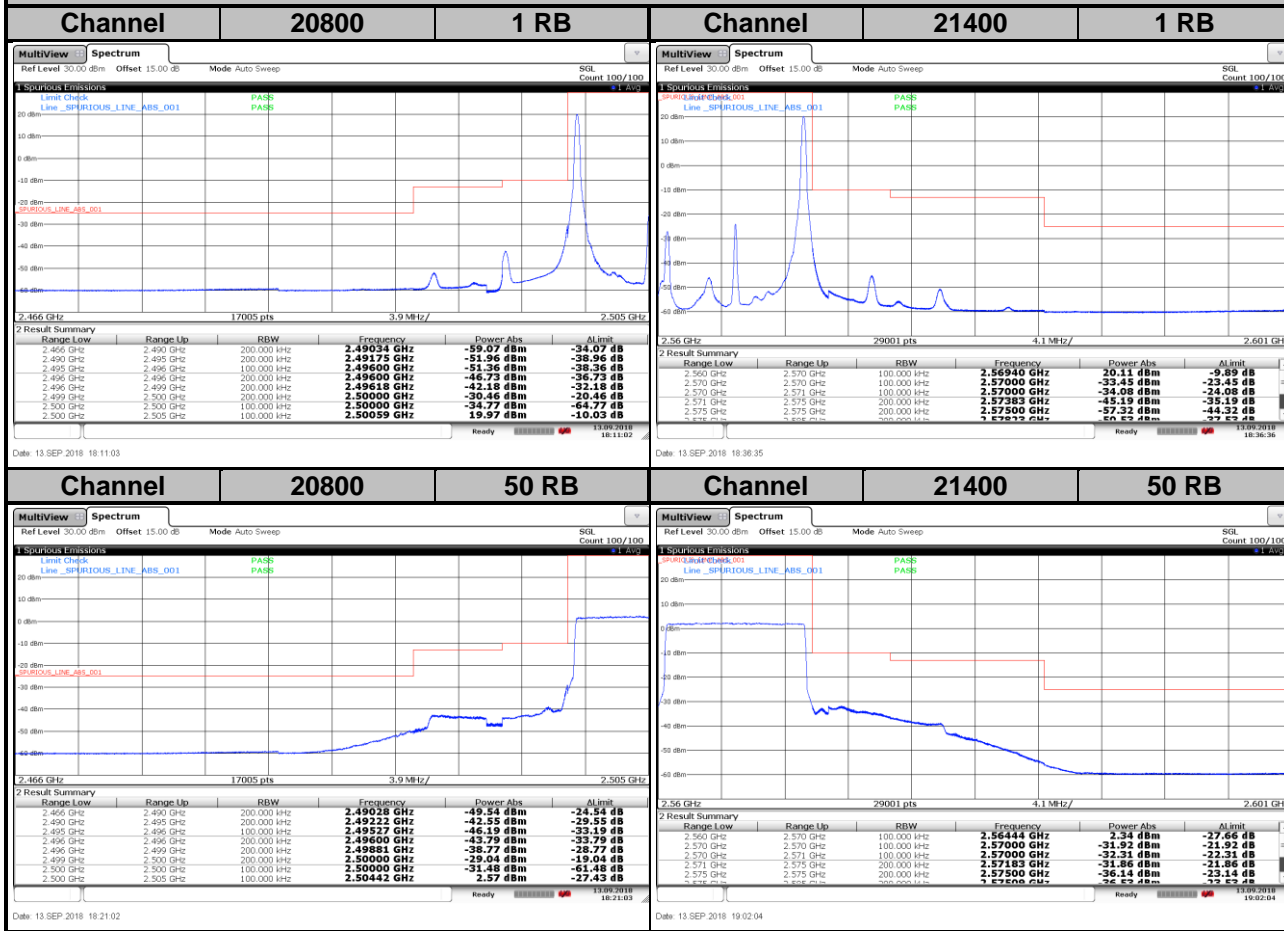

LTE Band 7
Channel Bandwidth: 10 MHz / 16QAM

<Out-of-Band Emissions>

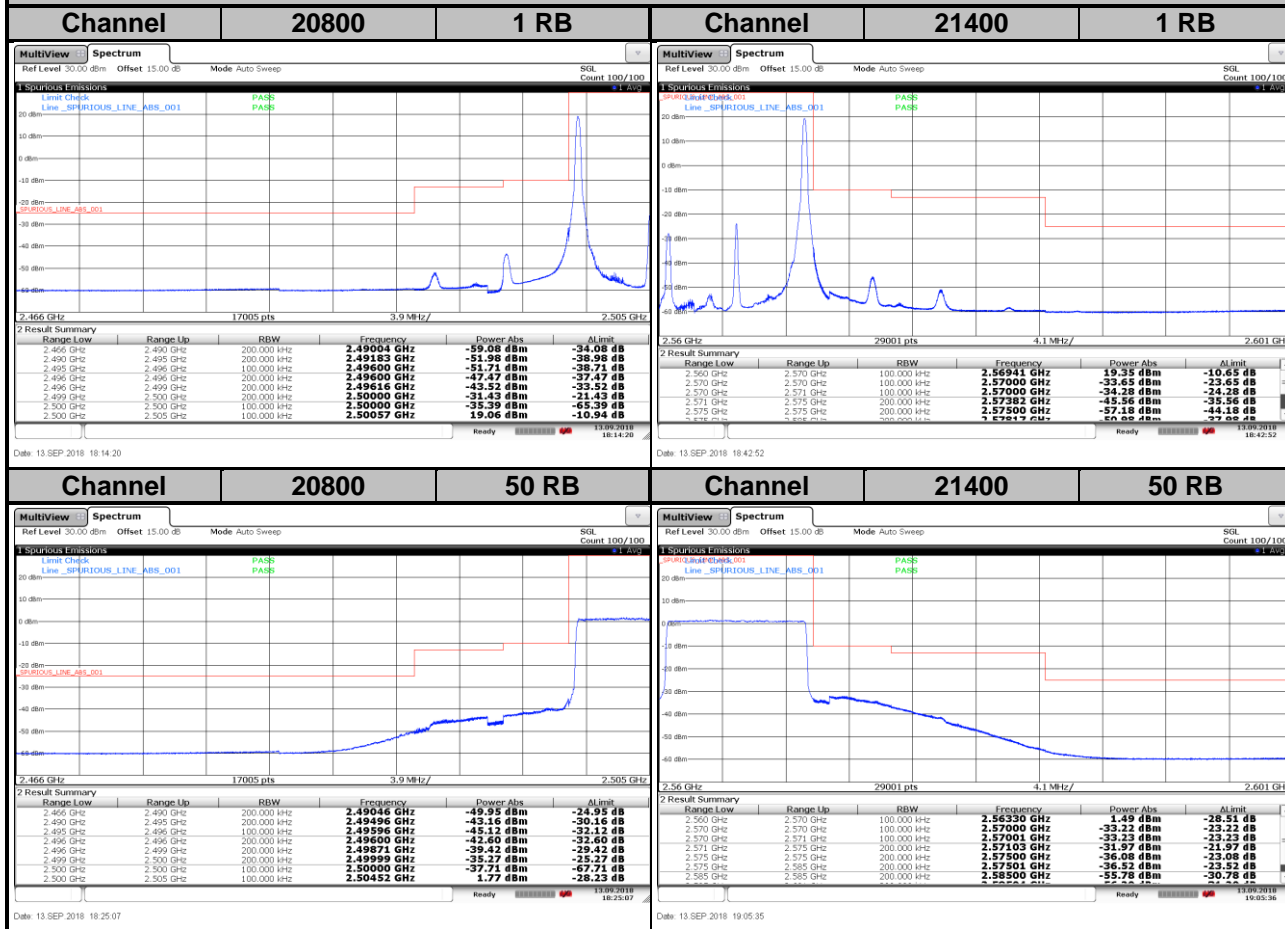

LTE Band 7
Channel Bandwidth: 10 MHz / 64QAM
<Out-of-Band Emissions>

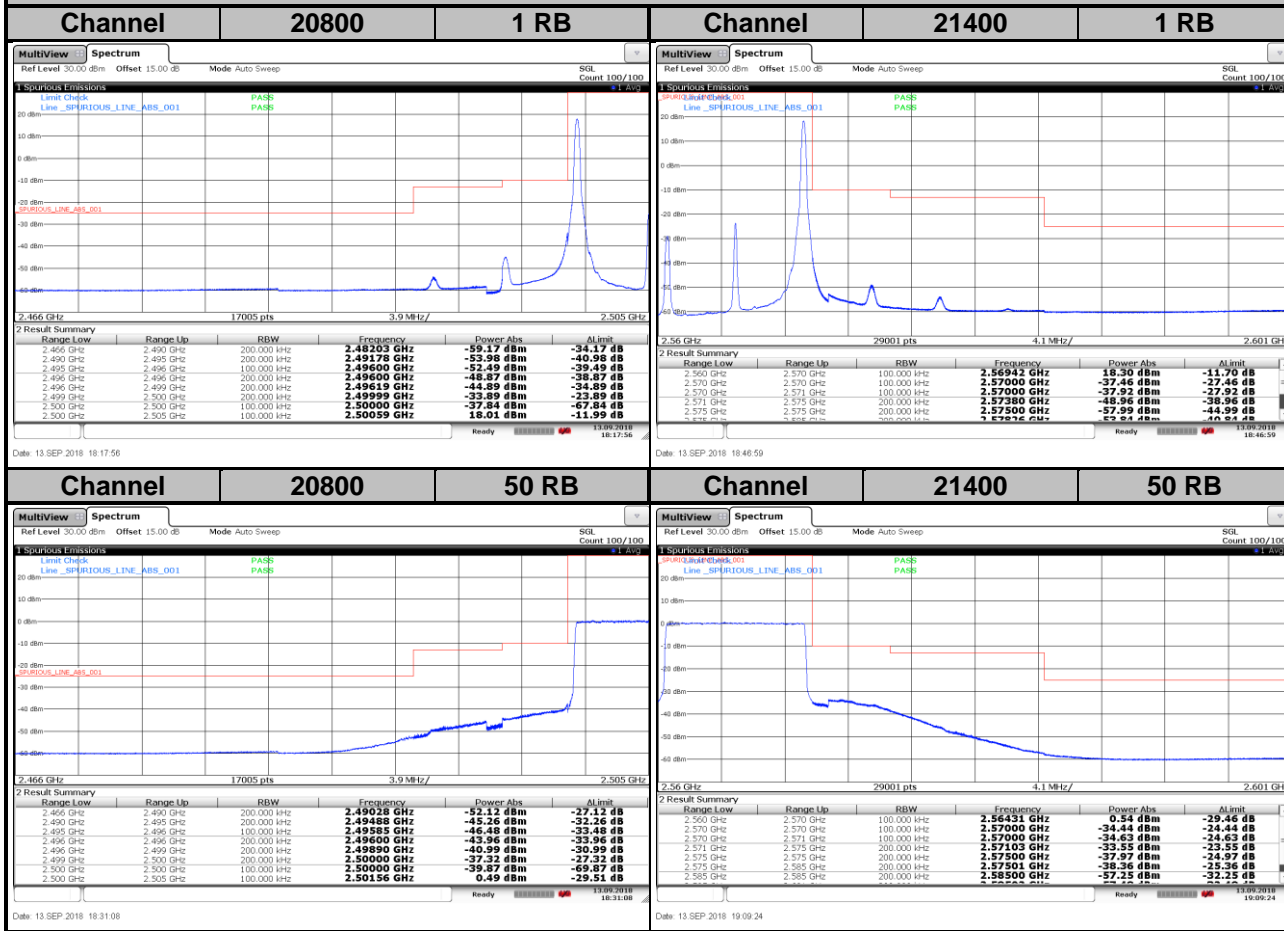

LTE Band 7
Channel Bandwidth: 15 MHz / QPSK
<Out-of-Band Emissions>

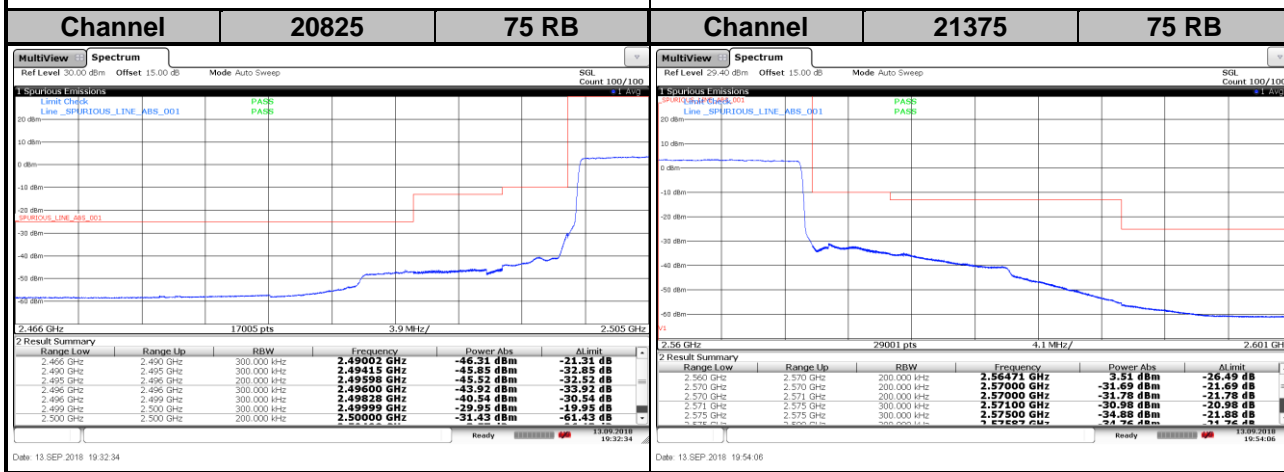
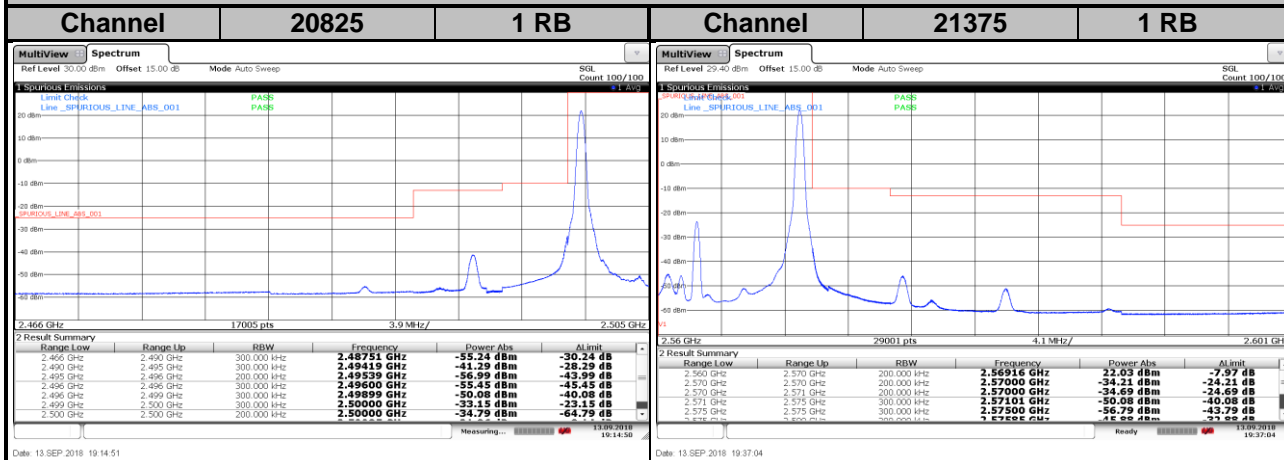

LTE Band 7
Channel Bandwidth: 15 MHz / 16QAM
<Out-of-Band Emissions>

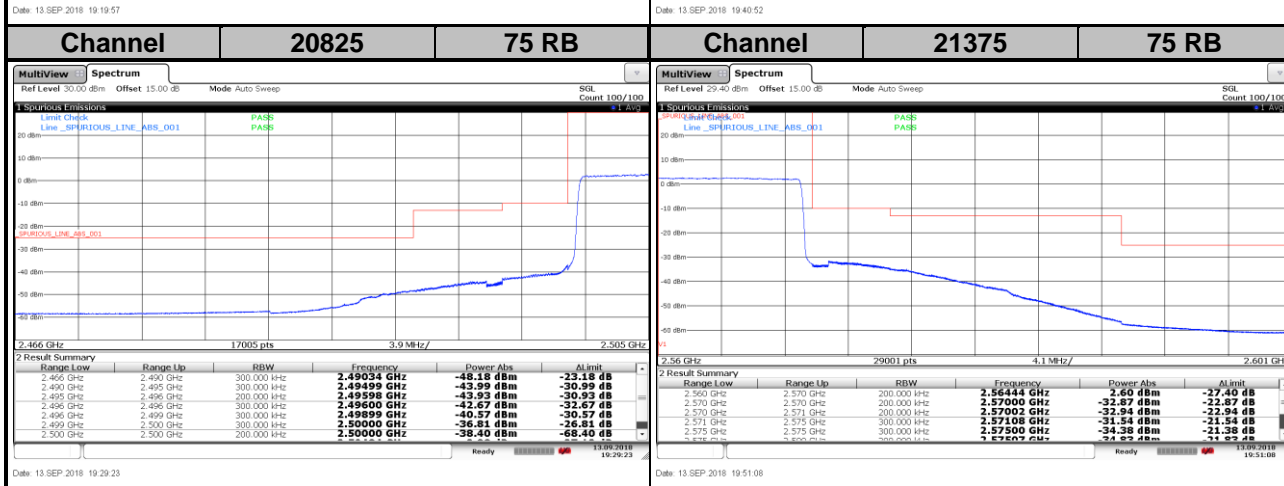
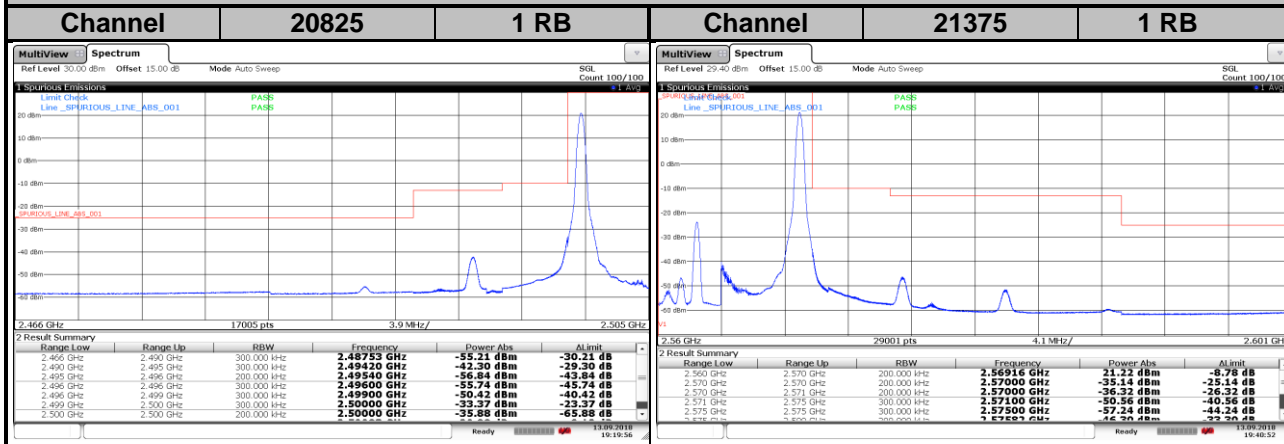

LTE Band 7
Channel Bandwidth: 15 MHz / 64QAM
<Out-of-Band Emissions>

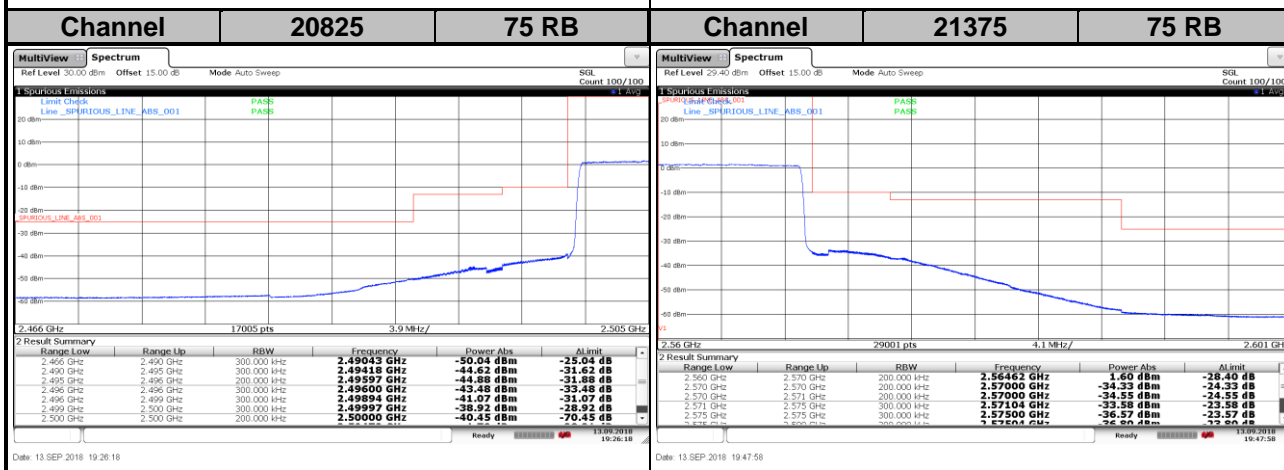
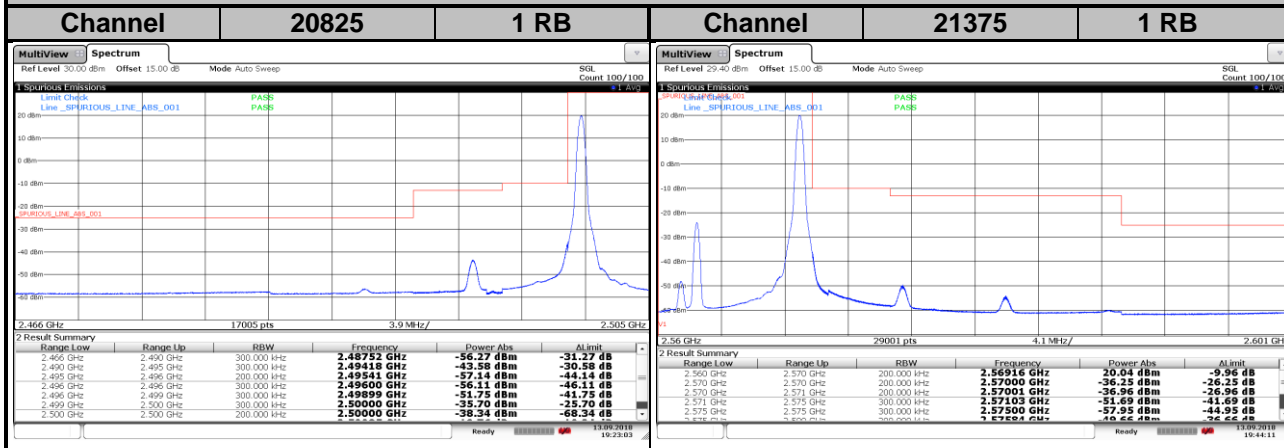

LTE Band 7
Channel Bandwidth: 20 MHz / QPSK
<Out-of-Band Emissions>

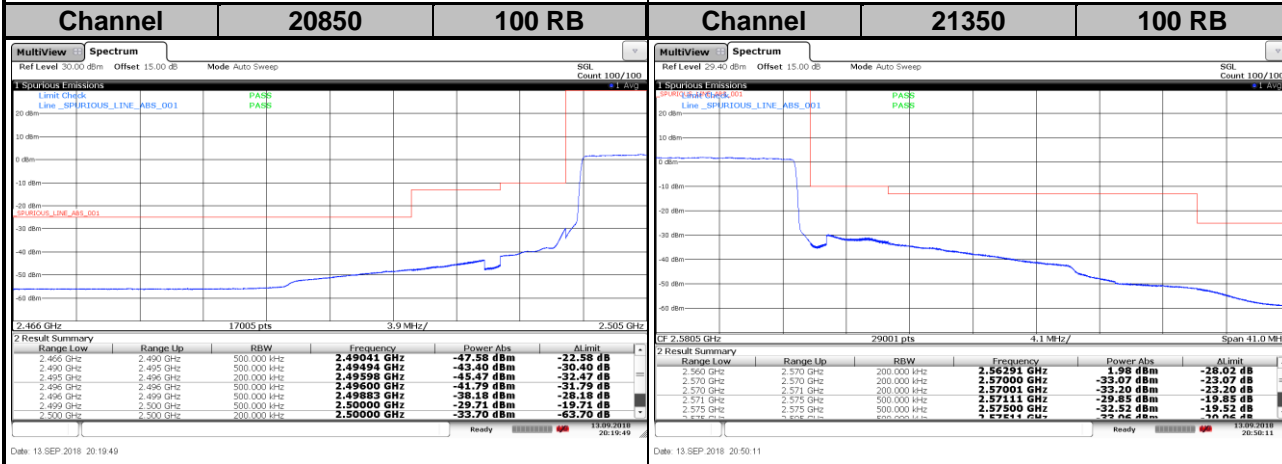
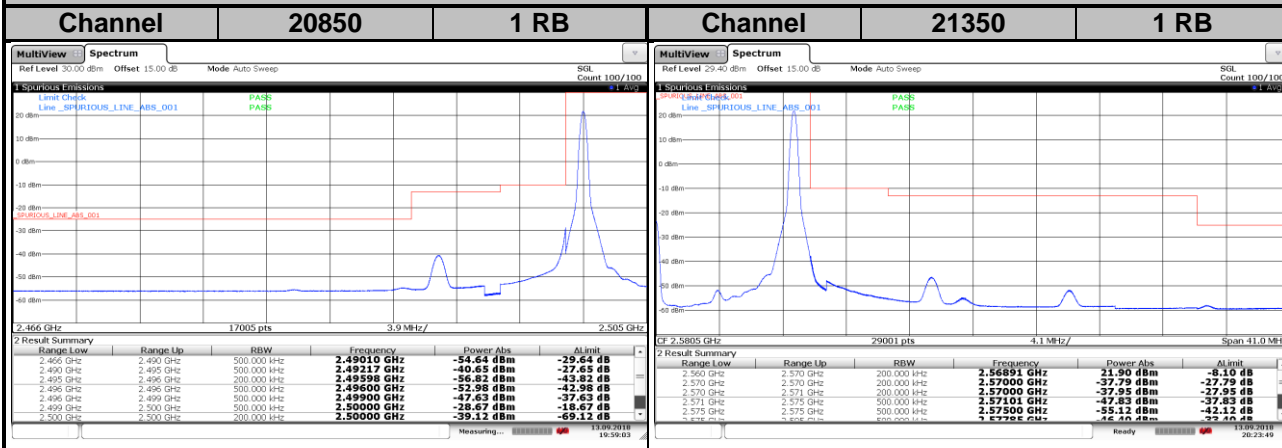

LTE Band 7
Channel Bandwidth: 20 MHz / 16QAM

<Out-of-Band Emissions>

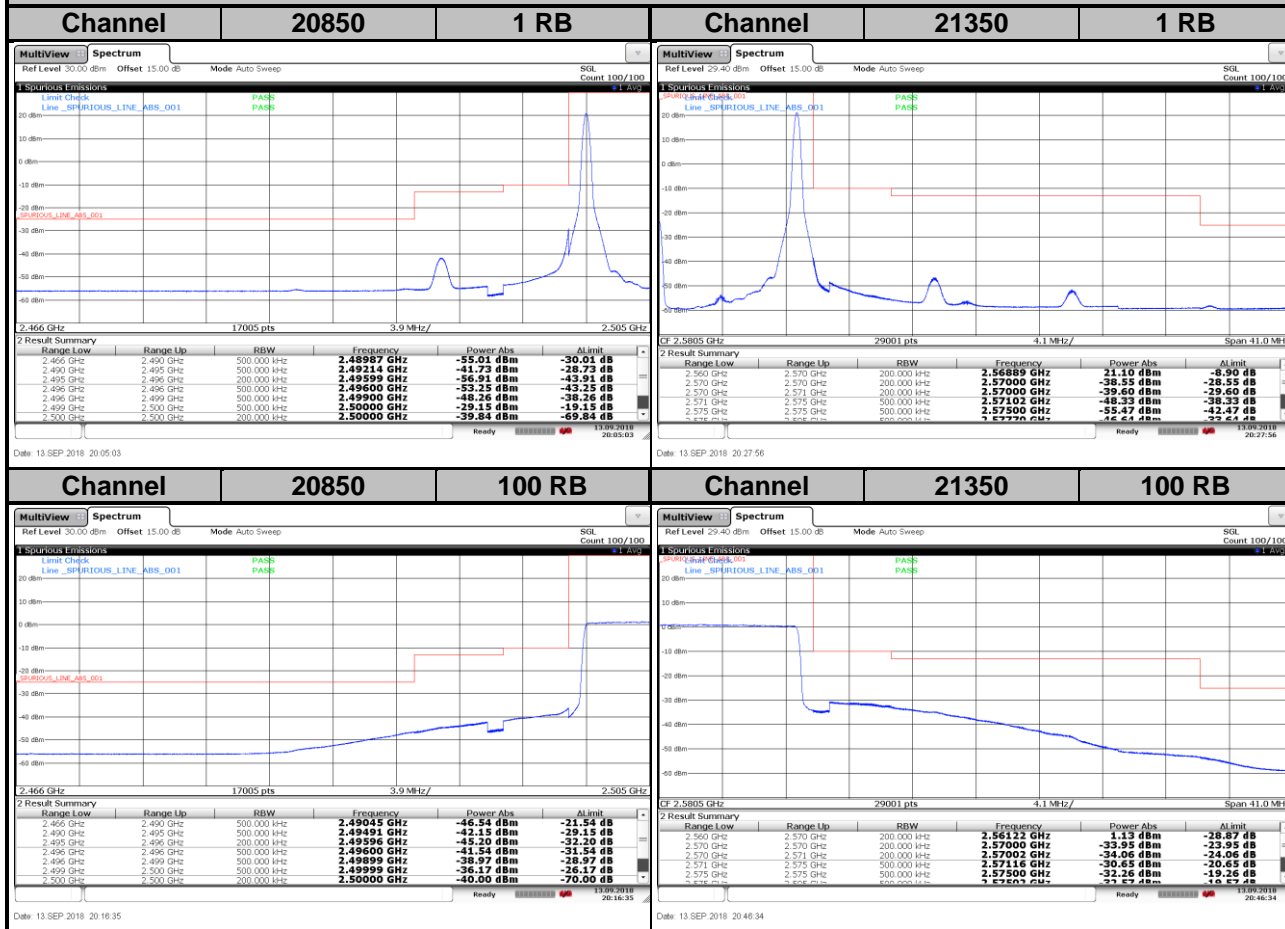

LTE Band 7
Channel Bandwidth: 20 MHz / 64QAM
<Out-of-Band Emissions>

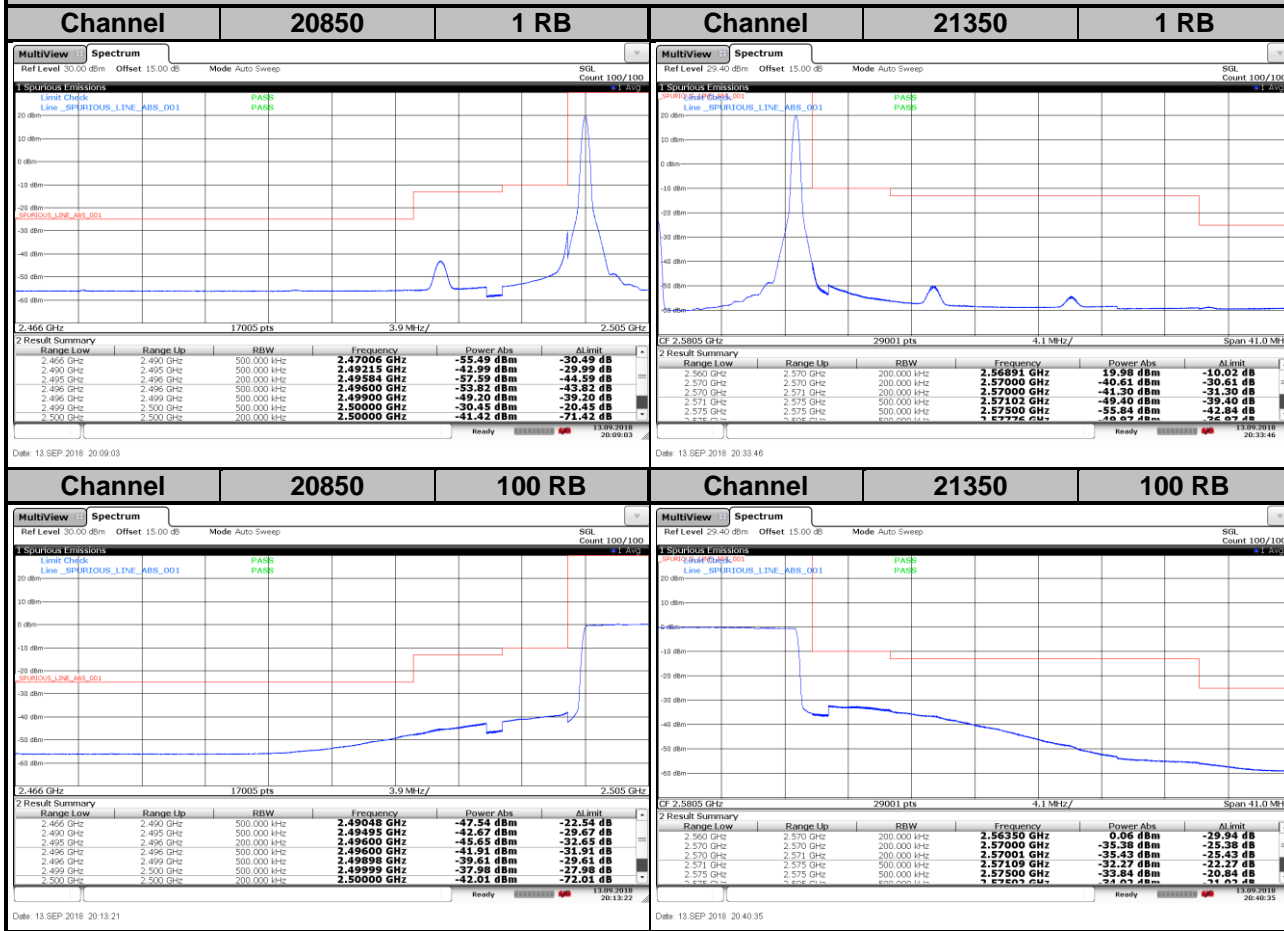

4.6 Peak to Average Ratio

4.6.1 Limits of Peak to Average Ratio Measurement

In measuring transmissions in this band using an average power technique, the peak to-average ratio (PAR) of the transmission may not exceed 13 dB.

4.6.2 Test Setup

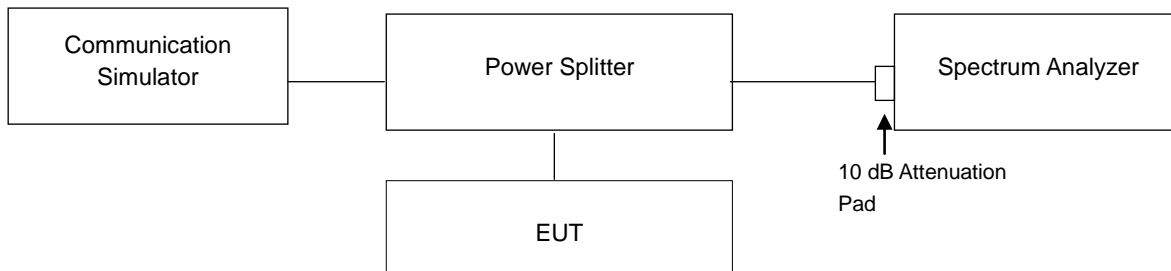

4.6.3 Test Procedures

1. Set resolution/measurement bandwidth \geq signal's occupied bandwidth;
2. Set the number of counts to a value that stabilizes the measured CCDF curve;
3. Record the maximum PAPR level associated with a probability of 0.1 %.

4.6.4 Test Results

LTE Band 7									
Channel Bandwidth: 5 MHz					Channel Bandwidth: 10 MHz				
Channel	Frequency (MHz)	Peak to Average Ratio (dB)			Channel	Frequency (MHz)	Peak to Average Ratio (dB)		
		QPSK	16QAM	64QAM			QPSK	16QAM	64QAM
20775	2502.5	3.47	5.09	6.47	20800	2505.0	3.41	5.10	6.47
21100	2535.0	3.77	5.56	6.91	21100	2535.0	3.70	5.44	6.95
21425	2567.5	3.84	5.58	7.12	21400	2565.0	3.76	5.54	7.07

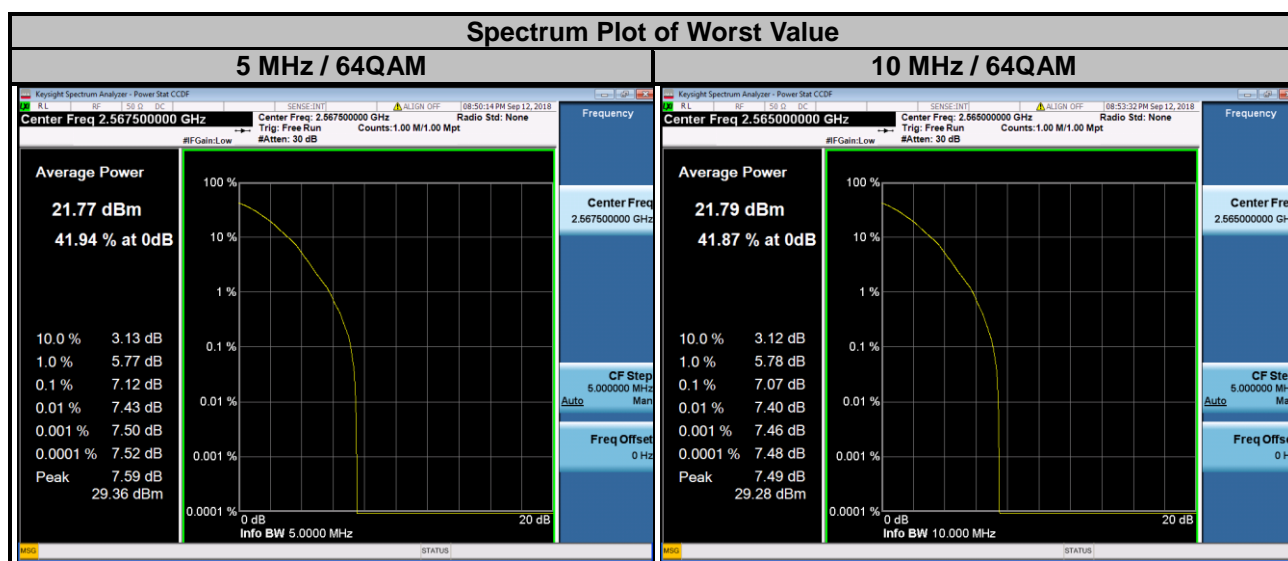

LTE Band 7									
Channel Bandwidth: 15 MHz					Channel Bandwidth: 20 MHz				
Channel	Frequency (MHz)	Peak to Average Ratio (dB)			Channel	Frequency (MHz)	Peak to Average Ratio (dB)		
		QPSK	16QAM	64QAM			QPSK	16QAM	64QAM
20825	2507.5	3.40	5.05	6.49	20850	2510.0	3.43	5.05	6.37
21100	2535.0	3.71	5.38	6.96	21100	2535.0	3.69	5.45	6.90
21375	2562.5	3.68	5.48	7.00	21350	2560.0	3.62	5.32	6.98

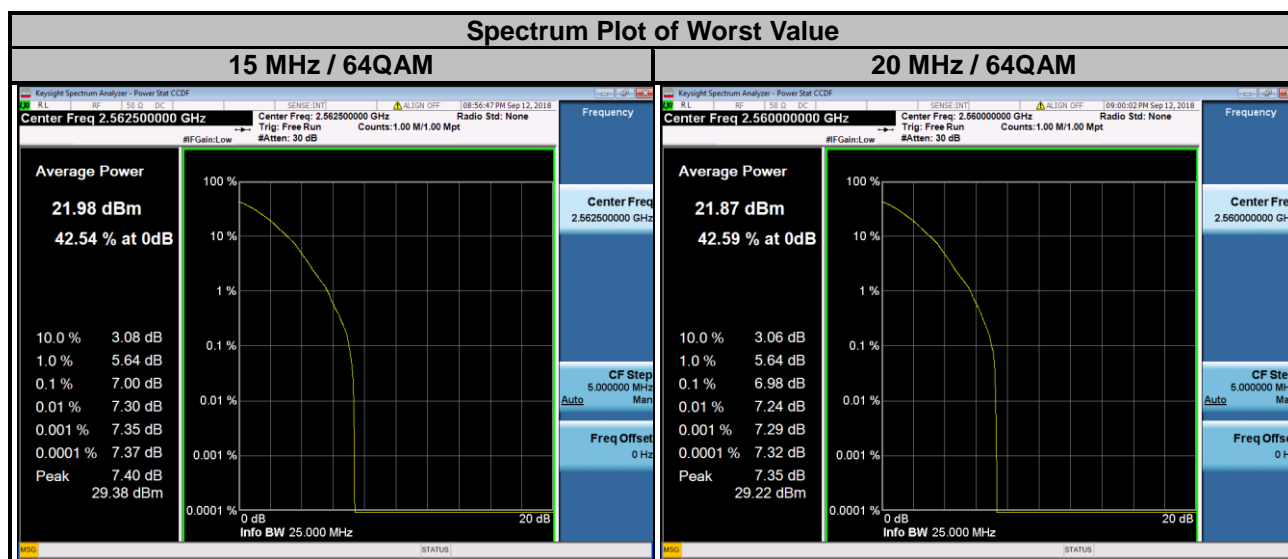

4.7 Conducted Spurious Emissions

4.7.1 Limits of Conducted Spurious Emissions Measurement

The power of any emission outside a licensee's frequency block shall be attenuated below the transmitter power (P) by at least $55 + 10 \log_{10}(P)$ dB. The limit of emission is equal to -25 dBm.

4.7.2 Test Setup

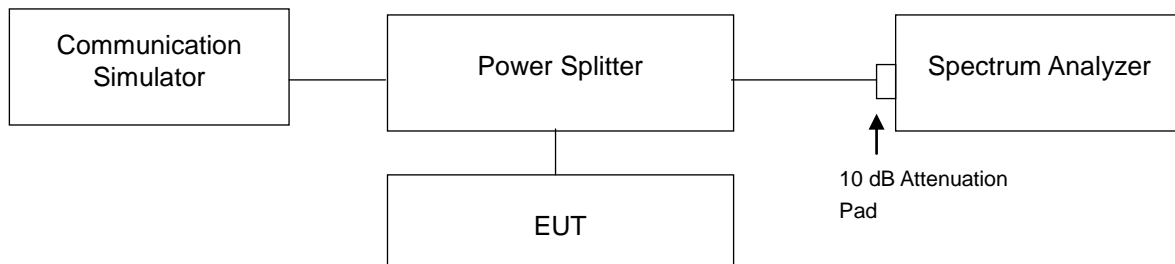

4.7.3 Test Procedure

- The EUT makes a phone call to the communication simulator. All measurements were done at low, middle and high operational frequency range.
- Measuring frequency range from 9 kHz to 3 GHz, 10 dB attenuation pad is connected with spectrum. RBW = 100 kHz and VBW = 300 kHz are used for conducted emission measurement.
- Measuring frequency range is from 3 GHz to 27 GHz, 10 dB attenuation pad is connected with spectrum. RBW = 1 MHz and VBW = 3 MHz are used for conducted emission measurement.

4.7.4 Test Results

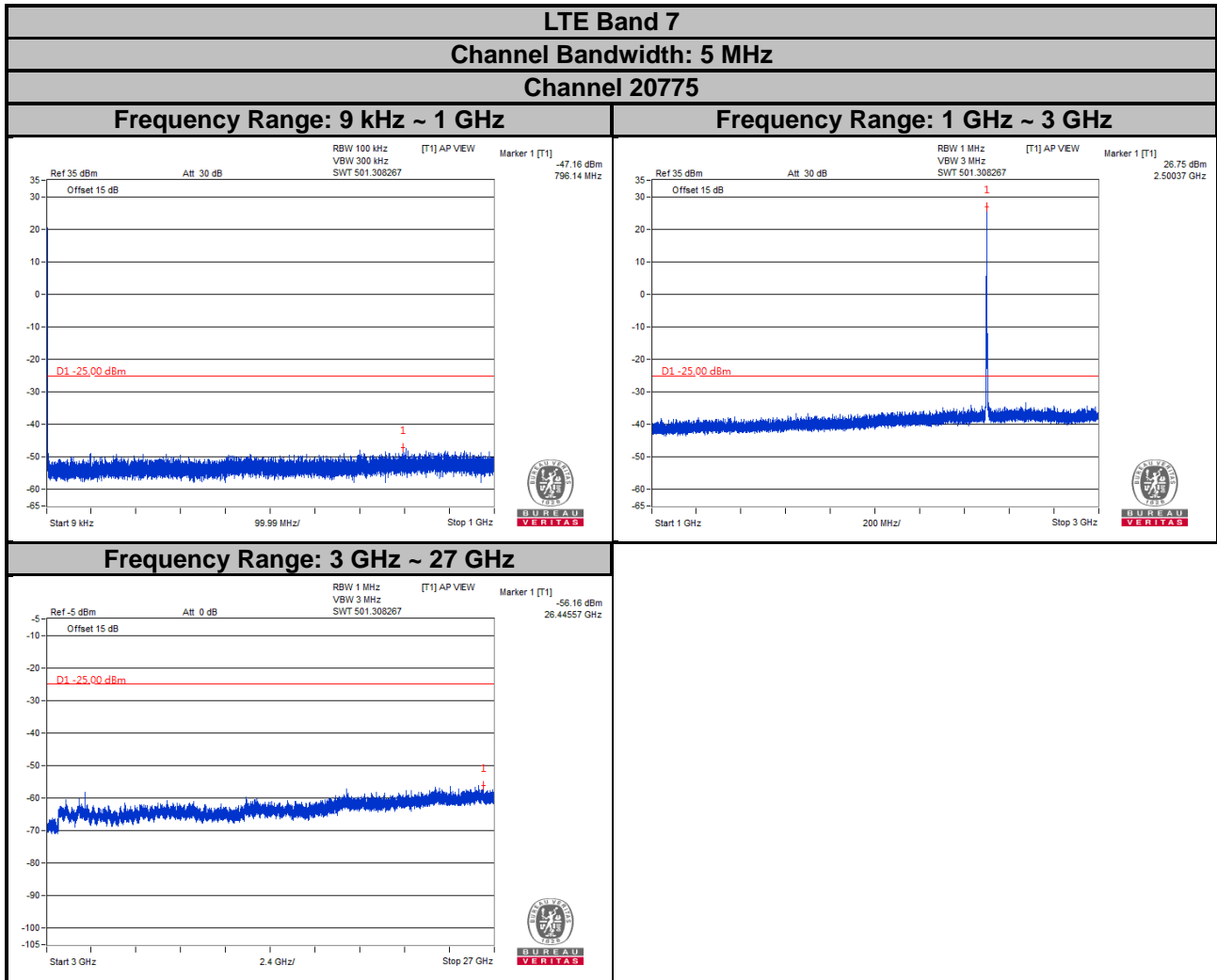

LTE Band 7
Channel Bandwidth: 5 MHz
Channel 21100

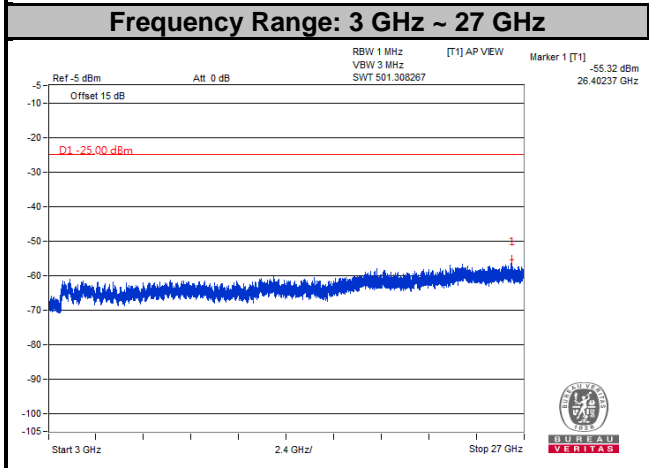
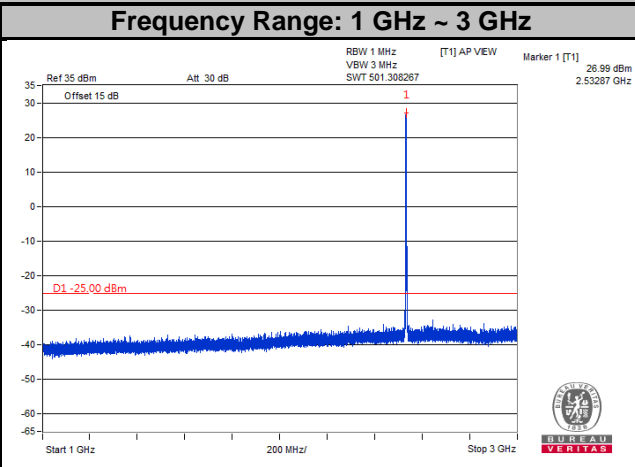
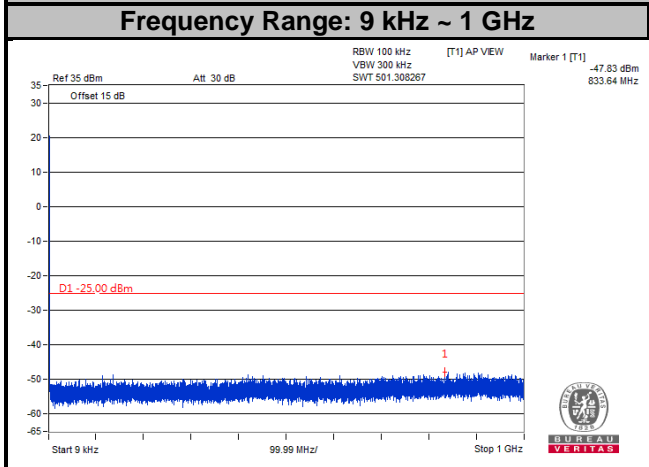

LTE Band 7
Channel Bandwidth: 5 MHz
Channel 21425

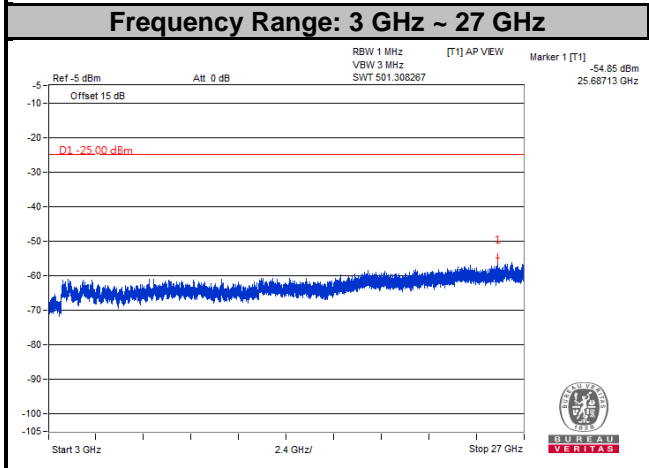
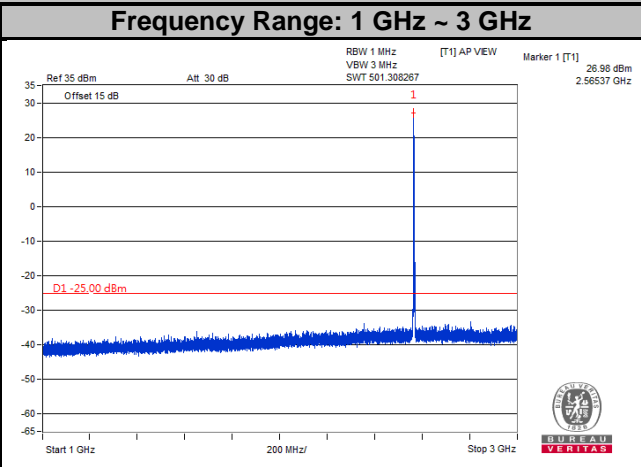
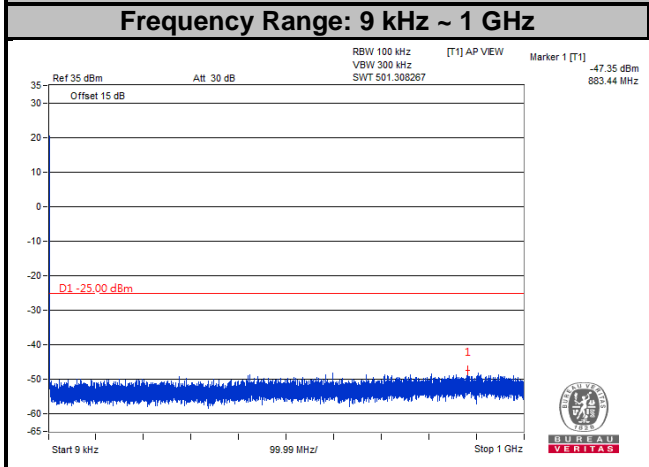

LTE Band 7
Channel Bandwidth: 10 MHz
Channel 20800

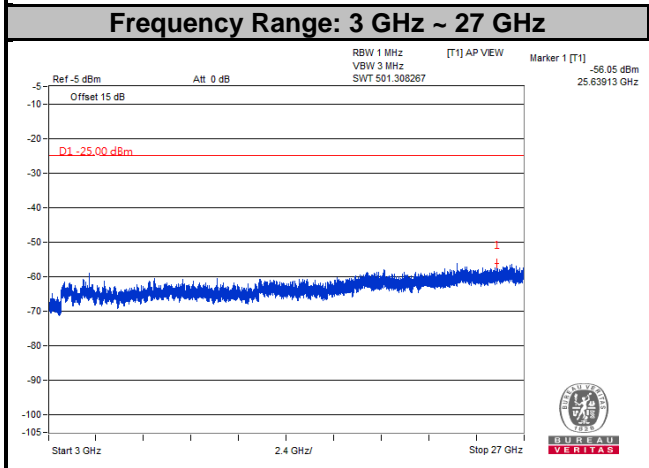
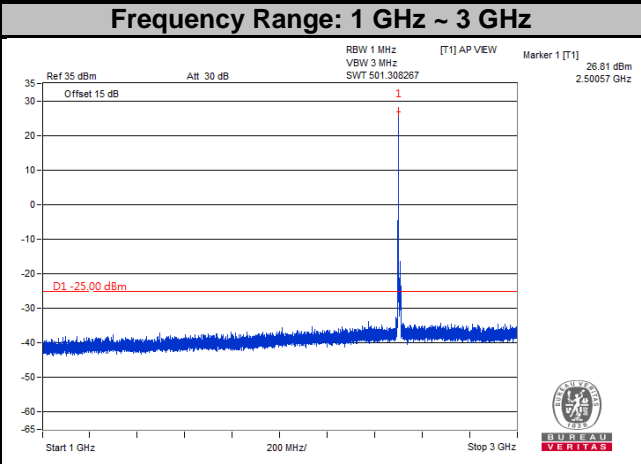
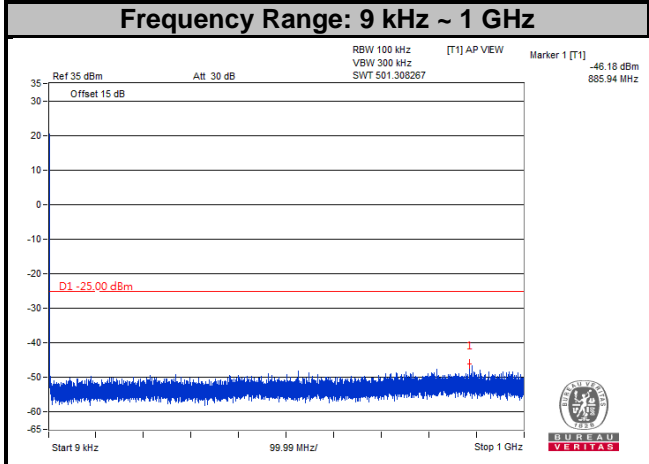

LTE Band 7
Channel Bandwidth: 10 MHz
Channel 21100

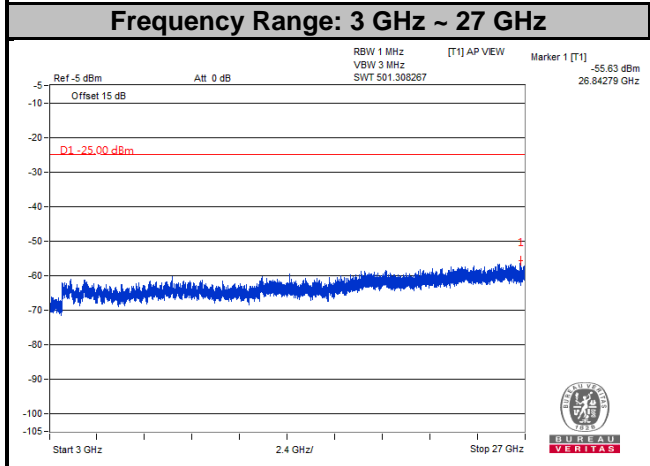
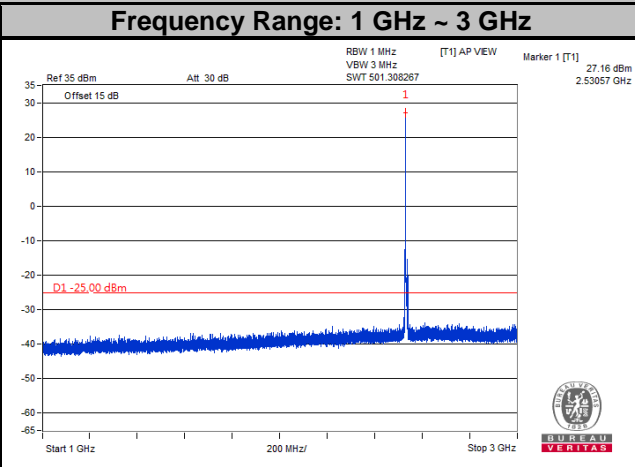
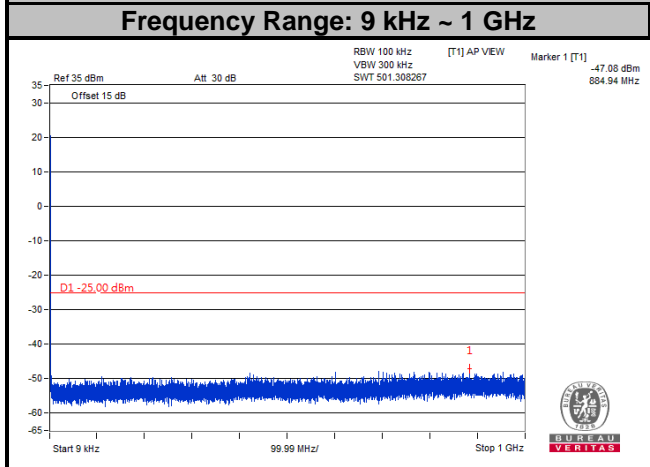

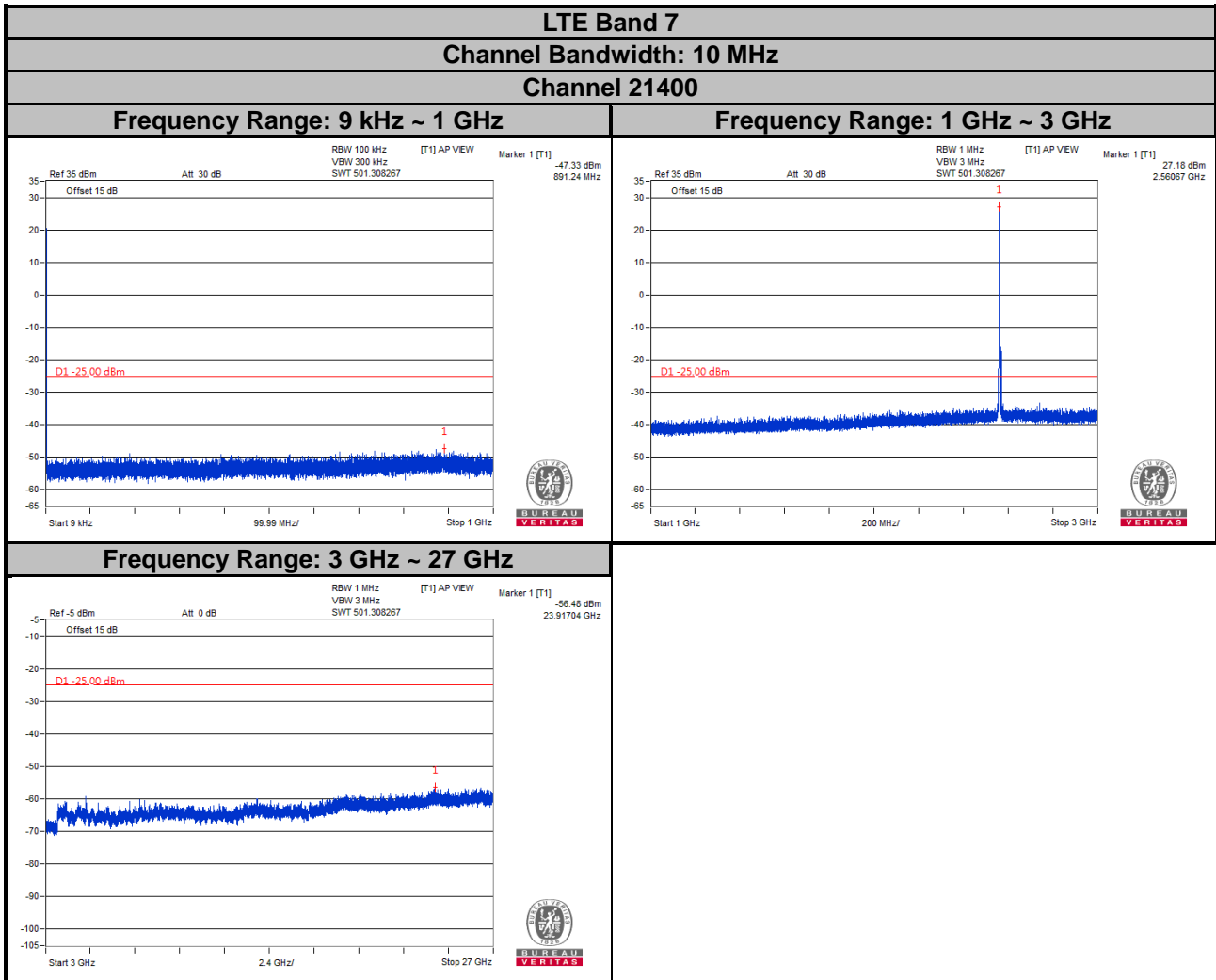

LTE Band 7
Channel Bandwidth: 15 MHz
Channel 20825

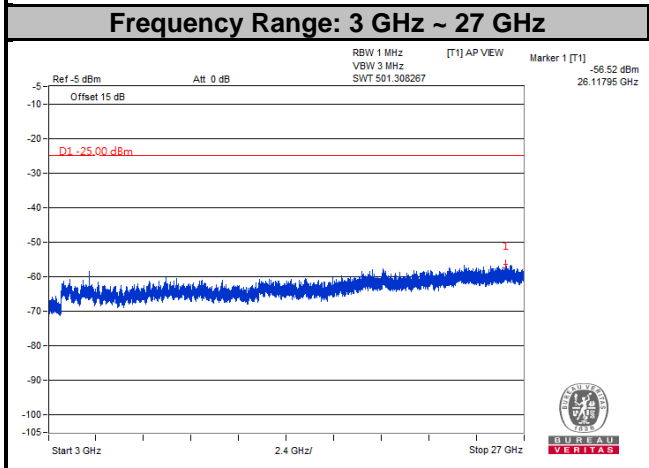
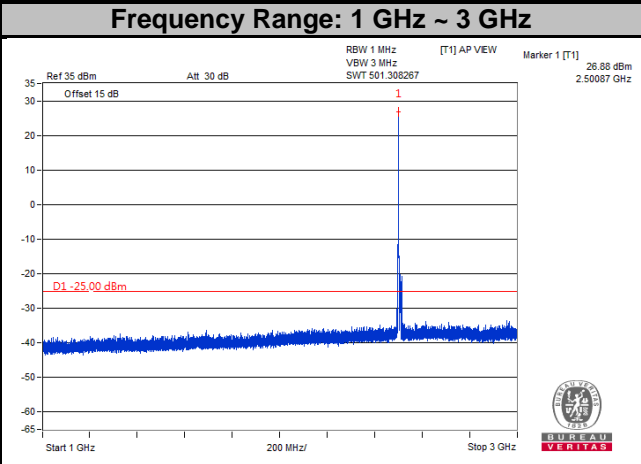
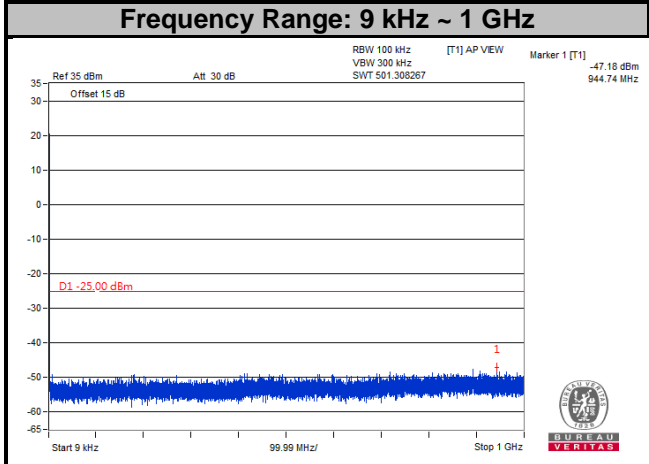

LTE Band 7
Channel Bandwidth: 15 MHz
Channel 21100

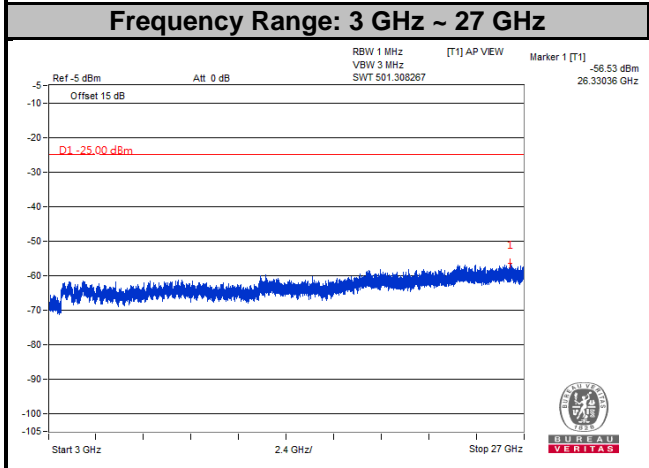
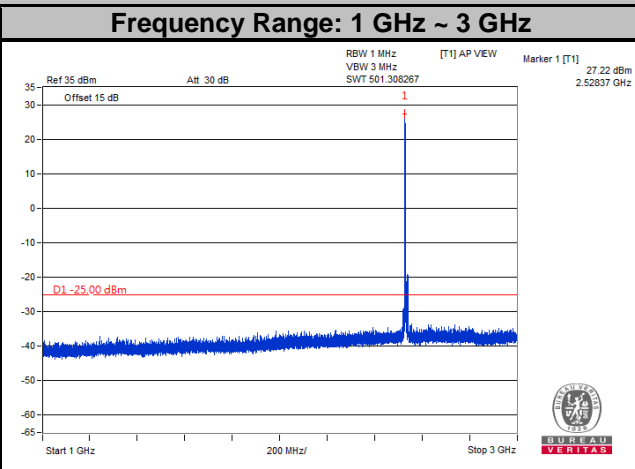
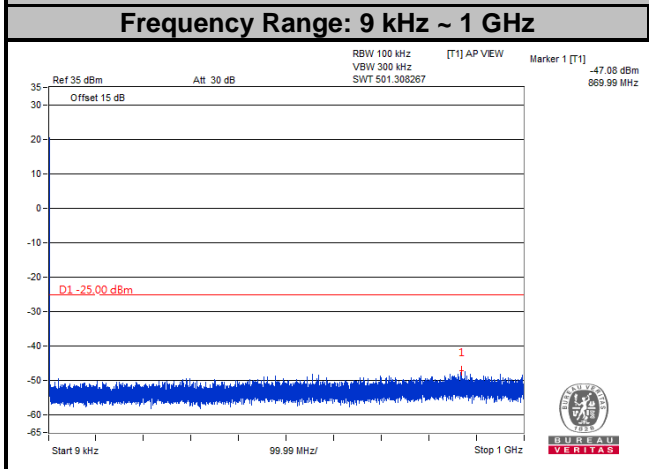

LTE Band 7
Channel Bandwidth: 15 MHz
Channel 21375

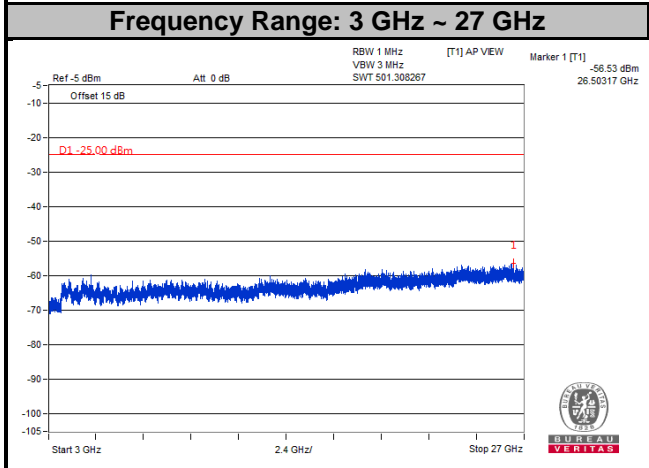
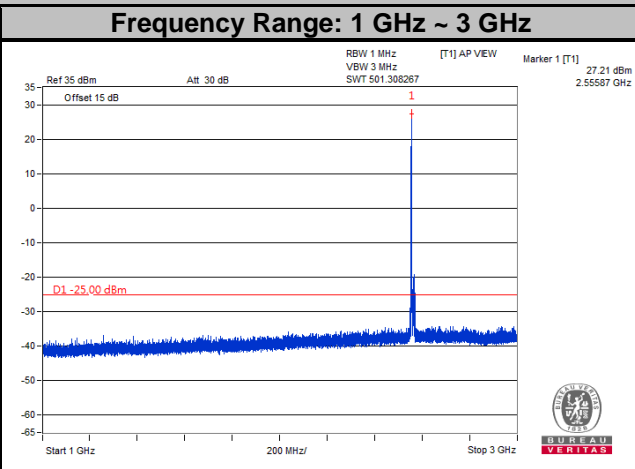
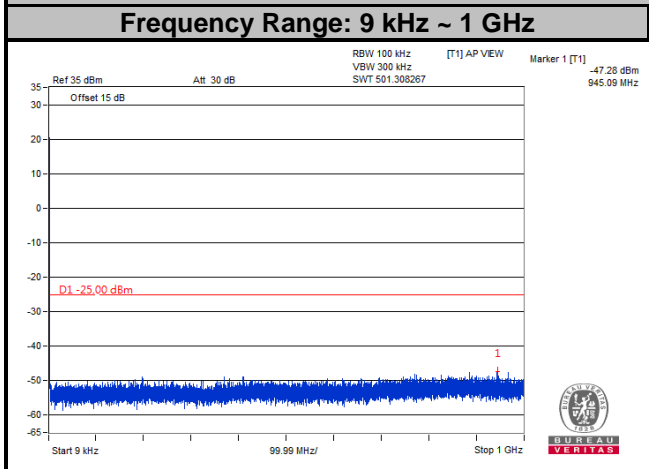

LTE Band 7
Channel Bandwidth: 20 MHz
Channel 20850

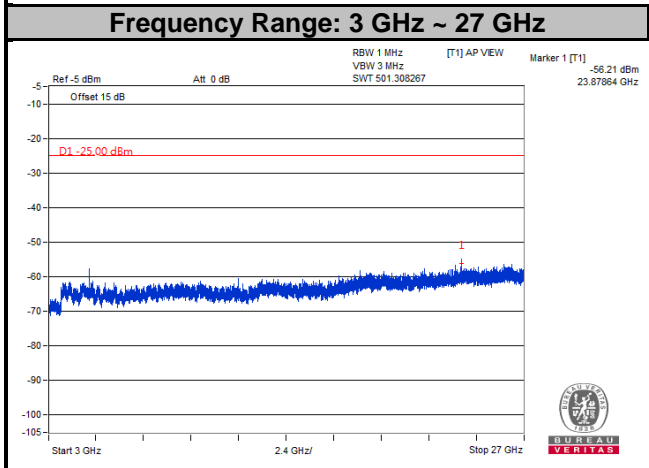
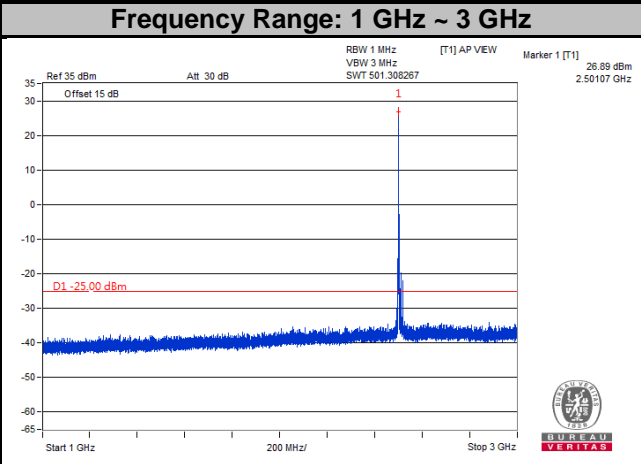
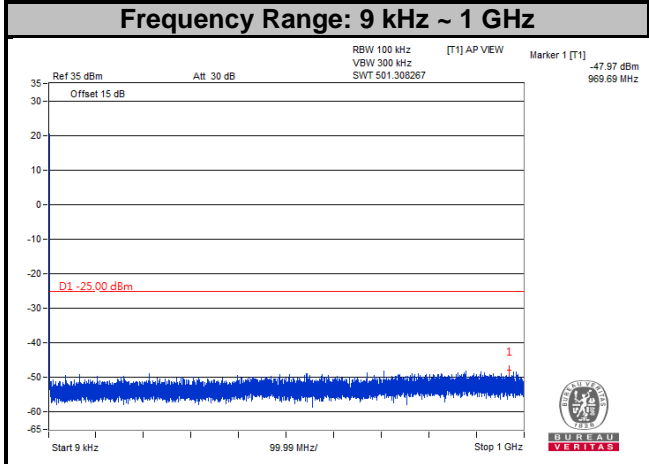

LTE Band 7
Channel Bandwidth: 20 MHz
Channel 21100

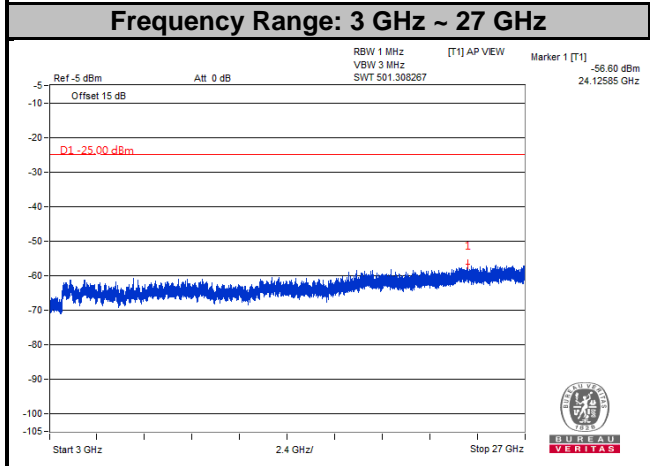
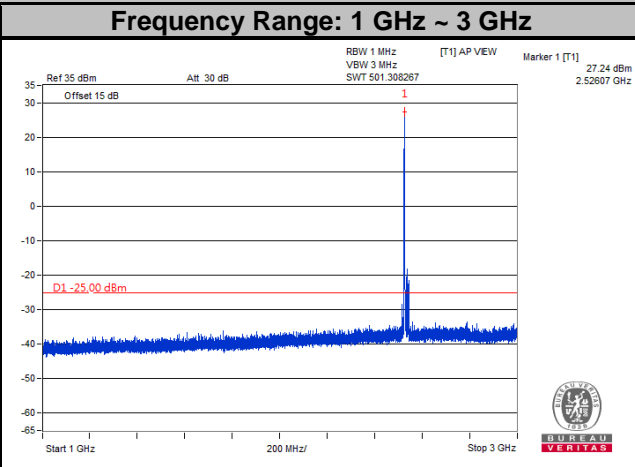
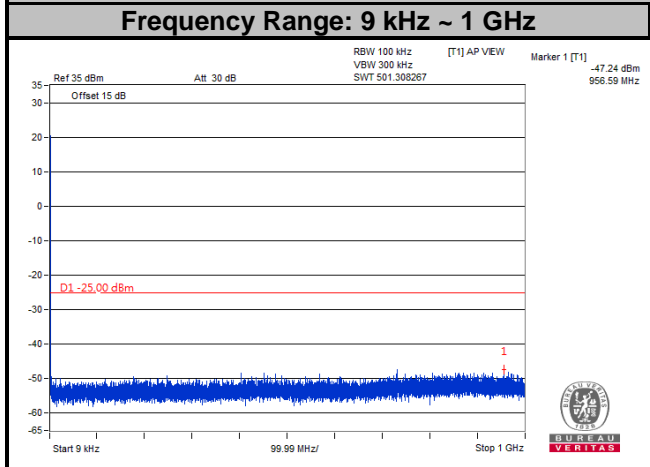

LTE Band 7
Channel Bandwidth: 20 MHz
Channel 21350

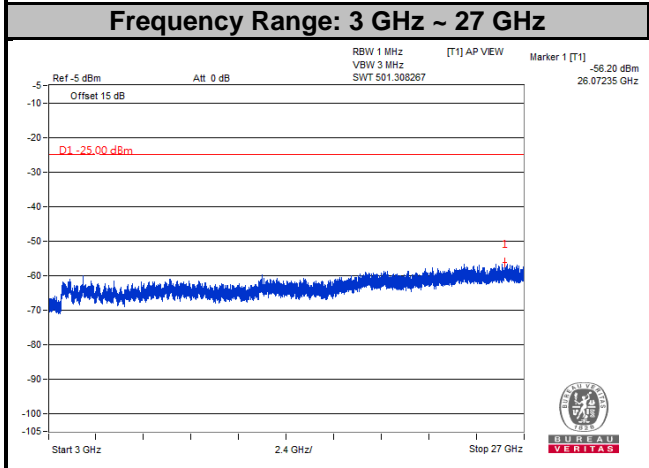
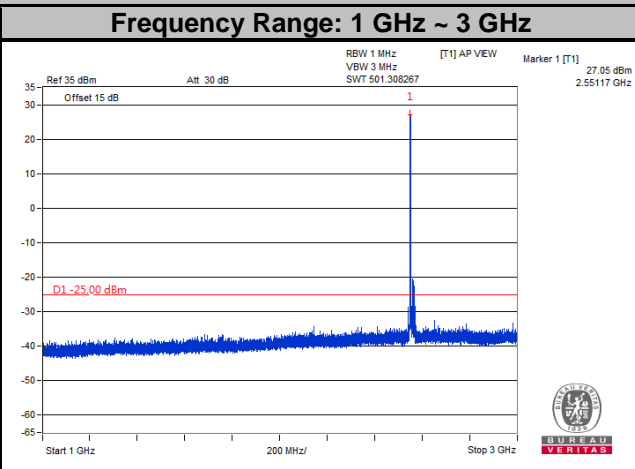
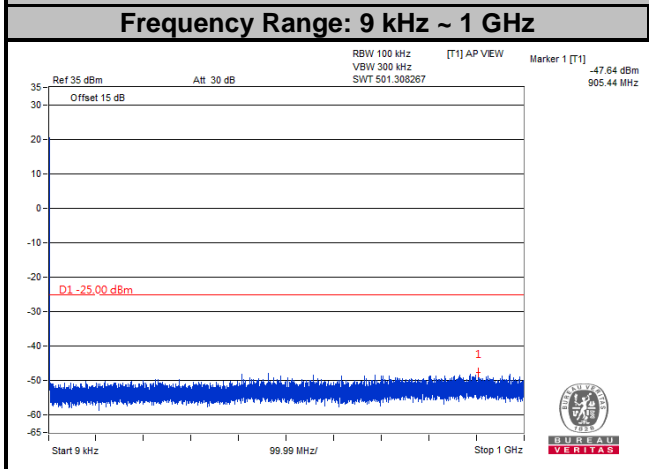

4.8 Radiated Emission Measurement

4.8.1 Limits of Radiated Emission Measurement

The power of any emission outside a licensee's frequency block shall be attenuated below the transmitter power (P) by at least $55 + 10 \log_{10}(P)$ dB. The limit of emission is equal to -25 dBm.

4.8.2 Test Procedure

- a. Substitution method is used for E.I.R.P measurement. In the semi-anechoic chamber, EUT placed on the 0.8 m (below or equal 1 GHz) and/or 1.5 m (above 1 GHz) height of Turn Table, rotated the table around 360 degrees to search the maximum radiation power and receiver antenna shall be rotated vertical and horizontal polarization and moved height from 1 m to 4 m to find the maximum polar radiated power. The "Read Value" is the spectrum reading the maximum power value.
- b. The substitution horn antenna is substituted for EUT at the same position and signals generator export the CW signal to the substitution antenna via a TX cable. Rotated the Turn Table and moved receiving antenna to find the maximum radiation power. Adjust output power level of S.G to get a Value of spectrum reading equal to "Read Value" of step a. Record the power level of S.G.
- c. EIRP = Output power level of S.G – TX cable loss + Antenna gain of substitution horn.
- d. E.R.P power can be calculated form E.I.R.P power by subtracting the gain of dipole, E.R.P power = E.I.R.P power - 2.15 dB.

NOTE: The resolution bandwidth of spectrum analyzer is 1 MHz and the video bandwidth is 3 MHz.

4.8.3 Deviation from Test Standard

No deviation.

4.8.4 Test Setup

<Radiated Emission below or equal 1 GHz>

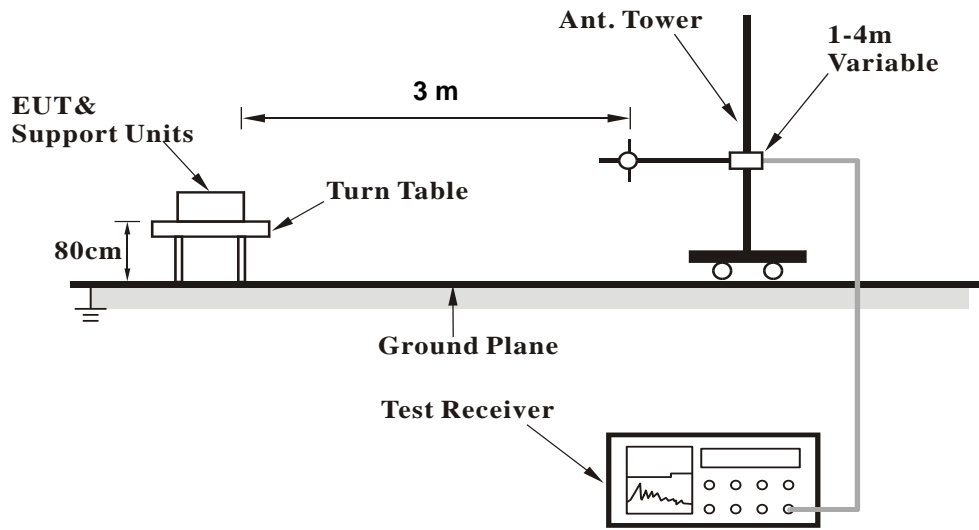

<Radiated Emission above 1 GHz>

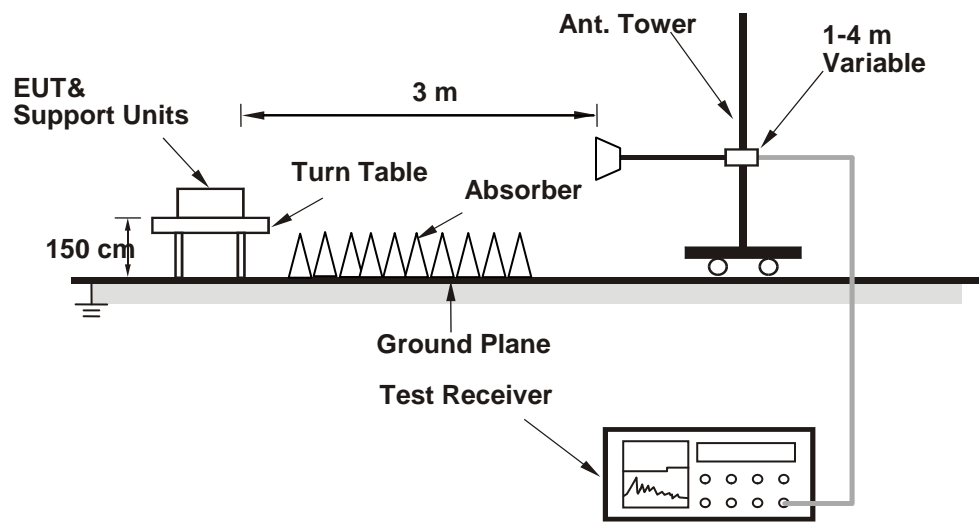

For the actual test configuration, please refer to the attached file (Test Setup Photo).

4.8.5 Test Results

LTE Band 7

Channel Bandwidth: 5 MHz / QPSK

Low Channel



Bureau Veritas Consumer Products Services Ltd., Taoyuan Branch

A D T

Data: 9

Date: 2018-09-13

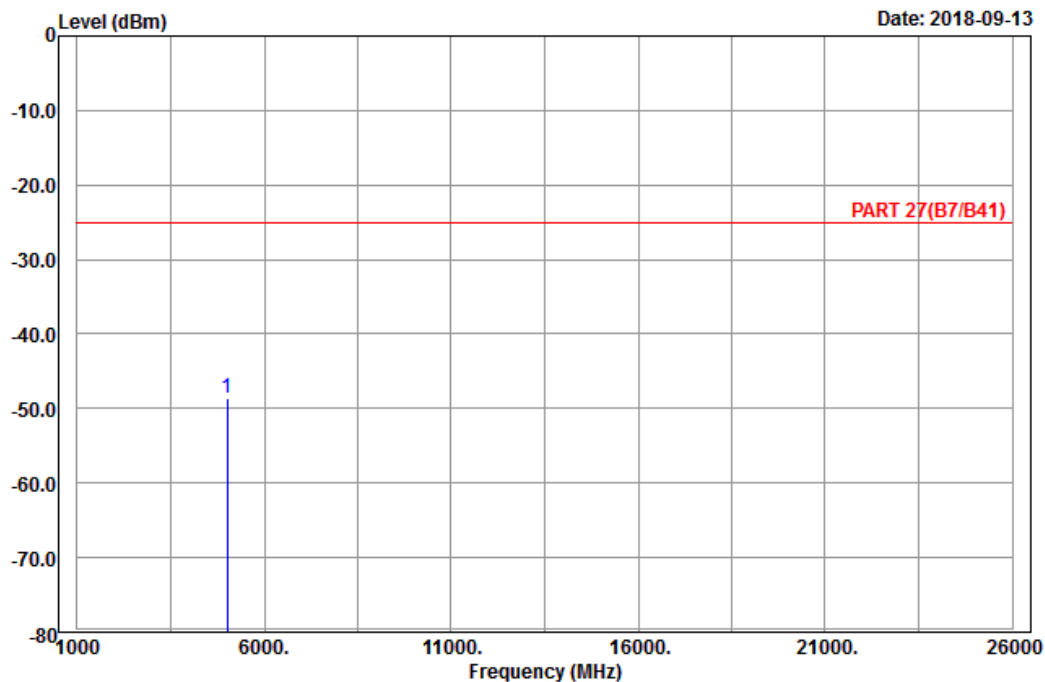

Site : 966 chamber 1
 Condition: PART 27(B7/B41) Horizontal
 Remark : LTE_Band 7_Link_CH20775
 Tested by: Harry Hsueh

Freq	Level	Read Level	Limit Line	Over Limit	Factor	Remark
MHz	dBm	dBm	dBm	dB	dB	
1 pp 5005.00	-48.61	-68.19	-25.00	-23.61	19.58	Peak



Bureau Veritas Consumer Products Services Ltd., Taoyuan Branch

A D T

Data: 10

Date: 2018-09-13

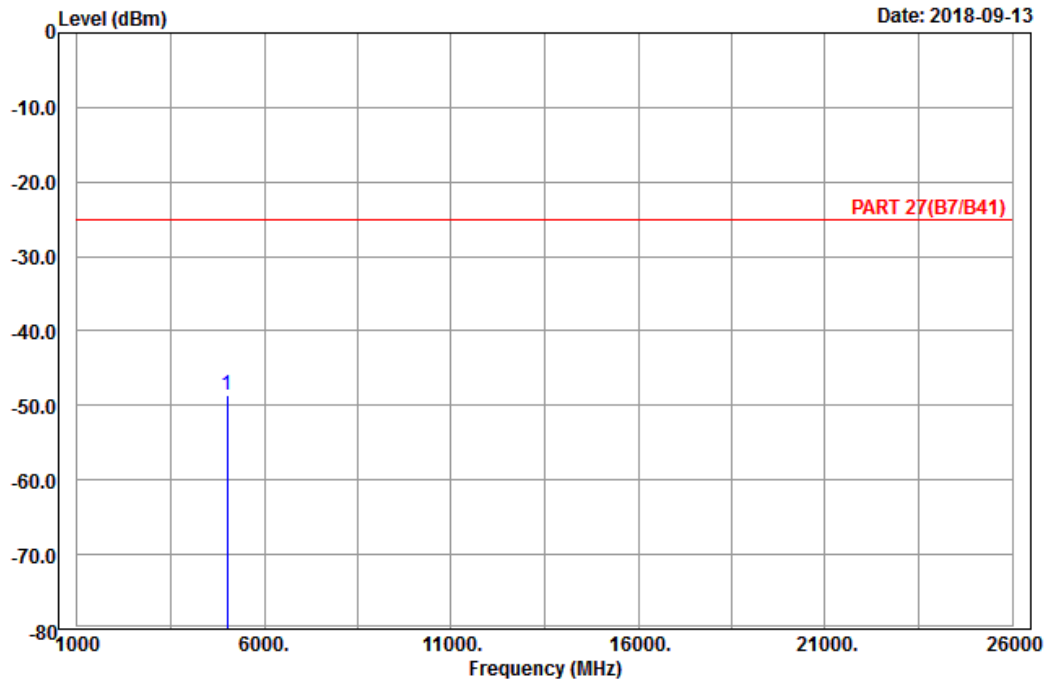

Site : 966 chamber 1
 Condition: PART 27(B7/B41) Vertical
 Remark : LTE_Band 7_Link_CH20775
 Tested by: Harry Hsueh

	Freq	Level	Read Level	Limit Line	Over Limit	Factor	Remark
	MHz	dBm	dBm	dBm	dB	dB	
1	pp 5005.00	-48.53	-68.11	-25.00	-23.53	19.58	Peak

Middle Channel



Bureau Veritas Consumer Products Services Ltd., Taoyuan Branch

A D T

Data: 9

Date: 2018-09-13

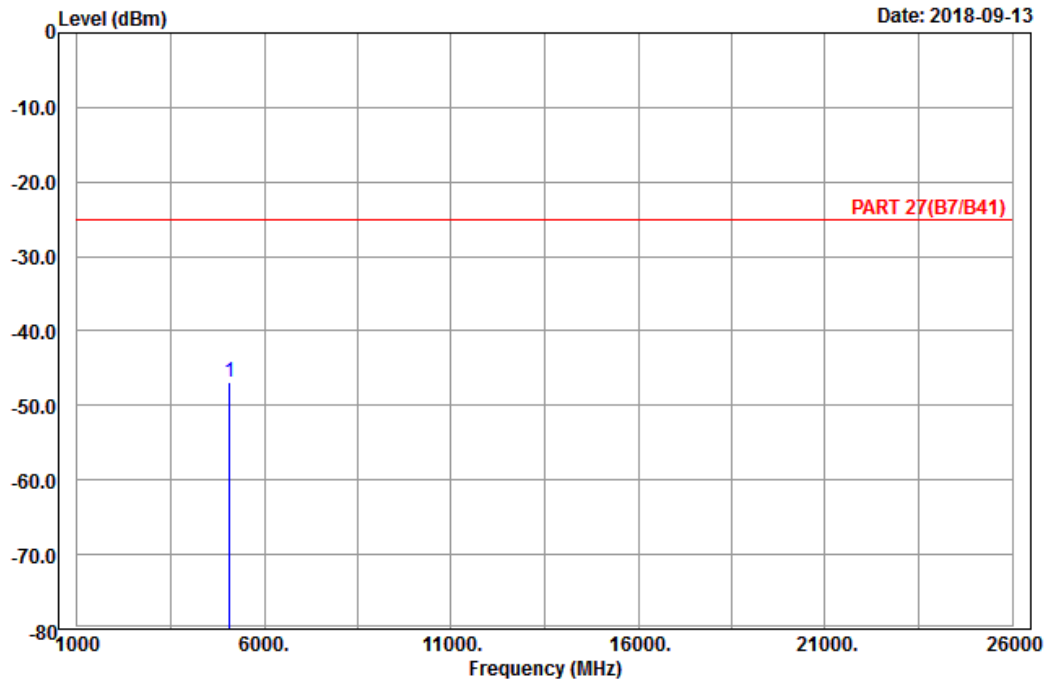

Site : 966 chamber 1
 Condition: PART 27(B7/B41) Horizontal
 Remark : LTE_Band 7_Link_CH21100
 Tested by: Harry Hsueh

	Freq	Level	Read Level	Limit	Over Limit	Factor	Remark
	MHz	dBm	dBm	dBm	dB	dB	
1	pp 5070.00	-46.97	-66.36	-25.00	-21.97	19.39	Peak



Bureau Veritas Consumer Products Services Ltd., Taoyuan Branch

A D T

Data: 10

Date: 2018-09-13

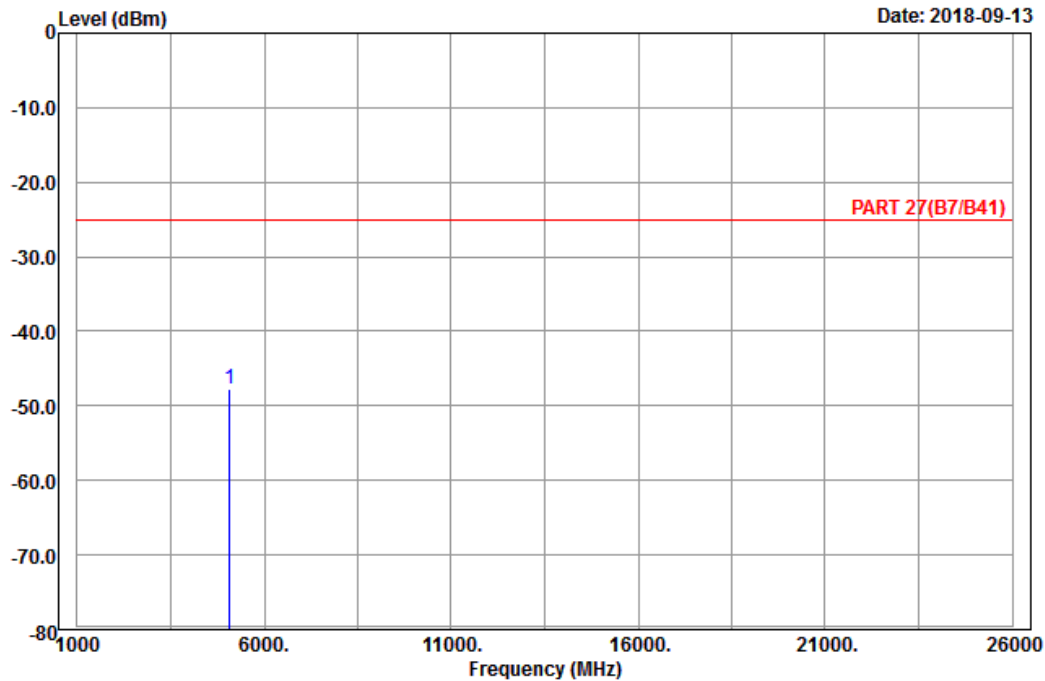

Site : 966 chamber 1
 Condition: PART 27(B7/B41) Vertical
 Remark : LTE_Band 7_Link_CH21100
 Tested by: Harry Hsueh

	Freq	Level	Read Level	Limit Line	Over Limit	Factor	Remark
	MHz	dBm	dBm	dBm	dB	dB	
1	pp 5070.00	-47.67	-67.06	-25.00	-22.67	19.39	Peak

High Channel



Bureau Veritas Consumer Products Services Ltd., Taoyuan Branch

A D T

Data: 9

Date: 2018-09-13

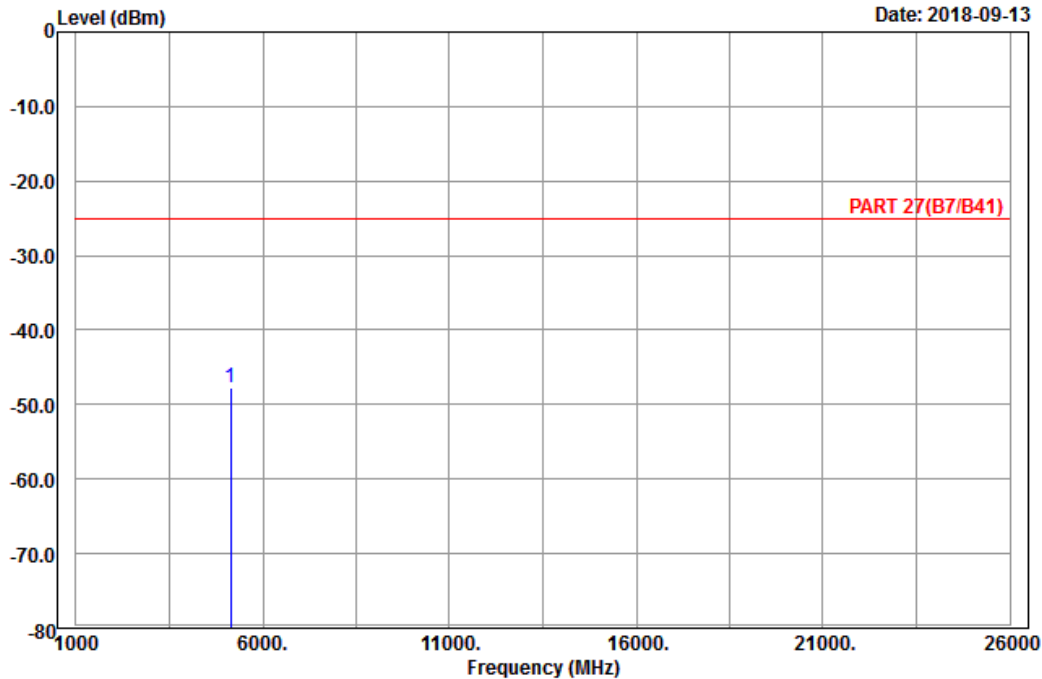

Site : 966 chamber 1
 Condition: PART 27(B7/B41) Horizontal
 Remark : LTE_Band 7_Link_CH21425
 Tested by: Harry Hsueh

Freq	Level	Read Level	Limit Line	Over Limit	Factor	Remark
MHz	dBm	dBm	dBm	dB	dB	
1 pp 5135.00	-47.79	-67.60	-25.00	-22.79	19.81	Peak



Bureau Veritas Consumer Products Services Ltd., Taoyuan Branch

A D T

Data: 10

Date: 2018-09-13

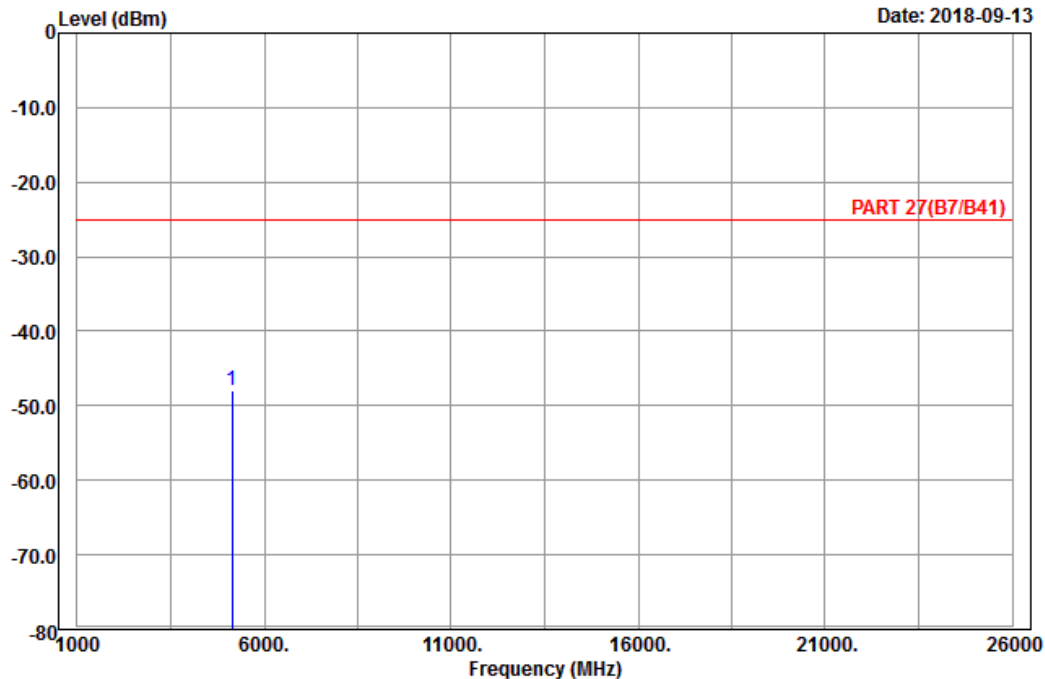

Site : 966 chamber 1
 Condition: PART 27(B7/B41) Vertical
 Remark : LTE_Band 7_Link_CH21425
 Tested by: Harry Hsueh

	Read	Limit	Over			
Freq	Level	Level	Line	Limit	Factor	Remark
MHz	dBm	dBm	dBm	dB	dB	
1 pp 5135.00	-48.03	-67.84	-25.00	-23.03	19.81	Peak

Channel Bandwidth: 20 MHz / QPSK
Low Channel



Bureau Veritas Consumer Products Services Ltd., Taoyuan Branch

A D T

Data: 9

Date: 2018-09-13

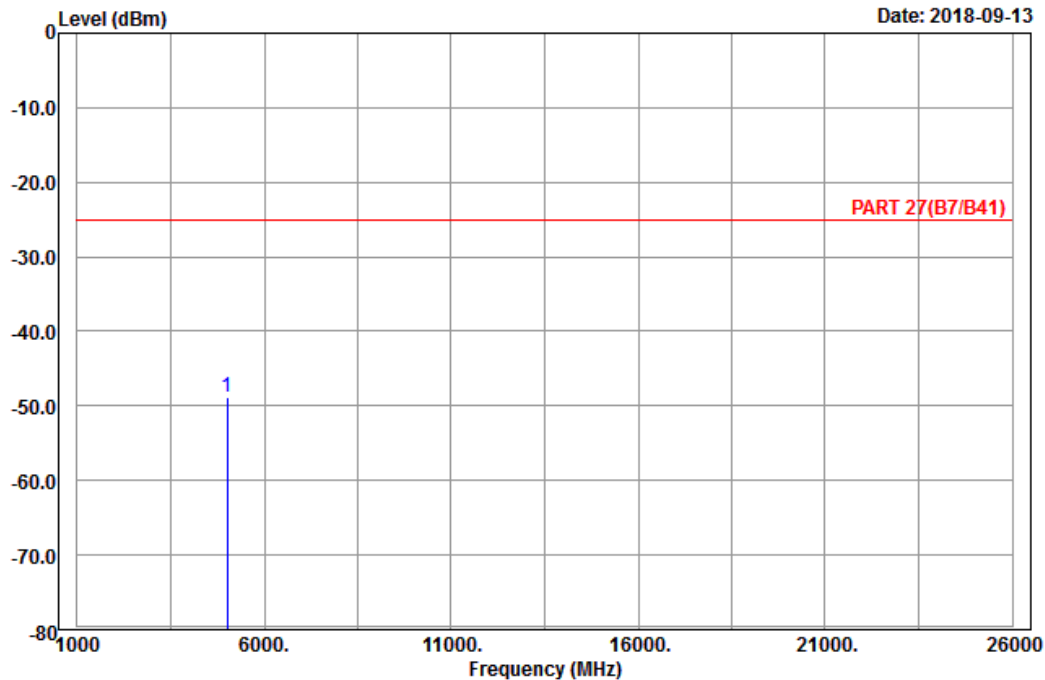

Site : 966 chamber 1
Condition: PART 27(B7/B41) Horizontal
Remark : LTE_Band 7_Link_CH20850
Tested by: Harry Hsueh

	Read	Limit	Over			
Freq	Level	Level	Line	Limit	Factor	Remark
MHz	dBm	dBm	dBm	dB	dB	
1 pp 5020.00	-48.73	-67.81	-25.00	-23.73	19.08	Peak



Bureau Veritas Consumer Products Services Ltd., Taoyuan Branch

A D T

Data: 10

Date: 2018-09-13

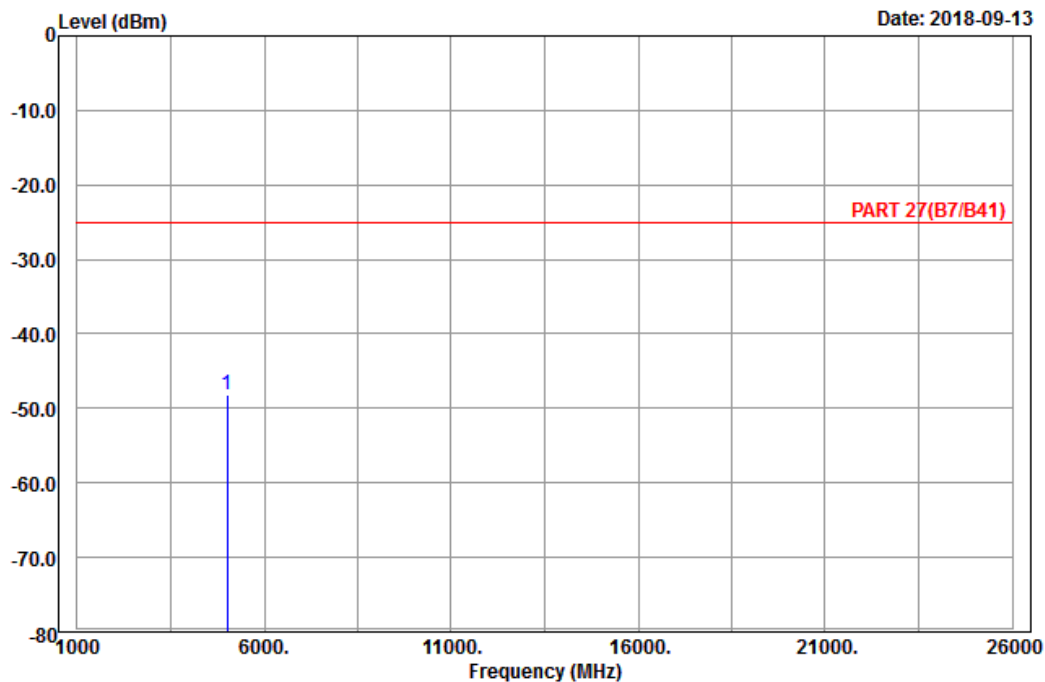

Site : 966 chamber 1
 Condition: PART 27(B7/B41) Vertical
 Remark : LTE_Band 7_Link_CH20850
 Tested by: Harry Hsueh

	Freq	Level	Read Level	Limit Line	Over Limit	Factor	Remark
	MHz	dBm	dBm	dBm	dB	dB	
1	pp 5020.00	-48.10	-67.18	-25.00	-23.10	19.08	Peak

Middle Channel



Bureau Veritas Consumer Products Services Ltd., Taoyuan Branch

A D T

Data: 9

Date: 2018-09-13

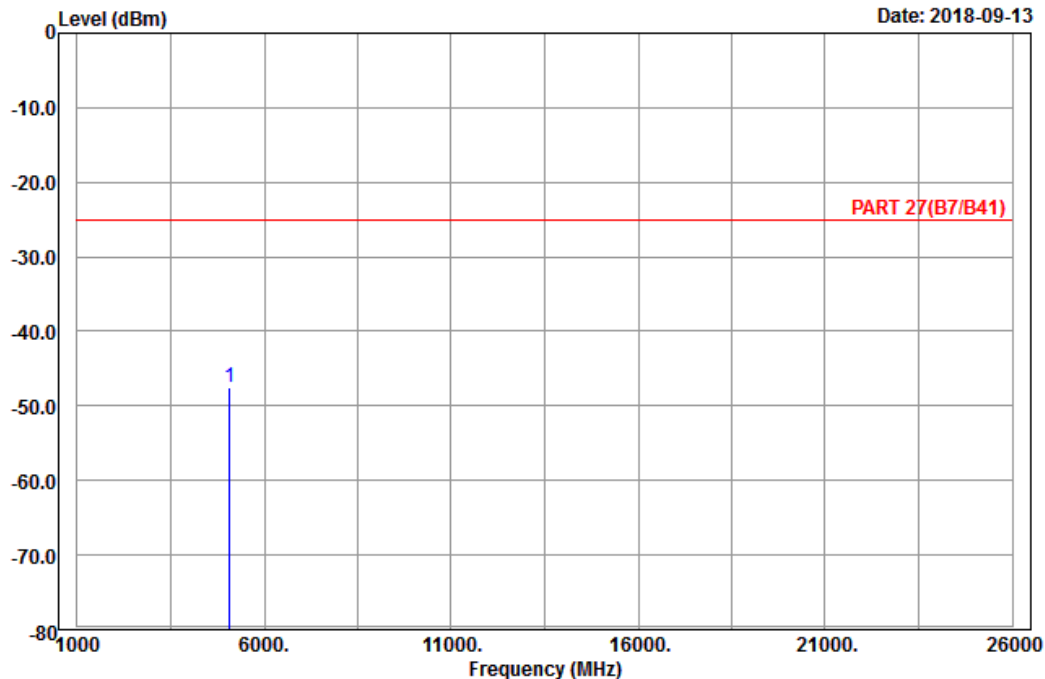

Site : 966 chamber 1
 Condition: PART 27(B7/B41) Horizontal
 Remark : LTE_Band 7_Link_CH21100
 Tested by: Harry Hsueh

Freq	Level	Read Level	Limit Line	Over Limit	Factor	Remark
MHz	dBm	dBm	dBm	dB	dB	
1 pp 5070.00	-47.55	-66.94	-25.00	-22.55	19.39	Peak



A D T

Data: 10

Date: 2018-09-13

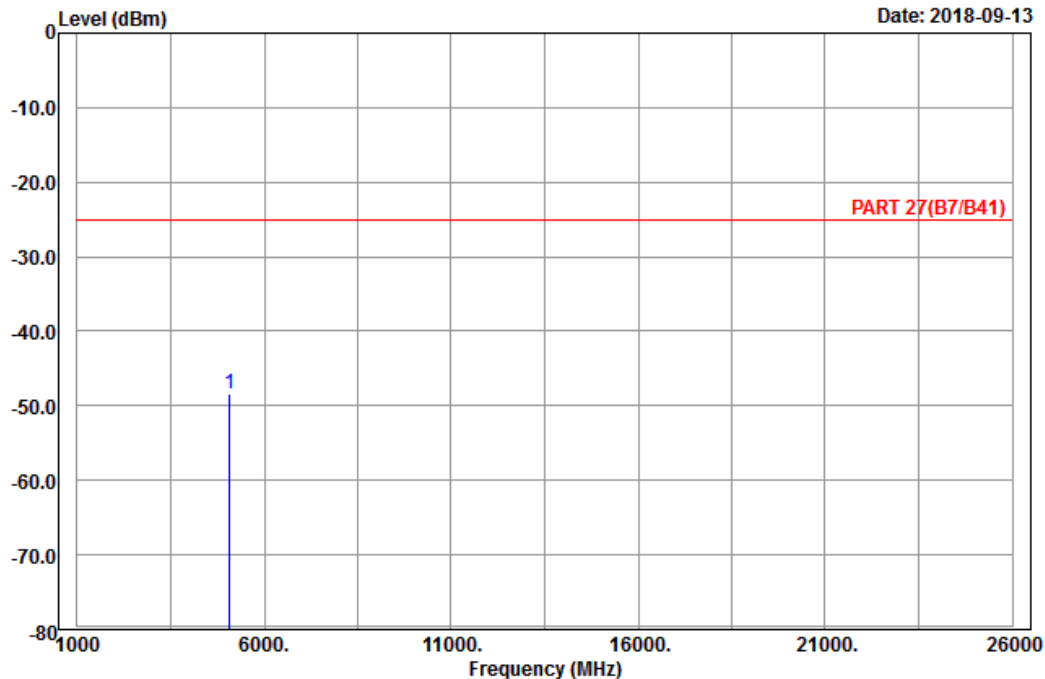

Site : 966 chamber 1
 Condition: PART 27(B7/B41) Vertical
 Remark : LTE_Band 7_Link_CH21100
 Tested by: Harry Hsueh

	Freq	Level	Read Level	Limit Line	Over Limit	Factor	Remark
	MHz	dBm	dBm	dBm	dB	dB	
1	pp 5070.00	-48.30	-67.69	-25.00	-23.30	19.39	Peak

High Channel



Bureau Veritas Consumer Products Services Ltd., Taoyuan Branch

A D T

Data: 13

Date: 2018-09-13

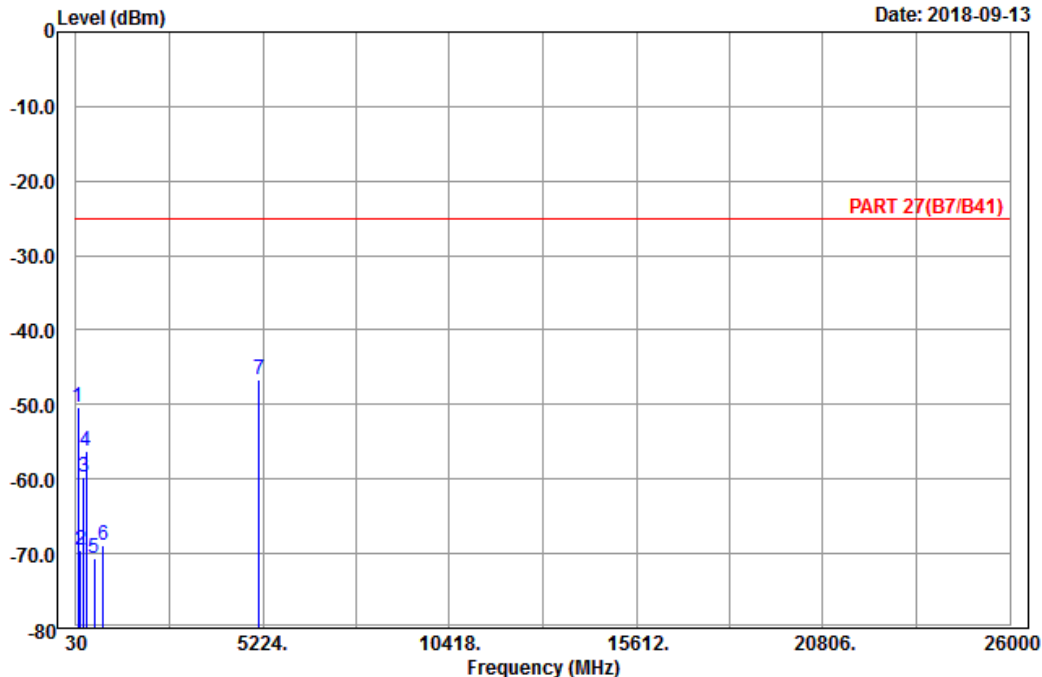

Site : 966 chamber 1
 Condition: PART 27(B7/B41) Horizontal
 Remark : LTE_Band 7_Link_CH21350
 Tested by: Harry Hsueh

	Freq	Level	Read Level	Limit Line	Over Limit	Factor	Remark
	MHz	dBm	dBm	dBm	dB	dB	
1	92.64	-50.40	-39.89	-25.00	-25.40	-10.51	Peak
2	152.58	-69.44	-61.55	-25.00	-44.44	-7.89	Peak
3	246.27	-59.62	-54.06	-25.00	-34.62	-5.56	Peak
4	314.70	-56.22	-50.44	-25.00	-31.22	-5.78	Peak
5	547.10	-70.52	-68.65	-25.00	-45.52	-1.87	Peak
6	792.10	-68.93	-70.43	-25.00	-43.93	1.50	Peak
7 pp	5120.00	-46.74	-66.45	-25.00	-21.74	19.71	Peak



Bureau Veritas Consumer Products Services Ltd., Taoyuan Branch

A D T

Data: 14

Date: 2018-09-13

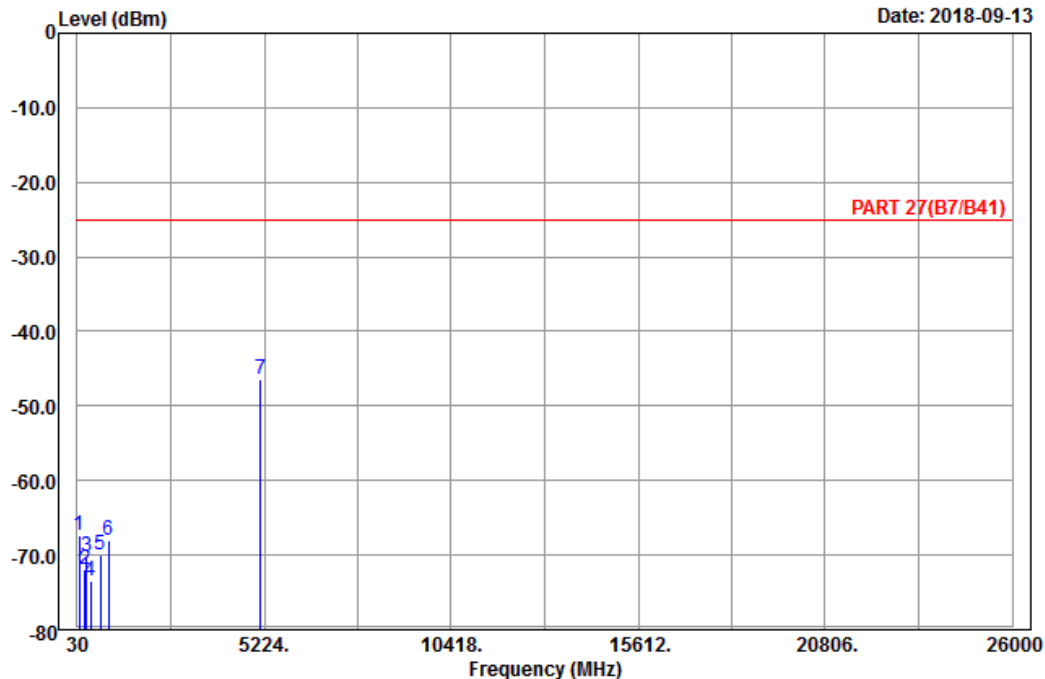

Site : 966 chamber 1
 Condition: PART 27(B7/B41) Vertical
 Remark : LTE_Band 7_Link_CH21350
 Tested by: Harry Hsueh

	Freq	Level	Read Level	Limit Line	Over Limit	Factor	Remark
	MHz	dBm	dBm	dBm	dB	dB	
1	91.83	-67.46	-56.90	-25.00	-42.46	-10.56	Peak
2	242.76	-71.90	-66.29	-25.00	-46.90	-5.61	Peak
3	279.48	-70.22	-64.45	-25.00	-45.22	-5.77	Peak
4	393.10	-73.36	-70.26	-25.00	-48.36	-3.10	Peak
5	671.70	-70.06	-69.82	-25.00	-45.06	-0.24	Peak
6	895.00	-67.92	-70.67	-25.00	-42.92	2.75	Peak
7 pp	5120.00	-46.47	-66.18	-25.00	-21.47	19.71	Peak

5 Pictures of Test Arrangements

Please refer to the attached file (Test Setup Photo).

Appendix – Information on the Testing Laboratories

We, Bureau Veritas Consumer Products Services (H.K.) Ltd., Taoyuan Branch, were founded in 1988 to provide our best service in EMC, Radio, Telecom and Safety consultation. Our laboratories are FCC recognized accredited test firms and accredited according to ISO/IEC 17025.

If you have any comments, please feel free to contact us at the following:

Linko EMC/RF Lab

Tel: 886-2-26052180

Fax: 886-2-26051924

Hsin Chu EMC/RF/Telecom Lab

Tel: 886-3-6668565

Fax: 886-3-6668323

Hwa Ya EMC/RF/Safety

Tel: 886-3-3183232

Fax: 886-3-3270892

Email: service.adt@tw.bureauveritas.com

Web Site: www.bureauveritas-adt.com

The address and road map of all our labs can be found in our web site also.

--- END ---