

FCC Test Report

(PART 24)

Report No.: RF180821C20-8

FCC ID: V65E6910

Test Model: E6910

Received Date: Aug. 21, 2018

Test Date: Aug. 30, 2018 ~ Sep. 14, 2018

Issued Date: Sep. 28, 2018

Applicant: Kyocera Corporation c/o Kyocera International, Inc.

Address: 8611 Balboa Avenue, San Diego, CA 92123

Issued By: Bureau Veritas Consumer Products Services (H.K.) Ltd., Taoyuan Branch

Lab Address: No. 47-2, 14th Ling, Chia Pau Vil., Lin Kou Dist., New Taipei City, Taiwan
(R.O.C)

Test Location (1): No. 19, Hwa Ya 2nd Rd, Wen Hwa Vil, Kwei Shan Dist., Taoyuan City
33383, Taiwan (R.O.C)

Test Location (2): No.215, Sec. 3, Beixin Rd., Xindian Dist., New Taipei City 231, Taiwan,
R.O.C

**FCC Registration /
Designation Number:** 427177 / TW0011



This report is for your exclusive use. Any copying or replication of this report to or for any other person or entity, or use of our name or trademark, is permitted only with our prior written permission. This report sets forth our findings solely with respect to the test samples identified herein. The results set forth in this report are not indicative or representative of the quality or characteristics of the lot from which a test sample was taken or any similar or identical product unless specifically and expressly noted. Our report includes all of the tests requested by you and the results thereof based upon the information that you provided to us. You have 60 days from date of issuance of this report to notify us of any material error or omission caused by our negligence, provided, however, that such notice shall be in writing and shall specifically address the issue you wish to raise. A failure to raise such issue within the prescribed time shall constitute your unqualified acceptance of the completeness of this report, the tests conducted and the correctness of the report contents. Unless specific mention, the uncertainty of measurement has been explicitly taken into account to declare the compliance or non-compliance to the specification. The report must not be used by the client to claim product certification, approval, or endorsement by TAF or any government agencies.

Table of Contents

Release Control Record	4
1 Certificate of Conformity	5
2 Summary of Test Results	6
2.1 Measurement Uncertainty	6
2.2 Test Site and Instruments	7
3 General Information	8
3.1 General Description of EUT	8
3.2 Configuration of System under Test	9
3.2.1 Description of Support Units	10
3.3 Test Mode Applicability and Tested Channel Detail	11
3.4 EUT Operating Conditions	14
3.5 General Description of Applied Standards	14
4 Test Types and Results	15
4.1 Output Power Measurement	15
4.1.1 Limits of Output Power Measurement	15
4.1.2 Test Procedures	15
4.1.3 Test Setup	16
4.1.4 Test Results	17
4.2 Modulation Characteristics Measurement	26
4.2.1 Limits of Modulation Characteristics	26
4.2.2 Test Setup	26
4.2.3 Test Procedure	26
4.2.4 Test Results	27
4.3 Frequency Stability Measurement	29
4.3.1 Limits of Frequency Stability Measurement	29
4.3.2 Test Procedure	29
4.3.3 Test Setup	29
4.3.4 Test Results	30
4.4 Occupied Bandwidth Measurement	39
4.4.1 Test Procedure	39
4.4.2 Test Setup	39
4.4.3 Test Result	40
4.5 Band Edge Measurement	44
4.5.1 Limits of Band Edge Measurement	44
4.5.2 Test Setup	44
4.5.3 Test Procedures	44
4.5.4 Test Results	45
4.6 Peak to Average Ratio	52
4.6.1 Limits of Peak to Average Ratio Measurement	52
4.6.2 Test Setup	52
4.6.3 Test Procedures	52
4.6.4 Test Results	53
4.7 Conducted Spurious Emissions	57
4.7.1 Limits of Conducted Spurious Emissions Measurement	57
4.7.2 Test Setup	57
4.7.3 Test Procedure	57
4.7.4 Test Results	58
4.8 Radiated Emission Measurement	85
4.8.1 Limits of Radiated Emission Measurement	85
4.8.2 Test Procedure	85
4.8.3 Deviation from Test Standard	85
4.8.4 Test Setup	86
4.8.5 Test Results	87

5 Pictures of Test Arrangements.....	123
Appendix – Information on the Testing Laboratories	124

Release Control Record

Issue No.	Description	Date Issued
RF180821C20-8	Original Release	Sep. 28, 2018

1 Certificate of Conformity

Product: Smart Phone

Brand: Kyocera

Test Model: E6910

Sample Status: Identical Prototype

Applicant: Kyocera Corporation c/o Kyocera International, Inc.

Test Date: Aug. 30, 2018 ~ Sep. 14, 2018

Standards: FCC Part 24, Subpart E

The above equipment has been tested by **Bureau Veritas Consumer Products Services (H.K.) Ltd., Taoyuan Branch**, and found compliance with the requirement of the above standards. The test record, data evaluation & Equipment Under Test (EUT) configurations represented herein are true and accurate accounts of the measurements of the sample's RF characteristics under the conditions specified in this report.

Prepared by : , **Date:** Sep. 28, 2018
Ivonne Wu / Supervisor

Approved by : , **Date:** Sep. 28, 2018
Dylan Chiou / Project Engineer

2 Summary of Test Results

Applied Standard: FCC Part 24 & Part 2			
FCC Clause	Test Item	Result	Remarks
2.1046 24.232	Effective Isotropic Radiated Power	Pass	Meet the requirement of limit.
2.1047	Modulation Characteristics	Pass	Meet the requirement.
2.1046 24.232(d)	Peak to Average Ratio	Pass	Meet the requirement of limit.
2.1055 24.235	Frequency Stability	Pass	Meet the requirement of limit.
2.1049 24.238(b)	Occupied Bandwidth	Pass	Meet the requirement of limit.
24.238(b)	Band Edge Measurements	Pass	Meet the requirement of limit.
2.1051 24.238	Conducted Spurious Emissions	Pass	Meet the requirement of limit.
2.1053 24.238	Radiated Spurious Emissions	Pass	Meet the requirement of limit. Minimum passing margin is -36.52 dB at 3700.40 MHz.

2.1 Measurement Uncertainty

Where relevant, the following measurement uncertainty levels have been estimated for tests performed on the EUT as specified in CISPR 16-4-2:

Measurement	Frequency	Expanded Uncertainty (k=2) (±)
Radiated Emissions up to 1 GHz	30 MHz ~ 200 MHz	2.0153 dB
	200 MHz ~ 1000 MHz	2.0224 dB
Radiated Emissions above 1 GHz	1 GHz ~ 18 GHz	1.0121 dB
	18 GHz ~ 40 GHz	1.1508 dB

2.2 Test Site and Instruments

Description & Manufacturer	Model No.	Serial No.	Date of Calibration	Due Date of Calibration
Test Receiver Agilent Technologies	N9038A	MY52260177	Aug. 20, 2018	Aug. 19, 2019
Spectrum Analyzer ROHDE & SCHWARZ	FSU43	101261	Jan. 11, 2018	Jan. 10, 2019
HORN Antenna ETS-Lindgren	3117	00143293	Dec. 13, 2017	Dec. 12, 2018
BILOG Antenna SCHWARZBECK	VULB 9168	9168-616	Dec. 14, 2017	Dec. 13, 2018
HORN Antenna SCHWARZBECK	BBHA 9170	9170-480	Dec. 01, 2017	Nov. 30, 2018
HORN Antenna SCHWARZBECK	BBHA 9120D	9120D-969	Dec. 12, 2017	Dec. 11, 2018
Fixed Attenuator Woken	00801A1GGAM02Y	NA	May 17, 2018	May 16, 2019
MXG Vector signal generator Agilent	N5182B	MY53050430	Oct. 24, 2017	Oct. 23, 2018
Preamplifier Agilent	310N	187226	Jun. 19, 2018	Jun. 18, 2019
Preamplifier Agilent	83017A	MY39501357	Jun. 19, 2018	Jun. 18, 2019
RF signal cable ETS-LINDGREN	5D-FB	Cable-CH1-01(RF C-SMS-100-SMS- 120+RFC-SMS-1 00-SMS-400)	Jun. 19, 2018	Jun. 18, 2019
RF signal cable ETS-LINDGREN	8D-FB	Cable-CH1-02(RF C-SMS-100-SMS- 24)	Jun. 19, 2018	Jun. 18, 2019
Boresight Antenna Fixture	FBA-01	FBA-SIP01	NA	NA
Software BV ADT	E3 8.130425b	NA	NA	NA
Antenna Tower MF	NA	NA	NA	NA
Turn Table MF	NA	NA	NA	NA
Antenna Tower & Turn Table Controller MF	MF-7802	NA	NA	NA
Communications Tester-Wireless Agilent	8960 Series 10	MY53201073	Jun. 28, 2017	Jun. 27, 2019
Radio Communication Analyzer Anritsu	MT8820C	6201010284	Dec. 28, 2017	Dec. 27, 2018

- Note: 1. The calibration interval of the above test instruments is 12 / 24 months and the calibrations are traceable to NML/ROC and NIST/USA.
2. The test was performed in HsinTien Chamber 1.
3. The horn antenna and preamplifier (model: 83017A) are used only for the measurement of emission frequency above 1 GHz if tested.
4. The IC Site Registration No. is IC7450I-1.

3 General Information

3.1 General Description of EUT

Product	Smart Phone	
Brand	Kyocera	
Test Model	E6910	
Status of EUT	Identical Prototype	
Power Supply Rating	3.8 Vdc (Battery) 5 Vdc or 9 Vdc or 12 Vdc (Adapter) 5 Vdc (Host equipment)	
Modulation Type	GSM/GPRS	GMSK
	EDGE	GMSK, 8PSK
	WCDMA	QPSK
	LTE	QPSK, 16QAM, 64QAM
Frequency Range	GSM/GPRS/EDGE	1850.2 ~ 1909.8 MHz
	WCDMA	1852.4 ~ 1907.6 MHz
	LTE Band 2 (Channel Bandwidth: 1.4 MHz)	1850.7 ~ 1909.3 MHz
	LTE Band 2 (Channel Bandwidth: 3 MHz)	1851.5 ~ 1908.5 MHz
	LTE Band 2 (Channel Bandwidth: 5 MHz)	1852.5 ~ 1907.5 MHz
	LTE Band 2 (Channel Bandwidth: 10 MHz)	1855.0 ~ 1905.0 MHz
	LTE Band 2 (Channel Bandwidth: 15 MHz)	1857.5 ~ 1902.5 MHz
	LTE Band 2 (Channel Bandwidth: 20 MHz)	1860.0 ~ 1900.0 MHz
Max. EIRP Power	GSM/GPRS	1986.09 mW
	EDGE	653.13 mW
	WCDMA	326.59 mW
	LTE Band 2 (Channel Bandwidth: 1.4 MHz)	382.82 mW
	LTE Band 2 (Channel Bandwidth: 3 MHz)	375.84 mW
	LTE Band 2 (Channel Bandwidth: 5 MHz)	391.74 mW
	LTE Band 2 (Channel Bandwidth: 10 MHz)	390.84 mW
	LTE Band 2 (Channel Bandwidth: 15 MHz)	393.55 mW
LTE Band 2 (Channel Bandwidth: 20 MHz)	396.28 mW	
Emission Designator	GSM/GPRS	243KGXW
	EDGE	247KG7W
	WCDMA	4M15F9W
	LTE Band 2 (Channel Bandwidth: 1.4 MHz)	1M09W7D
	LTE Band 2 (Channel Bandwidth: 3 MHz)	2M71W7D
	LTE Band 2 (Channel Bandwidth: 5 MHz)	4M50W7D
	LTE Band 2 (Channel Bandwidth: 10 MHz)	8M98W7D
	LTE Band 2 (Channel Bandwidth: 15 MHz)	13M5G7D
	LTE Band 2 (Channel Bandwidth: 20 MHz)	18M0W7D
Antenna Type	Fixed Internal Antenna with 1.0 dBi gain	
Accessory Device	Refer to Note as below	
Data Cable Supplied	Refer to Note as below	

Note:

1. The EUT's accessories list refers to Ext. Pho.
2. The above EUT information is declared by manufacturer and for more detailed features description, please refers to the manufacturer's specifications or user's manual.

3.2 Configuration of System under Test

<Radiated Emission Test>

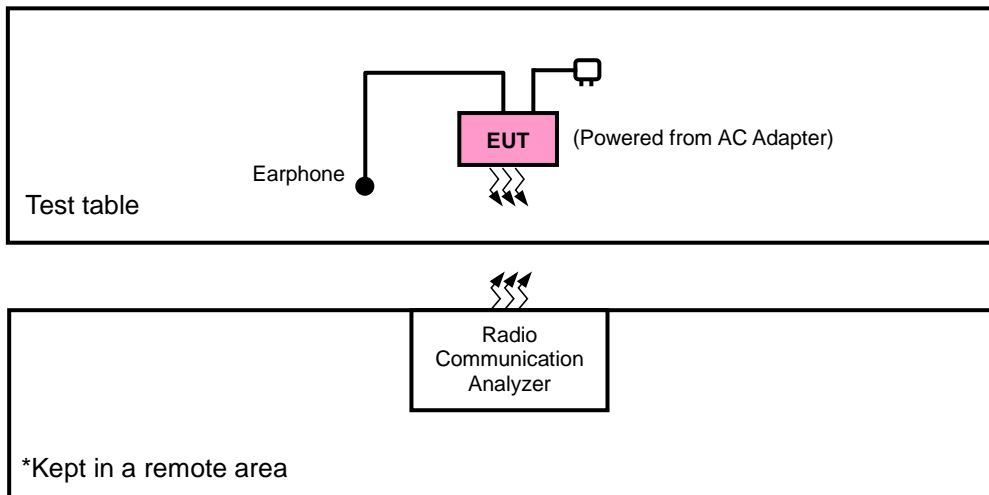

<E.I.R.P. Test>

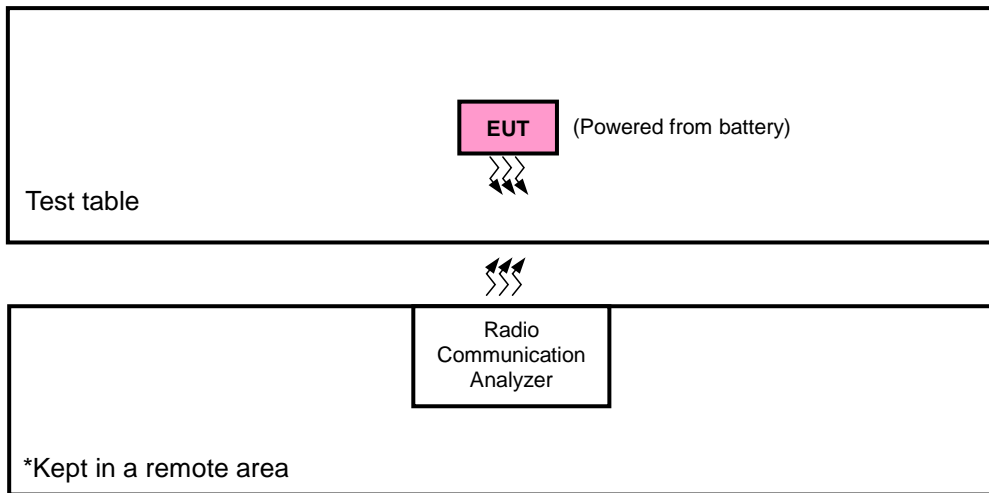

3.2.1 Description of Support Units

The EUT has been tested as an independent unit together with other necessary accessories or support units. The following support units or accessories were used to form a representative test configuration during the tests.

No.	Product	Brand	Model No.	Serial No.	FCC ID
1.	Earphone	Funkey	FK130102	N/A	N/A

No.	Signal Cable Description Of The Above Support Units
1.	N/A

Note:

1. All power cords of the above support units are non-shielded (1.8m).

3.3 Test Mode Applicability and Tested Channel Detail

Pre-Scan has been conducted to determine the worst-case mode from all possible combinations between available modulations, data rates, XYZ axis, and antenna ports.

The worst case was found when positioned as the table below. Following channel(s) was (were) selected for the final test as listed below:

Band	EIRP	Radiated Emission
GSM	Z-plane	Y-axis
EDGE	Z-plane	Y-axis
WCDMA	Z-plane	Y-axis
LTE Band 2	Z-plane	X-axis

GSM

EUT Configure Mode	Test Item	Available Channel	Tested Channel	Mode
-	EIRP	512 to 810	512, 661, 810	GSM, EDGE
-	Modulation Characteristics	512 to 810	661	GSM, EDGE
-	Frequency Stability	512 to 810	512, 810	GSM, EDGE
-	Occupied Bandwidth	512 to 810	512, 661, 810	GSM, EDGE
-	Band Edge	512 to 810	512, 810	GSM, EDGE
-	Peak to Average Ratio	512 to 810	512, 661, 810	GSM, EDGE
-	Conducted Emission	512 to 810	512, 661, 810	GSM, EDGE
-	Radiated Emission	512 to 810	512, 661, 810	GSM, EDGE

WCDMA

EUT Configure Mode	Test Item	Available Channel	Tested Channel	Mode
-	EIRP	9262 to 9538	9262, 9400, 9538	WCDMA
-	Modulation Characteristics	9262 to 9538	9400	WCDMA
-	Frequency Stability	9262 to 9538	9262, 9538	WCDMA
-	Occupied Bandwidth	9262 to 9538	9262, 9400, 9538	WCDMA
-	Band Edge	9262 to 9538	9262, 9538	WCDMA
-	Peak to Average Ratio	9262 to 9538	9262, 9400, 9538	WCDMA
-	Conducted Emission	9262 to 9538	9262, 9400, 9538	WCDMA
-	Radiated Emission	9262 to 9538	9262, 9400, 9538	WCDMA

LTE Band 2

EUT Configure Mode	Test Item	Available Channel	Tested Channel	Channel Bandwidth	Modulation	Mode
-	EIRP	18607 to 19193	18607, 18900, 19193	1.4 MHz	QPSK, 16QAM, 64QAM	1 RB / 0 RB Offset
		18615 to 19185	18615, 18900, 19185	3 MHz	QPSK, 16QAM, 64QAM	1 RB / 0 RB Offset
		18625 to 19175	18625, 18900, 19175	5 MHz	QPSK, 16QAM, 64QAM	1 RB / 0 RB Offset
		18650 to 19150	18650, 18900, 19150	10 MHz	QPSK, 16QAM, 64QAM	1 RB / 0 RB Offset
		18675 to 19125	18675, 18900, 19125	15 MHz	QPSK, 16QAM, 64QAM	1 RB / 0 RB Offset
		18700 to 19100	18700, 18900, 19100	20 MHz	QPSK, 16QAM, 64QAM	1 RB / 0 RB Offset
-	Modulation Characteristics	18700 to 19100	18900	5 MHz	QPSK, 16QAM, 64QAM	25 RB / 0 RB Offset
-	Frequency Stability	18607 to 19193	18607, 19193	1.4 MHz	QPSK	1 RB / 0 RB Offset
		18615 to 19185	18615, 19185	3 MHz	QPSK	1 RB / 0 RB Offset
		18625 to 19175	18625, 19175	5 MHz	QPSK	1 RB / 0 RB Offset
		18650 to 19150	18650, 19150	10 MHz	QPSK	1 RB / 0 RB Offset
		18675 to 19125	18675, 19125	15 MHz	QPSK	1 RB / 0 RB Offset
		18700 to 19100	18700, 19100	20 MHz	QPSK	1 RB / 0 RB Offset
-	Occupied Bandwidth	18607 to 19193	18607, 18900, 19193	1.4 MHz	QPSK, 16QAM, 64QAM	6 RB / 0 RB Offset
		18615 to 19185	18615, 18900, 19185	3 MHz	QPSK, 16QAM, 64QAM	15 RB / 0 RB Offset
		18625 to 19175	18625, 18900, 19175	5 MHz	QPSK, 16QAM, 64QAM	25 RB / 0 RB Offset
		18650 to 19150	18650, 18900, 19150	10 MHz	QPSK, 16QAM, 64QAM	50 RB / 0 RB Offset
		18675 to 19125	18675, 18900, 19125	15 MHz	QPSK, 16QAM, 64QAM	75 RB / 0 RB Offset
		18700 to 19100	18700, 18900, 19100	20 MHz	QPSK, 16QAM, 64QAM	100 RB / 0 RB Offset
-	Peak to Average Ratio	18607 to 19193	18607, 18900, 19193	1.4 MHz	QPSK, 16QAM, 64QAM	1 RB / 0 RB Offset
		18615 to 19185	18615, 18900, 19185	3 MHz	QPSK, 16QAM, 64QAM	1 RB / 0 RB Offset
		18625 to 19175	18625, 18900, 19175	5 MHz	QPSK, 16QAM, 64QAM	1 RB / 0 RB Offset
		18650 to 19150	18650, 18900, 19150	10 MHz	QPSK, 16QAM, 64QAM	1 RB / 0 RB Offset
		18675 to 19125	18675, 18900, 19125	15 MHz	QPSK, 16QAM, 64QAM	1 RB / 0 RB Offset
		18700 to 19100	18700, 18900, 19100	20 MHz	QPSK, 16QAM, 64QAM	1 RB / 0 RB Offset

EUT Configure Mode	Test Item	Available Channel	Tested Channel	Channel Bandwidth	Modulation	Mode		
-	Band Edge	18607 to 19193	18607	1.4 MHz	QPSK	1 RB / 0 RB Offset 6 RB / 0 RB Offset		
			19193	1.4 MHz	QPSK	1 RB / 5 RB Offset 6 RB / 0 RB Offset		
		18615 to 19185	18615	3 MHz	QPSK	1 RB / 0 RB Offset 15 RB / 0 RB Offset		
			19185	3 MHz	QPSK	1 RB / 14 RB Offset 15 RB / 0 RB Offset		
		18625 to 19175	18625	5 MHz	QPSK	1 RB / 0 RB Offset 25 RB / 0 RB Offset		
			19175	5 MHz	QPSK	1 RB / 24 RB Offset 25 RB / 0 RB Offset		
		18650 to 19150	18650	10 MHz	QPSK	1 RB / 0 RB Offset 50 RB / 0 RB Offset		
			19150	10 MHz	QPSK	1 RB / 49 RB Offset 50 RB / 0 RB Offset		
		18675 to 19125	18675	15 MHz	QPSK	1 RB / 0 RB Offset 75 RB / 0 RB Offset		
			19125	15 MHz	QPSK	1 RB / 74 RB Offset 75 RB / 0 RB Offset		
		18700 to 19100	18700	20 MHz	QPSK	1 RB / 0 RB Offset 100 RB / 0 RB Offset		
			19100	20 MHz	QPSK	1 RB / 99 RB Offset 100 RB / 0 RB Offset		
		-	Conducted Emission	18607 to 19193	18607, 18900, 19193	1.4 MHz	QPSK	1 RB / 0 RB Offset
				18615 to 19185	18615, 18900, 19185	3 MHz	QPSK	1 RB / 0 RB Offset
				18625 to 19175	18625, 18900, 19175	5 MHz	QPSK	1 RB / 0 RB Offset
				18650 to 19150	18650, 18900, 19150	10 MHz	QPSK	1 RB / 0 RB Offset
				18675 to 19125	18675, 18900, 19125	15 MHz	QPSK	1 RB / 0 RB Offset
				18700 to 19100	18700, 18900, 19100	20 MHz	QPSK	1 RB / 0 RB Offset
-	Radiated Emission	18607 to 19193	18607, 18900, 19193	1.4 MHz	QPSK	1 RB / 0 RB Offset		
		18625 to 19175	18625, 18900, 19175	5 MHz	QPSK	1 RB / 0 RB Offset		
		18700 to 19100	18700, 18900, 19100	20 MHz	QPSK	1 RB / 0 RB Offset		

Note: This device was tested under all bandwidths, RB configurations and modulations. The worst case was found in QPSK modulation.

Test Condition:

Test Item	Environmental Conditions	Input Power	Tested By
EIRP	26 deg. C, 58 % RH	3.8 Vdc	Karl Lee
Modulation Characteristics	26 deg. C, 58 % RH	3.8 Vdc	Wayne Lin
Frequency Stability	26 deg. C, 58 % RH	3.8 Vdc	Wayne Lin
Occupied Bandwidth	26 deg. C, 58 % RH	3.8 Vdc	Wayne Lin
Band Edge	26 deg. C, 58 % RH	3.8 Vdc	Wayne Lin
Peak to Average Ratio	26 deg. C, 58 % RH	3.8 Vdc	Wayne Lin
Conducted Emission	26 deg. C, 58 % RH	3.8 Vdc	Wayne Lin
Radiated Emission	25 deg. C, 65 % RH	120 Vac, 60 Hz	Karl Lee / Harry Hsueh

3.4 EUT Operating Conditions

The EUT makes a call to the communication simulator. The communication simulator station system controlled a EUT to export maximum output power under transmission mode and specific channel frequency

3.5 General Description of Applied Standards

The EUT is a RF Product. According to the specifications of the manufacturer, it must comply with the requirements of the following standards:

FCC 47 CFR Part 2

FCC 47 CFR Part 24

KDB 971168 D01 Power Meas License Digital Systems v03r01

ANSI/TIA/EIA-603-E 2016

ANSI 63.26-2015

NOTE: All test items have been performed and recorded as per the above standards.

4 Test Types and Results

4.1 Output Power Measurement

4.1.1 Limits of Output Power Measurement

Mobile / Portable station are limited to 2 watts e.i.r.p.

4.1.2 Test Procedures

EIRP / ERP Measurement:

- a. All measurements were done at low, middle and high operational frequency range. RBW and VBW is 1 MHz for GSM, GPRS & EDGE, 5 MHz for WCDMA, and 10 MHz for LTE mode.
- b. Substitution method is used for E.I.R.P measurement. In the semi-anechoic chamber, EUT placed on the 0.8 m (below or equal 1 GHz) and/or 1.5 m (above 1 GHz) height of Turn Table, rotated the table around 360 degrees to search the maximum radiation power and receiver antenna shall be rotated vertical and horizontal polarization and moved height from 1 m to 4 m to find the maximum polar radiated power. The "Read Value" is the spectrum reading the maximum power value.
- c. The substitution horn antenna is substituted for EUT at the same position and signals generator export the CW signal to the substitution antenna via a tx cable. Rotated the Turn Table and moved receiving antenna to find the maximum radiation power. Adjust output power level of S.G to get a Value of spectrum reading equal to "Read Value" of step b. Record the power level of S.G.
- d. $EIRP = \text{Output power level of S.G} - \text{TX cable loss} + \text{Antenna gain of substitution horn}$. E.R.P power can be calculated form E.I.R.P power by subtracting the gain of dipole, $E.R.P \text{ power} = E.I.R.P \text{ power} - 2.15 \text{ dB}$.

Conducted Power Measurement:

The EUT was set up for the maximum power with GSM, GPRS, EDGE, WCDMA, and LTE link data modulation and link up with simulator. Set the EUT to transmit under low, middle and high channel and record the power level shown on simulator.

4.1.3 Test Setup

EIRP / ERP Measurement:

<Radiated Emission below or equal 1 GHz>

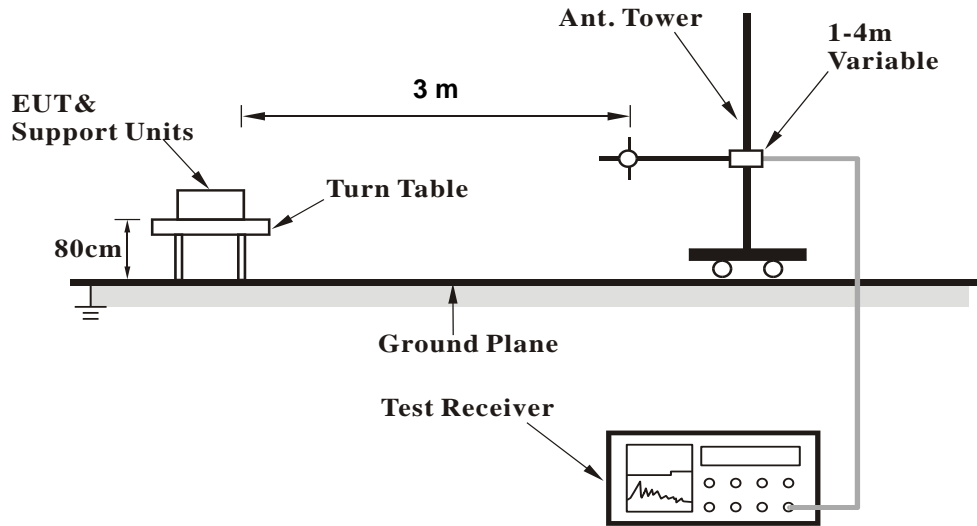

<Radiated Emission above 1 GHz>

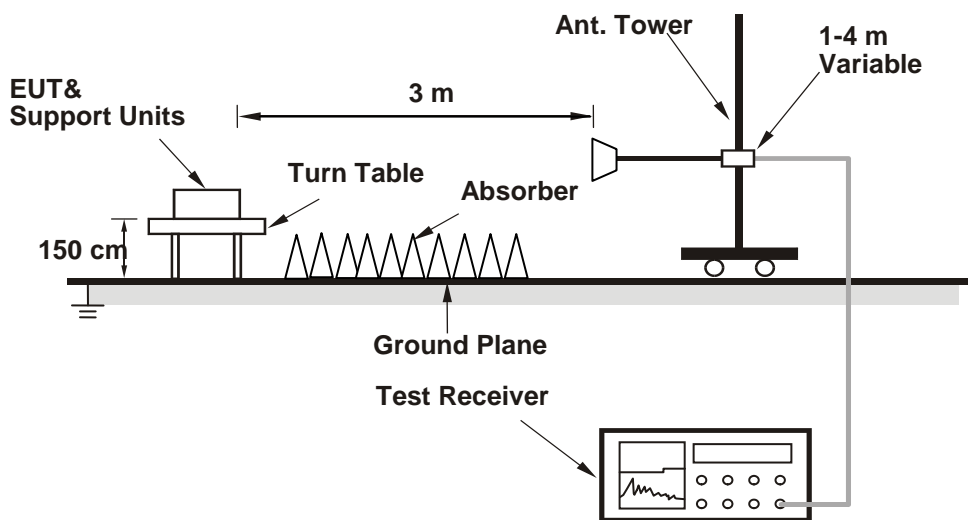

For the actual test configuration, please refer to the attached file (Test Setup Photo).

Conducted Power Measurement:

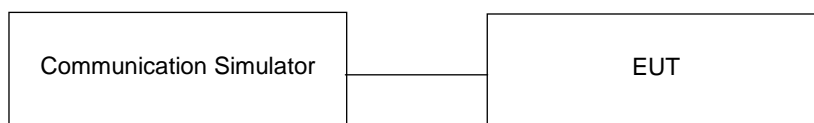

4.1.4 Test Results

Conducted Output Power (dBm)

Band	GSM1900		
Channel	512	661	810
Frequency (MHz)	1850.2	1880.0	1909.8
GSM (GMSK, 1Tx-slot)	29.77	29.59	29.41
GPRS (GMSK, 1Tx-slot)	29.81	29.65	29.44
GPRS (GMSK, 2Tx-slot)	26.66	26.50	26.20
GPRS (GMSK, 3Tx-slot)	24.61	24.53	24.32
GPRS (GMSK, 4Tx-slot)	23.67	23.75	23.38
EDGE (8PSK, 1Tx-slot)	25.08	25.11	25.15
EDGE (8PSK, 2Tx-slot)	22.38	22.42	22.44
EDGE (8PSK, 3Tx-slot)	20.54	20.37	20.19
EDGE (8PSK, 4Tx-slot)	19.49	19.29	18.95

Band	WCDMA II		
Channel	9262	9400	9538
Frequency (MHz)	1852.4	1880.0	1907.6
RMC 12.2K	23.81	23.98	23.87
HSDPA Subtest-1	22.90	23.09	22.86
HSDPA Subtest-2	22.92	22.56	22.53
HSDPA Subtest-3	22.47	23.07	22.88
HSDPA Subtest-4	22.43	23.02	22.87
HSUPA Subtest-1	22.88	23.12	22.90
HSUPA Subtest-2	20.90	21.10	20.95
HSUPA Subtest-3	21.93	22.09	21.95
HSUPA Subtest-4	20.91	21.09	20.89
HSUPA Subtest-5	22.90	23.10	22.90

LTE Band 2

BW	MCS Index	RB Size	RB Offset	Low	Mid	High	3GPP MPR (dB)	BW	MCS Index	RB Size	RB Offset	Low	Mid	High	3GPP MPR (dB)
				18700	18900	19100						18675	18900	19125	
				Channel Frequency (MHz)	1860.0	1880.0						1900.0	Channel Frequency (MHz)	1857.5	
20M	QPSK	1	0	24.05	24.19	24.17	0	15M	QPSK	1	0	23.84	23.91	23.94	0
		1	50	23.98	24.12	24.10	0			1	37	23.75	23.91	23.89	0
		1	99	23.91	24.05	24.03	0			1	74	23.69	23.83	23.81	0
		50	0	23.04	23.18	23.16	1			36	0	22.74	22.97	22.86	1
		50	25	23.09	23.16	23.14	1			36	19	22.84	22.94	23.00	1
		50	50	23.01	23.15	23.13	1			36	39	22.79	22.88	22.93	1
		100	0	23.02	23.16	23.14	1			75	0	22.79	22.86	22.93	1
	16QAM	1	0	22.98	23.14	23.10	1		16QAM	1	0	22.78	22.85	22.87	1
		1	50	22.88	23.10	23.03	1			1	37	22.63	22.81	22.83	1
		1	99	22.86	23.04	22.97	1			1	74	22.59	22.73	22.68	1
		50	0	22.00	22.10	22.13	2			36	0	21.79	21.93	21.86	2
		50	25	22.06	22.17	22.15	2			36	19	21.83	21.89	21.86	2
		50	50	21.95	22.12	22.04	2			36	39	21.78	21.82	21.83	2
	100	0	21.99	22.14	22.12	2	75		0	21.68	21.87	21.90	2		
	64QAM	1	0	22.02	22.10	22.13	2		64QAM	1	0	21.82	21.98	21.86	2
		1	50	21.93	22.06	22.01	2			1	37	21.65	21.90	21.79	2
		1	99	21.86	21.95	21.94	2			1	74	21.59	21.68	21.70	2
		50	0	21.03	21.11	21.06	3			36	0	20.70	20.89	20.78	3
		50	25	21.05	21.15	21.16	3			36	19	20.77	20.95	20.94	3
		50	50	20.97	21.10	21.11	3			36	39	20.72	20.87	20.88	3
	100	0	20.93	21.07	21.12	3	75		0	20.74	20.80	20.83	3		
10M	QPSK	1	0	23.72	23.84	23.75	0	5M	QPSK	1	0	23.72	23.85	23.77	0
		1	24	23.67	23.71	23.69	0			1	12	23.55	23.81	23.68	0
		1	49	23.55	23.78	23.79	0			1	24	23.60	23.76	23.56	0
		25	0	22.65	22.82	22.85	1			12	0	22.71	22.85	22.59	1
		25	12	22.73	22.88	22.92	1			12	6	22.81	22.90	22.81	1
		25	25	22.76	22.71	22.78	1			12	13	22.80	22.88	22.68	1
		50	0	22.68	22.76	22.90	1			25	0	22.75	22.81	22.82	1
	16QAM	1	0	22.73	22.80	22.74	1		16QAM	1	0	22.62	22.79	22.76	1
		1	24	22.59	22.62	22.67	1			1	12	22.60	22.82	22.74	1
		1	49	22.57	22.66	22.75	1			1	24	22.52	22.69	22.63	1
		25	0	21.63	21.75	21.88	2			12	0	21.56	21.82	21.82	2
		25	12	21.73	21.96	21.69	2			12	6	21.78	21.85	21.80	2
		25	25	21.72	21.90	21.77	2			12	13	21.68	21.72	21.77	2
	50	0	21.76	21.89	21.82	2	25		0	21.59	21.81	21.82	2		
	64QAM	1	0	21.67	21.69	21.80	2		64QAM	1	0	21.73	21.73	21.81	2
		1	24	21.52	21.64	21.68	2			1	12	21.56	21.81	21.77	2
		1	49	21.45	21.70	21.74	2			1	24	21.58	21.81	21.58	2
		25	0	20.59	20.78	20.84	3			12	0	20.70	20.68	20.69	3
		25	12	20.83	20.89	20.76	3			12	6	20.64	20.83	20.89	3
		25	25	20.77	20.76	20.80	3			12	13	20.71	20.82	20.79	3
	50	0	20.55	20.76	20.76	3	25		0	20.64	20.85	20.80	3		
3M	QPSK	1	0	23.60	23.91	23.89	0	1.4M	QPSK	1	0	23.71	23.90	23.86	0
		1	7	23.67	23.85	23.68	0			1	2	23.71	23.71	23.72	0
		1	14	23.52	23.66	23.65	0			1	5	23.54	23.65	23.62	0
		8	0	22.81	22.94	22.82	1			3	0	23.72	23.74	23.86	0
		8	3	22.70	23.00	22.98	1			3	1	23.83	23.89	23.83	0
		8	7	22.65	22.75	22.78	1			3	3	23.68	23.88	23.81	0
		15	0	22.63	22.76	22.81	1			6	0	22.59	22.84	22.83	1
	16QAM	1	0	22.64	22.81	22.79	1		16QAM	1	0	22.73	22.81	22.71	1
		1	7	22.61	22.82	22.68	1			1	2	22.61	22.82	22.79	1
		1	14	22.50	22.63	22.66	1			1	5	22.62	22.68	22.68	1
		8	0	21.69	21.70	21.77	2			3	0	22.70	22.74	22.70	1
		8	3	21.69	21.94	21.86	2			3	1	22.68	22.94	22.79	1
		8	7	21.56	21.84	21.73	2			3	3	22.61	22.87	22.76	1
	15	0	21.60	21.72	21.91	2	6		0	21.59	21.84	21.75	2		
	64QAM	1	0	21.53	21.95	21.80	2		64QAM	1	0	21.69	21.82	21.88	2
		1	7	21.59	21.75	21.66	2			1	2	21.69	21.68	21.59	2
		1	14	21.54	21.68	21.71	2			1	5	21.52	21.57	21.72	2
		8	0	20.71	20.81	20.75	3			3	0	21.81	21.97	21.73	2
		8	3	20.69	20.85	20.95	3			3	1	21.63	21.84	21.90	2
		8	7	20.64	20.78	20.76	3			3	3	21.64	21.75	21.82	2
	15	0	20.63	20.91	20.86	3	6		0	20.69	20.86	20.70	3		

EIRP Power (dBm)

GSM							
Plane	Channel	Frequency (MHz)	Reading (dBm)	Correction Factor (dB)	EIRP (dBm)	EIRP (mW)	Polarization (H/V)
Z	512	1850.2	-5.23	38.19	32.96	1976.97	H
	661	1880.0	-5.72	38.70	32.98	1986.09	
	810	1909.8	-6.44	39.35	32.91	1954.34	
	512	1850.2	-6.65	38.48	31.83	1524.05	V
	661	1880.0	-6.70	38.59	31.89	1545.25	
	810	1909.8	-7.07	38.87	31.80	1513.56	

Note: EIRP (dBm) = Reading (dBm) + Correction Factor (dB)

EDGE							
Plane	Channel	Frequency (MHz)	Reading (dBm)	Correction Factor (dB)	EIRP (dBm)	EIRP (mW)	Polarization (H/V)
Z	512	1850.2	-10.12	38.19	28.07	641.21	H
	661	1880.0	-10.60	38.70	28.10	645.65	
	810	1909.8	-11.20	39.35	28.15	653.13	
	512	1850.2	-11.45	38.48	27.03	504.66	V
	661	1880.0	-11.51	38.59	27.08	510.50	
	810	1909.8	-11.74	38.87	27.13	516.42	

Note: EIRP (dBm) = Reading (dBm) + Correction Factor (dB)

WCDMA							
Plane	Channel	Frequency (MHz)	Reading (dBm)	Correction Factor (dB)	EIRP (dBm)	EIRP (mW)	Polarization (H/V)
Z	9262	1852.4	-13.12	38.19	25.07	321.37	H
	9400	1880.0	-13.59	38.70	25.11	324.34	
	9538	1907.6	-14.21	39.35	25.14	326.59	
	9262	1852.4	-14.40	38.48	24.08	255.86	V
	9400	1880.0	-14.47	38.59	24.12	258.23	
	9538	1907.6	-14.71	38.87	24.16	260.62	

Note: EIRP (dBm) = Reading (dBm) + Correction Factor (dB)

LTE Band 2							
Channel Bandwidth: 1.4 MHz / QPSK							
Plane	Channel	Frequency (MHz)	Reading (dBm)	Correction Factor (dB)	EIRP (dBm)	EIRP (mW)	Polarization (H/V)
Z	18607	1850.7	-18.87	44.70	25.83	382.82	H
	18900	1880.0	-18.95	44.70	25.75	375.84	
	19193	1909.3	-19.21	44.57	25.36	343.80	
	18607	1850.7	-19.55	44.27	24.72	296.48	V
	18900	1880.0	-20.10	44.87	24.77	299.92	
	19193	1909.3	-20.54	44.61	24.07	255.45	
Channel Bandwidth: 1.4 MHz / 16QAM							
Z	18607	1850.7	-19.85	44.70	24.85	305.49	H
	18900	1880.0	-19.87	44.70	24.83	304.09	
	19193	1909.3	-19.79	44.57	24.78	300.82	
	18607	1850.7	-20.58	44.27	23.69	233.88	V
	18900	1880.0	-21.62	44.87	23.25	211.35	
	19193	1909.3	-21.57	44.61	23.04	201.51	
Channel Bandwidth: 1.4 MHz / 64QAM							
Z	18607	1850.7	-20.98	44.70	23.72	235.50	H
	18900	1880.0	-20.75	44.70	23.95	248.31	
	19193	1909.3	-21.12	44.57	23.45	221.46	
	18607	1850.7	-21.56	44.27	22.71	186.64	V
	18900	1880.0	-21.94	44.87	22.93	196.34	
	19193	1909.3	-22.12	44.61	22.49	177.54	

Note: EIRP (dBm) = Reading (dBm) + Correction Factor (dB)

LTE Band 2							
Channel Bandwidth: 3 MHz / QPSK							
Plane	Channel	Frequency (MHz)	Reading (dBm)	Correction Factor (dB)	EIRP (dBm)	EIRP (mW)	Polarization (H/V)
Z	18615	1851.5	-18.95	44.70	25.75	375.84	H
	18900	1880.0	-18.98	44.70	25.72	373.25	
	19185	1908.5	-19.23	44.57	25.34	342.22	
	18615	1851.5	-19.56	44.27	24.71	295.60	V
	18900	1880.0	-20.22	44.87	24.65	291.74	
	19185	1908.5	-19.85	44.61	24.76	299.43	
Channel Bandwidth: 3 MHz / 16QAM							
Z	18615	1851.5	-19.88	44.70	24.82	303.39	H
	18900	1880.0	-20.23	44.70	24.47	279.90	
	19185	1908.5	-19.81	44.57	24.76	299.43	
	18615	1851.5	-20.85	44.27	23.42	219.79	V
	18900	1880.0	-21.27	44.87	23.60	229.09	
	19185	1908.5	-20.88	44.61	23.73	236.21	
Channel Bandwidth: 3 MHz / 64QAM							
Z	18615	1851.5	-20.85	44.70	23.85	242.66	H
	18900	1880.0	-20.79	44.70	23.91	246.04	
	19185	1908.5	-21.36	44.57	23.21	209.56	
	18615	1851.5	-21.74	44.27	22.53	179.06	V
	18900	1880.0	-21.91	44.87	22.96	197.70	
	19185	1908.5	-21.73	44.61	22.88	194.22	

Note: EIRP (dBm) = Reading (dBm) + Correction Factor (dB)

LTE Band 2							
Channel Bandwidth: 5 MHz / QPSK							
Plane	Channel	Frequency (MHz)	Reading (dBm)	Correction Factor (dB)	EIRP (dBm)	EIRP (mW)	Polarization (H/V)
Z	18625	1852.5	-18.77	44.70	25.93	391.74	H
	18900	1880.0	-19.52	44.70	25.18	329.61	
	19175	1907.5	-19.23	44.57	25.34	342.22	
	18625	1852.5	-19.69	44.27	24.58	287.08	V
	18900	1880.0	-20.52	44.87	24.35	272.27	
	19175	1907.5	-20.12	44.61	24.49	281.25	
Channel Bandwidth: 5 MHz / 16QAM							
Z	18625	1852.5	-20.12	44.70	24.58	287.08	H
	18900	1880.0	-19.88	44.70	24.82	303.39	
	19175	1907.5	-19.76	44.57	24.81	302.90	
	18625	1852.5	-20.51	44.27	23.76	237.68	V
	18900	1880.0	-21.50	44.87	23.37	217.27	
	19175	1907.5	-20.78	44.61	23.83	241.71	
Channel Bandwidth: 5 MHz / 64QAM							
Z	18625	1852.5	-21.52	44.70	23.18	207.97	H
	18900	1880.0	-20.98	44.70	23.72	235.50	
	19175	1907.5	-20.75	44.57	23.82	241.16	
	18625	1852.5	-21.56	44.27	22.71	186.64	V
	18900	1880.0	-22.23	44.87	22.64	183.65	
	19175	1907.5	-21.79	44.61	22.82	191.56	

Note: EIRP (dBm) = Reading (dBm) + Correction Factor (dB)

LTE Band 2							
Channel Bandwidth: 10 MHz / QPSK							
Plane	Channel	Frequency (MHz)	Reading (dBm)	Correction Factor (dB)	EIRP (dBm)	EIRP (mW)	Polarization (H/V)
Z	18650	1855.0	-18.78	44.70	25.92	390.84	H
	18900	1880.0	-19.56	44.70	25.14	326.59	
	19150	1905.0	-18.95	44.57	25.62	365.01	
	18650	1855.0	-19.62	44.27	24.65	291.74	V
	18900	1880.0	-20.53	44.87	24.34	271.64	
	19150	1905.0	-20.12	44.61	24.49	281.38	
Channel Bandwidth: 10 MHz / 16QAM							
Z	18650	1855.0	-20.36	44.70	24.34	271.64	H
	18900	1880.0	-19.78	44.70	24.92	310.46	
	19150	1905.0	-20.22	44.57	24.35	272.46	
	18650	1855.0	-20.55	44.27	23.72	235.50	V
	18900	1880.0	-21.36	44.87	23.51	224.39	
	19150	1905.0	-21.01	44.61	23.60	229.25	
Channel Bandwidth: 10 MHz / 64QAM							
Z	18650	1855.0	-21.45	44.70	23.25	211.35	H
	18900	1880.0	-21.12	44.70	23.58	228.03	
	19150	1905.0	-21.34	44.57	23.23	210.52	
	18650	1855.0	-21.52	44.27	22.75	188.36	V
	18900	1880.0	-21.90	44.87	22.97	198.15	
	19150	1905.0	-22.13	44.61	22.48	177.13	

Note: EIRP (dBm) = Reading (dBm) + Correction Factor (dB)

LTE Band 2							
Channel Bandwidth: 15 MHz / QPSK							
Plane	Channel	Frequency (MHz)	Reading (dBm)	Correction Factor (dB)	EIRP (dBm)	EIRP (mW)	Polarization (H/V)
Z	18675	1857.5	-18.75	44.70	25.95	393.55	H
	18900	1880.0	-18.95	44.70	25.75	375.84	
	19125	1902.5	-18.88	44.57	25.69	370.94	
	18675	1857.5	-19.62	44.27	24.65	291.74	V
	18900	1880.0	-20.24	44.87	24.63	290.40	
	19125	1902.5	-19.75	44.61	24.86	306.41	
Channel Bandwidth: 15 MHz / 16QAM							
Z	18675	1857.5	-19.87	44.70	24.83	304.09	H
	18900	1880.0	-20.66	44.70	24.04	253.51	
	19125	1902.5	-20.41	44.57	24.16	260.80	
	18675	1857.5	-20.89	44.27	23.38	217.77	V
	18900	1880.0	-21.51	44.87	23.36	216.77	
	19125	1902.5	-21.47	44.61	23.14	206.21	
Channel Bandwidth: 15 MHz / 64QAM							
Z	18675	1857.5	-20.79	44.70	23.91	246.04	H
	18900	1880.0	-20.81	44.70	23.89	244.91	
	19125	1902.5	-20.69	44.57	23.88	244.51	
	18675	1857.5	-21.57	44.27	22.70	186.21	V
	18900	1880.0	-21.99	44.87	22.88	194.09	
	19125	1902.5	-22.36	44.61	22.25	168.00	

Note: EIRP (dBm) = Reading (dBm) + Correction Factor (dB)

LTE Band 2							
Channel Bandwidth: 20 MHz / QPSK							
Plane	Channel	Frequency (MHz)	Reading (dBm)	Correction Factor (dB)	EIRP (dBm)	EIRP (mW)	Polarization (H/V)
Z	18700	1860.0	-18.72	44.70	25.98	396.28	H
	18900	1880.0	-18.86	44.70	25.84	383.71	
	19100	1900.0	-18.99	44.57	25.58	361.66	
	18700	1860.0	-19.40	44.27	24.87	306.90	V
	18900	1880.0	-20.05	44.87	24.82	303.39	
	19100	1900.0	-19.83	44.61	24.78	300.82	
Channel Bandwidth: 20 MHz / 16QAM							
Z	18700	1860.0	-19.85	44.70	24.85	305.49	H
	18900	1880.0	-20.14	44.70	24.56	285.76	
	19100	1900.0	-19.59	44.57	24.98	314.99	
	18700	1860.0	-20.56	44.27	23.71	234.96	V
	18900	1880.0	-21.24	44.87	23.63	230.67	
	19100	1900.0	-20.99	44.61	23.62	230.30	
Channel Bandwidth: 20 MHz / 64QAM							
Z	18700	1860.0	-20.72	44.70	23.98	250.03	H
	18900	1880.0	-20.88	44.70	23.82	240.99	
	19100	1900.0	-21.45	44.57	23.12	205.26	
	18700	1860.0	-21.58	44.27	22.69	185.78	V
	18900	1880.0	-21.91	44.87	22.96	197.70	
	19100	1900.0	-21.75	44.61	22.86	193.33	

Note: EIRP (dBm) = Reading (dBm) + Correction Factor (dB)

4.2 Modulation Characteristics Measurement

4.2.1 Limits of Modulation Characteristics

N/A

4.2.2 Test Setup



4.2.3 Test Procedure

Connect the EUT to Communication Simulator via the antenna connector. The frequency band is set as EUT supported Modulation and Channels, the EUT output is matched with 50 ohm load, the waveform quality and constellation of the EUT was tested.

4.2.4 Test Results

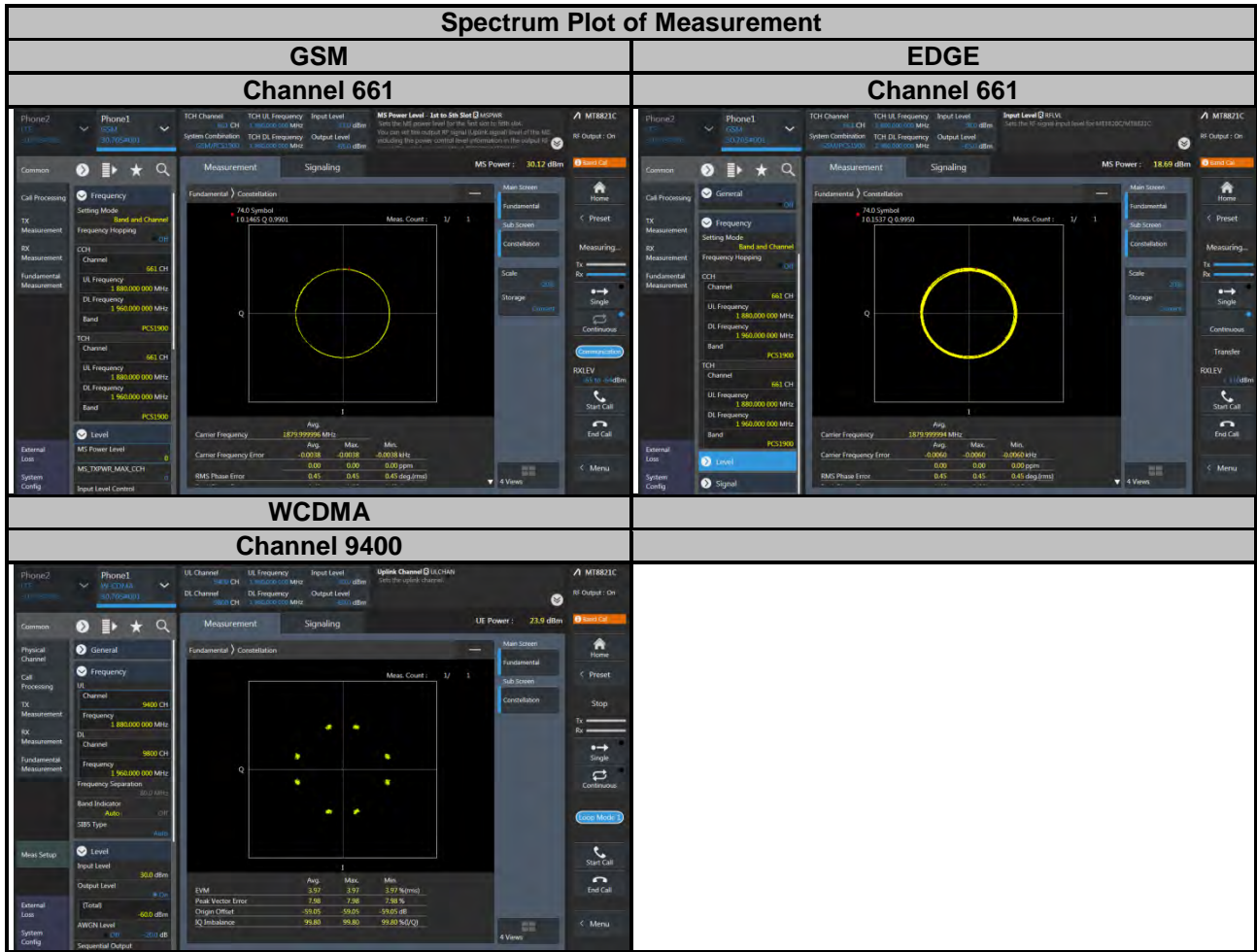

Spectrum Plot of Measurement

LTE Band 2

Channel 18900

QPSK

16QAM

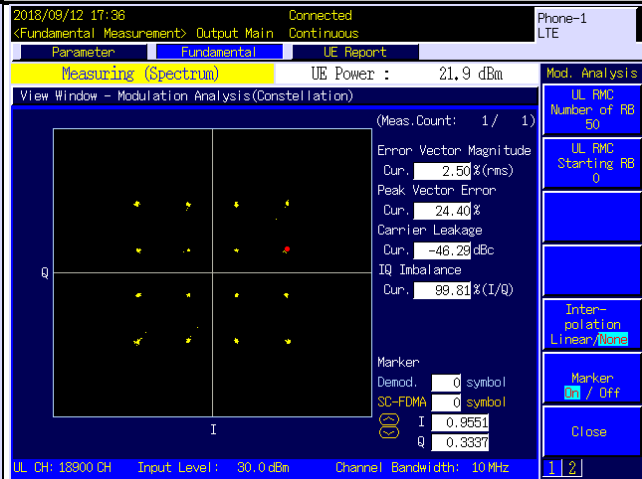
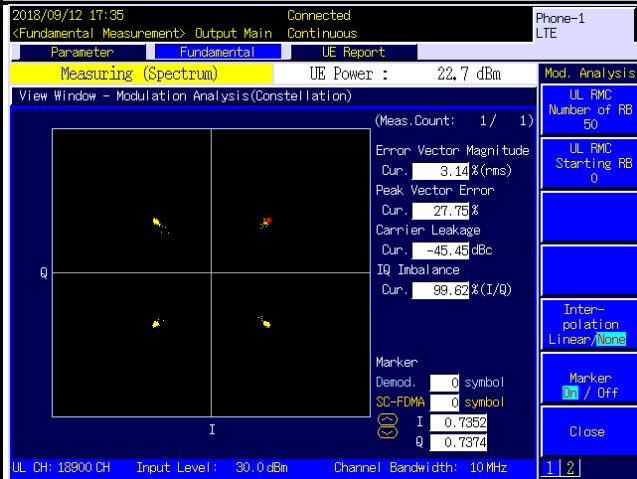

64QAM

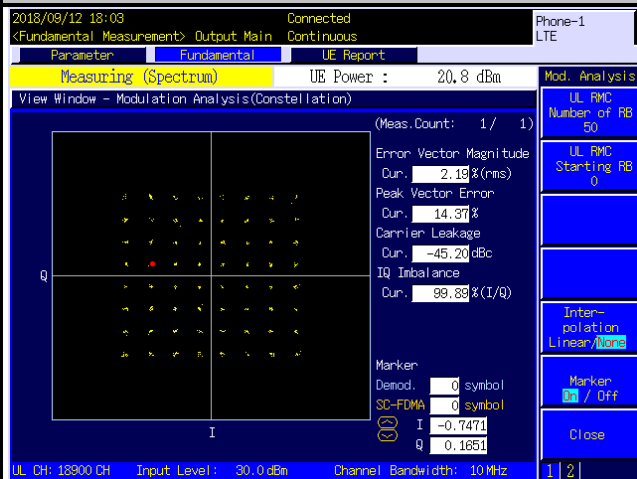

4.3 Frequency Stability Measurement

4.3.1 Limits of Frequency Stability Measurement

The frequency stability shall be sufficient to ensure that the fundamental emission stays within the authorized frequency block.

4.3.2 Test Procedure

- Device is placed at the oven room. The oven room could control the temperatures and humidity. Power warm up is at least 15 min and power applied should perform before recording frequency error.
- EUT is connected the external power supply to control the DC input power. The test voltage range is from minimum to maximum working voltage. Each step shall be record the frequency error rate.
- The temperature range step is 10 degrees in this test items. All temperature levels shall be hold the ± 0.5 °C during the measurement testing. The each temperature step shall be at least 0.5 hours, consider the EUT could be test under the stability condition.

NOTE: The frequency error was recorded frequency error from the communication simulator.

4.3.3 Test Setup

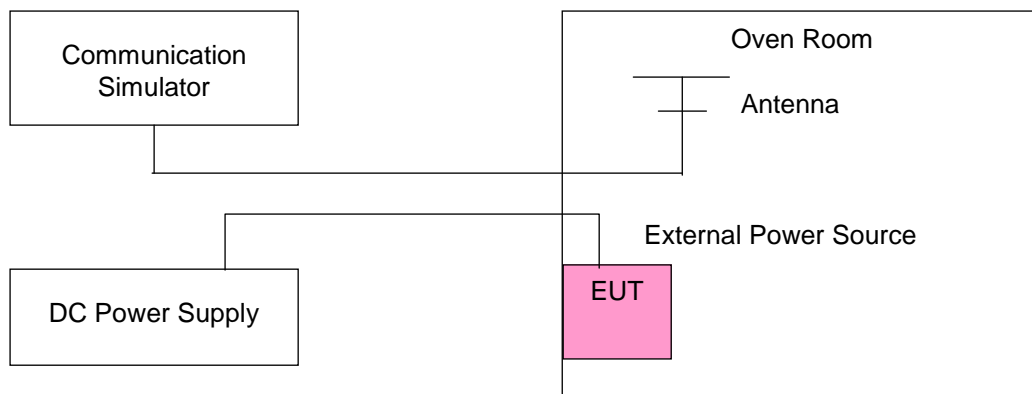

4.3.4 Test Results

Frequency Error vs. Voltage

Voltage (Volts)	GSM				Limit (ppm)
	Low Channel		High Channel		
	Frequency (MHz)	Frequency Error (ppm)	Frequency (MHz)	Frequency Error (ppm)	
3.8	1850.200004	0.002	1909.800001	0.001	2.5
3.23	1850.200002	0.001	1909.800002	0.001	2.5
4.37	1850.200004	0.002	1909.800002	0.001	2.5

Note: The applicant defined the normal working voltage of the battery is from 3.23 Vdc to 4.37 Vdc.

Frequency Error vs. Temperature

Temp. (°C)	GSM				Limit (ppm)
	Low Channel		High Channel		
	Frequency (MHz)	Frequency Error (ppm)	Frequency (MHz)	Frequency Error (ppm)	
-30	1850.200003	0.002	1909.800003	0.002	2.5
-20	1850.200001	0.001	1909.800003	0.001	2.5
-10	1850.200002	0.001	1909.800003	0.002	2.5
0	1850.200001	0.001	1909.800004	0.002	2.5
10	1850.200002	0.001	1909.800002	0.001	2.5
20	1850.199998	-0.001	1909.799998	-0.001	2.5
30	1850.199997	-0.001	1909.799998	-0.001	2.5
40	1850.199999	-0.001	1909.799997	-0.002	2.5
50	1850.199996	-0.002	1909.799998	-0.001	2.5
60	1850.199997	-0.002	1909.799998	-0.001	2.5

Frequency Error vs. Voltage

Voltage (Volts)	EDGE				Limit (ppm)
	Low Channel		High Channel		
	Frequency (MHz)	Frequency Error (ppm)	Frequency (MHz)	Frequency Error (ppm)	
3.8	1850.200002	0.001	1909.800003	0.002	2.5
3.23	1850.200002	0.001	1909.800003	0.002	2.5
4.37	1850.200004	0.002	1909.800001	0.001	2.5

Note: The applicant defined the normal working voltage of the battery is from 3.23 Vdc to 4.37 Vdc.

Frequency Error vs. Temperature

Temp. (°C)	EDGE				Limit (ppm)
	Low Channel		High Channel		
	Frequency (MHz)	Frequency Error (ppm)	Frequency (MHz)	Frequency Error (ppm)	
-30	1850.200003	0.002	1909.800004	0.002	2.5
-20	1850.200003	0.002	1909.800003	0.002	2.5
-10	1850.200002	0.001	1909.800002	0.001	2.5
0	1850.200003	0.002	1909.800004	0.002	2.5
10	1850.200003	0.002	1909.800003	0.001	2.5
20	1850.199998	-0.001	1909.799998	-0.001	2.5
30	1850.199997	-0.002	1909.799998	-0.001	2.5
40	1850.199999	-0.001	1909.799998	-0.001	2.5
50	1850.199998	-0.001	1909.799996	-0.002	2.5
60	1850.199998	-0.001	1909.799997	-0.002	2.5

Frequency Error vs. Voltage

Voltage (Volts)	WCDMA				Limit (ppm)
	Low Channel		High Channel		
	Frequency (MHz)	Frequency Error (ppm)	Frequency (MHz)	Frequency Error (ppm)	
3.8	1852.400001	0.001	1907.600003	0.002	2.5
3.23	1852.400001	0.001	1907.600003	0.002	2.5
4.37	1852.400003	0.002	1907.600004	0.002	2.5

Note: The applicant defined the normal working voltage of the battery is from 3.23 Vdc to 4.37 Vdc.

Frequency Error vs. Temperature

Temp. (°C)	WCDMA				Limit (ppm)
	Low Channel		High Channel		
	Frequency (MHz)	Frequency Error (ppm)	Frequency (MHz)	Frequency Error (ppm)	
-30	1852.400004	0.002	1907.600002	0.001	2.5
-20	1852.400003	0.001	1907.600001	0.001	2.5
-10	1852.400001	0.001	1907.600003	0.001	2.5
0	1852.400003	0.002	1907.600002	0.001	2.5
10	1852.400001	0.001	1907.600003	0.002	2.5
20	1852.399997	-0.002	1907.599998	-0.001	2.5
30	1852.399997	-0.002	1907.599997	-0.002	2.5
40	1852.399997	-0.002	1907.599997	-0.001	2.5
50	1852.399997	-0.002	1907.599998	-0.001	2.5
60	1852.399998	-0.001	1907.599999	-0.001	2.5

Frequency Error vs. Voltage

Voltage (Volts)	LTE Band 2				Limit (ppm)
	Channel Bandwidth: 1.4 MHz				
	Low Channel		High Channel		
	Frequency (MHz)	Frequency Error (ppm)	Frequency (MHz)	Frequency Error (ppm)	
3.8	1850.700003	0.002	1909.300001	0.001	2.5
3.23	1850.700001	0.001	1909.300004	0.002	2.5
4.37	1850.700002	0.001	1909.300004	0.002	2.5

Note: The applicant defined the normal working voltage of the battery is from 3.23 Vdc to 4.37 Vdc.

Frequency Error vs. Temperature

Temp. (°C)	LTE Band 2				Limit (ppm)
	Channel Bandwidth: 1.4 MHz				
	Low Channel		High Channel		
	Frequency (MHz)	Frequency Error (ppm)	Frequency (MHz)	Frequency Error (ppm)	
-30	1850.700003	0.001	1909.300002	0.001	2.5
-20	1850.700001	0.001	1909.300002	0.001	2.5
-10	1850.700002	0.001	1909.300004	0.002	2.5
0	1850.700001	0.001	1909.300001	0.001	2.5
10	1850.700004	0.002	1909.300003	0.002	2.5
20	1850.699998	-0.001	1909.299998	-0.001	2.5
30	1850.699997	-0.002	1909.299999	-0.001	2.5
40	1850.699998	-0.001	1909.299996	-0.002	2.5
50	1850.699996	-0.002	1909.299998	-0.001	2.5
60	1850.699997	-0.002	1909.299998	-0.001	2.5

Frequency Error vs. Voltage

Voltage (Volts)	LTE Band 2				Limit (ppm)
	Channel Bandwidth: 3 MHz				
	Low Channel		High Channel		
	Frequency (MHz)	Frequency Error (ppm)	Frequency (MHz)	Frequency Error (ppm)	
3.8	1851.500003	0.002	1908.500002	0.001	2.5
3.23	1851.500004	0.002	1908.500004	0.002	2.5
4.37	1851.500001	0.001	1908.500002	0.001	2.5

Note: The applicant defined the normal working voltage of the battery is from 3.23 Vdc to 4.37 Vdc.

Frequency Error vs. Temperature

Temp. (°C)	LTE Band 2				Limit (ppm)
	Channel Bandwidth: 3 MHz				
	Low Channel		High Channel		
	Frequency (MHz)	Frequency Error (ppm)	Frequency (MHz)	Frequency Error (ppm)	
-30	1851.500003	0.001	1908.500001	0.001	2.5
-20	1851.500001	0.001	1908.500003	0.001	2.5
-10	1851.500002	0.001	1908.500002	0.001	2.5
0	1851.500004	0.002	1908.500003	0.001	2.5
10	1851.500001	0.001	1908.500001	0.001	2.5
20	1851.499998	-0.001	1908.499998	-0.001	2.5
30	1851.499998	-0.001	1908.499997	-0.002	2.5
40	1851.499999	-0.001	1908.499998	-0.001	2.5
50	1851.499999	-0.001	1908.499998	-0.001	2.5
60	1851.499997	-0.002	1908.499998	-0.001	2.5

Frequency Error vs. Voltage

Voltage (Volts)	LTE Band 2				Limit (ppm)
	Channel Bandwidth: 5 MHz				
	Low Channel		High Channel		
	Frequency (MHz)	Frequency Error (ppm)	Frequency (MHz)	Frequency Error (ppm)	
3.8	1852.500003	0.002	1907.500002	0.001	2.5
3.23	1852.500002	0.001	1907.500002	0.001	2.5
4.37	1852.500004	0.002	1907.500002	0.001	2.5

Note: The applicant defined the normal working voltage of the battery is from 3.23 Vdc to 4.37 Vdc.

Frequency Error vs. Temperature

Temp. (°C)	LTE Band 2				Limit (ppm)
	Channel Bandwidth: 5 MHz				
	Low Channel		High Channel		
	Frequency (MHz)	Frequency Error (ppm)	Frequency (MHz)	Frequency Error (ppm)	
-30	1852.500002	0.001	1907.500002	0.001	2.5
-20	1852.500003	0.002	1907.500003	0.002	2.5
-10	1852.500002	0.001	1907.500002	0.001	2.5
0	1852.500002	0.001	1907.500004	0.002	2.5
10	1852.500003	0.001	1907.500004	0.002	2.5
20	1852.499999	-0.001	1907.499998	-0.001	2.5
30	1852.499997	-0.002	1907.499998	-0.001	2.5
40	1852.499999	-0.001	1907.499999	-0.001	2.5
50	1852.499998	-0.001	1907.499997	-0.002	2.5
60	1852.499998	-0.001	1907.499998	-0.001	2.5

Frequency Error vs. Voltage

Voltage (Volts)	LTE Band 2				Limit (ppm)
	Channel Bandwidth: 10 MHz				
	Low Channel		High Channel		
	Frequency (MHz)	Frequency Error (ppm)	Frequency (MHz)	Frequency Error (ppm)	
3.8	1855.000002	0.001	1905.000003	0.002	2.5
3.23	1855.000004	0.002	1905.000002	0.001	2.5
4.37	1855.000002	0.001	1905.000003	0.001	2.5

Note: The applicant defined the normal working voltage of the battery is from 3.23 Vdc to 4.37 Vdc.

Frequency Error vs. Temperature

Temp. (°C)	LTE Band 2				Limit (ppm)
	Channel Bandwidth: 10 MHz				
	Low Channel		High Channel		
	Frequency (MHz)	Frequency Error (ppm)	Frequency (MHz)	Frequency Error (ppm)	
-30	1855.000001	0.001	1905.000002	0.001	2.5
-20	1855.000004	0.002	1905.000003	0.001	2.5
-10	1855.000001	0.001	1905.000003	0.002	2.5
0	1855.000002	0.001	1905.000001	0.001	2.5
10	1855.000001	0.001	1905.000003	0.001	2.5
20	1854.999997	-0.002	1904.999999	-0.001	2.5
30	1854.999998	-0.001	1904.999996	-0.002	2.5
40	1854.999996	-0.002	1904.999997	-0.002	2.5
50	1854.999998	-0.001	1904.999997	-0.002	2.5
60	1854.999997	-0.002	1904.999997	-0.002	2.5

Frequency Error vs. Voltage

Voltage (Volts)	LTE Band 2				Limit (ppm)
	Channel Bandwidth: 15 MHz				
	Low Channel		High Channel		
	Frequency (MHz)	Frequency Error (ppm)	Frequency (MHz)	Frequency Error (ppm)	
3.8	1857.500003	0.002	1902.500004	0.002	2.5
3.23	1857.500004	0.002	1902.500002	0.001	2.5
4.37	1857.500002	0.001	1902.500003	0.001	2.5

Note: The applicant defined the normal working voltage of the battery is from 3.23 Vdc to 4.37 Vdc.

Frequency Error vs. Temperature

Temp. (°C)	LTE Band 2				Limit (ppm)
	Channel Bandwidth: 15 MHz				
	Low Channel		High Channel		
	Frequency (MHz)	Frequency Error (ppm)	Frequency (MHz)	Frequency Error (ppm)	
-30	1857.500002	0.001	1902.500003	0.001	2.5
-20	1857.500003	0.002	1902.500001	0.001	2.5
-10	1857.500002	0.001	1902.500001	0.001	2.5
0	1857.500004	0.002	1902.500004	0.002	2.5
10	1857.500003	0.001	1902.500004	0.002	2.5
20	1857.499998	-0.001	1902.499998	-0.001	2.5
30	1857.499996	-0.002	1902.499997	-0.002	2.5
40	1857.499997	-0.002	1902.499999	-0.001	2.5
50	1857.499999	-0.001	1902.499999	-0.001	2.5
60	1857.499998	-0.001	1902.499998	-0.001	2.5

Frequency Error vs. Voltage

Voltage (Volts)	LTE Band 2				Limit (ppm)
	Channel Bandwidth: 20 MHz				
	Low Channel		High Channel		
	Frequency (MHz)	Frequency Error (ppm)	Frequency (MHz)	Frequency Error (ppm)	
3.8	1860.000001	0.001	1900.000002	0.001	2.5
3.23	1860.000003	0.002	1900.000001	0.001	2.5
4.37	1860.000002	0.001	1900.000004	0.002	2.5

Note: The applicant defined the normal working voltage of the battery is from 3.23 Vdc to 4.37 Vdc.

Frequency Error vs. Temperature

Temp. (°C)	LTE Band 2				Limit (ppm)
	Channel Bandwidth: 20 MHz				
	Low Channel		High Channel		
	Frequency (MHz)	Frequency Error (ppm)	Frequency (MHz)	Frequency Error (ppm)	
-30	1860.000004	0.002	1900.000004	0.002	2.5
-20	1860.000004	0.002	1900.000002	0.001	2.5
-10	1860.000003	0.001	1900.000003	0.001	2.5
0	1860.000003	0.002	1900.000004	0.002	2.5
10	1860.000003	0.001	1900.000004	0.002	2.5
20	1859.999997	-0.001	1899.999996	-0.002	2.5
30	1859.999997	-0.002	1899.999997	-0.002	2.5
40	1859.999998	-0.001	1899.999997	-0.002	2.5
50	1859.999999	-0.001	1899.999997	-0.002	2.5
60	1859.999998	-0.001	1899.999998	-0.001	2.5

4.4 Occupied Bandwidth Measurement

4.4.1 Test Procedure

The EUT makes a call to the communication simulator. All measurements were done at low, middle and high operational frequency range. The communication simulator station system controlled a EUT to export maximum output power under transmission mode and specific channel frequency. Use OBW measurement function of Spectrum analyzer to measure 99 % occupied bandwidth.

4.4.2 Test Setup

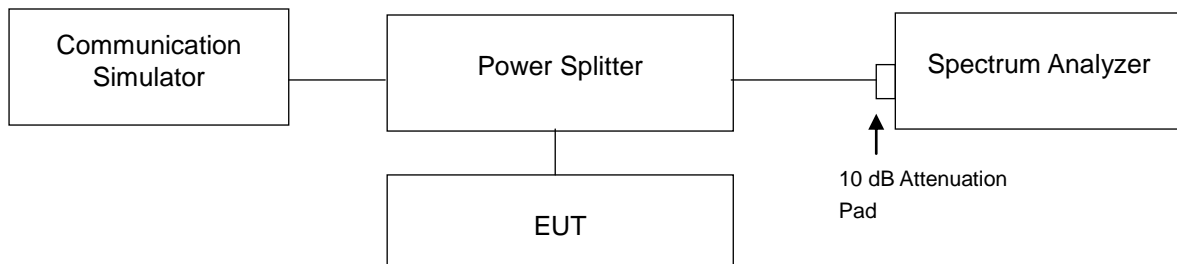

4.4.3 Test Result

Channel	Frequency (MHz)	99 % Occupied Bandwidth (kHz)		Channel	Frequency (MHz)	99 % Occupied Bandwidth (MHz)
		GSM	EDGE			WCDMA
512	1850.2	242.57	246.87	9262	1852.4	4.1460
661	1880.0	242.59	245.98	9400	1880.0	4.1444
810	1909.8	242.20	245.26	9538	1907.6	4.1414

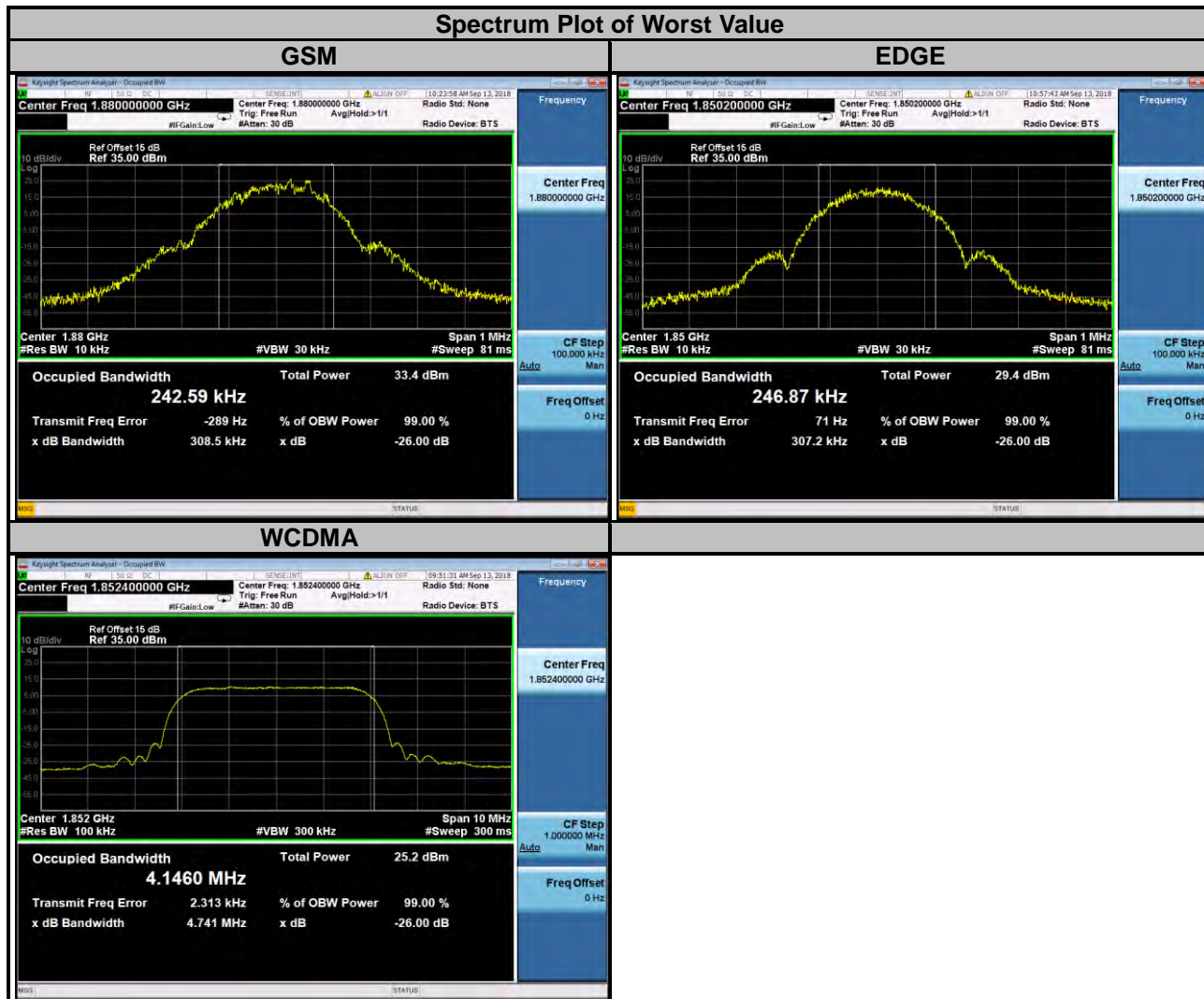

LTE Band 2									
Channel Bandwidth: 1.4 MHz					Channel Bandwidth: 3 MHz				
Channel	Frequency (MHz)	99 % Occupied Bandwidth (MHz)			Channel	Frequency (MHz)	99 % Occupied Bandwidth (MHz)		
		QPSK	16QAM	64QAM			QPSK	16QAM	64QAM
18607	1850.7	1.0880	1.0897	1.0876	18615	1851.5	2.7015	2.6985	2.7054
18900	1880.0	1.0869	1.0874	1.0874	18900	1880.0	2.7011	2.6977	2.7037
19193	1909.3	1.0858	1.0909	1.0869	19185	1908.5	2.7024	2.6983	2.7051

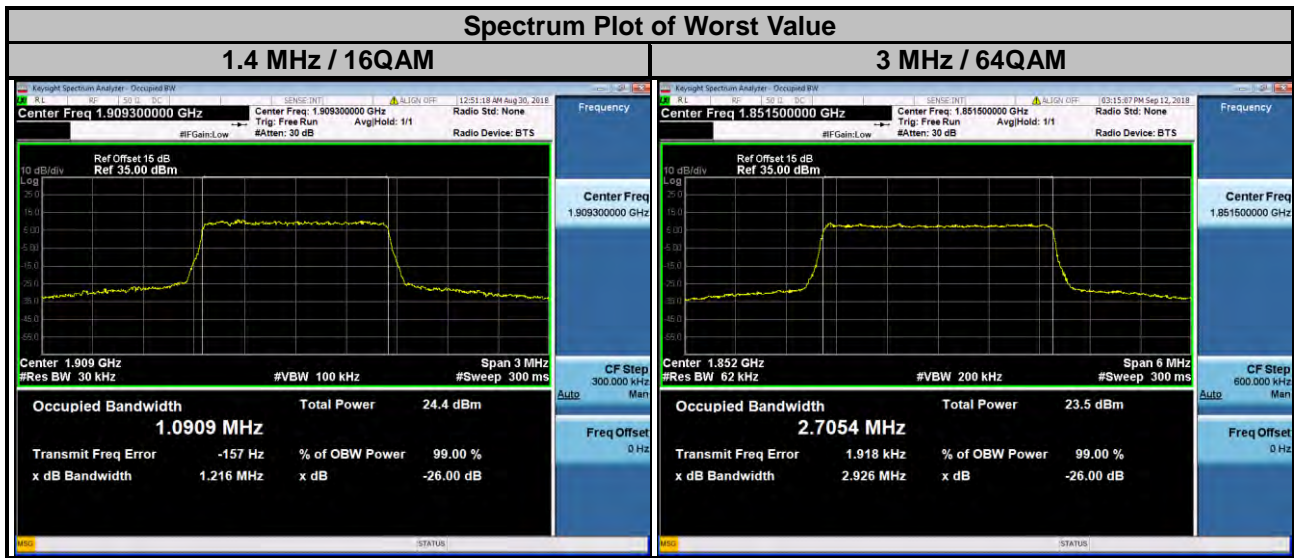

LTE Band 2

Channel Bandwidth: 5 MHz					Channel Bandwidth: 10 MHz				
Channel	Frequency (MHz)	99 % Occupied Bandwidth (MHz)			Channel	Frequency (MHz)	99 % Occupied Bandwidth (MHz)		
		QPSK	16QAM	64QAM			QPSK	16QAM	64QAM
18625	1852.5	4.4914	4.4935	4.4946	18650	1855.0	8.9676	8.9735	8.9664
18900	1880.0	4.4956	4.4966	4.4939	18900	1880.0	8.9759	8.9829	8.9720
19175	1907.5	4.4927	4.4972	4.4970	19150	1905.0	8.9746	8.9756	8.9759

Spectrum Plot of Worst Value

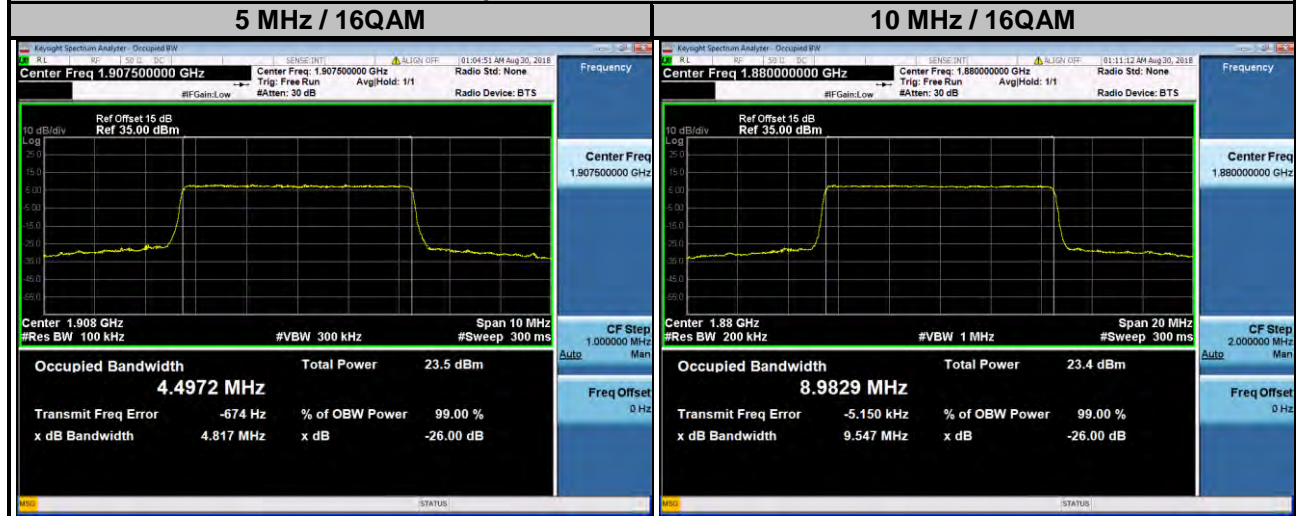

LTE Band 2									
Channel Bandwidth: 15 MHz					Channel Bandwidth: 20 MHz				
Channel	Frequency (MHz)	99 % Occupied Bandwidth (MHz)			Channel	Frequency (MHz)	99 % Occupied Bandwidth (MHz)		
		QPSK	16QAM	64QAM			QPSK	16QAM	64QAM
18675	1857.5	13.449	13.435	13.431	18700	1860.0	17.904	17.924	17.915
18900	1880.0	13.470	13.454	13.454	18900	1880.0	17.944	17.969	17.962
19125	1902.5	13.449	13.442	13.446	19100	1900.0	17.907	17.937	17.934

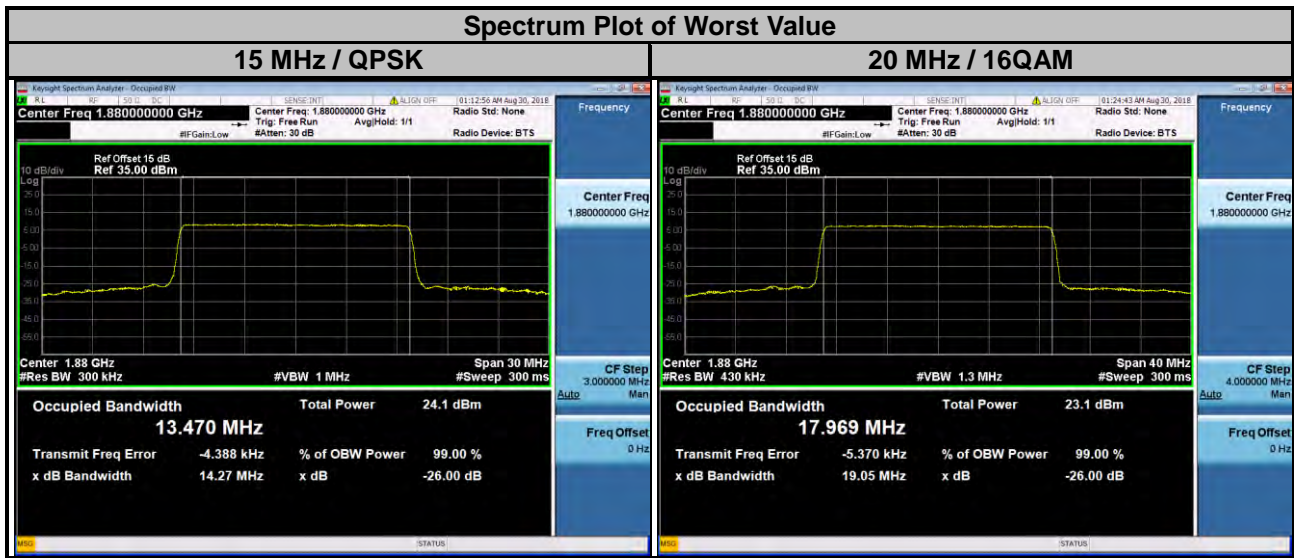

4.5 Band Edge Measurement

4.5.1 Limits of Band Edge Measurement

Power of any emission outside of the authorized operating frequency ranges must be attenuated below the transmitting power (P) by a factor of at least $43 + 10 \log(P)$ dB. In the 1 MHz bands immediately outside and adjacent to the frequency block a resolution bandwidth of at least one percent of the emission bandwidth of the fundamental emission of the transmitter may be employed.

4.5.2 Test Setup

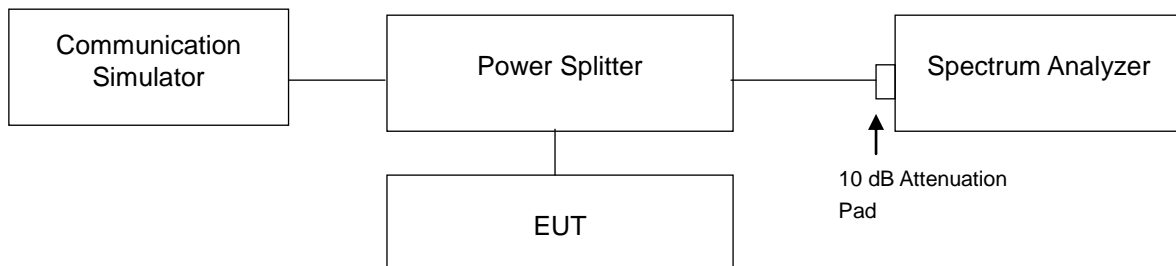

4.5.3 Test Procedures

- a. All measurements were done at low and high operational frequency range.
- b. The center frequency of spectrum is the band edge frequency and span is 1 MHz. RB of the spectrum is 10 kHz and VB of the spectrum is 30 kHz (GSM/GPRS/EDGE).
- c. The center frequency of spectrum is the band edge frequency and span is 5 MHz. RB of the spectrum is 100 kHz and VB of the spectrum is 300 kHz (WCDMA).
- d. The center frequency of spectrum is the band edge frequency and span is 1 MHz. RB of the spectrum is 15 kHz and VB of the spectrum is 51 kHz (LTE Bandwidth 1.4 MHz).
- e. The center frequency of spectrum is the band edge frequency and span is 1 MHz. RB of the spectrum is 30 kHz and VB of the spectrum is 100 kHz (LTE Bandwidth 3 MHz).
- f. The center frequency of spectrum is the band edge frequency and span is 1 MHz. RB of the spectrum is 62 kHz and VB of the spectrum is 200 kHz (LTE Bandwidth 5 MHz).
- g. The center frequency of spectrum is the band edge frequency and span is 1 MHz. RB of the spectrum is 100 kHz and VB of the spectrum is 300 kHz (LTE Bandwidth 10 MHz).
- h. The center frequency of spectrum is the band edge frequency and span is 1 MHz. RB of the spectrum is 150 kHz and VB of the spectrum is 470 kHz (LTE Bandwidth 15 MHz).
- i. The center frequency of spectrum is the band edge frequency and span is 1 MHz. RB of the spectrum is 200 kHz and VB of the spectrum is 1 MHz (LTE Bandwidth 20 MHz).
- j. Record the max trace plot into the test report.

4.5.4 Test Results

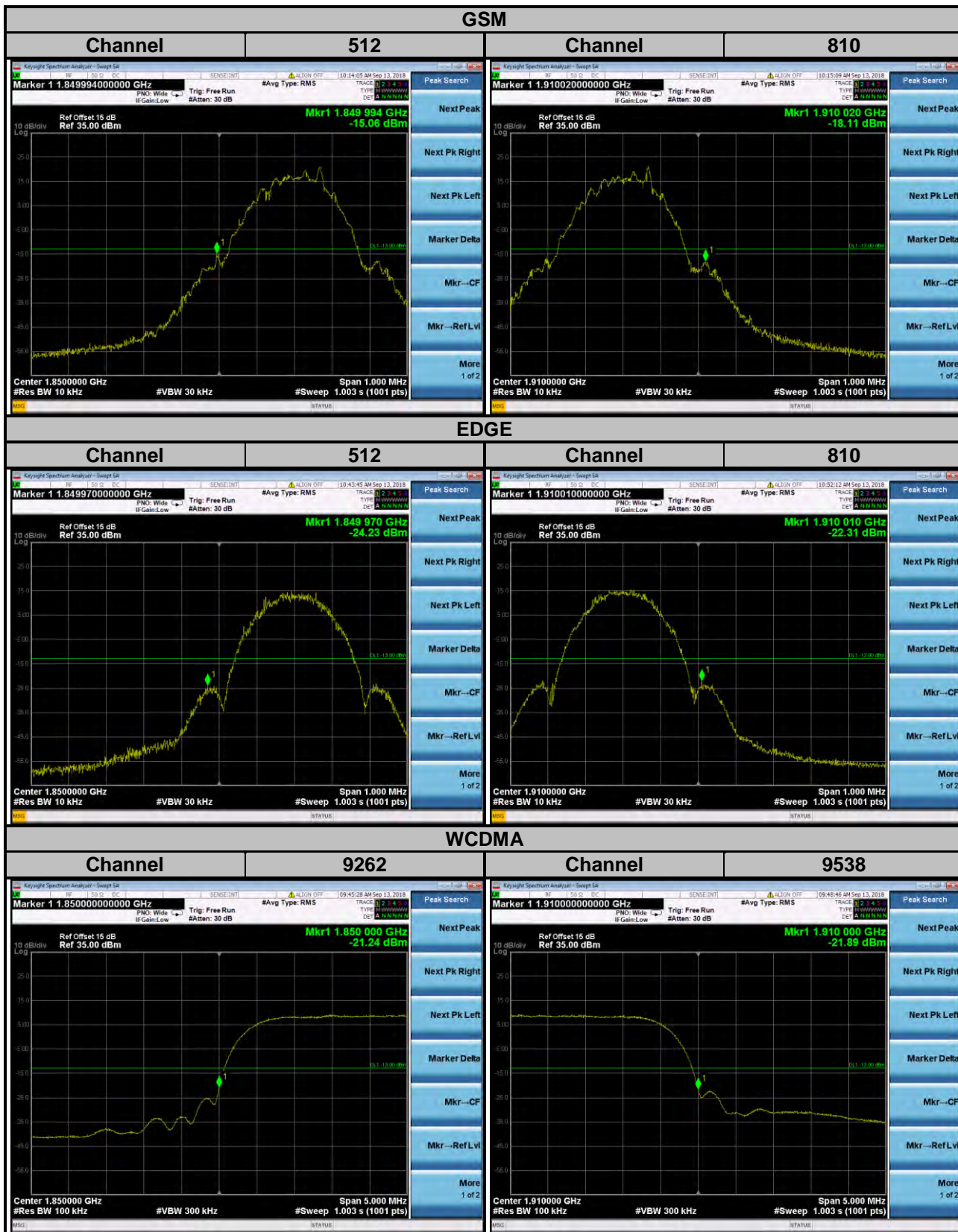

LTE Band 2
Channel Bandwidth: 1.4 MHz

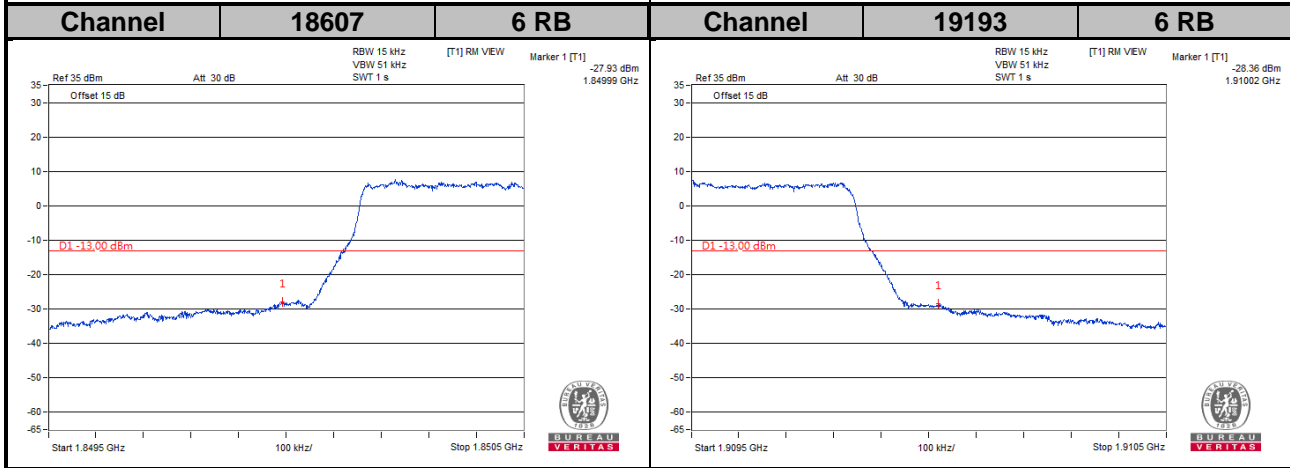
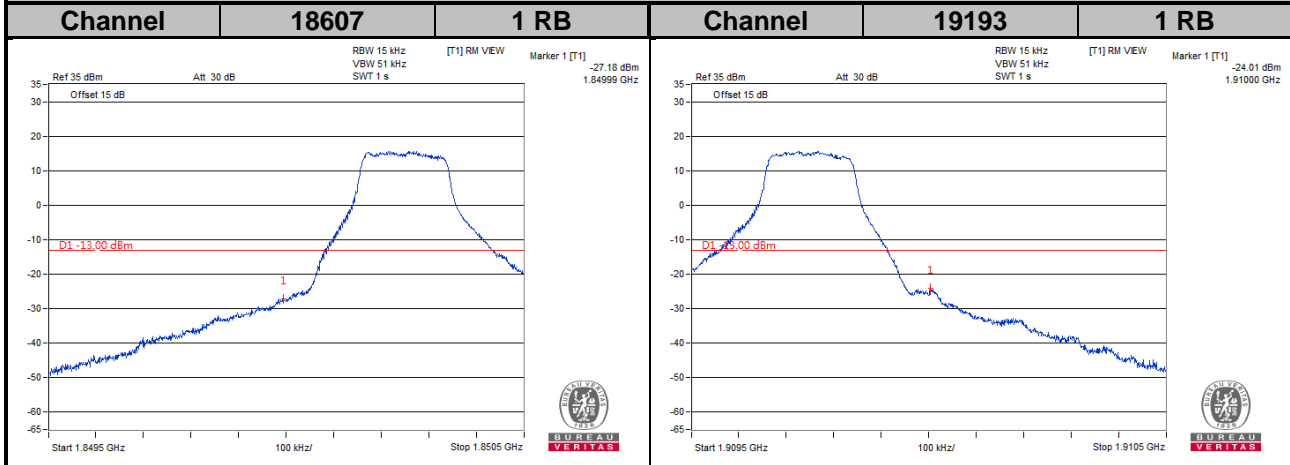

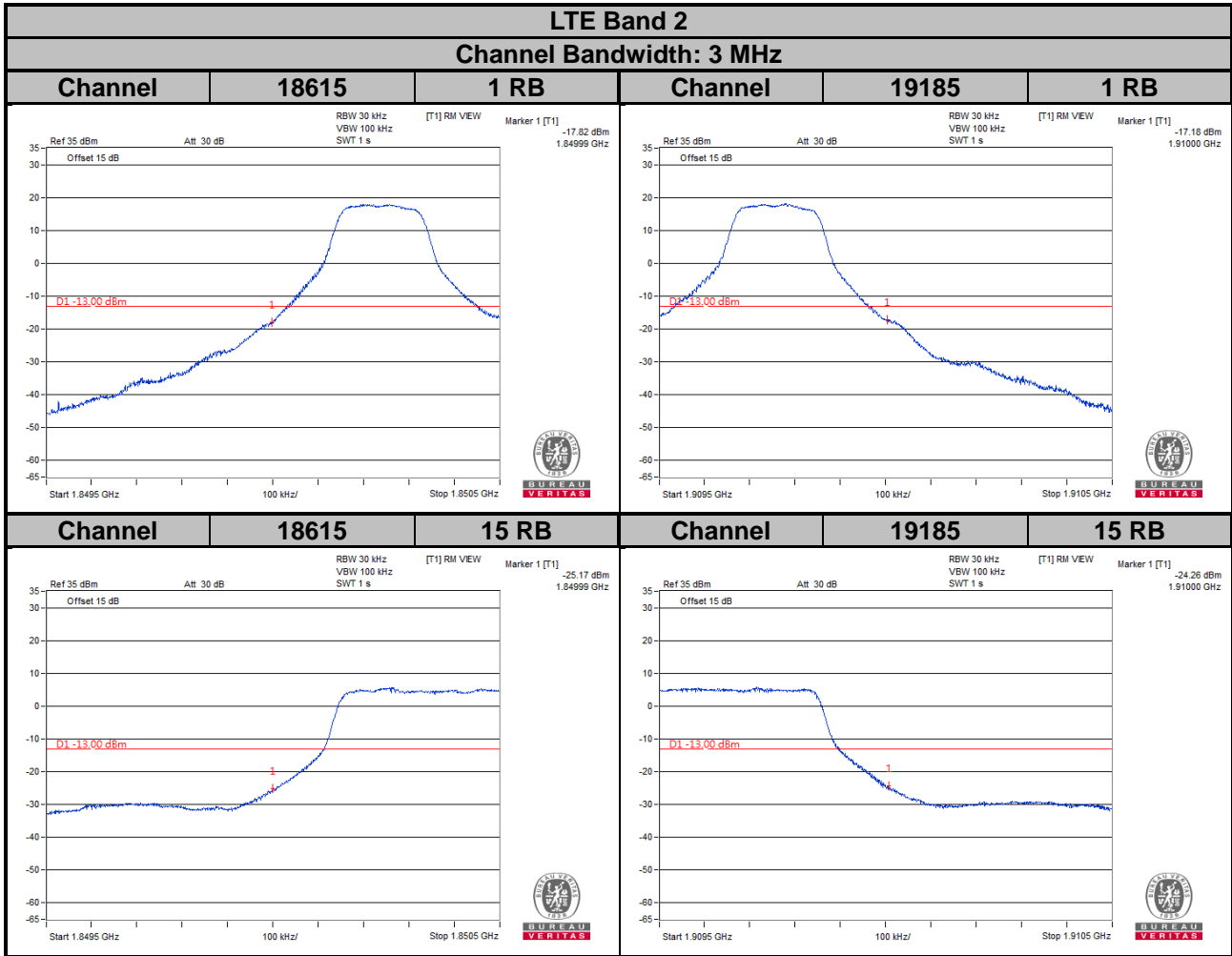

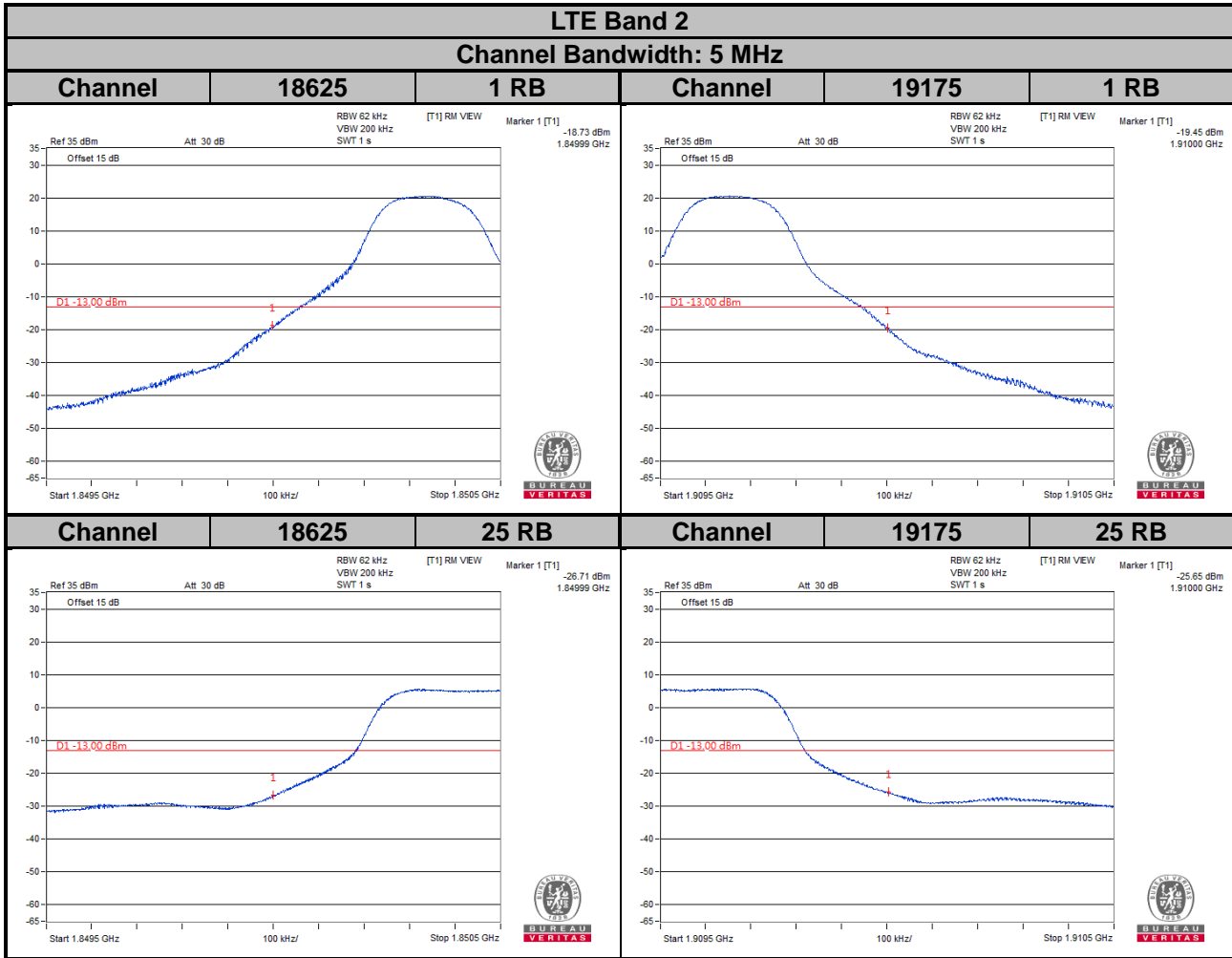

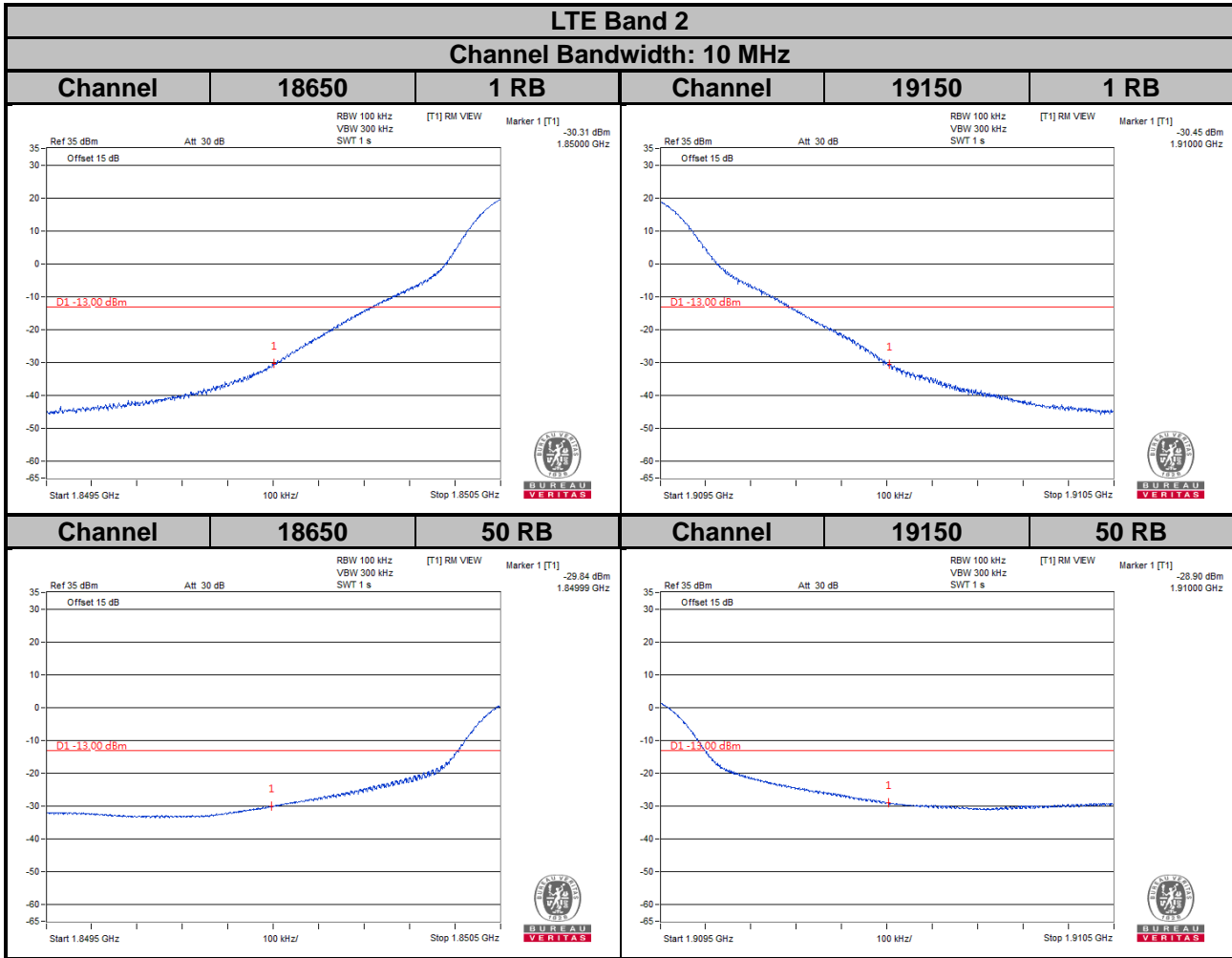

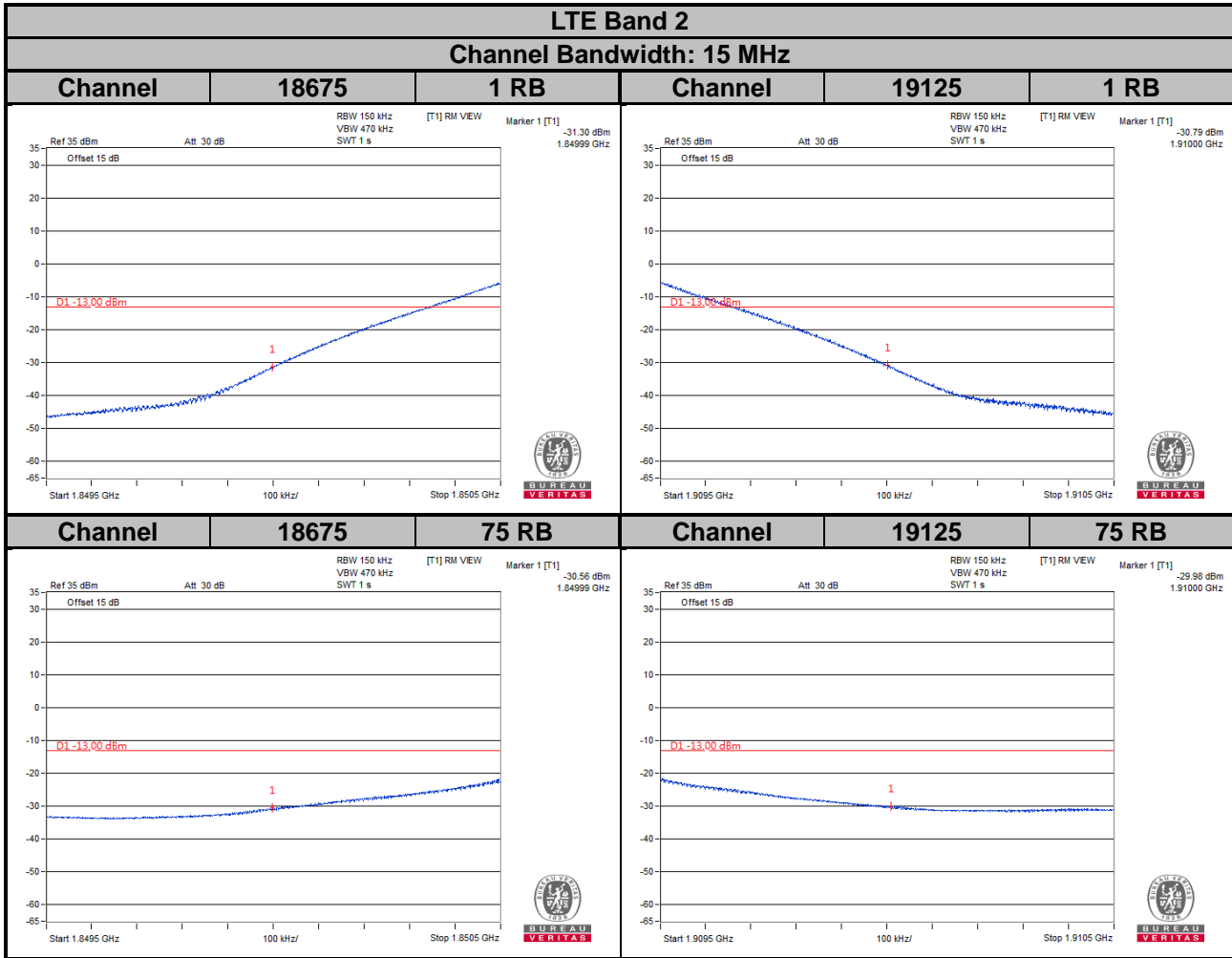

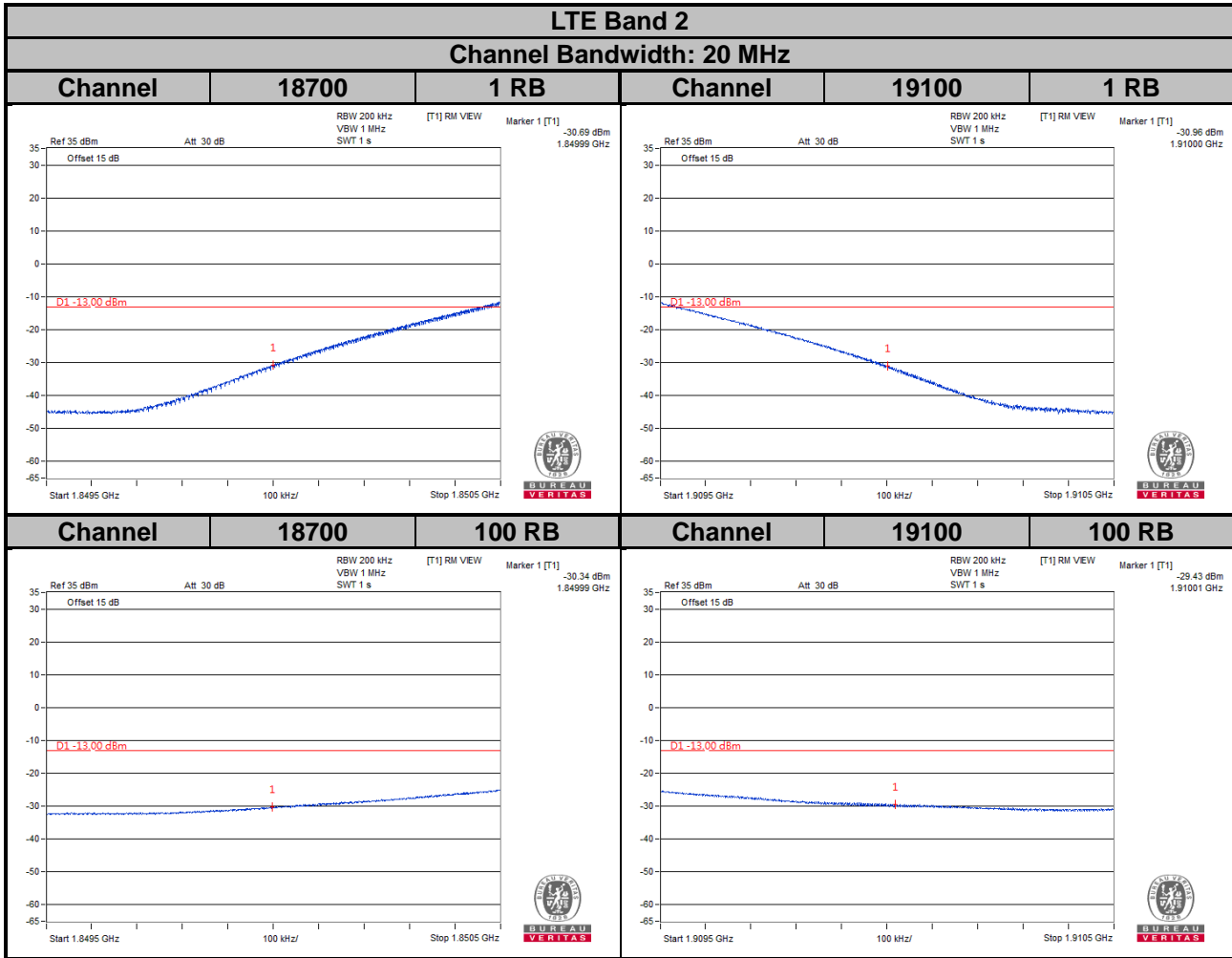

4.6 Peak to Average Ratio

4.6.1 Limits of Peak to Average Ratio Measurement

In measuring transmissions in this band using an average power technique, the peak to-average ratio (PAR) of the transmission may not exceed 13 dB.

4.6.2 Test Setup

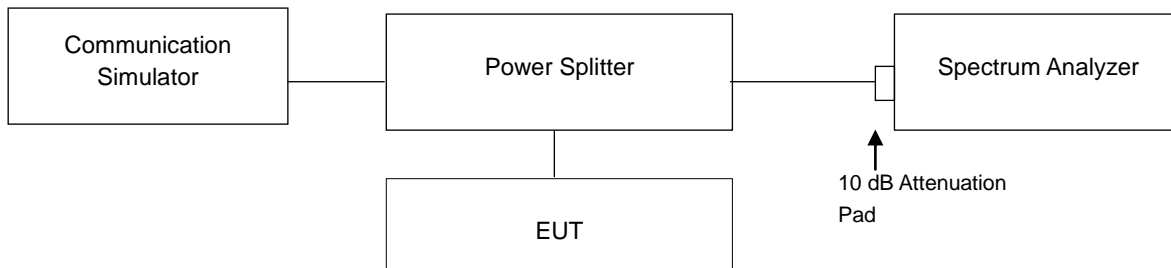

4.6.3 Test Procedures

1. Set resolution/measurement bandwidth \geq signal's occupied bandwidth;
2. Set the number of counts to a value that stabilizes the measured CCDF curve;
3. Record the maximum PAPR level associated with a probability of 0.1 %.

4.6.4 Test Results

Channel	Frequency (MHz)	Peak to Average Ratio (dB)		Channel	Frequency (MHz)	Peak to Average Ratio (dB)
		GSM	EDGE			
512	1850.2	0.35	3.27	9262	1852.4	3.03
661	1880.0	0.35	3.27	9400	1880.0	3.17
810	1909.8	0.34	3.32	9538	1907.6	3.16



LTE Band 2

Channel Bandwidth: 1.4 MHz					Channel Bandwidth: 3 MHz				
Channel	Frequency (MHz)	Peak to Average Ratio (dB)			Channel	Frequency (MHz)	Peak to Average Ratio (dB)		
		QPSK	16QAM	64QAM			QPSK	16QAM	64QAM
18607	1850.7	4.08	5.59	5.54	18615	1851.5	3.90	5.38	5.45
18900	1880.0	3.99	5.35	5.52	18900	1880.0	3.80	5.24	5.32
19193	1909.3	3.97	5.37	5.38	19185	1908.5	3.87	5.37	5.29

Spectrum Plot of Worst Value

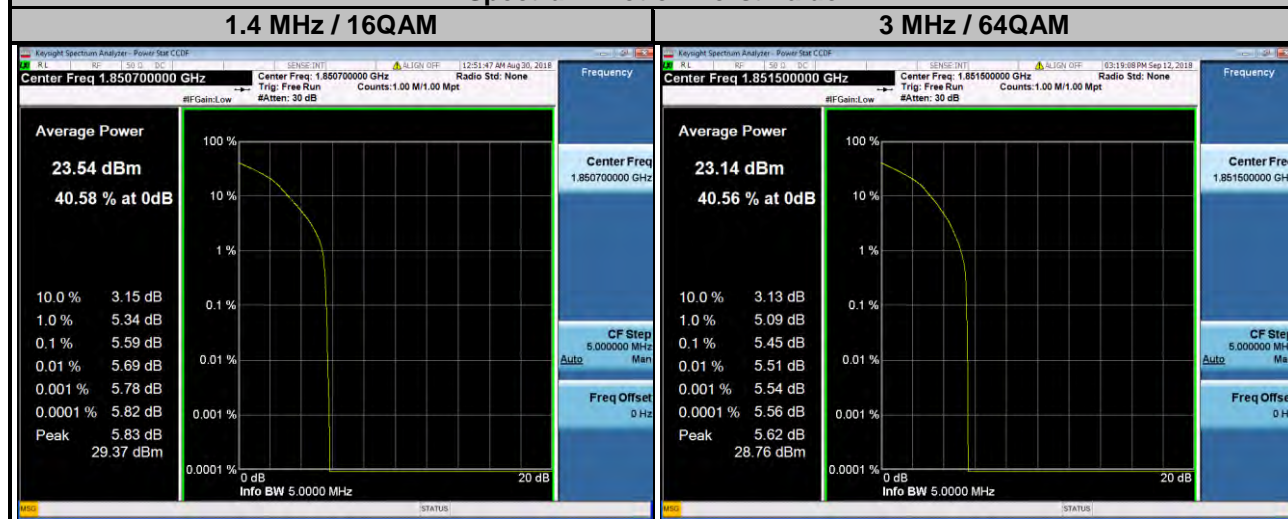

LTE Band 2									
Channel Bandwidth: 5 MHz					Channel Bandwidth: 10 MHz				
Channel	Frequency (MHz)	Peak to Average Ratio (dB)			Channel	Frequency (MHz)	Peak to Average Ratio (dB)		
		QPSK	16QAM	64QAM			QPSK	16QAM	64QAM
18625	1852.5	3.91	5.41	5.43	18650	1855.0	3.84	5.39	5.28
18900	1880.0	3.77	5.20	5.28	18900	1880.0	3.60	5.04	5.03
19175	1907.5	3.87	5.37	5.23	19150	1905.0	3.78	5.28	5.14

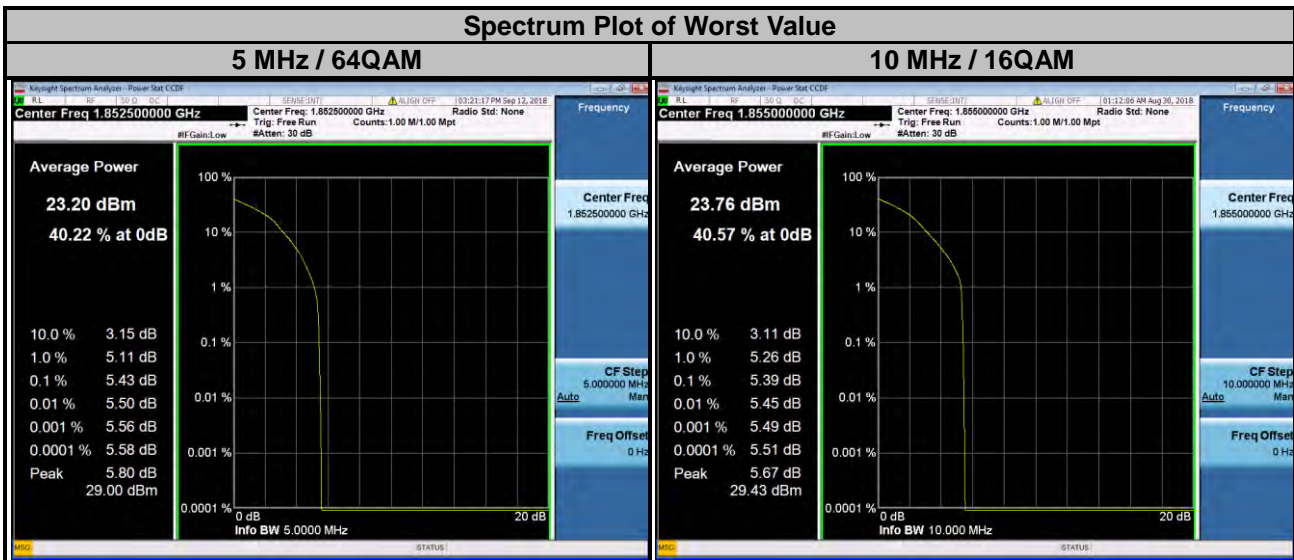

LTE Band 2									
Channel Bandwidth: 15 MHz					Channel Bandwidth: 20 MHz				
Channel	Frequency (MHz)	Peak to Average Ratio (dB)			Channel	Frequency (MHz)	Peak to Average Ratio (dB)		
		QPSK	16QAM	64QAM			QPSK	16QAM	64QAM
18675	1857.5	3.83	5.38	5.25	18700	1860.0	3.82	5.44	5.26
18900	1880.0	3.52	4.97	4.96	18900	1880.0	3.47	4.90	4.76
19125	1902.5	3.86	5.35	5.20	19100	1900.0	3.90	5.57	5.40

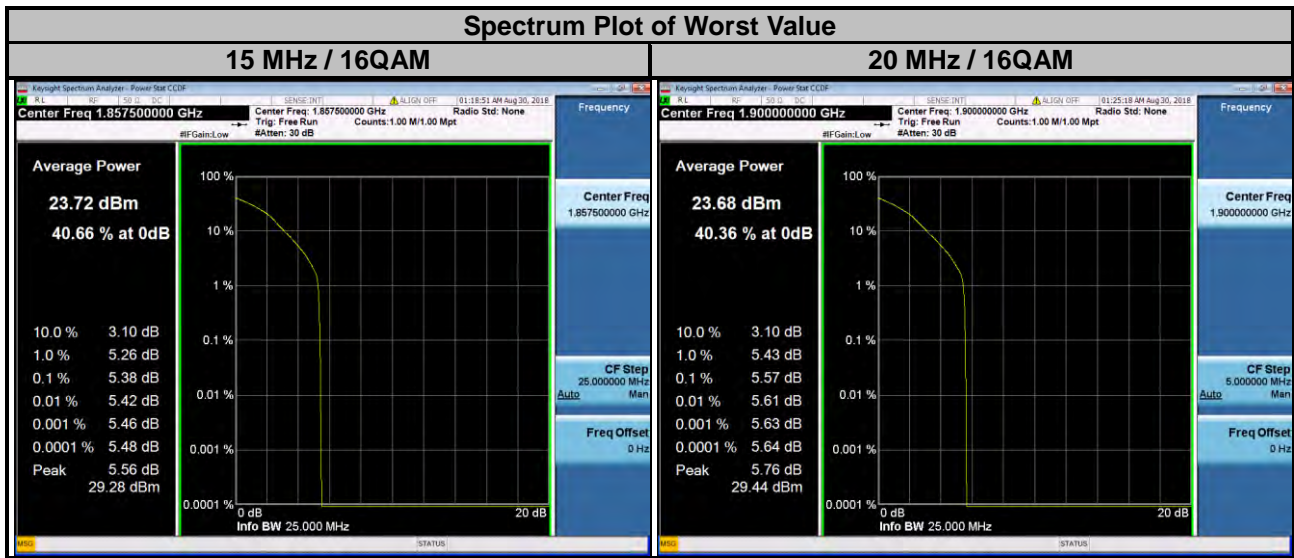

4.7 Conducted Spurious Emissions

4.7.1 Limits of Conducted Spurious Emissions Measurement

The power of any emission outside of the authorized operating frequency ranges must be attenuated below the transmitting power (P) by a factor of at least $43 + 10 \log(P)$ dB. The emission limit equal to -13 dBm.

4.7.2 Test Setup

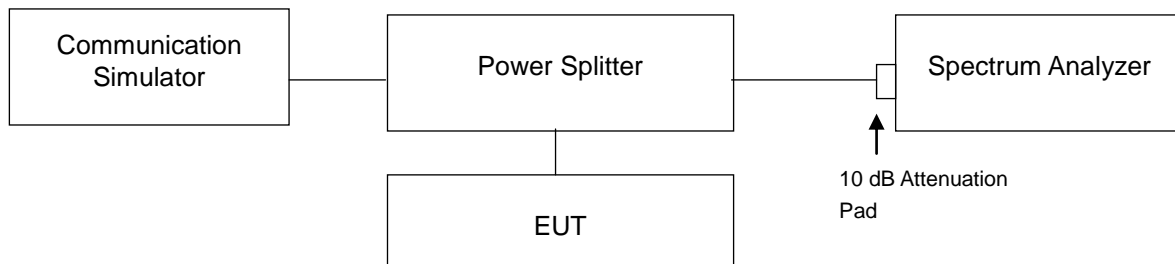

4.7.3 Test Procedure

- The EUT makes a phone call to the communication simulator. All measurements were done at low, middle and high operational frequency range.
- Measuring frequency range from 9 kHz to 1 GHz, 10 dB attenuation pad is connected with spectrum. RBW = 100 kHz and VBW = 300 kHz is used for conducted emission measurement.
- Measuring frequency range is from 10 GHz to 26.5 GHz / 27 GHz, 10 dB attenuation pad is connected with spectrum. RBW = 1 MHz and VBW = 3 MHz is used for conducted emission measurement.

4.7.4 Test Results

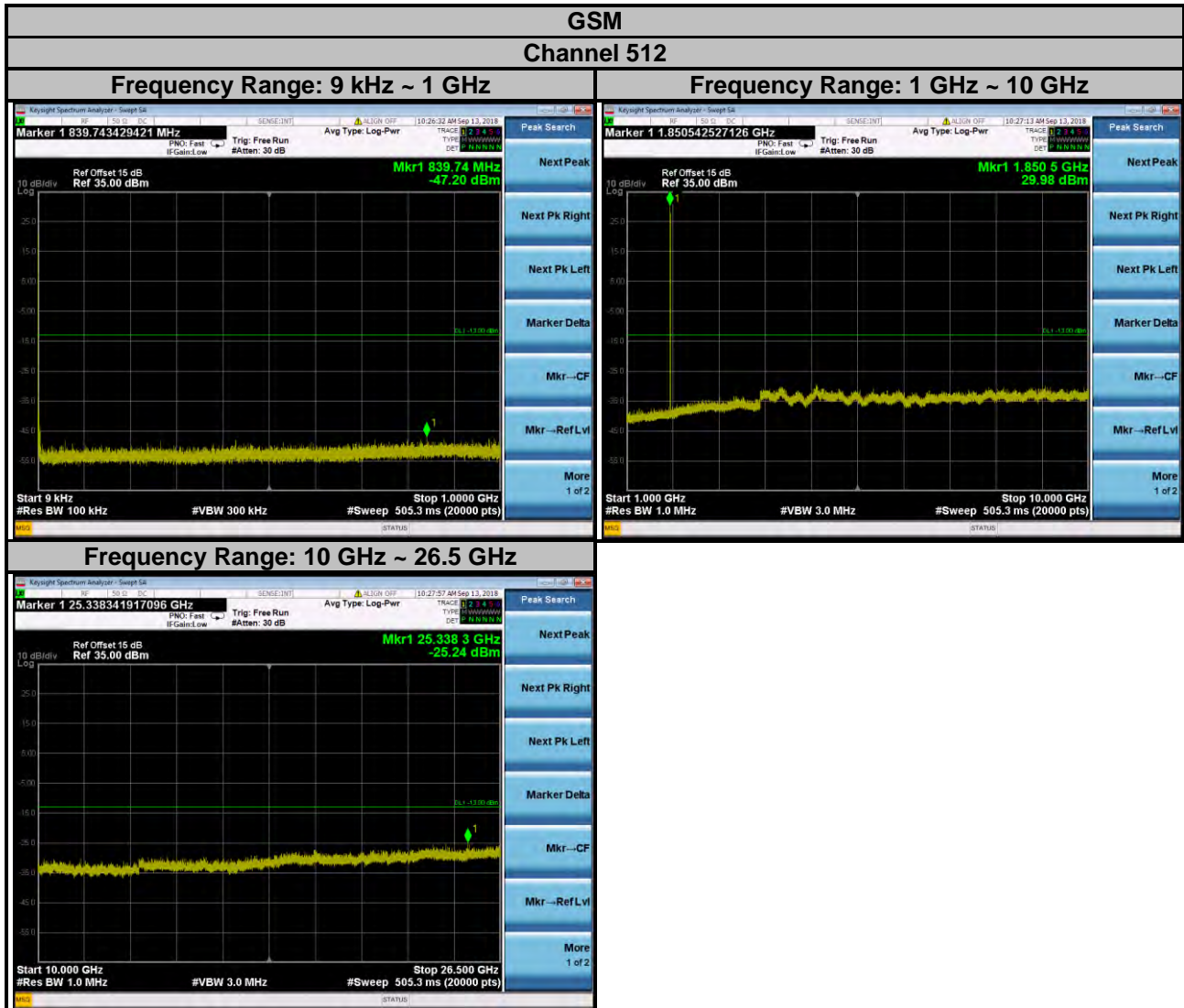

GSM

Channel 661

Frequency Range: 9 kHz ~ 1 GHz

Frequency Range: 1 GHz ~ 10 GHz

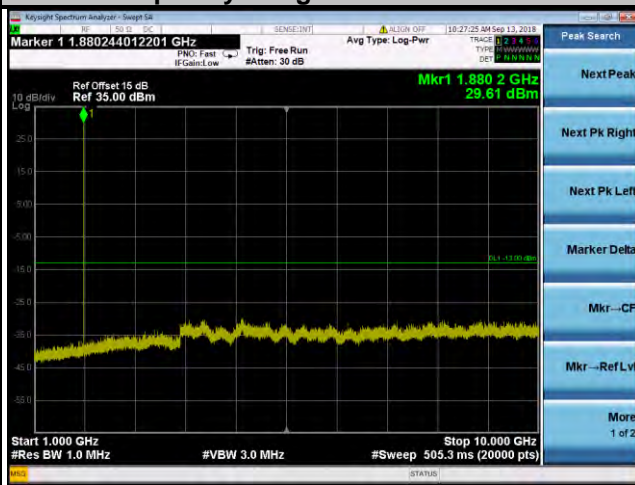
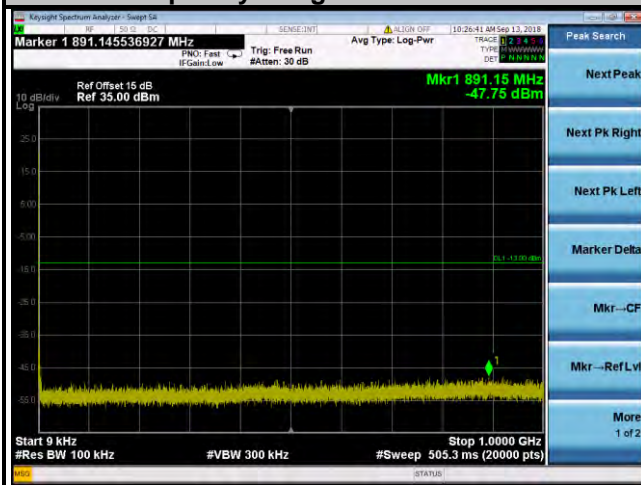

Frequency Range: 10 GHz ~ 26.5 GHz

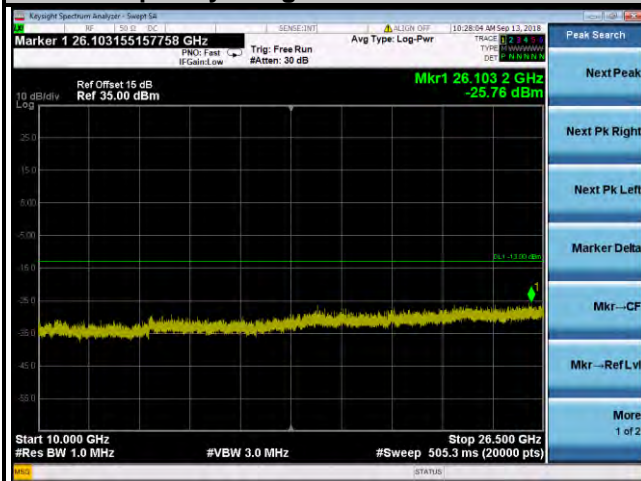

GSM

Channel 810

Frequency Range: 9 kHz ~ 1 GHz

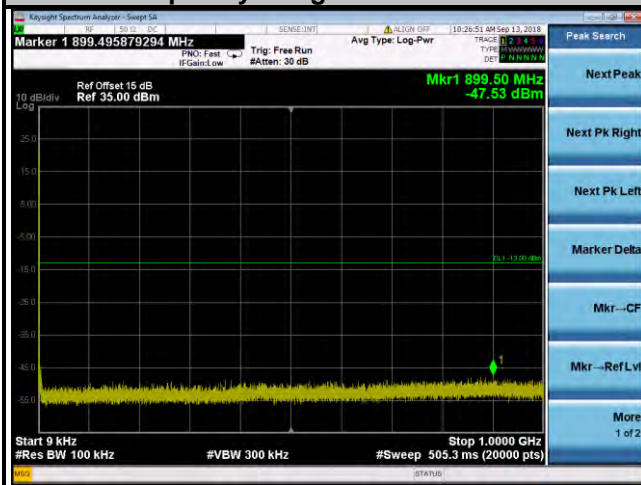

Frequency Range: 1 GHz ~ 10 GHz

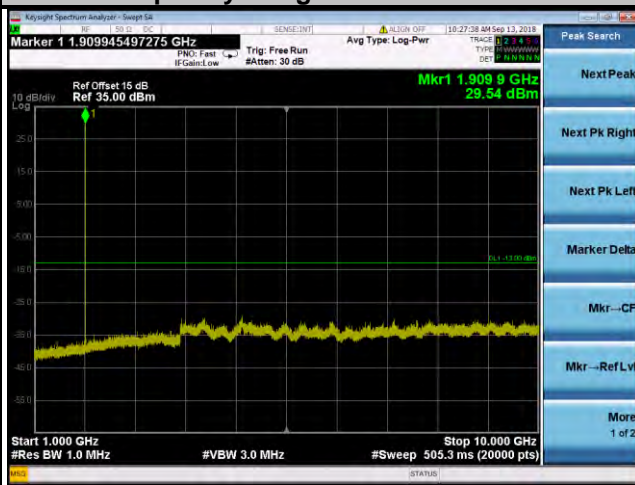

Frequency Range: 10 GHz ~ 26.5 GHz

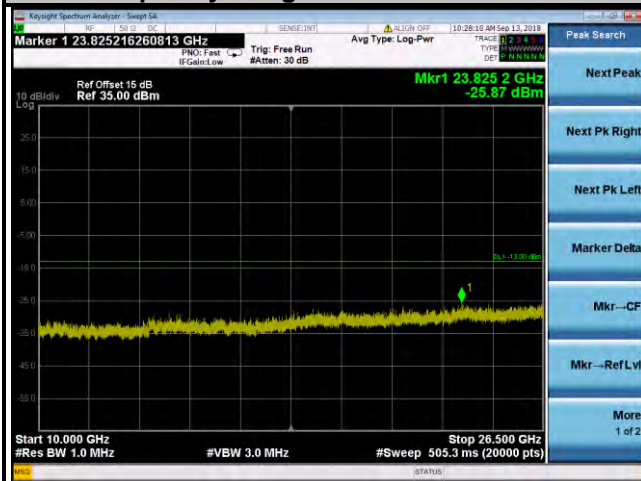

EDGE

Channel 512

Frequency Range: 9 kHz ~ 1 GHz

Frequency Range: 1 GHz ~ 10 GHz

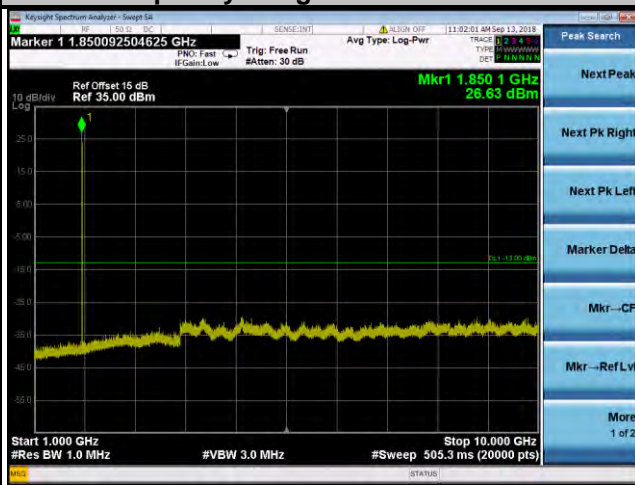
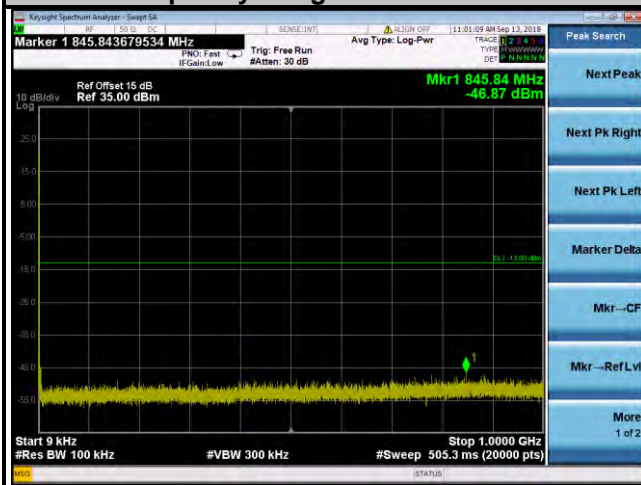

Frequency Range: 10 GHz ~ 26.5 GHz

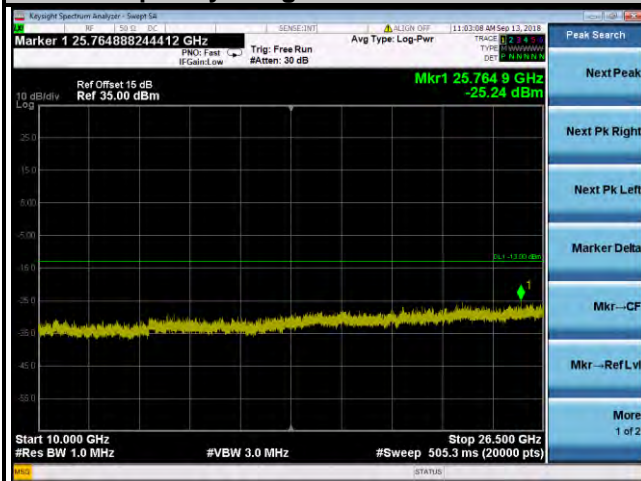

EDGE

Channel 661

Frequency Range: 9 kHz ~ 1 GHz

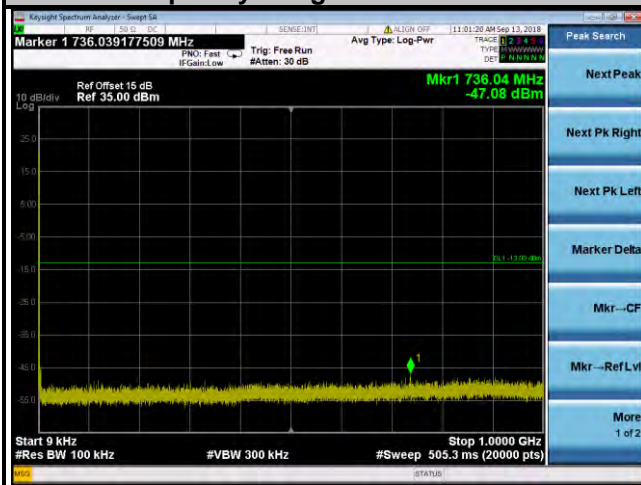

Frequency Range: 1 GHz ~ 10 GHz

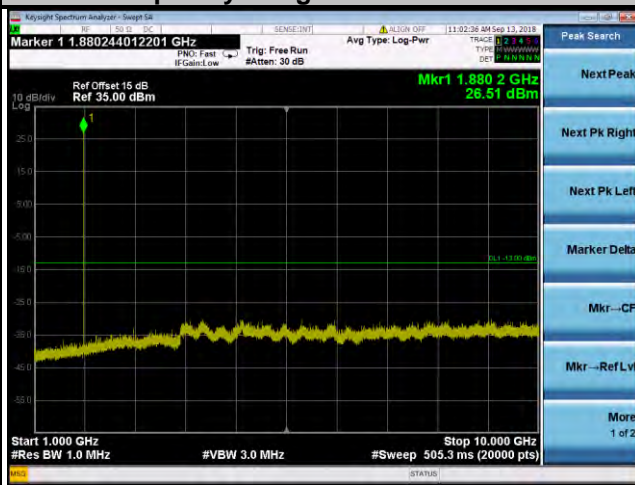

Frequency Range: 10 GHz ~ 26.5 GHz

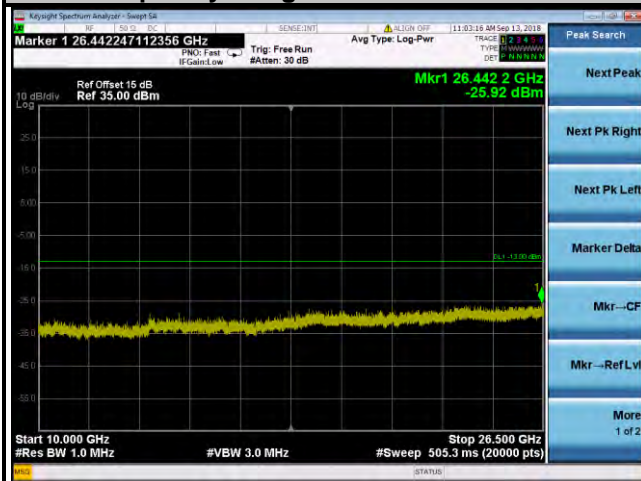

EDGE

Channel 810

Frequency Range: 9 kHz ~ 1 GHz

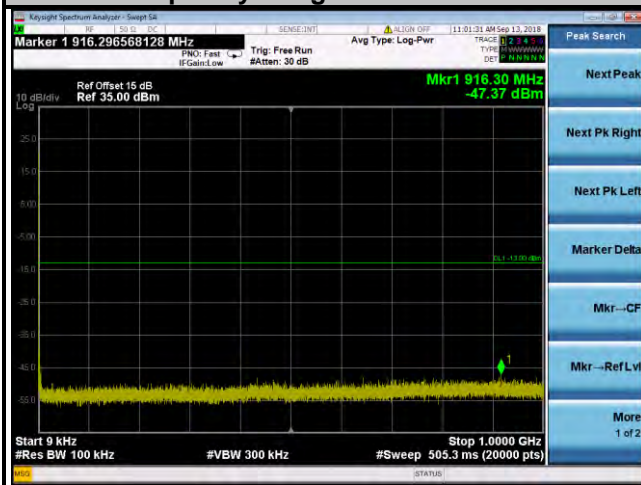

Frequency Range: 1 GHz ~ 10 GHz

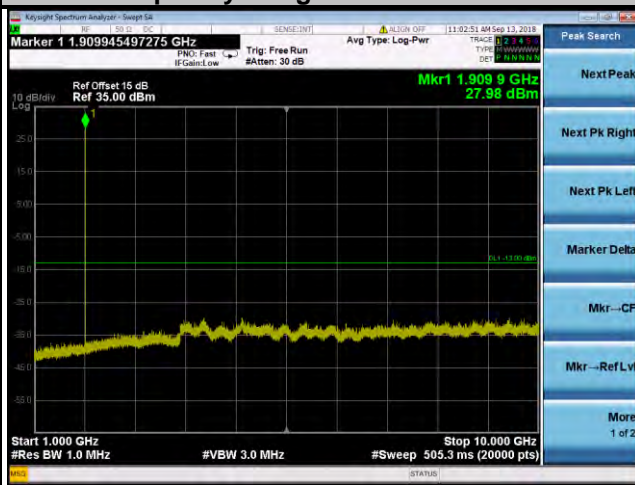

Frequency Range: 10 GHz ~ 26.5 GHz

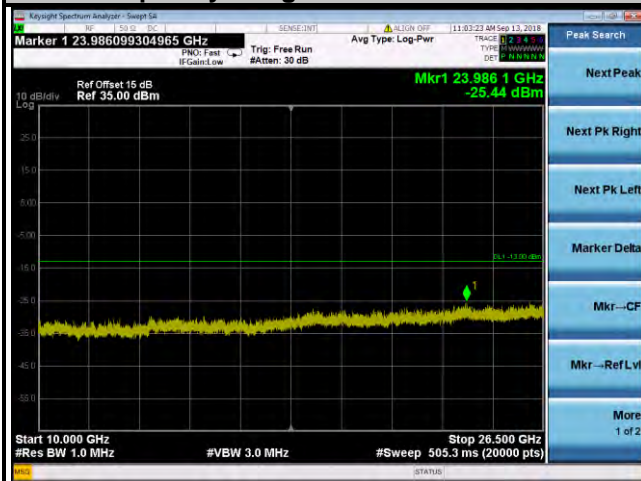

WCDMA Channel 9262

Frequency Range: 9 kHz ~ 1 GHz

Frequency Range: 1 GHz ~ 10 GHz

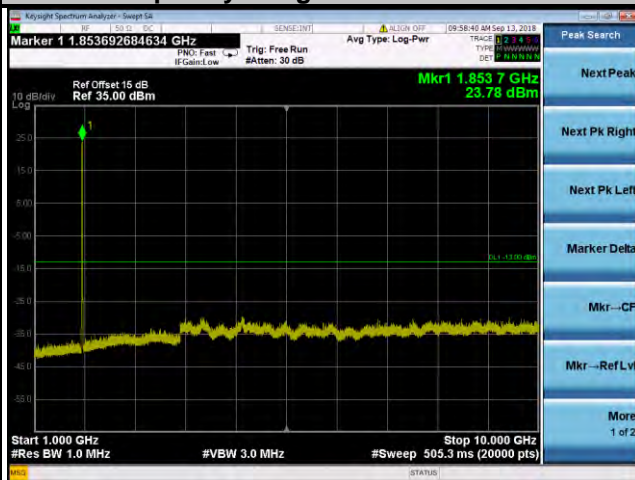
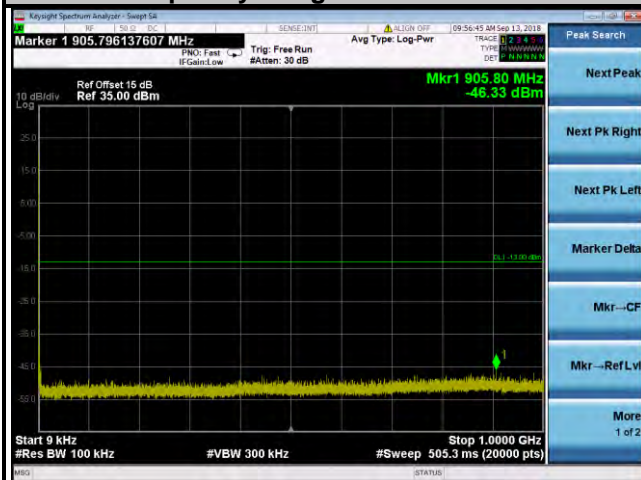

Frequency Range: 10 GHz ~ 26.5 GHz

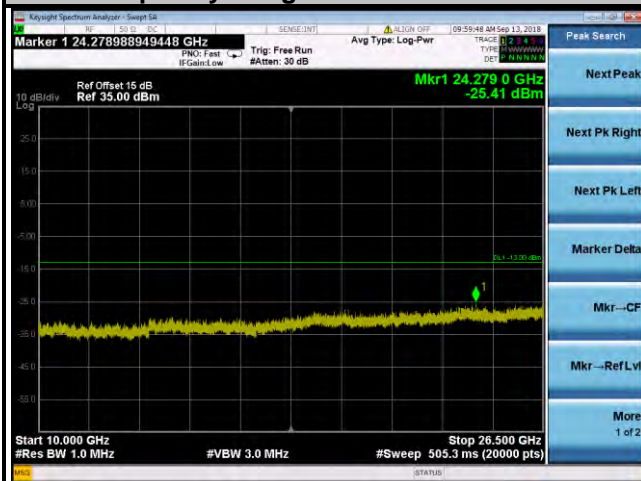

WCDMA
Channel 9400

Frequency Range: 9 kHz ~ 1 GHz

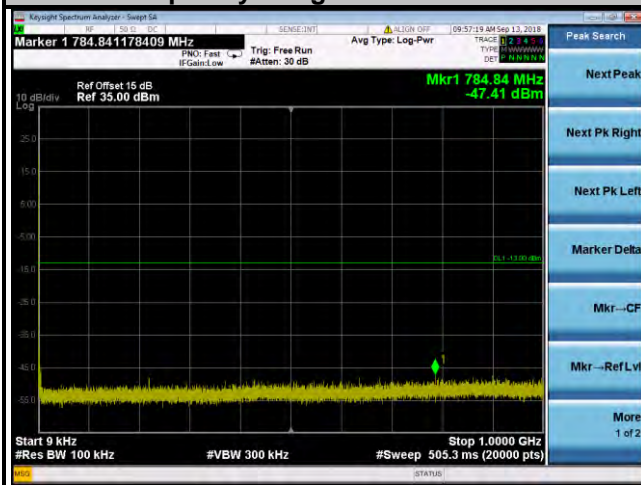

Frequency Range: 1 GHz ~ 10 GHz

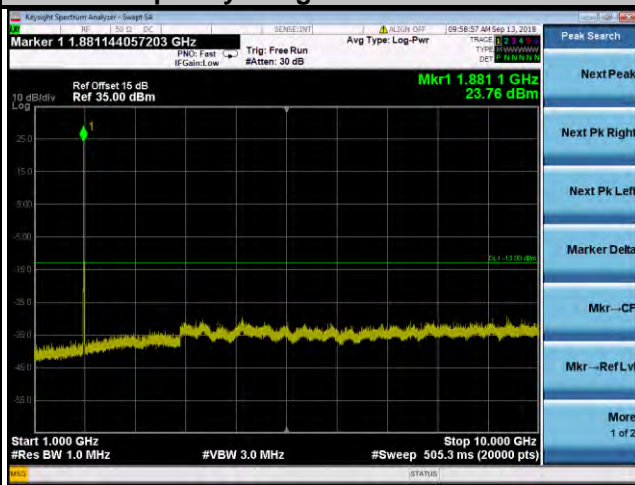

Frequency Range: 10 GHz ~ 26.5 GHz

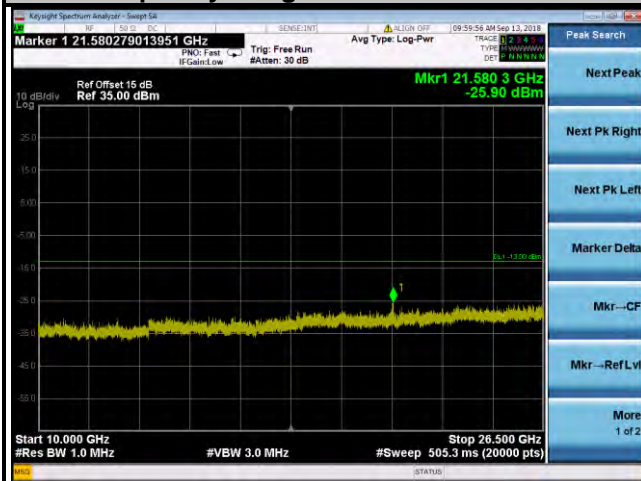

WCDMA
Channel 9538

Frequency Range: 9 kHz ~ 1 GHz

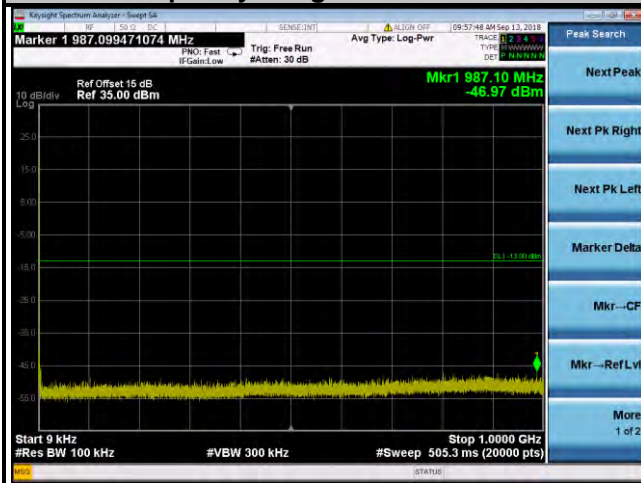

Frequency Range: 1 GHz ~ 10 GHz

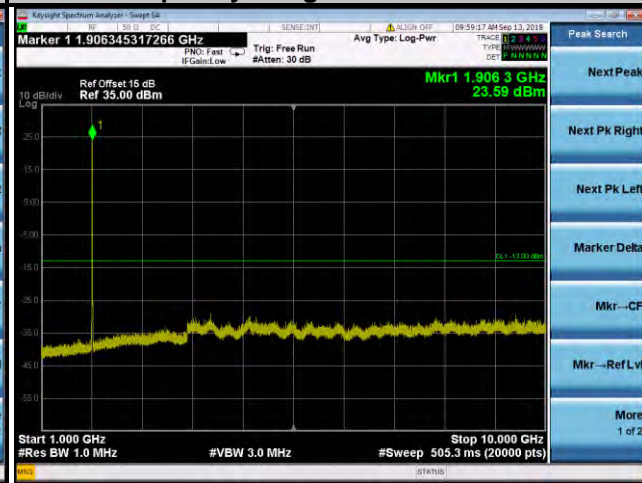

Frequency Range: 10 GHz ~ 26.5 GHz

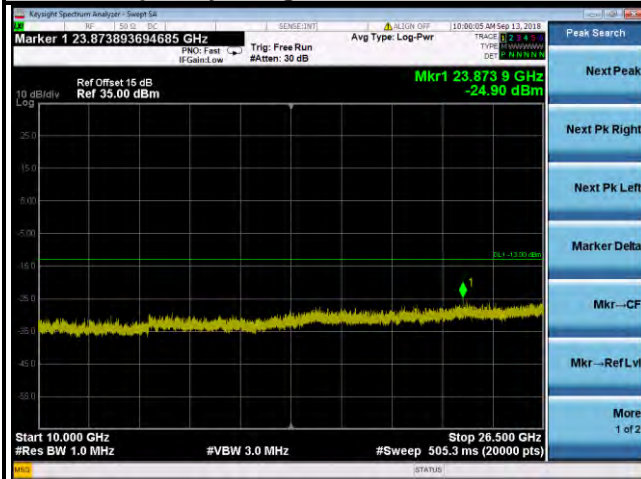

LTE Band 2
Channel Bandwidth: 1.4 MHz
Channel 18607

Frequency Range: 9 kHz ~ 1 GHz

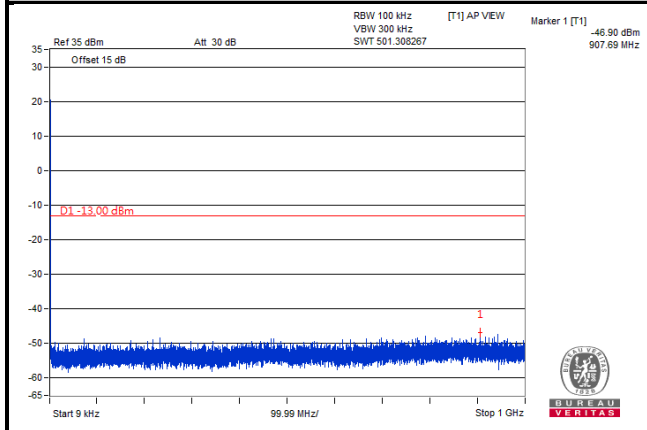

Frequency Range: 1 GHz ~ 10 GHz

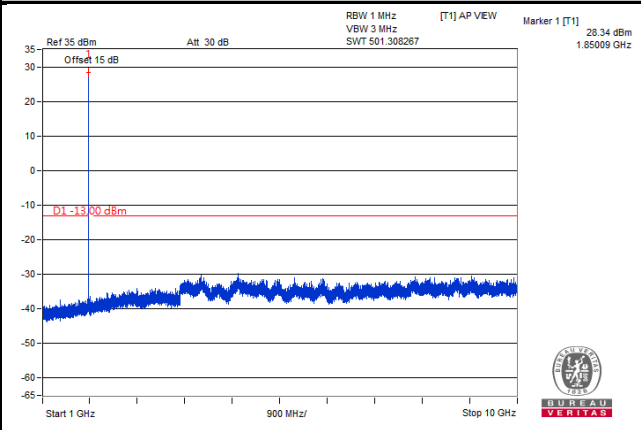

Frequency Range: 10 GHz ~ 27 GHz

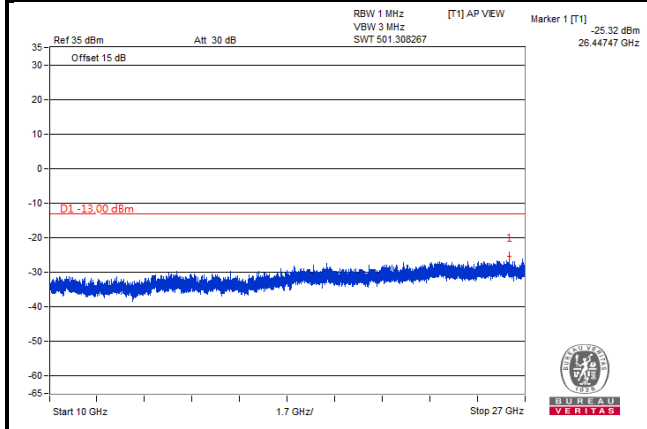

LTE Band 2
Channel Bandwidth: 1.4 MHz
Channel 18900

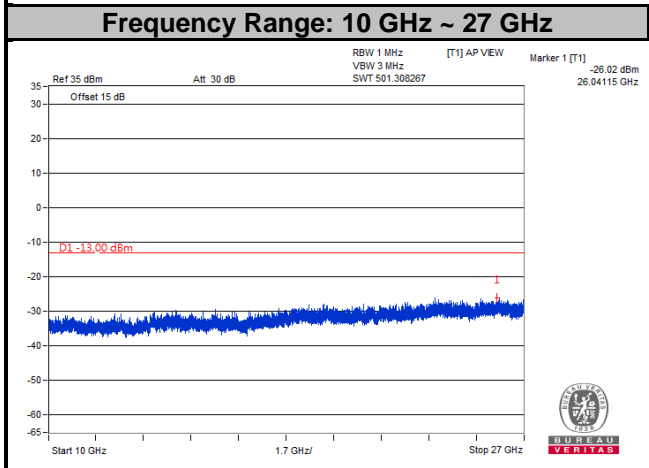
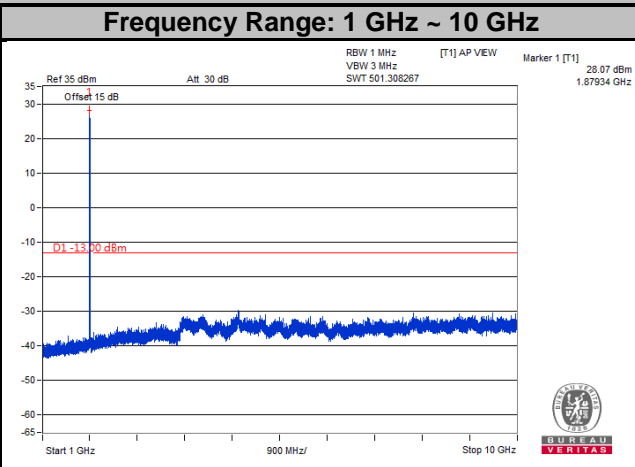
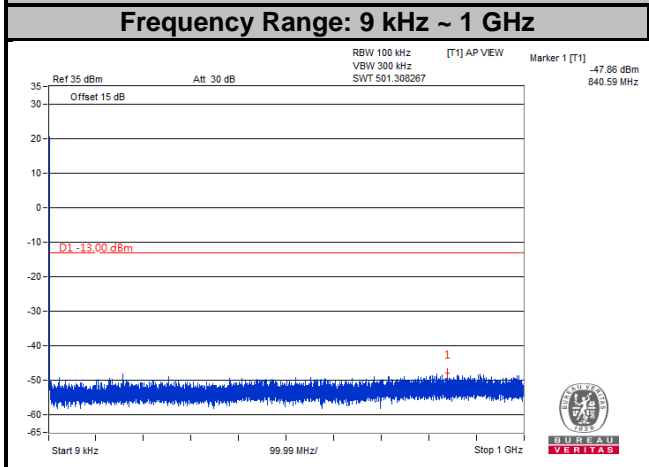

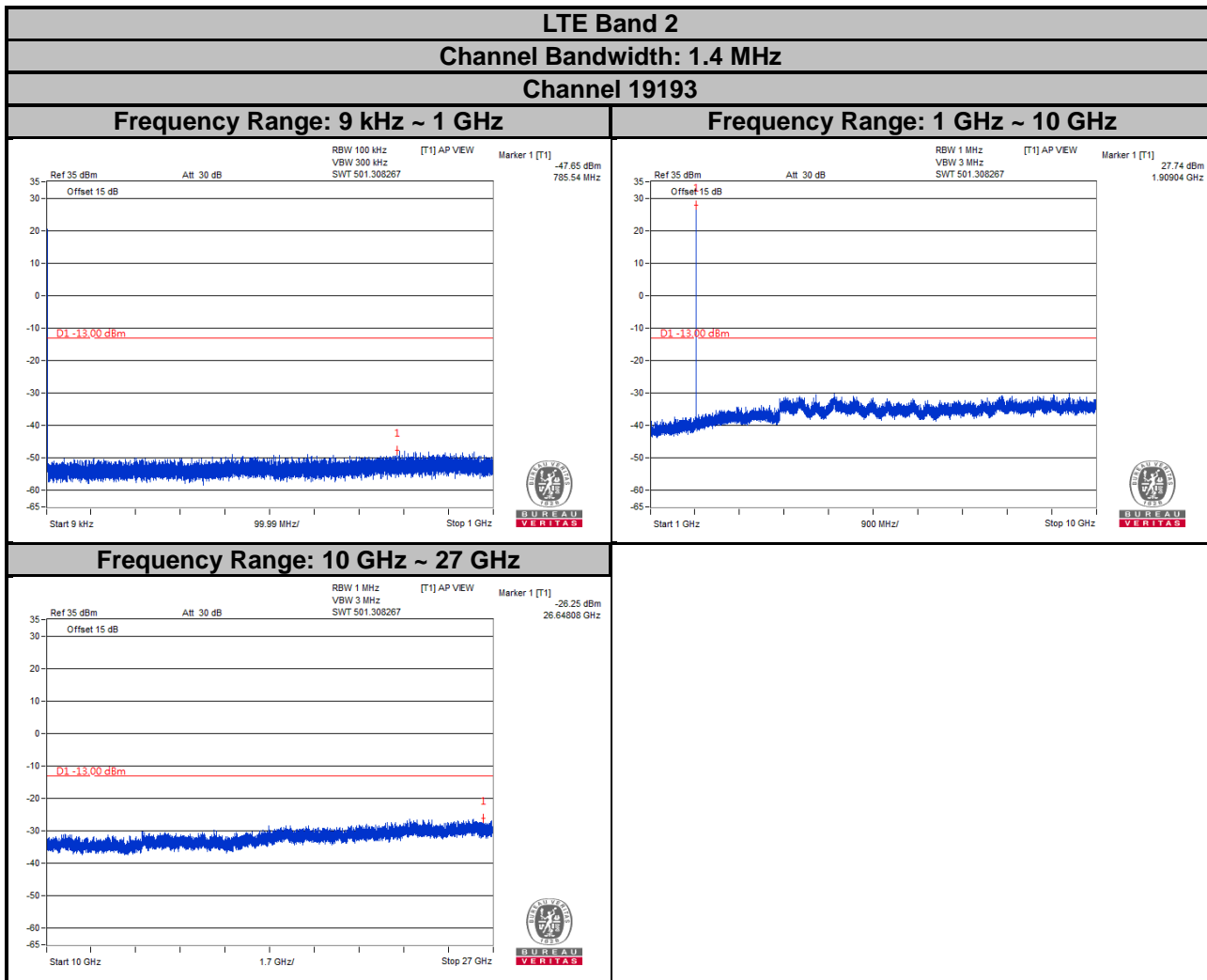

LTE Band 2
Channel Bandwidth: 3 MHz
Channel 18615

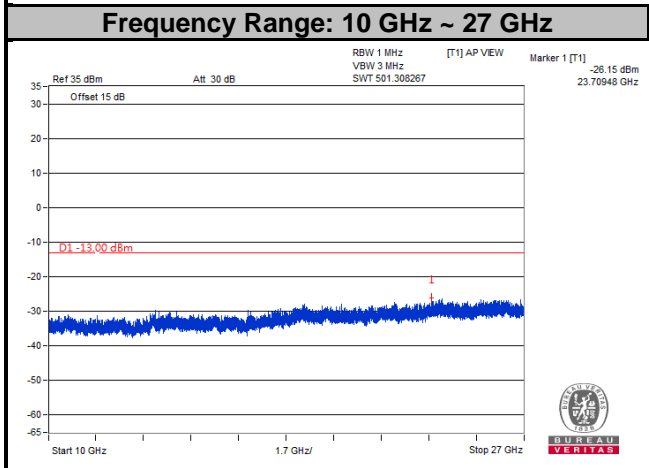
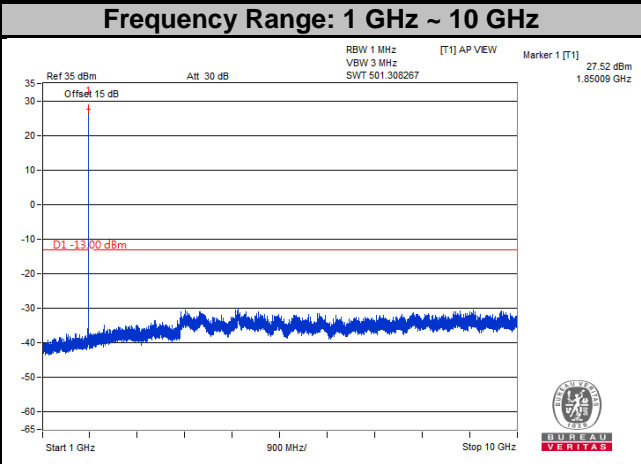
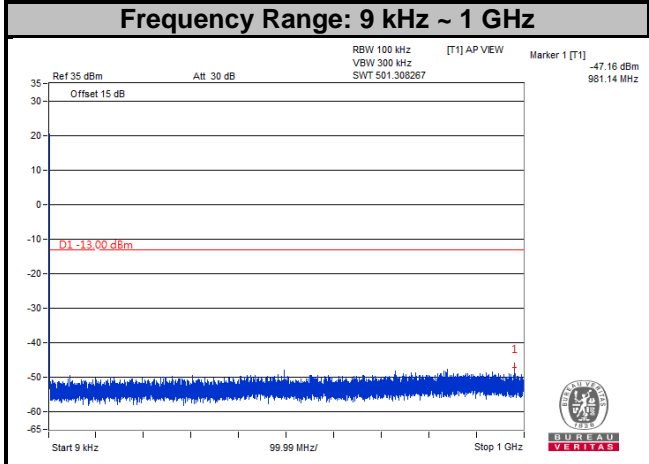

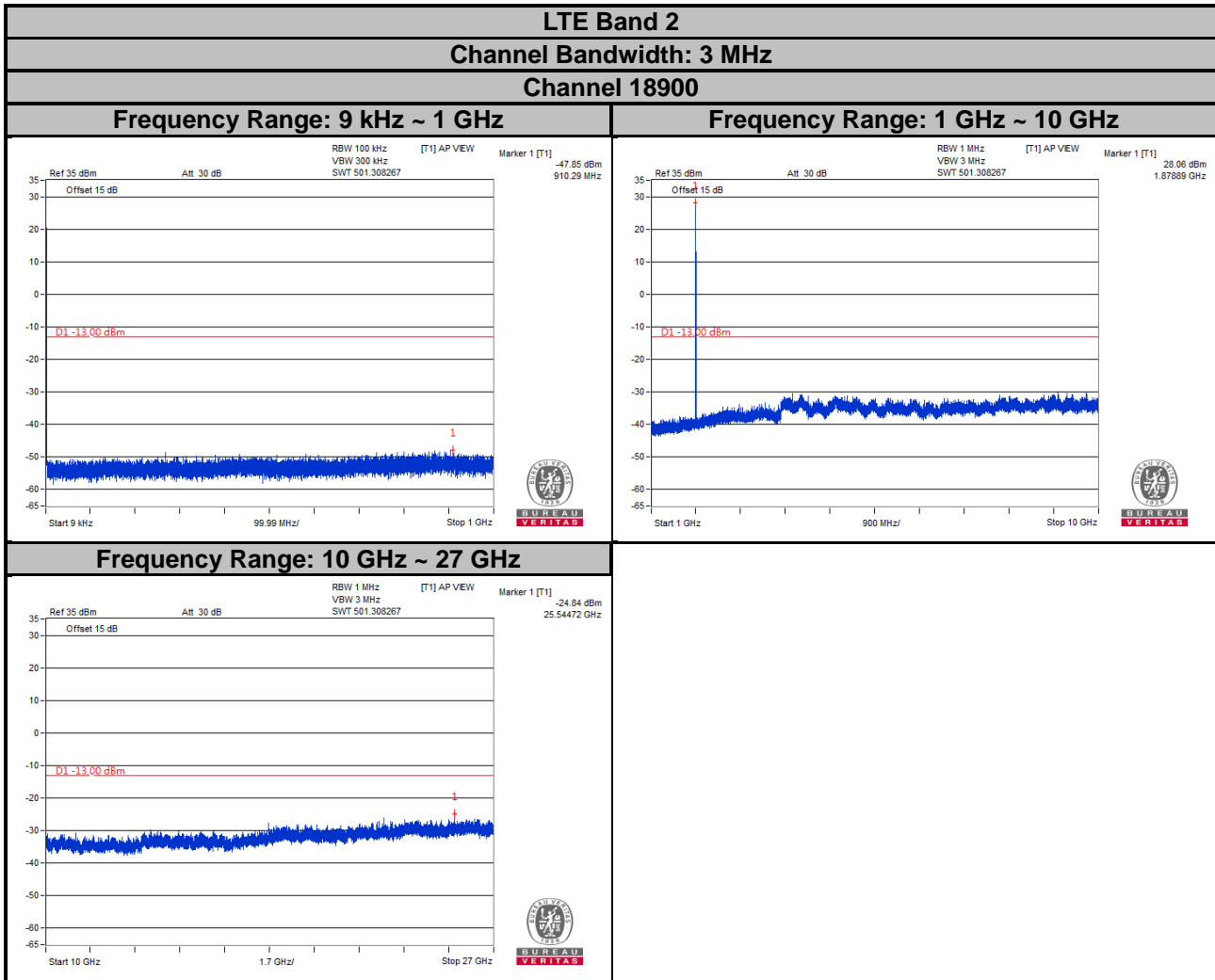

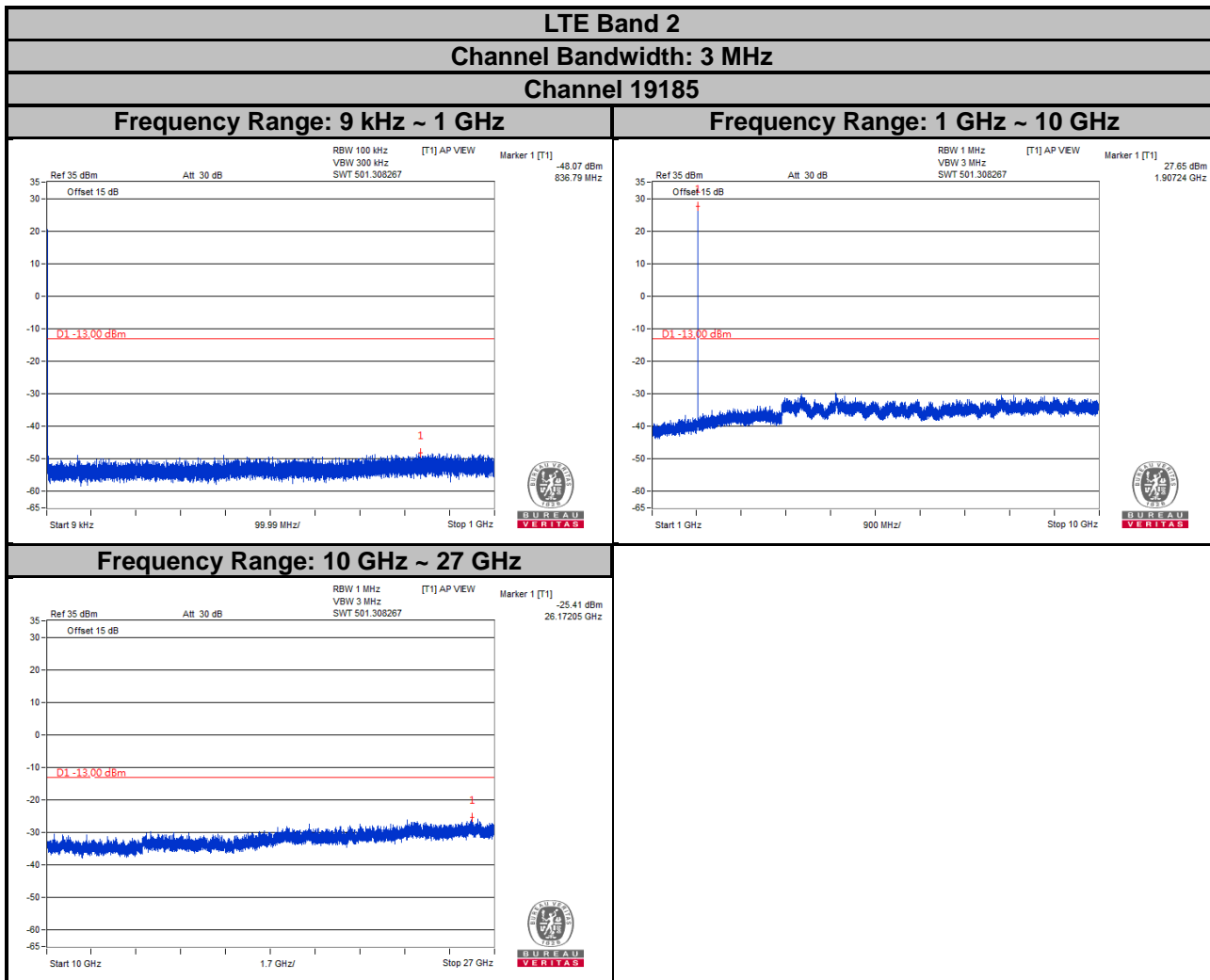

LTE Band 2
Channel Bandwidth: 5 MHz
Channel 18625

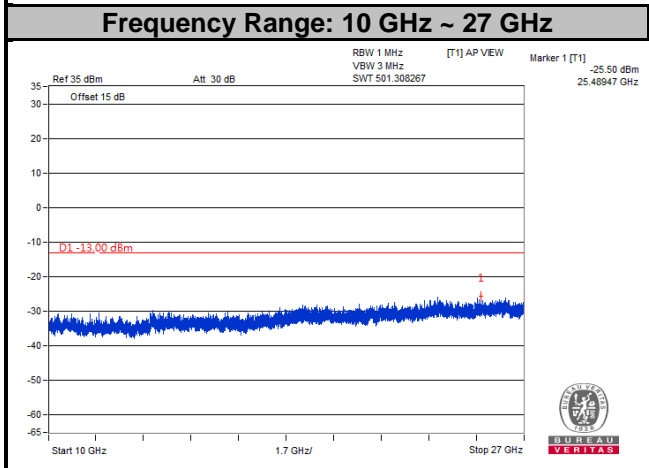
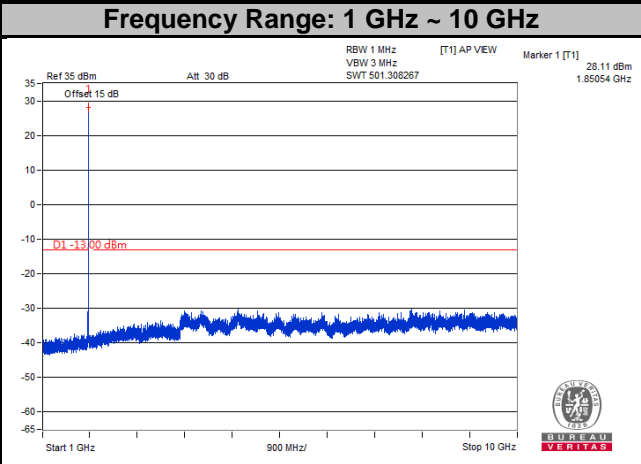
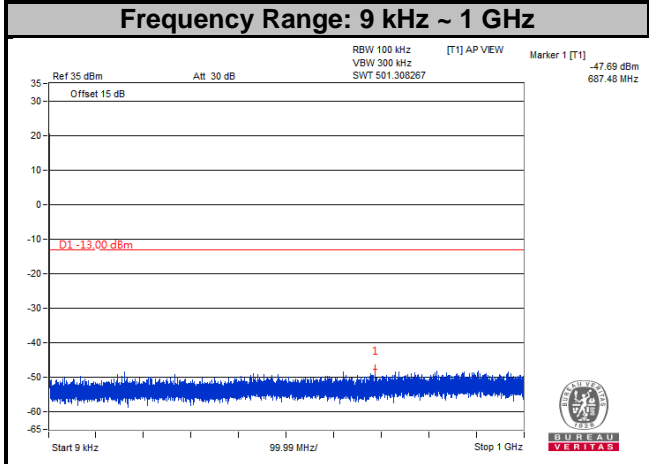

LTE Band 2
Channel Bandwidth: 5 MHz
Channel 18900

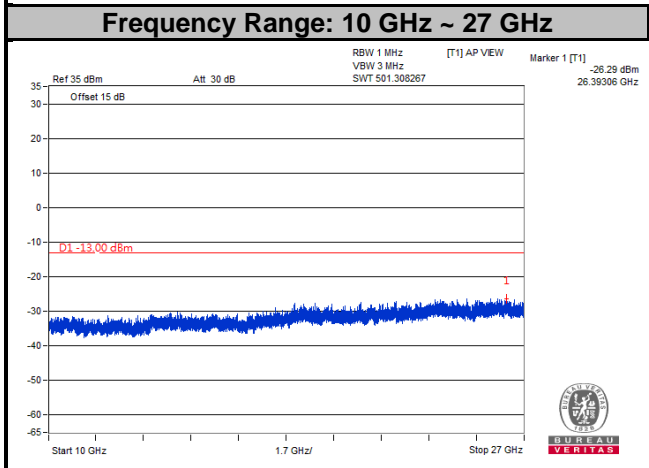
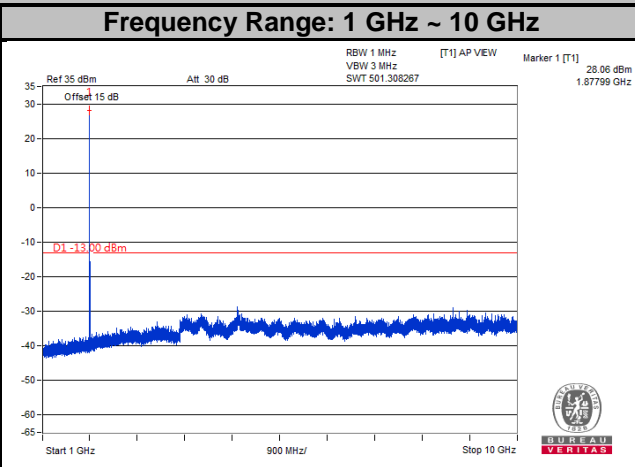
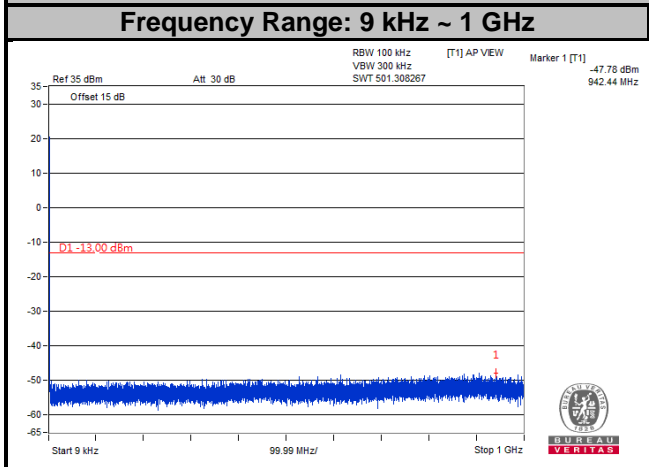

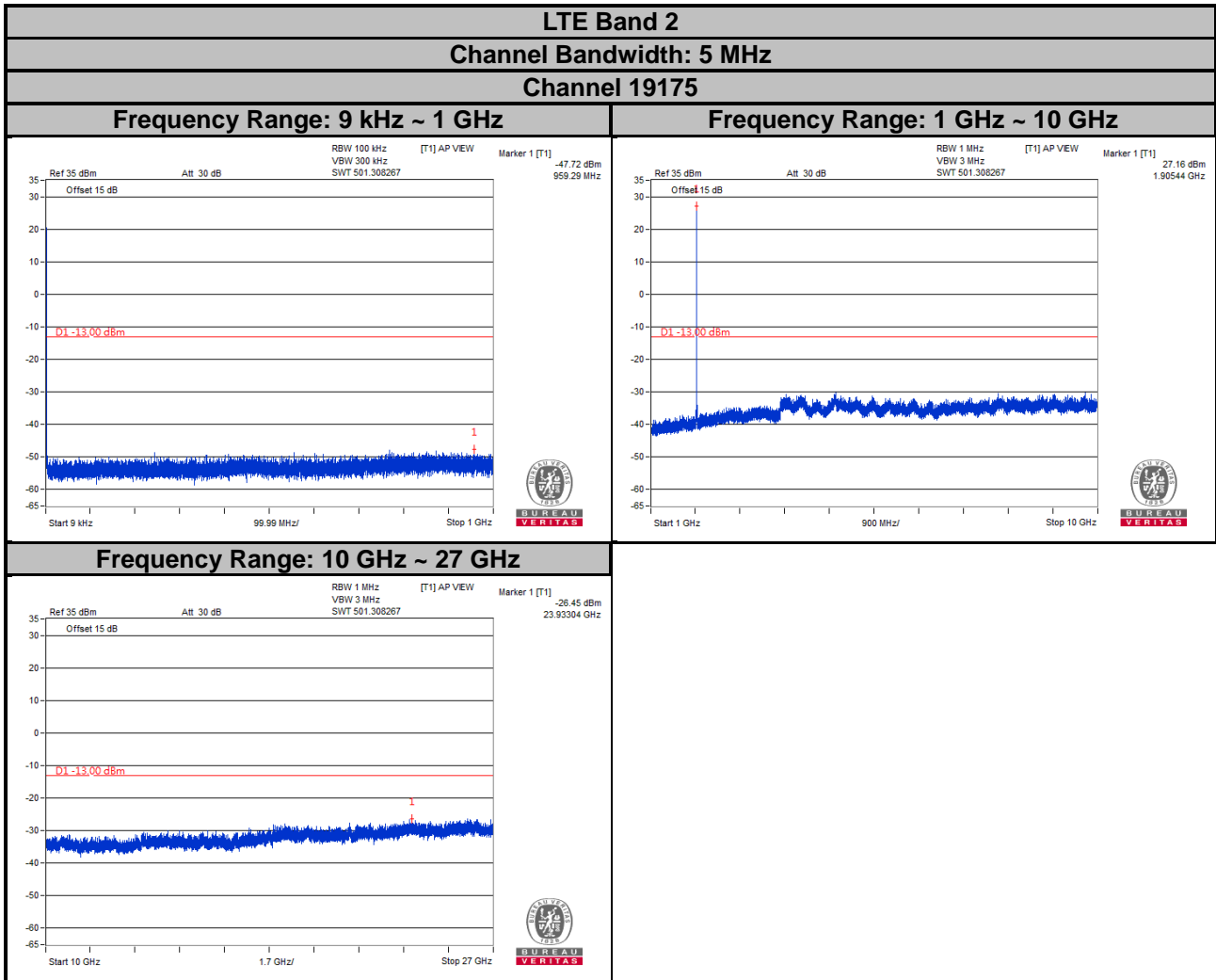

LTE Band 2
Channel Bandwidth: 10 MHz

Channel 18650

Frequency Range: 9 kHz ~ 1 GHz

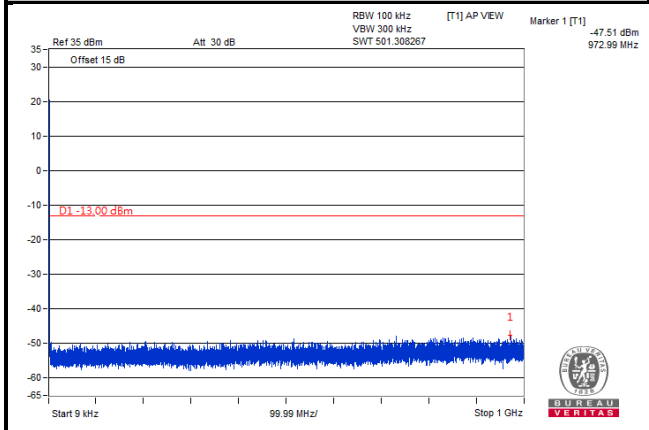

Frequency Range: 1 GHz ~ 10 GHz

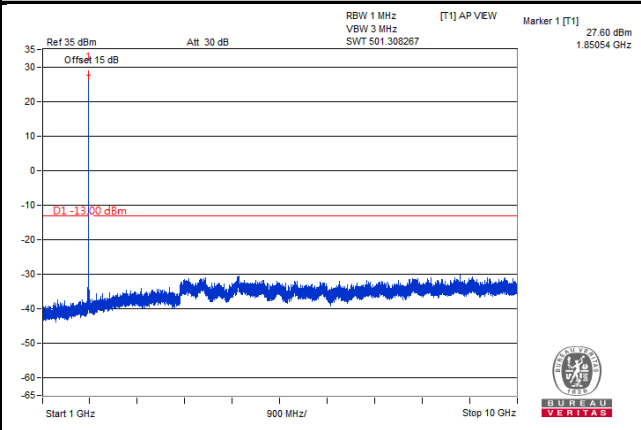

Frequency Range: 10 GHz ~ 27 GHz

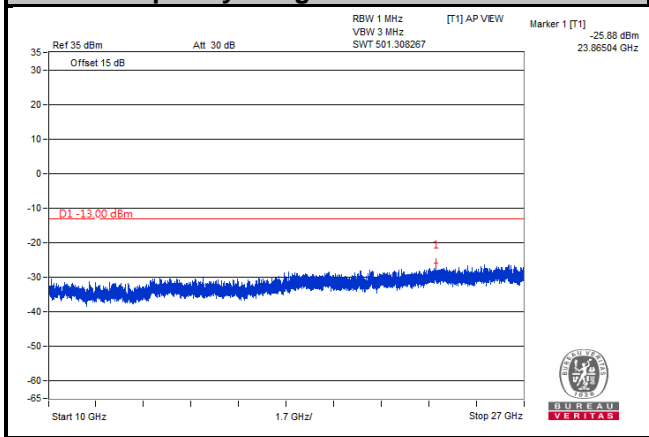

LTE Band 2
Channel Bandwidth: 10 MHz
Channel 18900

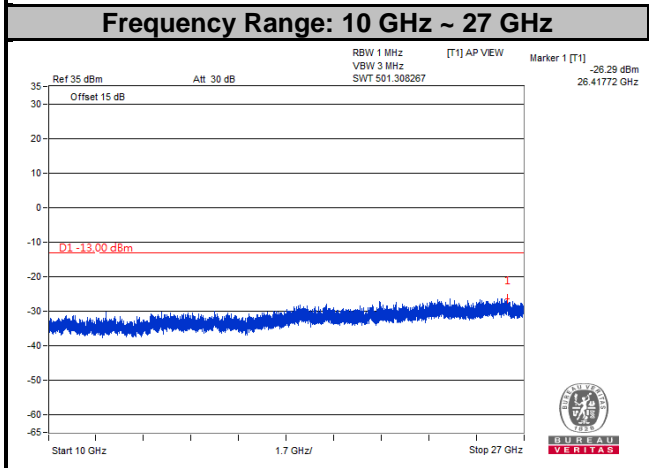
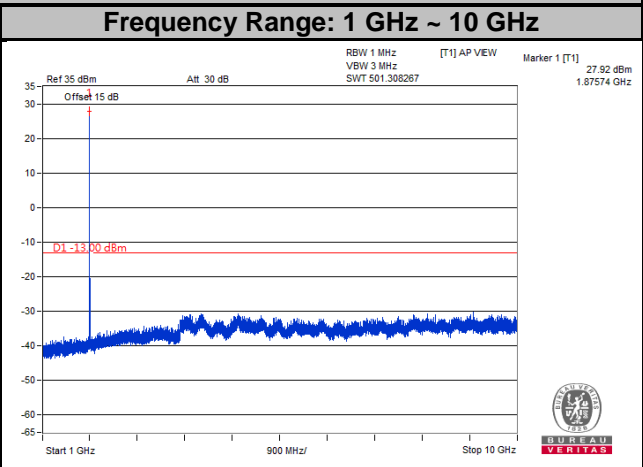
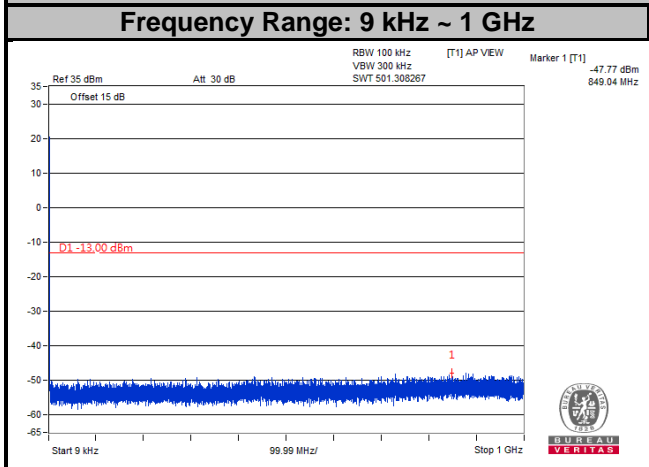

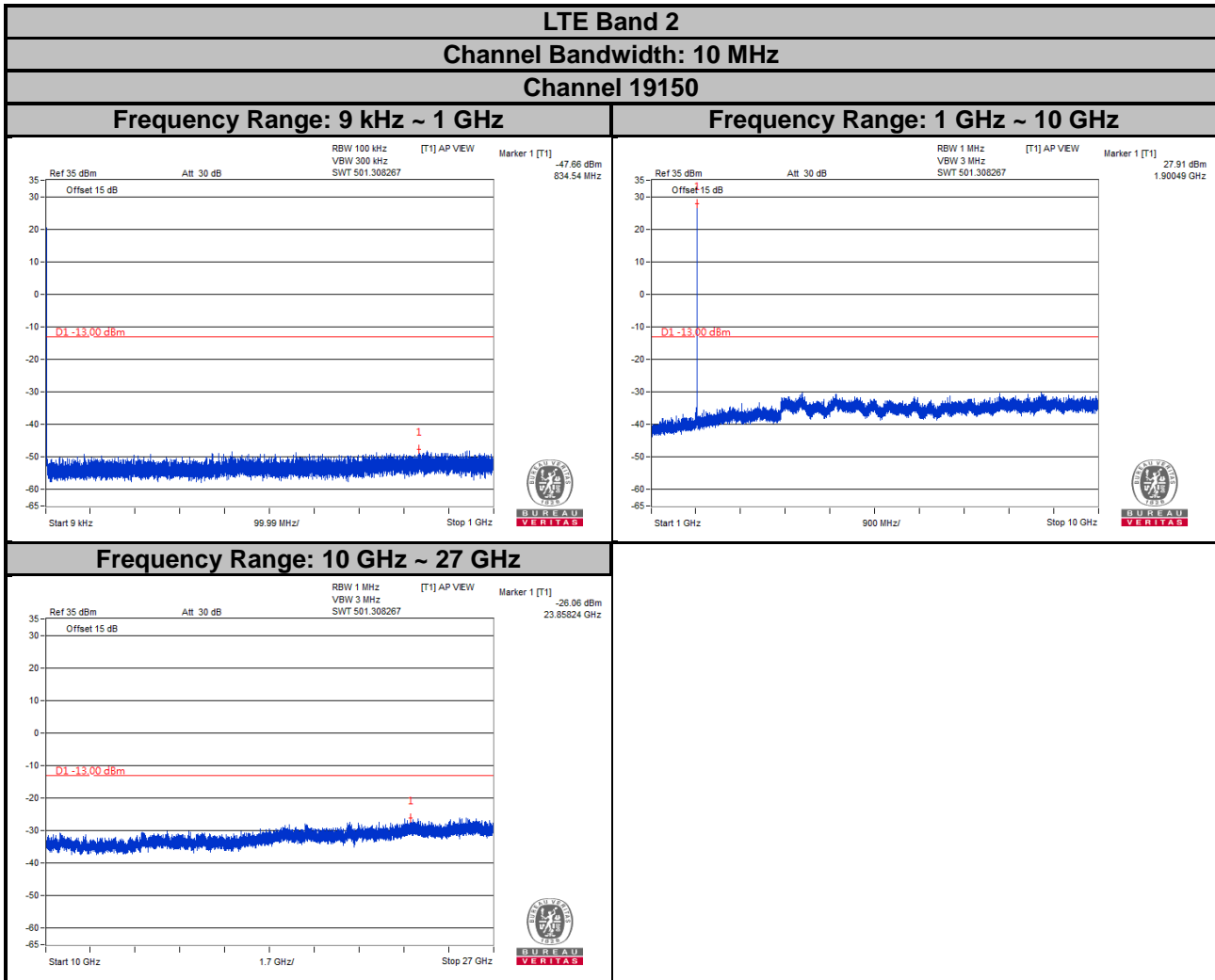

LTE Band 2

Channel Bandwidth: 15 MHz

Channel 18675

Frequency Range: 9 kHz ~ 1 GHz

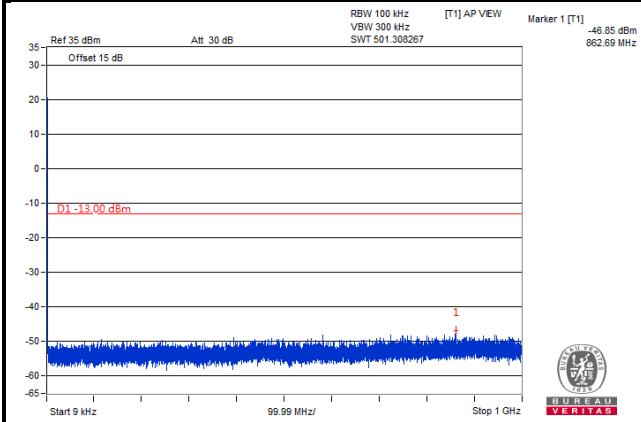

Frequency Range: 1 GHz ~ 10 GHz

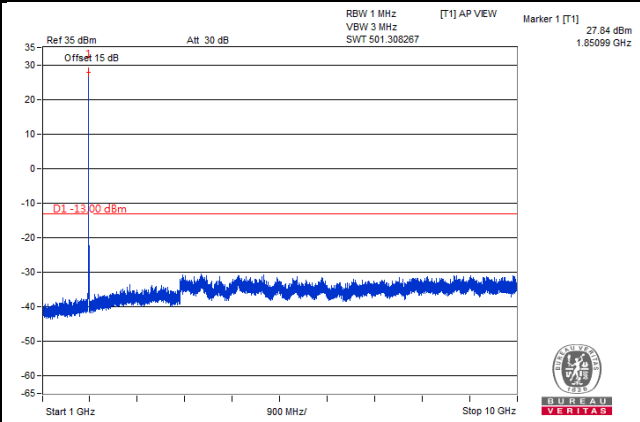

Frequency Range: 10 GHz ~ 27 GHz

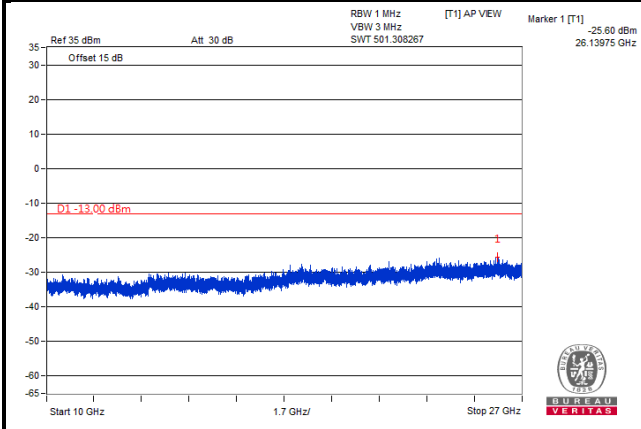

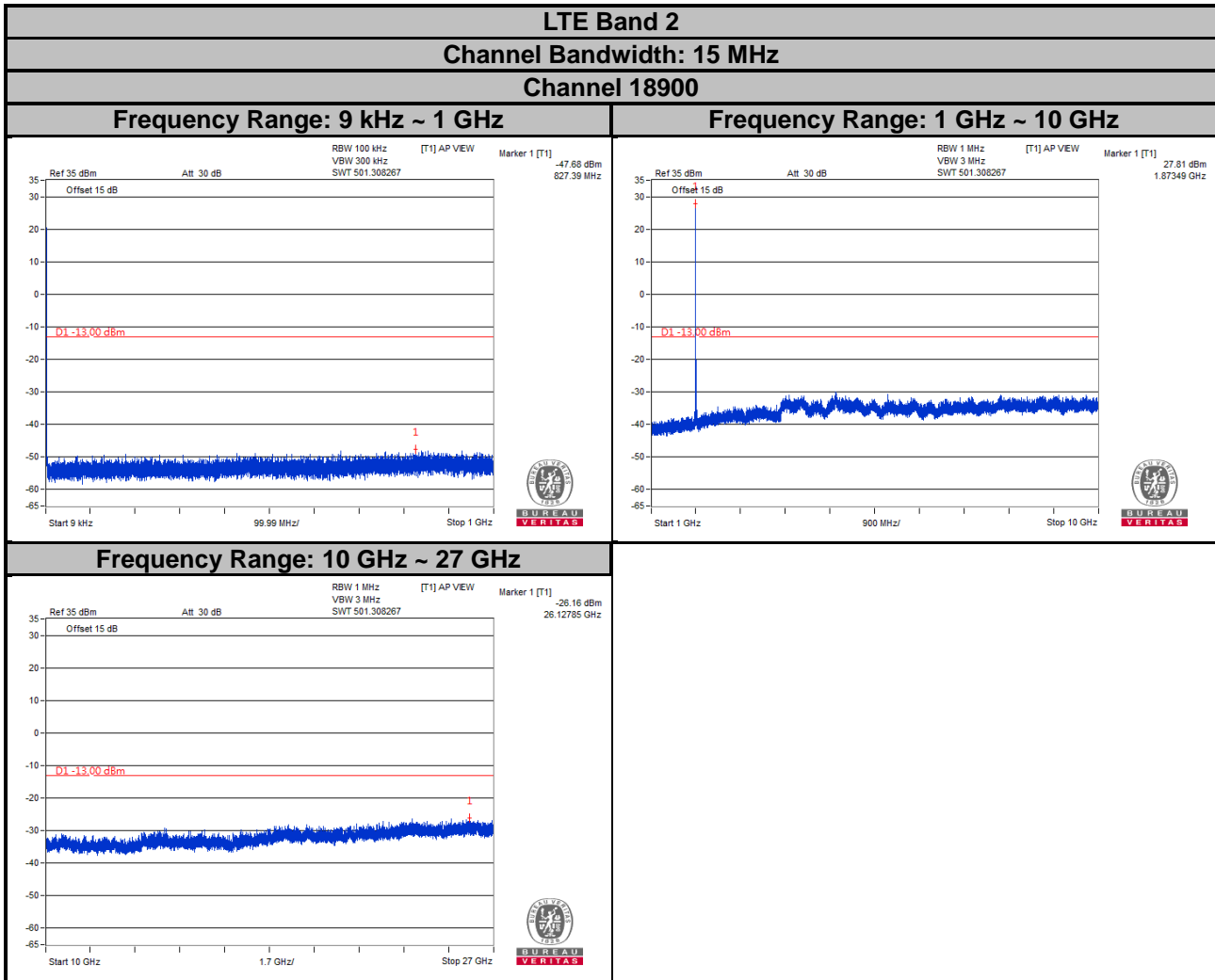

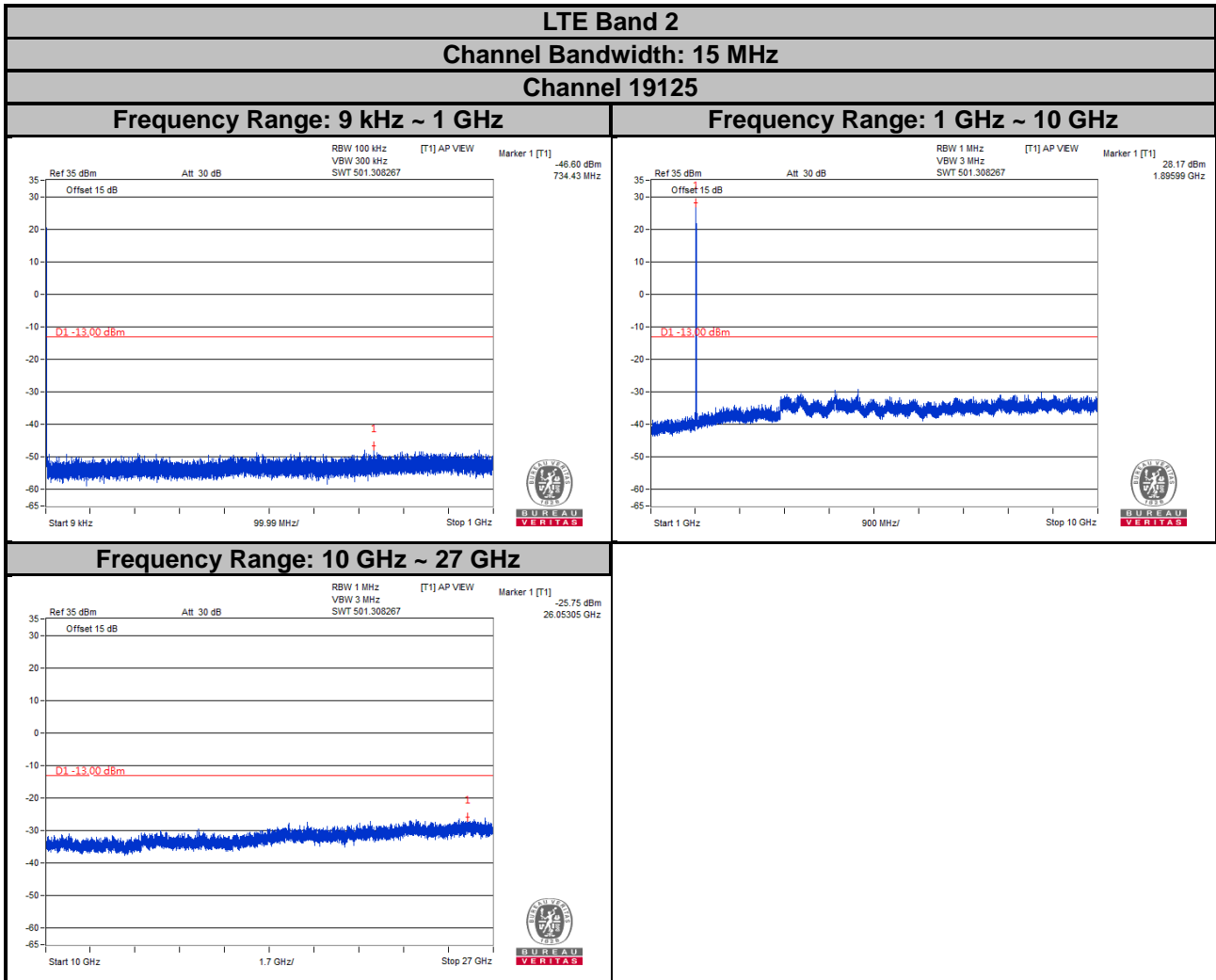

LTE Band 2
Channel Bandwidth: 20 MHz

Channel 18700

Frequency Range: 9 kHz ~ 1 GHz

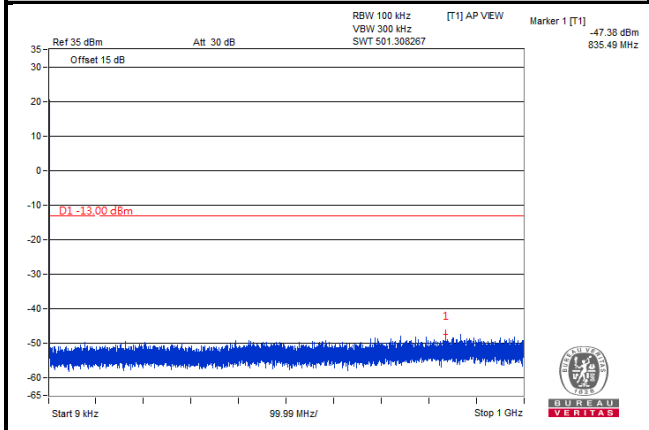

Frequency Range: 1 GHz ~ 10 GHz

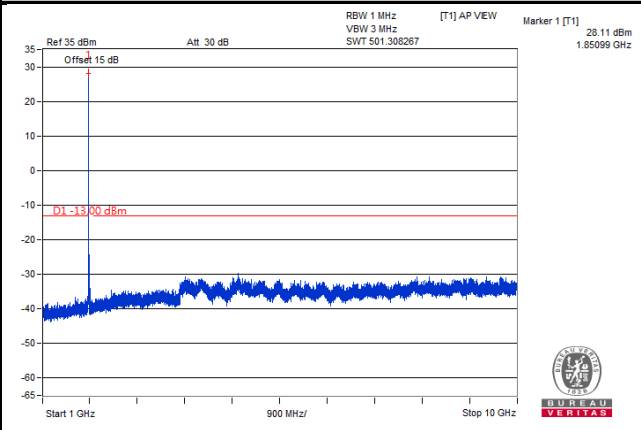

Frequency Range: 10 GHz ~ 27 GHz

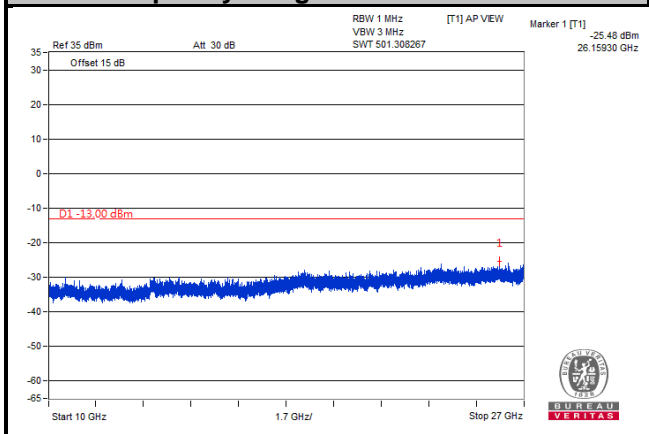

LTE Band 2
Channel Bandwidth: 20 MHz
Channel 18900

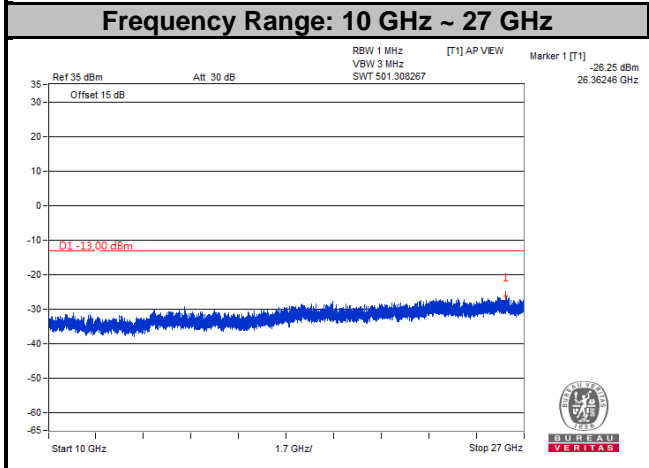
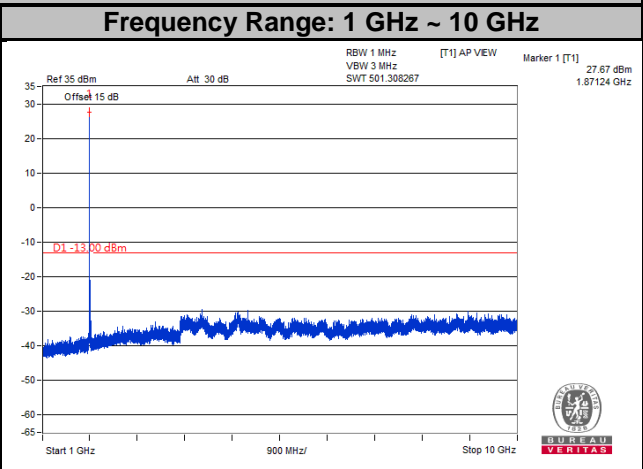
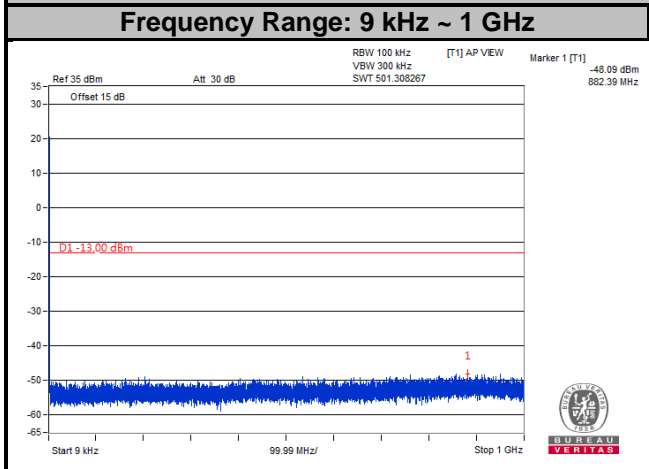

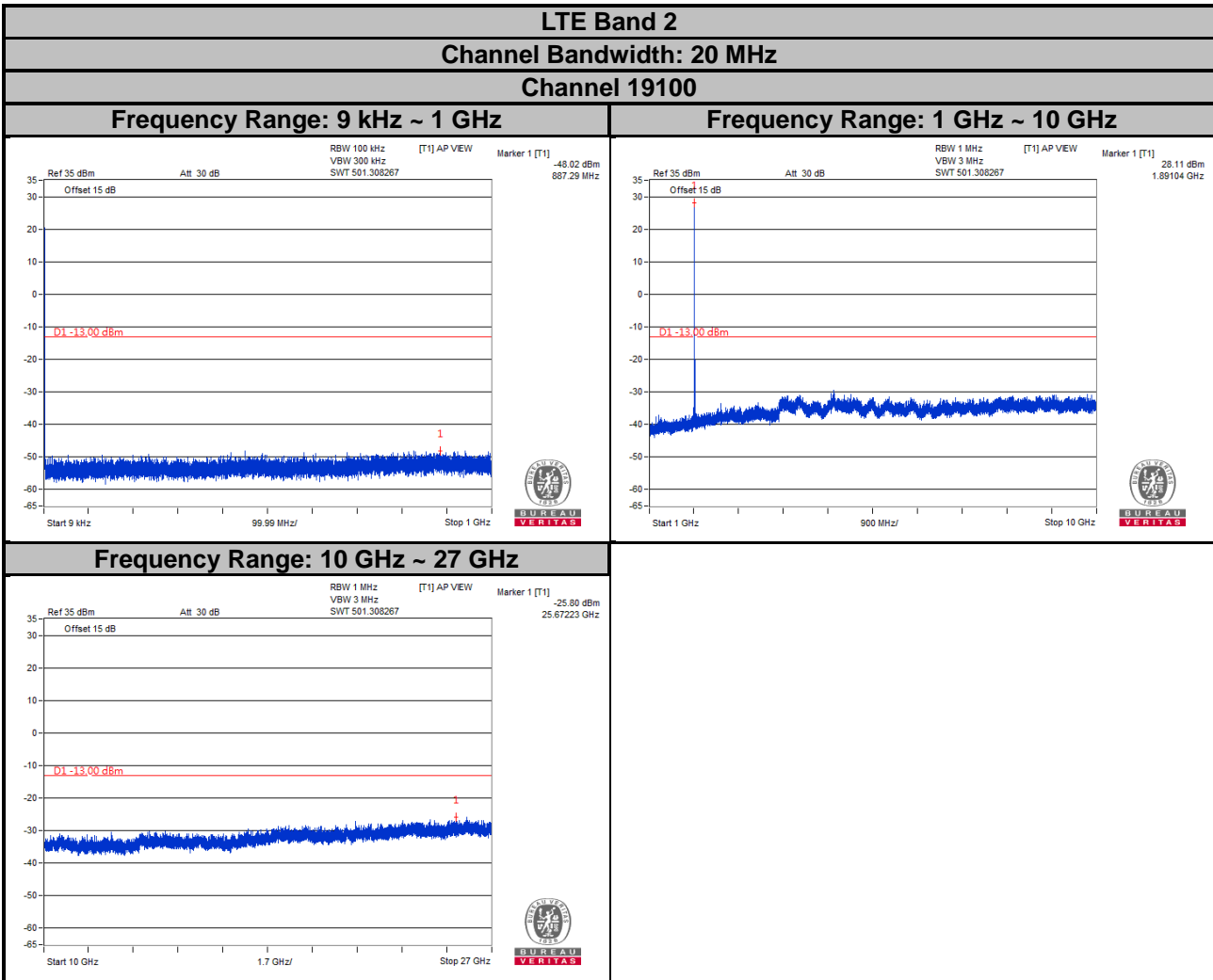

4.8 Radiated Emission Measurement

4.8.1 Limits of Radiated Emission Measurement

The power of any emission outside of the authorized operating frequency ranges must be attenuated below the transmitting power (P) by a factor of at least $43 + 10 \log(P)$ dB. The emission limit is equal to -13 dBm.

4.8.2 Test Procedure

- a. Substitution method is used for E.I.R.P measurement. In the semi-anechoic chamber, EUT placed on the 0.8 m (below or equal 1 GHz) and/or 1.5 m (above 1 GHz) height of Turn Table, rotated the table around 360 degrees to search the maximum radiation power and receiver antenna shall be rotated vertical and horizontal polarization and moved height from 1 m to 4 m to find the maximum polar radiated power. The "Read Value" is the spectrum reading the maximum power value.
- b. The substitution horn antenna is substituted for EUT at the same position and signals generator export the CW signal to the substitution antenna via a TX cable. Rotated the Turn Table and moved receiving antenna to find the maximum radiation power. Adjust output power level of S.G to get a Value of spectrum reading equal to "Read Value" of step a. Record the power level of S.G.
- c. EIRP = Output power level of S.G – TX cable loss + Antenna gain of substitution horn.
- d. E.R.P power can be calculated form E.I.R.P power by subtracting the gain of dipole, E.R.P power = E.I.R.P power - 2.15 dB.

NOTE: The resolution bandwidth and video bandwidth of test receiver/spectrum analyzer is 1 MHz/3 MHz.

4.8.3 Deviation from Test Standard

No deviation.

4.8.4 Test Setup

<Radiated Emission below or equal 1 GHz>

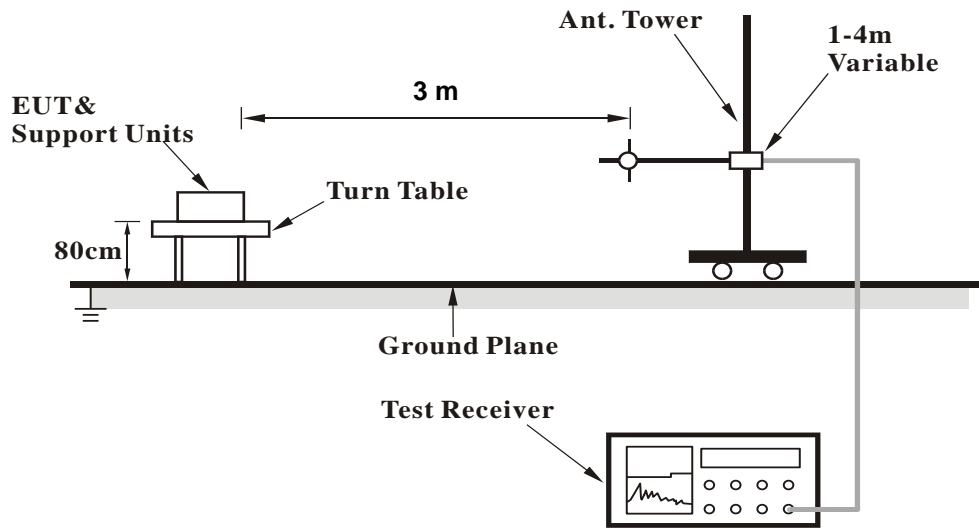

<Radiated Emission above 1 GHz>

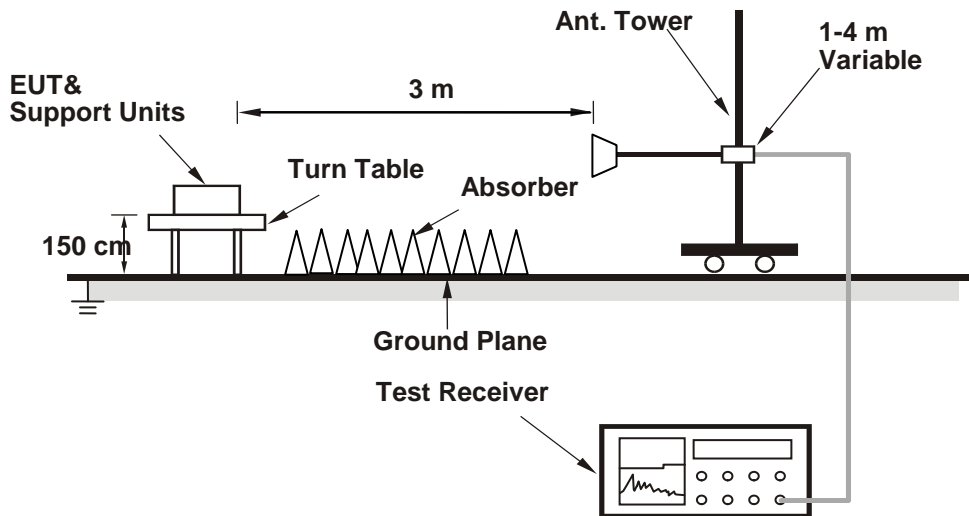

For the actual test configuration, please refer to the attached file (Test Setup Photo).

4.8.5 Test Results

GSM:

Low Channel



Bureau Veritas Consumer Products Services Ltd., Taoyuan Branch

A D T

Data: 13

Date: 2018-09-14

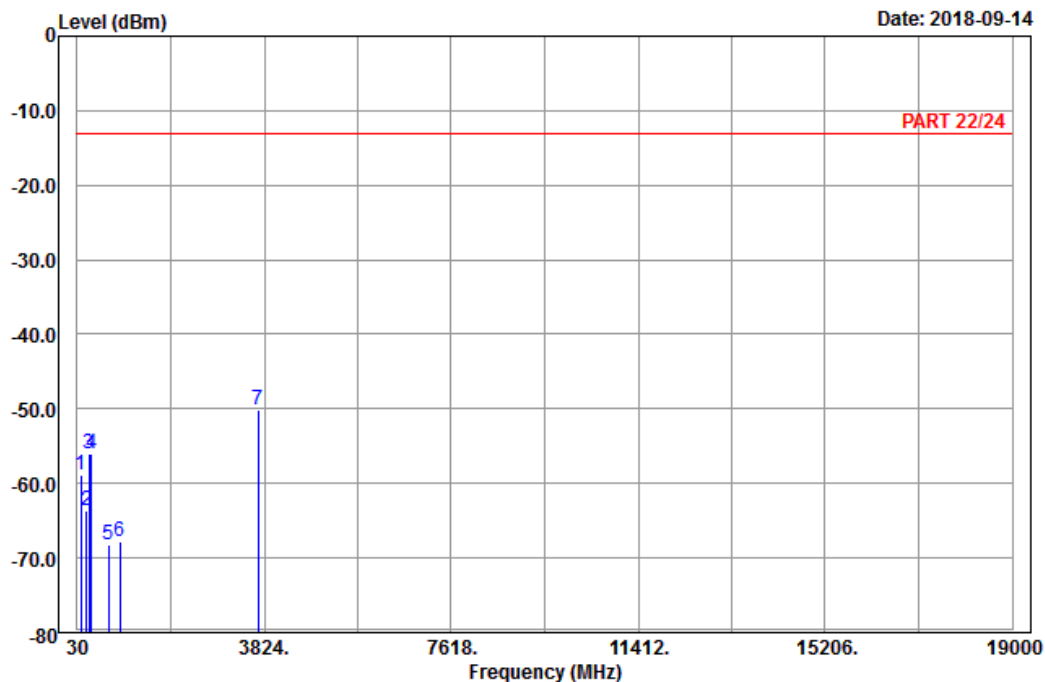

Site : 966 chamber 1
 Condition: PART 22/24 Horizontal
 Remark : PCS 1900_Link_CH512
 Tested by: Karl Lee

	Freq	Level	Read Level	Limit Line	Over Limit	Factor	Remark
	MHz	dBm	dBm	dBm	dB	dB	
1	96.69	-58.84	-48.55	-13.00	-45.84	-10.29	Peak
2	220.35	-63.57	-57.66	-13.00	-50.57	-5.91	Peak
3	277.32	-56.02	-50.26	-13.00	-43.02	-5.76	Peak
4	310.50	-56.07	-50.23	-13.00	-43.07	-5.84	Peak
5	659.80	-68.34	-68.16	-13.00	-55.34	-0.18	Peak
6	888.00	-67.72	-70.27	-13.00	-54.72	2.55	Peak
7 pp	3700.40	-50.10	-65.98	-13.00	-37.10	15.88	Peak



Bureau Veritas Consumer Products Services Ltd., Taoyuan Branch

A D T

Data: 14

Date: 2018-09-14

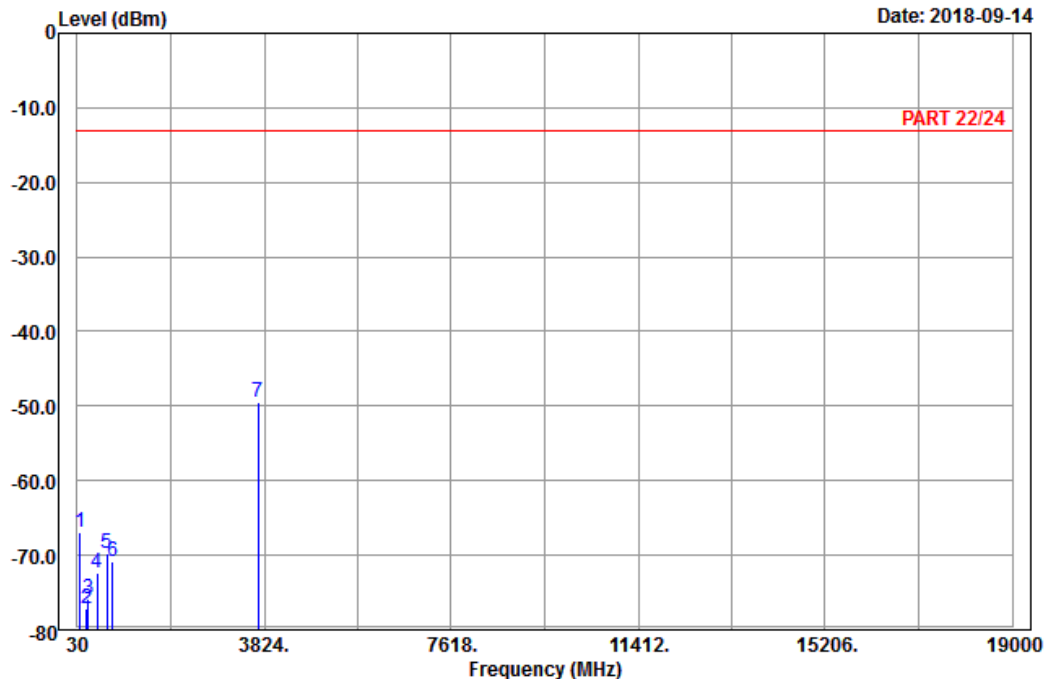

Site : 966 chamber 1
 Condition: PART 22/24 Vertical
 Remark : PCS 1900_Link_CH512
 Tested by: Karl Lee

	Freq	Level	Read Level	Limit Line	Over Limit	Factor	Remark
	MHz	dBm	dBm	dBm	dB	dB	
1	91.56	-66.89	-56.27	-13.00	-53.89	-10.62	Peak
2	220.35	-77.21	-71.30	-13.00	-64.21	-5.91	Peak
3	253.29	-75.88	-70.35	-13.00	-62.88	-5.53	Peak
4	431.60	-72.28	-68.84	-13.00	-59.28	-3.44	Peak
5	633.90	-69.69	-69.73	-13.00	-56.69	0.04	Peak
6	754.30	-70.80	-69.81	-13.00	-57.80	-0.99	Peak
7 pp	3700.40	-49.52	-65.40	-13.00	-36.52	15.88	Peak

Middle Channel



Bureau Veritas Consumer Products Services Ltd., Taoyuan Branch

A D T

Data: 9

Date: 2018-09-14

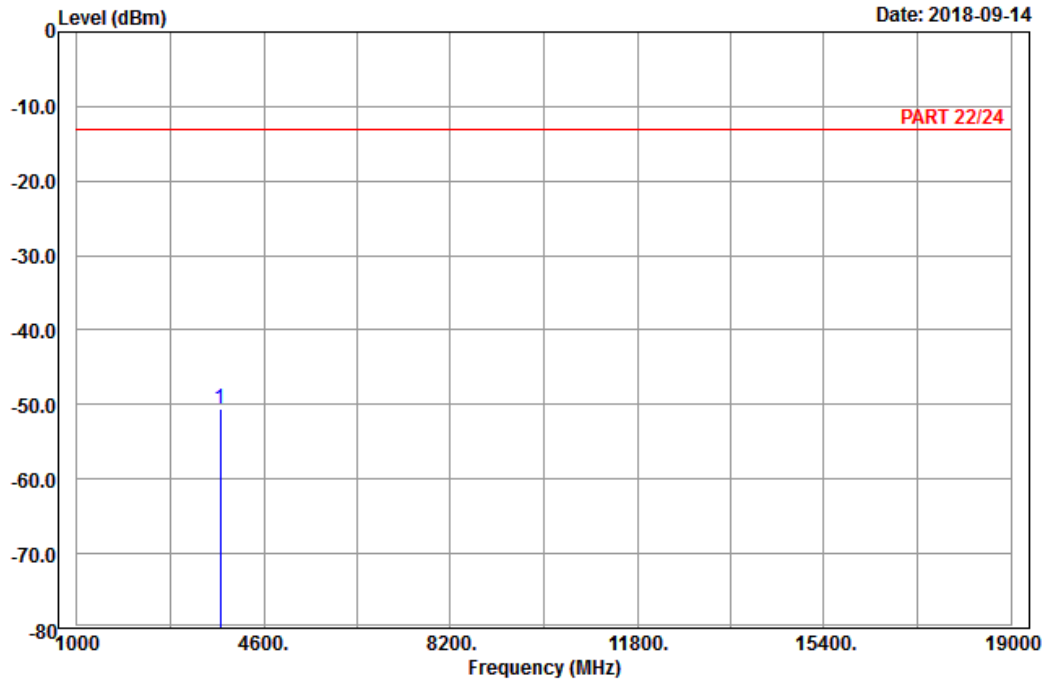

Site : 966 chamber 1
 Condition: PART 22/24 Horizontal
 Remark : PCS 1900_Link_CH661
 Tested by: Karl Lee

Freq	Level	Read Level	Limit Line	Over Limit	Factor	Remark
MHz	dBm	dBm	dBm	dB	dB	
1 pp 3760.00	-50.56	-66.70	-13.00	-37.56	16.14	Peak



Bureau Veritas Consumer Products Services Ltd., Taoyuan Branch

A D T

Data: 10

Date: 2018-09-14

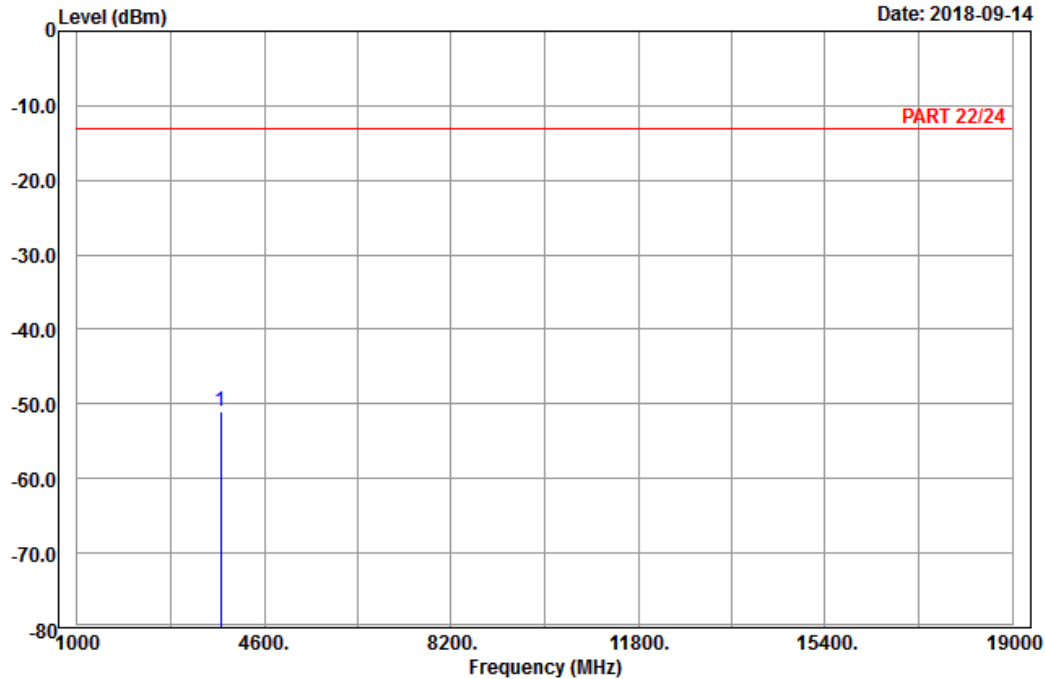

Site : 966 chamber 1
 Condition: PART 22/24 Vertical
 Remark : PCS 1900_Link_CH661
 Tested by: Karl Lee

	Freq	Level	Read Level	Limit Line	Over Limit	Factor	Remark
	MHz	dBm	dBm	dBm	dB	dB	
1	pp 3760.00	-51.07	-67.21	-13.00	-38.07	16.14	Peak

High Channel



Bureau Veritas Consumer Products Services Ltd., Taoyuan Branch

A D T

Data: 9

Date: 2018-09-14

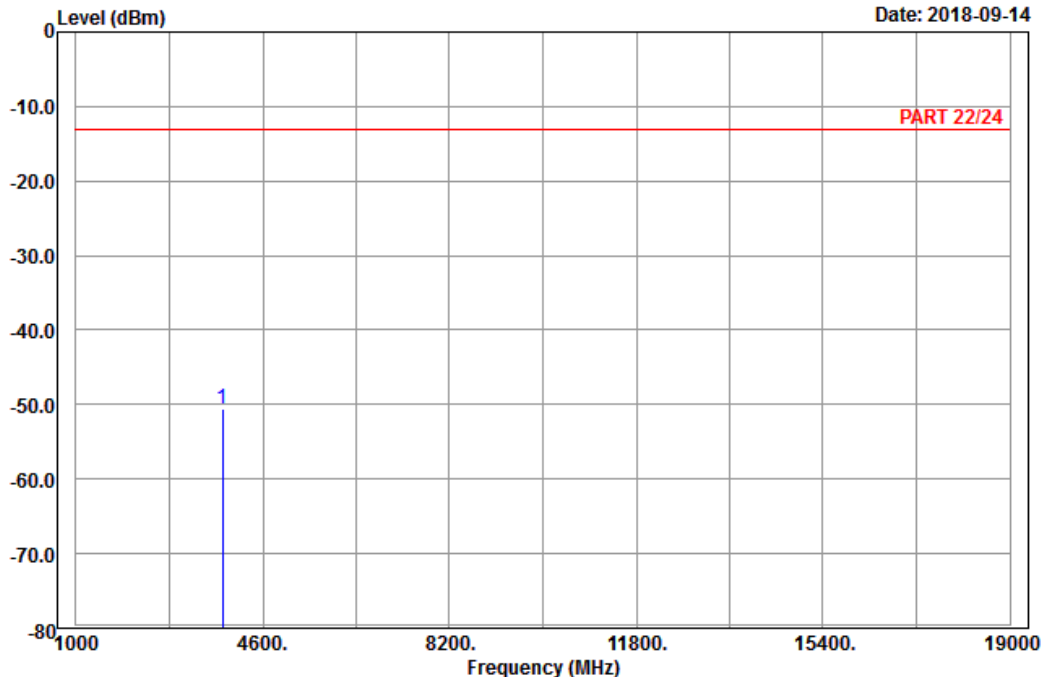

Site : 966 chamber 1
 Condition: PART 22/24 Horizontal
 Remark : PCS 1900_Link_CH810
 Tested by: Karl Lee

Freq	Level	Read Level	Limit Line	Over Limit	Factor	Remark
MHz	dBm	dBm	dBm	dB	dB	
1 pp 3819.60	-50.51	-67.01	-13.00	-37.51	16.50	Peak



Bureau Veritas Consumer Products Services Ltd., Taoyuan Branch

A D T

Data: 10

Date: 2018-09-14

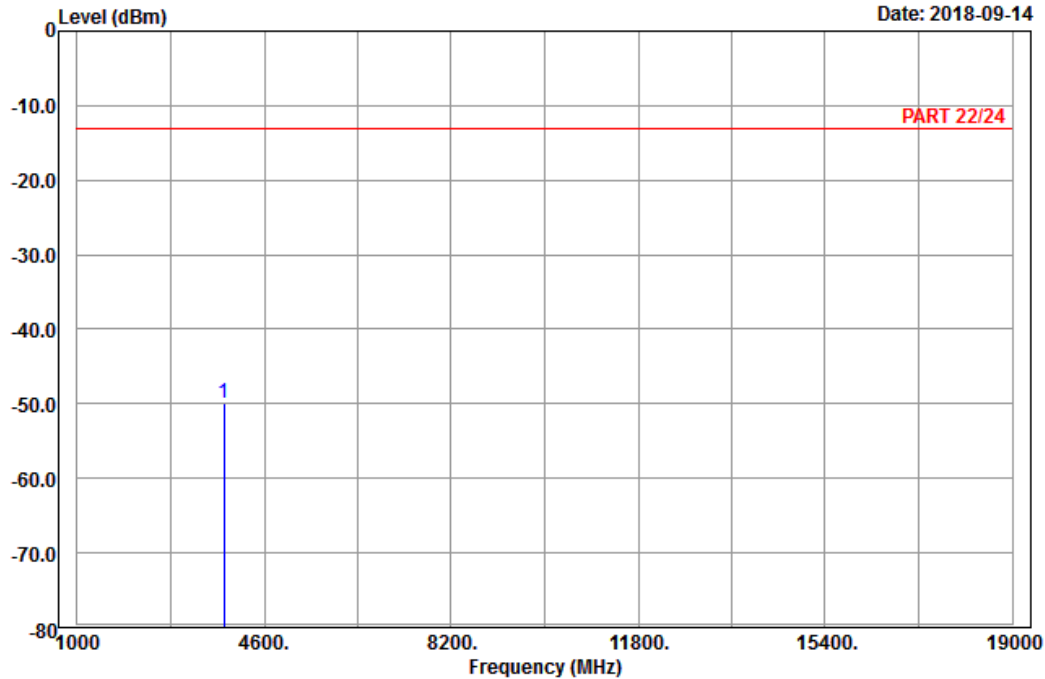

Site : 966 chamber 1
 Condition: PART 22/24 Vertical
 Remark : PCS 1900_Link_CH810
 Tested by: Karl Lee

	Freq	Level	Read Level	Limit Line	Over Limit	Factor	Remark
	MHz	dBm	dBm	dBm	dB	dB	
1	pp 3819.60	-50.00	-66.50	-13.00	-37.00	16.50	Peak

EDGE:
Low Channel



Bureau Veritas Consumer Products Services Ltd., Taoyuan Branch

A D T

Data: 9

Date: 2018-09-14

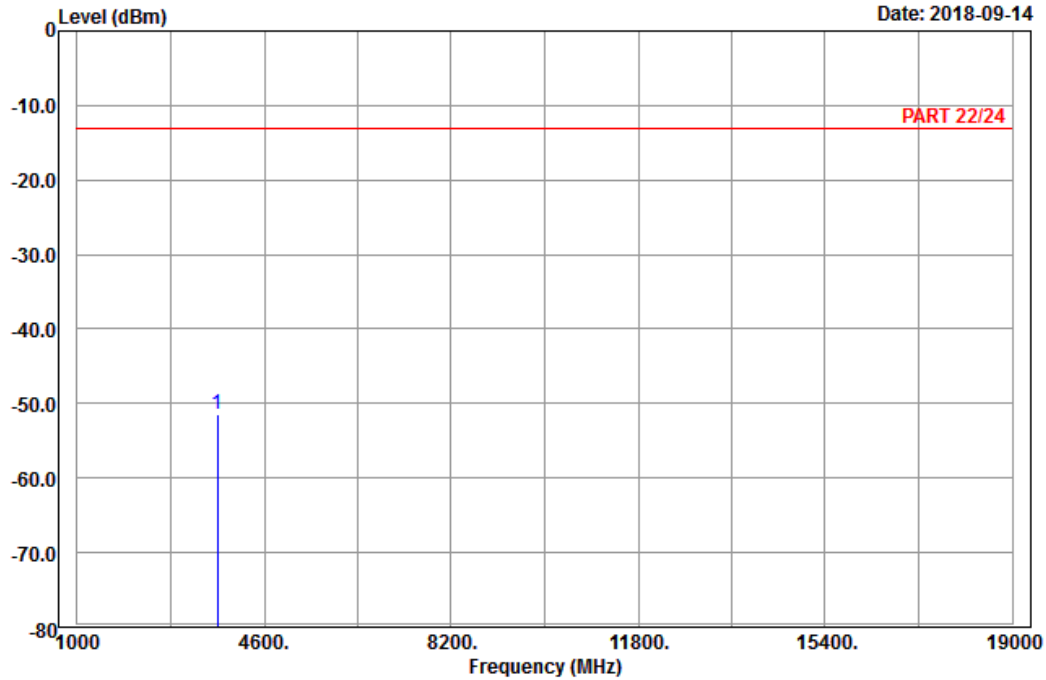

Site : 966 chamber 1
Condition: PART 22/24 Horizontal
Remark : EDGE 1900_Link_CH512
Tested by: Karl Lee

	Freq	Level	Read Level	Limit Line	Over Limit	Factor	Remark
	MHz	dBm	dBm	dBm	dB	dB	
1	pp 3700.40	-51.40	-67.28	-13.00	-38.40	15.88	Peak



Bureau Veritas Consumer Products Services Ltd., Taoyuan Branch

A D T

Data: 10

Date: 2018-09-14

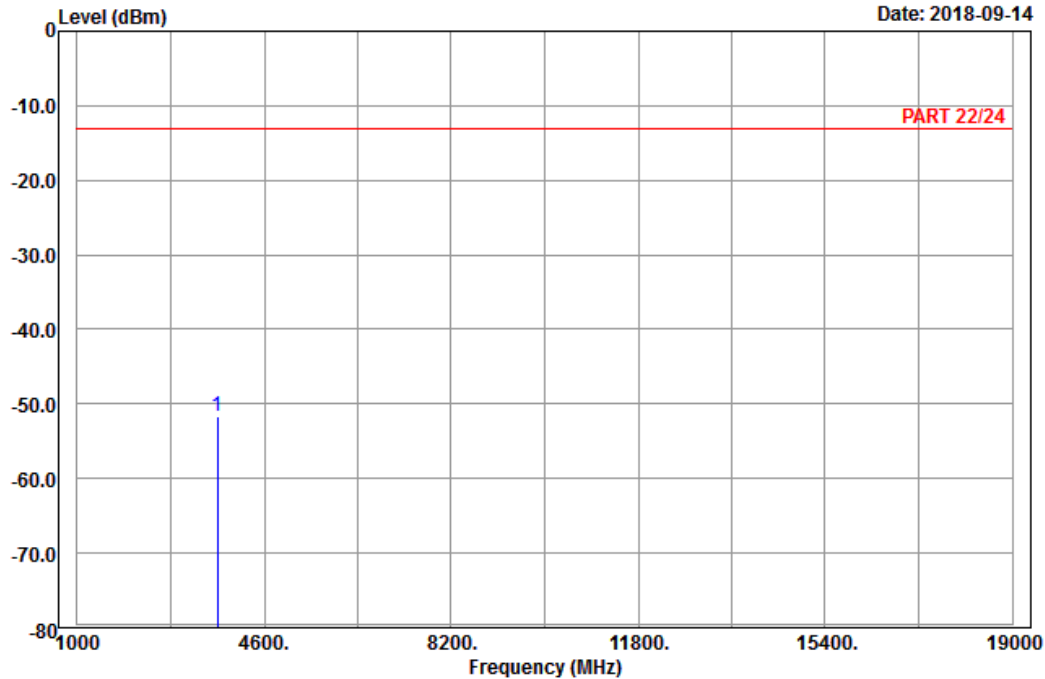

Site : 966 chamber 1
 Condition: PART 22/24 Vertical
 Remark : EDGE 1900_Link_CH512
 Tested by: Karl Lee

	Freq	Level	Read Level	Limit Line	Over Limit	Factor	Remark
	MHz	dBm	dBm	dBm	dB	dB	
1	pp 3700.40	-51.70	-67.58	-13.00	-38.70	15.88	Peak

Middle Channel



Bureau Veritas Consumer Products Services Ltd., Taoyuan Branch

A D T

Data: 9

Date: 2018-09-14

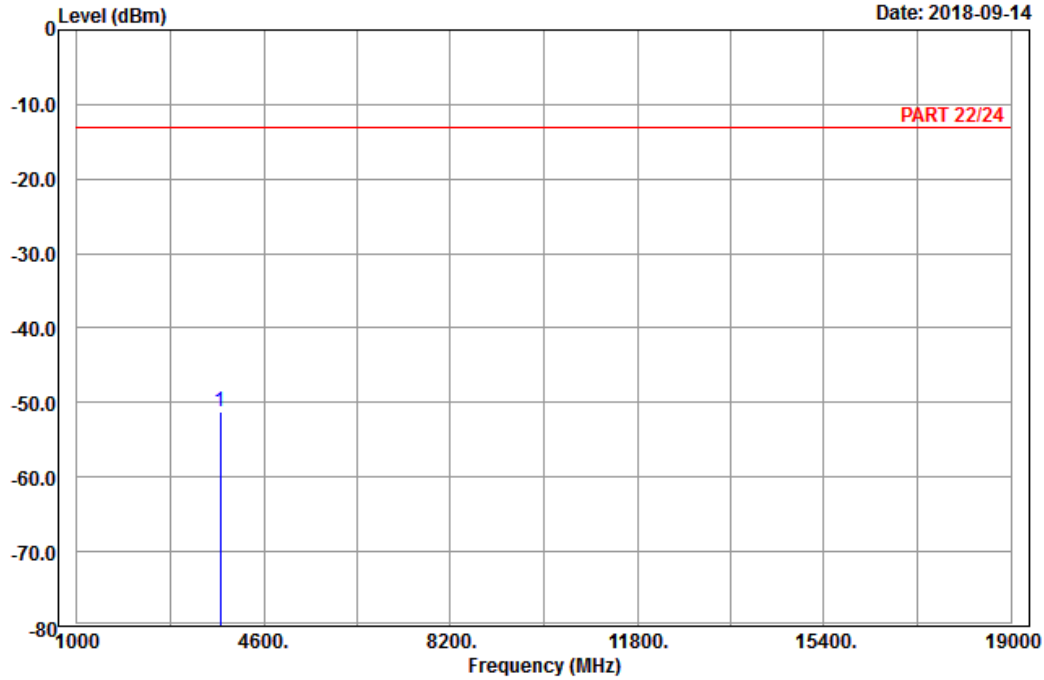

Site : 966 chamber 1
 Condition: PART 22/24 Horizontal
 Remark : EDGE 1900_Link_CH661
 Tested by: Karl Lee

Freq	Level	Read Level	Limit Line	Over Limit	Factor	Remark
MHz	dBm	dBm	dBm	dB	dB	
1 pp 3760.00	-51.31	-67.45	-13.00	-38.31	16.14	Peak



Bureau Veritas Consumer Products Services Ltd., Taoyuan Branch

A D T

Data: 10

Date: 2018-09-14

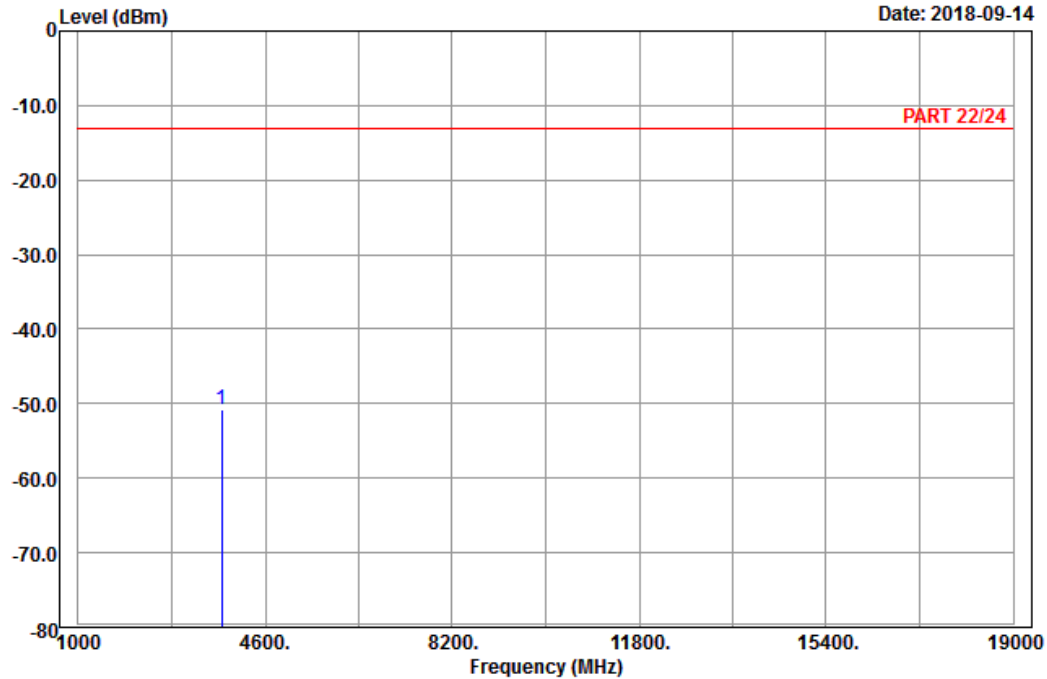

Site : 966 chamber 1
 Condition: PART 22/24 Vertical
 Remark : EDGE 1900_Link_CH661
 Tested by: Karl Lee

	Freq	Level	Read Level	Limit Line	Over Limit	Factor	Remark
	MHz	dBm	dBm	dBm	dB	dB	
1	pp 3760.00	-50.87	-67.01	-13.00	-37.87	16.14	Peak

High Channel



Bureau Veritas Consumer Products Services Ltd., Taoyuan Branch

A D T

Data: 9

Date: 2018-09-14

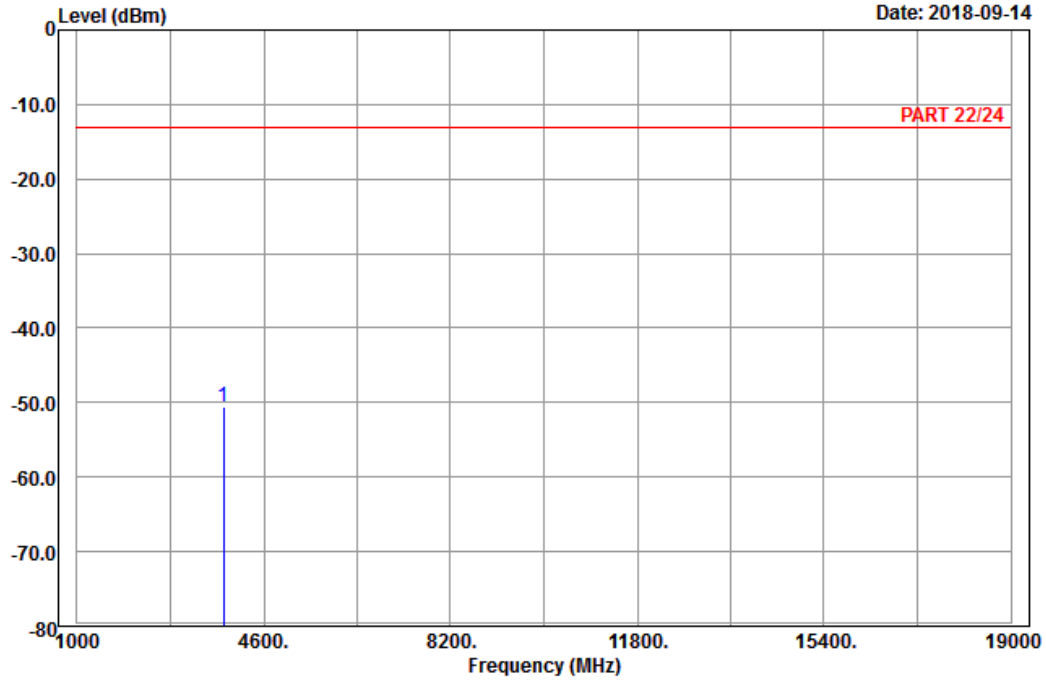

Site : 966 chamber 1
 Condition: PART 22/24 Horizontal
 Remark : EDGE 1900_Link_CH810
 Tested by: Karl Lee

Freq	Level	Read Level	Limit Line	Over Limit	Factor	Remark
MHz	dBm	dBm	dBm	dB	dB	
1 pp 3819.60	-50.50	-67.00	-13.00	-37.50	16.50	Peak



Bureau Veritas Consumer Products Services Ltd., Taoyuan Branch

A D T

Data: 10

Date: 2018-09-14

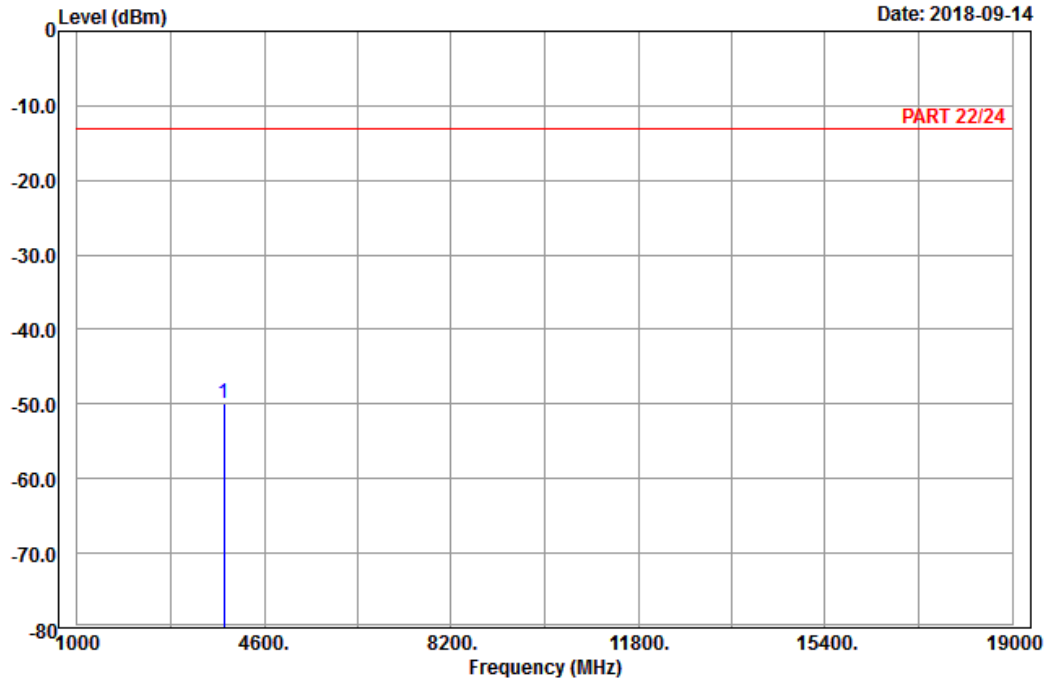

Site : 966 chamber 1
 Condition: PART 22/24 Vertical
 Remark : EDGE 1900_Link_CH810
 Tested by: Karl Lee

	Freq	Level	Read Level	Limit Line	Over Limit	Factor	Remark
	MHz	dBm	dBm	dBm	dB	dB	
1	pp 3819.60	-49.83	-66.33	-13.00	-36.83	16.50	Peak

WCDMA:
Low Channel



Bureau Veritas Consumer Products Services Ltd., Taoyuan Branch

A D T

Data: 9

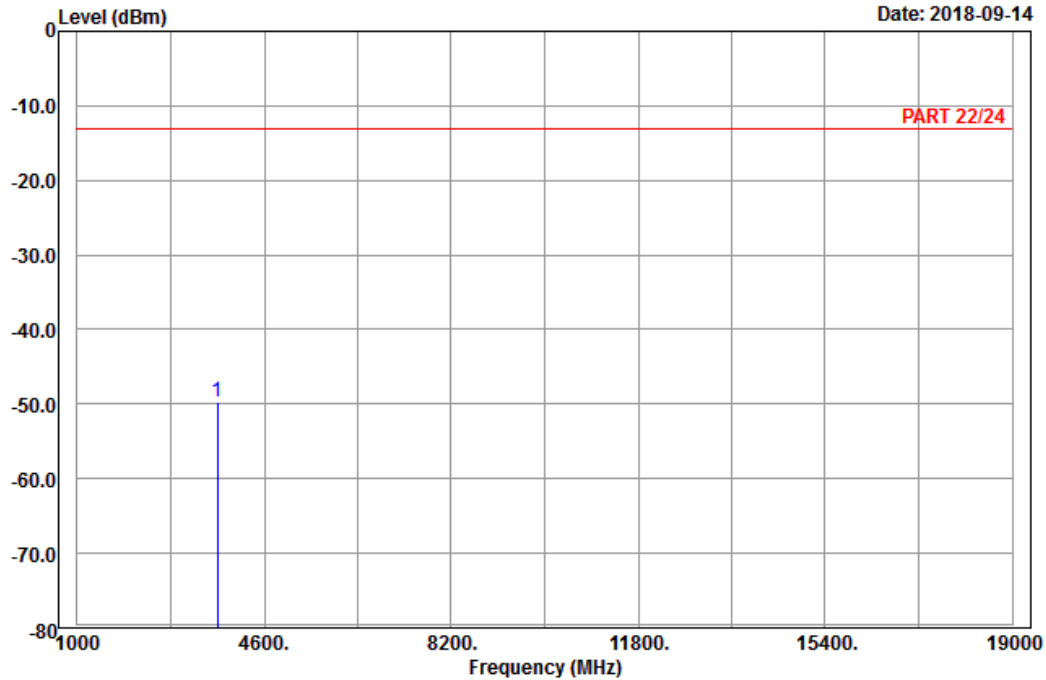

Site : 966 chamber 1
Condition: PART 22/24 Horizontal
Remark : Band II_Link_CH9262
Tested by: Karl Lee

	Read	Limit	Over				
Freq	Level	Level	Line	Limit	Factor	Remark	
MHz	dBm	dBm	dBm	dB	dB		
1 pp 3704.80	-49.68	-65.56	-13.00	-36.68	15.88	Peak	



Bureau Veritas Consumer Products Services Ltd., Taoyuan Branch

A D T

Data: 10

Date: 2018-09-14

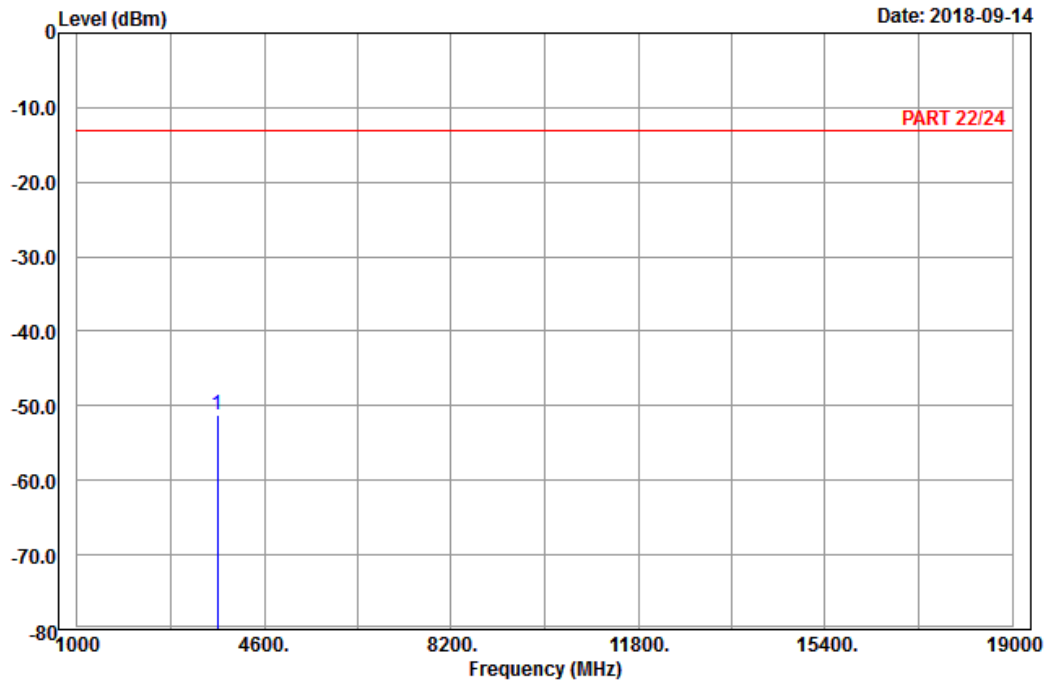

Site : 966 chamber 1
 Condition: PART 22/24 Vertical
 Remark : Band II_Link_CH9262
 Tested by: Karl Lee

	Freq	Level	Read Level	Limit Line	Over Limit	Factor	Remark
	MHz	dBm	dBm	dBm	dB	dB	
1	pp 3704.80	-51.29	-67.17	-13.00	-38.29	15.88	Peak

Middle Channel



Bureau Veritas Consumer Products Services Ltd., Taoyuan Branch

A D T

Data: 9

Date: 2018-09-14

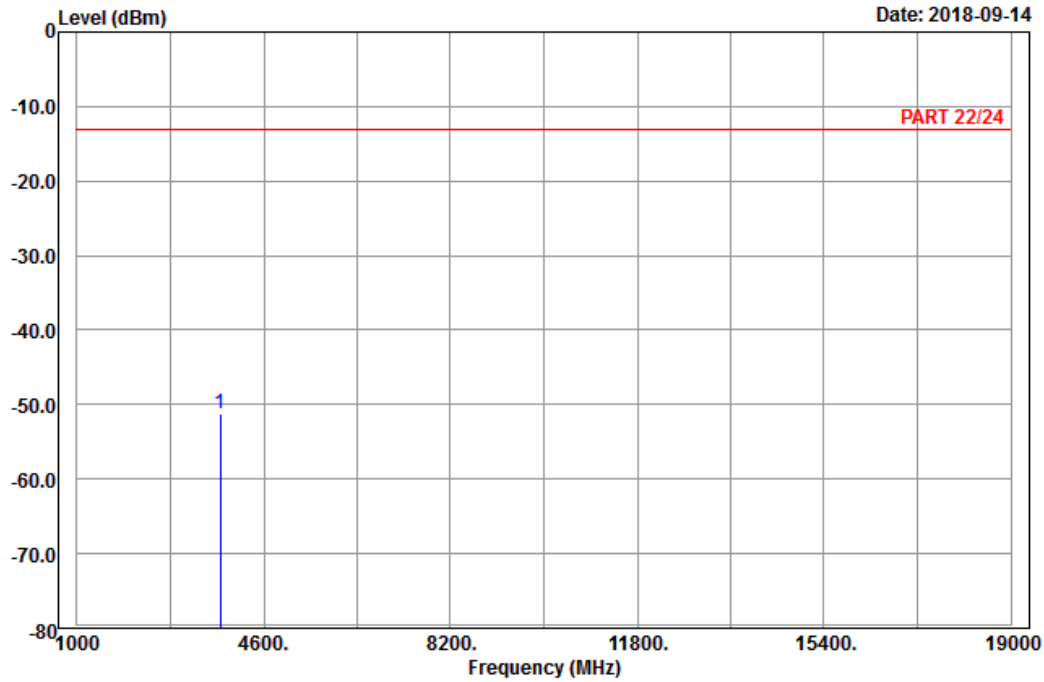

Site : 966 chamber 1
 Condition: PART 22/24 Horizontal
 Remark : Band II_Link_CH9400
 Tested by: Karl Lee

Freq	Level	Read Level	Limit Line	Over Limit	Factor	Remark
MHz	dBm	dBm	dBm	dB	dB	
1 pp 3760.00	-51.14	-67.28	-13.00	-38.14	16.14	Peak



Bureau Veritas Consumer Products Services Ltd., Taoyuan Branch

A D T

Data: 10

Date: 2018-09-14

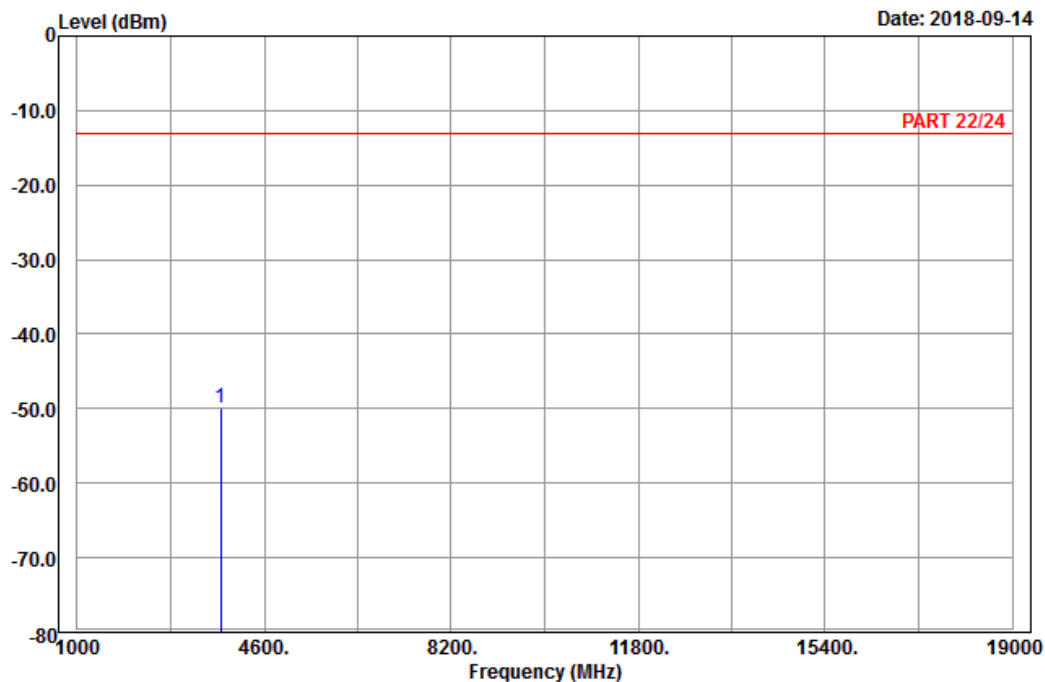

Site : 966 chamber 1
 Condition: PART 22/24 Vertical
 Remark : Band II_Link_CH9400
 Tested by: Karl Lee

	Freq	Level	Read Level	Limit Line	Over Limit	Factor	Remark
	MHz	dBm	dBm	dBm	dB	dB	
1	pp 3760.00	-49.88	-66.02	-13.00	-36.88	16.14	Peak

High Channel



Bureau Veritas Consumer Products Services Ltd., Taoyuan Branch

A D T

Data: 9

Date: 2018-09-14

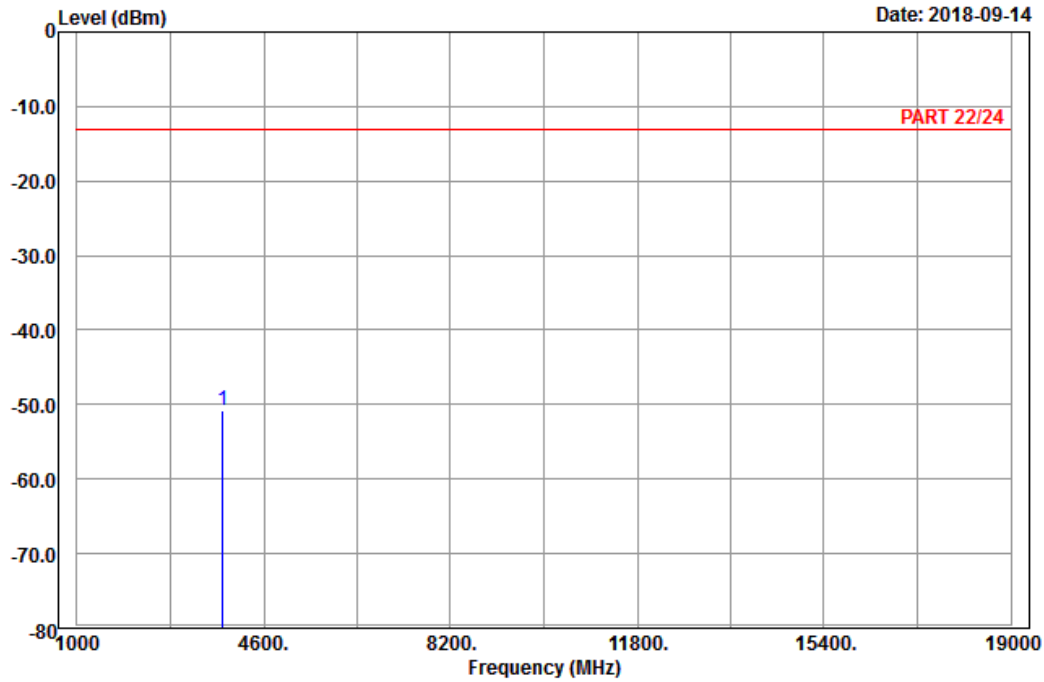

Site : 966 chamber 1
 Condition: PART 22/24 Horizontal
 Remark : Band II_Link_CH9538
 Tested by: Karl Lee

Freq	Level	Read Level	Limit Line	Over Limit	Factor	Remark
MHz	dBm	dBm	dBm	dB	dB	
1 pp 3815.20	-50.71	-67.12	-13.00	-37.71	16.41	Peak



Bureau Veritas Consumer Products Services Ltd., Taoyuan Branch

A D T

Data: 10

Date: 2018-09-14

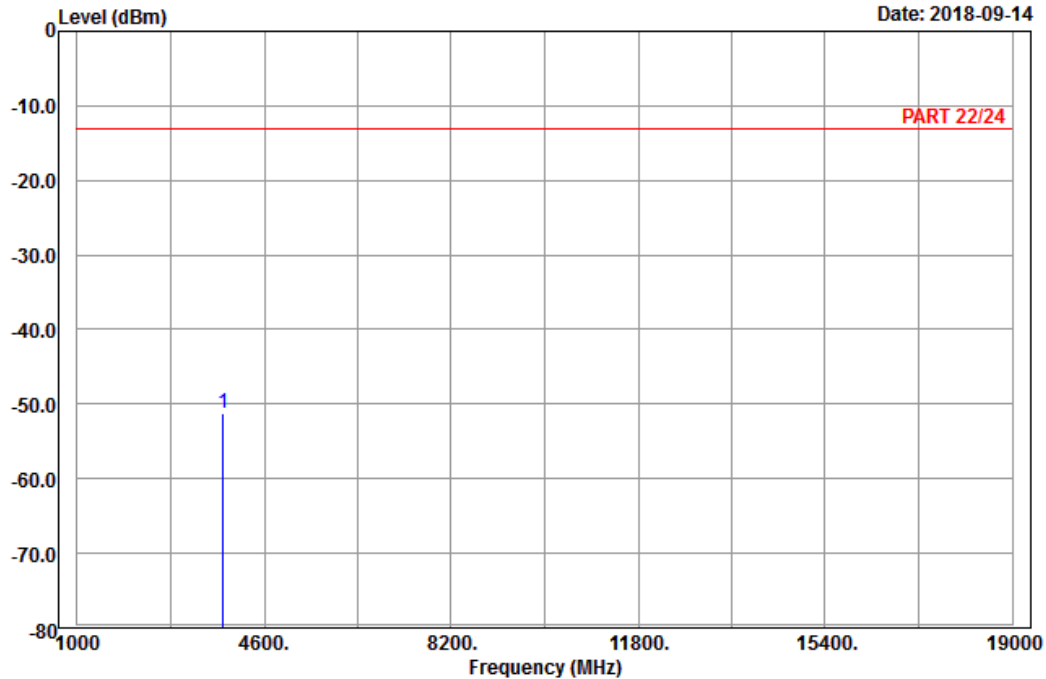

Site : 966 chamber 1
 Condition: PART 22/24 Vertical
 Remark : Band II_Link_CH9538
 Tested by: Karl Lee

	Freq	Level	Read Level	Limit Line	Over Limit	Factor	Remark
	MHz	dBm	dBm	dBm	dB	dB	
1 pp	3815.20	-51.24	-67.65	-13.00	-38.24	16.41	Peak

LTE Band 2
 Channel Bandwidth: 1.4 MHz / QPSK
 Low Channel



Bureau Veritas Consumer Products Services Ltd., Taoyuan Branch

A D T

Data: 9

Date: 2018-09-13

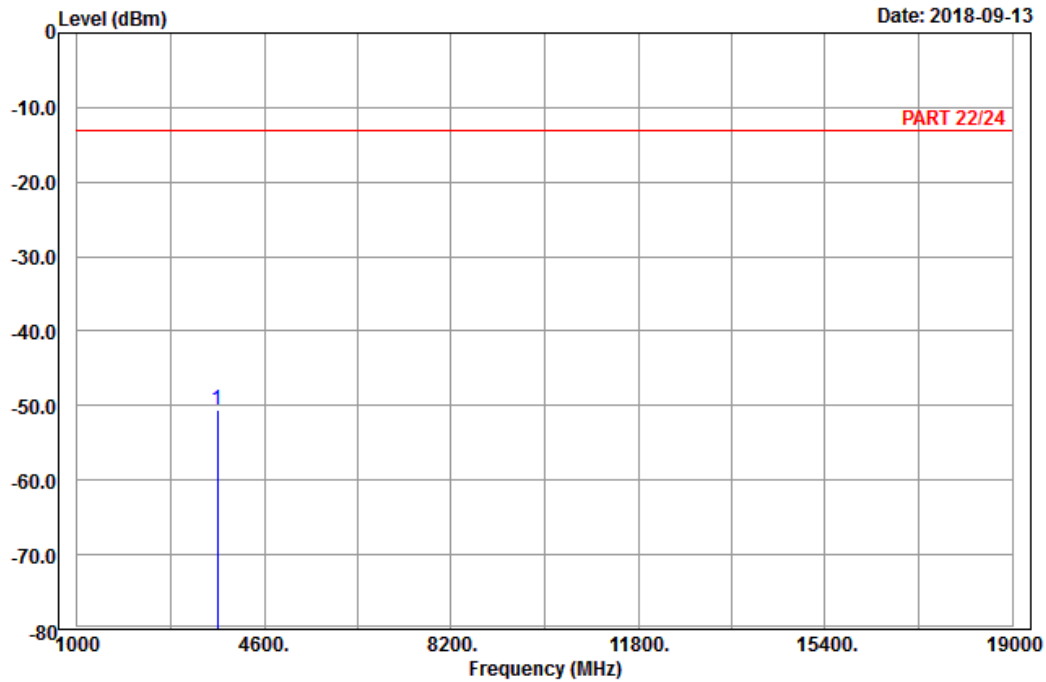

Site : 966 chamber 1
 Condition: PART 22/24 Horizontal
 Remark : LTE_Band 2_Link_CH18607
 Tested by: Harry Hsueh

	Read	Limit	Over			
Freq	Level	Level	Line	Limit	Factor	Remark
MHz	dBm	dBm	dBm	dB	dB	
1 pp 3701.40	-50.58	-66.46	-13.00	-37.58	15.88	Peak



A D T

Data: 10

Date: 2018-09-13

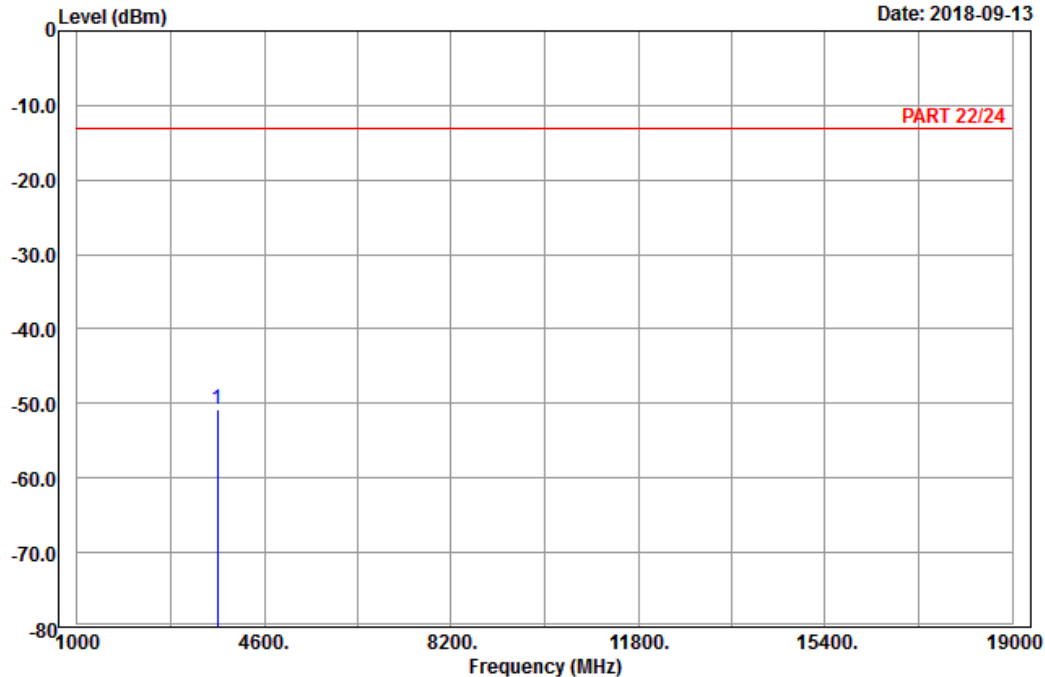

Site : 966 chamber 1
 Condition: PART 22/24 Vertical
 Remark : LTE_Band 2_Link_CH18607
 Tested by: Harry Hsueh

	Freq	Level	Read Level	Limit Line	Over Limit	Factor	Remark
	MHz	dBm	dBm	dBm	dB	dB	
1	pp 3701.40	-50.70	-66.58	-13.00	-37.70	15.88	Peak

Middle Channel



Bureau Veritas Consumer Products Services Ltd., Taoyuan Branch

A D T

Data: 9

Date: 2018-09-13

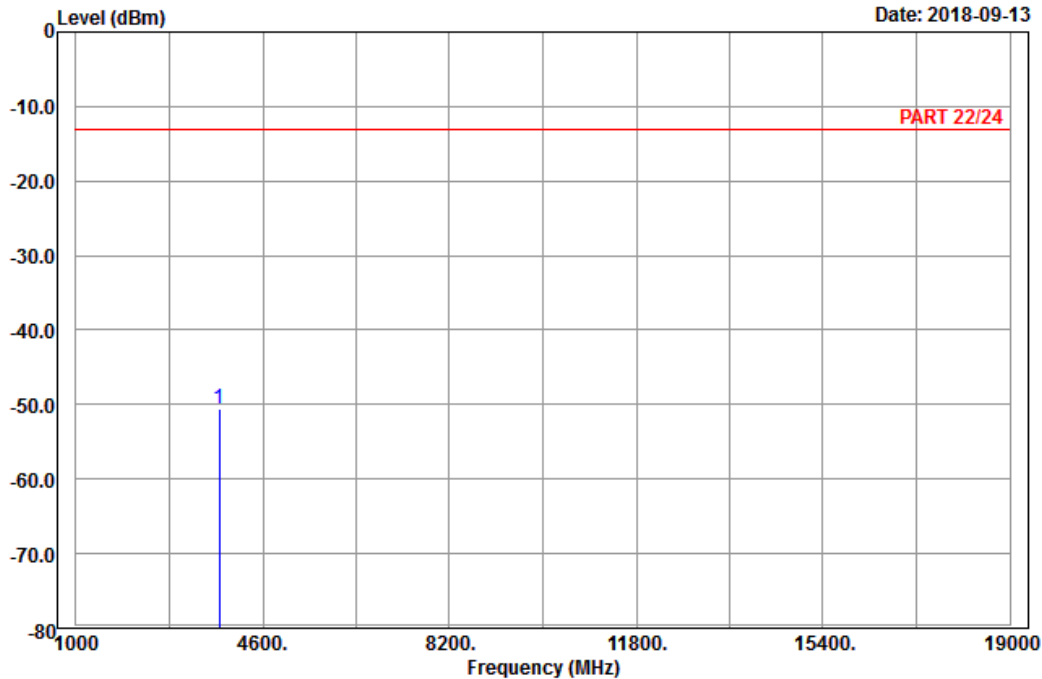

Site : 966 chamber 1
 Condition: PART 22/24 Horizontal
 Remark : LTE_Band 2_Link_CH18900
 Tested by: Harry Hsueh

	Read	Limit	Over			
Freq	Level	Level	Line	Limit	Factor	Remark
MHz	dBm	dBm	dBm	dB	dB	
1 pp 3760.00	-50.54	-66.68	-13.00	-37.54	16.14	Peak



Bureau Veritas Consumer Products Services Ltd., Taoyuan Branch

A D T

Data: 10

Date: 2018-09-13

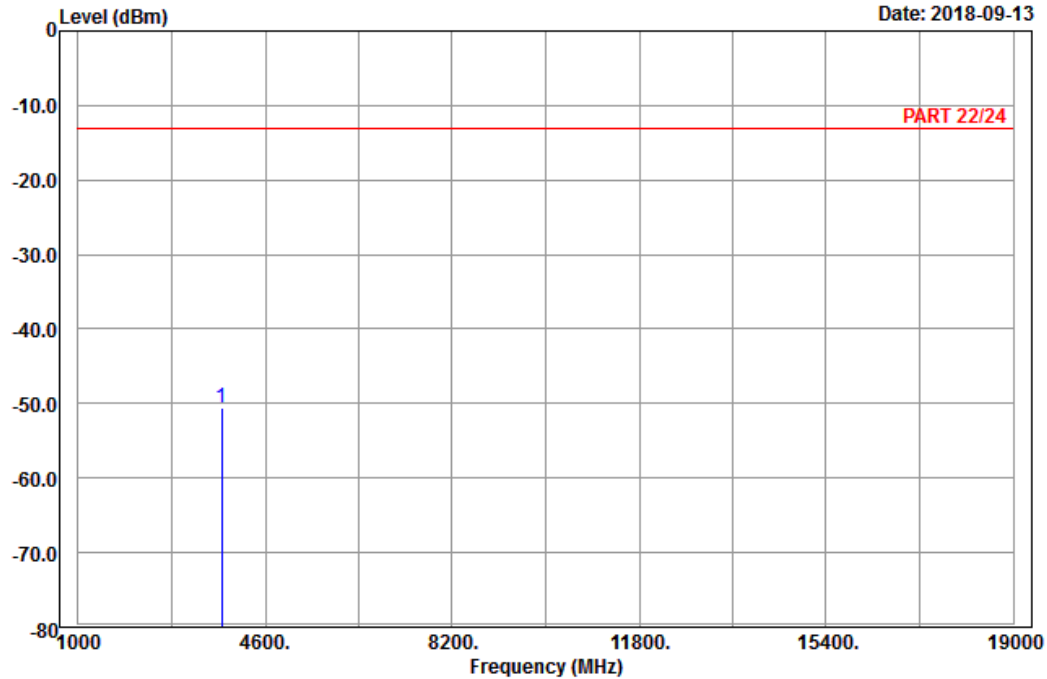

Site : 966 chamber 1
 Condition: PART 22/24 Vertical
 Remark : LTE_Band 2_Link_CH18900
 Tested by: Harry Hsueh

	Freq	Level	Read Level	Limit Line	Over Limit	Factor	Remark
	MHz	dBm	dBm	dBm	dB	dB	
1 pp	3760.00	-50.51	-66.65	-13.00	-37.51	16.14	Peak

High Channel



Bureau Veritas Consumer Products Services Ltd., Taoyuan Branch

A D T

Data: 9

Date: 2018-09-13

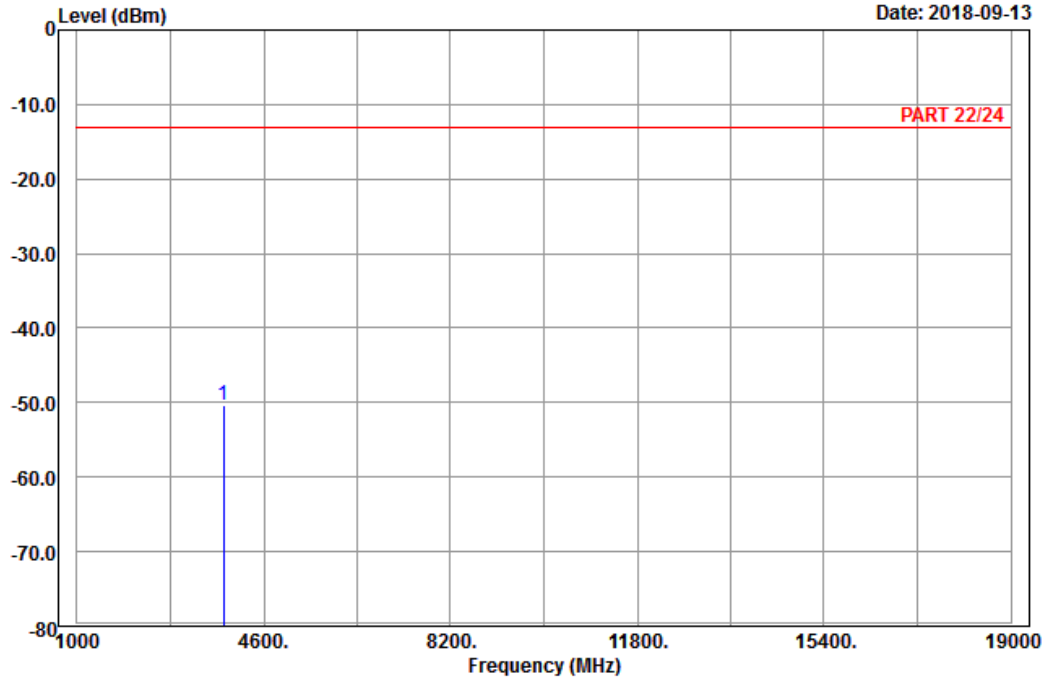

Site : 966 chamber 1
 Condition: PART 22/24 Horizontal
 Remark : LTE_Band 2_Link_CH19193
 Tested by: Harry Hsueh

	Read	Limit	Over			
Freq	Level	Level	Line	Limit	Factor	Remark
MHz	dBm	dBm	dBm	dB	dB	
1 pp 3818.60	-50.31	-66.81	-13.00	-37.31	16.50	Peak



Bureau Veritas Consumer Products Services Ltd., Taoyuan Branch

A D T

Data: 10

Date: 2018-09-13

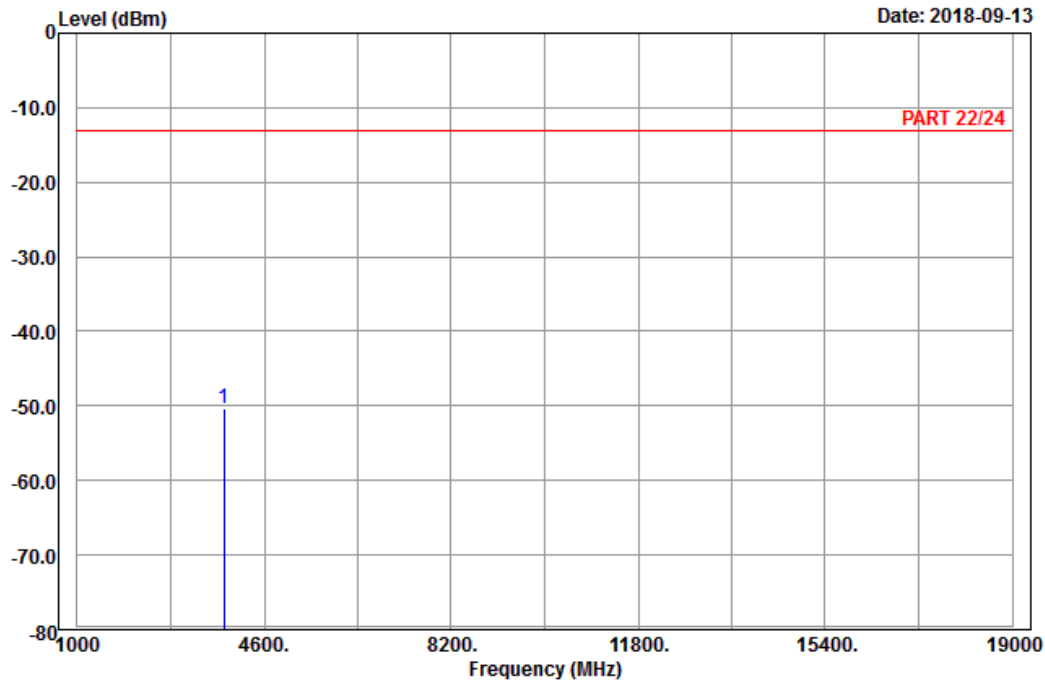

Site : 966 chamber 1
 Condition: PART 22/24 Vertical
 Remark : LTE_Band 2_Link_CH19193
 Tested by: Harry Hsueh

	Freq	Level	Read Level	Limit Line	Over Limit	Factor	Remark
	MHz	dBm	dBm	dBm	dB	dB	
1 pp	3818.60	-50.29	-66.79	-13.00	-37.29	16.50	Peak

Channel Bandwidth: 5 MHz / QPSK
Low Channel



Bureau Veritas Consumer Products Services Ltd., Taoyuan Branch

A D T

Data: 9

Date: 2018-09-13

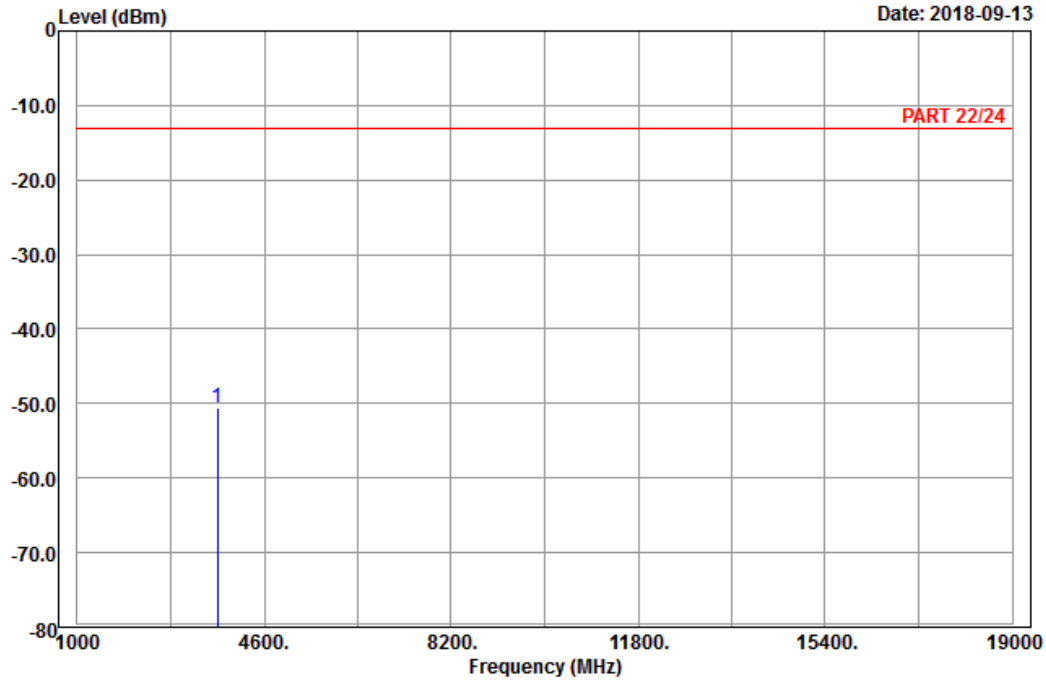

Site : 966 chamber 1
Condition: PART 22/24 Horizontal
Remark : LTE_Band 2_Link_CH18625
Tested by: Harry Hsueh

	Read	Limit	Over				
Freq	Level	Level	Line	Limit	Factor	Remark	
MHz	dBm	dBm	dBm	dB	dB		
1 pp 3705.00	-50.68	-66.56	-13.00	-37.68	15.88	Peak	



A D T

Data: 10

Date: 2018-09-13

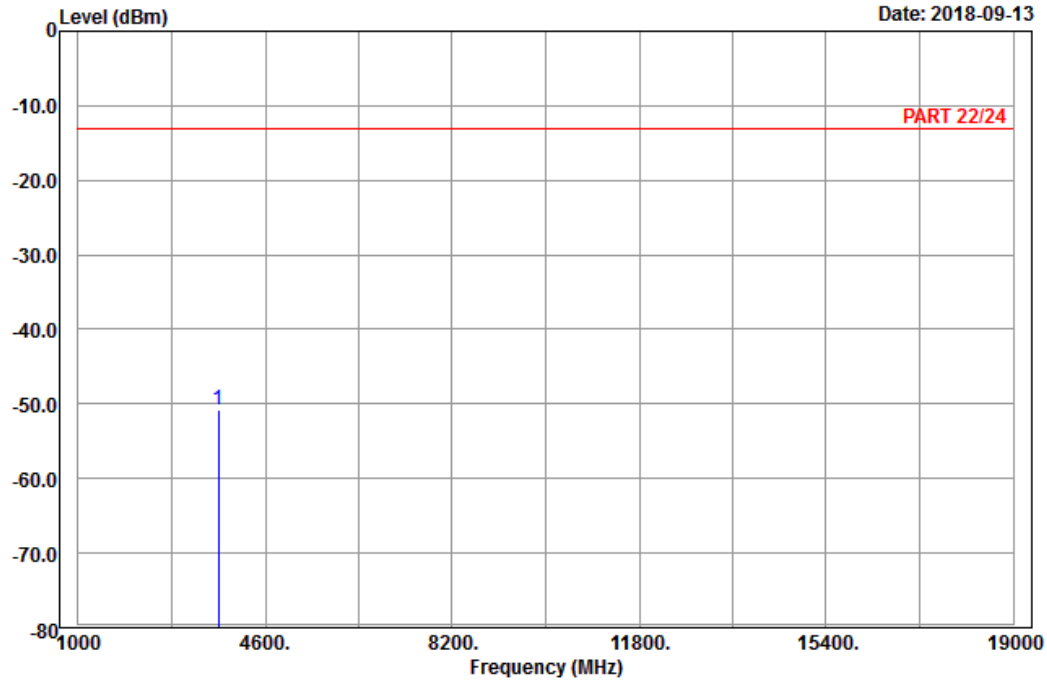

Site : 966 chamber 1
 Condition: PART 22/24 Vertical
 Remark : LTE_Band 2_Link_CH18625
 Tested by: Harry Hsueh

	Freq	Level	Read Level	Limit Line	Over Limit	Factor	Remark
	MHz	dBm	dBm	dBm	dB	dB	
1 pp	3705.00	-50.81	-66.69	-13.00	-37.81	15.88	Peak

Middle Channel



Bureau Veritas Consumer Products Services Ltd., Taoyuan Branch

A D T

Data: 9

Date: 2018-09-13

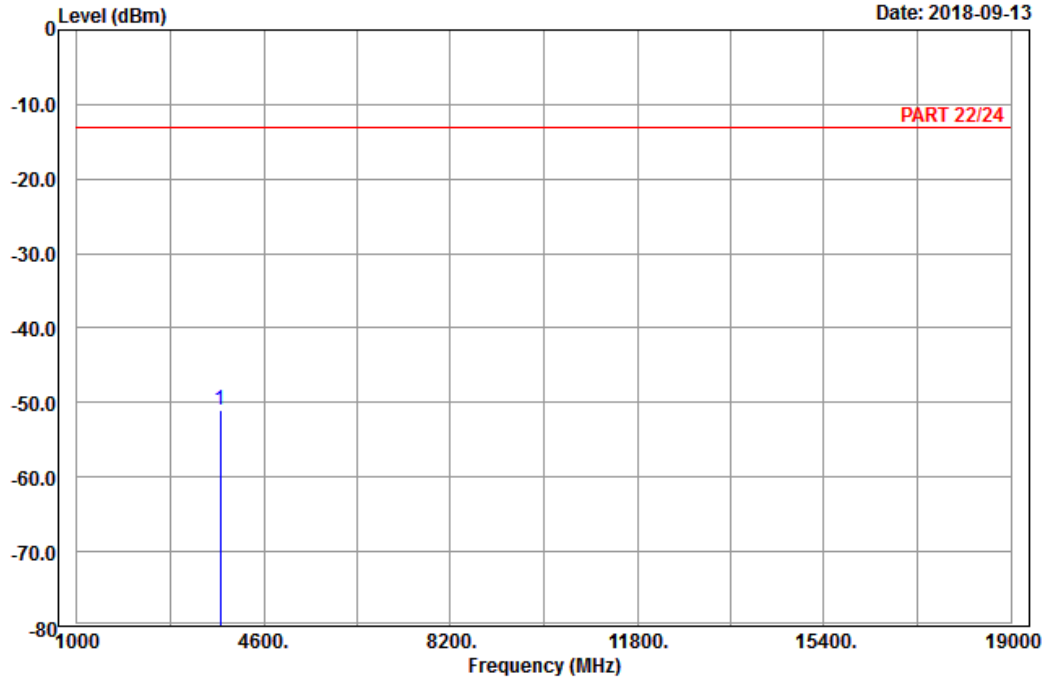

Site : 966 chamber 1
 Condition: PART 22/24 Horizontal
 Remark : LTE_Band 2_Link_CH18900
 Tested by: Harry Hsueh

	Read	Limit	Over			
Freq	Level	Level	Line	Limit	Factor	Remark
MHz	dBm	dBm	dBm	dB	dB	
1 pp 3760.00	-50.96	-67.10	-13.00	-37.96	16.14	Peak



Bureau Veritas Consumer Products Services Ltd., Taoyuan Branch

A D T

Data: 10

Date: 2018-09-13

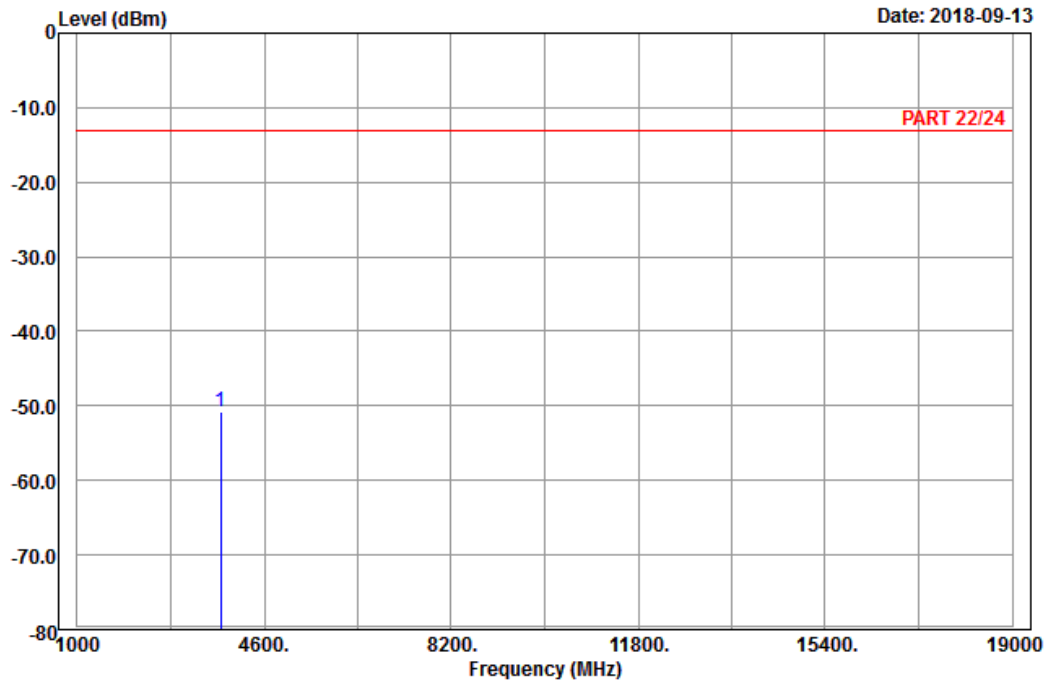

Site : 966 chamber 1
 Condition: PART 22/24 Vertical
 Remark : LTE_Band 2_Link_CH18900
 Tested by: Harry Hsueh

	Freq	Level	Read Level	Limit Line	Over Limit	Factor	Remark
	MHz	dBm	dBm	dBm	dB	dB	
1	pp 3760.00	-50.70	-66.84	-13.00	-37.70	16.14	Peak

High Channel



Bureau Veritas Consumer Products Services Ltd., Taoyuan Branch

A D T

Data: 9

Date: 2018-09-13

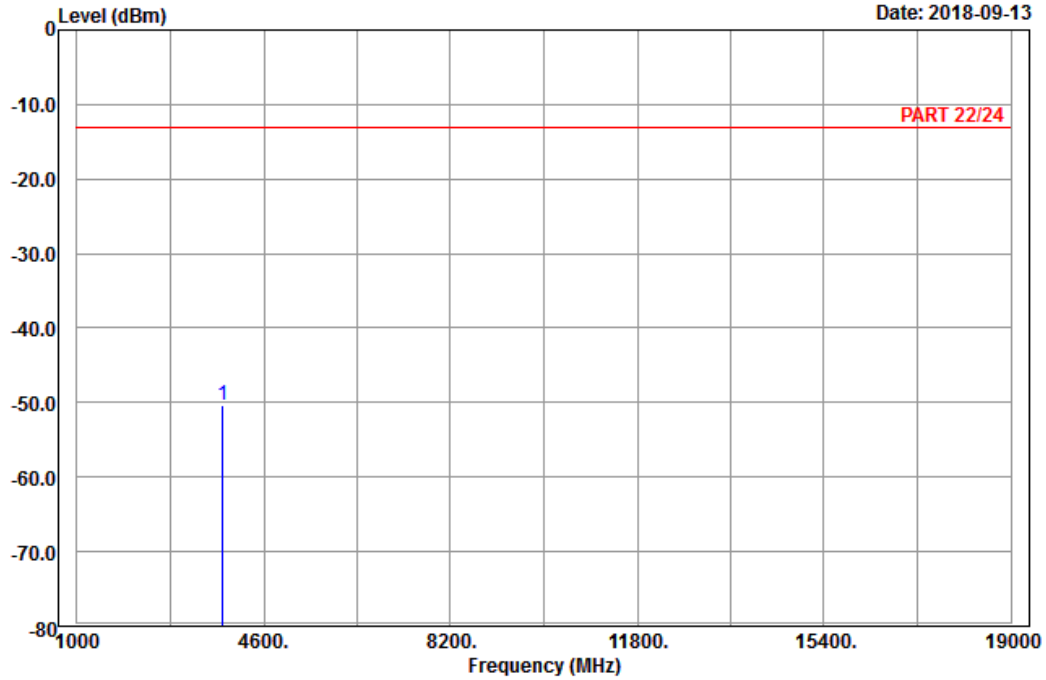

Site : 966 chamber 1
 Condition: PART 22/24 Horizontal
 Remark : LTE_Band 2_Link_CH19175
 Tested by: Harry Hsueh

	Read	Limit	Over			
Freq	Level	Level	Line	Limit	Factor	Remark
MHz	dBm	dBm	dBm	dB	dB	
1 pp 3815.00	-50.32	-66.73	-13.00	-37.32	16.41	Peak



Bureau Veritas Consumer Products Services Ltd., Taoyuan Branch

A D T

Data: 10

Date: 2018-09-13

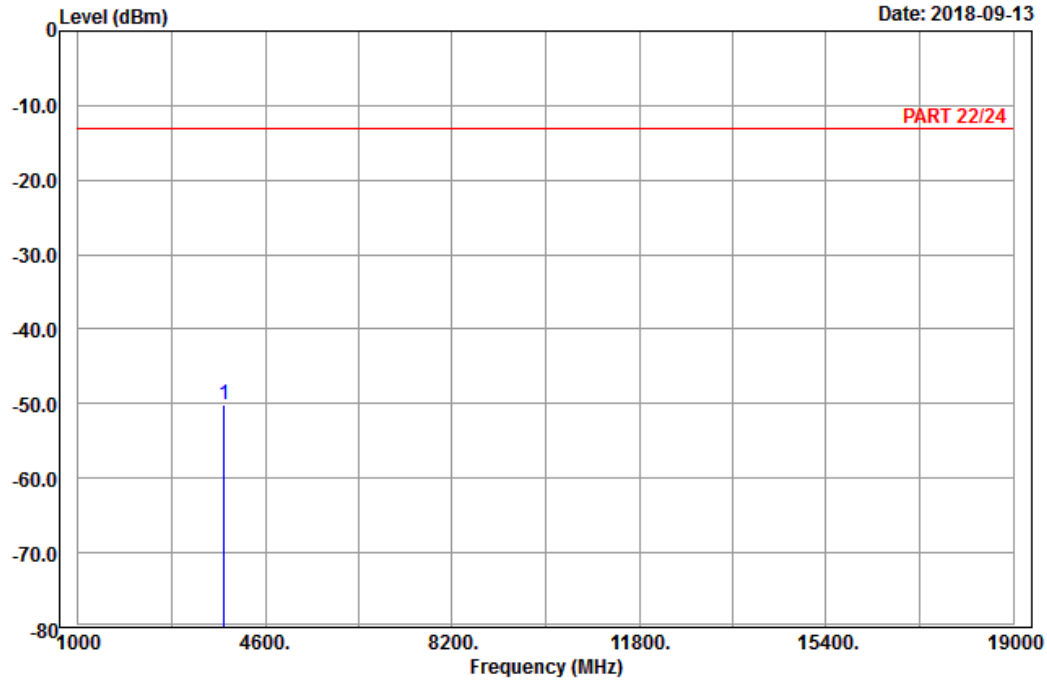

Site : 966 chamber 1
 Condition: PART 22/24 Vertical
 Remark : LTE_Band 2_Link_CH19175
 Tested by: Harry Hsueh

	Freq	Level	Read Level	Limit Line	Over Limit	Factor	Remark
	MHz	dBm	dBm	dBm	dB	dB	
1	pp 3815.00	-50.06	-66.47	-13.00	-37.06	16.41	Peak

Channel Bandwidth: 20 MHz / QPSK
Low Channel



Bureau Veritas Consumer Products Services Ltd., Taoyuan Branch

A D T

Data: 9

Date: 2018-09-13

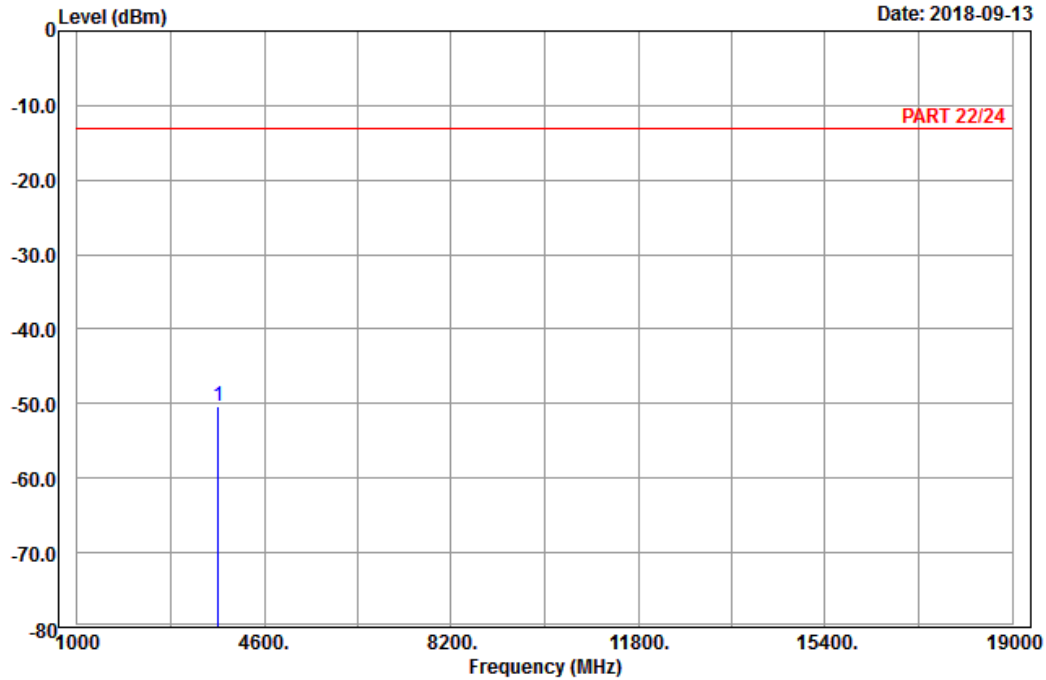

Site : 966 chamber 1
Condition: PART 22/24 Horizontal
Remark : LTE_Band 2_Link_CH18700
Tested by: Harry Hsueh

	Read	Limit	Over			
Freq	Level	Level	Line	Limit	Factor	Remark
MHz	dBm	dBm	dBm	dB	dB	
1 pp 3720.00	-50.29	-66.26	-13.00	-37.29	15.97	Peak



Bureau Veritas Consumer Products Services Ltd., Taoyuan Branch

A D T

Data: 10

Date: 2018-09-13

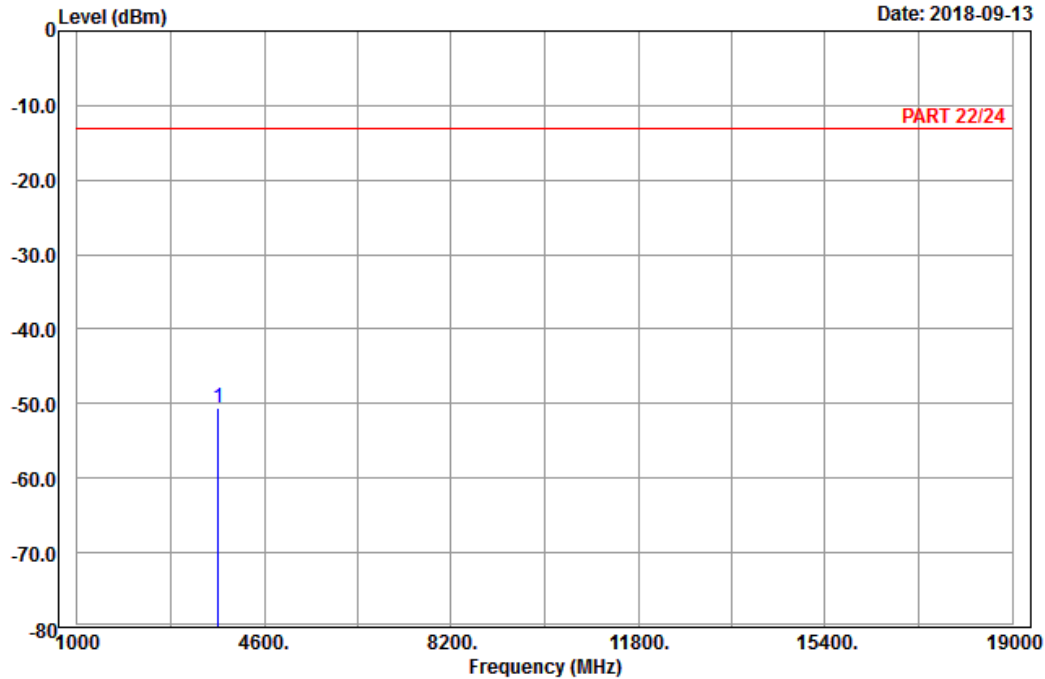

Site : 966 chamber 1
 Condition: PART 22/24 Vertical
 Remark : LTE_Band 2_Link_CH18700
 Tested by: Harry Hsueh

	Freq	Level	Read Level	Limit Line	Over Limit	Factor	Remark
	MHz	dBm	dBm	dBm	dB	dB	
1 pp	3720.00	-50.47	-66.44	-13.00	-37.47	15.97	Peak

Middle Channel



Bureau Veritas Consumer Products Services Ltd., Taoyuan Branch

A D T

Data: 9

Date: 2018-09-13

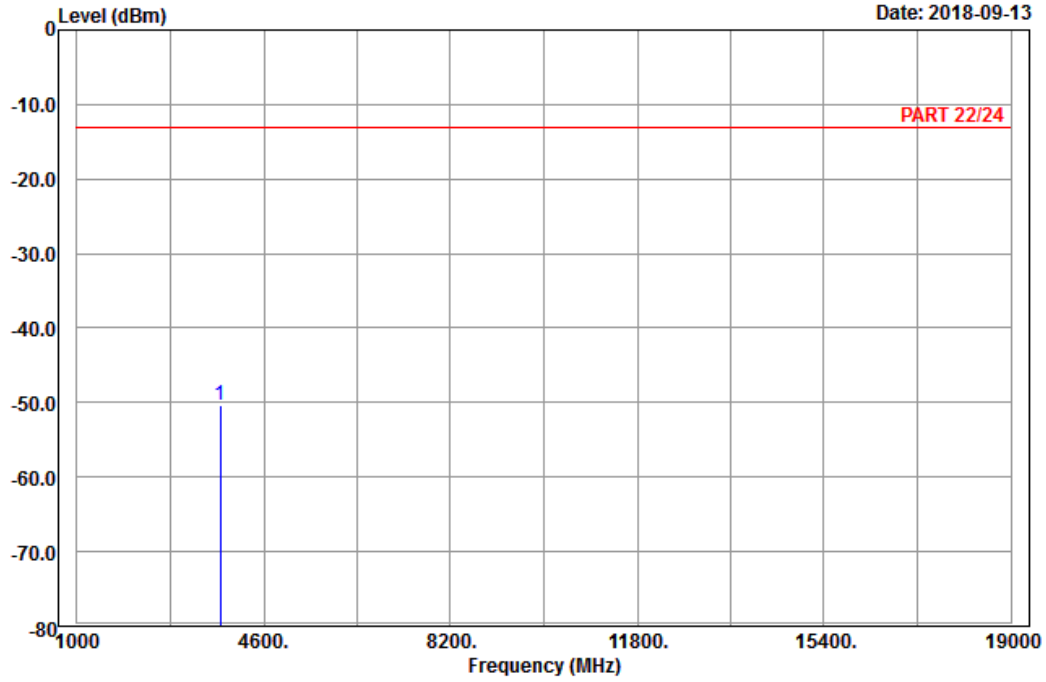

Site : 966 chamber 1
 Condition: PART 22/24 Horizontal
 Remark : LTE_Band 2_Link_CH18900
 Tested by: Harry Hsueh

Freq	Level	Read Level	Limit	Over	Factor	Remark
MHz	dBm	dBm	dBm	dB	dB	
1 pp 3760.00	-50.34	-66.48	-13.00	-37.34	16.14	Peak



A D T

Data: 10

Date: 2018-09-13

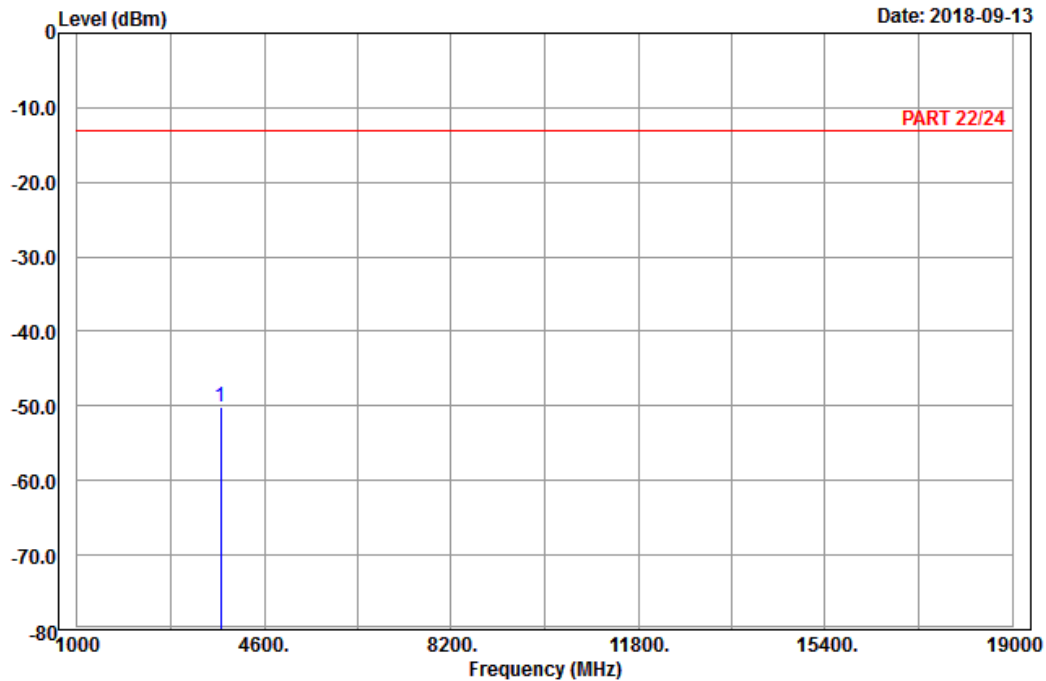

Site : 966 chamber 1
 Condition: PART 22/24 Vertical
 Remark : LTE_Band 2_Link_CH18900
 Tested by: Harry Hsueh

	Read	Limit	Over		
Freq	Level	Level	Line	Limit	Factor
MHz	dBm	dBm	dBm	dB	dB
1 pp 3760.00	-50.07	-66.21	-13.00	-37.07	16.14 Peak

High Channel



Bureau Veritas Consumer Products Services Ltd., Taoyuan Branch

A D T

Data: 13

Date: 2018-09-13

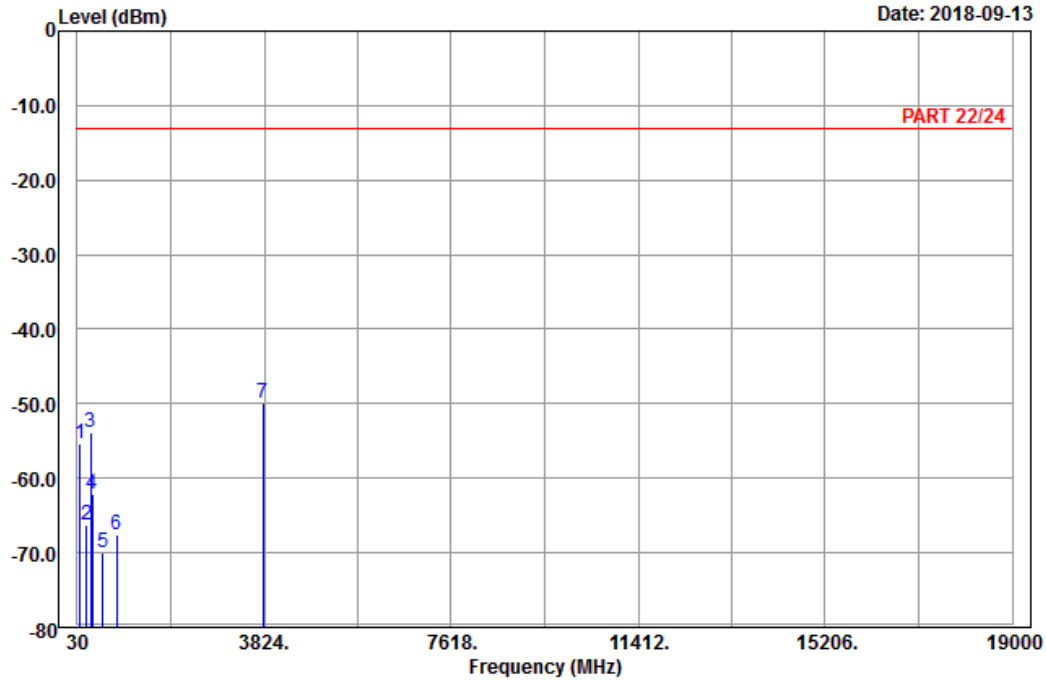

Site : 966 chamber 1
 Condition: PART 22/24 Horizontal
 Remark : LTE_Band 2_Link_CH19100
 Tested by: Harry Hsueh

	Freq	Level	Read Level	Limit	Over	Factor	Remark
	MHz	dBm	dBm	dBm	dB	dB	
1	88.59	-55.36	-44.47	-13.00	-42.36	-10.89	Peak
2	214.68	-66.24	-60.25	-13.00	-53.24	-5.99	Peak
3	300.00	-53.90	-47.94	-13.00	-40.90	-5.96	Peak
4	328.00	-62.16	-56.53	-13.00	-49.16	-5.63	Peak
5	542.90	-69.89	-67.73	-13.00	-56.89	-2.16	Peak
6	837.60	-67.64	-69.22	-13.00	-54.64	1.58	Peak
7 pp	3800.00	-49.97	-66.38	-13.00	-36.97	16.41	Peak



A D T

Data: 14

Date: 2018-09-13

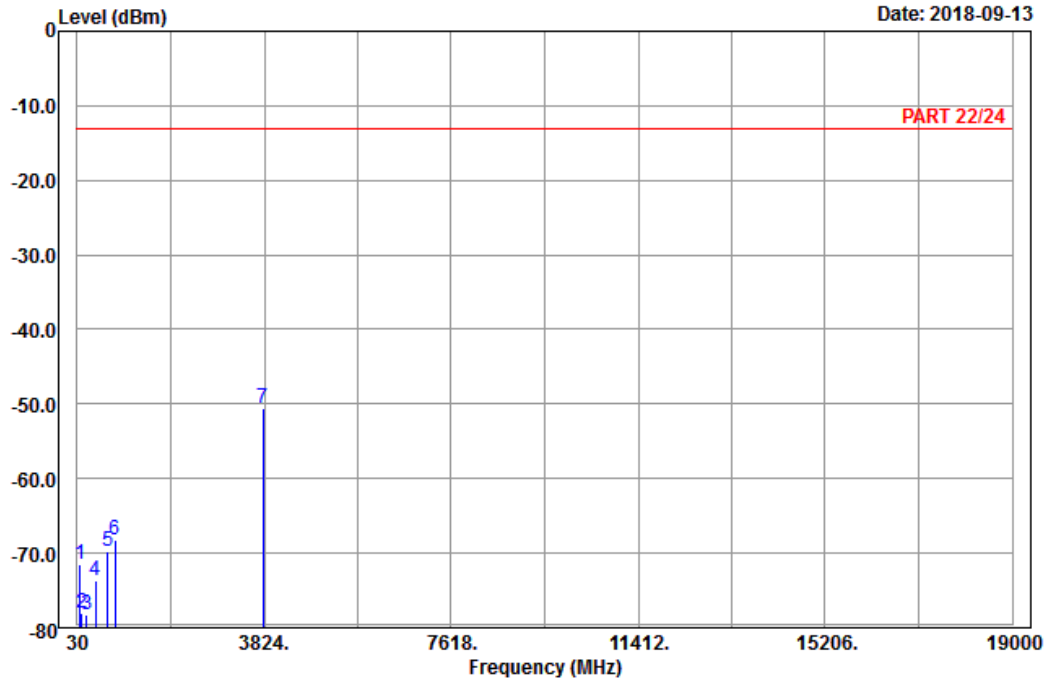

Site : 966 chamber 1
 Condition: PART 22/24 Vertical
 Remark : LTE_Band 2_Link_CH19100
 Tested by: Harry Hsueh

	Freq	Level	Read Level	Limit Line	Over Limit	Factor	Remark
	MHz	dBm	dBm	dBm	dB	dB	
1	85.35	-71.39	-60.17	-13.00	-58.39	-11.22	Peak
2	128.28	-78.04	-70.27	-13.00	-65.04	-7.77	Peak
3	220.89	-78.36	-72.46	-13.00	-65.36	-5.90	Peak
4	397.30	-73.76	-70.92	-13.00	-60.76	-2.84	Peak
5	648.60	-69.69	-69.57	-13.00	-56.69	-0.12	Peak
6	791.40	-68.24	-69.68	-13.00	-55.24	1.44	Peak
7 pp	3800.00	-50.47	-66.88	-13.00	-37.47	16.41	Peak

5 Pictures of Test Arrangements

Please refer to the attached file (Test Setup Photo).

Appendix – Information on the Testing Laboratories

We, Bureau Veritas Consumer Products Services (H.K.) Ltd., Taoyuan Branch, were founded in 1988 to provide our best service in EMC, Radio, Telecom and Safety consultation. Our laboratories are FCC recognized accredited test firms and accredited according to ISO/IEC 17025.

If you have any comments, please feel free to contact us at the following:

Linko EMC/RF Lab

Tel: 886-2-26052180

Fax: 886-2-26051924

Hsin Chu EMC/RF/Telecom Lab

Tel: 886-3-6668565

Fax: 886-3-6668323

Hwa Ya EMC/RF/Safety

Tel: 886-3-3183232

Fax: 886-3-3270892

Email: service.adt@tw.bureauveritas.com

Web Site: www.bureauveritas-adt.com

The address and road map of all our labs can be found in our web site also.

--- END ---