

## FCC Test Report

### (PART 22)

**Report No.:** RF180821C20-7

**FCC ID:** V65E6910

**Test Model:** E6910

**Received Date:** Aug. 21, 2018

**Test Date:** Sep. 12, 2018 ~ Sep. 14, 2018

**Issued Date:** Sep. 28, 2018

**Applicant:** Kyocera Corporation c/o Kyocera International, Inc.

**Address:** 8611 Balboa Avenue, San Diego, CA 92123

**Issued By:** Bureau Veritas Consumer Products Services (H.K.) Ltd., Taoyuan Branch

**Lab Address:** No. 47-2, 14th Ling, Chia Pau Vil., Lin Kou Dist., New Taipei City, Taiwan  
( R.O.C )

**Test Location (1):** No. 19, Hwa Ya 2nd Rd, Wen Hwa Vil, Kwei Shan Dist., Taoyuan City  
33383, Taiwan (R.O.C)

**Test Location (2):** No.215, Sec. 3, Beixin Rd., Xindian Dist., New Taipei City 231, Taiwan,  
R.O.C

**FCC Registration /  
Designation Number:** 427177 / TW0011



This report is for your exclusive use. Any copying or replication of this report to or for any other person or entity, or use of our name or trademark, is permitted only with our prior written permission. This report sets forth our findings solely with respect to the test samples identified herein. The results set forth in this report are not indicative or representative of the quality or characteristics of the lot from which a test sample was taken or any similar or identical product unless specifically and expressly noted. Our report includes all of the tests requested by you and the results thereof based upon the information that you provided to us. You have 60 days from date of issuance of this report to notify us of any material error or omission caused by our negligence, provided, however, that such notice shall be in writing and shall specifically address the issue you wish to raise. A failure to raise such issue within the prescribed time shall constitute your unqualified acceptance of the completeness of this report, the tests conducted and the correctness of the report contents. Unless specific mention, the uncertainty of measurement has been explicitly taken into account to declare the compliance or non-compliance to the specification. The report must not be used by the client to claim product certification, approval, or endorsement by TAF or any government agencies

## Table of Contents

<b>Release Control Record</b> .....	<b>4</b>
<b>1 Certificate of Conformity</b> .....	<b>5</b>
<b>2 Summary of Test Results</b> .....	<b>6</b>
2.1 Measurement Uncertainty .....	6
2.2 Test Site and Instruments .....	7
<b>3 General Information</b> .....	<b>8</b>
3.1 General Description of EUT .....	8
3.2 Configuration of System under Test .....	9
3.2.1 Description of Support Units .....	9
3.3 Test Mode Applicability and Tested Channel Detail .....	10
3.4 EUT Operating Conditions .....	13
3.5 General Description of Applied Standards .....	13
<b>4 Test Types and Results</b> .....	<b>14</b>
4.1 Output Power Measurement .....	14
4.1.1 Limits of Output Power Measurement .....	14
4.1.2 Test Procedures .....	14
4.1.3 Test Setup .....	15
4.1.4 Test Results .....	16
4.2 Modulation Characteristics Measurement .....	23
4.2.1 Limits of Modulation Characteristics .....	23
4.2.2 Test Setup .....	23
4.2.3 Test Procedure .....	23
4.2.4 Test Results .....	24
4.3 Frequency Stability Measurement .....	26
4.3.1 Limits of Frequency Stability Measurement .....	26
4.3.2 Test Procedure .....	26
4.3.3 Test Setup .....	26
4.3.4 Test Results .....	27
4.4 Occupied Bandwidth Measurement .....	34
4.4.1 Test Procedure .....	34
4.4.2 Test Setup .....	34
4.4.3 Test Result .....	35
4.5 Band Edge Measurement .....	38
4.5.1 Limits of Band Edge Measurement .....	38
4.5.2 Test Setup .....	38
4.5.3 Test Procedures .....	38
4.5.4 Test Results .....	39
4.6 Peak to Average Ratio .....	44
4.6.1 Limits of Peak to Average Ratio Measurement .....	44
4.6.2 Test Setup .....	44
4.6.3 Test Procedures .....	44
4.6.4 Test Results .....	45
4.7 Conducted Spurious Emissions .....	48
4.7.1 Limits of Conducted Spurious Emissions Measurement .....	48
4.7.2 Test Setup .....	48
4.7.3 Test Procedure .....	48
4.7.4 Test Results .....	49
4.8 Radiated Emission Measurement .....	56
4.8.1 Limits of Radiated Emission Measurement .....	56
4.8.2 Test Procedure .....	56
4.8.3 Deviation from Test Standard .....	56
4.8.4 Test Setup .....	57
4.8.5 Test Results .....	58

<b>5 Pictures of Test Arrangements.....</b>	<b>94</b>
<b>Appendix – Information on the Testing Laboratories .....</b>	<b>95</b>

### Release Control Record

Issue No.	Description	Date Issued
RF180821C20-7	Original Release	Sep. 28, 2018

## 1 Certificate of Conformity

**Product:** Smart Phone

**Brand:** Kyocera

**Test Model:** E6910

**Sample Status:** Identical Prototype

**Applicant:** Kyocera Corporation c/o Kyocera International, Inc.

**Test Date:** Sep. 12, 2018 ~ Sep. 14, 2018

**Standards:** FCC Part 22, Subpart H

The above equipment has been tested by **Bureau Veritas Consumer Products Services (H.K.) Ltd., Taoyuan Branch**, and found compliance with the requirement of the above standards. The test record, data evaluation & Equipment Under Test (EUT) configurations represented herein are true and accurate accounts of the measurements of the sample's RF characteristics under the conditions specified in this report.

**Prepared by :** , **Date:** Sep. 28, 2018  
Ivonne Wu / Supervisor

**Approved by :** , **Date:** Sep. 28, 2018  
Dylan Chiou / Project Engineer

## 2 Summary of Test Results

Applied Standard: FCC Part 22 & Part 2			
FCC Clause	Test Item	Result	Remarks
2.1046 22.913 (a)	Effective Radiated Power	Pass	Meet the requirement of limit.
2.1047	Modulation Characteristics	Pass	Meet the requirement.
---	Peak to Average Ratio	Pass	Meet the requirement of limit.
2.1055 22.355	Frequency Stability	Pass	Meet the requirement of limit.
2.1049	Occupied Bandwidth	Pass	Meet the requirement of limit.
22.917	Band Edge Measurements	Pass	Meet the requirement of limit.
2.1051 22.917	Conducted Spurious Emissions	Pass	Meet the requirement of limit.
2.1053 22.917	Radiated Spurious Emissions	Pass	Meet the requirement of limit. Minimum passing margin is -32.93 dB at 92.10 MHz.

### 2.1 Measurement Uncertainty

Where relevant, the following measurement uncertainty levels have been estimated for tests performed on the EUT as specified in CISPR 16-4-2:

Measurement	Frequency	Expanded Uncertainty (k=2) (±)
Radiated Emissions up to 1 GHz	30 MHz ~ 200 MHz	2.0153 dB
	200 MHz ~ 1000 MHz	2.0224 dB
Radiated Emissions above 1 GHz	1 GHz ~ 18 GHz	1.0121 dB
	18 GHz ~ 40 GHz	1.1508 dB

## 2.2 Test Site and Instruments

Description & Manufacturer	Model No.	Serial No.	Date of Calibration	Due Date of Calibration
Test Receiver Agilent Technologies	N9038A	MY52260177	Aug. 20, 2018	Aug. 19, 2019
Spectrum Analyzer ROHDE & SCHWARZ	FSU43	101261	Jan. 11, 2018	Jan. 10, 2019
HORN Antenna ETS-Lindgren	3117	00143293	Dec. 13, 2017	Dec. 12, 2018
BILOG Antenna SCHWARZBECK	VULB 9168	9168-616	Dec. 14, 2017	Dec. 13, 2018
HORN Antenna SCHWARZBECK	BBHA 9170	9170-480	Dec. 01, 2017	Nov. 30, 2018
HORN Antenna SCHWARZBECK	BBHA 9120D	9120D-969	Dec. 12, 2017	Dec. 11, 2018
Fixed Attenuator Woken	00801A1GGAM02Y	NA	May 17, 2018	May 16, 2019
MXG Vector signal generator Agilent	N5182B	MY53050430	Oct. 24, 2017	Oct. 23, 2018
Preamplifier Agilent	310N	187226	Jun. 19, 2018	Jun. 18, 2019
Preamplifier Agilent	83017A	MY39501357	Jun. 19, 2018	Jun. 18, 2019
RF signal cable ETS-LINDGREN	5D-FB	Cable-CH1-01(RF C-SMS-100-SMS- 120+RFC-SMS-1 00-SMS-400)	Jun. 19, 2018	Jun. 18, 2019
RF signal cable ETS-LINDGREN	8D-FB	Cable-CH1-02(RF C-SMS-100-SMS- 24)	Jun. 19, 2018	Jun. 18, 2019
Boresight Antenna Fixture	FBA-01	FBA-SIP01	NA	NA
Software BV ADT	E3 8.130425b	NA	NA	NA
Antenna Tower MF	NA	NA	NA	NA
Turn Table MF	NA	NA	NA	NA
Antenna Tower & Turn Table Controller MF	MF-7802	NA	NA	NA
Communications Tester-Wireless Agilent	8960 Series 10	MY53201073	Jun. 28, 2017	Jun. 27, 2019
Radio Communication Analyzer Anritsu	MT8820C	6201010284	Dec. 28, 2017	Dec. 27, 2018

- Note: 1. The calibration interval of the above test instruments is 12 / 24 months and the calibrations are traceable to NML/ROC and NIST/USA.
2. The test was performed in HsinTien Chamber 1.
3. The horn antenna and preamplifier (model: 83017A) are used only for the measurement of emission frequency above 1 GHz if tested.
4. The IC Site Registration No. is IC7450I-1.

### 3 General Information

#### 3.1 General Description of EUT

<b>Product</b>	Smart Phone	
<b>Brand</b>	Kyocera	
<b>Test Model</b>	E6910	
<b>Status of EUT</b>	Identical Prototype	
<b>Power Supply Rating</b>	3.8 Vdc (Battery) 5 Vdc or 9 Vdc or 12 Vdc (Adapter) 5 Vdc (Host equipment)	
<b>Modulation Type</b>	GSM/GPRS	GMSK
	EDGE	GMSK, 8PSK
	WCDMA	QPSK
	LTE	QPSK, 16QAM, 64QAM
<b>Frequency Range</b>	GSM/GPRS/EDGE	824.2 ~ 848.8 MHz
	WCDMA	826.4 ~ 846.6 MHz
	LTE 5 (Channel Bandwidth: 1.4 MHz)	824.7 ~ 848.3 MHz
	LTE 5 (Channel Bandwidth: 3 MHz)	825.5 ~ 847.5 MHz
	LTE 5 (Channel Bandwidth: 5 MHz)	826.5 ~ 846.5 MHz
	LTE 5 (Channel Bandwidth: 10 MHz)	829 ~ 844 MHz
<b>Max. ERP Power</b>	GSM/GPRS	812.83 mW
	EDGE	257.63 mW
	WCDMA	128.53 mW
	LTE 5 (Channel Bandwidth: 1.4 MHz)	142.50 mW
	LTE 5 (Channel Bandwidth: 3 MHz)	145.28 mW
	LTE 5 (Channel Bandwidth: 5 MHz)	149.28 mW
	LTE 5 (Channel Bandwidth: 10 MHz)	159.88 mW
<b>Emission Designator</b>	GSM/GPRS	243KGXW
	EDGE	246KG7W
	WCDMA	4M15F9W
	LTE 5 (Channel Bandwidth: 1.4 MHz)	1M09W7D
	LTE 5 (Channel Bandwidth: 3 MHz)	2M70G7D
	LTE 5 (Channel Bandwidth: 5 MHz)	4M50W7D
	LTE 5 (Channel Bandwidth: 10 MHz)	8M98W7D
<b>Antenna Type</b>	Fixed Internal Antenna with -1.1 dBi gain	
<b>Accessory Device</b>	Refer to Note as below	
<b>Data Cable Supplied</b>	Refer to Note as below	

Note:

1. The EUT's accessories list refers to Ext. Pho.
2. The above EUT information is declared by manufacturer and for more detailed features description, please refers to the manufacturer's specifications or user's manual.



### 3.2 Configuration of System under Test

#### <Radiated Emission Test>

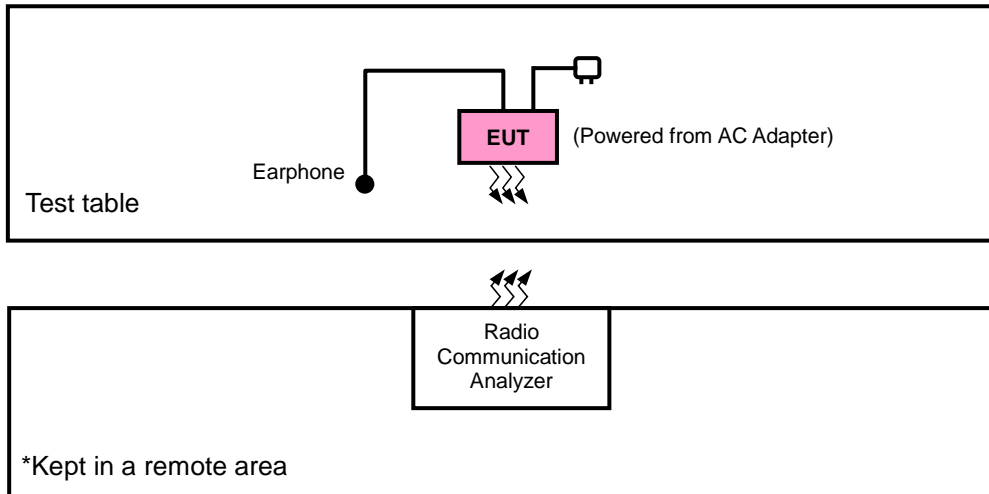

#### <E.R.P. Test>

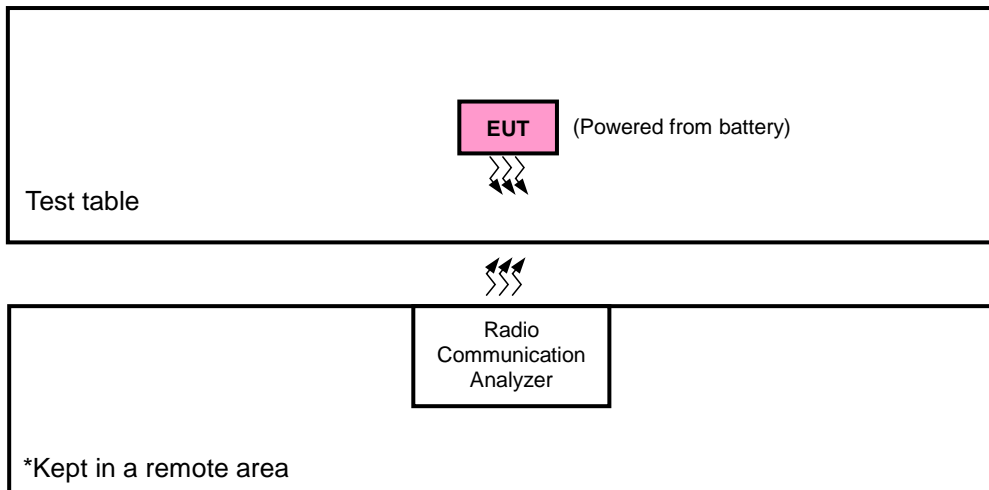

#### 3.2.1 Description of Support Units

The EUT has been tested as an independent unit together with other necessary accessories or support units. The following support units or accessories were used to form a representative test configuration during the tests.

No.	Product	Brand	Model No.	Serial No.	FCC ID
1.	Earphone	Funkey	FK130102	N/A	N/A

No.	Signal Cable Description Of The Above Support Units
1.	N/A

Note:

1. All power cords of the above support units are non-shielded (1.8m).

### 3.3 Test Mode Applicability and Tested Channel Detail

Pre-Scan has been conducted to determine the worst-case mode from all possible combinations between available modulations, data rates, XYZ axis, and antenna ports.

The worst case was found when positioned as the table below. Following channel(s) was (were) selected for the final test as listed below:

Band	ERP	Radiated Emission
GSM	Z-plane	Z-axis
EDGE	Z-plane	Z-axis
WCDMA	Z-plane	Z-axis
LTE Band 5	Z-plane	Y-axis

#### GSM

EUT Configure Mode	Test Item	Available Channel	Tested Channel	Mode
-	ERP	128 to 251	128, 189, 251	GSM, EDGE
-	Modulation Characteristics	128 to 251	189	GSM, EDGE
-	Frequency Stability	128 to 251	128, 251	GSM, EDGE
-	Occupied Bandwidth	128 to 251	128, 189, 251	GSM, EDGE
-	Band Edge	128 to 251	128, 251	GSM, EDGE
-	Peak to Average Ratio	128 to 251	128, 189, 251	GSM, EDGE
-	Conducted Emission	128 to 251	128, 189, 251	GSM, EDGE
-	Radiated Emission	128 to 251	128, 189, 251	GSM, EDGE

#### WCDMA

EUT Configure Mode	Test Item	Available Channel	Tested Channel	Mode
-	ERP	4132 to 4233	4132, 4182, 4233	WCDMA
-	Modulation Characteristics	4132 to 4233	4182	WCDMA
-	Frequency Stability	4132 to 4233	4132, 4233	WCDMA
-	Occupied Bandwidth	4132 to 4233	4132, 4182, 4233	WCDMA
-	Band Edge	4132 to 4233	4132, 4233	WCDMA
-	Peak to Average Ratio	4132 to 4233	4132, 4182, 4233	WCDMA
-	Conducted Emission	4132 to 4233	4132, 4182, 4233	WCDMA
-	Radiated Emission	4132 to 4233	4132, 4182, 4233	WCDMA

### LTE Band 5

EUT Configure Mode	Test Item	Available Channel	Tested Channel	Channel Bandwidth	Modulation	Mode
-	ERP	20407 to 20643	20407, 20525, 20643	1.4 MHz	QPSK, 16QAM, 64QAM	1 RB / 0 RB Offset
		20415 to 20635	20415, 20525, 20635	3 MHz	QPSK, 16QAM, 64QAM	1 RB / 0 RB Offset
		20425 to 20625	20425, 20525, 20625	5 MHz	QPSK, 16QAM, 64QAM	1 RB / 0 RB Offset
		20450 to 20600	20450, 20525, 20600	10 MHz	QPSK, 16QAM, 64QAM	1 RB / 0 RB Offset
-	Modulation Characteristics	20450 to 20600	20525	10 MHz	QPSK, 16QAM, 64QAM	1 RB / 0 RB Offset
-	Frequency Stability	20407 to 20643	20407, 20643	1.4 MHz	QPSK	1 RB / 0 RB Offset
		20415 to 20635	20415, 20635	3 MHz	QPSK	1 RB / 0 RB Offset
		20425 to 20625	20425, 20625	5 MHz	QPSK	1 RB / 0 RB Offset
		20450 to 20600	20450, 20600	10 MHz	QPSK	1 RB / 0 RB Offset
-	Occupied Bandwidth	20407 to 20643	20407, 20525, 20643	1.4 MHz	QPSK, 16QAM, 64QAM	6 RB / 0 RB Offset
		20415 to 20635	20415, 20525, 20635	3 MHz	QPSK, 16QAM, 64QAM	15 RB / 0 RB Offset
		20425 to 20625	20425, 20525, 20625	5 MHz	QPSK, 16QAM, 64QAM	25 RB / 0 RB Offset
		20450 to 20600	20450, 20525, 20600	10 MHz	QPSK, 16QAM, 64QAM	50 RB / 0 RB Offset
-	Band Edge	20407 to 20643	20407	1.4MHz	QPSK	1 RB / 0 RB Offset 6 RB / 0 RB Offset
			20643	1.4MHz	QPSK	1 RB / 5 RB Offset 6 RB / 0 RB Offset
		20415 to 20635	20415	3 MHz	QPSK	1 RB / 0 RB Offset 15 RB / 0 RB Offset
			20635	3 MHz	QPSK	1 RB / 14 RB Offset 15 RB / 0 RB Offset
		20425 to 20625	20425	5 MHz	QPSK	1 RB / 0 RB Offset 25 RB / 0 RB Offset
			20625	5 MHz	QPSK	1 RB / 24 RB Offset 25 RB / 0 RB Offset
		20450 to 20600	20450	10 MHz	QPSK	1 RB / 0 RB Offset 50 RB / 0 RB Offset
			20600	10 MHz	QPSK	1 RB / 49 RB Offset 50 RB / 0 RB Offset

EUT Configure Mode	Test Item	Available Channel	Tested Channel	Channel Bandwidth	Modulation	Mode
-	Peak to Average Ratio	20407 to 20643	20407, 20525, 20643	1.4 MHz	QPSK, 16QAM, 64QAM	1 RB / 0 RB Offset
		20415 to 20635	20415, 20525, 20635	3 MHz	QPSK, 16QAM, 64QAM	1 RB / 0 RB Offset
		20425 to 20625	20425, 20525, 20625	5 MHz	QPSK, 16QAM, 64QAM	1 RB / 0 RB Offset
		20450 to 20600	20450, 20525, 20600	10 MHz	QPSK, 16QAM, 64QAM	1 RB / 0 RB Offset
-	Conducted Emission	20407 to 20643	20407, 20525, 20643	1.4 MHz	QPSK	1 RB / 0 RB Offset
		20415 to 20635	20415, 20525, 20635	3 MHz	QPSK	1 RB / 0 RB Offset
		20425 to 20625	20425, 20525, 20625	5 MHz	QPSK	1 RB / 0 RB Offset
		20450 to 20600	20450, 20525, 20600	10 MHz	QPSK	1 RB / 0 RB Offset
-	Radiated Emission	20407 to 20643	20407, 20525, 20643	1.4 MHz	QPSK	1 RB / 0 RB Offset
		20425 to 20625	20425, 20525, 20625	5 MHz	QPSK	1 RB / 0 RB Offset
		20450 to 20600	20450, 20525, 20600	10 MHz	QPSK	1 RB / 0 RB Offset

**Note:** This device was tested under all bandwidths, RB configurations and modulations. The worst case was found in QPSK modulation.

**Test Condition:**

Test Item	Environmental Conditions	Input Power	Tested By
ERP	25 deg. C, 65 % RH	3.8 Vdc	Karl Lee
Modulation Characteristics	25 deg. C, 65 % RH	3.8 Vdc	Wayne Lin
Frequency Stability	25 deg. C, 65 % RH	3.8 Vdc	Wayne Lin
Occupied Bandwidth	25 deg. C, 65 % RH	3.8 Vdc	Wayne Lin
Band Edge	25 deg. C, 65 % RH	3.8 Vdc	Wayne Lin
Peak to Average Ratio	25 deg. C, 65 % RH	3.8 Vdc	Wayne Lin
Conducted Emission	25 deg. C, 65 % RH	3.8 Vdc	Wayne Lin
Radiated Emission	25 deg. C, 65 % RH	120 Vac, 60 Hz	Karl Lee / Charles Hsiao / Harry Hsueh

### **3.4 EUT Operating Conditions**

The EUT makes a call to the communication simulator. The communication simulator station system controlled a EUT to export maximum output power under transmission mode and specific channel frequency.

### **3.5 General Description of Applied Standards**

The EUT is a RF Product. According to the specifications of the manufacturer, it must comply with the requirements of the following standards:

**FCC 47 CFR Part 2**

**FCC 47 CFR Part 22**

**KDB 971168 D01 Power Meas License Digital Systems v03r01**

**ANSI/TIA/EIA-603-E 2016**

**ANSI 63.26-2015**

**Note:** All test items have been performed and recorded as per the above standards.

## 4 Test Types and Results

### 4.1 Output Power Measurement

#### 4.1.1 Limits of Output Power Measurement

Mobile / Portable station are limited to 7 watts e.r.p.

#### 4.1.2 Test Procedures

##### **EIRP / ERP Measurement:**

- a. All measurements were done at low, middle and high operational frequency range. RBW and VBW is 1 MHz for GSM, GPRS & EDGE, 5 MHz for WCDMA, and 10 MHz for LTE mode.
- b. Substitution method is used for E.I.R.P measurement. In the semi-anechoic chamber, EUT placed on the 0.8 m (below or equal 1 GHz) and/or 1.5 m (above 1 GHz) height of Turn Table, rotated the table around 360 degrees to search the maximum radiation power and receiver antenna shall be rotated vertical and horizontal polarization and moved height from 1 m to 4 m to find the maximum polar radiated power. The "Read Value" is the spectrum reading the maximum power value.
- c. The substitution horn antenna is substituted for EUT at the same position and signals generator export the CW signal to the substitution antenna via a tx cable. Rotated the Turn Table and moved receiving antenna to find the maximum radiation power. Adjust output power level of S.G to get a Value of spectrum reading equal to "Read Value" of step b. Record the power level of S.G.
- d.  $EIRP = \text{Output power level of S.G} - \text{TX cable loss} + \text{Antenna gain of substitution horn}$ . E.R.P power can be calculated form E.I.R.P power by subtracting the gain of dipole,  $E.R.P \text{ power} = E.I.R.P \text{ power} - 2.15 \text{ dB}$ .

##### **Conducted Power Measurement:**

The EUT was set up for the maximum power with GSM, GPRS, EDGE, WCDMA, and LTE link data modulation and link up with simulator. Set the EUT to transmit under low, middle and high channel and record the power level shown on simulator.

4.1.3 Test Setup

**EIRP / ERP Measurement:**

**<Radiated Emission below or equal 1 GHz>**

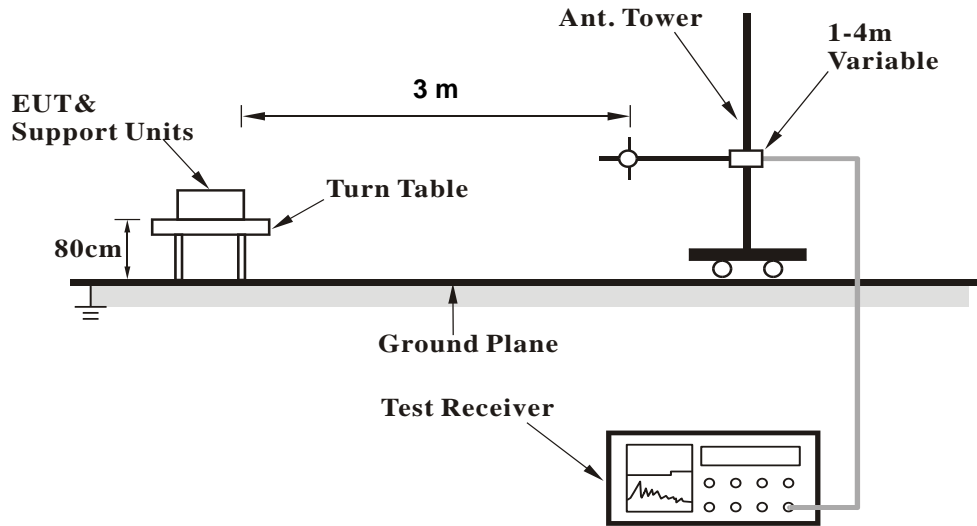

**<Radiated Emission above 1 GHz>**

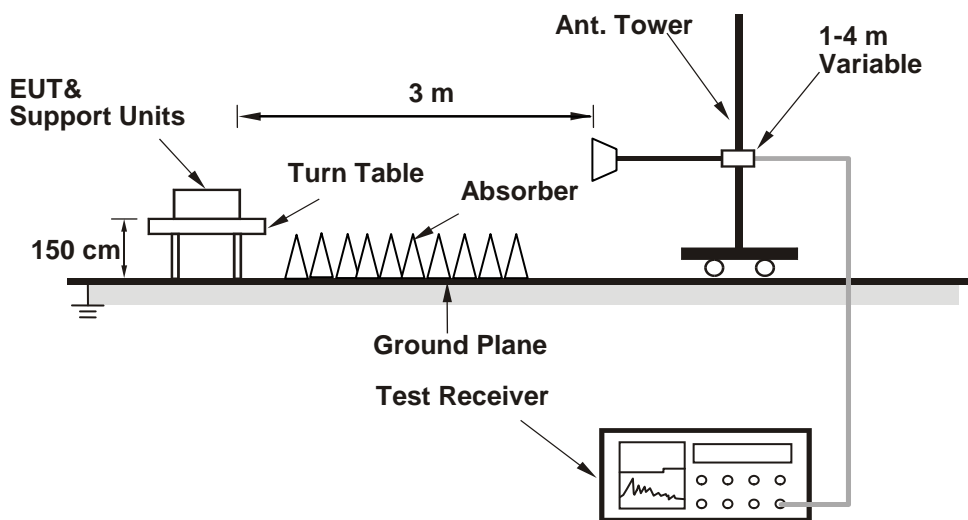

For the actual test configuration, please refer to the attached file (Test Setup Photo).

**Conducted Power Measurement:**

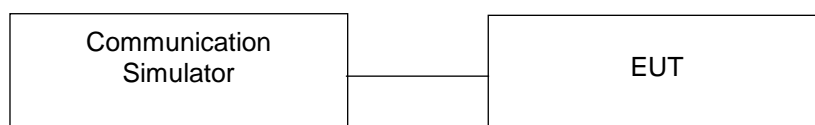

#### 4.1.4 Test Results

##### Conducted Output Power (dBm)

Band	GSM850		
Channel	128	189	251
Frequency (MHz)	824.2	836.4	848.8
GSM (GMSK, 1Tx-slot)	32.02	32.21	32.33
GPRS (GMSK, 1Tx-slot)	32.03	32.21	32.37
GPRS (GMSK, 2Tx-slot)	29.16	29.46	29.64
GPRS (GMSK, 3Tx-slot)	27.15	27.45	27.65
GPRS (GMSK, 4Tx-slot)	26.11	26.31	26.29
EDGE (8PSK, 1Tx-slot)	26.02	26.01	26.05
EDGE (8PSK, 2Tx-slot)	23.26	23.27	23.36
EDGE (8PSK, 3Tx-slot)	21.21	21.60	21.82
EDGE (8PSK, 4Tx-slot)	20.24	20.75	20.91

Band	WCDMA V		
Channel	4132	4182	4233
Frequency (MHz)	826.4	836.4	846.6
RMC 12.2K	23.51	23.62	23.56
HSDPA Subtest-1	22.30	22.46	22.36
HSDPA Subtest-2	22.36	21.95	21.87
HSDPA Subtest-3	21.81	22.47	22.38
HSDPA Subtest-4	21.89	22.45	22.32
HSUPA Subtest-1	22.40	22.48	22.39
HSUPA Subtest-2	20.42	20.49	20.39
HSUPA Subtest-3	21.37	21.56	21.32
HSUPA Subtest-4	20.36	20.51	20.41
HSUPA Subtest-5	22.41	22.50	22.40



**LTE Band 5**

BW	MCS Index	RB Size	RB Offset	Low	Mid	High	3GPP MPR (dB)	BW	MCS Index	RB Size	RB Offset	Low	Mid	High	3GPP MPR (dB)		
				20450	20525	20600						20425	20525	20625			
				Channel Frequency (MHz)	829.0	836.5						844.0	Channel Frequency (MHz)	826.5		836.5	846.5
10M	QPSK	1	0	24.35	24.47	24.42	0	5M	QPSK	1	0	24.29	24.38	24.33	0		
		1	24	24.27	24.32	24.34	0			1	12	24.37	24.46	24.36	0		
		1	49	24.26	24.31	24.33	0			1	24	24.32	24.46	24.35	0		
		25	0	23.34	23.38	23.31	1			12	0	23.40	23.46	23.35	1		
		25	12	23.28	23.36	23.35	1			12	6	23.31	23.48	23.35	1		
		25	25	23.20	23.32	23.27	1			12	13	23.26	23.34	23.27	1		
		50	0	23.22	23.34	23.29	1			25	0	23.26	23.40	23.34	1		
	16QAM	1	0	23.28	23.43	23.34	1		16QAM	1	0	23.24	23.37	23.28	1		
		1	24	23.37	23.44	23.42	1			1	12	23.30	23.45	23.35	1		
		1	49	23.31	23.45	23.35	1			1	24	23.26	23.44	23.28	1		
		25	0	22.41	22.36	22.35	2			12	0	22.35	22.41	22.38	2		
		25	12	22.33	22.45	22.37	2			12	6	22.33	22.34	22.27	2		
		25	25	22.27	22.42	22.33	2			12	13	22.17	22.35	22.26	2		
		50	0	22.23	22.41	22.33	2			25	0	22.24	22.34	22.29	2		
	64QAM	1	0	22.27	22.42	22.41	2		64QAM	1	0	22.28	22.42	22.28	2		
		1	24	22.37	22.49	22.41	2			1	12	22.24	22.37	22.39	2		
		1	49	22.28	22.46	22.37	2			1	24	22.20	22.31	22.29	2		
		25	0	21.42	21.41	21.34	3			12	0	21.36	21.38	21.35	3		
		25	12	21.29	21.38	21.44	3			12	6	21.28	21.38	21.36	3		
		25	25	21.25	21.39	21.32	3			12	13	21.28	21.28	21.31	3		
		50	0	21.29	21.38	21.38	3			25	0	21.24	21.34	21.32	3		
	3M	3M	3M	3M	3M	3M	3M		3M	3M	3M	3M	3M	3M	3M	3M	3M
	BW	MCS Index	RB Size	RB Offset	Low	Mid	High		3GPP MPR (dB)	BW	MCS Index	RB Size	RB Offset	Low	Mid	High	3GPP MPR (dB)
					20415	20525	20635							20407	20525	20643	
Channel Frequency (MHz)					825.5	836.5	847.5	Channel Frequency (MHz)						824.7	836.5	848.3	
3M	QPSK	1	0	24.22	24.39	24.28	0	1.4M	QPSK	1	0	24.23	24.41	24.18	0		
		1	7	24.32	24.34	24.35	0			1	2	24.17	24.36	24.15	0		
		1	14	24.21	24.31	24.18	0			1	5	24.12	24.32	24.09	0		
		8	0	23.37	23.29	23.19	1			3	0	24.02	24.21	24.03	0		
		8	3	23.18	23.37	23.28	1			3	1	24.10	24.30	24.05	0		
		8	7	23.21	23.35	23.21	1			3	3	24.00	24.17	24.00	0		
		15	0	23.16	23.36	23.26	1			6	0	23.21	23.35	23.14	1		
	16QAM	1	0	23.33	23.27	23.20	1		16QAM	1	0	23.27	23.46	23.21	1		
		1	7	23.22	23.26	23.32	1			1	2	23.22	23.41	23.14	1		
		1	14	23.21	23.24	23.25	1			1	5	23.14	23.37	23.09	1		
		8	0	22.23	22.30	22.16	2			3	0	23.01	23.25	23.05	1		
		8	3	22.12	22.33	22.37	2			3	1	23.22	23.34	23.04	1		
		8	7	22.07	22.18	22.13	2			3	3	23.01	23.20	23.01	1		
		15	0	22.16	22.32	22.21	2			6	0	22.18	22.31	22.09	2		
	64QAM	1	0	22.24	22.39	22.25	2		64QAM	1	0	22.16	22.28	22.22	2		
		1	7	22.08	22.34	22.16	2			1	2	22.06	22.43	22.15	2		
		1	14	22.25	22.22	22.27	2			1	5	22.11	22.31	22.16	2		
		8	0	21.18	21.36	21.34	3			3	0	22.15	22.14	22.14	2		
		8	3	21.12	21.22	21.17	3			3	1	22.10	22.18	22.25	2		
		8	7	21.08	21.28	21.10	3			3	3	22.26	22.11	22.08	2		
		15	0	21.20	21.18	21.21	3			6	0	21.15	21.32	21.24	3		

**ERP Power (dBm)**

GSM							
Plane	Channel	Frequency (MHz)	Reading (dBm)	Correction Factor (dB)	ERP (dBm)	ERP (mW)	Polarization (H/V)
Z	128	824.2	0.00	31.208	29.06	805.01	H
	189	836.4	-0.05	31.3	29.10	812.83	
	251	848.8	-0.06	31.222	29.01	796.53	
	128	824.2	-3.31	31.504	26.04	402.16	V
	189	836.4	-2.88	31.117	26.09	406.16	
	251	848.8	-3.75	31.922	26.02	400.13	

Note: ERP (dBm) = Reading (dBm) + Correction Factor (dB) – 2.15

EDGE							
Plane	Channel	Frequency (MHz)	Reading (dBm)	Correction Factor (dB)	ERP (dBm)	ERP (mW)	Polarization (H/V)
Z	128	824.2	-5.00	31.208	24.06	254.57	H
	189	836.4	-5.04	31.3	24.11	257.63	
	251	848.8	-5.06	31.222	24.01	251.88	
	128	824.2	-8.30	31.504	21.05	127.47	V
	189	836.4	-7.84	31.117	21.13	129.63	
	251	848.8	-8.74	31.922	21.03	126.82	

Note: ERP (dBm) = Reading (dBm) + Correction Factor (dB) – 2.15

WCDMA							
Plane	Channel	Frequency (MHz)	Reading (dBm)	Correction Factor (dB)	ERP (dBm)	ERP (mW)	Polarization (H/V)
Z	4132	826.4	-8.00	31.208	21.06	127.59	H
	4182	836.4	-8.06	31.3	21.09	128.53	
	4233	846.6	-8.06	31.222	21.01	126.24	
	4132	826.4	-11.30	31.504	18.05	63.89	V
	4182	836.4	-10.90	31.117	18.07	64.08	
	4233	846.6	-11.80	31.922	17.97	62.69	

Note: ERP (dBm) = Reading (dBm) + Correction Factor (dB) – 2.15

LTE Band 5							
Channel Bandwidth: 1.4 MHz / QPSK							
Plane	Channel	Frequency (MHz)	Reading (dBm)	Correction Factor (dB)	ERP (dBm)	ERP (mW)	Polarization (H/V)
Z	20407	824.7	-7.52	31.208	21.54	142.50	H
	20525	836.5	-7.62	31.3	21.53	142.23	
	20643	848.3	-7.58	31.222	21.49	140.99	
	20407	824.7	-11.55	31.504	17.80	60.31	V
	20525	836.5	-11.60	31.117	17.37	54.54	
	20643	848.3	-12.01	31.922	17.76	59.73	
Channel Bandwidth: 1.4 MHz / 16QAM							
Z	20407	824.7	-8.66	31.208	20.40	109.70	H
	20525	836.5	-8.45	31.3	20.70	117.49	
	20643	848.3	-8.62	31.222	20.45	110.97	
	20407	824.7	-13.23	31.504	16.12	40.96	V
	20525	836.5	-12.89	31.117	16.08	40.52	
	20643	848.3	-13.45	31.922	16.32	42.87	
Channel Bandwidth: 1.4 MHz / 64QAM							
Z	20407	824.7	-9.85	31.208	19.21	83.33	H
	20525	836.5	-9.45	31.3	19.70	93.33	
	20643	848.3	-9.22	31.222	19.85	96.65	
	20407	824.7	-13.01	31.504	16.34	43.09	V
	20525	836.5	-12.56	31.117	16.41	43.72	
	20643	848.3	-13.11	31.922	16.66	46.37	

Note: ERP (dBm) = Reading (dBm) + Correction Factor (dB) – 2.15

LTE Band 5							
Channel Bandwidth: 3 MHz / QPSK							
Plane	Channel	Frequency (MHz)	Reading (dBm)	Correction Factor (dB)	ERP (dBm)	ERP (mW)	Polarization (H/V)
Z	20415	825.5	-7.96	31.208	21.10	128.77	H
	20525	836.5	-7.65	31.3	21.50	141.25	
	20635	847.5	-7.45	31.222	21.62	145.28	
	20415	825.5	-11.55	31.504	17.80	60.31	V
	20525	836.5	-11.01	31.117	17.96	62.47	
	20635	847.5	-11.85	31.922	17.92	61.97	
Channel Bandwidth: 3 MHz / 16QAM							
Z	20415	825.5	-8.69	31.208	20.37	108.84	H
	20525	836.5	-8.74	31.3	20.41	109.90	
	20635	847.5	-8.23	31.222	20.84	121.39	
	20415	825.5	-12.61	31.504	16.74	47.23	V
	20525	836.5	-12.45	31.117	16.52	44.84	
	20635	847.5	-13.55	31.922	16.22	41.90	
Channel Bandwidth: 3 MHz / 64QAM							
Z	20415	825.5	-9.62	31.208	19.44	87.86	H
	20525	836.5	-9.70	31.3	19.45	88.10	
	20635	847.5	-9.86	31.222	19.21	83.41	
	20415	825.5	-12.52	31.504	16.83	48.24	V
	20525	836.5	-12.79	31.117	16.18	41.47	
	20635	847.5	-13.23	31.922	16.54	45.10	

Note: ERP (dBm) = Reading (dBm) + Correction Factor (dB) – 2.15

LTE Band 5							
Channel Bandwidth: 5 MHz / QPSK							
Plane	Channel	Frequency (MHz)	Reading (dBm)	Correction Factor (dB)	ERP (dBm)	ERP (mW)	Polarization (H/V)
Z	20425	826.5	-7.56	31.208	21.50	141.19	H
	20525	836.5	-7.41	31.3	21.74	149.28	
	20625	846.5	-7.91	31.222	21.16	130.68	
	20425	826.5	-11.80	31.504	17.55	56.94	V
	20525	836.5	-11.95	31.117	17.02	50.32	
	20625	846.5	-11.96	31.922	17.81	60.42	
Channel Bandwidth: 5 MHz / 16QAM							
Z	20425	826.5	-8.56	31.208	20.50	112.15	H
	20525	836.5	-8.95	31.3	20.20	104.71	
	20625	846.5	-8.55	31.222	20.52	112.77	
	20425	826.5	-12.56	31.504	16.79	47.80	V
	20525	836.5	-12.57	31.117	16.40	43.62	
	20625	846.5	-13.25	31.922	16.52	44.90	
Channel Bandwidth: 5 MHz / 64QAM							
Z	20425	826.5	-9.63	31.208	19.43	87.76	H
	20525	836.5	-9.48	31.3	19.67	92.68	
	20625	846.5	-9.23	31.222	19.84	96.43	
	20425	826.5	-12.62	31.504	16.73	47.14	V
	20525	836.5	-12.58	31.117	16.39	43.52	
	20625	846.5	-13.71	31.922	16.06	40.35	

Note: ERP (dBm) = Reading (dBm) + Correction Factor (dB) – 2.15

LTE Band 5							
Channel Bandwidth: 10 MHz / QPSK							
Plane	Channel	Frequency (MHz)	Reading (dBm)	Correction Factor (dB)	ERP (dBm)	ERP (mW)	Polarization (H/V)
Z	20450	829.0	-7.02	31.208	22.04	159.88	H
	20525	836.5	-7.58	31.3	21.57	143.55	
	20600	844.0	-7.66	31.222	21.41	138.42	
	20450	829.0	-11.58	31.504	17.77	59.90	V
	20525	836.5	-11.91	31.117	17.06	50.78	
	20600	844.0	-12.23	31.922	17.54	56.78	
Channel Bandwidth: 10 MHz / 16QAM							
Z	20425	826.5	-8.65	31.208	20.41	109.85	H
	20525	836.5	-8.25	31.3	20.90	122.91	
	20625	846.5	-8.46	31.222	20.61	115.19	
	20425	826.5	-12.56	31.504	16.80	47.84	V
	20525	836.5	-12.54	31.117	16.43	43.92	
	20625	846.5	-13.42	31.922	16.35	43.17	
Channel Bandwidth: 10 MHz / 64QAM							
Z	20450	829.0	-9.12	31.208	19.94	98.58	H
	20525	836.5	-9.89	31.3	19.26	84.33	
	20600	844.0	-9.77	31.222	19.30	85.15	
	20450	829.0	-12.50	31.504	16.85	48.46	V
	20525	836.5	-12.30	31.117	16.67	46.42	
	20600	844.0	-13.57	31.922	16.20	41.71	

Note: ERP (dBm) = Reading (dBm) + Correction Factor (dB) – 2.15

## 4.2 Modulation Characteristics Measurement

### 4.2.1 Limits of Modulation Characteristics

N/A

### 4.2.2 Test Setup



### 4.2.3 Test Procedure

Connect the EUT to Communication Simulator via the antenna connector. The frequency band is set as EUT supported Modulation and Channels, the EUT output is matched with 50 ohm load, the waveform quality and constellation of the EUT was tested.

### 4.2.4 Test Results

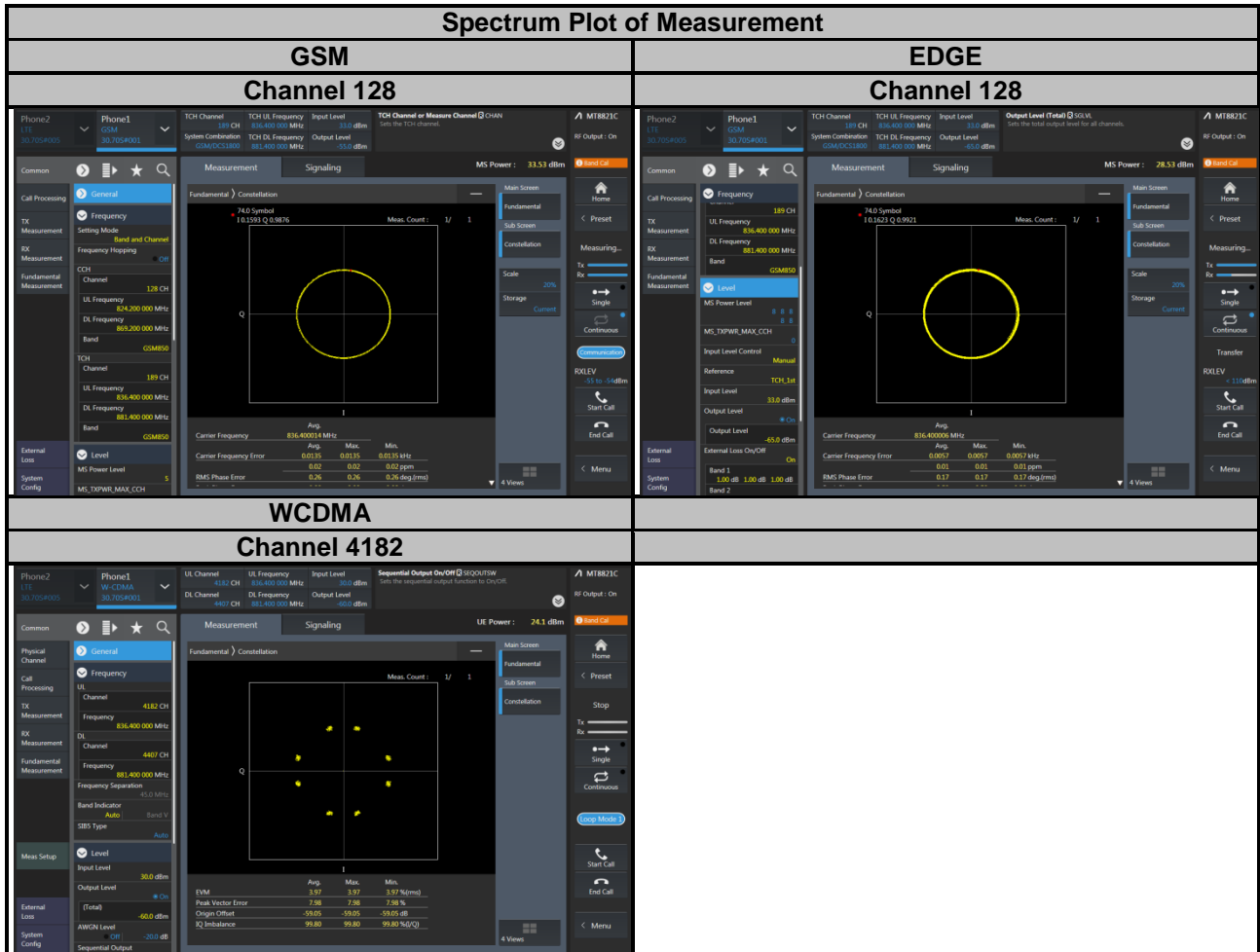



### Spectrum Plot of Measurement

#### LTE Band 5

#### Channel 20525

#### QPSK

#### 16QAM

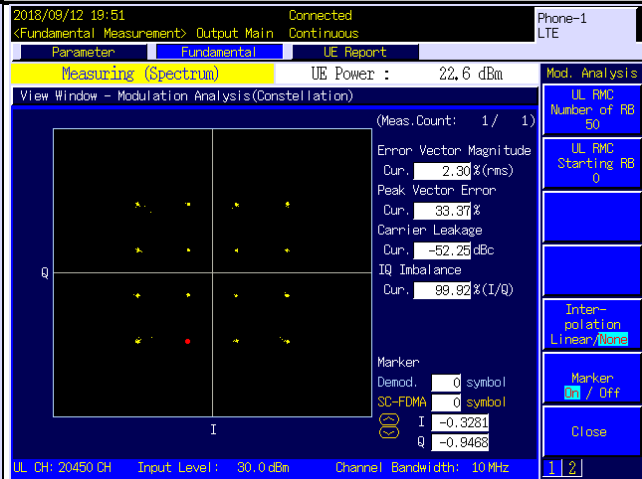
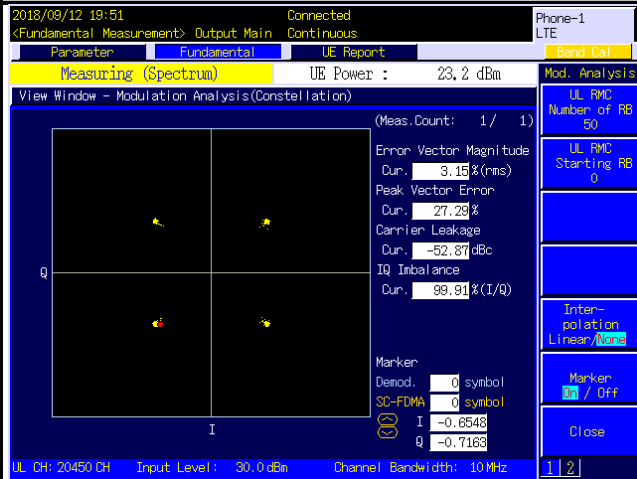

#### 64QAM

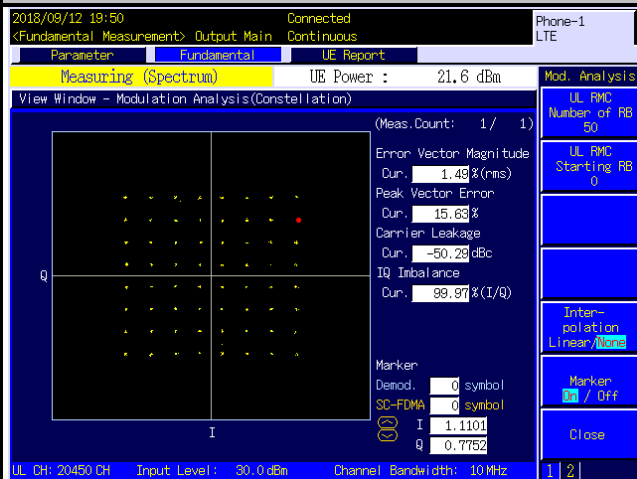

### 4.3 Frequency Stability Measurement

#### 4.3.1 Limits of Frequency Stability Measurement

1.5 ppm is for base and fixed station. 2.5 ppm is for mobile station.

#### 4.3.2 Test Procedure

- a. Device is placed at the oven room. The oven room could control the temperatures and humidity. Power warm up is at least 15 min and power applied should perform before recording frequency error.
- b. EUT is connected the external power supply to control the DC input power. The test voltage range is from minimum to maximum working voltage. Each step shall be record the frequency error rate.
- c. The temperature range step is 10 degrees in this test items. All temperature levels shall be hold the  $\pm 0.5$  °C during the measurement testing. The each temperature step shall be at least 0.5 hours, consider the EUT could be test under the stability condition.

**NOTE:** The frequency error was recorded frequency error from the communication simulator.

#### 4.3.3 Test Setup

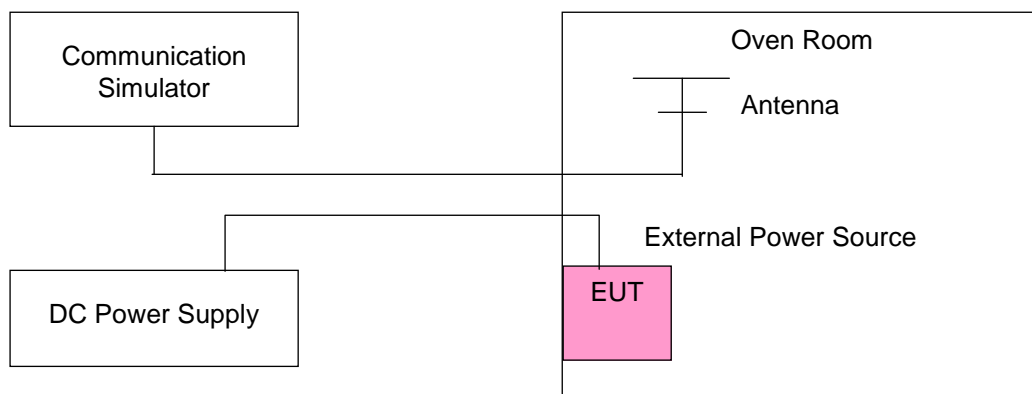

#### 4.3.4 Test Results

##### Frequency Error vs. Voltage

Voltage (Volts)	GSM				Limit (ppm)
	Low Channel		High Channel		
	Frequency (MHz)	Frequency Error (ppm)	Frequency (MHz)	Frequency Error (ppm)	
3.8	824.200001	0.001	848.800004	0.004	2.5
3.23	824.200004	0.005	848.800003	0.004	2.5
4.37	824.200004	0.004	848.800002	0.002	2.5

**Note:** The applicant defined the normal working voltage of the battery is from 3.23 Vdc to 4.37 Vdc.

##### Frequency Error vs. Temperature

Temp. (°C)	GSM				Limit (ppm)
	Low Channel		High Channel		
	Frequency (MHz)	Frequency Error (ppm)	Frequency (MHz)	Frequency Error (ppm)	
-30	824.200001	0.001	848.800003	0.004	2.5
-20	824.200004	0.004	848.800002	0.003	2.5
-10	824.200004	0.004	848.800004	0.004	2.5
0	824.200002	0.003	848.800003	0.003	2.5
10	824.200001	0.001	848.800002	0.003	2.5
20	824.199999	-0.002	848.799998	-0.002	2.5
30	824.199997	-0.004	848.799999	-0.001	2.5
40	824.199996	-0.004	848.799997	-0.004	2.5
50	824.199998	-0.002	848.799999	-0.002	2.5
60	824.199998	-0.003	848.799998	-0.003	2.5

## Frequency Error vs. Voltage

Voltage (Volts)	EDGE				Limit (ppm)
	Low Channel		High Channel		
	Frequency (MHz)	Frequency Error (ppm)	Frequency (MHz)	Frequency Error (ppm)	
3.8	824.200002	0.002	848.800002	0.002	2.5
3.23	824.200001	0.001	848.800003	0.003	2.5
4.37	824.200004	0.004	848.800003	0.004	2.5

**Note:** The applicant defined the normal working voltage of the battery is from 3.23 Vdc to 4.37 Vdc.

## Frequency Error vs. Temperature

Temp. (°C)	EDGE				Limit (ppm)
	Low Channel		High Channel		
	Frequency (MHz)	Frequency Error (ppm)	Frequency (MHz)	Frequency Error (ppm)	
-30	824.200002	0.002	848.800002	0.002	2.5
-20	824.200003	0.003	848.800003	0.004	2.5
-10	824.200002	0.003	848.800004	0.005	2.5
0	824.200004	0.004	848.800004	0.005	2.5
10	824.200003	0.003	848.800001	0.002	2.5
20	824.199999	-0.002	848.799997	-0.004	2.5
30	824.199998	-0.002	848.799998	-0.002	2.5
40	824.199996	-0.004	848.799999	-0.001	2.5
50	824.199999	-0.002	848.799997	-0.003	2.5
60	824.199998	-0.003	848.799997	-0.003	2.5

Frequency Error vs. Voltage

Voltage (Volts)	WCDMA				Limit (ppm)
	Low Channel		High Channel		
	Frequency (MHz)	Frequency Error (ppm)	Frequency (MHz)	Frequency Error (ppm)	
3.8	826.400004	0.005	846.600002	0.002	2.5
3.23	826.400003	0.004	846.600001	0.001	2.5
4.37	826.400002	0.003	846.600002	0.002	2.5

**Note:** The applicant defined the normal working voltage of the battery is from 3.23 Vdc to 4.37 Vdc.

Frequency Error vs. Temperature

Temp. (°C)	WCDMA				Limit (ppm)
	Low Channel		High Channel		
	Frequency (MHz)	Frequency Error (ppm)	Frequency (MHz)	Frequency Error (ppm)	
-30	826.400001	0.002	846.600003	0.004	2.5
-20	826.400004	0.005	846.600002	0.002	2.5
-10	826.400004	0.004	846.600004	0.004	2.5
0	826.400003	0.003	846.600001	0.001	2.5
10	826.400003	0.003	846.600001	0.002	2.5
20	826.399998	-0.003	846.599998	-0.002	2.5
30	826.399997	-0.004	846.599997	-0.003	2.5
40	826.399998	-0.002	846.599999	-0.002	2.5
50	826.399996	-0.004	846.599998	-0.002	2.5
60	826.399997	-0.004	846.599998	-0.003	2.5

Frequency Error vs. Voltage

Voltage (Volts)	LTE Band 5				Limit (ppm)
	Channel Bandwidth: 1.4 MHz				
	Low Channel		High Channel		
	Frequency (MHz)	Frequency Error (ppm)	Frequency (MHz)	Frequency Error (ppm)	
3.8	824.700002	0.002	848.300001	0.001	2.5
3.23	824.700002	0.002	848.300001	0.002	2.5
4.37	824.700001	0.002	848.300001	0.001	2.5

**Note:** The applicant defined the normal working voltage of the battery is from 3.23 Vdc to 4.37 Vdc.

Frequency Error vs. Temperature

Temp. (°C)	LTE Band 5				Limit (ppm)
	Channel Bandwidth: 1.4 MHz				
	Low Channel		High Channel		
	Frequency (MHz)	Frequency Error (ppm)	Frequency (MHz)	Frequency Error (ppm)	
-30	824.700003	0.004	848.300003	0.003	2.5
-20	824.700004	0.005	848.300003	0.003	2.5
-10	824.700002	0.002	848.300004	0.005	2.5
0	824.700002	0.002	848.300002	0.003	2.5
10	824.700001	0.001	848.300002	0.002	2.5
20	824.699998	-0.003	848.299997	-0.003	2.5
30	824.699996	-0.004	848.299999	-0.001	2.5
40	824.699997	-0.004	848.299998	-0.002	2.5
50	824.699997	-0.003	848.299998	-0.002	2.5
60	824.699997	-0.004	848.299997	-0.004	2.5

Frequency Error vs. Voltage

Voltage (Volts)	LTE Band 5				Limit (ppm)
	Channel Bandwidth: 3 MHz				
	Low Channel		High Channel		
	Frequency (MHz)	Frequency Error (ppm)	Frequency (MHz)	Frequency Error (ppm)	
3.8	825.500003	0.004	847.500003	0.004	2.5
3.23	825.500003	0.004	847.500001	0.001	2.5
4.37	825.500004	0.005	847.500003	0.003	2.5

**Note:** The applicant defined the normal working voltage of the battery is from 3.23 Vdc to 4.37 Vdc.

Frequency Error vs. Temperature

Temp. (°C)	LTE Band 5				Limit (ppm)
	Channel Bandwidth: 3 MHz				
	Low Channel		High Channel		
	Frequency (MHz)	Frequency Error (ppm)	Frequency (MHz)	Frequency Error (ppm)	
-30	825.500003	0.004	847.500003	0.003	2.5
-20	825.500002	0.002	847.500004	0.004	2.5
-10	825.500003	0.004	847.500003	0.003	2.5
0	825.500004	0.005	847.500004	0.004	2.5
10	825.500004	0.005	847.500004	0.004	2.5
20	825.499998	-0.003	847.499997	-0.004	2.5
30	825.499999	-0.001	847.499999	-0.002	2.5
40	825.499999	-0.001	847.499998	-0.003	2.5
50	825.499998	-0.003	847.499997	-0.004	2.5
60	825.499998	-0.002	847.499999	-0.002	2.5

Frequency Error vs. Voltage

Voltage (Volts)	LTE Band 5				Limit (ppm)
	Channel Bandwidth: 5 MHz				
	Low Channel		High Channel		
	Frequency (MHz)	Frequency Error (ppm)	Frequency (MHz)	Frequency Error (ppm)	
3.8	826.500002	0.003	846.500001	0.002	2.5
3.23	826.500004	0.004	846.500002	0.002	2.5
4.37	826.500001	0.001	846.500002	0.002	2.5

**Note:** The applicant defined the normal working voltage of the battery is from 3.23 Vdc to 4.37 Vdc.

Frequency Error vs. Temperature

Temp. (°C)	LTE Band 5				Limit (ppm)
	Channel Bandwidth: 5 MHz				
	Low Channel		High Channel		
	Frequency (MHz)	Frequency Error (ppm)	Frequency (MHz)	Frequency Error (ppm)	
-30	826.500003	0.003	846.500002	0.002	2.5
-20	826.500001	0.001	846.500002	0.002	2.5
-10	826.500003	0.003	846.500004	0.005	2.5
0	826.500002	0.002	846.500003	0.004	2.5
10	826.500002	0.003	846.500002	0.003	2.5
20	826.499997	-0.004	846.499997	-0.004	2.5
30	826.499999	-0.002	846.499998	-0.003	2.5
40	826.499998	-0.003	846.499999	-0.001	2.5
50	826.499999	-0.002	846.499997	-0.004	2.5
60	826.499998	-0.003	846.499997	-0.003	2.5



Frequency Error vs. Voltage

Voltage (Volts)	LTE Band 5				Limit (ppm)
	Channel Bandwidth: 10 MHz				
	Low Channel		High Channel		
	Frequency (MHz)	Frequency Error (ppm)	Frequency (MHz)	Frequency Error (ppm)	
3.8	829.000004	0.005	844.000002	0.003	2.5
3.23	829.000003	0.003	844.000001	0.002	2.5
4.37	829.000002	0.002	844.000003	0.004	2.5

**Note:** The applicant defined the normal working voltage of the battery is from 3.23 Vdc to 4.37 Vdc.

Frequency Error vs. Temperature

Temp. (°C)	LTE Band 5				Limit (ppm)
	Channel Bandwidth: 10 MHz				
	Low Channel		High Channel		
	Frequency (MHz)	Frequency Error (ppm)	Frequency (MHz)	Frequency Error (ppm)	
-30	829.000002	0.003	844.000003	0.004	2.5
-20	829.000003	0.004	844.000002	0.003	2.5
-10	829.000002	0.002	844.000002	0.002	2.5
0	829.000002	0.002	844.000001	0.002	2.5
10	829.000003	0.004	844.000003	0.003	2.5
20	828.999999	-0.002	843.999999	-0.001	2.5
30	828.999999	-0.002	843.999998	-0.003	2.5
40	828.999997	-0.003	843.999998	-0.003	2.5
50	828.999999	-0.001	843.999998	-0.003	2.5
60	828.999997	-0.003	843.999998	-0.002	2.5

## 4.4 Occupied Bandwidth Measurement

### 4.4.1 Test Procedure

The EUT makes a call to the communication simulator. All measurements were done at low, middle and high operational frequency range. The communication simulator station system controlled a EUT to export maximum output power under transmission mode and specific channel frequency. Use OBW measurement function of Spectrum analyzer to measure 99 % occupied bandwidth.

### 4.4.2 Test Setup

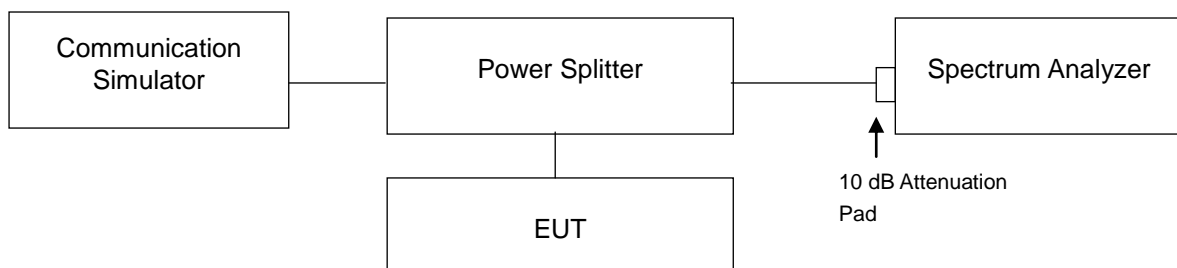

### 4.4.3 Test Result

Channel	Frequency (MHz)	99 % Occupied Bandwidth (kHz)		Channel	Frequency (MHz)	99 % Occupied Bandwidth (MHz)
		GSM	EDGE			WCDMA
128	824.2	242.40	245.09	4132	826.4	4.1508
189	836.4	241.86	245.13	4182	836.4	4.1524
251	848.8	242.79	246.36	4233	846.6	4.1432

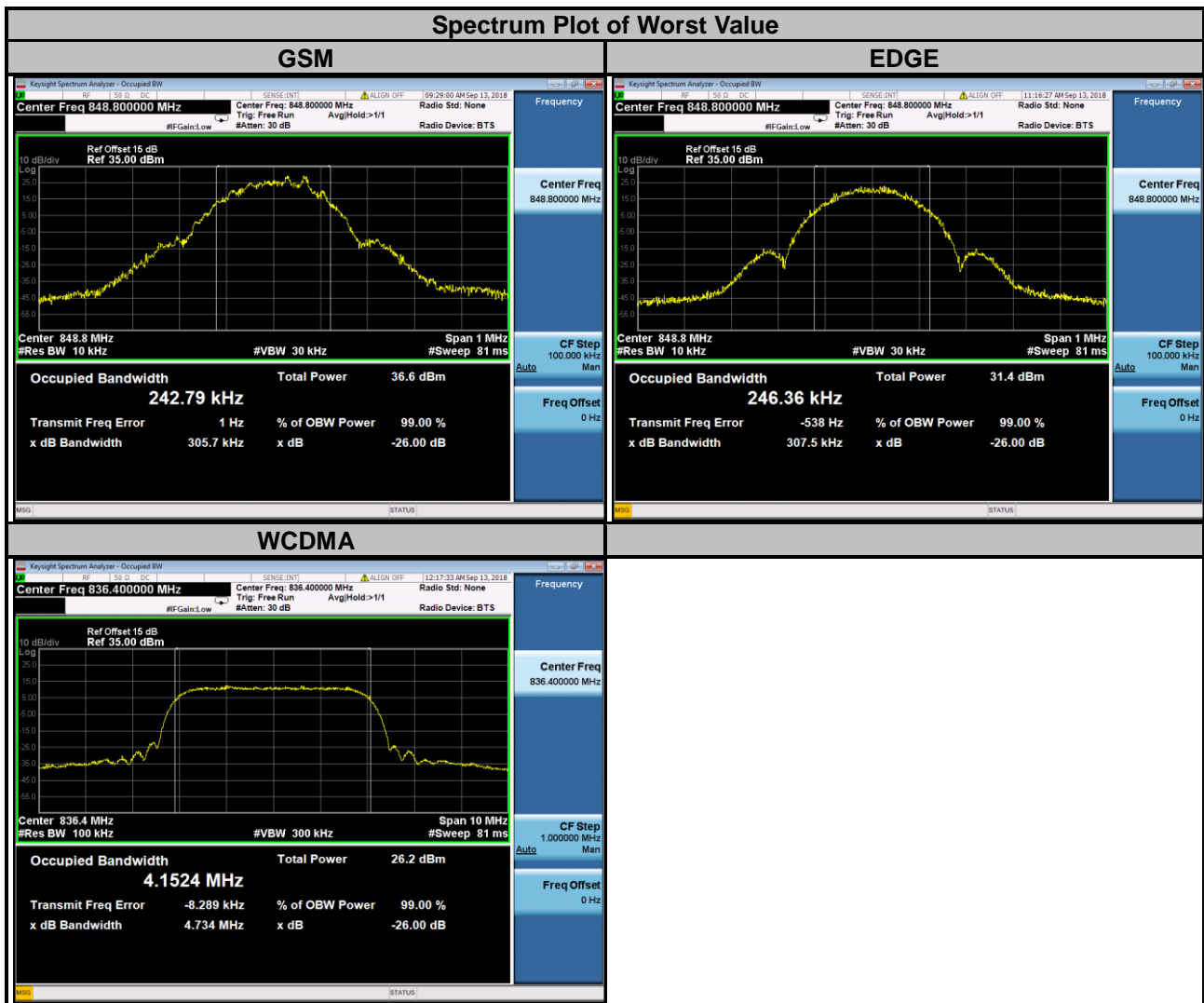

LTE Band 5									
Channel Bandwidth: 1.4 MHz					Channel Bandwidth: 3 MHz				
Channel	Frequency (MHz)	99 % Occupied Bandwidth (MHz)			Channel	Frequency (MHz)	99 % Occupied Bandwidth (MHz)		
		QPSK	16QAM	64QAM			QPSK	16QAM	64QAM
20407	824.7	1.0868	1.0859	1.0884	20415	825.5	2.7003	2.6971	2.6981
20525	836.5	1.0859	1.0861	1.0877	20525	836.5	2.7025	2.6985	2.6977
20643	848.3	1.0872	1.0891	1.0888	20635	847.5	2.7018	2.6991	2.6989

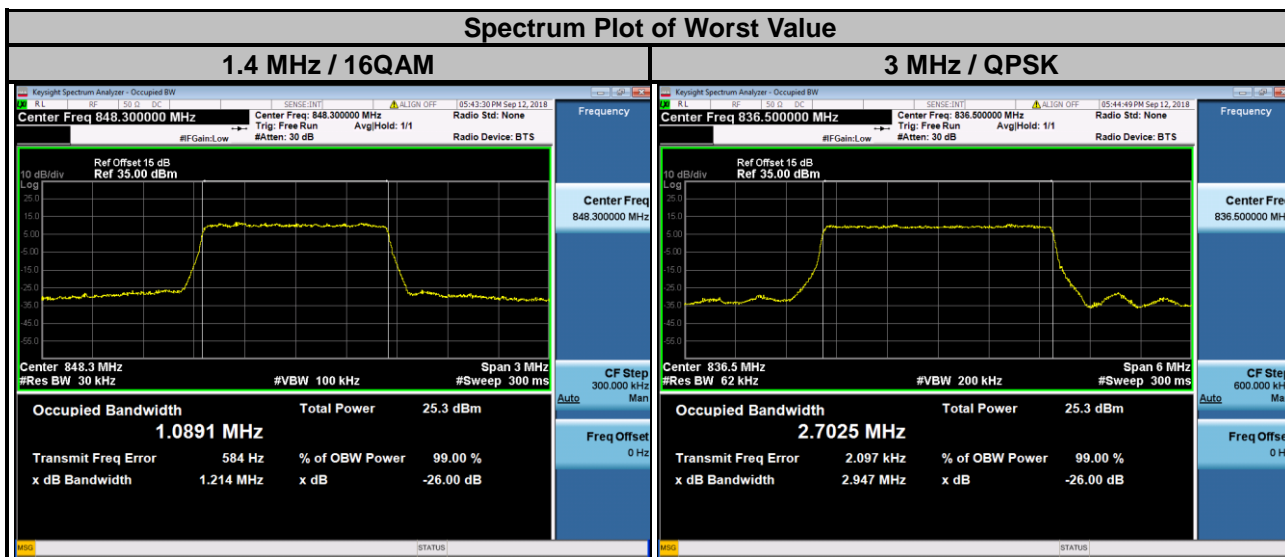

LTE Band 5									
Channel Bandwidth: 5 MHz					Channel Bandwidth: 10 MHz				
Channel	Frequency (MHz)	99 % Occupied Bandwidth (MHz)			Channel	Frequency (MHz)	99 % Occupied Bandwidth (MHz)		
		QPSK	16QAM	64QAM			QPSK	16QAM	64QAM
20425	826.5	4.4942	4.4955	4.5032	20450	829.0	8.9696	8.9745	8.9770
20525	836.5	4.4916	4.4955	4.5001	20525	836.5	8.9689	8.9673	8.9758
20625	846.5	4.4902	4.4927	4.5020	20600	844.0	8.9695	8.9721	8.9808

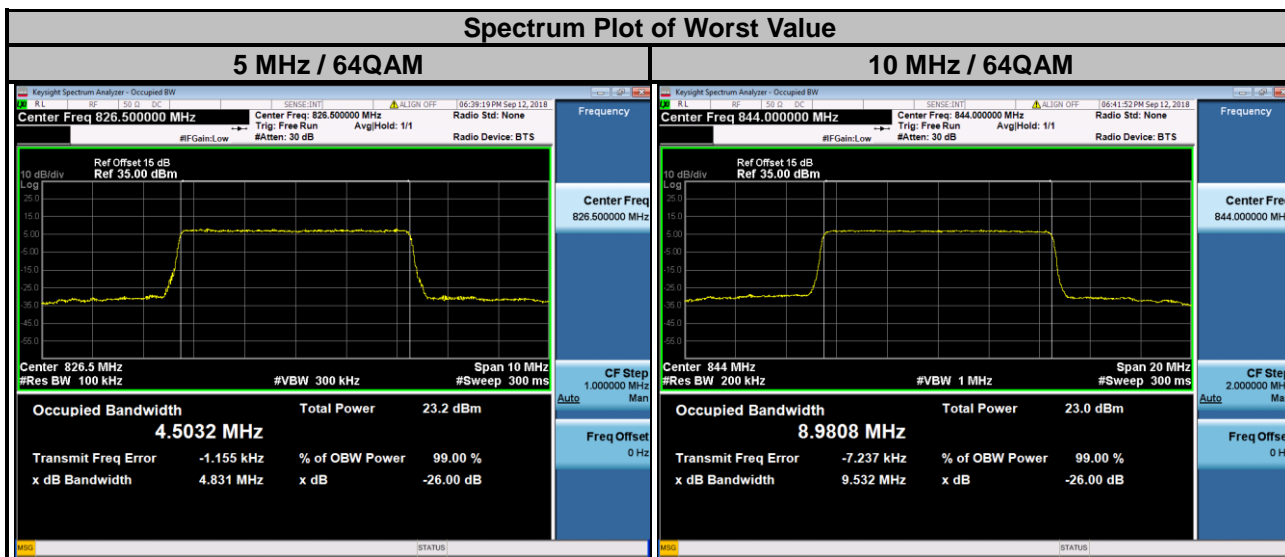

## 4.5 Band Edge Measurement

### 4.5.1 Limits of Band Edge Measurement

Power of any emission outside of the authorized operating frequency ranges must be attenuated below the transmitting power (P) by a factor of at least  $43 + 10 \log(P)$  dB. In the 1 MHz bands immediately outside and adjacent to the frequency block a resolution bandwidth of at least one percent of the emission bandwidth of the fundamental emission of the transmitter may be employed.

### 4.5.2 Test Setup

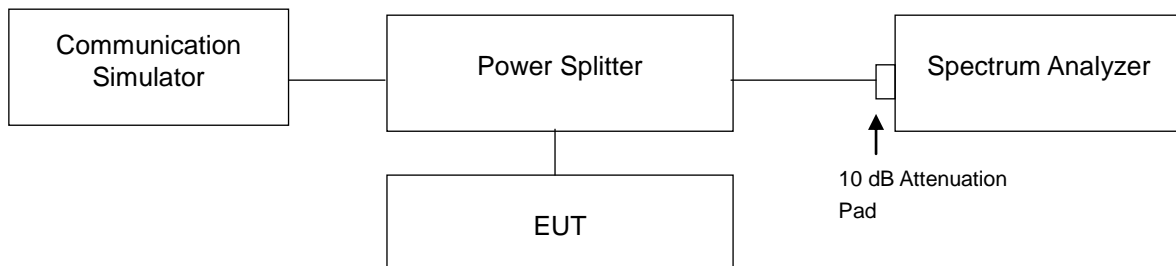

### 4.5.3 Test Procedures

- All measurements were done at low and high operational frequency range.
- The center frequency of spectrum is the band edge frequency and span is 1 MHz. RB of the spectrum is 10 kHz and VB of the spectrum is 30 kHz (GSM/GPRS/EDGE).
- The center frequency of spectrum is the band edge frequency and span is 5 MHz. RB of the spectrum is 100 kHz and VB of the spectrum is 300 kHz (WCDMA).
- The center frequency of spectrum is the band edge frequency and span is 1 MHz. RB of the spectrum is 15 kHz and VB of the spectrum is 51 kHz (LTE Bandwidth 1.4 MHz).
- The center frequency of spectrum is the band edge frequency and span is 1 MHz. RB of the spectrum is 30 kHz and VB of the spectrum is 100 kHz (LTE Bandwidth 3 MHz).
- The center frequency of spectrum is the band edge frequency and span is 1 MHz. RB of the spectrum is 62 kHz and VB of the spectrum is 200 kHz (LTE Bandwidth 5 MHz).
- The center frequency of spectrum is the band edge frequency and span is 1 MHz. RB of the spectrum is 100 kHz and VB of the spectrum is 300 kHz (LTE Bandwidth 10 MHz).
- Record the max trace plot into the test report.

### 4.5.4 Test Results

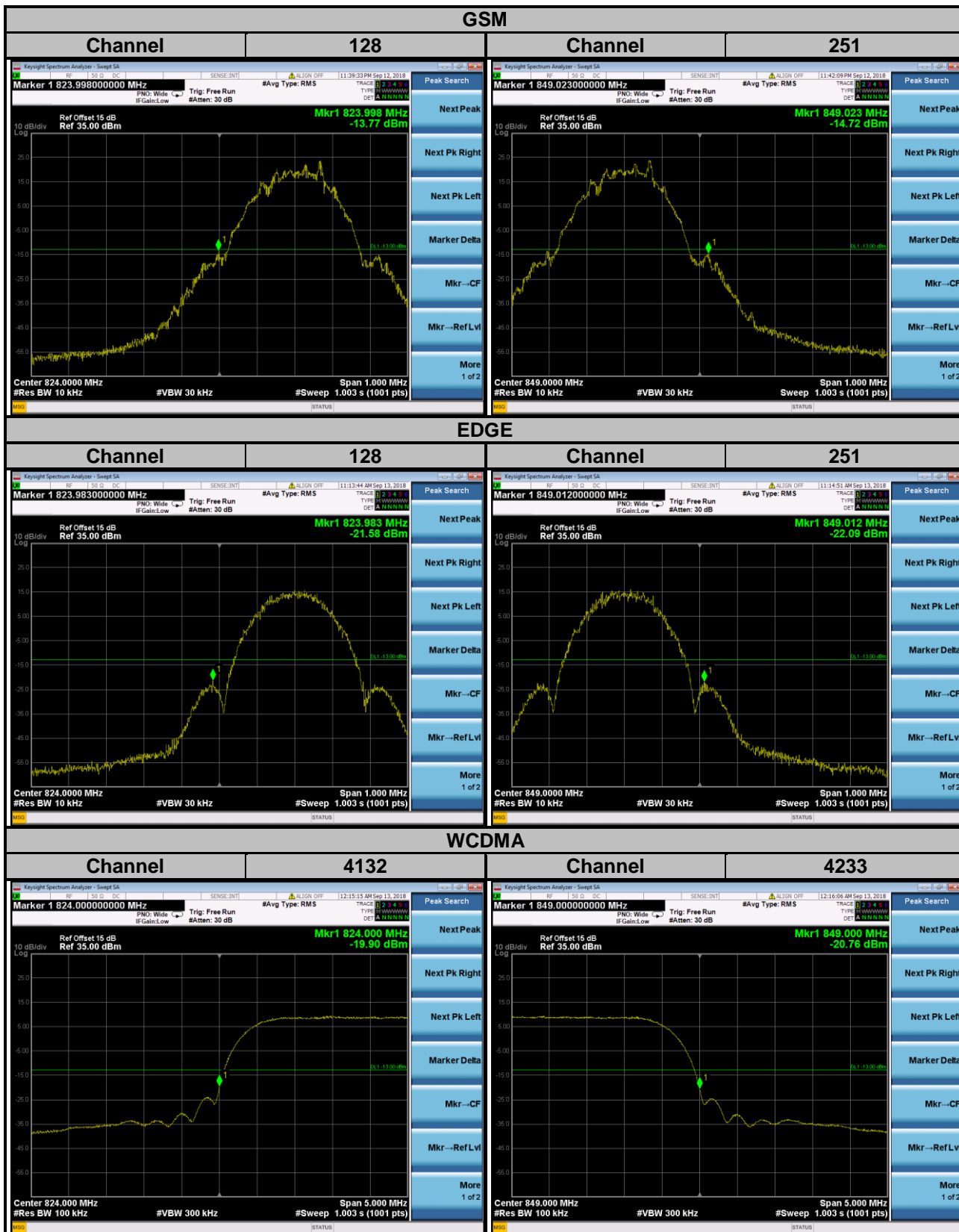

**LTE Band 5**  
**Channel Bandwidth: 1.4 MHz**

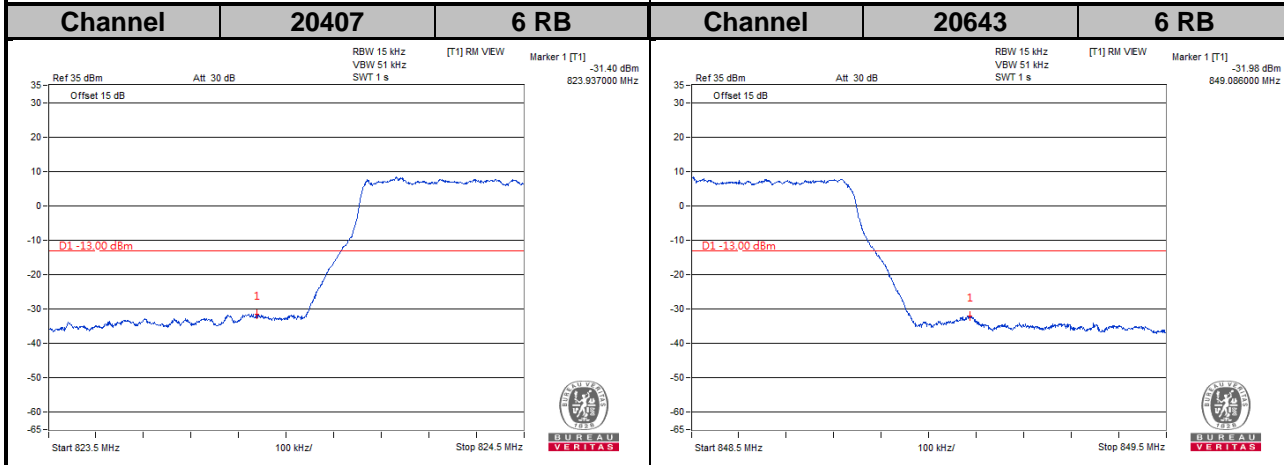
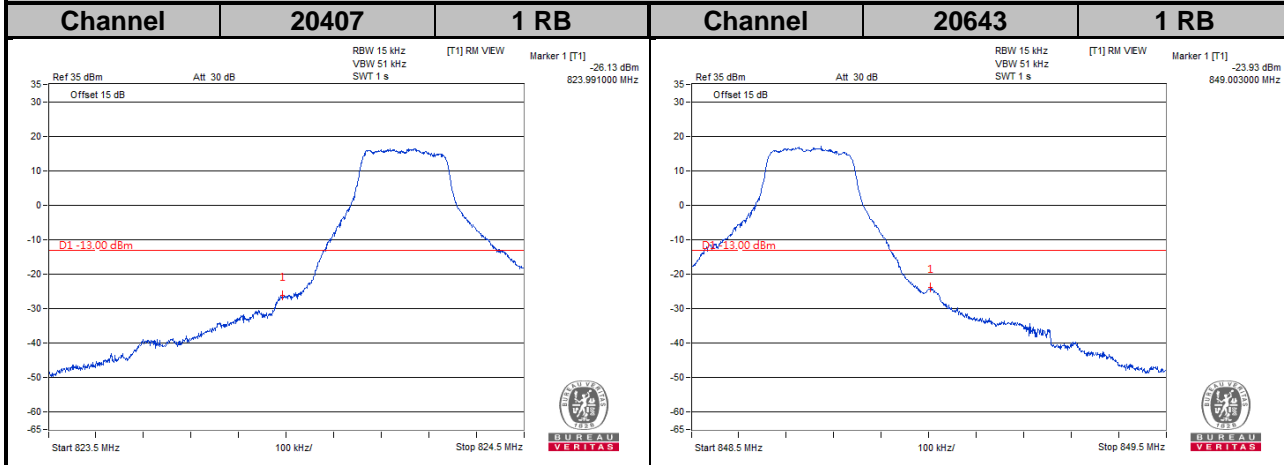



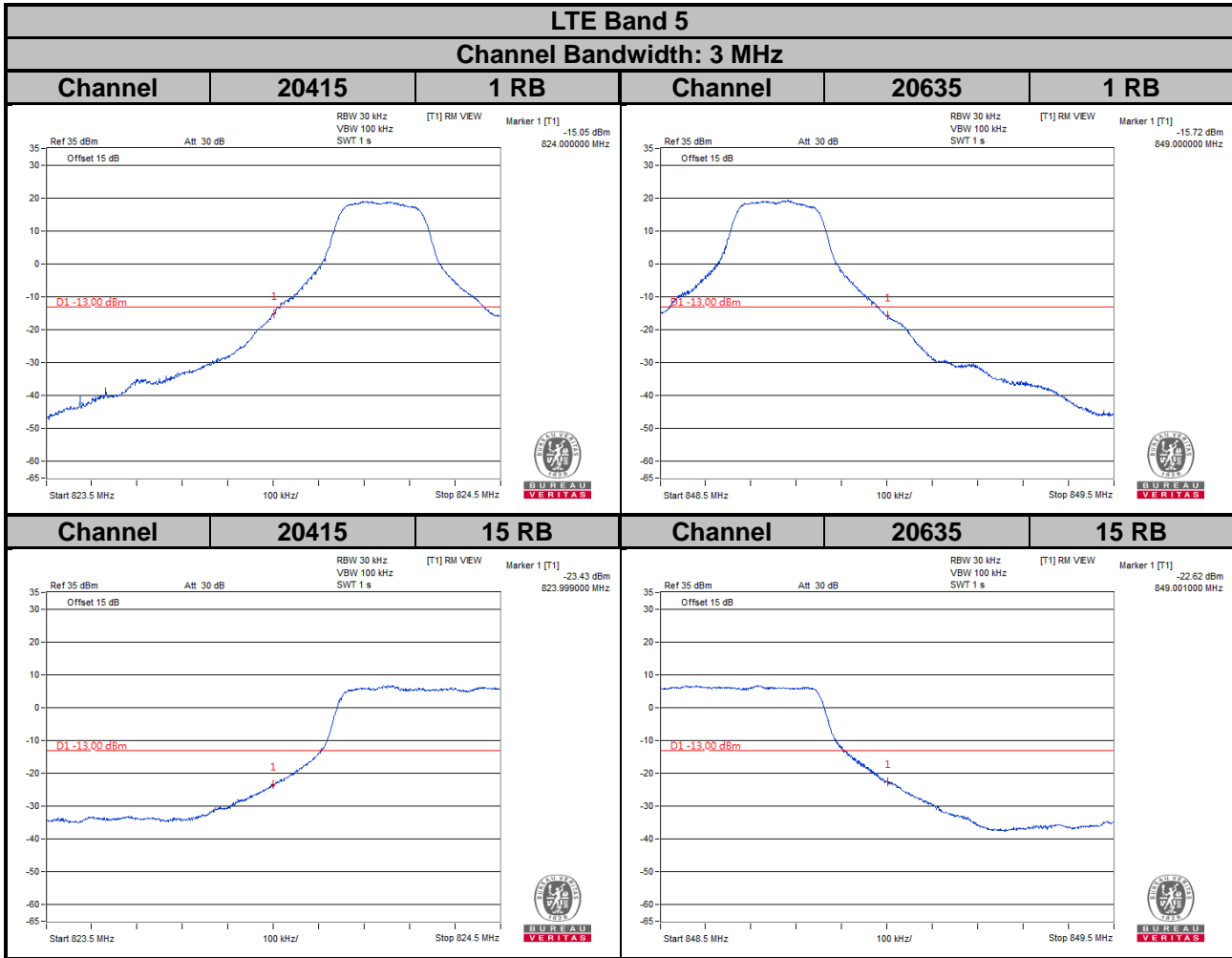

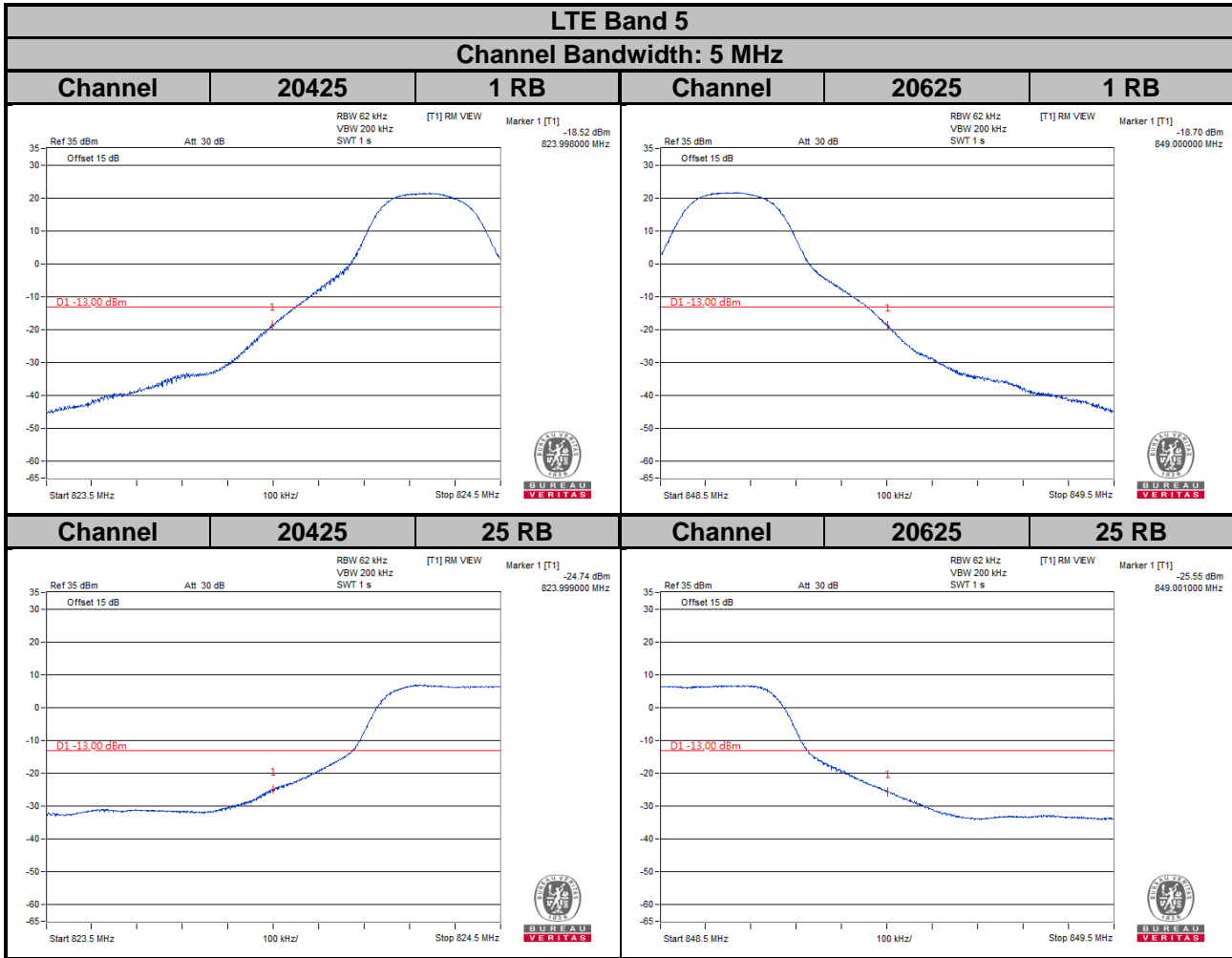

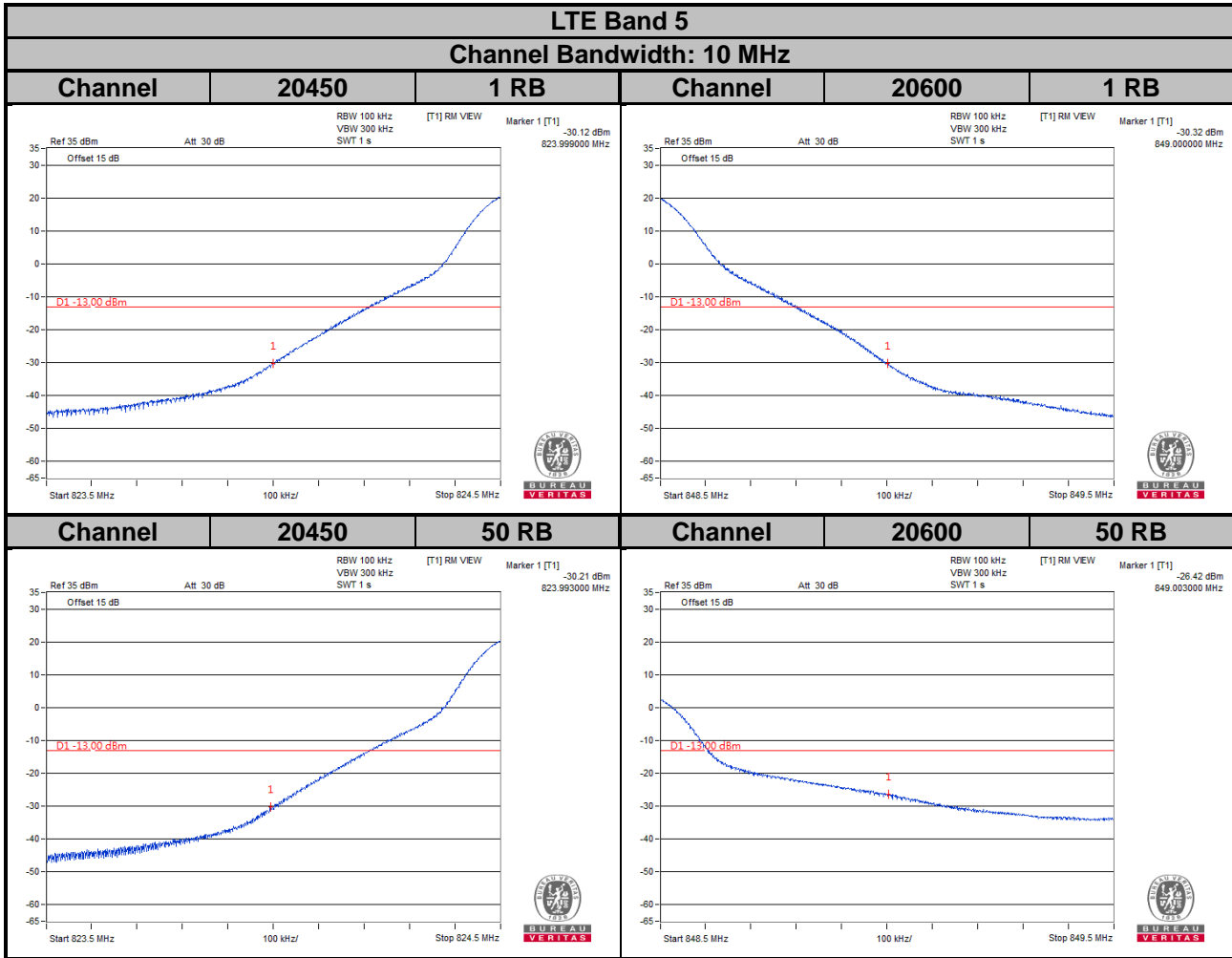

## 4.6 Peak to Average Ratio

### 4.6.1 Limits of Peak to Average Ratio Measurement

In measuring transmissions in this band using an average power technique, the peak to-average ratio (PAR) of the transmission may not exceed 13 dB.

### 4.6.2 Test Setup

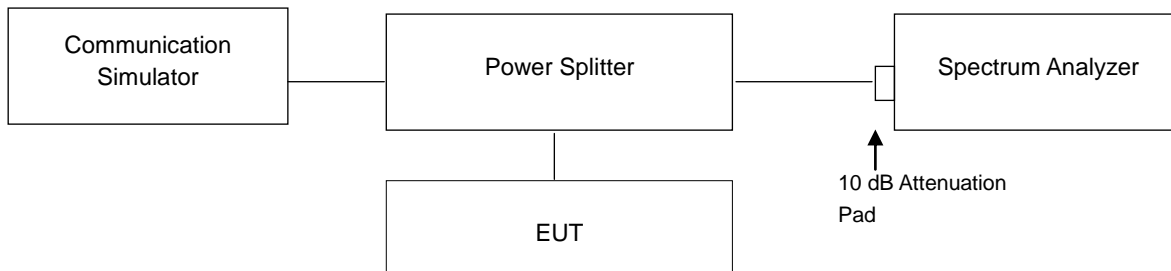

### 4.6.3 Test Procedures

1. Set resolution/measurement bandwidth  $\geq$  signal's occupied bandwidth;
2. Set the number of counts to a value that stabilizes the measured CCDF curve;
3. Record the maximum PAPR level associated with a probability of 0.1 %.

#### 4.6.4 Test Results

Channel	Frequency (MHz)	Peak to Average Ratio (dB)		Channel	Frequency (MHz)	Peak to Average Ratio (dB)
		GSM	EDGE			
128	824.2	0.63	3.30	4132	826.4	3.01
189	836.4	0.64	3.29	4182	836.4	2.93
251	848.8	0.64	3.26	4233	846.6	3.06

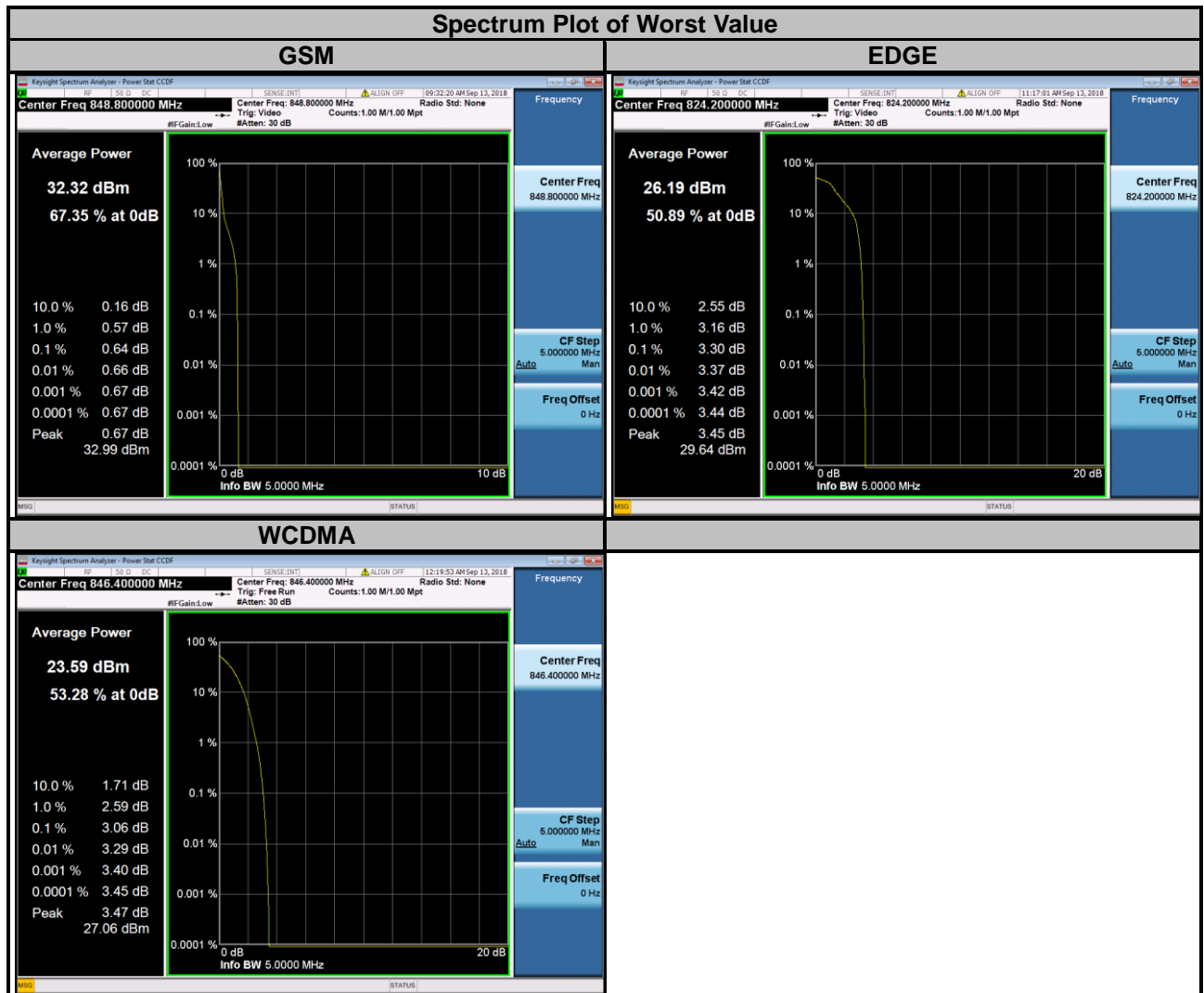

### LTE Band 5

Channel Bandwidth: 1.4 MHz					Channel Bandwidth: 3 MHz				
Channel	Frequency (MHz)	Peak to Average Ratio (dB)			Channel	Frequency (MHz)	Peak to Average Ratio (dB)		
		QPSK	16QAM	64QAM			QPSK	16QAM	64QAM
20407	824.7	3.40	4.70	5.90	20415	825.5	3.26	4.58	5.90
20525	836.5	3.30	4.53	5.71	20525	836.5	3.20	4.48	5.79
20643	848.3	3.39	4.58	5.82	20635	847.5	3.24	4.55	5.84

### Spectrum Plot of Worst Value

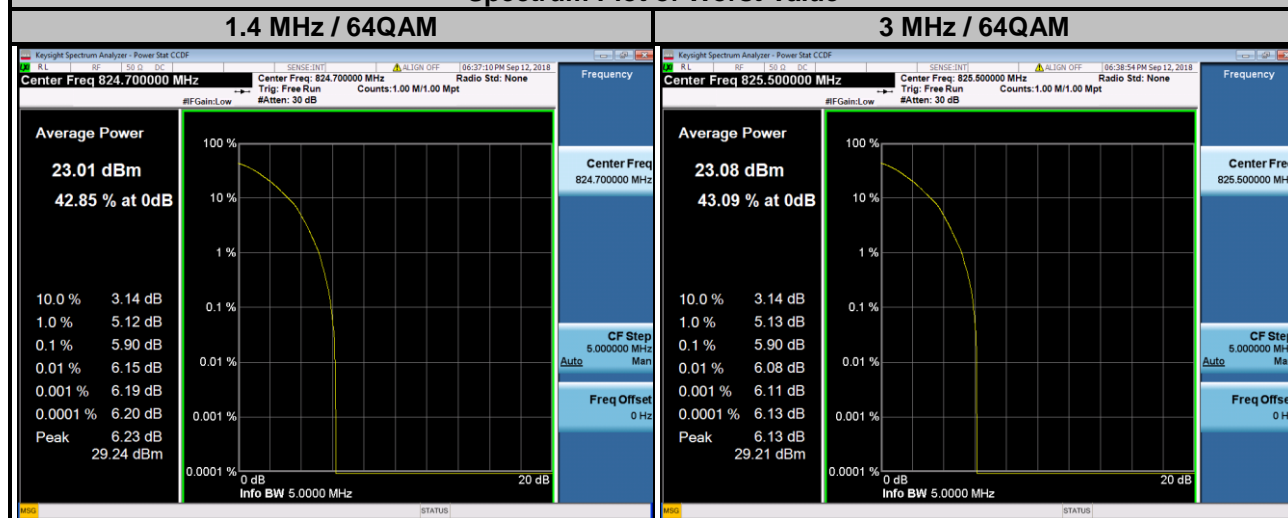

LTE Band 5									
Channel Bandwidth: 5 MHz					Channel Bandwidth: 10 MHz				
Channel	Frequency (MHz)	Peak to Average Ratio (dB)			Channel	Frequency (MHz)	Peak to Average Ratio (dB)		
		QPSK	16QAM	64QAM			QPSK	16QAM	64QAM
20425	826.5	3.26	4.60	5.87	20450	829.0	3.21	4.51	5.86
20525	836.5	3.22	4.53	5.86	20525	836.5	3.32	4.69	6.06
20625	846.5	3.25	4.56	5.85	20600	844.0	3.02	4.29	5.58

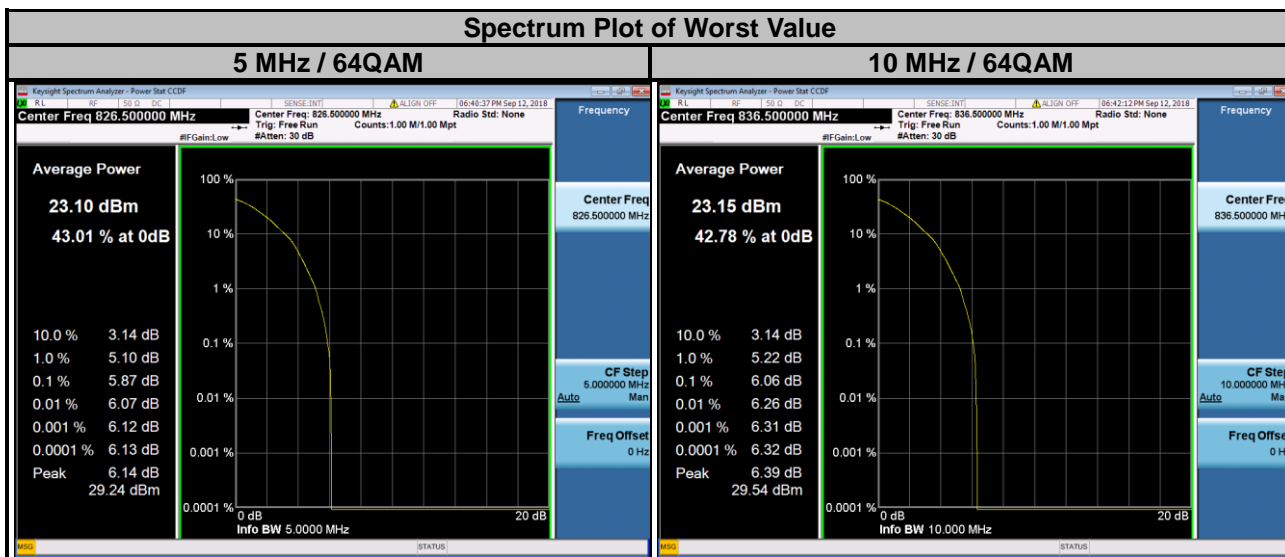

## 4.7 Conducted Spurious Emissions

### 4.7.1 Limits of Conducted Spurious Emissions Measurement

The power of any emission outside of the authorized operating frequency ranges must be attenuated below the transmitting power (P) by a factor of at least  $43 + 10 \log(P)$  dB. The emission limit equal to -13 dBm.

### 4.7.2 Test Setup

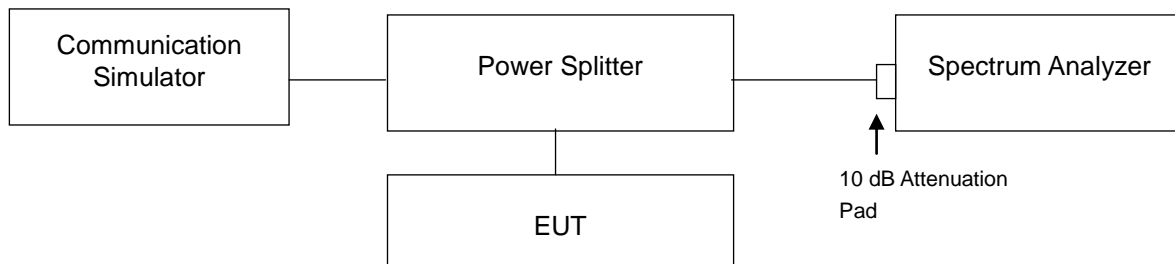

### 4.7.3 Test Procedure

- The EUT makes a phone call to the communication simulator. All measurements were done at low, middle and high operational frequency range.
- Measuring frequency range is from 9 kHz to 10 GHz. 10 dB attenuation pad is connected with spectrum. RBW = 100 kHz and VBW = 300 kHz is used for conducted emission measurement.



### 4.7.4 Test Results

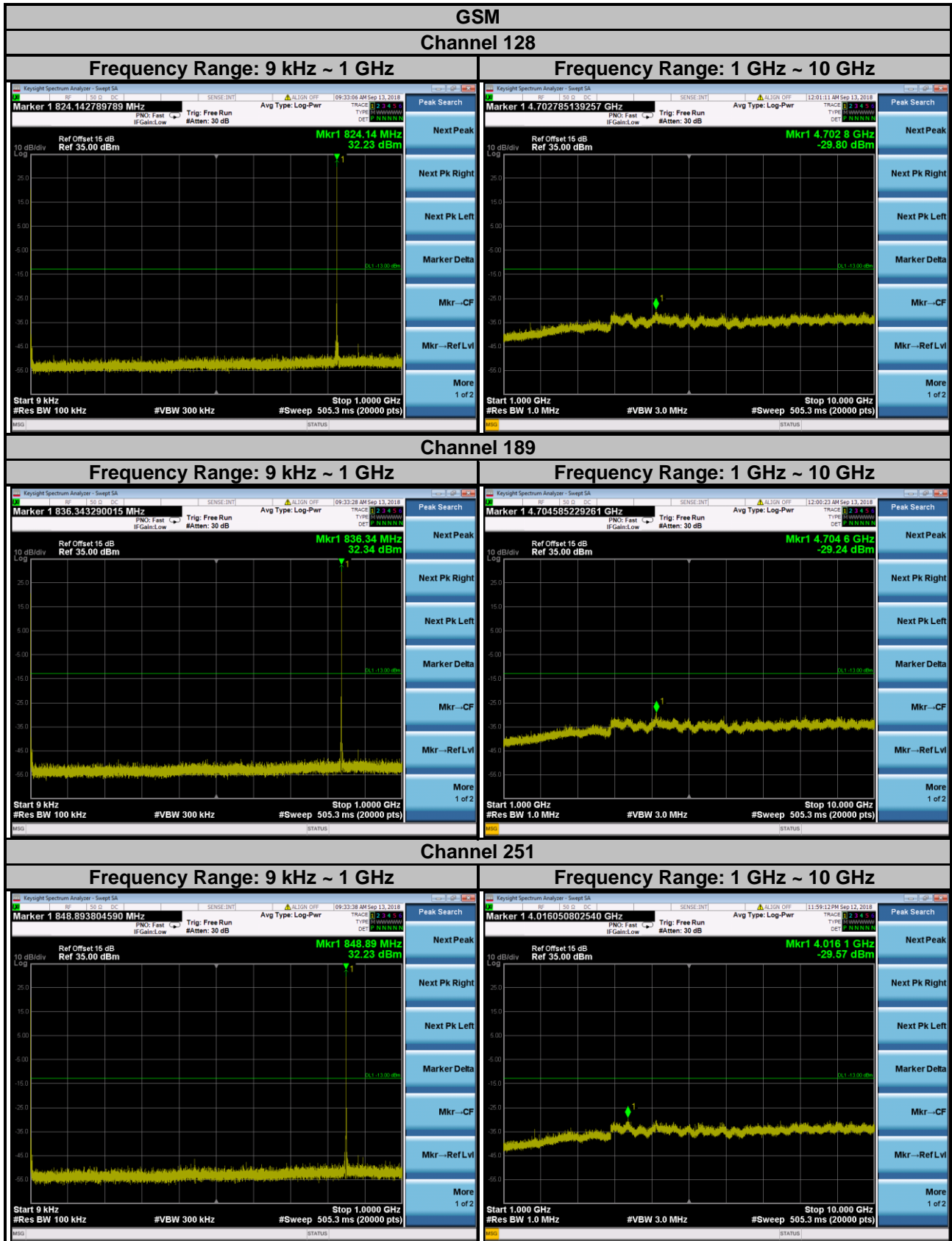



### WCDMA Channel 4132

Frequency Range: 9 kHz ~ 1 GHz

Frequency Range: 1 GHz ~ 10 GHz

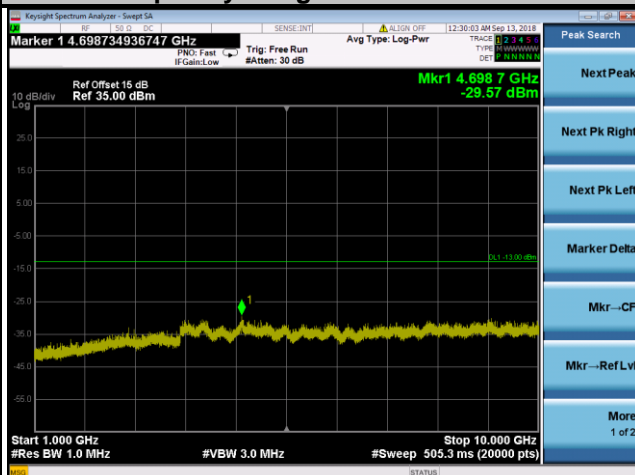
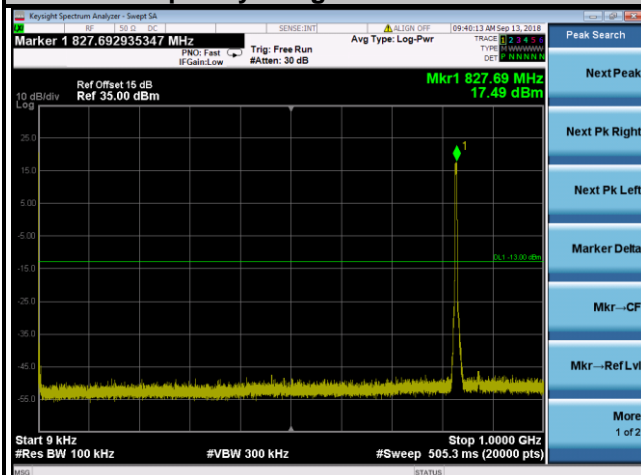

### Channel 4182

Frequency Range: 9 kHz ~ 1 GHz

Frequency Range: 1 GHz ~ 10 GHz

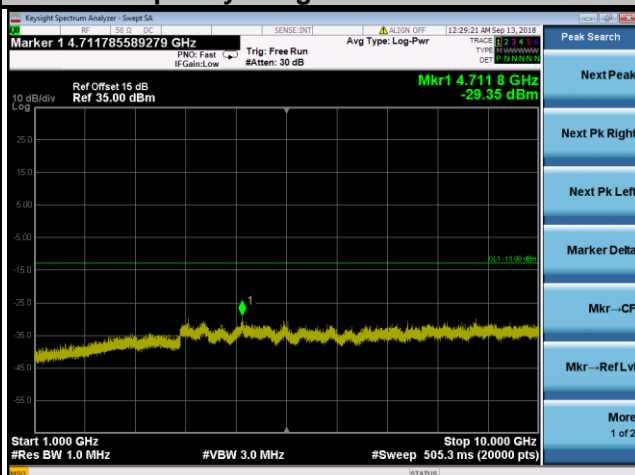
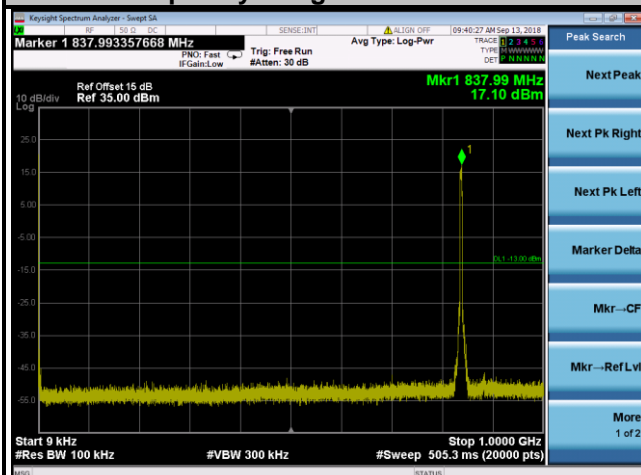

### Channel 4233

Frequency Range: 9 kHz ~ 1 GHz

Frequency Range: 1 GHz ~ 10 GHz

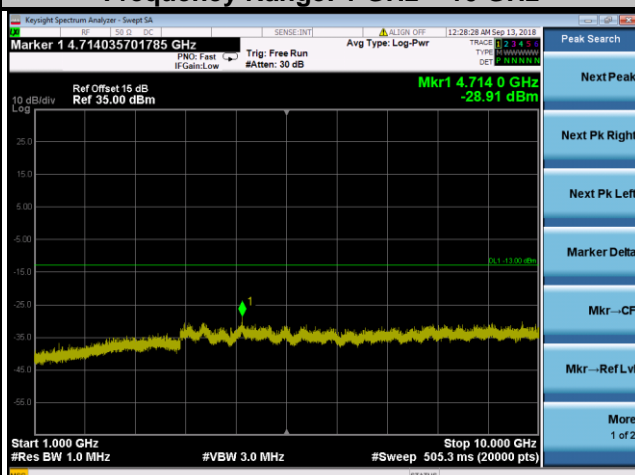
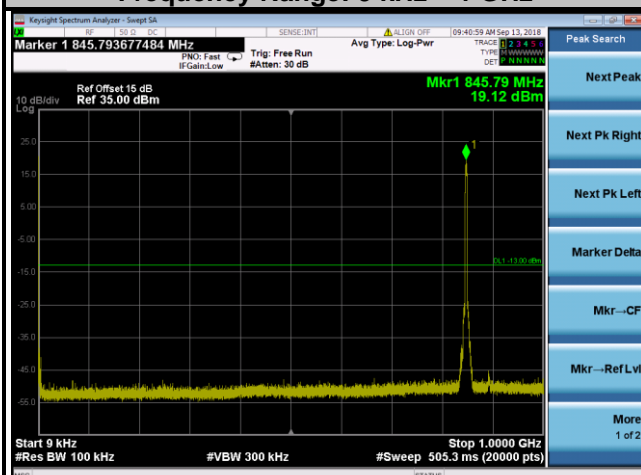

**LTE Band 5**  
**Channel Bandwidth: 1.4 MHz**

**Channel 20407**

**Frequency Range: 9 kHz ~ 1 GHz**

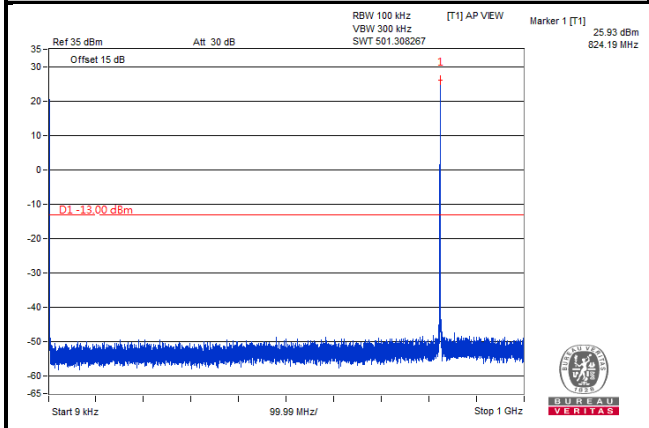

**Frequency Range: 1 GHz ~ 10 GHz**

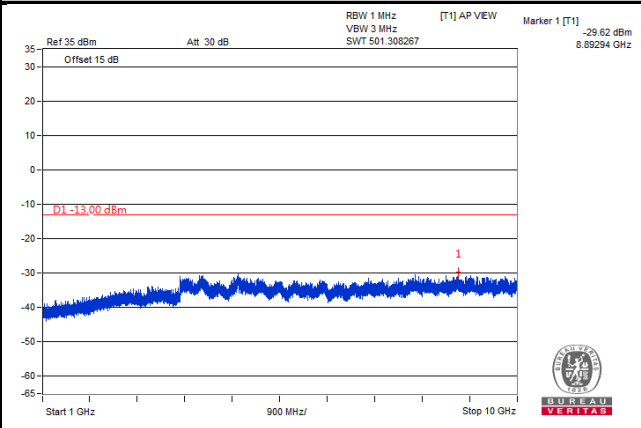

**Channel 20525**

**Frequency Range: 9 kHz ~ 1 GHz**

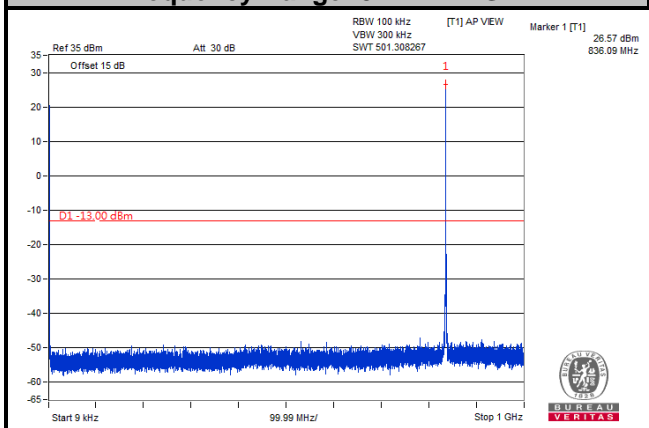

**Frequency Range: 1 GHz ~ 10 GHz**

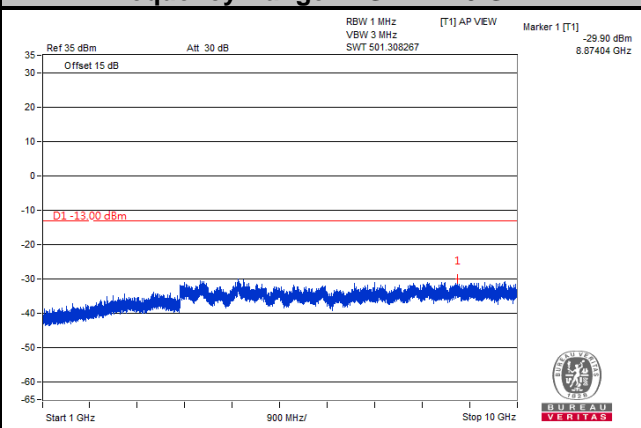

**Channel 20643**

**Frequency Range: 9 kHz ~ 1 GHz**

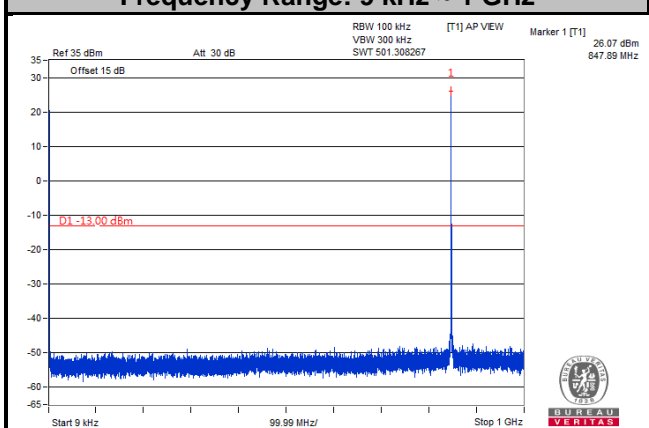

**Frequency Range: 1 GHz ~ 10 GHz**

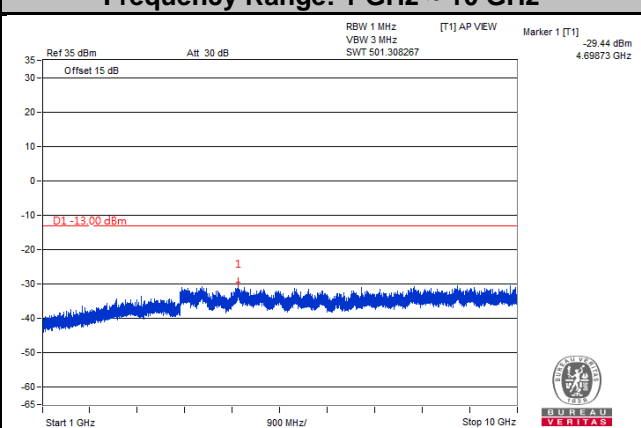

**LTE Band 5**  
**Channel Bandwidth: 3 MHz**  
**Channel 20415**

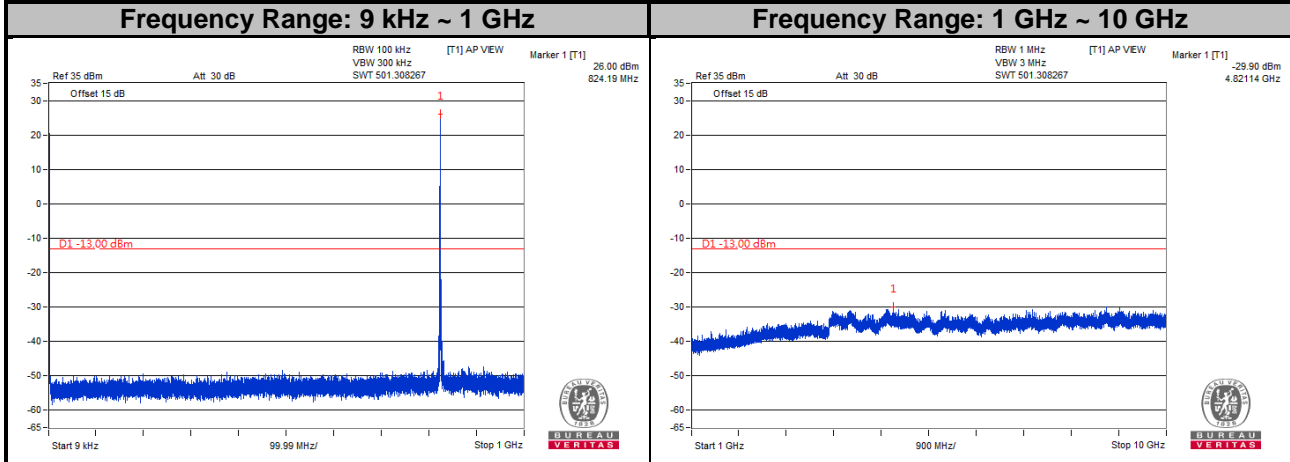

**Channel 20525**

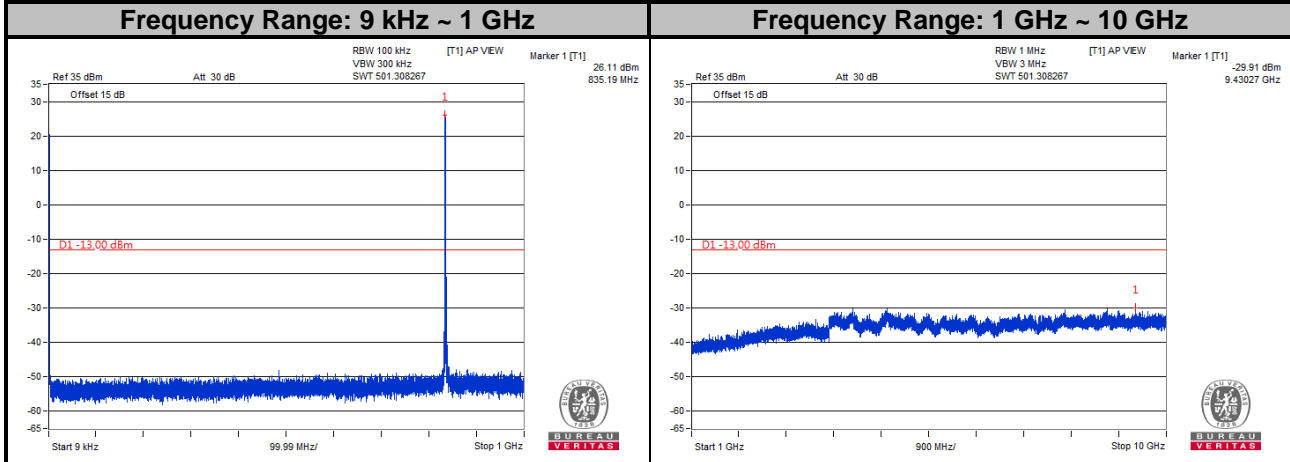

**Channel 20635**

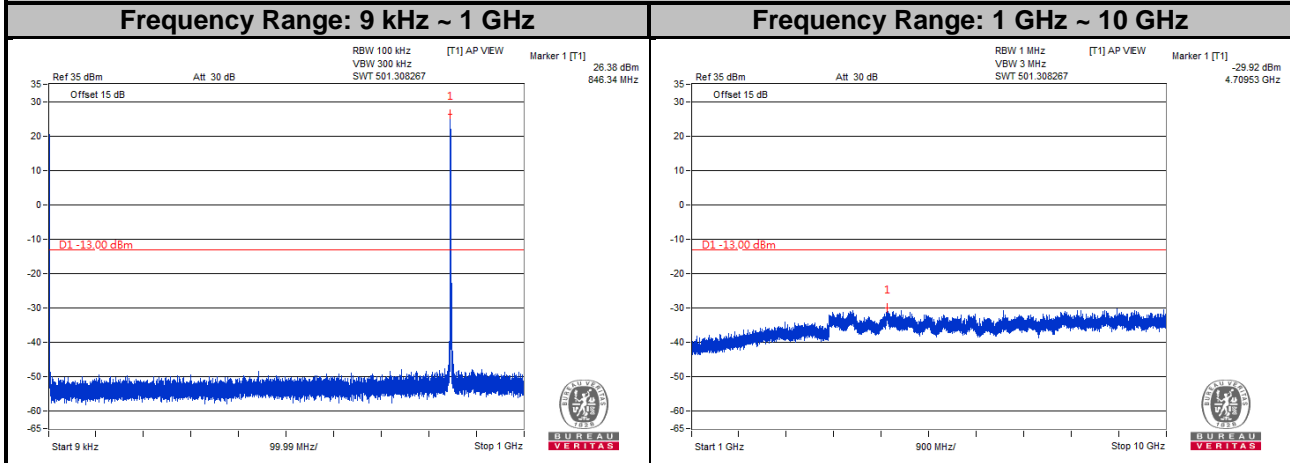

**LTE Band 5**  
**Channel Bandwidth: 5 MHz**

**Channel 20425**

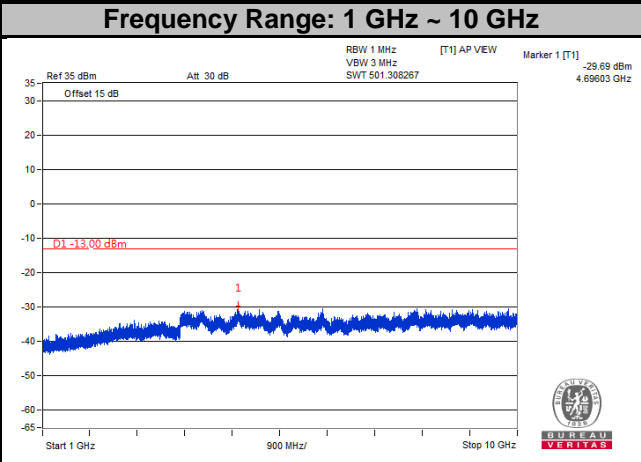
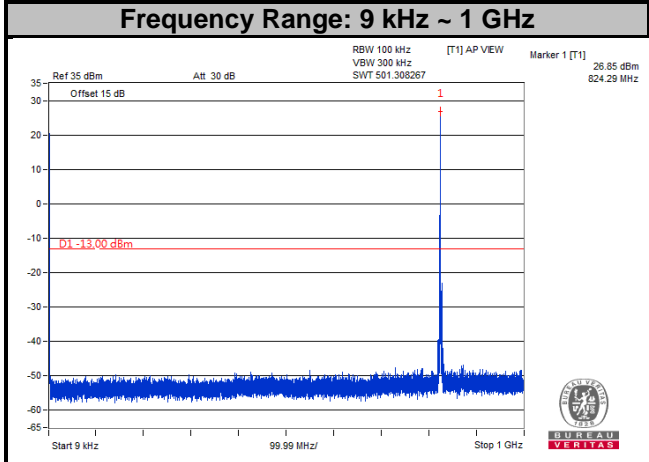

**Channel 20525**

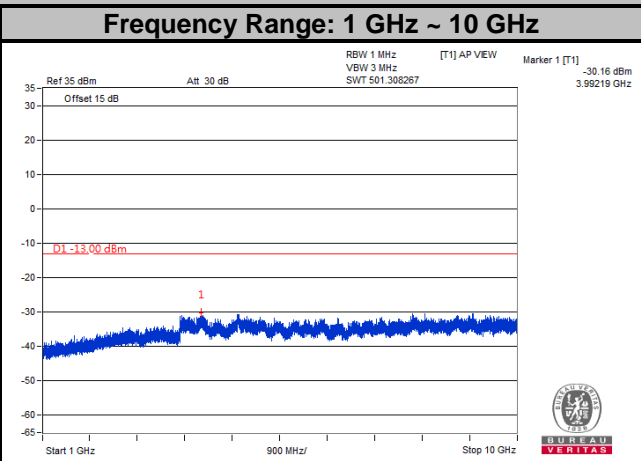
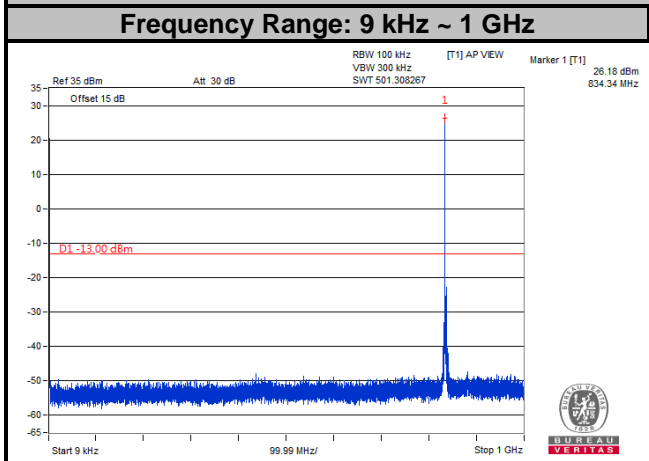

**Channel 20625**

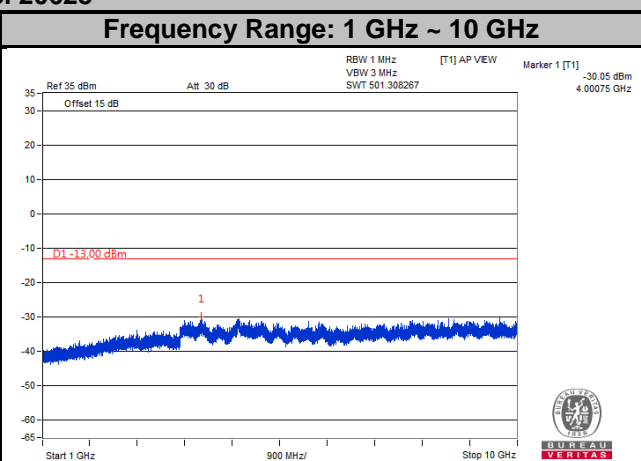
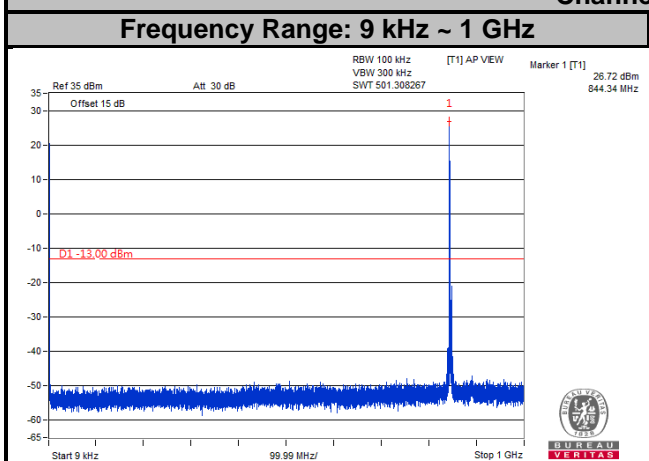

**LTE Band 5**  
**Channel Bandwidth: 10 MHz**  
**Channel 20450**

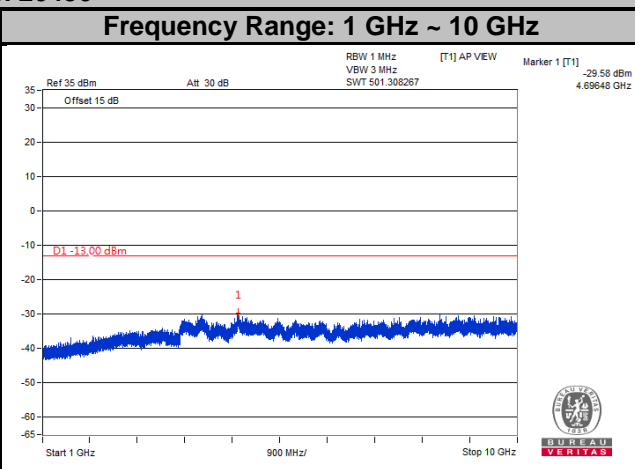
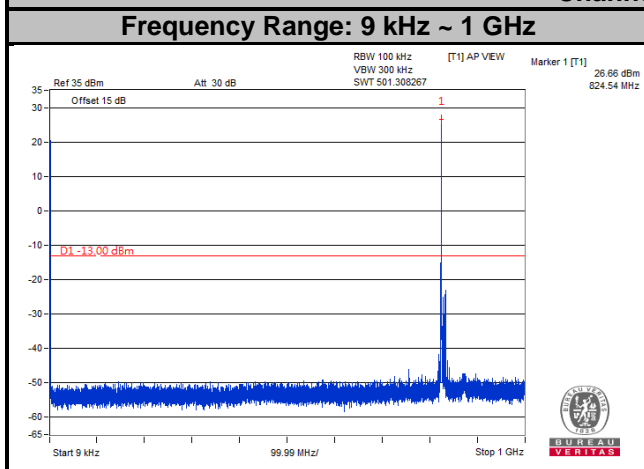

**Channel 20525**

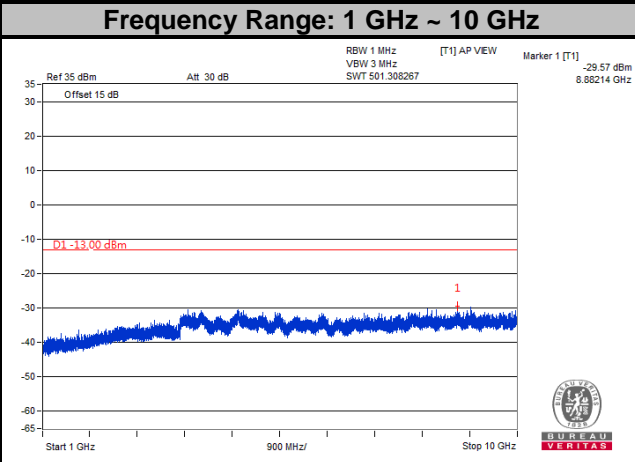
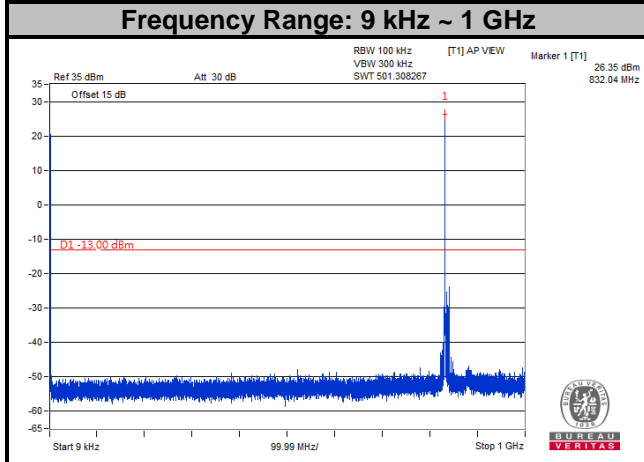

**Channel 20600**

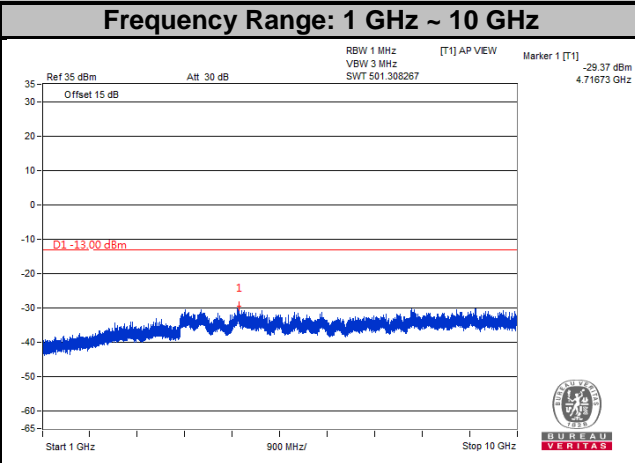
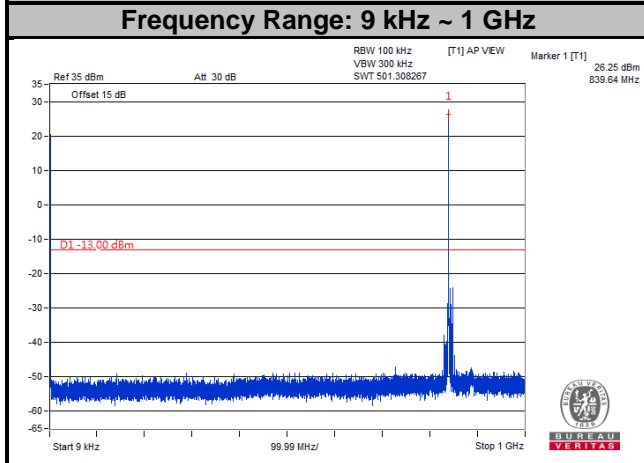

## 4.8 Radiated Emission Measurement

### 4.8.1 Limits of Radiated Emission Measurement

The power of any emission outside of the authorized operating frequency ranges must be attenuated below the transmitting power (P) by a factor of at least  $43 + 10 \log(P)$  dB. The emission limit is equal to -13 dBm.

### 4.8.2 Test Procedure

- a. Substitution method is used for E.I.R.P measurement. In the semi-anechoic chamber, EUT placed on the 0.8 m (below or equal 1 GHz) and/or 1.5 m (above 1 GHz) height of Turn Table, rotated the table around 360 degrees to search the maximum radiation power and receiver antenna shall be rotated vertical and horizontal polarization and moved height from 1 m to 4 m to find the maximum polar radiated power. The "Read Value" is the spectrum reading the maximum power value.
- b. The substitution horn antenna is substituted for EUT at the same position and signals generator export the CW signal to the substitution antenna via a TX cable. Rotated the Turn Table and moved receiving antenna to find the maximum radiation power. Adjust output power level of S.G to get a Value of spectrum reading equal to "Read Value" of step a. Record the power level of S.G
- c. EIRP = Output power level of S.G – TX cable loss + Antenna gain of substitution horn.
- d. E.R.P power can be calculated form E.I.R.P power by subtracting the gain of dipole, E.R.P power = E.I.R.P power - 2.15 dB.

**NOTE:** The resolution bandwidth and video bandwidth of test receiver/spectrum analyzer is 1 MHz/3 MHz.

### 4.8.3 Deviation from Test Standard

No deviation.



4.8.4 Test Setup

<Radiated Emission below or equal 1 GHz>

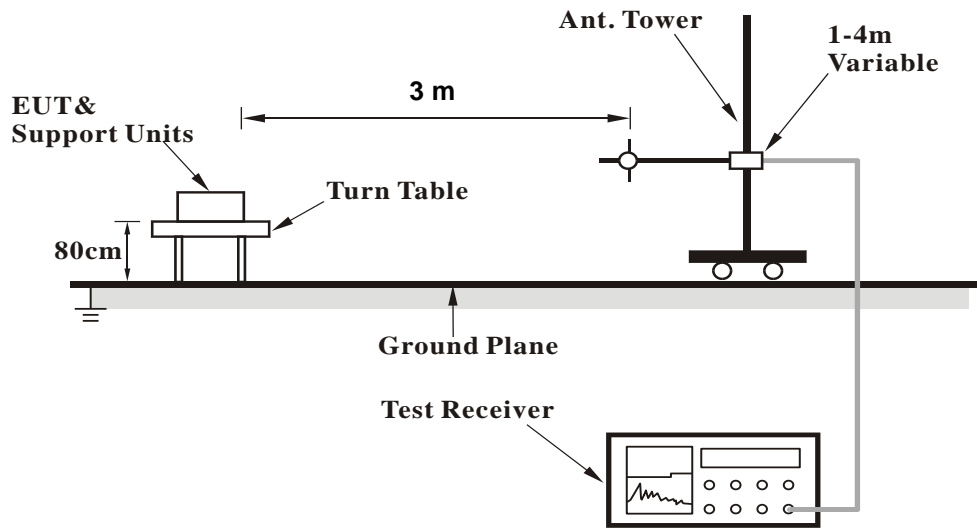

<Radiated Emission above 1 GHz>

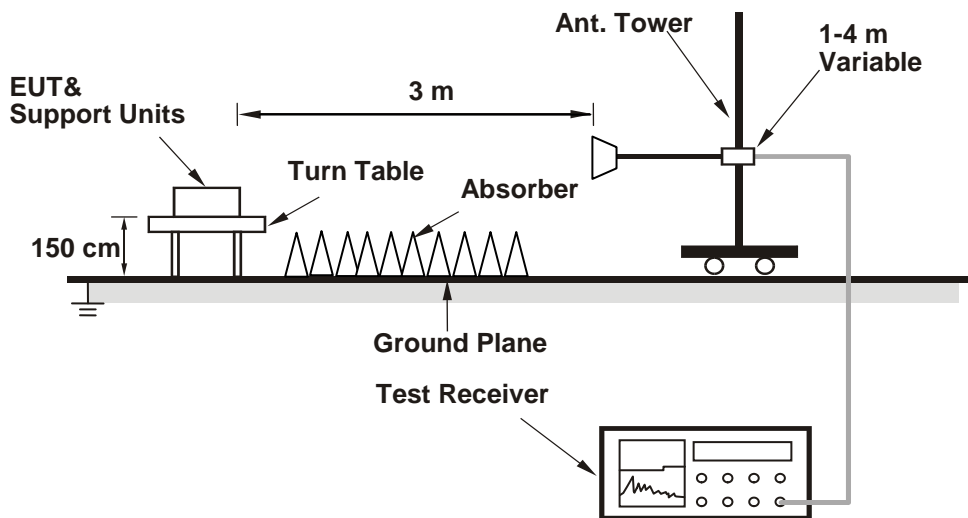

For the actual test configuration, please refer to the attached file (Test Setup Photo).

4.8.5 Test Results

GSM:  
Low Channel



Bureau Veritas Consumer Products Services Ltd., Taoyuan Branch

A D T

Data: 9

Date: 2018-09-14

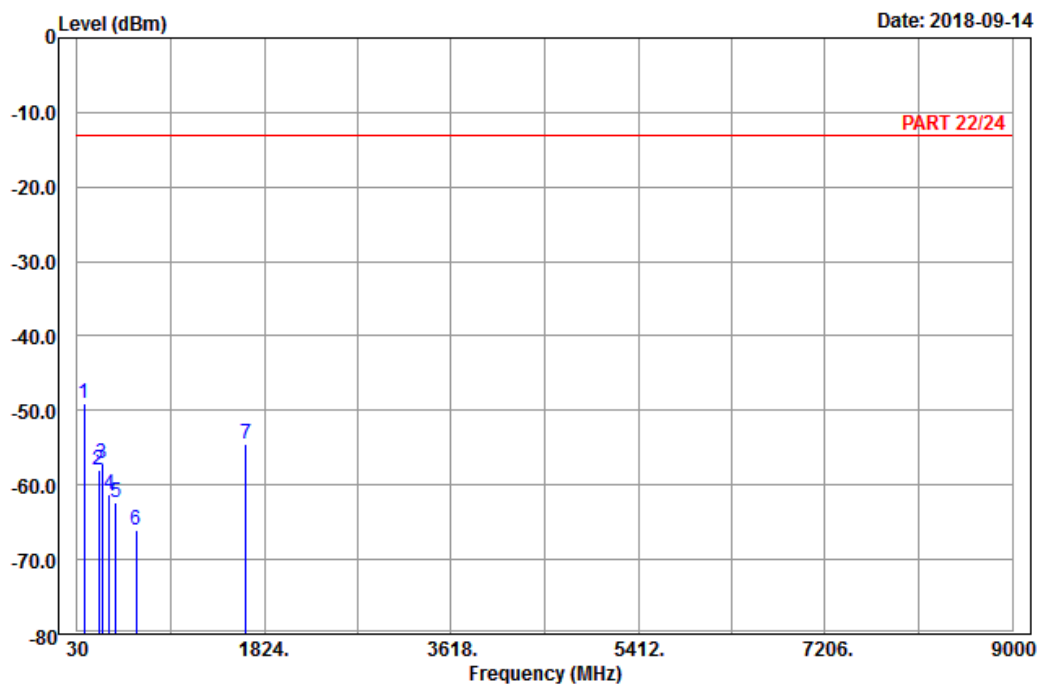

Site : 966 chamber 1  
 Condition: PART 22/24 Horizontal  
 Remark : GSM 850\_Link\_CH128  
 Tested by: Karl Lee

	Freq	Level	Read Level	Limit Line	Over Limit	Factor	Remark
	MHz	dBm	dBm	dBm	dB	dB	
1 pp	95.07	-49.09	-38.69	-13.00	-36.09	-10.40	Peak
2	240.33	-57.93	-52.29	-13.00	-44.93	-5.64	Peak
3	266.52	-57.19	-51.53	-13.00	-44.19	-5.66	Peak
4	337.10	-61.26	-55.74	-13.00	-48.26	-5.52	Peak
5	400.80	-62.28	-59.52	-13.00	-49.28	-2.76	Peak
6	598.20	-65.96	-66.31	-13.00	-52.96	0.35	Peak
7	1648.40	-54.55	-62.28	-13.00	-41.55	7.73	Peak



Bureau Veritas Consumer Products Services Ltd., Taoyuan Branch

A D T

Data: 10

Date: 2018-09-14

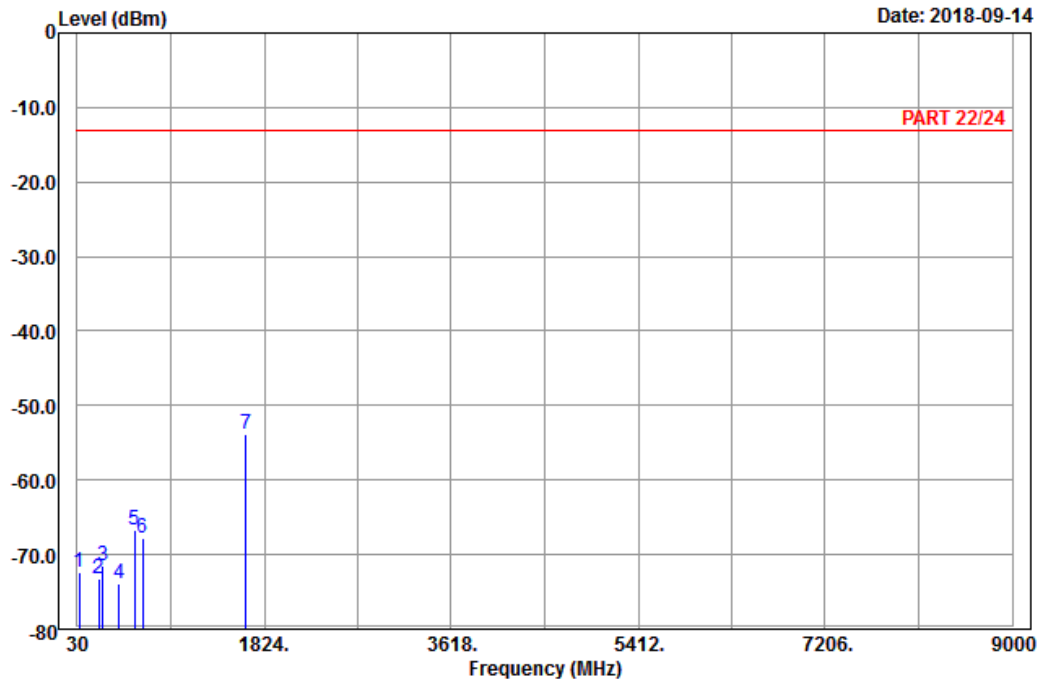

Site : 966 chamber 1  
 Condition: PART 22/24 Vertical  
 Remark : GSM 850\_Link\_CH128  
 Tested by: Karl Lee

	Freq	Level	Read Level	Limit Line	Over Limit	Factor	Remark
	MHz	dBm	dBm	dBm	dB	dB	
1	52.95	-72.36	-58.30	-13.00	-59.36	-14.06	Peak
2	235.20	-73.26	-67.56	-13.00	-60.26	-5.70	Peak
3	275.97	-71.52	-65.77	-13.00	-58.52	-5.75	Peak
4	433.00	-73.93	-70.47	-13.00	-60.93	-3.46	Peak
5	583.50	-66.73	-66.47	-13.00	-53.73	-0.26	Peak
6	658.40	-67.75	-67.57	-13.00	-54.75	-0.18	Peak
7 pp	1648.40	-53.78	-61.51	-13.00	-40.78	7.73	Peak

Middle Channel



Bureau Veritas Consumer Products Services Ltd., Taoyuan Branch

A D T

Data: 5

Date: 2018-09-14

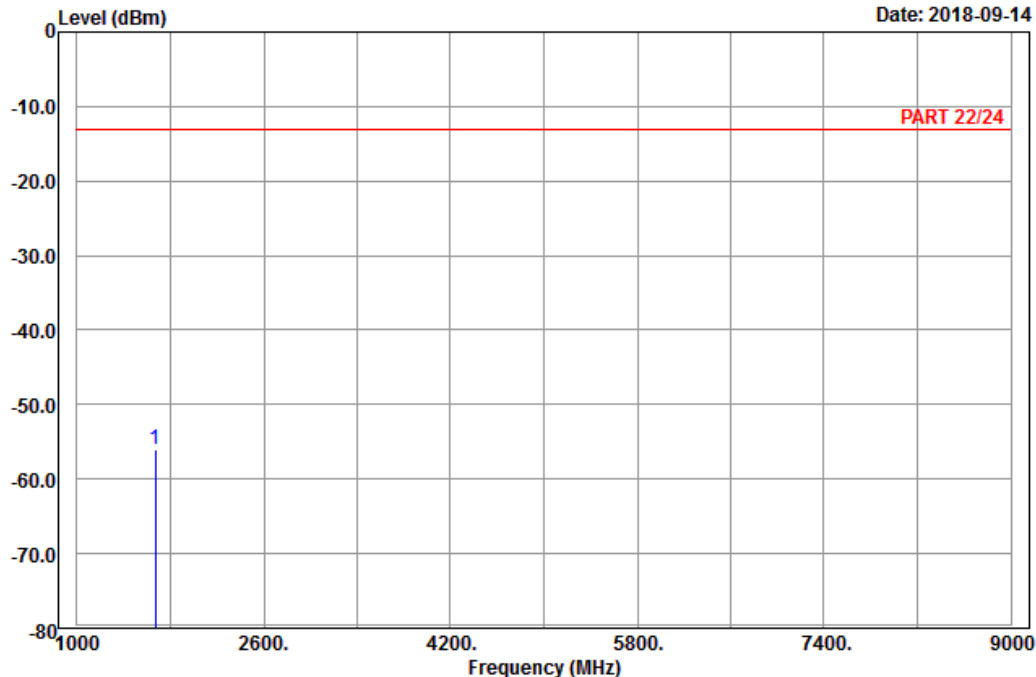

Site : 966 chamber 1  
 Condition: PART 22/24 Horizontal  
 Remark : GSM 850\_Link\_CH189  
 Tested by: Charles Hsiao

Freq	Level	Read Level	Limit	Over	Factor	Remark
MHz	dBm	dBm	dBm	dB	dB	
1 pp 1672.80	-55.92	-63.83	-13.00	-42.92	7.91	Peak



Bureau Veritas Consumer Products Services Ltd., Taoyuan Branch

A D T

Data: 6

Date: 2018-09-14

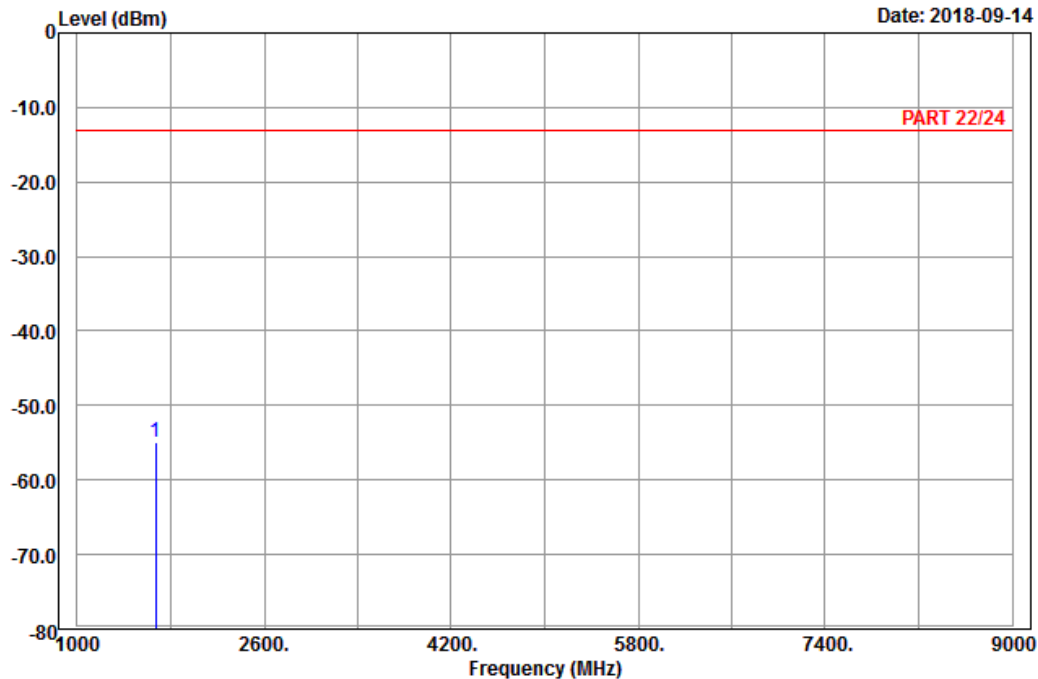

Site : 966 chamber 1  
 Condition: PART 22/24 Vertical  
 Remark : GSM 850\_Link\_CH189  
 Tested by: Charles Hsiao

	Freq	Level	Read Level	Limit Line	Over Limit	Factor	Remark
	MHz	dBm	dBm	dBm	dB	dB	
1	pp 1672.80	-54.87	-62.78	-13.00	-41.87	7.91	Peak

High Channel



Bureau Veritas Consumer Products Services Ltd., Taoyuan Branch

A D T

Data: 5

Date: 2018-09-14

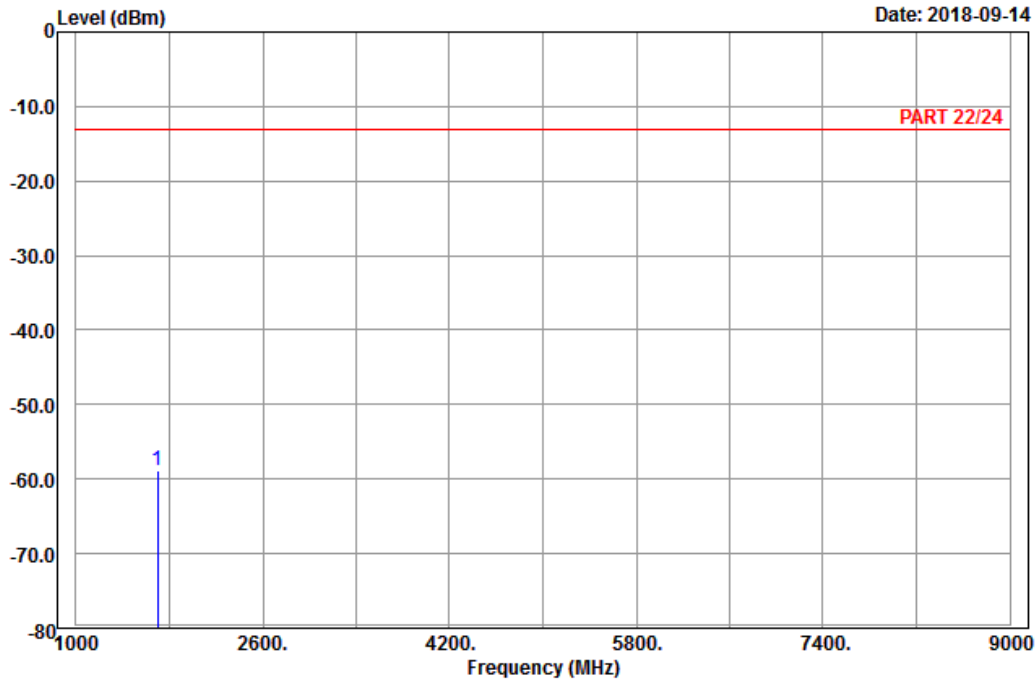

Site : 966 chamber 1  
 Condition: PART 22/24 Horizontal  
 Remark : GSM 850\_Link\_CH251  
 Tested by: Karl Lee

	Read	Limit	Over			
Freq	Level	Level	Line	Limit	Factor	Remark
MHz	dBm	dBm	dBm	dB	dB	
1 pp 1697.60	-58.92	-67.06	-13.00	-45.92	8.14	Peak



Bureau Veritas Consumer Products Services Ltd., Taoyuan Branch

A D T

Data: 6

Date: 2018-09-14

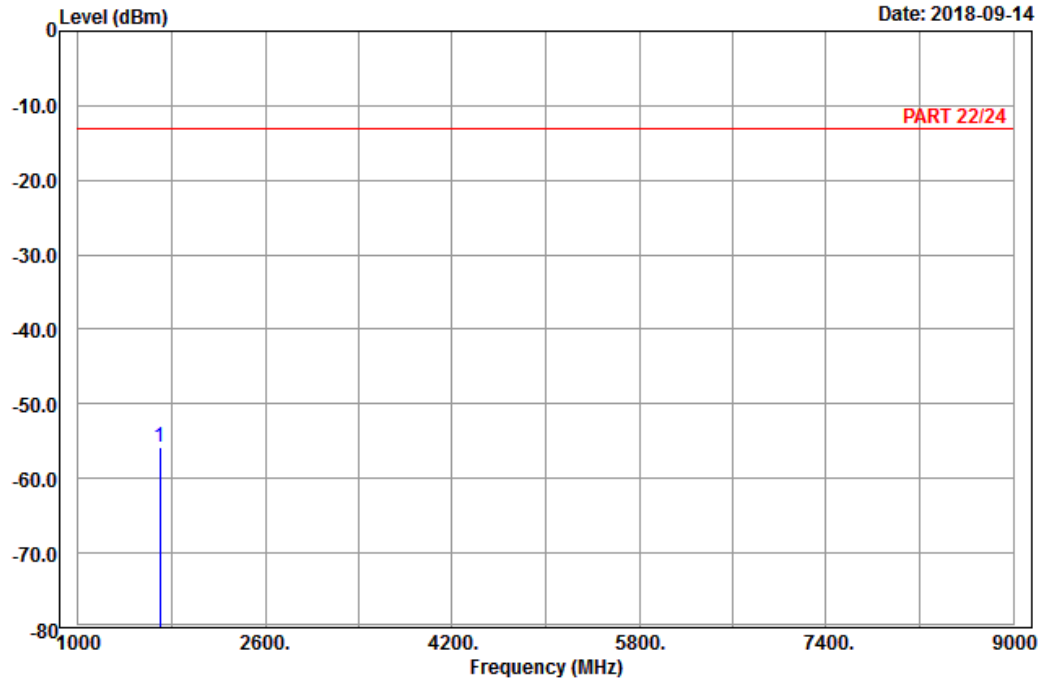

Site : 966 chamber 1  
 Condition: PART 22/24 Vertical  
 Remark : GSM 850\_Link\_CH251  
 Tested by: Karl Lee

	Read	Limit	Over			
Freq	Level	Level	Line	Limit	Factor	Remark
MHz	dBm	dBm	dBm	dB	dB	
1 pp 1697.60	-55.78	-63.92	-13.00	-42.78	8.14	Peak

EDGE:  
Low Channel



Bureau Veritas Consumer Products Services Ltd., Taoyuan Branch

A D T

Data: 5

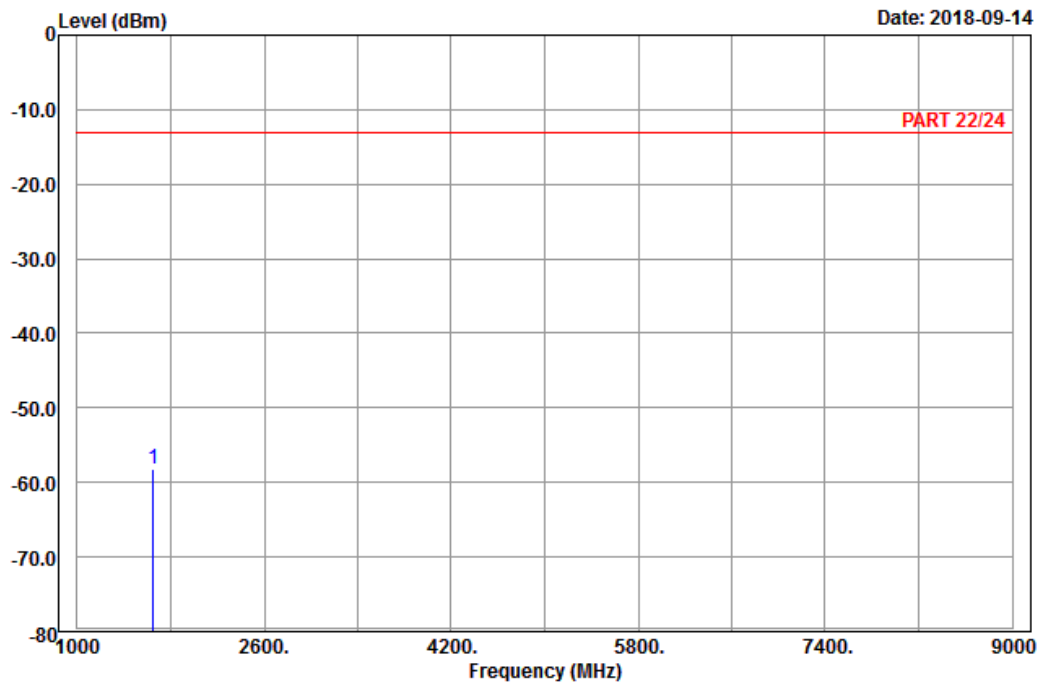

Site : 966 chamber 1  
Condition: PART 22/24 Horizontal  
Remark : EDGE 850\_Link\_CH128  
Tested by: Karl Lee

	Read	Limit	Over			
Freq	Level	Level	Line	Limit	Factor	Remark
MHz	dBm	dBm	dBm	dB	dB	
1 pp 1648.40	-58.22	-65.95	-13.00	-45.22	7.73	Peak





A D T

Data: 6

Date: 2018-09-14

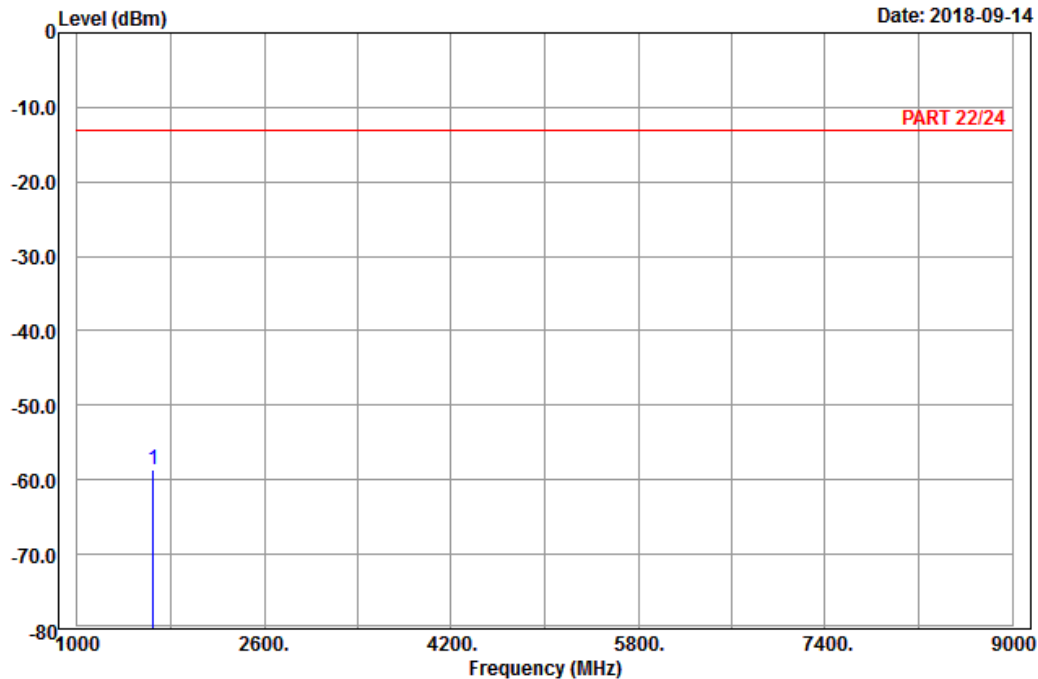

Site : 966 chamber 1  
 Condition: PART 22/24 Vertical  
 Remark : EDGE 850\_Link\_CH128  
 Tested by: Karl Lee

	Freq	Level	Read Level	Limit Line	Over Limit	Factor	Remark
	MHz	dBm	dBm	dBm	dB	dB	
1	pp 1648.40	-58.72	-66.45	-13.00	-45.72	7.73	Peak

Middle Channel



Bureau Veritas Consumer Products Services Ltd., Taoyuan Branch

A D T

Data: 5

Date: 2018-09-14

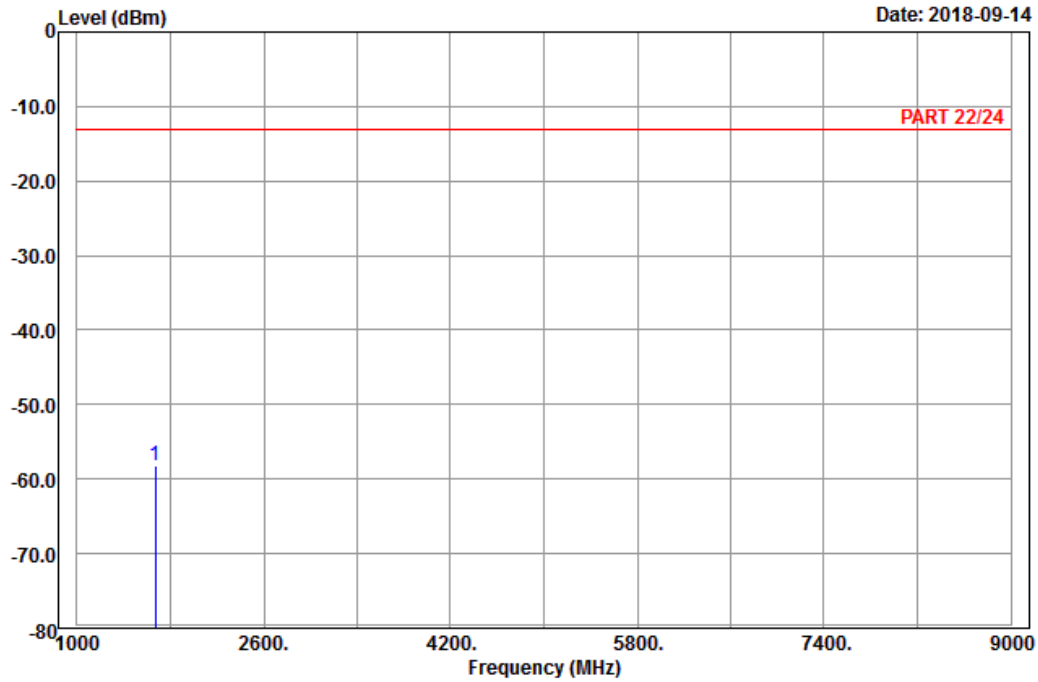

Site : 966 chamber 1  
 Condition: PART 22/24 Horizontal  
 Remark : EDGE 850\_Link\_CH189  
 Tested by: Karl Lee

Freq	Level	Read Level	Limit Line	Over Limit	Factor	Remark
MHz	dBm	dBm	dBm	dB	dB	
1 pp 1672.80	-58.10	-66.01	-13.00	-45.10	7.91	Peak



Bureau Veritas Consumer Products Services Ltd., Taoyuan Branch

A D T

Data: 6

Date: 2018-09-14

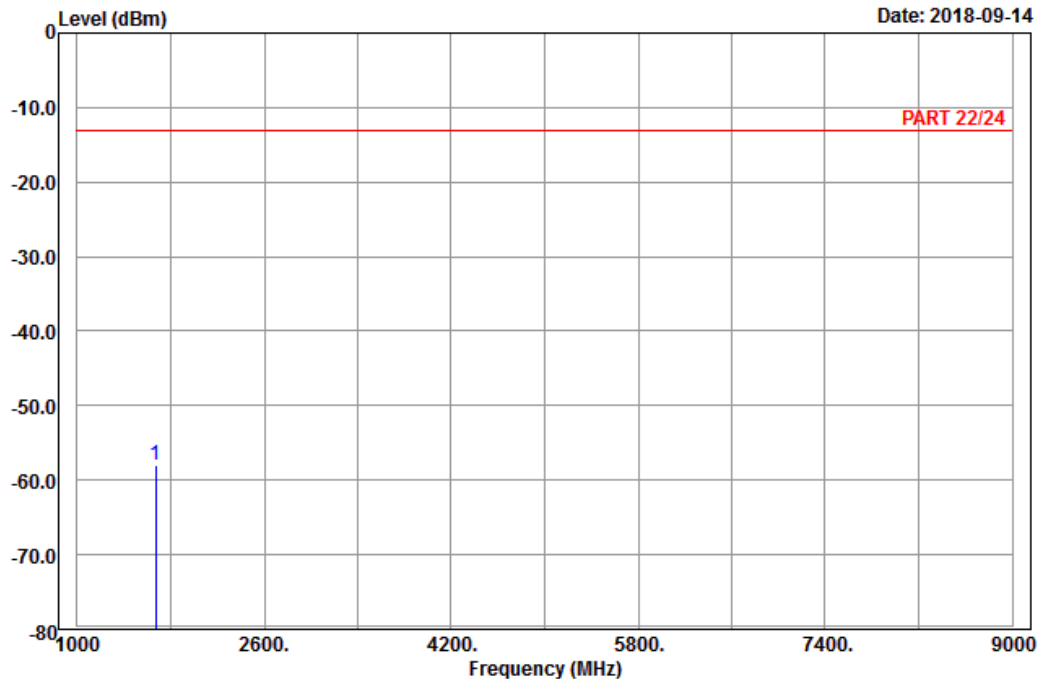

Site : 966 chamber 1  
 Condition: PART 22/24 Vertical  
 Remark : EDGE 850\_Link\_CH189  
 Tested by: Karl Lee

	Freq	Level	Read Level	Limit Line	Over Limit	Factor	Remark
	MHz	dBm	dBm	dBm	dB	dB	
1	pp 1672.80	-58.01	-65.92	-13.00	-45.01	7.91	Peak

High Channel



Bureau Veritas Consumer Products Services Ltd., Taoyuan Branch

A D T

Data: 5

Date: 2018-09-14

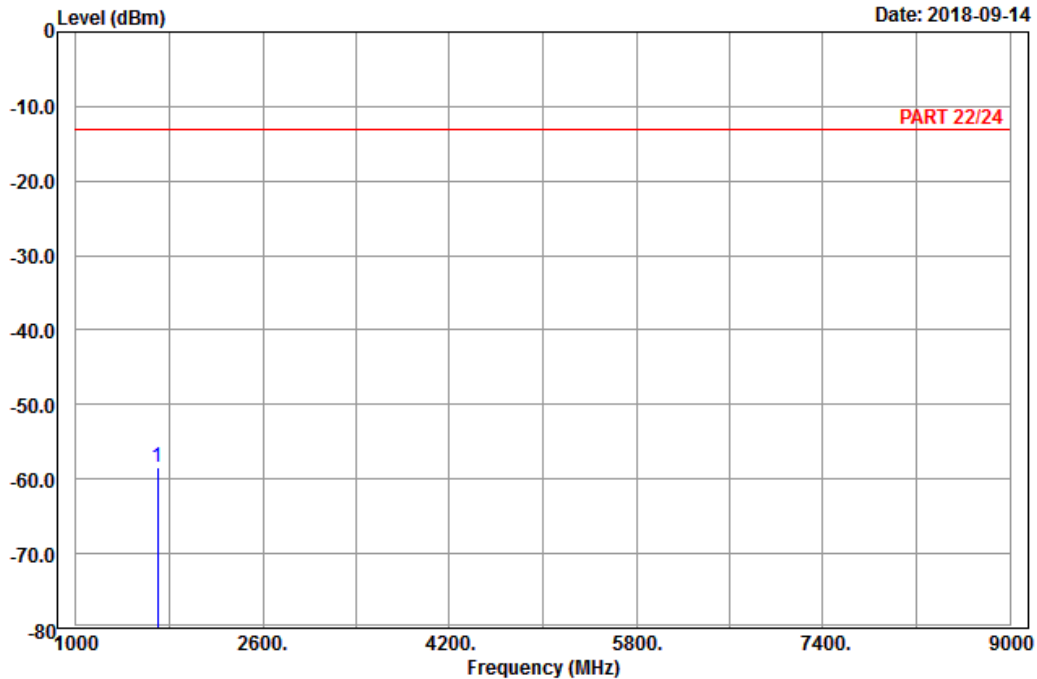

Site : 966 chamber 1  
 Condition: PART 22/24 Horizontal  
 Remark : EDGE 850\_Link\_CH251  
 Tested by: Karl Lee

	Freq	Level	Read Level	Limit Line	Over Limit	Factor	Remark
	MHz	dBm	dBm	dBm	dB	dB	
1	pp 1697.60	-58.36	-66.50	-13.00	-45.36	8.14	Peak



Bureau Veritas Consumer Products Services Ltd., Taoyuan Branch

A D T

Data: 6

Date: 2018-09-14

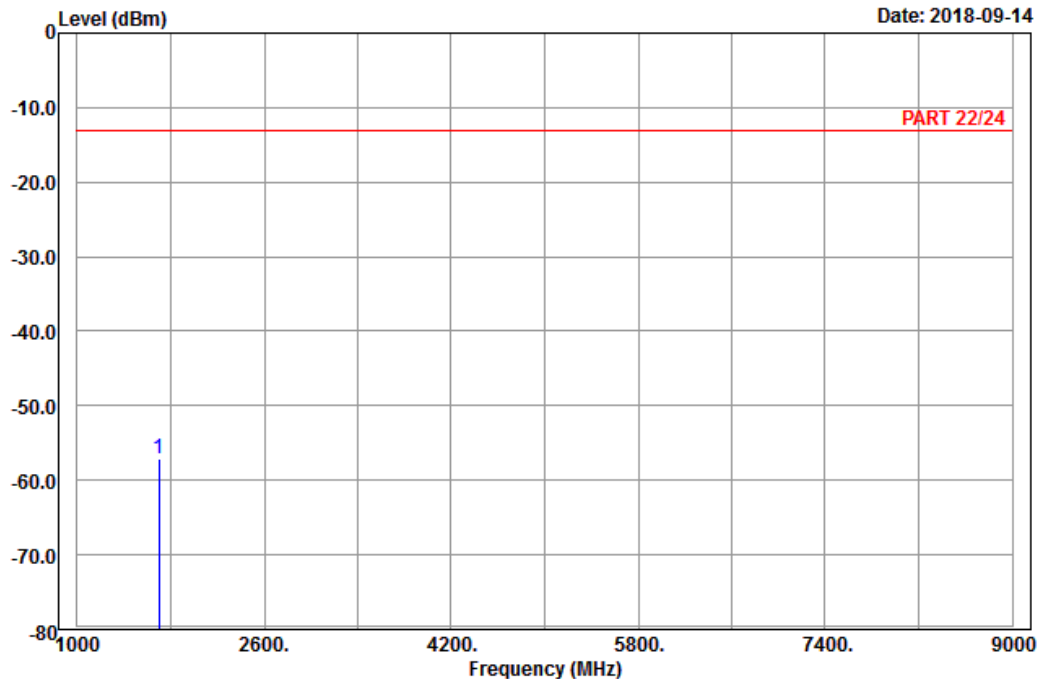

Site : 966 chamber 1  
 Condition: PART 22/24 Vertical  
 Remark : EDGE 850\_Link\_CH251  
 Tested by: Karl Lee

	Freq	Level	Read Level	Limit Line	Over Limit	Factor	Remark
	MHz	dBm	dBm	dBm	dB	dB	
1	pp 1697.60	-57.08	-65.22	-13.00	-44.08	8.14	Peak

WCDMA:  
Low Channel



Bureau Veritas Consumer Products Services Ltd., Taoyuan Branch

A D T

Data: 5

Date: 2018-09-14

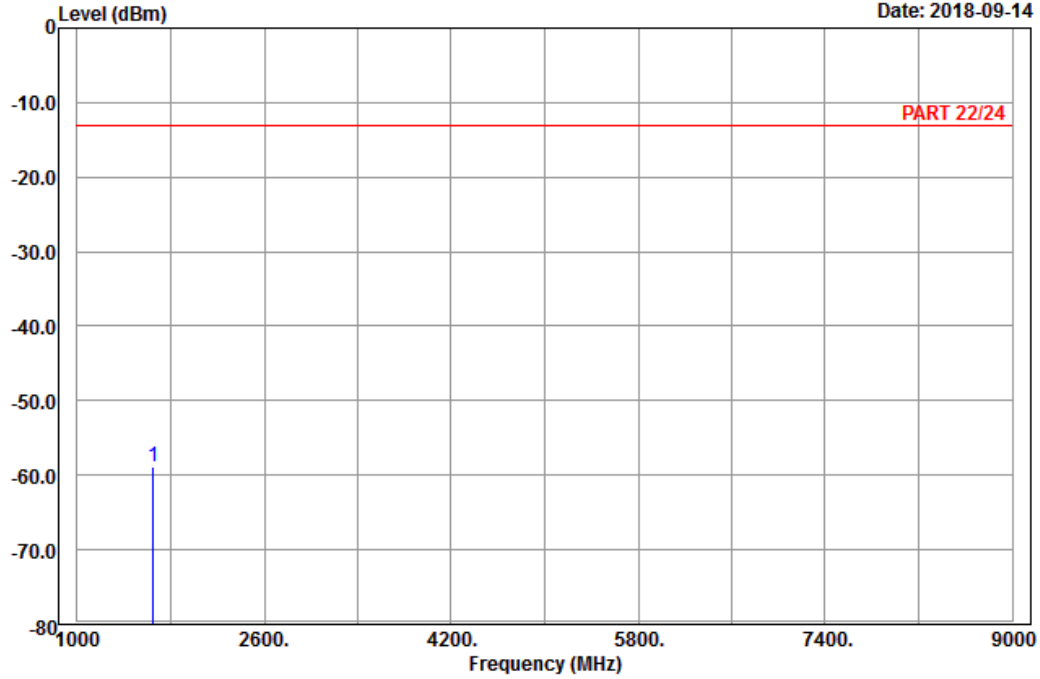

Site : 966 chamber 1  
Condition: PART 22/24 Horizontal  
Remark : Band V\_Link\_CH4132  
Tested by: Charles Hsiao

	Read	Limit	Over				
Freq	Level	Level	Line	Limit	Factor	Remark	
MHz	dBm	dBm	dBm	dB	dB		
1 pp 1652.80	-58.78	-66.51	-13.00	-45.78	7.73	Peak	



Bureau Veritas Consumer Products Services Ltd., Taoyuan Branch

A D T

Data: 6

Date: 2018-09-14

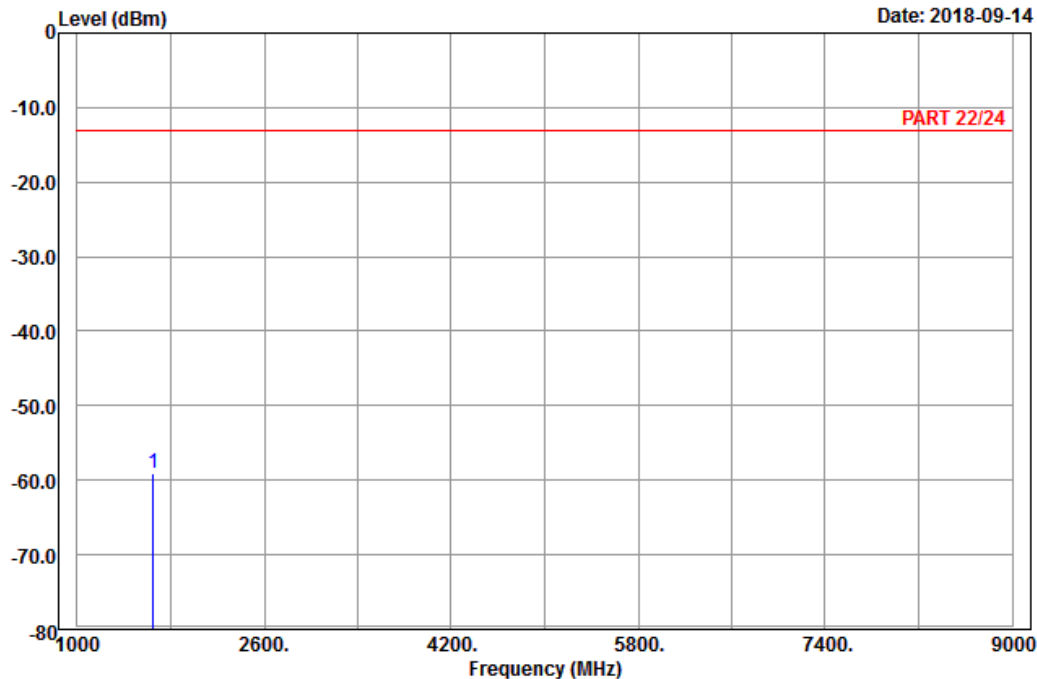

Site : 966 chamber 1  
 Condition: PART 22/24 Vertical  
 Remark : Band V\_Link\_CH4132  
 Tested by: Charles Hsiao

	Freq	Level	Read Level	Limit Line	Over Limit	Factor	Remark
	MHz	dBm	dBm	dBm	dB	dB	
1	pp 1652.80	-58.99	-66.72	-13.00	-45.99	7.73	Peak

Middle Channel



Bureau Veritas Consumer Products Services Ltd., Taoyuan Branch

A D T

Data: 5

Date: 2018-09-14

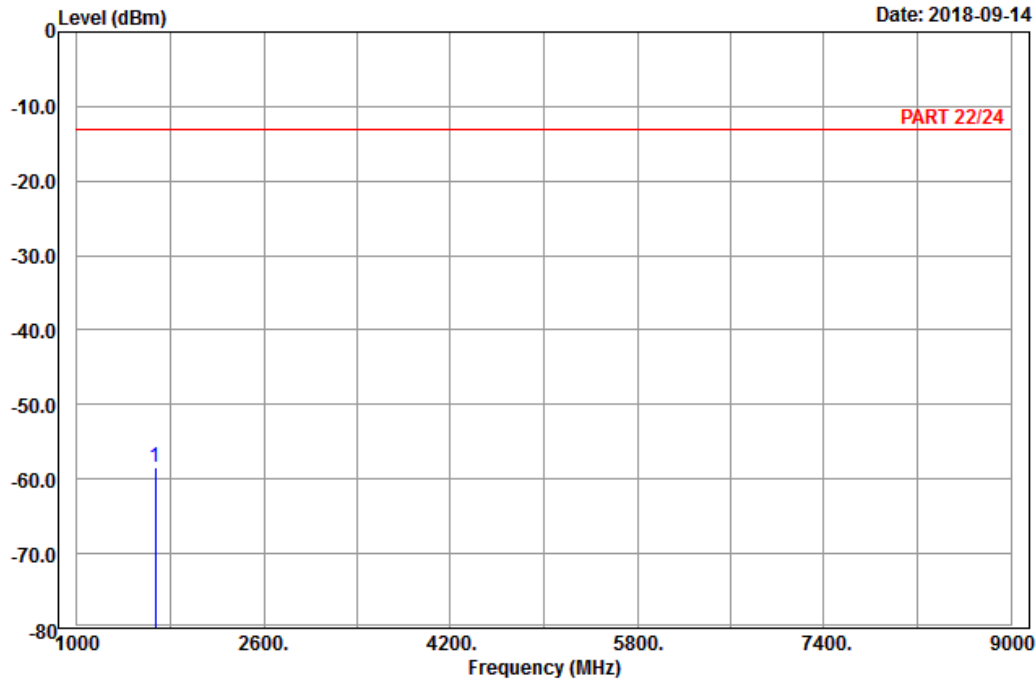

Site : 966 chamber 1  
 Condition: PART 22/24 Horizontal  
 Remark : Band V\_Link\_CH4182  
 Tested by: Charles Hsiao

Freq	Level	Read Level	Limit	Over Limit	Factor	Remark
MHz	dBm	dBm	dBm	dB	dB	
1 pp 1672.80	-58.48	-66.39	-13.00	-45.48	7.91	Peak





Bureau Veritas Consumer Products Services Ltd., Taoyuan Branch

A D T

Data: 6

Date: 2018-09-14

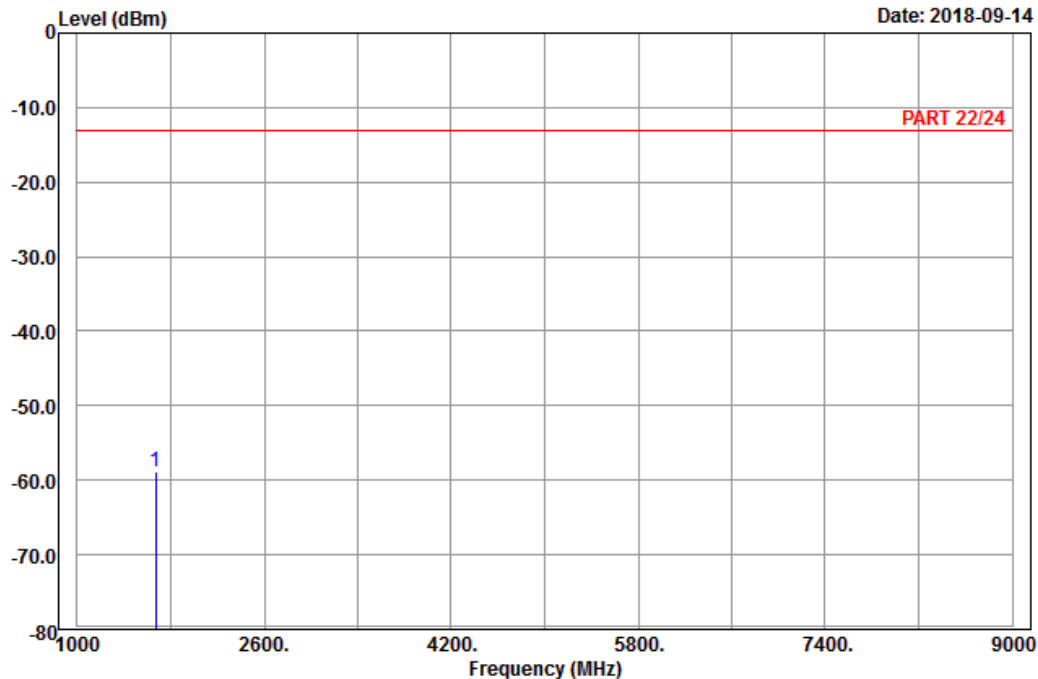

Site : 966 chamber 1  
 Condition: PART 22/24 Vertical  
 Remark : Band V\_Link\_CH4182  
 Tested by: Charles Hsiao

	Freq	Level	Read Level	Limit Line	Over Limit	Factor	Remark
	MHz	dBm	dBm	dBm	dB	dB	
1	pp 1672.80	-58.79	-66.70	-13.00	-45.79	7.91	Peak

High Channel



Bureau Veritas Consumer Products Services Ltd., Taoyuan Branch

A D T

Data: 5

Date: 2018-09-14

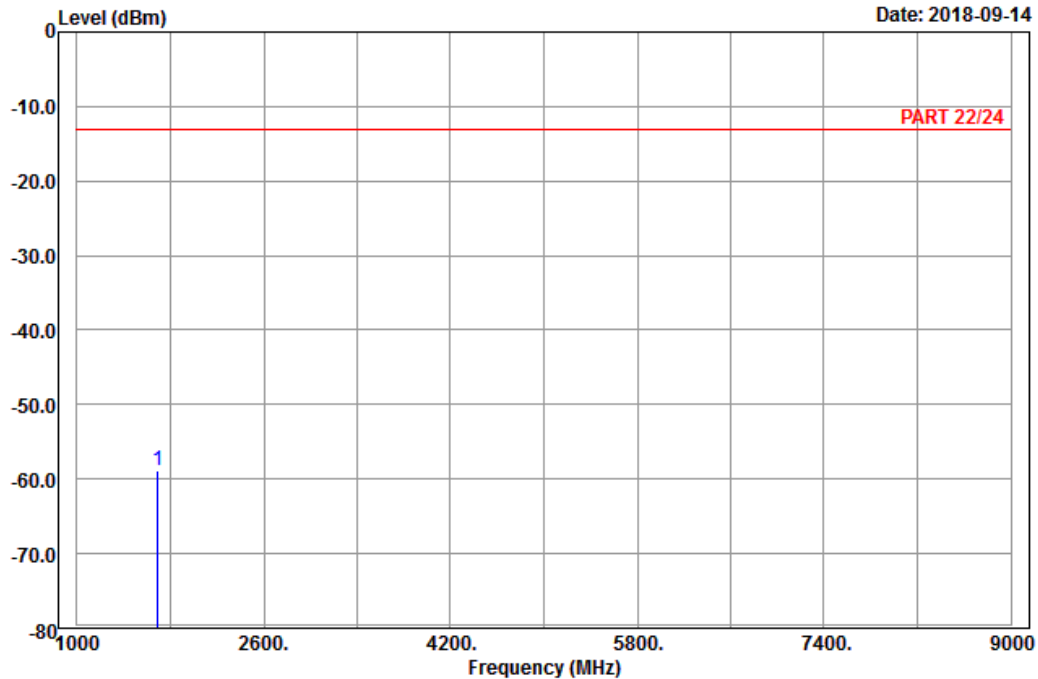

Site : 966 chamber 1  
 Condition: PART 22/24 Horizontal  
 Remark : Band V\_Link\_CH4233  
 Tested by: Charles Hsiao

Freq	Level	Read Level	Limit	Over	Factor	Remark
MHz	dBm	dBm	dBm	dB	dB	
1 pp 1693.20	-58.84	-66.98	-13.00	-45.84	8.14	Peak



Bureau Veritas Consumer Products Services Ltd., Taoyuan Branch

A D T

Data: 6

Date: 2018-09-14

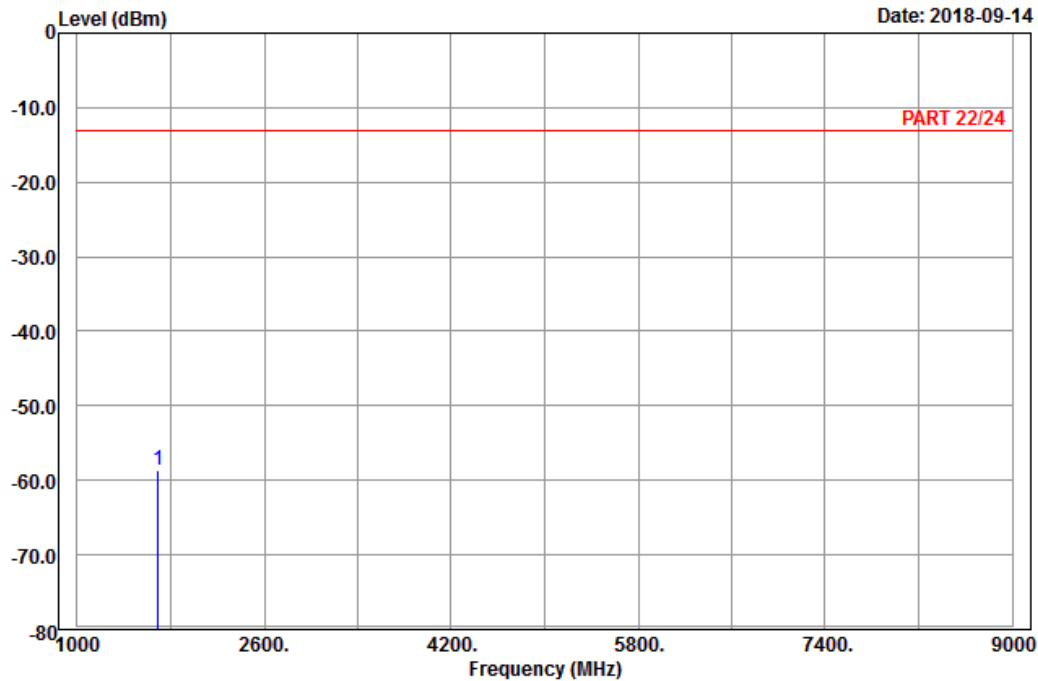

Site : 966 chamber 1  
 Condition: PART 22/24 Vertical  
 Remark : Band V\_Link\_CH4233  
 Tested by: Charles Hsiao

	Freq	Level	Read Level	Limit Line	Over Limit	Factor	Remark
	MHz	dBm	dBm	dBm	dB	dB	
1	pp 1693.20	-58.62	-66.76	-13.00	-45.62	8.14	Peak

LTE Band 5  
 Channel Bandwidth: 1.4 MHz / QPSK  
 Low Channel



Bureau Veritas Consumer Products Services Ltd., Taoyuan Branch

A D T

Data: 5

Date: 2018-09-13

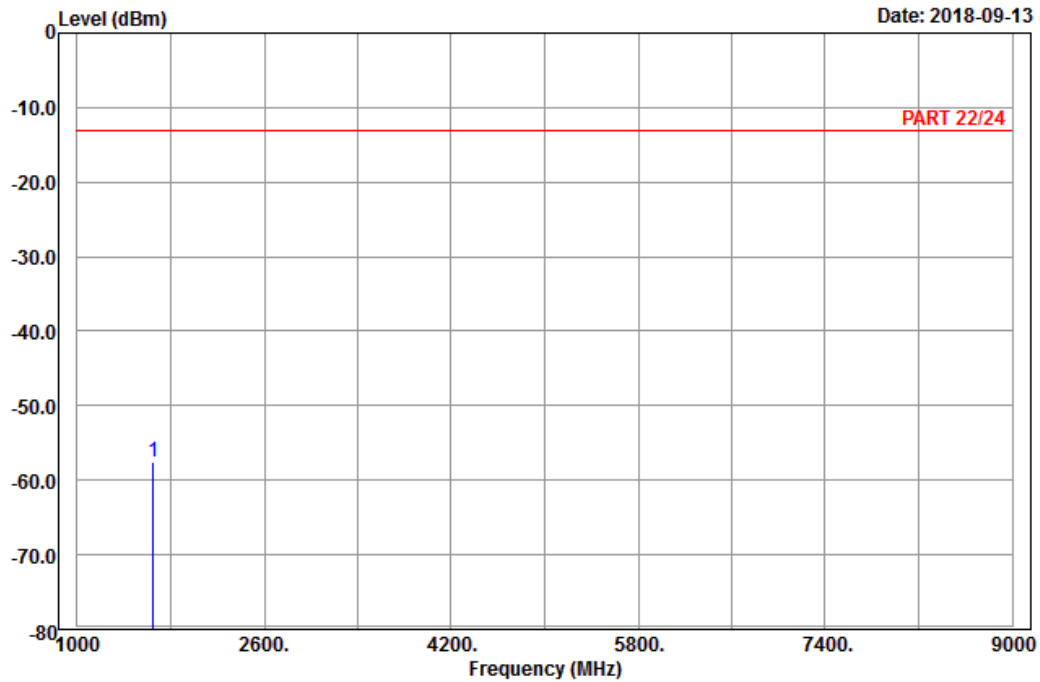

Site : 966 chamber 1  
 Condition: PART 22/24 Horizontal  
 Remark : LTE\_Band 5\_Link\_CH20407  
 Tested by: Harry Hsueh

	Read	Limit	Over			
Freq	Level	Level	Line	Limit	Factor	Remark
MHz	dBm	dBm	dBm	dB	dB	
1 pp 1649.40	-57.51	-65.24	-13.00	-44.51	7.73	Peak



Bureau Veritas Consumer Products Services Ltd., Taoyuan Branch

A D T

Data: 6

Date: 2018-09-13

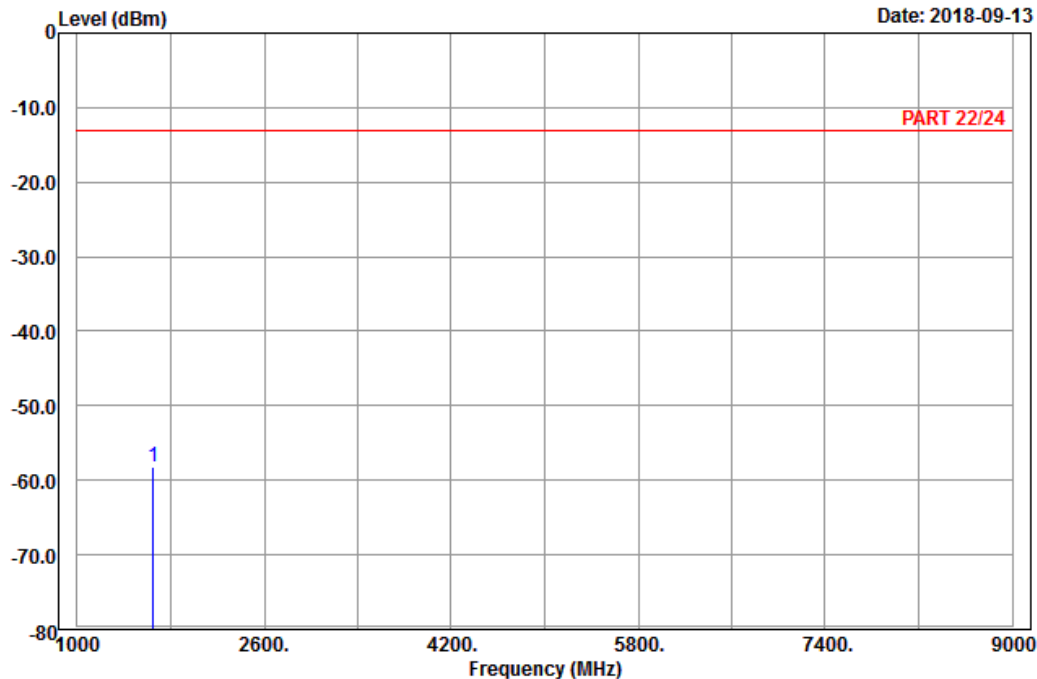

Site : 966 chamber 1  
 Condition: PART 22/24 Vertical  
 Remark : LTE\_Band 5\_Link\_CH20407  
 Tested by: Harry Hsueh

	Freq	Level	Read Level	Limit Line	Over Limit	Factor	Remark
	MHz	dBm	dBm	dBm	dB	dB	
1	pp 1649.40	-58.20	-65.93	-13.00	-45.20	7.73	Peak

Middle Channel



Bureau Veritas Consumer Products Services Ltd., Taoyuan Branch

A D T

Data: 5

Date: 2018-09-13

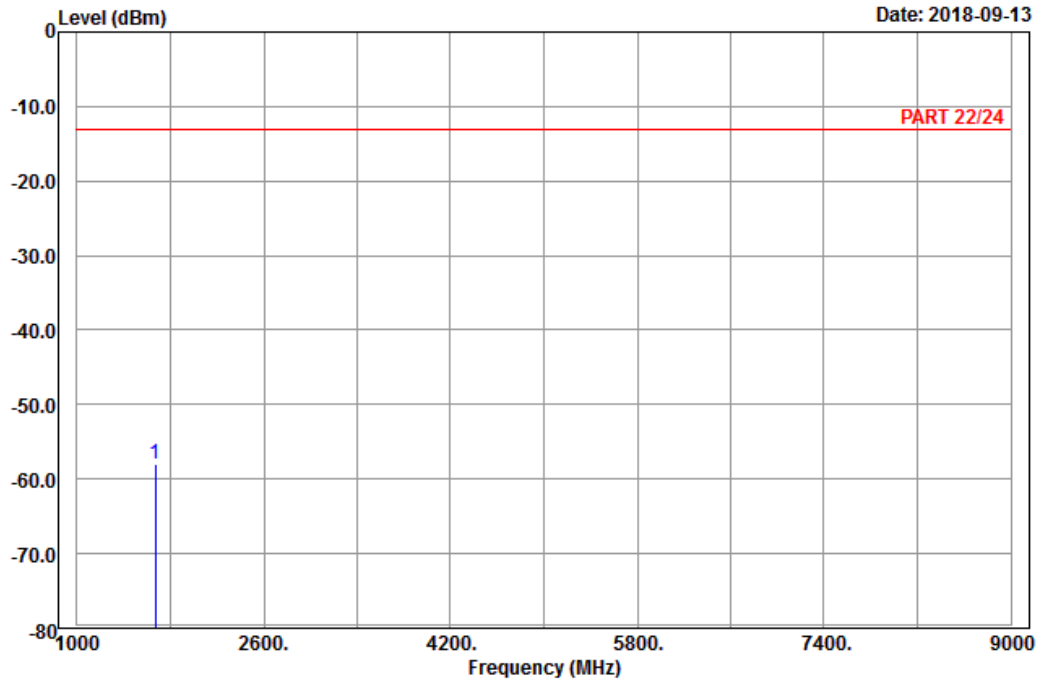

Site : 966 chamber 1  
 Condition: PART 22/24 Horizontal  
 Remark : LTE\_Band 5\_Link\_CH20525  
 Tested by: Harry Hsueh

	Read	Limit	Over			
Freq	Level	Level	Line	Limit	Factor	Remark
MHz	dBm	dBm	dBm	dB	dB	
1 pp 1673.00	-57.98	-65.89	-13.00	-44.98	7.91	Peak



A D T

Data: 6

Date: 2018-09-13

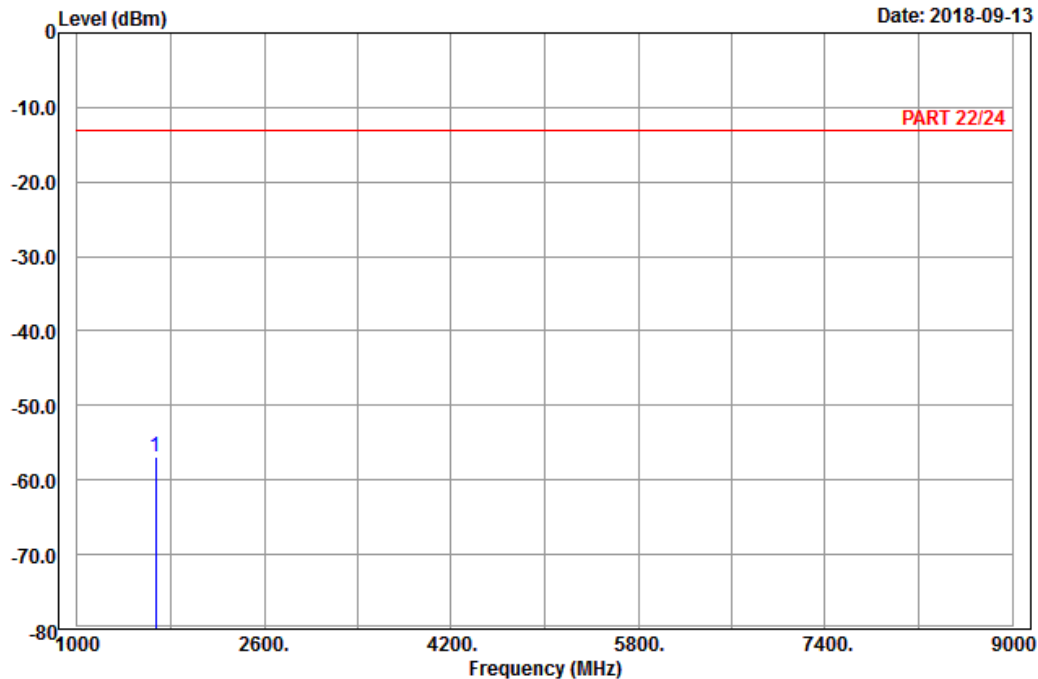

Site : 966 chamber 1  
 Condition: PART 22/24 Vertical  
 Remark : LTE\_Band 5\_Link\_CH20525  
 Tested by: Harry Hsueh

	Freq	Level	Read Level	Limit Line	Over Limit	Factor	Remark
	MHz	dBm	dBm	dBm	dB	dB	
1	pp 1673.00	-56.97	-64.88	-13.00	-43.97	7.91	Peak

High Channel



Bureau Veritas Consumer Products Services Ltd., Taoyuan Branch

A D T

Data: 5

Date: 2018-09-13

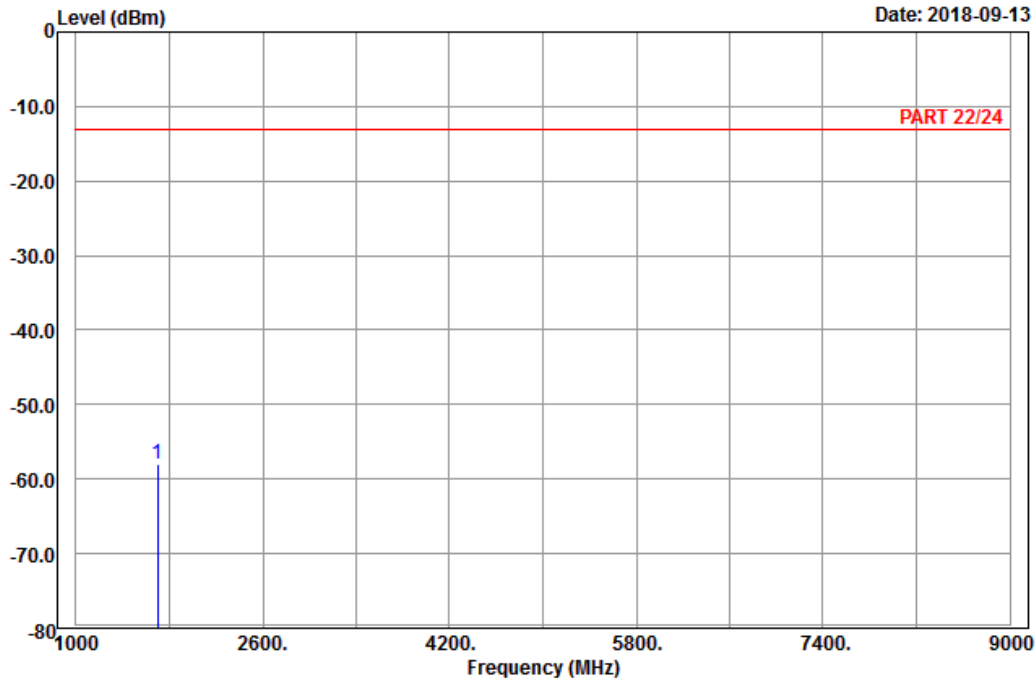

Site : 966 chamber 1  
 Condition: PART 22/24 Horizontal  
 Remark : LTE\_Band 5\_Link\_CH20643  
 Tested by: Harry Hsueh

Freq	Level	Read Level	Limit	Over	Factor	Remark
MHz	dBm	dBm	dBm	dB	dB	
1 pp 1696.60	-57.94	-66.08	-13.00	-44.94	8.14	Peak





Bureau Veritas Consumer Products Services Ltd., Taoyuan Branch

A D T

Data: 6

Date: 2018-09-13

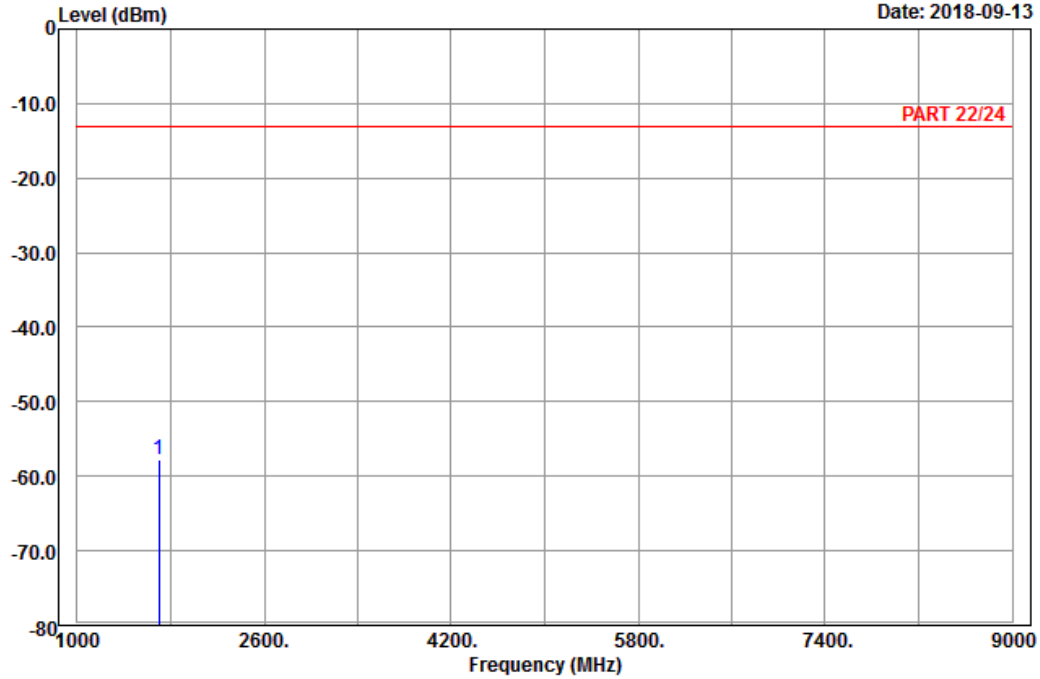

Site : 966 chamber 1  
 Condition: PART 22/24 Vertical  
 Remark : LTE\_Band 5\_Link\_CH20643  
 Tested by: Harry Hsueh

	Freq	Level	Read Level	Limit Line	Over Limit	Factor	Remark
	MHz	dBm	dBm	dBm	dB	dB	
1	pp 1696.60	-57.87	-66.01	-13.00	-44.87	8.14	Peak

Channel Bandwidth: 5 MHz / QPSK  
Low Channel



Bureau Veritas Consumer Products Services Ltd., Taoyuan Branch

A D T

Data: 5

Date: 2018-09-13

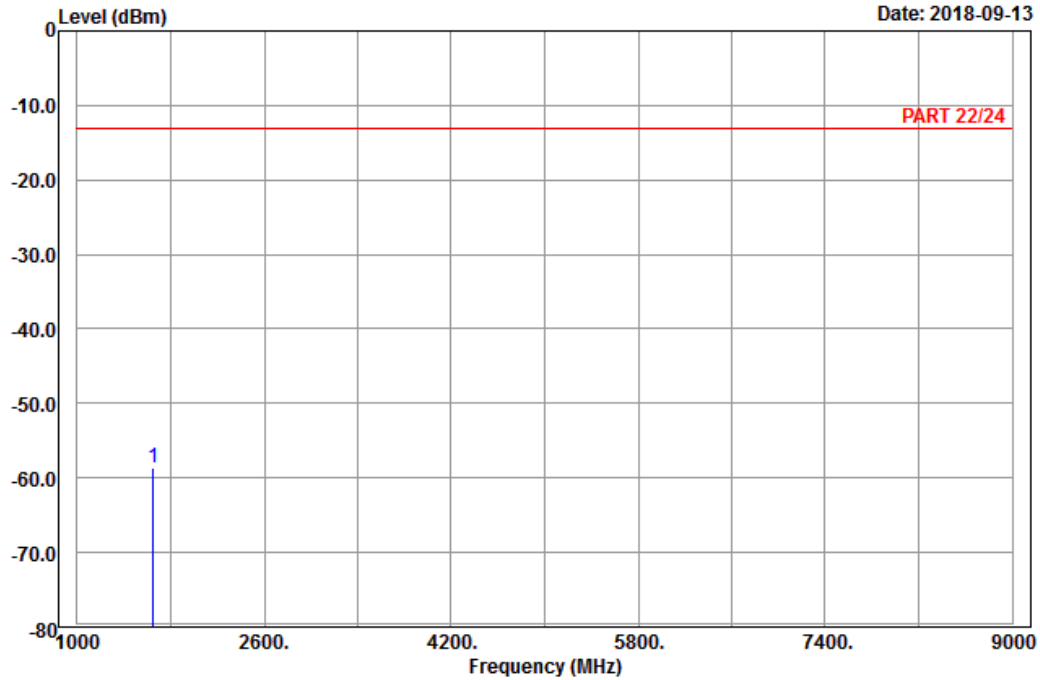

Site : 966 chamber 1  
Condition: PART 22/24 Horizontal  
Remark : LTE\_Band 5\_Link\_CH20425  
Tested by: Harry Hsueh

	Freq	Level	Read Level	Limit Line	Over Limit	Factor	Remark
	MHz	dBm	dBm	dBm	dB	dB	
1	pp 1653.00	-58.66	-66.39	-13.00	-45.66	7.73	Peak



A D T

Data: 6

Date: 2018-09-13

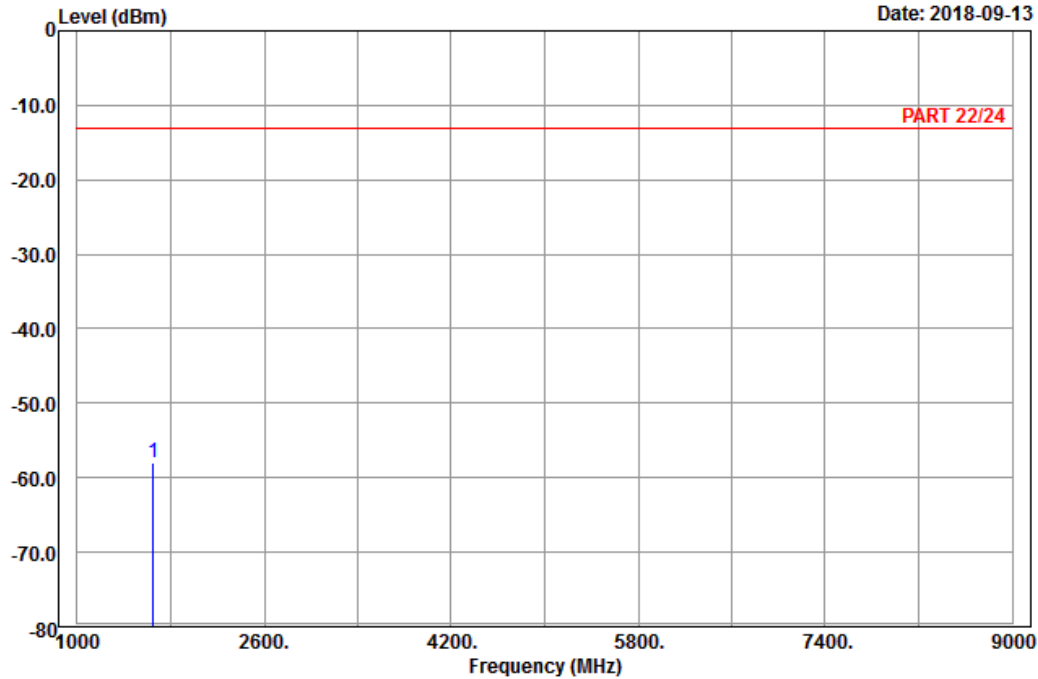

Site : 966 chamber 1  
 Condition: PART 22/24 Vertical  
 Remark : LTE\_Band 5\_Link\_CH20425  
 Tested by: Harry Hsueh

	Freq	Level	Read Level	Limit Line	Over Limit	Factor	Remark
	MHz	dBm	dBm	dBm	dB	dB	
1	pp 1653.00	-57.88	-65.61	-13.00	-44.88	7.73	Peak

Middle Channel



Bureau Veritas Consumer Products Services Ltd., Taoyuan Branch

A D T

Data: 5

Date: 2018-09-13

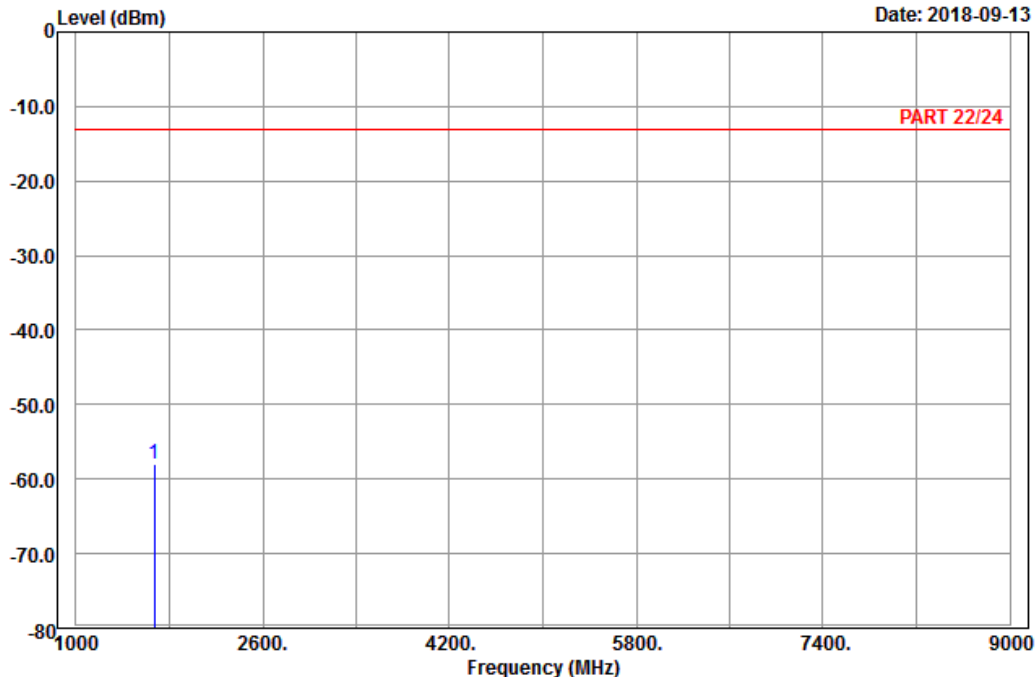

Site : 966 chamber 1  
 Condition: PART 22/24 Horizontal  
 Remark : LTE\_Band 5\_Link\_CH20525  
 Tested by: Harry Hsueh

Freq	Level	Read Level	Limit	Over	Factor	Remark
MHz	dBm	dBm	dBm	dB	dB	
1 pp 1673.00	-57.98	-65.89	-13.00	-44.98	7.91	Peak



A D T

Data: 6

Date: 2018-09-13

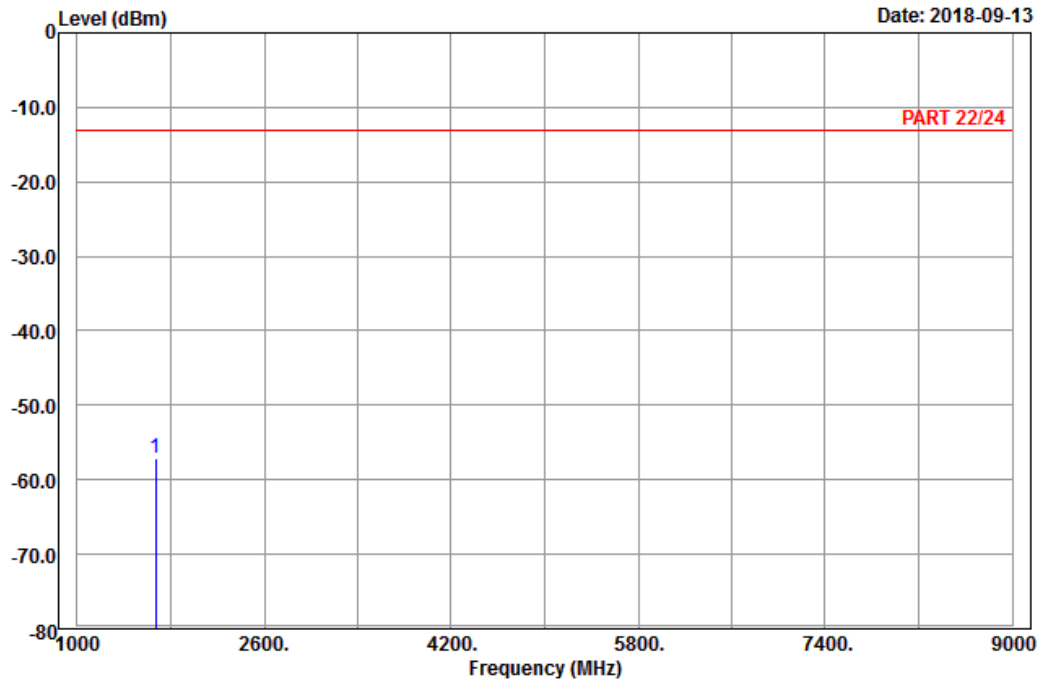

Site : 966 chamber 1  
 Condition: PART 22/24 Vertical  
 Remark : LTE\_Band 5\_Link\_CH20525  
 Tested by: Harry Hsueh

	Freq	Level	Read Level	Limit Line	Over Limit	Factor	Remark
	MHz	dBm	dBm	dBm	dB	dB	
1	pp 1673.00	-57.22	-65.13	-13.00	-44.22	7.91	Peak

High Channel



Bureau Veritas Consumer Products Services Ltd., Taoyuan Branch

A D T

Data: 5

Date: 2018-09-13

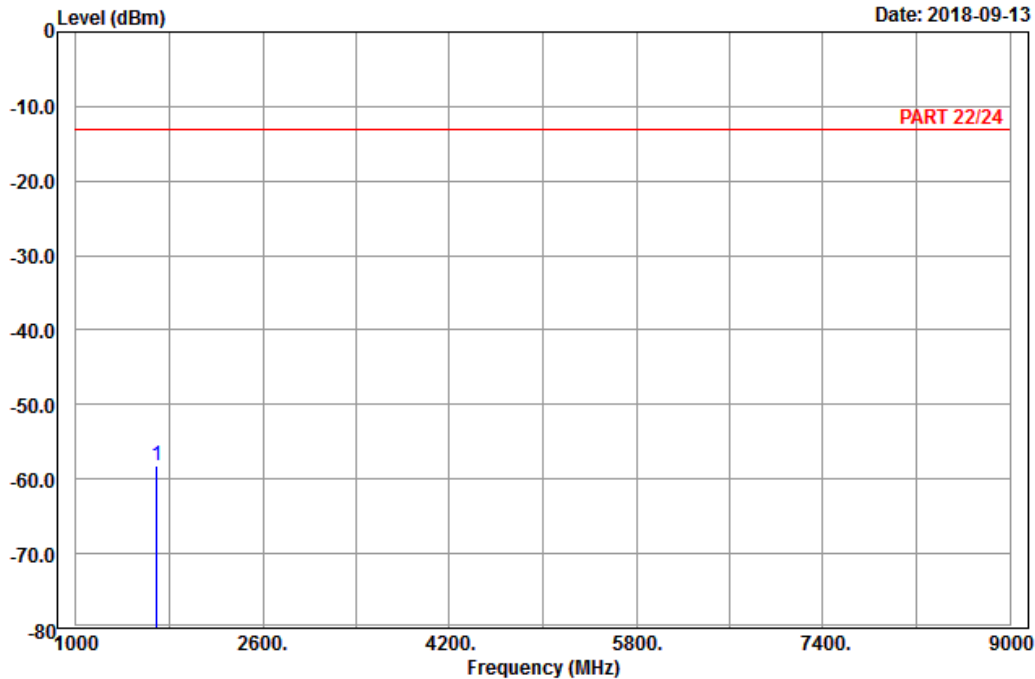

Site : 966 chamber 1  
 Condition: PART 22/24 Horizontal  
 Remark : LTE\_Band 5\_Link\_CH20625  
 Tested by: Harry Hsueh

Freq	Level	Read Level	Limit	Over	Factor	Remark
MHz	dBm	dBm	dBm	dB	dB	
1 pp 1693.00	-58.28	-66.30	-13.00	-45.28	8.02	Peak



A D T

Data: 6

Date: 2018-09-13

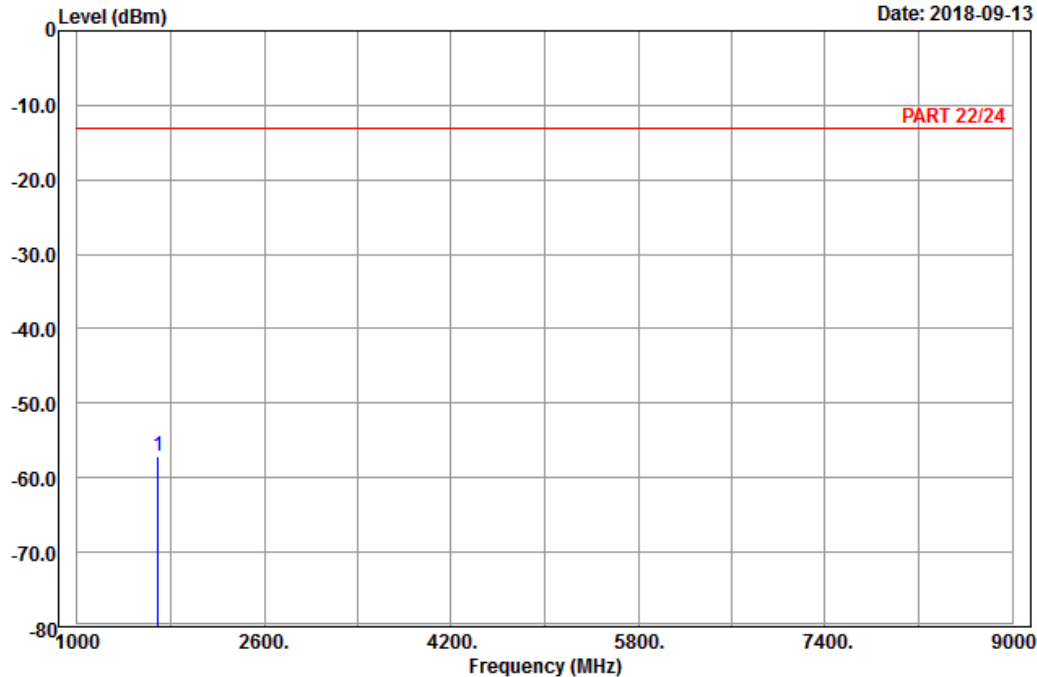

Site : 966 chamber 1  
 Condition: PART 22/24 Vertical  
 Remark : LTE\_Band 5\_Link\_CH20625  
 Tested by: Harry Hsueh

	Freq	Level	Read Level	Limit Line	Over Limit	Factor	Remark
	MHz	dBm	dBm	dBm	dB	dB	
1	pp 1693.00	-57.01	-65.03	-13.00	-44.01	8.02	Peak

Channel Bandwidth: 10 MHz / QPSK  
Low Channel



Bureau Veritas Consumer Products Services Ltd., Taoyuan Branch

A D T

Data: 5

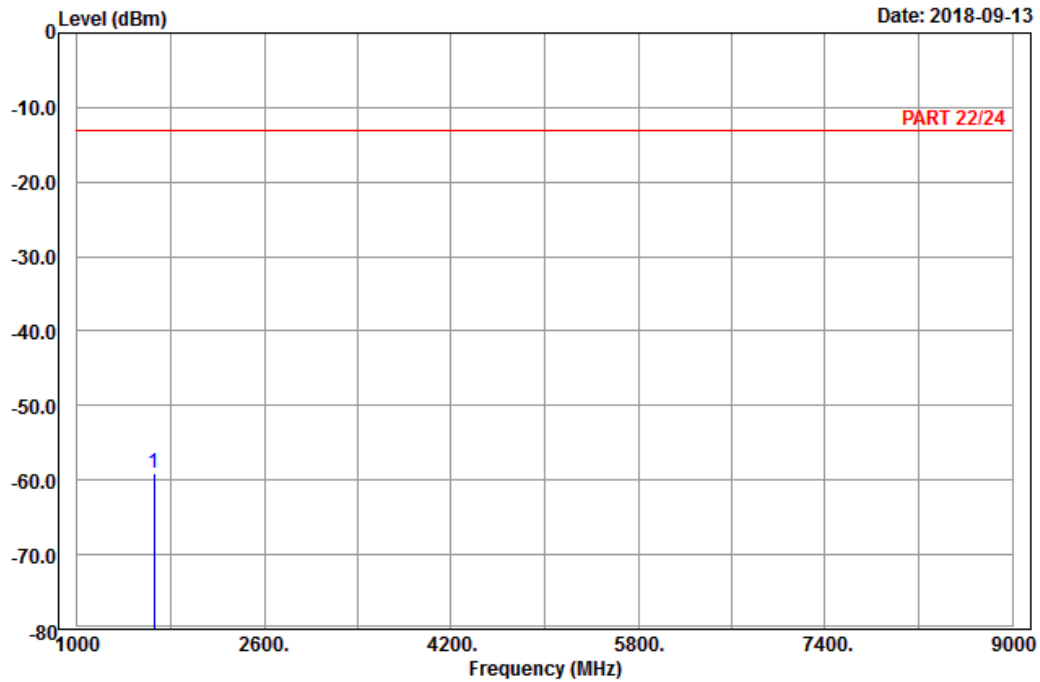

Site : 966 chamber 1  
Condition: PART 22/24 Horizontal  
Remark : LTE\_Band 5\_Link\_CH20450  
Tested by: Karl Lee

	Freq	Level	Read Level	Limit Line	Over Limit	Factor	Remark
	MHz	dBm	dBm	dBm	dB	dB	
1	pp 1658.00	-58.98	-66.89	-13.00	-45.98	7.91	Peak





Bureau Veritas Consumer Products Services Ltd., Taoyuan Branch

A D T

Data: 6

Date: 2018-09-13

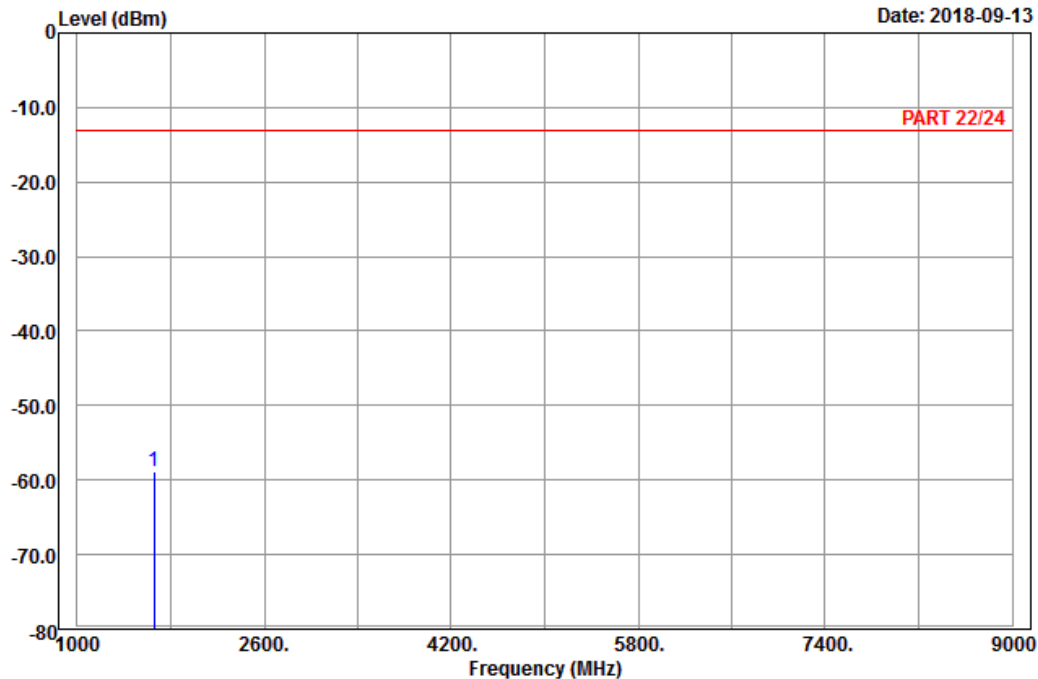

Site : 966 chamber 1  
 Condition: PART 22/24 Vertical  
 Remark : LTE\_Band 5\_Link\_CH20450  
 Tested by: Karl Lee

	Freq	Level	Read Level	Limit Line	Over Limit	Factor	Remark
	MHz	dBm	dBm	dBm	dB	dB	
1	pp 1658.00	-58.81	-66.72	-13.00	-45.81	7.91	Peak

Middle Channel



Bureau Veritas Consumer Products Services Ltd., Taoyuan Branch

A D T

Data: 9

Date: 2018-09-13

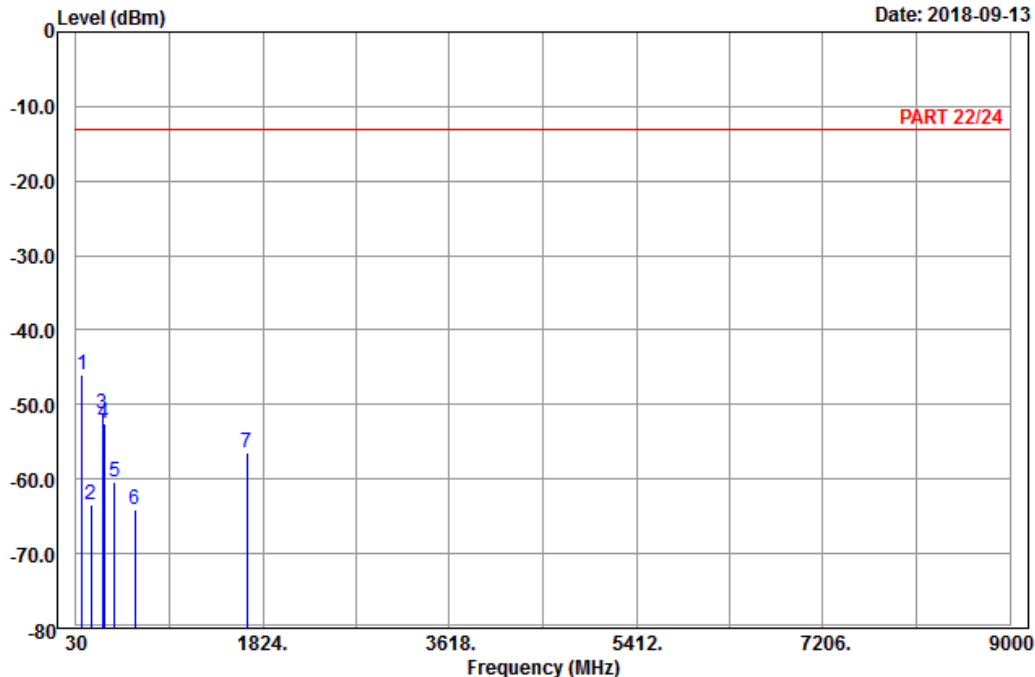

Site : 966 chamber 1  
 Condition: PART 22/24 Horizontal  
 Remark : LTE\_Band 5\_Link\_CH20525  
 Tested by: Karl Lee

	Freq	Level	Read Level	Limit Line	Over Limit	Factor	Remark
	MHz	dBm	dBm	dBm	dB	dB	
1	pp	92.10	-45.93	-35.37	-13.00	-32.93	-10.56 Peak
2		174.72	-63.50	-57.31	-13.00	-50.50	-6.19 Peak
3		282.99	-51.27	-45.46	-13.00	-38.27	-5.81 Peak
4		302.10	-52.61	-46.68	-13.00	-39.61	-5.93 Peak
5		401.50	-60.37	-57.59	-13.00	-47.37	-2.78 Peak
6		594.00	-64.13	-64.28	-13.00	-51.13	0.15 Peak
7		1673.00	-56.38	-64.29	-13.00	-43.38	7.91 Peak



A D T

Data: 10

Date: 2018-09-13

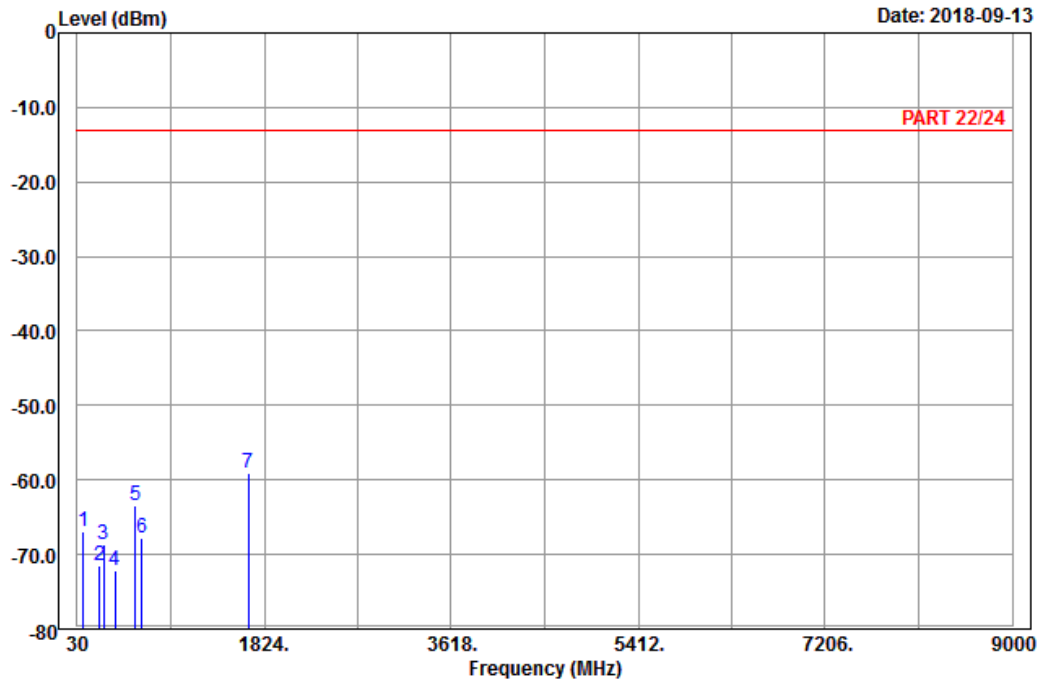

Site : 966 chamber 1  
 Condition: PART 22/24 Vertical  
 Remark : LTE\_Band 5\_Link\_CH20525  
 Tested by: Karl Lee

	Freq	Level	Read Level	Limit Line	Over Limit	Factor	Remark
	MHz	dBm	dBm	dBm	dB	dB	
1	91.29	-66.93	-56.31	-13.00	-53.93	-10.62	Peak
2	246.27	-71.49	-65.93	-13.00	-58.49	-5.56	Peak
3	279.75	-68.72	-62.95	-13.00	-55.72	-5.77	Peak
4	394.50	-72.15	-69.15	-13.00	-59.15	-3.00	Peak
5	587.70	-63.40	-63.30	-13.00	-50.40	-0.10	Peak
6	652.10	-67.74	-67.60	-13.00	-54.74	-0.14	Peak
7 pp	1673.00	-58.97	-66.88	-13.00	-45.97	7.91	Peak

High Channel



Bureau Veritas Consumer Products Services Ltd., Taoyuan Branch

A D T

Data: 5

Date: 2018-09-13

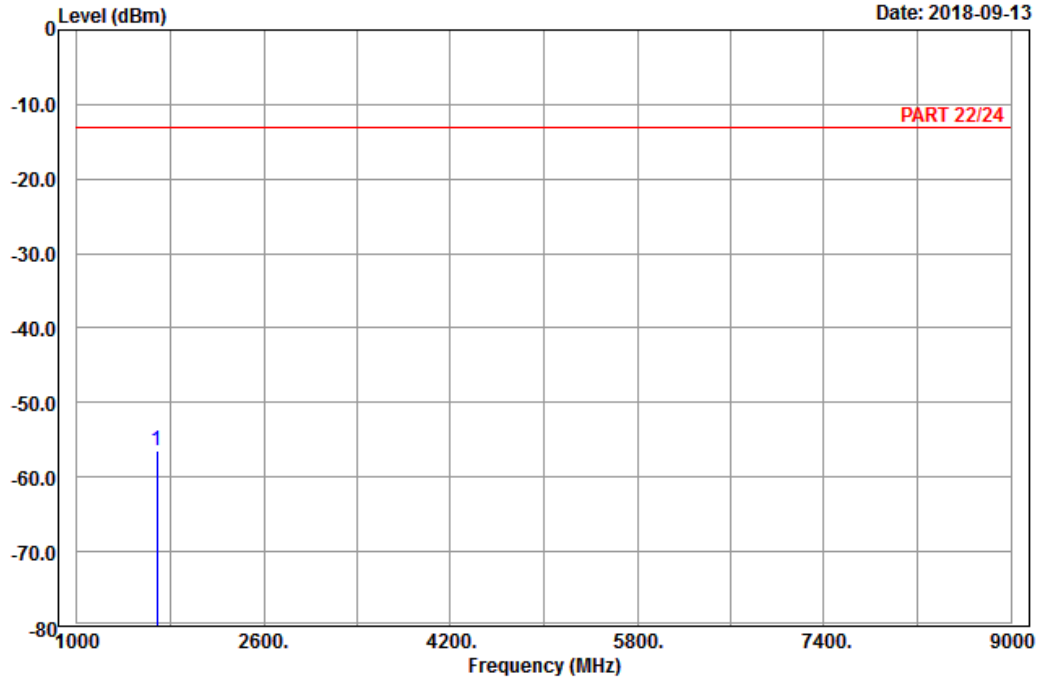

Site : 966 chamber 1  
 Condition: PART 22/24 Horizontal  
 Remark : LTE\_Band 5\_Link\_CH20600  
 Tested by: Karl Lee

	Read	Limit	Over		
Freq	Level	Level	Line	Limit	Factor Remark
MHz	dBm	dBm	dBm	dB	dB
1 pp 1688.00	-56.53	-64.55	-13.00	-43.53	8.02 Peak



Bureau Veritas Consumer Products Services Ltd., Taoyuan Branch

A D T

Data: 6

Date: 2018-09-13

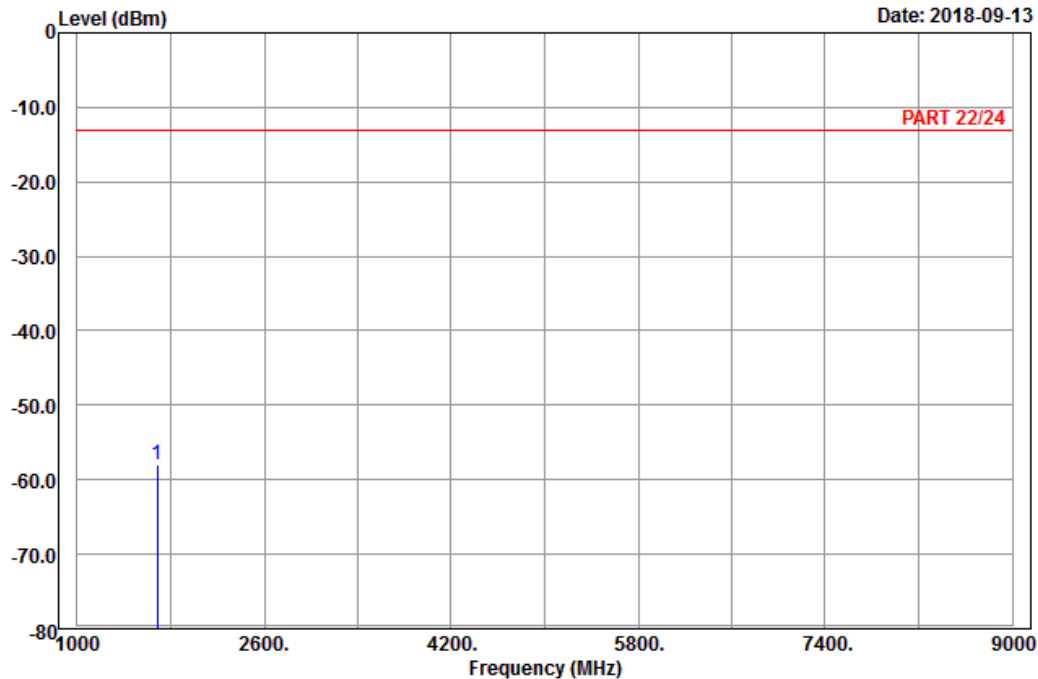

Site : 966 chamber 1  
 Condition: PART 22/24 Vertical  
 Remark : LTE\_Band 5\_Link\_CH20600  
 Tested by: Karl Lee

	Freq	Level	Read Level	Limit Line	Over Limit	Factor	Remark
	MHz	dBm	dBm	dBm	dB	dB	
1	pp 1688.00	-57.88	-65.90	-13.00	-44.88	8.02	Peak

## 5 Pictures of Test Arrangements

Please refer to the attached file (Test Setup Photo).

## Appendix – Information on the Testing Laboratories

We, Bureau Veritas Consumer Products Services (H.K.) Ltd., Taoyuan Branch, were founded in 1988 to provide our best service in EMC, Radio, Telecom and Safety consultation. Our laboratories are FCC recognized accredited test firms and accredited according to ISO/IEC 17025.

If you have any comments, please feel free to contact us at the following:

**Linko EMC/RF Lab**

Tel: 886-2-26052180

Fax: 886-2-26051924

**Hsin Chu EMC/RF/Telecom Lab**

Tel: 886-3-6668565

Fax: 886-3-6668323

**Hwa Ya EMC/RF/Safety**

Tel: 886-3-3183232

Fax: 886-3-3270892

**Email:** [service.adt@tw.bureauveritas.com](mailto:service.adt@tw.bureauveritas.com)

**Web Site:** [www.bureauveritas-adt.com](http://www.bureauveritas-adt.com)

The address and road map of all our labs can be found in our web site also.

--- END ---