

FCC Test Report

Report No.: RF180821C20-5

FCC ID: V65E6910

Test Model: E6910

Received Date: Aug. 21, 2018

Test Date: Sep. 13, 2018 ~ Sep. 18, 2018

Issued Date: Sep. 28, 2018

Applicant: Kyocera Corporation c/o Kyocera International, Inc.

Address: 8611 Balboa Avenue, San Diego, CA 92123

Issued By: Bureau Veritas Consumer Products Services (H.K.) Ltd., Taoyuan Branch

Lab Address: No. 47-2, 14th Ling, Chia Pau Vil., Lin Kou Dist., New Taipei City, Taiwan (R.O.C)

Test Location (1): No. 19, Hwa Ya 2nd Rd, Wen Hwa Tsuen, Kwei Shan Hsiang, Taoyuan Hsien 333, Taiwan, R.O.C.

Test Location (2): No.215, Sec. 3, Beixin Rd., Xindian Dist., New Taipei City 231, Taiwan, R.O.C

**FCC Registration /
Designation Number:** 427177 / TW0011



This report is for your exclusive use. Any copying or replication of this report to or for any other person or entity, or use of our name or trademark, is permitted only with our prior written permission. This report sets forth our findings solely with respect to the test samples identified herein. The results set forth in this report are not indicative or representative of the quality or characteristics of the lot from which a test sample was taken or any similar or identical product unless specifically and expressly noted. Our report includes all of the tests requested by you and the results thereof based upon the information that you provided to us. You have 60 days from date of issuance of this report to notify us of any material error or omission caused by our negligence, provided, however, that such notice shall be in writing and shall specifically address the issue you wish to raise. A failure to raise such issue within the prescribed time shall constitute your unqualified acceptance of the completeness of this report, the tests conducted and the correctness of the report contents. Unless specific mention, the uncertainty of measurement has been explicitly taken into account to declare the compliance or non-compliance to the specification. The report must not be used by the client to claim product certification, approval, or endorsement by TAF or any government agencies.

Table of Contents

Release Control Record	4
1 Certificate of Conformity	5
2 Summary of Test Results	6
2.1 Measurement Uncertainty	6
2.2 Modification Record	6
3 General Information	7
3.1 General Description of EUT	7
3.2 Description of Test Modes	9
3.2.1 Test Mode Applicability and Tested Channel Detail	11
3.3 Duty Cycle of Test Signal	13
3.4 Description of Support Units	14
3.4.1 Configuration of System under Test	14
3.5 General Description of Applied Standards	14
4 Test Types and Results	15
4.1 Radiated Emission and Bandedge Measurement	15
4.1.1 Limits of Radiated Emission and Bandedge Measurement	15
4.1.2 Limits of Unwanted Emission Out of the Restricted Bands	16
4.1.3 Test Instruments	17
4.1.4 Test Procedures	19
4.1.5 Deviation from Test Standard	20
4.1.6 Test Set Up	20
4.1.7 EUT Operating Conditions	21
4.1.8 Test Results	22
4.2 Conducted Emission Measurement	62
4.2.1 Limits of Conducted Emission Measurement	62
4.2.2 Test Instruments	62
4.2.3 Test Procedures	63
4.2.4 Deviation from Test Standard	63
4.2.5 Test Setup	63
4.2.6 EUT Operating Conditions	63
4.2.7 Test Results	64
4.3 Transmit Power Measurement	66
4.3.1 Limits of Transmit Power Measurement	66
4.3.2 Test Setup	66
4.3.3 Test Instruments	67
4.3.4 Test Procedure	67
4.3.5 Deviation from Test Standard	67
4.3.6 EUT Operating Conditions	67
4.3.7 Test Result	68
4.4 Occupied Bandwidth Measurement	73
4.4.1 Test Setup	73
4.4.2 Test Instruments	73
4.4.3 Test Procedure	73
4.4.4 Test Results	74
4.5 Peak Power Spectral Density Measurement	77
4.5.1 Limits of Peak Power Spectral Density Measurement	77
4.5.2 Test Setup	77
4.5.3 Test Instruments	77
4.5.4 Test Procedures	77
4.5.5 Deviation from Test Standard	78
4.5.6 EUT Operating Conditions	78
4.5.7 Test Results	79
4.6 Frequency Stability	84

4.6.1	Limit of Frequency Stability Measurement	84
4.6.2	Test Setup	84
4.6.3	Test Instruments	84
4.6.4	Test Procedure	84
4.6.5	Deviation from Test Standard	84
4.6.6	EUT Operating Condition	84
4.6.7	Test Results	85
4.7	6 dB Bandwidth Measurement.....	86
4.7.1	Limits of 6 dB Bandwidth Measurement.....	86
4.7.2	Test Setup.....	86
4.7.3	Test Instruments	86
4.7.4	Test Procedure	86
4.7.5	Deviation from Test Standard	86
4.7.6	EUT Operating Condition	86
4.7.7	Test Results	87
5	Pictures of Test Arrangements.....	89
	Annex A- Radiated Out of Band Emisison (OOBE) Measurement (For U-NII-3 band)	90
	Appendix – Information on the Testing Laboratories	93

Release Control Record

Issue No.	Description	Date Issued
RF180821C20-5	Original Release	Sep. 28, 2018

1 Certificate of Conformity

Product: Smart Phone

Brand: Kyocera

Test Model: E6910

Sample Status: Identical Prototype

Applicant: Kyocera Corporation c/o Kyocera International, Inc.

Test Date: Sep. 13, 2018 ~ Sep. 18, 2018

Standards: 47 CFR FCC Part 15, Subpart E (Section 15.407)
ANSI C63.10:2013

The above equipment has been tested by **Bureau Veritas Consumer Products Services (H.K.) Ltd., Taoyuan Branch**, and found compliance with the requirement of the above standards. The test record, data evaluation & Equipment Under Test (EUT) configurations represented herein are true and accurate accounts of the measurements of the sample's RF characteristics under the conditions specified in this report.

Prepared by :  , **Date:** Sep. 28, 2018
Ivonne Wu / Supervisor

Approved by :  , **Date:** Sep. 28, 2018
Dylan Chiou / Project Engineer

2 Summary of Test Results

47 CFR FCC Part 15, Subpart E (Section 15.407)			
FCC Clause	Test Item	Result	Remarks
15.407(b)(6)	AC Power Conducted Emissions	Pass	Meet the requirement of limit. Minimum passing margin is -15.01 dB at 0.61868 MHz.
15.407(b) (1/2/3/4(i/ii)/6)	Radiated Emissions & Band Edge Measurement	Pass	Meet the requirement of limit. Minimum passing margin is -5.74 dB at 11550 MHz.
15.407(a)(1/2/3)	Max Average Transmit Power	Pass	Meet the requirement of limit.
---	Occupied Bandwidth Measurement	-	Reference only
15.407(a)(1/2/3)	Peak Power Spectral Density	Pass	Meet the requirement of limit.
15.407(e)	6 dB Bandwidth	Pass	Meet the requirement of limit. (U-NII-3 Band only)
15.407(g)	Frequency Stability	Pass	Meet the requirement of limit.
15.203	Antenna Requirement	Pass	No antenna connector is used.

*For U-NII-3 band compliance with rule part 15.407(b)(4)(i), the OOB test plots were recorded in Annex A.

2.1 Measurement Uncertainty

Where relevant, the following measurement uncertainty levels have been estimated for tests performed on the EUT as specified in CISPR 16-4-2:

Measurement	Frequency	Expanded Uncertainty (k=2) (±)
Conducted Emissions at mains ports	150 kHz ~ 30 MHz	2.44 dB
Radiated Emissions up to 1 GHz	30 MHz ~ 200 MHz	2.0153 dB
	200 MHz ~ 1000 MHz	2.0224 dB
Radiated Emissions above 1 GHz	1 GHz ~ 18 GHz	1.0121 dB
	18 GHz ~ 40 GHz	1.1508 dB

2.2 Modification Record

There were no modifications required for compliance.

3 General Information

3.1 General Description of EUT

Product	Smart Phone
Brand	Kyocera
Test Model	E6910
Status of EUT	Identical Prototype
Power Supply Rating	3.8 Vdc (Battery) 5 Vdc or 9 Vdc or 12 Vdc (Adapter) 5 Vdc (Host equipment)
Modulation Type	256QAM, 64QAM, 16QAM, QPSK, BPSK
Modulation Technology	OFDM
Transfer Rate	802.11a: 54.0/ 48.0/ 36.0/ 24.0/ 18.0/ 12.0/ 9.0/ 6.0 Mbps 802.11n: up to 150.0 Mbps 802.11ac: up to 433.3 Mbps
Operating Frequency	5180 ~ 5240 MHz, 5260 ~ 5320 MHz, 5500 ~ 5700 MHz, 5745 ~ 5825 MHz
Number of Channel	5180 ~ 5240 MHz: 4 for 802.11a, 802.11n (HT20) 2 for 802.11n (HT40) 1 for 802.11ac (VHT80) 5260 ~ 5320 MHz: 4 for 802.11a, 802.11n (HT20) 2 for 802.11n (HT40) 1 for 802.11ac (VHT80) 5500 ~ 5700 MHz: 11 for 802.11a, 802.11n (HT20) 5 for 802.11n (HT40) 2 for 802.11ac (VHT80) 5745 ~ 5825 MHz: 5 for 802.11a, 802.11n (HT20) 2 for 802.11n (HT40) 1 for 802.11ac (VHT80)
Output Power	58.479 mW for 5180 ~ 5240 MHz 61.094 mW for 5260 ~ 5320 MHz 54.828 mW for 5500 ~ 5700 MHz 55.847 mW for 5745 ~ 5825 MHz
Antenna Type	Fixed Internal antenna with 2.2 dBi gain
Antenna Connector	N/A
Accessory Device	Refer to Note as below
Data Cable Supplied	Refer to Note as below

Note:

1. The EUT provides one transmitter and receiver.

Modulation Mode	Tx Function
802.11a	1TX
802.11n (HT20)	1TX
802.11n (HT40)	1TX
802.11ac (VHT20)	1TX
802.11ac (VHT40)	1TX
802.11ac (VHT80)	1TX

* The modulation and bandwidth are similar for 802.11n mode for HT20 / HT40 and 802.11ac mode for VHT20 / VHT40, therefore investigated worst case to representative mode in test report. (Final test mode refer section 3.2.1)

2. The EUT's accessories list refers to Ext. Pho.
3. The above EUT information is declared by manufacturer and for more detailed features description, please refers to the manufacturer's specifications or user's manual.

3.2 Description of Test Modes

For 5180 ~ 5240 MHz

4 channels are provided for 802.11a, 802.11n (HT20):

Channel	Frequency (MHz)	Channel	Frequency (MHz)
36	5180	44	5220
40	5200	48	5240

2 channels are provided for 802.11n (HT40):

Channel	Frequency (MHz)	Channel	Frequency (MHz)
38	5190	46	5230

1 channel is provided for 802.11ac (VHT80):

Channel	Frequency (MHz)
42	5210

For 5260 ~ 5320 MHz

4 channels are provided for 802.11a, 802.11n (HT20):

Channel	Frequency (MHz)	Channel	Frequency (MHz)
52	5260	60	5300
56	5280	64	5320

2 channels are provided for 802.11n (HT40):

Channel	Frequency (MHz)	Channel	Frequency (MHz)
54	5270	62	5310

1 channel is provided for 802.11ac (VHT80):

Channel	Frequency (MHz)
58	5290

For 5500 ~ 5700 MHz

11 channels are provided for 802.11a, 802.11n (HT20):

Channel	Frequency (MHz)	Channel	Frequency (MHz)
100	5500	124	5620
104	5520	128	5640
108	5540	132	5660
112	5560	136	5680
116	5580	140	5700
120	5600		

5 channels are provided for 802.11n (HT40):

Channel	Frequency (MHz)	Channel	Frequency (MHz)
102	5510	126	5630
110	5550	134	5670
118	5590		

2 channels are provided for 802.11ac (VHT80):

Channel	Frequency (MHz)	Channel	Frequency (MHz)
106	5530	122	5610

For 5745 ~ 5825 MHz:

5 channels are provided for 802.11a, 802.11n (HT20):

Channel	Frequency (MHz)	Channel	Frequency (MHz)
149	5745	161	5805
153	5765	165	5825
157	5785		

2 channels are provided for 802.11n (HT40):

Channel	Frequency (MHz)	Channel	Frequency (MHz)
151	5755	159	5795

1 channel is provided for 802.11ac (VHT80):

Channel	Frequency (MHz)
155	5775

3.2.1 Test Mode Applicability and Tested Channel Detail

EUT Configure Mode	Applicable To				Description
	RE \geq 1G	RE $<$ 1G	PLC	APCM	
-	√	√	√	√	-

Where **RE \geq 1G**: Radiated Emission above 1 GHz **RE $<$ 1G**: Radiated Emission below 1 GHz
PLC: Power Line Conducted Emission **APCM**: Antenna Port Conducted Measurement

Note:

1. The EUT had been pre-tested on the positioned of each 3 axis. The worst case was found when positioned on **Y-plane** for 5180-5240MHz & 5260-5320MHz and **Z-plane** for 5500-5700MHz & 5745-5825MHz.
2. "-" means no effect.

Radiated Emission Test (Above 1 GHz):

- Pre-Scan has been conducted to determine the worst-case mode from all possible combinations between available modulations, data rates and antenna ports (if EUT with antenna diversity architecture).
- Following channel(s) was (were) selected for the final test as listed below.

EUT Configure Mode	Frequency Band (MHz)	Mode	Available Channel	Tested Channel	Modulation Technology	Modulation Type	Data Rate (Mbps)
-	5180-5240	802.11a	36 to 48	36, 40, 48	OFDM	BPSK	6.0
-		802.11n (HT20)	36 to 48	36, 40, 48	OFDM	BPSK	6.5
-		802.11n (HT40)	38 to 46	38, 46	OFDM	BPSK	13.5
-		802.11ac (VHT80)	42	42	OFDM	BPSK	29.3
-	5260-5320	802.11a	52 to 64	52, 60, 64	OFDM	BPSK	6.0
-		802.11n (HT20)	52 to 64	52, 60, 64	OFDM	BPSK	6.5
-		802.11n (HT40)	54 to 62	54, 62	OFDM	BPSK	13.5
-		802.11ac (VHT80)	58	58	OFDM	BPSK	29.3
-	5500-5700	802.11a	100 to 140	100, 116, 140	OFDM	BPSK	6.0
-		802.11n (HT20)	100 to 140	100, 116, 140	OFDM	BPSK	6.5
-		802.11n (HT40)	102 to 134	102, 110, 134	OFDM	BPSK	13.5
-		802.11ac (VHT80)	106 to 122	106, 122	OFDM	BPSK	29.3
-	5745-5825	802.11a	149 to 165	149, 157, 165	OFDM	BPSK	6.0
-		802.11n (HT20)	149 to 165	149, 157, 165	OFDM	BPSK	6.5
-		802.11n (HT40)	151 to 159	151, 159	OFDM	BPSK	13.5
-		802.11ac (VHT80)	155	155	OFDM	BPSK	29.3

Radiated Emission Test (Below 1 GHz):

- Pre-Scan has been conducted to determine the worst-case mode from all possible combinations between available modulations, data rates and antenna ports (if EUT with antenna diversity architecture).
- Following channel(s) was (were) selected for the final test as listed below.

EUT Configure Mode	Frequency Band (MHz)	Mode	Available Channel	Tested Channel	Modulation Technology	Modulation Type	Data Rate (Mbps)
	5745-5825	802.11ac (VHT80)	155	155	OFDM	BPSK	29.3

Power Line Conducted Emission Test:

- Pre-Scan has been conducted to determine the worst-case mode from all possible combinations between available modulations, data rates and antenna ports (if EUT with antenna diversity architecture).
- Following channel(s) was (were) selected for the final test as listed below.

EUT Configure Mode	Frequency Band (MHz)	Mode	Available Channel	Tested Channel	Modulation Technology	Modulation Type	Data Rate (Mbps)
-	5745-5825	802.11ac (VHT80)	155	155	OFDM	BPSK	29.3

Antenna Port Conducted Measurement:

- This item includes all test value of each mode, but only includes spectrum plot of worst value of each mode.
- Pre-Scan has been conducted to determine the worst-case mode from all possible combinations between available modulations, data rates and antenna ports (if EUT with antenna diversity architecture).
- Following channel(s) was (were) selected for the final test as listed below.

EUT Configure Mode	Frequency Band (MHz)	Mode	Available Channel	Tested Channel	Modulation Technology	Modulation Type	Data Rate (Mbps)
-	5180-5240	802.11a	36 to 48	36, 40, 48	OFDM	BPSK	6.0
-		802.11n (HT20)	36 to 48	36, 40, 48	OFDM	BPSK	6.5
-		802.11n (HT40)	38 to 46	38, 46	OFDM	BPSK	13.5
-		802.11ac (VHT80)	42	42	OFDM	BPSK	29.3
-	5260-5320	802.11a	52 to 64	52, 60, 64	OFDM	BPSK	6.0
-		802.11n (HT20)	52 to 64	52, 60, 64	OFDM	BPSK	6.5
-		802.11n (HT40)	54 to 62	54, 62	OFDM	BPSK	13.5
-		802.11ac (VHT80)	58	58	OFDM	BPSK	29.3
-	5500-5700	802.11a	100 to 140	100, 116, 140	OFDM	BPSK	6.0
-		802.11n (HT20)	100 to 140	100, 116, 140	OFDM	BPSK	6.5
-		802.11n (HT40)	102 to 134	102, 110, 134	OFDM	BPSK	13.5
-		802.11ac (VHT80)	106 to 122	106, 122	OFDM	BPSK	29.3
-	5745-5825	802.11a	149 to 165	149, 157, 165	OFDM	BPSK	6.0
-		802.11n (HT20)	149 to 165	149, 157, 165	OFDM	BPSK	6.5
-		802.11n (HT40)	151 to 159	151, 159	OFDM	BPSK	13.5
-		802.11ac (VHT80)	155	155	OFDM	BPSK	29.3

Test Condition:

Applicable To	Environmental Conditions	Input Power	Tested by
RE≥1G	25 deg. C, 65 % RH	120 Vac, 60 Hz	Charles Hsiao
RE<1G	25 deg. C, 65 % RH	120 Vac, 60 Hz	Charles Hsiao
PLC	25 deg. C, 65 % RH	120 Vac, 60 Hz	Jisyong Wang
APCM	25 deg. C, 65 % RH	3.8 Vdc	Gavin Wu

3.3 Duty Cycle of Test Signal

MODULATION TYPE: BPSK

Duty cycle of test signal is < 98 %, duty factor is required.

802.11a: Duty cycle = $1.34/1.462 = 0.917$, Duty factor = $10 * \log(1/0.917) = 0.38$

802.11n (HT20): Duty cycle = $1.254/1.357 = 0.924$, Duty factor = $10 * \log(1/0.924) = 0.34$

802.11n (HT40): Duty cycle = $0.617/0.727 = 0.849$, Duty factor = $10 * \log(1/0.849) = 0.71$

802.11ac (VHT80): Duty cycle = $0.313/0.408 = 0.767$, Duty factor = $10 * \log(1/0.767) = 1.15$

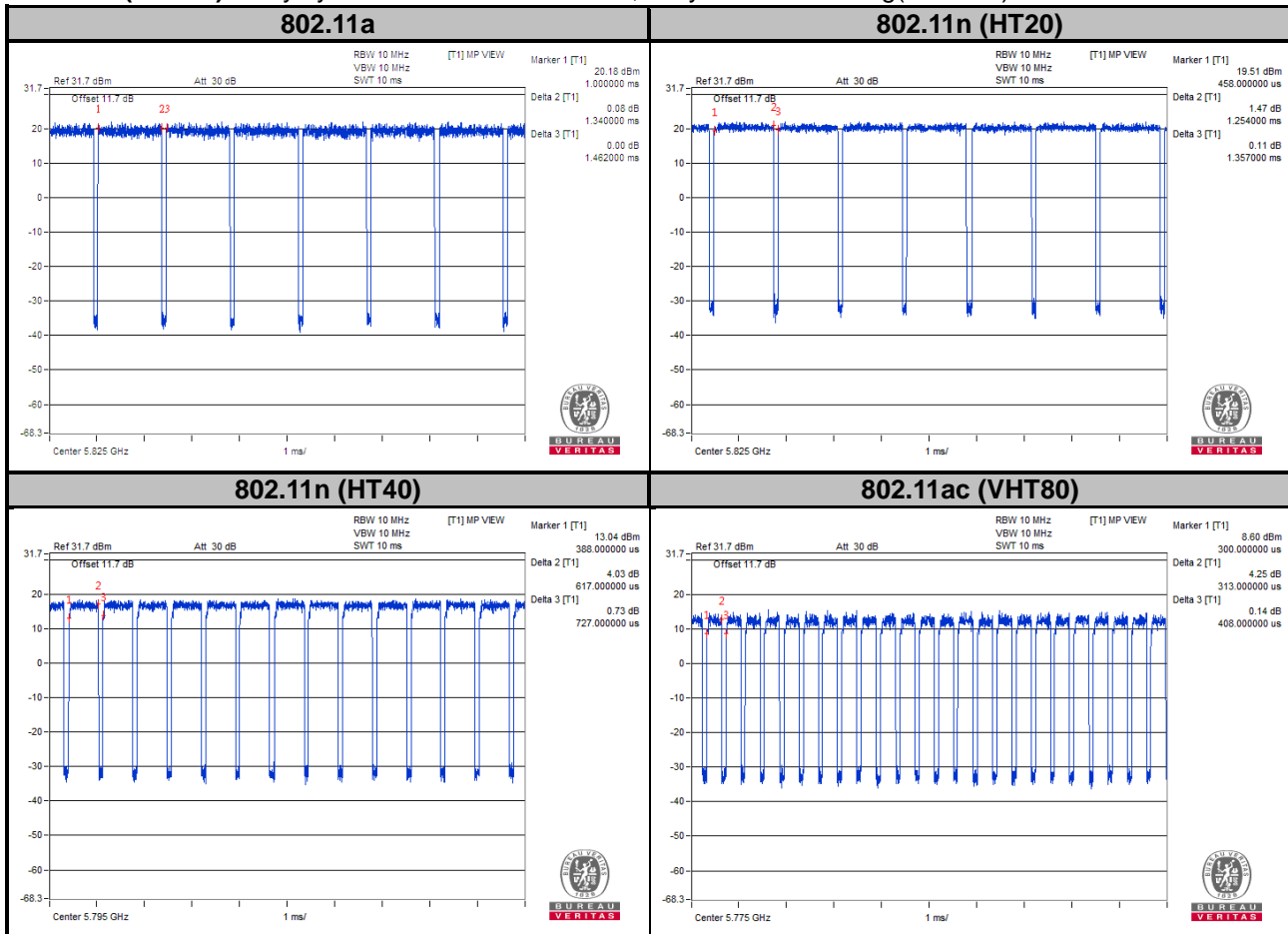

3.4 Description of Support Units

The EUT has been tested as an independent unit together with other necessary accessories or support units. The following support units or accessories were used to form a representative test configuration during the tests.

No.	Product	Brand	Model No.	Serial No.	FCC ID
1.	Earphone	Funkey	FK130102	N/A	N/A

No.	Signal Cable Description Of The Above Support Units
1.	N/A

Note:

1. All power cords of the above support units are non-shielded (1.8m).

3.4.1 Configuration of System under Test

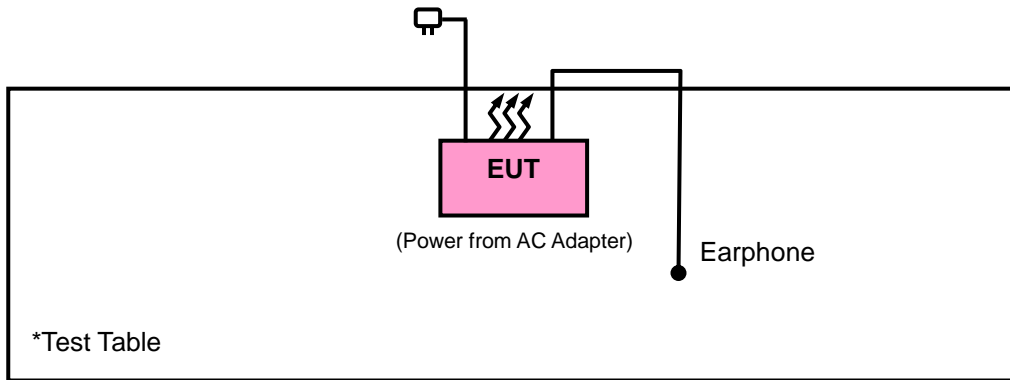

3.5 General Description of Applied Standards

The EUT is a RF Product. According to the specifications of the manufacturer, it must comply with the requirements of the following standards:

FCC Part 15, Subpart E (15.407)

KDB 789033 D02 General UNII Test Procedures New Rules v02r01

ANSI C63.10-2013

All test items have been performed and recorded as per the above standards.

4 Test Types and Results

4.1 Radiated Emission and Bandedge Measurement

4.1.1 Limits of Radiated Emission and Bandedge Measurement

Radiated emissions which fall in the restricted bands must comply with the radiated emission limits specified as below table. Other emissions shall be at least 20 dB below the highest level of the desired power:

Frequencies (MHz)	Field Strength (microvolts/meter)	Measurement Distance (meters)
0.009 ~ 0.490	2400/F (kHz)	300
0.490 ~ 1.705	24000/F (kHz)	30
1.705 ~ 30.0	30	30
30 ~ 88	100	3
88 ~ 216	150	3
216 ~ 960	200	3
Above 960	500	3

Note:

1. The lower limit shall apply at the transition frequencies.
2. Emission level (dBuV/m) = 20 log Emission level (uV/m).
3. For frequencies above 1000 MHz, the field strength limits are based on average detector, however, the peak field strength of any emission shall not exceed the maximum permitted average limits, specified above by more than 20 dB under any condition of modulation.

4.1.2 Limits of Unwanted Emission Out of the Restricted Bands

Applicable To		Limit	
789033 D02 General UNII Test Procedures New Rules v02r01		Field Strength at 3 m	
		PK: 74 (dBµV/m)	AV: 54 (dBµV/m)
Frequency Band	Applicable To	EIRP Limit	Equivalent Field Strength at 3 m
5150~5250 MHz	15.407(b)(1)	PK: -27 (dBm/MHz)	PK: 68.2 (dBµV/m)
5250~5350 MHz	15.407(b)(2)		
5470~5725 MHz	15.407(b)(3)		
5725~5850 MHz	15.407(b)(4)(i)	PK:-27 (dBm/MHz) ^{*1} PK:10 (dBm/MHz) ^{*2} PK:15.6 (dBm/MHz) ^{*3} PK:27 (dBm/MHz) ^{*4}	PK: 68.2 (dBµV/m) ^{*1} PK:105.2 (dBµV/m) ^{*2} PK: 110.8 (dBµV/m) ^{*3} PK:122.2 (dBµV/m) ^{*4}
	15.407(b)(4)(ii)	Emission limits in section 15.247(d)	

^{*1} beyond 75 MHz or more above of the band edge.

^{*2} below the band edge increasing linearly to 10 dBm/MHz at 25 MHz above.

^{*3} below the band edge increasing linearly to a level of 15.6 dBm/MHz at 5 MHz above.

^{*4} from 5 MHz above or below the band edge increasing linearly to a level of 27 dBm/MHz at the band edge.

Note:

The following formula is used to convert the equipment isotropic radiated power (eirp) to field strength:

$$E = \frac{1000000\sqrt{30P}}{3} \mu\text{V/m, where P is the eirp (Watts).}$$

4.1.3 Test Instruments

Description & Manufacturer	Model No.	Serial No.	Date of Calibration	Due Date of Calibration
Test Receiver Agilent Technologies	N9038A	MY52260177	Aug. 20, 2018	Aug. 19, 2019
Spectrum Analyzer ROHDE & SCHWARZ	FSU43	101261	Jan. 11, 2018	Jan. 10, 2019
HORN Antenna ETS-Lindgren	3117	00143293	Dec. 13, 2017	Dec. 12, 2018
BILOG Antenna SCHWARZBECK	VULB 9168	9168-616	Dec. 14, 2017	Dec. 13, 2018
HORN Antenna SCHWARZBECK	BBHA 9170	9170-480	Dec. 01, 2017	Nov. 30, 2018
Fixed Attenuator Woken	00801A1GGAM02Y	NA	May 17, 2018	May 16, 2019
Loop Antenna	EM-6879	269	Sep. 07, 2018	Sep. 06, 2019
Preamplifier Agilent	310N	187226	Jun. 19, 2018	Jun. 18, 2019
Preamplifier Agilent	83017A	MY39501357	Jun. 19, 2018	Jun. 18, 2019
Preamplifier EMCI	EMC 184045	980116	Oct. 20, 2017	Oct. 19, 2018
Power Meter Anritsu	ML2495A	1012010	Sep. 05, 2018	Sep. 04, 2019
Power Sensor Anritsu	MA2411B	1315050	Sep. 04, 2018	Sep. 03, 2019
RF signal cable ETS-LINDGREN	5D-FB	Cable-CH1-01(RFC -SMS-100-SMS-12 0+RFC-SMS-100-S MS-400)	Jun. 19, 2018	Jun. 18, 2019
RF signal cable ETS-LINDGREN	8D-FB	Cable-CH1-02(RFC -SMS-100-SMS-24)	Jun. 19, 2018	Jun. 18, 2019
Boresight Antenna Fixture	FBA-01	FBA-SIP01	NA	NA
Software BV ADT	E3 8.130425b	NA	NA	NA
Antenna Tower MF	NA	NA	NA	NA
Turn Table MF	NA	NA	NA	NA
Antenna Tower & Turn Table Controller MF	MF-7802	NA	NA	NA
Temperature & Humidity Chamber	GTH-120-40-CP-A R	MAA1306-019	Jul. 17, 2018	Jul. 16, 2019
DC Power Supply Topward	33010D	807748	Oct. 25, 2016	Oct. 24, 2018
Digital Multimeter Fluke	87-III	70360742	Jun. 29, 2018	Jun. 28, 2019

- Note:
1. The calibration interval of the above test instruments is 12 / 24 months and the calibrations are traceable to NML/ROC and NIST/USA.
 2. The test was performed in HsinTien Chamber 1.
 3. The horn antenna and preamplifier (model: 83017A) are used only for the measurement of emission frequency above 1 GHz if tested.
 4. The IC Site Registration No. is IC7450I-1.

4.1.4 Test Procedures

For Radiated Emission below 30 MHz

- a. The EUT was placed on the top of a rotating table 0.8 meters above the ground at a 3 meter chamber room. The table was rotated 360 degrees to determine the position of the highest radiation.
- b. The EUT was set 3 meters away from the interference-receiving antenna, which was mounted on the top of a variable-height antenna tower.
- c. Both Parallel, perpendicular, and ground-parallel orientations of the antenna are set to make the measurement.
- d. For each suspected emission, the EUT was arranged to its worst case and the rotatable table was turned from 0 degrees to 360 degrees to find the maximum reading.
- e. The test-receiver system was set to Quasi-Peak Detect Function and Specified Bandwidth with Maximum Hold Mode.

Note:

1. The resolution bandwidth and video bandwidth of test receiver/spectrum analyzer is 9 kHz at frequency below 30 MHz.

For Radiated Emission above 30 MHz

- a. The EUT was placed on the top of a rotating table 0.8 meters (for 30 MHz ~ 1 GHz) / 1.5 meters (for above 1 GHz) above the ground at 3 meter chamber room for test. The table was rotated 360 degrees to determine the position of the highest radiation.
- b. The EUT was set 3 meters away from the interference-receiving antenna, which was mounted on the top of a variable-height antenna tower.
- c. The height of antenna is varied from one meter to four meters above the ground to determine the maximum value of the field strength. Both horizontal and vertical polarizations of the antenna are set to make the measurement.
- d. For each suspected emission, the EUT was arranged to its worst case and then the antenna was tuned to heights from 1 meter to 4 meters and the rotatable table was turned from 0 degrees to 360 degrees to find the maximum reading.
- e. The test-receiver system was set to quasi-peak detect function and specified bandwidth with maximum hold mode when the test frequency is below 1 GHz.
- f. The test-receiver system was set to peak and average detected function and specified bandwidth with maximum hold mode when the test frequency is above 1 GHz. If the peak reading value also meets average limit, measurement with the average detector is unnecessary.

Note:

1. The resolution bandwidth and video bandwidth of test receiver/spectrum analyzer is 120 kHz for Quasi-peak detection (QP) at frequency below 1 GHz.
2. The resolution bandwidth of test receiver/spectrum analyzer is 1 MHz and the video bandwidth is 3 MHz for Peak detection (PK) at frequency above 1 GHz.
3. The resolution bandwidth of test receiver/spectrum analyzer is 1 MHz and the video bandwidth is $\geq 1/T$ (Duty cycle < 98 %) or 10 Hz (Duty cycle ≥ 98 %) for Average detection (AV) at frequency above 1 GHz.
(11a: RBW = 1 MHz, VBW = 1 kHz ; 11n (HT20): RBW = 1 MHz, VBW = 1 kHz ;
11n (HT40): RBW = 1 MHz, VBW = 3 kHz ; 11ac (VHT80): RBW = 1 MHz, VBW = 3 kHz)
4. All modes of operation were investigated and the worst-case emissions are reported.

4.1.5 Deviation from Test Standard

No deviation.

4.1.6 Test Setup

<Radiated Emission below 30 MHz>

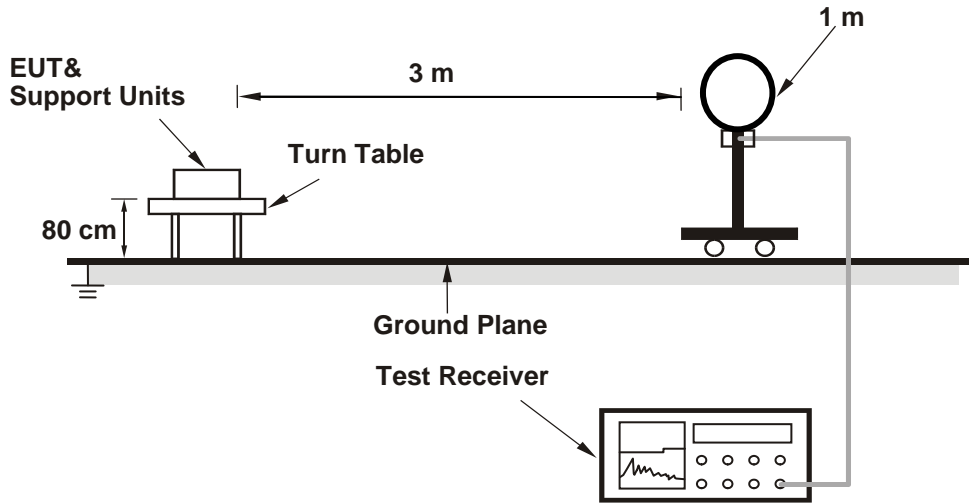

<Radiated Emission 30 MHz to 1 GHz>

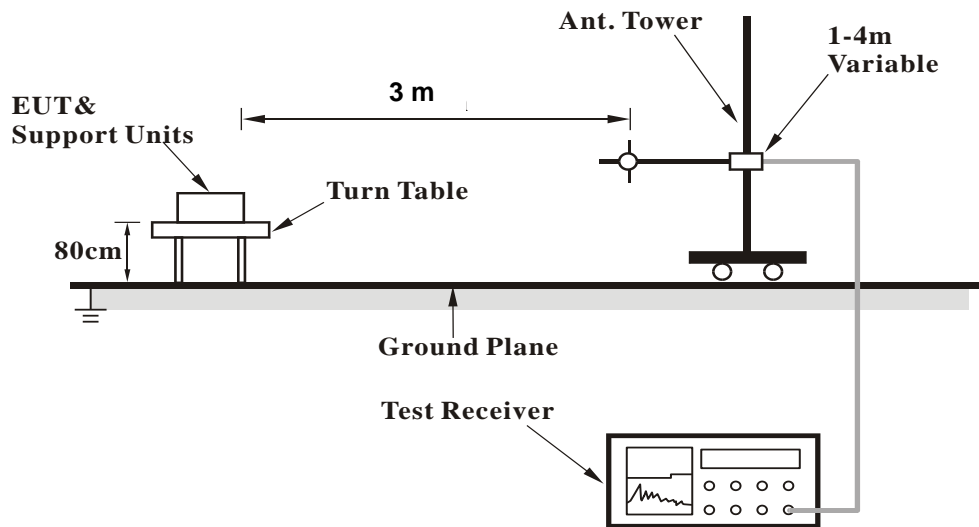

<Radiated Emission above 1 GHz>

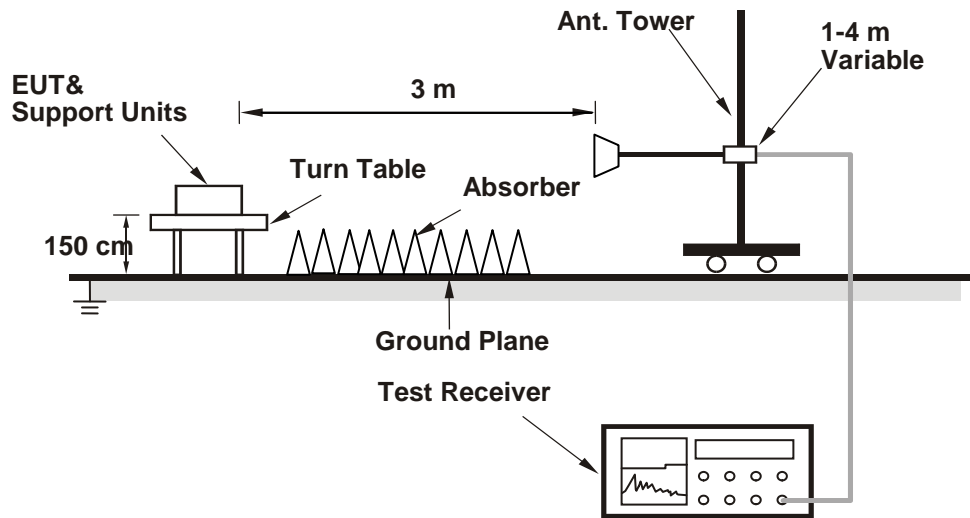

For the actual test configuration, please refer to the attached file (Test Setup Photo).

4.1.7 EUT Operating Conditions

- a. Placed the EUT on a testing table.
- b. Use the software to control the EUT under transmission condition continuously at specific channel frequency.

4.1.8 Test Results
 Above 1 GHz Data :
 802.11a

EUT Test Condition		Measurement Detail	
Channel	Channel 36	Frequency Range	1 GHz ~ 40 GHz
Input Power	120 Vac, 60 Hz	Detector Function	Peak (PK) Average (AV)
Environmental Conditions	25 deg. C, 65 % RH	Tested By	Charles Hsiao

Antenna Polarity & Test Distance: Horizontal at 3 m										
Frequency (MHz)	Emission Level (dBuV/m)	Read Level (dBuV)	Limit (dBuV/m)	Margin (dB)	Antenna Factor (dB/m)	Cable Loss (dB)	Preamp Factor (dB)	Antenna Height (cm)	Table Angle (Degree)	Remark
5142.5	44.13	35.87	54	-9.87	34.12	8.13	33.99	128	207	Average
5142.5	54.06	45.8	74	-19.94	34.12	8.13	33.99	128	207	Peak
5180	98.57	90.26			34.15	8.16	34	128	207	Average
5180	105.37	97.06			34.15	8.16	34	128	207	Peak
10360	53.44	39.14	68.2	-14.76	37.12	12.3	35.12	144	214	Peak

Antenna Polarity & Test Distance: Vertical at 3 m										
Frequency (MHz)	Emission Level (dBuV/m)	Read Level (dBuV)	Limit (dBuV/m)	Margin (dB)	Antenna Factor (dB/m)	Cable Loss (dB)	Preamp Factor (dB)	Antenna Height (cm)	Table Angle (Degree)	Remark
5138	43.15	34.9	54	-10.85	34.11	8.13	33.99	200	196	Average
5138	53.86	45.61	74	-20.14	34.11	8.13	33.99	200	196	Peak
5180	96.62	88.31			34.15	8.16	34	200	196	Average
5180	103.06	94.75			34.15	8.16	34	200	196	Peak
10360	53.94	39.64	68.2	-14.26	37.12	12.3	35.12	153	115	Peak

Remarks:

- Emission Level = Read Level + Antenna Factor + Cable Loss - Preamp Factor
 Margin value = Emission level – Limit value
- 5180 MHz: Fundamental Frequency
- *: Out of Restricted Band
- The emission levels of other frequencies were very low against the limit

EUT Test Condition		Measurement Detail	
Channel	Channel 40	Frequency Range	1 GHz ~ 40 GHz
Input Power	120 Vac, 60 Hz	Detector Function	Peak (PK) Average (AV)
Environmental Conditions	25 deg. C, 65 % RH	Tested By	Charles Hsiao

Antenna Polarity & Test Distance: Horizontal at 3 m										
Frequency (MHz)	Emission Level (dBuV/m)	Read Level (dBuV)	Limit (dBuV/m)	Margin (dB)	Antenna Factor (dB/m)	Cable Loss (dB)	Preamp Factor (dB)	Antenna Height (cm)	Table Angle (Degree)	Remark
5149.7	44.73	36.48	54	-9.27	34.12	8.13	34	128	207	Average
5149.7	54.35	46.1	74	-19.65	34.12	8.13	34	128	207	Peak
5200	98.49	90.14			34.16	8.19	34	128	207	Average
5200	105.68	97.33			34.16	8.19	34	128	207	Peak
5449.66	42.62	33.79	54	-11.38	34.36	8.51	34.04	128	207	Average
5449.66	53.32	44.49	74	-20.68	34.36	8.51	34.04	128	207	Peak
*10400	53.27	38.93	68.2	-14.93	37.14	12.36	35.16	195	255	Peak
Antenna Polarity & Test Distance: Vertical at 3 m										
Frequency (MHz)	Emission Level (dBuV/m)	Read Level (dBuV)	Limit (dBuV/m)	Margin (dB)	Antenna Factor (dB/m)	Cable Loss (dB)	Preamp Factor (dB)	Antenna Height (cm)	Table Angle (Degree)	Remark
5138.75	43.43	35.18	54	-10.57	34.11	8.13	33.99	200	196	Average
5138.75	54.37	46.12	74	-19.63	34.11	8.13	33.99	200	196	Peak
5200	96.25	87.9			34.16	8.19	34	200	196	Average
5200	103.13	94.78			34.16	8.19	34	200	196	Peak
5440.42	42.61	33.82	54	-11.39	34.35	8.48	34.04	200	196	Average
5440.42	53.24	44.45	74	-20.76	34.35	8.48	34.04	200	196	Peak
*10400	54.26	39.92	68.2	-13.94	37.14	12.36	35.16	114	315	Peak

Remarks:

- Emission Level = Read Level + Antenna Factor + Cable Loss - Preamp Factor
Margin value = Emission level – Limit value
- 5200 MHz: Fundamental Frequency
- *: Out of Restricted Band
- The emission levels of other frequencies were very low against the limit

EUT Test Condition		Measurement Detail	
Channel	Channel 48	Frequency Range	1 GHz ~ 40 GHz
Input Power	120 Vac, 60 Hz	Detector Function	Peak (PK) Average (AV)
Environmental Conditions	25 deg. C, 65 % RH	Tested By	Charles Hsiao

Antenna Polarity & Test Distance: Horizontal at 3 m										
Frequency (MHz)	Emission Level (dBuV/m)	Read Level (dBuV)	Limit (dBuV/m)	Margin (dB)	Antenna Factor (dB/m)	Cable Loss (dB)	Preamp Factor (dB)	Antenna Height (cm)	Table Angle (Degree)	Remark
5240	98.59	90.15			34.19	8.26	34.01	128	207	Average
5240	105.53	97.09			34.19	8.26	34.01	128	207	Peak
5448.89	42.85	34.02	54	-11.15	34.36	8.51	34.04	128	207	Average
5448.89	53.34	44.51	74	-20.66	34.36	8.51	34.04	128	207	Peak
10480	54.35	39.84	68.2	-13.85	37.19	12.53	35.21	187	222	Peak

Antenna Polarity & Test Distance: Vertical at 3 m										
Frequency (MHz)	Emission Level (dBuV/m)	Read Level (dBuV)	Limit (dBuV/m)	Margin (dB)	Antenna Factor (dB/m)	Cable Loss (dB)	Preamp Factor (dB)	Antenna Height (cm)	Table Angle (Degree)	Remark
5240	96.49	88.05			34.19	8.26	34.01	200	196	Average
5240	103.12	94.68			34.19	8.26	34.01	200	196	Peak
5350.33	42.79	34.16	54	-11.21	34.28	8.38	34.03	200	196	Average
5350.33	53.1	44.47	74	-20.9	34.28	8.38	34.03	200	196	Peak
10480	53.55	39.04	68.2	-14.65	37.19	12.53	35.21	119	324	Peak

Remarks:

- Emission Level = Read Level + Antenna Factor + Cable Loss - Preamp Factor
Margin value = Emission level – Limit value
- 5240 MHz: Fundamental Frequency
- *: Out of Restricted Band
- The emission levels of other frequencies were very low against the limit

EUT Test Condition		Measurement Detail	
Channel	Channel 52	Frequency Range	1 GHz ~ 40 GHz
Input Power	120 Vac, 60 Hz	Detector Function	Peak (PK) Average (AV)
Environmental Conditions	25 deg. C, 65 % RH	Tested By	Charles Hsiao

Antenna Polarity & Test Distance: Horizontal at 3 m										
Frequency (MHz)	Emission Level (dBuV/m)	Read Level (dBuV)	Limit (dBuV/m)	Margin (dB)	Antenna Factor (dB/m)	Cable Loss (dB)	Preamp Factor (dB)	Antenna Height (cm)	Table Angle (Degree)	Remark
5149.1	42.68	34.43	54	-11.32	34.12	8.13	34	100	209	Average
5149.1	53.65	45.4	74	-20.35	34.12	8.13	34	100	209	Peak
5260	99.89	91.43			34.21	8.26	34.01	100	209	Average
5260	106.72	98.26			34.21	8.26	34.01	100	209	Peak
10520	54.25	39.66	68.2	-13.95	37.21	12.61	35.23	145	216	Peak

Antenna Polarity & Test Distance: Vertical at 3 m										
Frequency (MHz)	Emission Level (dBuV/m)	Read Level (dBuV)	Limit (dBuV/m)	Margin (dB)	Antenna Factor (dB/m)	Cable Loss (dB)	Preamp Factor (dB)	Antenna Height (cm)	Table Angle (Degree)	Remark
5108.75	42.55	34.35	54	-11.45	34.09	8.1	33.99	190	196	Average
5108.75	53.16	44.96	74	-20.84	34.09	8.1	33.99	190	196	Peak
5260	98.59	90.13			34.21	8.26	34.01	190	196	Average
5260	105.19	96.73			34.21	8.26	34.01	190	196	Peak
10520	54.6	40.01	68.2	-13.6	37.21	12.61	35.23	140	96	Peak

Remarks:

- Emission Level = Read Level + Antenna Factor + Cable Loss - Preamp Factor
Margin value = Emission level – Limit value
- 5260 MHz: Fundamental Frequency
- *: Out of Restricted Band
- The emission levels of other frequencies were very low against the limit

EUT Test Condition		Measurement Detail	
Channel	Channel 60	Frequency Range	1 GHz ~ 40 GHz
Input Power	120 Vac, 60 Hz	Detector Function	Peak (PK) Average (AV)
Environmental Conditions	25 deg. C, 65 % RH	Tested By	Charles Hsiao

Antenna Polarity & Test Distance: Horizontal at 3 m										
Frequency (MHz)	Emission Level (dBuV/m)	Read Level (dBuV)	Limit (dBuV/m)	Margin (dB)	Antenna Factor (dB/m)	Cable Loss (dB)	Preamp Factor (dB)	Antenna Height (cm)	Table Angle (Degree)	Remark
5115.95	42.6	34.4	54	-11.4	34.09	8.1	33.99	100	209	Average
5115.95	53.4	45.2	74	-20.6	34.09	8.1	33.99	100	209	Peak
5300	99.63	91.09			34.24	8.32	34.02	100	209	Average
5300	106.57	98.03			34.24	8.32	34.02	100	209	Peak
5350.11	44.08	35.45	54	-9.92	34.28	8.38	34.03	100	209	Average
5350.11	53.92	45.29	74	-20.08	34.28	8.38	34.03	100	209	Peak
10600	46.25	31.57	54	-7.75	37.28	12.67	35.27	154	19	Average
10600	54.35	39.67	74	-19.65	37.28	12.67	35.27	154	19	Peak

Antenna Polarity & Test Distance: Vertical at 3 m										
Frequency (MHz)	Emission Level (dBuV/m)	Read Level (dBuV)	Limit (dBuV/m)	Margin (dB)	Antenna Factor (dB/m)	Cable Loss (dB)	Preamp Factor (dB)	Antenna Height (cm)	Table Angle (Degree)	Remark
5133.5	42.55	34.3	54	-11.45	34.11	8.13	33.99	190	196	Average
5133.5	52.94	44.69	74	-21.06	34.11	8.13	33.99	190	196	Peak
5300	98.74	90.2			34.24	8.32	34.02	190	196	Average
5300	105.8	97.26			34.24	8.32	34.02	190	196	Peak
5350.88	43.84	35.21	54	-10.16	34.28	8.38	34.03	190	196	Average
5350.88	54.31	45.68	74	-19.69	34.28	8.38	34.03	190	196	Peak
10600	46.27	31.59	54	-7.73	37.28	12.67	35.27	143	299	Average
10600	53.44	38.76	74	-20.56	37.28	12.67	35.27	143	299	Peak

Remarks:

- Emission Level = Read Level + Antenna Factor + Cable Loss - Preamp Factor
Margin value = Emission level – Limit value
- 5300 MHz: Fundamental Frequency
- The emission levels of other frequencies were very low against the limit

EUT Test Condition		Measurement Detail	
Channel	Channel 64	Frequency Range	1 GHz ~ 40 GHz
Input Power	120 Vac, 60 Hz	Detector Function	Peak (PK) Average (AV)
Environmental Conditions	25 deg. C, 65 % RH	Tested By	Charles Hsiao

Antenna Polarity & Test Distance: Horizontal at 3 m										
Frequency (MHz)	Emission Level (dBuV/m)	Read Level (dBuV)	Limit (dBuV/m)	Margin (dB)	Antenna Factor (dB/m)	Cable Loss (dB)	Preamp Factor (dB)	Antenna Height (cm)	Table Angle (Degree)	Remark
5320	97.48	88.9			34.25	8.35	34.02	116	188	Average
5320	104.71	96.13			34.25	8.35	34.02	116	188	Peak
5368.04	43.54	34.87	54	-10.46	34.29	8.41	34.03	116	188	Average
5368.04	53.88	45.21	74	-20.12	34.29	8.41	34.03	116	188	Peak
10640	46.67	31.94	54	-7.33	37.31	12.71	35.29	177	144	Average
10640	54.98	40.25	74	-19.02	37.31	12.71	35.29	177	144	Peak

Antenna Polarity & Test Distance: Vertical at 3 m										
Frequency (MHz)	Emission Level (dBuV/m)	Read Level (dBuV)	Limit (dBuV/m)	Margin (dB)	Antenna Factor (dB/m)	Cable Loss (dB)	Preamp Factor (dB)	Antenna Height (cm)	Table Angle (Degree)	Remark
5320	96.66	88.08			34.25	8.35	34.02	190	196	Average
5320	103.45	94.87			34.25	8.35	34.02	190	196	Peak
5373.76	43.54	34.88	54	-10.46	34.29	8.41	34.04	190	196	Average
5373.76	54.27	45.61	74	-19.73	34.29	8.41	34.04	190	196	Peak
10640	46.72	31.99	54	-7.28	37.31	12.71	35.29	127	270	Average
10640	53.74	39.01	74	-20.26	37.31	12.71	35.29	127	270	Peak

Remarks:

- Emission Level = Read Level + Antenna Factor + Cable Loss - Preamp Factor
Margin value = Emission level – Limit value
- 5320 MHz: Fundamental Frequency
- The emission levels of other frequencies were very low against the limit

EUT Test Condition		Measurement Detail	
Channel	Channel 100	Frequency Range	1 GHz ~ 40 GHz
Input Power	120 Vac, 60 Hz	Detector Function	Peak (PK) Average (AV)
Environmental Conditions	25 deg. C, 65 % RH	Tested By	Charles Hsiao

Antenna Polarity & Test Distance: Horizontal at 3 m										
Frequency (MHz)	Emission Level (dBuV/m)	Read Level (dBuV)	Limit (dBuV/m)	Margin (dB)	Antenna Factor (dB/m)	Cable Loss (dB)	Preamp Factor (dB)	Antenna Height (cm)	Table Angle (Degree)	Remark
5450.48	43.05	34.23	54	-10.95	34.36	8.51	34.05	100	199	Average
5450.48	54.43	45.61	74	-19.57	34.36	8.51	34.05	100	199	Peak
*5469.04	51.97	43.14	68.2	-16.23	34.37	8.51	34.05	100	199	Peak
5500	92.74	49.77			34.4	8.57	0	100	199	Average
5500	99.98	57.01			34.4	8.57	0	100	199	Peak
11000	45.8	30.72	54	-8.2	37.6	12.96	35.48	131	85	Average
11000	55.32	40.24	74	-18.68	37.6	12.96	35.48	131	85	Peak
Antenna Polarity & Test Distance: Vertical at 3 m										
Frequency (MHz)	Emission Level (dBuV/m)	Read Level (dBuV)	Limit (dBuV/m)	Margin (dB)	Antenna Factor (dB/m)	Cable Loss (dB)	Preamp Factor (dB)	Antenna Height (cm)	Table Angle (Degree)	Remark
5459.44	43.3	34.48	54	-10.7	34.36	8.51	34.05	162	213	Average
5459.44	54.02	45.2	74	-19.98	34.36	8.51	34.05	162	213	Peak
*5470.16	53.01	44.18	68.2	-15.19	34.37	8.51	34.05	162	213	Peak
5500	96.21	87.29			34.4	8.57	34.05	162	213	Average
5500	102.67	93.75			34.4	8.57	34.05	162	213	Peak
11000	45.21	30.13	54	-8.79	37.6	12.96	35.48	139	190	Average
11000	54.74	39.66	74	-19.26	37.6	12.96	35.48	139	190	Peak

Remarks:

- Emission Level = Read Level + Antenna Factor + Cable Loss - Preamp Factor
Margin value = Emission level – Limit value
- 5500 MHz: Fundamental Frequency
- *: Out of Restricted Band
- The emission levels of other frequencies were very low against the limit

EUT Test Condition		Measurement Detail	
Channel	Channel 116	Frequency Range	1 GHz ~ 40 GHz
Input Power	120 Vac, 60 Hz	Detector Function	Peak (PK) Average (AV)
Environmental Conditions	25 deg. C, 65 % RH	Tested By	Charles Hsiao

Antenna Polarity & Test Distance: Horizontal at 3 m										
Frequency (MHz)	Emission Level (dBuV/m)	Read Level (dBuV)	Limit (dBuV/m)	Margin (dB)	Antenna Factor (dB/m)	Cable Loss (dB)	Preamp Factor (dB)	Antenna Height (cm)	Table Angle (Degree)	Remark
5440.72	42.89	34.1	54	-11.11	34.35	8.48	34.04	100	196	Average
5440.72	53.46	44.67	74	-20.54	34.35	8.48	34.04	100	196	Peak
*5470.64	52.18	43.35	68.2	-16.02	34.37	8.51	34.05	100	196	Peak
5580	96.29	87.3			34.47	8.6	34.08	100	196	Average
5580	103.18	94.19			34.47	8.6	34.08	100	196	Peak
*5725.16	52.93	43.77	68.2	-15.27	34.62	8.65	34.11	100	196	Peak
11160	46.41	31.33	54	-7.59	37.7	12.83	35.45	109	74	Average
11160	55.9	40.82	74	-18.1	37.7	12.83	35.45	109	74	Peak
Antenna Polarity & Test Distance: Vertical at 3 m										
Frequency (MHz)	Emission Level (dBuV/m)	Read Level (dBuV)	Limit (dBuV/m)	Margin (dB)	Antenna Factor (dB/m)	Cable Loss (dB)	Preamp Factor (dB)	Antenna Height (cm)	Table Angle (Degree)	Remark
5419.44	43.63	34.86	54	-10.37	34.33	8.48	34.04	231	213	Average
5419.44	53.47	44.7	74	-20.53	34.33	8.48	34.04	231	213	Peak
*5469.36	53.3	44.47	68.2	-14.9	34.37	8.51	34.05	231	213	Peak
5580	99.43	90.44			34.47	8.6	34.08	231	213	Average
5580	106.88	97.89			34.47	8.6	34.08	231	213	Peak
*5724.76	52.86	43.7	68.2	-15.34	34.62	8.65	34.11	231	213	Peak
11160	46.43	31.35	54	-7.57	37.7	12.83	35.45	169	153	Average
11160	56.08	41	74	-17.92	37.7	12.83	35.45	169	153	Peak

Remarks:

- Emission Level = Read Level + Antenna Factor + Cable Loss - Preamp Factor
Margin value = Emission level – Limit value
- 5580 MHz: Fundamental Frequency
- *: Out of Restricted Band
- The emission levels of other frequencies were very low against the limit

EUT Test Condition		Measurement Detail	
Channel	Channel 140	Frequency Range	1 GHz ~ 40 GHz
Input Power	120 Vac, 60 Hz	Detector Function	Peak (PK) Average (AV)
Environmental Conditions	25 deg. C, 65 % RH	Tested By	Charles Hsiao

Antenna Polarity & Test Distance: Horizontal at 3 m										
Frequency (MHz)	Emission Level (dBuV/m)	Read Level (dBuV)	Limit (dBuV/m)	Margin (dB)	Antenna Factor (dB/m)	Cable Loss (dB)	Preamp Factor (dB)	Antenna Height (cm)	Table Angle (Degree)	Remark
5700	93.99	84.86			34.59	8.64	34.1	100	185	Average
5700	100.77	91.64			34.59	8.64	34.1	100	185	Peak
*5724.44	52.75	43.59	68.2	-15.45	34.62	8.65	34.11	100	185	Peak
11400	45.6	30.5	54	-8.4	37.84	12.67	35.41	126	211	Average
11400	55.01	39.91	74	-18.99	37.84	12.67	35.41	126	211	Peak

Antenna Polarity & Test Distance: Vertical at 3 m										
Frequency (MHz)	Emission Level (dBuV/m)	Read Level (dBuV)	Limit (dBuV/m)	Margin (dB)	Antenna Factor (dB/m)	Cable Loss (dB)	Preamp Factor (dB)	Antenna Height (cm)	Table Angle (Degree)	Remark
5700	96.31	87.18			34.59	8.64	34.1	233	215	Average
5700	104.2	95.07			34.59	8.64	34.1	233	215	Peak
*5725.48	54	44.84	68.2	-14.2	34.62	8.65	34.11	233	215	Peak
11400	45.57	30.47	54	-8.43	37.84	12.67	35.41	175	113	Average
11400	55.1	40	74	-18.9	37.84	12.67	35.41	175	113	Peak

Remarks:

- Emission Level = Read Level + Antenna Factor + Cable Loss - Preamp Factor
Margin value = Emission level – Limit value
- 5700 MHz: Fundamental Frequency
- *: Out of Restricted Band
- The emission levels of other frequencies were very low against the limit

EUT Test Condition		Measurement Detail	
Channel	Channel 149	Frequency Range	1 GHz ~ 40 GHz
Input Power	120 Vac, 60 Hz	Detector Function	Peak (PK) Average (AV)
Environmental Conditions	25 deg. C, 65 % RH	Tested By	Charles Hsiao

<Spurious Emission>

Antenna Polarity & Test Distance: Horizontal at 3 m										
Frequency (MHz)	Emission Level (dBuV/m)	Read Level (dBuV)	Limit (dBuV/m)	Margin (dB)	Antenna Factor (dB/m)	Cable Loss (dB)	Preamp Factor (dB)	Antenna Height (cm)	Table Angle (Degree)	Remark
5745	88.79	79.6			34.64	8.66	34.11	100	169	Average
5745	95.49	86.3			34.64	8.66	34.11	100	169	Peak
11490	47.01	31.89	54	-6.99	37.89	12.62	35.39	105	235	Average
11490	57.09	41.97	74	-16.91	37.89	12.62	35.39	105	235	Peak
Antenna Polarity & Test Distance: Vertical at 3 m										
Frequency (MHz)	Emission Level (dBuV/m)	Read Level (dBuV)	Limit (dBuV/m)	Margin (dB)	Antenna Factor (dB/m)	Cable Loss (dB)	Preamp Factor (dB)	Antenna Height (cm)	Table Angle (Degree)	Remark
5745	93.65	84.46			34.64	8.66	34.11	200	186	Average
5745	100.83	91.64			34.64	8.66	34.11	200	186	Peak
11490	46.9	31.78	54	-7.1	37.89	12.62	35.39	157	88	Average
11490	55.44	40.32	74	-18.56	37.89	12.62	35.39	157	88	Peak

<Out of Band Emission (OOBE)>

Antenna Polarity & Test Distance: Horizontal at 3 m										
Frequency (MHz)	Emission Level (dBuV/m)	Read Level (dBuV)	Limit (dBuV/m)	Margin (dB)	Antenna Factor (dB/m)	Cable Loss (dB)	Preamp Factor (dB)	Antenna Height (cm)	Table Angle (Degree)	Remark
*5589.25	53.55	44.54	68.2	-14.65	34.49	8.6	34.08	100	169	Peak
5654.875	53.03	43.94	71.81	-18.78	34.56	8.63	34.1	100	169	Peak
5920.525	52.95	43.57	71.51	-18.56	34.81	8.73	34.16	100	169	Peak
*5989.825	54.32	44.84	68.2	-13.88	34.9	8.75	34.17	100	169	Peak
Antenna Polarity & Test Distance: Vertical at 3 m										
Frequency (MHz)	Emission Level (dBuV/m)	Read Level (dBuV)	Limit (dBuV/m)	Margin (dB)	Antenna Factor (dB/m)	Cable Loss (dB)	Preamp Factor (dB)	Antenna Height (cm)	Table Angle (Degree)	Remark
*5595.025	53.9	44.89	68.2	-14.3	34.49	8.6	34.08	200	186	Peak
5652.775	51.16	42.06	70.25	-19.09	34.56	8.63	34.09	200	186	Peak
5922.1	51.25	41.85	70.35	-19.1	34.83	8.73	34.16	200	186	Peak
*5988.25	54.32	44.86	68.2	-13.88	34.88	8.75	34.17	200	186	Peak

Remarks:

- Emission Level = Read Level + Antenna Factor + Cable Loss - Preamp Factor
Margin value = Emission level – Limit value
- 5745 MHz: Fundamental Frequency
- *: Out of Restricted Band
- The emission levels of other frequencies were very low against the limit

EUT Test Condition		Measurement Detail	
Channel	Channel 157	Frequency Range	1 GHz ~ 40 GHz
Input Power	120 Vac, 60 Hz	Detector Function	Peak (PK) Average (AV)
Environmental Conditions	25 deg. C, 65 % RH	Tested By	Charles Hsiao

<Spurious Emission>

Antenna Polarity & Test Distance: Horizontal at 3 m										
Frequency (MHz)	Emission Level (dBuV/m)	Read Level (dBuV)	Limit (dBuV/m)	Margin (dB)	Antenna Factor (dB/m)	Cable Loss (dB)	Preamp Factor (dB)	Antenna Height (cm)	Table Angle (Degree)	Remark
5785	92.63	83.4			34.68	8.68	34.13	100	169	Average
5785	99.81	90.58			34.68	8.68	34.13	100	169	Peak
11570	47.32	32.01	54	-6.68	38	12.68	35.37	157	111	Average
11570	55.62	40.31	74	-18.38	38	12.68	35.37	157	111	Peak
Antenna Polarity & Test Distance: Vertical at 3 m										
Frequency (MHz)	Emission Level (dBuV/m)	Read Level (dBuV)	Limit (dBuV/m)	Margin (dB)	Antenna Factor (dB/m)	Cable Loss (dB)	Preamp Factor (dB)	Antenna Height (cm)	Table Angle (Degree)	Remark
5785	97.77	88.54			34.68	8.68	34.13	200	186	Average
5785	104.4	95.17			34.68	8.68	34.13	200	186	Peak
11570	47.28	31.97	54	-6.72	38	12.68	35.37	141	246	Average
11570	56.78	41.47	74	-17.22	38	12.68	35.37	141	246	Peak

<Out of Band Emission (OOBE)>

Antenna Polarity & Test Distance: Horizontal at 3 m										
Frequency (MHz)	Emission Level (dBuV/m)	Read Level (dBuV)	Limit (dBuV/m)	Margin (dB)	Antenna Factor (dB/m)	Cable Loss (dB)	Preamp Factor (dB)	Antenna Height (cm)	Table Angle (Degree)	Remark
*5646.475	53.95	44.88	68.2	-14.25	34.54	8.62	34.09	100	169	Peak
5655.4	52.92	43.83	72.2	-19.28	34.56	8.63	34.1	100	169	Peak
5923.675	52.27	42.87	69.18	-16.91	34.83	8.73	34.16	100	169	Peak
*6025	54.35	44.83	68.2	-13.85	34.93	8.77	34.18	100	169	Peak
Antenna Polarity & Test Distance: Vertical at 3 m										
Frequency (MHz)	Emission Level (dBuV/m)	Read Level (dBuV)	Limit (dBuV/m)	Margin (dB)	Antenna Factor (dB/m)	Cable Loss (dB)	Preamp Factor (dB)	Antenna Height (cm)	Table Angle (Degree)	Remark
*5597.125	55.05	46.04	68.2	-13.15	34.49	8.6	34.08	200	186	Peak
5655.4	52.64	43.55	72.2	-19.56	34.56	8.63	34.1	200	186	Peak
5920.525	52.61	43.23	71.51	-18.9	34.81	8.73	34.16	200	186	Peak
*5962	53.47	44.03	68.2	-14.73	34.87	8.74	34.17	200	186	Peak

Remarks:

- Emission Level = Read Level + Antenna Factor + Cable Loss - Preamp Factor
Margin value = Emission level – Limit value
- 5785 MHz: Fundamental Frequency
- *: Out of Restricted Band
- The emission levels of other frequencies were very low against the limit

EUT Test Condition		Measurement Detail	
Channel	Channel 165	Frequency Range	1 GHz ~ 40 GHz
Input Power	120 Vac, 60 Hz	Detector Function	Peak (PK) Average (AV)
Environmental Conditions	25 deg. C, 65 % RH	Tested By	Charles Hsiao

<Spurious Emission>

Antenna Polarity & Test Distance: Horizontal at 3 m										
Frequency (MHz)	Emission Level (dBuV/m)	Read Level (dBuV)	Limit (dBuV/m)	Margin (dB)	Antenna Factor (dB/m)	Cable Loss (dB)	Preamp Factor (dB)	Antenna Height (cm)	Table Angle (Degree)	Remark
5825	91.57	82.28			34.73	8.69	34.13	100	169	Average
5825	98.15	88.86			34.73	8.69	34.13	100	169	Peak
11650	47.52	31.99	54	-6.48	38.09	12.8	35.36	151	111	Average
11650	56.69	41.16	74	-17.31	38.09	12.8	35.36	151	111	Peak
Antenna Polarity & Test Distance: Vertical at 3 m										
Frequency (MHz)	Emission Level (dBuV/m)	Read Level (dBuV)	Limit (dBuV/m)	Margin (dB)	Antenna Factor (dB/m)	Cable Loss (dB)	Preamp Factor (dB)	Antenna Height (cm)	Table Angle (Degree)	Remark
5825	96.67	87.38			34.73	8.69	34.13	200	186	Average
5825	103.14	93.85			34.73	8.69	34.13	200	186	Peak
11650	47.59	32.06	54	-6.41	38.09	12.8	35.36	196	322	Average
11650	55.97	40.44	74	-18.03	38.09	12.8	35.36	196	322	Peak

<Out of Band Emission (OOBE)>

Antenna Polarity & Test Distance: Horizontal at 3 m										
Frequency (MHz)	Emission Level (dBuV/m)	Read Level (dBuV)	Limit (dBuV/m)	Margin (dB)	Antenna Factor (dB/m)	Cable Loss (dB)	Preamp Factor (dB)	Antenna Height (cm)	Table Angle (Degree)	Remark
*5567.725	53.3	44.31	68.2	-14.9	34.47	8.59	34.07	100	169	Peak
5654.875	51.67	42.58	71.81	-20.14	34.56	8.63	34.1	100	169	Peak
5916.325	52.82	43.44	74.62	-21.8	34.81	8.73	34.16	100	169	Peak
*5939.425	54.76	45.33	68.2	-13.44	34.85	8.74	34.16	100	169	Peak
Antenna Polarity & Test Distance: Vertical at 3 m										
Frequency (MHz)	Emission Level (dBuV/m)	Read Level (dBuV)	Limit (dBuV/m)	Margin (dB)	Antenna Factor (dB/m)	Cable Loss (dB)	Preamp Factor (dB)	Antenna Height (cm)	Table Angle (Degree)	Remark
*5622.325	53.09	44.04	68.2	-15.11	34.52	8.61	34.08	200	186	Peak
5659.6	52.3	43.21	75.3	-23	34.56	8.63	34.1	200	186	Peak
5922.625	52.67	43.27	69.96	-17.29	34.83	8.73	34.16	200	186	Peak
*5980.375	54.95	45.49	68.2	-13.25	34.88	8.75	34.17	200	186	Peak

Remarks:

- Emission Level = Read Level + Antenna Factor + Cable Loss - Preamp Factor
Margin value = Emission level – Limit value
- 5825 MHz: Fundamental Frequency
- *: Out of Restricted Band
- The emission levels of other frequencies were very low against the limit

802.11n (HT20)

EUT Test Condition		Measurement Detail	
Channel	Channel 36	Frequency Range	1 GHz ~ 40 GHz
Input Power	120 Vac, 60 Hz	Detector Function	Peak (PK) Average (AV)
Environmental Conditions	25 deg. C, 65 % RH	Tested By	Charles Hsiao

Antenna Polarity & Test Distance: Horizontal at 3 m

Frequency (MHz)	Emission Level (dBuV/m)	Read Level (dBuV)	Limit (dBuV/m)	Margin (dB)	Antenna Factor (dB/m)	Cable Loss (dB)	Preamp Factor (dB)	Antenna Height (cm)	Table Angle (Degree)	Remark
5149.1	43.79	35.54	54	-10.21	34.12	8.13	34	128	207	Average
5149.1	54.86	46.61	74	-19.14	34.12	8.13	34	128	207	Peak
5180	97.49	89.18			34.15	8.16	34	128	207	Average
5180	104.38	96.07			34.15	8.16	34	128	207	Peak
*10360	53.21	38.91	68.2	-14.99	37.12	12.3	35.12	117	4	Peak

Antenna Polarity & Test Distance: Vertical at 3 m

Frequency (MHz)	Emission Level (dBuV/m)	Read Level (dBuV)	Limit (dBuV/m)	Margin (dB)	Antenna Factor (dB/m)	Cable Loss (dB)	Preamp Factor (dB)	Antenna Height (cm)	Table Angle (Degree)	Remark
5135	42.88	34.63	54	-11.12	34.11	8.13	33.99	200	196	Average
5135	53.36	45.11	74	-20.64	34.11	8.13	33.99	200	196	Peak
5180	95.66	87.35			34.15	8.16	34	200	196	Average
5180	102.41	94.1			34.15	8.16	34	200	196	Peak
*10360	53.55	39.25	68.2	-14.65	37.12	12.3	35.12	112	300	Peak

Remarks:

- Emission Level = Read Level + Antenna Factor + Cable Loss - Preamp Factor
Margin value = Emission level – Limit value
- 5180 MHz: Fundamental Frequency
- *: Out of Restricted Band
- The emission levels of other frequencies were very low against the limit

EUT Test Condition		Measurement Detail	
Channel	Channel 40	Frequency Range	1 GHz ~ 40 GHz
Input Power	120 Vac, 60 Hz	Detector Function	Peak (PK) Average (AV)
Environmental Conditions	25 deg. C, 65 % RH	Tested By	Charles Hsiao

Antenna Polarity & Test Distance: Horizontal at 3 m										
Frequency (MHz)	Emission Level (dBuV/m)	Read Level (dBuV)	Limit (dBuV/m)	Margin (dB)	Antenna Factor (dB/m)	Cable Loss (dB)	Preamp Factor (dB)	Antenna Height (cm)	Table Angle (Degree)	Remark
5142.95	43.19	34.93	54	-10.81	34.12	8.13	33.99	128	207	Average
5142.95	53.71	45.45	74	-20.29	34.12	8.13	33.99	128	207	Peak
5200	98.57	90.22			34.16	8.19	34	128	207	Average
5200	105.5	97.15			34.16	8.19	34	128	207	Peak
5423.15	42.57	33.8	54	-11.43	34.33	8.48	34.04	128	207	Average
5423.15	53.54	44.77	74	-20.46	34.33	8.48	34.04	128	207	Peak
*10400	53.06	38.72	68.2	-15.14	37.14	12.36	35.16	157	208	Peak
Antenna Polarity & Test Distance: Vertical at 3 m										
Frequency (MHz)	Emission Level (dBuV/m)	Read Level (dBuV)	Limit (dBuV/m)	Margin (dB)	Antenna Factor (dB/m)	Cable Loss (dB)	Preamp Factor (dB)	Antenna Height (cm)	Table Angle (Degree)	Remark
5140.25	43.25	34.99	54	-10.75	34.12	8.13	33.99	200	196	Average
5140.25	54.23	45.97	74	-19.77	34.12	8.13	33.99	200	196	Peak
5200	96.33	87.98			34.16	8.19	34	200	196	Average
5200	103.08	94.73			34.16	8.19	34	200	196	Peak
5448.12	42.52	33.69	54	-11.48	34.36	8.51	34.04	200	196	Average
5448.12	54	45.17	74	-20	34.36	8.51	34.04	200	196	Peak
*10400	54.14	39.8	68.2	-14.06	37.14	12.36	35.16	114	258	Peak

Remarks:

- Emission Level = Read Level + Antenna Factor + Cable Loss - Preamp Factor
Margin value = Emission level – Limit value
- 5200 MHz: Fundamental Frequency
- *: Out of Restricted Band
- The emission levels of other frequencies were very low against the limit

EUT Test Condition		Measurement Detail	
Channel	Channel 48	Frequency Range	1 GHz ~ 40 GHz
Input Power	120 Vac, 60 Hz	Detector Function	Peak (PK) Average (AV)
Environmental Conditions	25 deg. C, 65 % RH	Tested By	Charles Hsiao

Antenna Polarity & Test Distance: Horizontal at 3 m										
Frequency (MHz)	Emission Level (dBuV/m)	Read Level (dBuV)	Limit (dBuV/m)	Margin (dB)	Antenna Factor (dB/m)	Cable Loss (dB)	Preamp Factor (dB)	Antenna Height (cm)	Table Angle (Degree)	Remark
5240	98.77	90.33			34.19	8.26	34.01	128	207	Average
5240	105.97	97.53			34.19	8.26	34.01	128	207	Peak
5452.41	42.64	33.82	54	-11.36	34.36	8.51	34.05	128	207	Average
5452.41	53.27	44.45	74	-20.73	34.36	8.51	34.05	128	207	Peak
*10480	54.25	39.74	68.2	-13.95	37.19	12.53	35.21	157	44	Peak

Antenna Polarity & Test Distance: Vertical at 3 m										
Frequency (MHz)	Emission Level (dBuV/m)	Read Level (dBuV)	Limit (dBuV/m)	Margin (dB)	Antenna Factor (dB/m)	Cable Loss (dB)	Preamp Factor (dB)	Antenna Height (cm)	Table Angle (Degree)	Remark
5240	96.57	88.13			34.19	8.26	34.01	200	196	Average
5240	103.63	95.19			34.19	8.26	34.01	200	196	Peak
5441.74	42.6	33.81	54	-11.4	34.35	8.48	34.04	200	196	Average
5441.74	53.19	44.4	74	-20.81	34.35	8.48	34.04	200	196	Peak
*10480	53.52	39.01	68.2	-14.68	37.19	12.53	35.21	124	211	Peak

Remarks:

- Emission Level = Read Level + Antenna Factor + Cable Loss - Preamp Factor
Margin value = Emission level – Limit value
- 5240 MHz: Fundamental Frequency
- *: Out of Restricted Band
- The emission levels of other frequencies were very low against the limit

EUT Test Condition		Measurement Detail	
Channel	Channel 52	Frequency Range	1 GHz ~ 40 GHz
Input Power	120 Vac, 60 Hz	Detector Function	Peak (PK) Average (AV)
Environmental Conditions	25 deg. C, 65 % RH	Tested By	Charles Hsiao

Antenna Polarity & Test Distance: Horizontal at 3 m										
Frequency (MHz)	Emission Level (dBuV/m)	Read Level (dBuV)	Limit (dBuV/m)	Margin (dB)	Antenna Factor (dB/m)	Cable Loss (dB)	Preamp Factor (dB)	Antenna Height (cm)	Table Angle (Degree)	Remark
5148.8	42.82	34.57	54	-11.18	34.12	8.13	34	100	209	Average
5148.8	53.21	44.96	74	-20.79	34.12	8.13	34	100	209	Peak
5260	97.79	89.33			34.21	8.26	34.01	100	209	Average
5260	104.12	95.66			34.21	8.26	34.01	100	209	Peak
*10520	54.25	39.66	68.2	-13.95	37.21	12.61	35.23	100	360	Peak

Antenna Polarity & Test Distance: Vertical at 3 m										
Frequency (MHz)	Emission Level (dBuV/m)	Read Level (dBuV)	Limit (dBuV/m)	Margin (dB)	Antenna Factor (dB/m)	Cable Loss (dB)	Preamp Factor (dB)	Antenna Height (cm)	Table Angle (Degree)	Remark
5110.4	42.73	34.53	54	-11.27	34.09	8.1	33.99	190	196	Average
5110.4	54.3	46.1	74	-19.7	34.09	8.1	33.99	190	196	Peak
5260	96.59	88.13			34.21	8.26	34.01	190	196	Average
5260	103.01	94.55			34.21	8.26	34.01	190	196	Peak
*10520	54.14	39.55	68.2	-14.06	37.21	12.61	35.23	105	133	Peak

Remarks:

- Emission Level = Read Level + Antenna Factor + Cable Loss - Preamp Factor
Margin value = Emission level – Limit value
- 5260 MHz: Fundamental Frequency
- *: Out of Restricted Band
- The emission levels of other frequencies were very low against the limit

EUT Test Condition		Measurement Detail	
Channel	Channel 60	Frequency Range	1 GHz ~ 40 GHz
Input Power	120 Vac, 60 Hz	Detector Function	Peak (PK) Average (AV)
Environmental Conditions	25 deg. C, 65 % RH	Tested By	Charles Hsiao

Antenna Polarity & Test Distance: Horizontal at 3 m										
Frequency (MHz)	Emission Level (dBuV/m)	Read Level (dBuV)	Limit (dBuV/m)	Margin (dB)	Antenna Factor (dB/m)	Cable Loss (dB)	Preamp Factor (dB)	Antenna Height (cm)	Table Angle (Degree)	Remark
5106.95	42.59	34.42	54	-11.41	34.09	8.07	33.99	116	188	Average
5106.95	53.61	45.44	74	-20.39	34.09	8.07	33.99	116	188	Peak
5300	97.55	89.01			34.24	8.32	34.02	116	188	Average
5300	104.32	95.78			34.24	8.32	34.02	116	188	Peak
5352.2	44.01	35.38	54	-9.99	34.28	8.38	34.03	116	188	Average
5352.2	54.95	46.32	74	-19.05	34.28	8.38	34.03	116	188	Peak
10600	46.71	32.03	54	-7.29	37.28	12.67	35.27	187	199	Average
10600	54.14	39.46	74	-19.86	37.28	12.67	35.27	187	199	Peak

Antenna Polarity & Test Distance: Vertical at 3 m										
Frequency (MHz)	Emission Level (dBuV/m)	Read Level (dBuV)	Limit (dBuV/m)	Margin (dB)	Antenna Factor (dB/m)	Cable Loss (dB)	Preamp Factor (dB)	Antenna Height (cm)	Table Angle (Degree)	Remark
5100.95	42.62	34.46	54	-11.38	34.08	8.07	33.99	190	196	Average
5100.95	53.04	44.88	74	-20.96	34.08	8.07	33.99	190	196	Peak
5300	96.49	87.95			34.24	8.32	34.02	190	196	Average
5300	103.46	94.92			34.24	8.32	34.02	190	196	Peak
5350.44	43.96	35.33	54	-10.04	34.28	8.38	34.03	190	196	Average
5350.44	54.42	45.79	74	-19.58	34.28	8.38	34.03	190	196	Peak
10600	46.35	31.67	54	-7.65	37.28	12.67	35.27	158	228	Average
10600	53.35	38.67	74	-20.65	37.28	12.67	35.27	158	228	Peak

Remarks:

- Emission Level = Read Level + Antenna Factor + Cable Loss - Preamp Factor
Margin value = Emission level – Limit value
- 5300 MHz: Fundamental Frequency
- The emission levels of other frequencies were very low against the limit

EUT Test Condition		Measurement Detail	
Channel	Channel 64	Frequency Range	1 GHz ~ 40 GHz
Input Power	120 Vac, 60 Hz	Detector Function	Peak (PK) Average (AV)
Environmental Conditions	25 deg. C, 65 % RH	Tested By	Charles Hsiao

Antenna Polarity & Test Distance: Horizontal at 3 m										
Frequency (MHz)	Emission Level (dBuV/m)	Read Level (dBuV)	Limit (dBuV/m)	Margin (dB)	Antenna Factor (dB/m)	Cable Loss (dB)	Preamp Factor (dB)	Antenna Height (cm)	Table Angle (Degree)	Remark
5320	96.33	87.75			34.25	8.35	34.02	116	188	Average
5320	103.63	95.05			34.25	8.35	34.02	116	188	Peak
5374.09	43.6	34.94	54	-10.4	34.29	8.41	34.04	116	188	Average
5374.09	54.34	45.68	74	-19.66	34.29	8.41	34.04	116	188	Peak
10640	46.97	32.24	54	-7.03	37.31	12.71	35.29	154	332	Average
10640	54.74	40.01	74	-19.26	37.31	12.71	35.29	154	332	Peak

Antenna Polarity & Test Distance: Vertical at 3 m										
Frequency (MHz)	Emission Level (dBuV/m)	Read Level (dBuV)	Limit (dBuV/m)	Margin (dB)	Antenna Factor (dB/m)	Cable Loss (dB)	Preamp Factor (dB)	Antenna Height (cm)	Table Angle (Degree)	Remark
5320	95.28	86.7			34.25	8.35	34.02	190	196	Average
5320	102.62	94.04			34.25	8.35	34.02	190	196	Peak
5374.53	43.61	34.95	54	-10.39	34.29	8.41	34.04	190	196	Average
5374.53	55.14	46.48	74	-18.86	34.29	8.41	34.04	190	196	Peak
10640	46.83	32.1	54	-7.17	37.31	12.71	35.29	124	310	Average
10640	53.65	38.92	74	-20.35	37.31	12.71	35.29	124	310	Peak

Remarks:

- Emission Level = Read Level + Antenna Factor + Cable Loss - Preamp Factor
Margin value = Emission level – Limit value
- 5320 MHz: Fundamental Frequency
- The emission levels of other frequencies were very low against the limit

EUT Test Condition		Measurement Detail	
Channel	Channel 100	Frequency Range	1 GHz ~ 40 GHz
Input Power	120 Vac, 60 Hz	Detector Function	Peak (PK) Average (AV)
Environmental Conditions	25 deg. C, 65 % RH	Tested By	Charles Hsiao

Antenna Polarity & Test Distance: Horizontal at 3 m										
Frequency (MHz)	Emission Level (dBuV/m)	Read Level (dBuV)	Limit (dBuV/m)	Margin (dB)	Antenna Factor (dB/m)	Cable Loss (dB)	Preamp Factor (dB)	Antenna Height (cm)	Table Angle (Degree)	Remark
5450.64	43.13	34.31	54	-10.87	34.36	8.51	34.05	100	199	Average
5450.64	53.37	44.55	74	-20.63	34.36	8.51	34.05	100	199	Peak
*5469.04	52.98	44.15	68.2	-15.22	34.37	8.51	34.05	100	199	Peak
5500	92.34	83.42			34.4	8.57	34.05	100	199	Average
5500	99.47	90.55			34.4	8.57	34.05	100	199	Peak
11000	45.86	30.78	54	-8.14	37.6	12.96	35.48	154	122	Average
11000	55.4	40.32	74	-18.6	37.6	12.96	35.48	154	122	Peak
Antenna Polarity & Test Distance: Vertical at 3 m										
Frequency (MHz)	Emission Level (dBuV/m)	Read Level (dBuV)	Limit (dBuV/m)	Margin (dB)	Antenna Factor (dB/m)	Cable Loss (dB)	Preamp Factor (dB)	Antenna Height (cm)	Table Angle (Degree)	Remark
5458.48	43.58	34.76	54	-10.42	34.36	8.51	34.05	162	213	Average
5458.48	54.38	45.56	74	-19.62	34.36	8.51	34.05	162	213	Peak
*5470.16	53.54	44.71	68.2	-14.66	34.37	8.51	34.05	162	213	Peak
5500	95.46	86.54			34.4	8.57	34.05	162	213	Average
5500	102.67	93.75			34.4	8.57	34.05	162	213	Peak
11000	45.92	30.84	54	-8.08	37.6	12.96	35.48	165	9	Average
11000	55.4	40.32	74	-18.6	37.6	12.96	35.48	165	9	Peak

Remarks:

- Emission Level = Read Level + Antenna Factor + Cable Loss - Preamp Factor
Margin value = Emission level – Limit value
- 5500 MHz: Fundamental Frequency
- *: Out of Restricted Band
- The emission levels of other frequencies were very low against the limit

EUT Test Condition		Measurement Detail	
Channel	Channel 116	Frequency Range	1 GHz ~ 40 GHz
Input Power	120 Vac, 60 Hz	Detector Function	Peak (PK) Average (AV)
Environmental Conditions	25 deg. C, 65 % RH	Tested By	Charles Hsiao

Antenna Polarity & Test Distance: Horizontal at 3 m										
Frequency (MHz)	Emission Level (dBuV/m)	Read Level (dBuV)	Limit (dBuV/m)	Margin (dB)	Antenna Factor (dB/m)	Cable Loss (dB)	Preamp Factor (dB)	Antenna Height (cm)	Table Angle (Degree)	Remark
5443.6	42.86	34.07	54	-11.14	34.35	8.48	34.04	100	196	Average
5443.6	54.74	45.95	74	-19.26	34.35	8.48	34.04	100	196	Peak
*5468.08	53.09	44.26	68.2	-15.11	34.37	8.51	34.05	100	196	Peak
5580	95.78	86.79			34.47	8.6	34.08	100	196	Average
5580	103.05	94.06			34.47	8.6	34.08	100	196	Peak
*5724.68	52.27	43.11	68.2	-15.93	34.62	8.65	34.11	100	196	Peak
11160	45.59	30.51	54	-8.41	37.7	12.83	35.45	136	276	Average
11160	55.14	40.06	74	-18.86	37.7	12.83	35.45	136	276	Peak

Antenna Polarity & Test Distance: Vertical at 3 m										
Frequency (MHz)	Emission Level (dBuV/m)	Read Level (dBuV)	Limit (dBuV/m)	Margin (dB)	Antenna Factor (dB/m)	Cable Loss (dB)	Preamp Factor (dB)	Antenna Height (cm)	Table Angle (Degree)	Remark
5458.32	43.01	34.19	54	-10.99	34.36	8.51	34.05	231	213	Average
5458.32	53.14	44.32	74	-20.86	34.36	8.51	34.05	231	213	Peak
*5470.16	52.41	43.58	68.2	-15.79	34.37	8.51	34.05	231	213	Peak
5580	99.03	90.04			34.47	8.6	34.08	231	213	Average
5580	106.48	97.49			34.47	8.6	34.08	231	213	Peak
*5725.24	53.32	44.16	68.2	-14.88	34.62	8.65	34.11	231	213	Peak
11160	45.62	30.54	54	-8.38	37.7	12.83	35.45	125	108	Average
11160	55.13	40.05	74	-18.87	37.7	12.83	35.45	125	108	Peak

Remarks:

- Emission Level = Read Level + Antenna Factor + Cable Loss - Preamp Factor
Margin value = Emission level – Limit value
- 5580 MHz: Fundamental Frequency
- *: Out of Restricted Band
- The emission levels of other frequencies were very low against the limit

EUT Test Condition		Measurement Detail	
Channel	Channel 140	Frequency Range	1 GHz ~ 40 GHz
Input Power	120 Vac, 60 Hz	Detector Function	Peak (PK) Average (AV)
Environmental Conditions	25 deg. C, 65 % RH	Tested By	Charles Hsiao

Antenna Polarity & Test Distance: Horizontal at 3 m										
Frequency (MHz)	Emission Level (dBuV/m)	Read Level (dBuV)	Limit (dBuV/m)	Margin (dB)	Antenna Factor (dB/m)	Cable Loss (dB)	Preamp Factor (dB)	Antenna Height (cm)	Table Angle (Degree)	Remark
5700	89.16	80.03			34.59	8.64	34.1	100	185	Average
5700	97.09	87.96			34.59	8.64	34.1	100	185	Peak
*5724.52	52.41	43.25	68.2	-15.79	34.62	8.65	34.11	100	185	Peak
11400	45.43	30.33	54	-8.57	37.84	12.67	35.41	128	185	Average
11400	54.94	39.84	74	-19.06	37.84	12.67	35.41	128	185	Peak

Antenna Polarity & Test Distance: Vertical at 3 m										
Frequency (MHz)	Emission Level (dBuV/m)	Read Level (dBuV)	Limit (dBuV/m)	Margin (dB)	Antenna Factor (dB/m)	Cable Loss (dB)	Preamp Factor (dB)	Antenna Height (cm)	Table Angle (Degree)	Remark
5700	95.94	86.81			34.59	8.64	34.1	233	215	Average
5700	103.52	94.39			34.59	8.64	34.1	233	215	Peak
*5724.28	54.03	44.87	68.2	-14.17	34.62	8.65	34.11	233	215	Peak
11400	45.17	30.07	54	-8.83	37.84	12.67	35.41	146	229	Average
11400	54.71	39.61	74	-19.29	37.84	12.67	35.41	146	229	Peak

Remarks:

- Emission Level = Read Level + Antenna Factor + Cable Loss - Preamp Factor
Margin value = Emission level – Limit value
- 5700 MHz: Fundamental Frequency
- *: Out of Restricted Band
- The emission levels of other frequencies were very low against the limit

EUT Test Condition		Measurement Detail	
Channel	Channel 149	Frequency Range	1 GHz ~ 40 GHz
Input Power	120 Vac, 60 Hz	Detector Function	Peak (PK) Average (AV)
Environmental Conditions	25 deg. C, 65 % RH	Tested By	Charles Hsiao

<Spurious Emission>

Antenna Polarity & Test Distance: Horizontal at 3 m										
Frequency (MHz)	Emission Level (dBuV/m)	Read Level (dBuV)	Limit (dBuV/m)	Margin (dB)	Antenna Factor (dB/m)	Cable Loss (dB)	Preamp Factor (dB)	Antenna Height (cm)	Table Angle (Degree)	Remark
5745	88.52	79.33			34.64	8.66	34.11	100	169	Average
5745	95.55	86.36			34.64	8.66	34.11	100	169	Peak
11490	46.9	31.78	54	-7.1	37.89	12.62	35.39	137	118	Average
11490	56.52	41.4	74	-17.48	37.89	12.62	35.39	137	118	Peak
Antenna Polarity & Test Distance: Vertical at 3 m										
Frequency (MHz)	Emission Level (dBuV/m)	Read Level (dBuV)	Limit (dBuV/m)	Margin (dB)	Antenna Factor (dB/m)	Cable Loss (dB)	Preamp Factor (dB)	Antenna Height (cm)	Table Angle (Degree)	Remark
5745	93.49	84.3			34.64	8.66	34.11	200	186	Average
5745	100.3	91.11			34.64	8.66	34.11	200	186	Peak
11490	47.17	32.05	54	-6.83	37.89	12.62	35.39	158	188	Average
11490	55.27	40.15	74	-18.73	37.89	12.62	35.39	158	188	Peak

<Out of Band Emission (OOBE)>

Antenna Polarity & Test Distance: Horizontal at 3 m										
Frequency (MHz)	Emission Level (dBuV/m)	Read Level (dBuV)	Limit (dBuV/m)	Margin (dB)	Antenna Factor (dB/m)	Cable Loss (dB)	Preamp Factor (dB)	Antenna Height (cm)	Table Angle (Degree)	Remark
*5622.325	53.85	44.8	68.2	-14.35	34.52	8.61	34.08	100	169	Peak
5660.125	54.17	45.08	75.69	-21.52	34.56	8.63	34.1	100	169	Peak
5922.1	53.62	44.22	70.35	-16.73	34.83	8.73	34.16	100	169	Peak
*5999.275	54.18	44.69	68.2	-14.02	34.9	8.76	34.17	100	169	Peak
Antenna Polarity & Test Distance: Vertical at 3 m										
Frequency (MHz)	Emission Level (dBuV/m)	Read Level (dBuV)	Limit (dBuV/m)	Margin (dB)	Antenna Factor (dB/m)	Cable Loss (dB)	Preamp Factor (dB)	Antenna Height (cm)	Table Angle (Degree)	Remark
*5565.625	53.53	44.54	68.2	-14.67	34.47	8.59	34.07	200	186	Peak
5653.825	52.68	43.59	71.03	-18.35	34.56	8.63	34.1	200	186	Peak
5923.15	51.52	42.12	69.57	-18.05	34.83	8.73	34.16	200	186	Peak
*6008.725	53.3	43.79	68.2	-14.9	34.92	8.76	34.17	200	186	Peak

Remarks:

- Emission Level = Read Level + Antenna Factor + Cable Loss - Preamp Factor
Margin value = Emission level – Limit value
- 5745 MHz: Fundamental Frequency
- *: Out of Restricted Band
- The emission levels of other frequencies were very low against the limit

EUT Test Condition		Measurement Detail	
Channel	Channel 157	Frequency Range	1 GHz ~ 40 GHz
Input Power	120 Vac, 60 Hz	Detector Function	Peak (PK) Average (AV)
Environmental Conditions	25 deg. C, 65 % RH	Tested By	Charles Hsiao

<Spurious Emission>

Antenna Polarity & Test Distance: Horizontal at 3 m										
Frequency (MHz)	Emission Level (dBuV/m)	Read Level (dBuV)	Limit (dBuV/m)	Margin (dB)	Antenna Factor (dB/m)	Cable Loss (dB)	Preamp Factor (dB)	Antenna Height (cm)	Table Angle (Degree)	Remark
5785	92.52	83.29			34.68	8.68	34.13	100	169	Average
5785	99.76	90.53			34.68	8.68	34.13	100	169	Peak
11570	46.89	31.58	54	-7.11	38	12.68	35.37	158	59	Average
11570	55.47	40.16	74	-18.53	38	12.68	35.37	158	59	Peak
Antenna Polarity & Test Distance: Vertical at 3 m										
Frequency (MHz)	Emission Level (dBuV/m)	Read Level (dBuV)	Limit (dBuV/m)	Margin (dB)	Antenna Factor (dB/m)	Cable Loss (dB)	Preamp Factor (dB)	Antenna Height (cm)	Table Angle (Degree)	Remark
5785	97.77	88.54			34.68	8.68	34.13	200	186	Average
5785	104.84	95.61			34.68	8.68	34.13	200	186	Peak
11570	47.23	31.92	54	-6.77	38	12.68	35.37	104	24	Average
11570	56.56	41.25	74	-17.44	38	12.68	35.37	104	24	Peak

<Out of Band Emission (OOBE)>

Antenna Polarity & Test Distance: Horizontal at 3 m										
Frequency (MHz)	Emission Level (dBuV/m)	Read Level (dBuV)	Limit (dBuV/m)	Margin (dB)	Antenna Factor (dB/m)	Cable Loss (dB)	Preamp Factor (dB)	Antenna Height (cm)	Table Angle (Degree)	Remark
*5586.625	54.4	45.39	68.2	-13.8	34.49	8.6	34.08	100	169	Peak
5659.075	53.87	44.78	74.92	-21.05	34.56	8.63	34.1	100	169	Peak
5920	54.62	45.24	71.9	-17.28	34.81	8.73	34.16	100	169	Peak
*5960.95	55.55	46.11	68.2	-12.65	34.87	8.74	34.17	100	169	Peak
Antenna Polarity & Test Distance: Vertical at 3 m										
Frequency (MHz)	Emission Level (dBuV/m)	Read Level (dBuV)	Limit (dBuV/m)	Margin (dB)	Antenna Factor (dB/m)	Cable Loss (dB)	Preamp Factor (dB)	Antenna Height (cm)	Table Angle (Degree)	Remark
*5643.85	53.5	44.43	68.2	-14.7	34.54	8.62	34.09	200	186	Peak
5656.975	51.85	42.76	73.36	-21.51	34.56	8.63	34.1	200	186	Peak
5917.9	53.48	44.1	73.45	-19.97	34.81	8.73	34.16	200	186	Peak
*6011.35	53.65	44.15	68.2	-14.55	34.92	8.76	34.18	200	186	Peak

Remarks:

- Emission Level = Read Level + Antenna Factor + Cable Loss - Preamp Factor
Margin value = Emission level – Limit value
- 5785 MHz: Fundamental Frequency
- *: Out of Restricted Band
- The emission levels of other frequencies were very low against the limit

EUT Test Condition		Measurement Detail	
Channel	Channel 165	Frequency Range	1 GHz ~ 40 GHz
Input Power	120 Vac, 60 Hz	Detector Function	Peak (PK) Average (AV)
Environmental Conditions	25 deg. C, 65 % RH	Tested By	Charles Hsiao

<Spurious Emission>

Antenna Polarity & Test Distance: Horizontal at 3 m										
Frequency (MHz)	Emission Level (dBuV/m)	Read Level (dBuV)	Limit (dBuV/m)	Margin (dB)	Antenna Factor (dB/m)	Cable Loss (dB)	Preamp Factor (dB)	Antenna Height (cm)	Table Angle (Degree)	Remark
5825	91.52	82.23			34.73	8.69	34.13	100	169	Average
5825	98.24	88.95			34.73	8.69	34.13	100	169	Peak
11650	47.57	32.04	54	-6.43	38.09	12.8	35.36	134	311	Average
11650	56.6	41.07	74	-17.4	38.09	12.8	35.36	134	311	Peak
Antenna Polarity & Test Distance: Vertical at 3 m										
Frequency (MHz)	Emission Level (dBuV/m)	Read Level (dBuV)	Limit (dBuV/m)	Margin (dB)	Antenna Factor (dB/m)	Cable Loss (dB)	Preamp Factor (dB)	Antenna Height (cm)	Table Angle (Degree)	Remark
5825	96.32	87.03			34.73	8.69	34.13	200	186	Average
5825	103.12	93.83			34.73	8.69	34.13	200	186	Peak
11650	47.52	31.99	54	-6.48	38.09	12.8	35.36	113	38	Average
11650	55.68	40.15	74	-18.32	38.09	12.8	35.36	113	38	Peak

<Out of Band Emission (OOBE)>

Antenna Polarity & Test Distance: Horizontal at 3 m										
Frequency (MHz)	Emission Level (dBuV/m)	Read Level (dBuV)	Limit (dBuV/m)	Margin (dB)	Antenna Factor (dB/m)	Cable Loss (dB)	Preamp Factor (dB)	Antenna Height (cm)	Table Angle (Degree)	Remark
*5593.975	53.67	44.66	68.2	-14.53	34.49	8.6	34.08	100	169	Peak
5656.45	52.33	43.24	72.97	-20.64	34.56	8.63	34.1	100	169	Peak
5922.1	52.35	42.95	70.35	-18	34.83	8.73	34.16	100	169	Peak
*5936.275	54.41	45.01	68.2	-13.79	34.83	8.73	34.16	100	169	Peak
Antenna Polarity & Test Distance: Vertical at 3 m										
Frequency (MHz)	Emission Level (dBuV/m)	Read Level (dBuV)	Limit (dBuV/m)	Margin (dB)	Antenna Factor (dB/m)	Cable Loss (dB)	Preamp Factor (dB)	Antenna Height (cm)	Table Angle (Degree)	Remark
*5590.3	53.16	44.15	68.2	-15.04	34.49	8.6	34.08	200	186	Peak
5654.875	51.63	42.54	71.81	-20.18	34.56	8.63	34.1	200	186	Peak
5917.375	52.11	42.73	73.84	-21.73	34.81	8.73	34.16	200	186	Peak
*5966.2	54.94	45.49	68.2	-13.26	34.87	8.75	34.17	200	186	Peak

Remarks:

- Emission Level = Read Level + Antenna Factor + Cable Loss - Preamp Factor
Margin value = Emission level – Limit value
- 5825 MHz: Fundamental Frequency
- *: Out of Restricted Band
- The emission levels of other frequencies were very low against the limit

802.11n (HT40)

EUT Test Condition		Measurement Detail	
Channel	Channel 38	Frequency Range	1 GHz ~ 40 GHz
Input Power	120 Vac, 60 Hz	Detector Function	Peak (PK) Average (AV)
Environmental Conditions	25 deg. C, 65 % RH	Tested By	Charles Hsiao

Antenna Polarity & Test Distance: Horizontal at 3 m

Frequency (MHz)	Emission Level (dBuV/m)	Read Level (dBuV)	Limit (dBuV/m)	Margin (dB)	Antenna Factor (dB/m)	Cable Loss (dB)	Preamp Factor (dB)	Antenna Height (cm)	Table Angle (Degree)	Remark
5148.95	44.25	36	54	-9.75	34.12	8.13	34	128	207	Average
5148.95	54.13	45.88	74	-19.87	34.12	8.13	34	128	207	Peak
5190	90.65	82.31			34.15	8.19	34	128	207	Average
5190	97.37	89.03			34.15	8.19	34	128	207	Peak
5414.46	43.06	34.33	54	-10.94	34.33	8.44	34.04	128	207	Average
5414.46	53.07	44.34	74	-20.93	34.33	8.44	34.04	128	207	Peak
*10380	53.87	39.52	68.2	-14.33	37.13	12.36	35.14	113	300	Peak

Antenna Polarity & Test Distance: Vertical at 3 m

Frequency (MHz)	Emission Level (dBuV/m)	Read Level (dBuV)	Limit (dBuV/m)	Margin (dB)	Antenna Factor (dB/m)	Cable Loss (dB)	Preamp Factor (dB)	Antenna Height (cm)	Table Angle (Degree)	Remark
5148.95	43.31	35.06	54	-10.69	34.12	8.13	34	200	196	Average
5148.95	53.04	44.79	74	-20.96	34.12	8.13	34	200	196	Peak
5190	88.17	79.83			34.15	8.19	34	200	196	Average
5190	95.81	87.47			34.15	8.19	34	200	196	Peak
5451.75	42.99	34.17	54	-11.01	34.36	8.51	34.05	200	196	Average
5451.75	53.22	44.4	74	-20.78	34.36	8.51	34.05	200	196	Peak
*10380	55.42	41.07	68.2	-12.78	37.13	12.36	35.14	142	113	Peak

Remarks:

- Emission Level = Read Level + Antenna Factor + Cable Loss - Preamp Factor
Margin value = Emission level – Limit value
- 5190 MHz: Fundamental Frequency
- *: Out of Restricted Band
- The emission levels of other frequencies were very low against the limit

EUT Test Condition		Measurement Detail	
Channel	Channel 46	Frequency Range	1 GHz ~ 40 GHz
Input Power	120 Vac, 60 Hz	Detector Function	Peak (PK) Average (AV)
Environmental Conditions	25 deg. C, 65 % RH	Tested By	Charles Hsiao

Antenna Polarity & Test Distance: Horizontal at 3 m										
Frequency (MHz)	Emission Level (dBuV/m)	Read Level (dBuV)	Limit (dBuV/m)	Margin (dB)	Antenna Factor (dB/m)	Cable Loss (dB)	Preamp Factor (dB)	Antenna Height (cm)	Table Angle (Degree)	Remark
5150	44.54	36.29	54	-9.46	34.12	8.13	34	128	207	Average
5150	53.81	45.56	74	-20.19	34.12	8.13	34	128	207	Peak
5230	93.32	84.92			34.19	8.22	34.01	128	207	Average
5230	100.2	91.8			34.19	8.22	34.01	128	207	Peak
5350.66	43.16	34.53	54	-10.84	34.28	8.38	34.03	128	207	Average
5350.66	53.83	45.2	74	-20.17	34.28	8.38	34.03	128	207	Peak
*10460	53.48	38.97	68.2	-14.72	37.17	12.53	35.19	122	190	Peak

Antenna Polarity & Test Distance: Vertical at 3 m										
Frequency (MHz)	Emission Level (dBuV/m)	Read Level (dBuV)	Limit (dBuV/m)	Margin (dB)	Antenna Factor (dB/m)	Cable Loss (dB)	Preamp Factor (dB)	Antenna Height (cm)	Table Angle (Degree)	Remark
5128.55	43.15	34.93	54	-10.85	34.11	8.1	33.99	200	196	Average
5128.55	53.33	45.11	74	-20.67	34.11	8.1	33.99	200	196	Peak
5230	91.47	83.07			34.19	8.22	34.01	200	196	Average
5230	98.32	89.92			34.19	8.22	34.01	200	196	Peak
5410.17	43.12	34.4	54	-10.88	34.32	8.44	34.04	200	196	Average
5410.17	53.59	44.87	74	-20.41	34.32	8.44	34.04	200	196	Peak
*10460	53.26	38.75	68.2	-14.94	37.17	12.53	35.19	118	246	Peak

Remarks:

- Emission Level = Read Level + Antenna Factor + Cable Loss - Preamp Factor
Margin value = Emission level – Limit value
- 5230 MHz: Fundamental Frequency
- *: Out of Restricted Band
- The emission levels of other frequencies were very low against the limit

EUT Test Condition		Measurement Detail	
Channel	Channel 54	Frequency Range	1 GHz ~ 40 GHz
Input Power	120 Vac, 60 Hz	Detector Function	Peak (PK) Average (AV)
Environmental Conditions	25 deg. C, 65 % RH	Tested By	Charles Hsiao

Antenna Polarity & Test Distance: Horizontal at 3 m										
Frequency (MHz)	Emission Level (dBuV/m)	Read Level (dBuV)	Limit (dBuV/m)	Margin (dB)	Antenna Factor (dB/m)	Cable Loss (dB)	Preamp Factor (dB)	Antenna Height (cm)	Table Angle (Degree)	Remark
5118.8	42.96	34.76	54	-11.04	34.09	8.1	33.99	100	209	Average
5118.8	53.74	45.54	74	-20.26	34.09	8.1	33.99	100	209	Peak
5270	94.77	86.28			34.21	8.29	34.01	100	209	Average
5270	101.49	93			34.21	8.29	34.01	100	209	Peak
5351.21	43.55	34.92	54	-10.45	34.28	8.38	34.03	100	209	Average
5351.21	54.28	45.65	74	-19.72	34.28	8.38	34.03	100	209	Peak
*10540	55.62	41	68.2	-12.58	37.23	12.63	35.24	199	200	Peak

Antenna Polarity & Test Distance: Vertical at 3 m										
Frequency (MHz)	Emission Level (dBuV/m)	Read Level (dBuV)	Limit (dBuV/m)	Margin (dB)	Antenna Factor (dB/m)	Cable Loss (dB)	Preamp Factor (dB)	Antenna Height (cm)	Table Angle (Degree)	Remark
5115.05	43.27	35.07	54	-10.73	34.09	8.1	33.99	190	196	Average
5115.05	53.29	45.09	74	-20.71	34.09	8.1	33.99	190	196	Peak
5270	93.17	84.68			34.21	8.29	34.01	190	196	Average
5270	100.8	92.31			34.21	8.29	34.01	190	196	Peak
5366.61	43.62	34.98	54	-10.38	34.29	8.38	34.03	190	196	Average
5366.61	53.71	45.07	74	-20.29	34.29	8.38	34.03	190	196	Peak
*10540	54.07	39.45	68.2	-14.13	37.23	12.63	35.24	125	22	Peak

Remarks:

- Emission Level = Read Level + Antenna Factor + Cable Loss - Preamp Factor
Margin value = Emission level – Limit value
- 5270 MHz: Fundamental Frequency
- *: Out of Restricted Band
- The emission levels of other frequencies were very low against the limit

EUT Test Condition		Measurement Detail	
Channel	Channel 62	Frequency Range	1 GHz ~ 40 GHz
Input Power	120 Vac, 60 Hz	Detector Function	Peak (PK) Average (AV)
Environmental Conditions	25 deg. C, 65 % RH	Tested By	Charles Hsiao

Antenna Polarity & Test Distance: Horizontal at 3 m										
Frequency (MHz)	Emission Level (dBuV/m)	Read Level (dBuV)	Limit (dBuV/m)	Margin (dB)	Antenna Factor (dB/m)	Cable Loss (dB)	Preamp Factor (dB)	Antenna Height (cm)	Table Angle (Degree)	Remark
5117	42.91	34.71	54	-11.09	34.09	8.1	33.99	116	188	Average
5117	53.49	45.29	74	-20.51	34.09	8.1	33.99	116	188	Peak
5310	91.33	82.78			34.25	8.32	34.02	116	188	Average
5310	98.08	89.53			34.25	8.32	34.02	116	188	Peak
5350.66	43.58	34.95	54	-10.42	34.28	8.38	34.03	116	188	Average
5350.66	53.89	45.26	74	-20.11	34.28	8.38	34.03	116	188	Peak
10620	47.03	32.32	54	-6.97	37.3	12.69	35.28	147	111	Average
10620	54.03	39.32	74	-19.97	37.3	12.69	35.28	147	111	Peak

Antenna Polarity & Test Distance: Vertical at 3 m										
Frequency (MHz)	Emission Level (dBuV/m)	Read Level (dBuV)	Limit (dBuV/m)	Margin (dB)	Antenna Factor (dB/m)	Cable Loss (dB)	Preamp Factor (dB)	Antenna Height (cm)	Table Angle (Degree)	Remark
5131.85	42.98	34.76	54	-11.02	34.11	8.1	33.99	190	196	Average
5131.85	53.22	45	74	-20.78	34.11	8.1	33.99	190	196	Peak
5310	90.28	81.73			34.25	8.32	34.02	190	196	Average
5310	97.44	88.89			34.25	8.32	34.02	190	196	Peak
5353.63	43.66	35.03	54	-10.34	34.28	8.38	34.03	190	196	Average
5353.63	53.65	45.02	74	-20.35	34.28	8.38	34.03	190	196	Peak
10620	47.22	32.51	54	-6.78	37.3	12.69	35.28	168	144	Average
10620	55.17	40.46	74	-18.83	37.3	12.69	35.28	168	144	Peak

Remarks:

- Emission Level = Read Level + Antenna Factor + Cable Loss - Preamp Factor
Margin value = Emission level – Limit value
- 5310 MHz: Fundamental Frequency
- The emission levels of other frequencies were very low against the limit

EUT Test Condition		Measurement Detail	
Channel	Channel 102	Frequency Range	1 GHz ~ 40 GHz
Input Power	120 Vac, 60 Hz	Detector Function	Peak (PK) Average (AV)
Environmental Conditions	25 deg. C, 65 % RH	Tested By	Charles Hsiao

Antenna Polarity & Test Distance: Horizontal at 3 m										
Frequency (MHz)	Emission Level (dBuV/m)	Read Level (dBuV)	Limit (dBuV/m)	Margin (dB)	Antenna Factor (dB/m)	Cable Loss (dB)	Preamp Factor (dB)	Antenna Height (cm)	Table Angle (Degree)	Remark
5449.68	43.57	34.74	54	-10.43	34.36	8.51	34.04	100	199	Average
5449.68	54.17	45.34	74	-19.83	34.36	8.51	34.04	100	199	Peak
*5470.64	53.48	44.65	68.2	-14.72	34.37	8.51	34.05	100	199	Peak
5510	86.91	78			34.4	8.57	34.06	100	199	Average
5510	93.88	84.97			34.4	8.57	34.06	100	199	Peak
*5725.8	53.44	44.28	68.2	-14.76	34.62	8.65	34.11	100	199	Peak
11020	45.94	30.87	54	-8.06	37.61	12.94	35.48	174	111	Average
11020	55.44	40.37	74	-18.56	37.61	12.94	35.48	174	111	Peak

Antenna Polarity & Test Distance: Vertical at 3 m										
Frequency (MHz)	Emission Level (dBuV/m)	Read Level (dBuV)	Limit (dBuV/m)	Margin (dB)	Antenna Factor (dB/m)	Cable Loss (dB)	Preamp Factor (dB)	Antenna Height (cm)	Table Angle (Degree)	Remark
5439.6	43.72	34.93	54	-10.28	34.35	8.48	34.04	155	213	Average
5439.6	53.8	45.01	74	-20.2	34.35	8.48	34.04	155	213	Peak
*5468.72	54.35	45.52	68.2	-13.85	34.37	8.51	34.05	155	213	Peak
5510	89.85	80.94			34.4	8.57	34.06	155	213	Average
5510	96.24	87.33			34.4	8.57	34.06	155	213	Peak
*5724.84	53.41	44.25	68.2	-14.79	34.62	8.65	34.11	155	213	Peak
11020	46.33	31.26	54	-7.67	37.61	12.94	35.48	162	209	Average
11020	55.82	40.75	74	-18.18	37.61	12.94	35.48	162	209	Peak

Remarks:

- Emission Level = Read Level + Antenna Factor + Cable Loss - Preamp Factor
Margin value = Emission level – Limit value
- 5510 MHz: Fundamental Frequency
- *: Out of Restricted Band
- The emission levels of other frequencies were very low against the limit

EUT Test Condition		Measurement Detail	
Channel	Channel 110	Frequency Range	1 GHz ~ 40 GHz
Input Power	120 Vac, 60 Hz	Detector Function	Peak (PK) Average (AV)
Environmental Conditions	25 deg. C, 65 % RH	Tested By	Charles Hsiao

Antenna Polarity & Test Distance: Horizontal at 3 m										
Frequency (MHz)	Emission Level (dBuV/m)	Read Level (dBuV)	Limit (dBuV/m)	Margin (dB)	Antenna Factor (dB/m)	Cable Loss (dB)	Preamp Factor (dB)	Antenna Height (cm)	Table Angle (Degree)	Remark
5448.72	43.4	34.57	54	-10.6	34.36	8.51	34.04	100	196	Average
5448.72	53.74	44.91	74	-20.26	34.36	8.51	34.04	100	196	Peak
*5470	53.01	44.18	68.2	-15.19	34.37	8.51	34.05	100	196	Peak
5550	91.03	82.06			34.45	8.59	34.07	100	196	Average
5550	98.14	89.17			34.45	8.59	34.07	100	196	Peak
*5725.24	53.04	43.88	68.2	-15.16	34.62	8.65	34.11	100	196	Peak
11100	45.24	30.15	54	-8.76	37.66	12.89	35.46	123	237	Average
11100	54.69	39.6	74	-19.31	37.66	12.89	35.46	123	237	Peak

Antenna Polarity & Test Distance: Vertical at 3 m										
Frequency (MHz)	Emission Level (dBuV/m)	Read Level (dBuV)	Limit (dBuV/m)	Margin (dB)	Antenna Factor (dB/m)	Cable Loss (dB)	Preamp Factor (dB)	Antenna Height (cm)	Table Angle (Degree)	Remark
5459.6	43.48	34.66	54	-10.52	34.36	8.51	34.05	238	213	Average
5459.6	53.97	45.15	74	-20.03	34.36	8.51	34.05	238	213	Peak
*5469.68	53.36	44.53	68.2	-14.84	34.37	8.51	34.05	238	213	Peak
5550	94.22	85.25			34.45	8.59	34.07	238	213	Average
5550	101.09	92.12			34.45	8.59	34.07	238	213	Peak
*5724.28	52.88	43.72	68.2	-15.32	34.62	8.65	34.11	238	213	Peak
11100	46.02	30.93	54	-7.98	37.66	12.89	35.46	147	19	Average
11100	55.52	40.43	74	-18.48	37.66	12.89	35.46	147	19	Peak

Remarks:

- Emission Level = Read Level + Antenna Factor + Cable Loss - Preamp Factor
Margin value = Emission level – Limit value
- 5550 MHz: Fundamental Frequency
- *: Out of Restricted Band
- The emission levels of other frequencies were very low against the limit

EUT Test Condition		Measurement Detail	
Channel	Channel 134	Frequency Range	1 GHz ~ 40 GHz
Input Power	120 Vac, 60 Hz	Detector Function	Peak (PK) Average (AV)
Environmental Conditions	25 deg. C, 65 % RH	Tested By	Charles Hsiao

Antenna Polarity & Test Distance: Horizontal at 3 m										
Frequency (MHz)	Emission Level (dBuV/m)	Read Level (dBuV)	Limit (dBuV/m)	Margin (dB)	Antenna Factor (dB/m)	Cable Loss (dB)	Preamp Factor (dB)	Antenna Height (cm)	Table Angle (Degree)	Remark
5441.36	43.33	34.54	54	-10.67	34.35	8.48	34.04	100	185	Average
5441.36	54.58	45.79	74	-19.42	34.35	8.48	34.04	100	185	Peak
*5469.68	51.76	42.93	68.2	-16.44	34.37	8.51	34.05	100	185	Peak
5670	92.18	83.08			34.57	8.63	34.1	100	185	Average
5670	99.47	90.37			34.57	8.63	34.1	100	185	Peak
*5724.04	54.53	45.37	68.2	-13.67	34.62	8.65	34.11	100	185	Peak
11340	45.99	30.9	54	-8.01	37.8	12.71	35.42	159	246	Average
11340	55.46	40.37	74	-18.54	37.8	12.71	35.42	159	246	Peak

Antenna Polarity & Test Distance: Vertical at 3 m										
Frequency (MHz)	Emission Level (dBuV/m)	Read Level (dBuV)	Limit (dBuV/m)	Margin (dB)	Antenna Factor (dB/m)	Cable Loss (dB)	Preamp Factor (dB)	Antenna Height (cm)	Table Angle (Degree)	Remark
5435.6	43.21	34.42	54	-10.79	34.35	8.48	34.04	237	215	Average
5435.6	53.21	44.42	74	-20.79	34.35	8.48	34.04	237	215	Peak
*5468.72	52.16	43.33	68.2	-16.04	34.37	8.51	34.05	237	215	Peak
5670	95.79	86.69			34.57	8.63	34.1	237	215	Average
5670	102.85	93.75			34.57	8.63	34.1	237	215	Peak
*5724.04	54.81	45.65	68.2	-13.39	34.62	8.65	34.11	237	215	Peak
11340	45.39	30.3	54	-8.61	37.8	12.71	35.42	148	161	Average
11340	54.94	39.85	74	-19.06	37.8	12.71	35.42	148	161	Peak

Remarks:

- Emission Level = Read Level + Antenna Factor + Cable Loss - Preamp Factor
Margin value = Emission level – Limit value
- 5670 MHz: Fundamental Frequency
- *: Out of Restricted Band
- The emission levels of other frequencies were very low against the limit

EUT Test Condition		Measurement Detail	
Channel	Channel 151	Frequency Range	1 GHz ~ 40 GHz
Input Power	120 Vac, 60 Hz	Detector Function	Peak (PK) Average (AV)
Environmental Conditions	25 deg. C, 65 % RH	Tested By	Charles Hsiao

<Spurious Emission>

Antenna Polarity & Test Distance: Horizontal at 3 m										
Frequency (MHz)	Emission Level (dBuV/m)	Read Level (dBuV)	Limit (dBuV/m)	Margin (dB)	Antenna Factor (dB/m)	Cable Loss (dB)	Preamp Factor (dB)	Antenna Height (cm)	Table Angle (Degree)	Remark
5755	85.14	75.93			34.66	8.66	34.11	100	169	Average
5755	92.61	83.4			34.66	8.66	34.11	100	169	Peak
11510	47.56	32.45	54	-6.44	37.9	12.6	35.39	118	5	Average
11510	55.91	40.8	74	-18.09	37.9	12.6	35.39	118	5	Peak
Antenna Polarity & Test Distance: Vertical at 3 m										
Frequency (MHz)	Emission Level (dBuV/m)	Read Level (dBuV)	Limit (dBuV/m)	Margin (dB)	Antenna Factor (dB/m)	Cable Loss (dB)	Preamp Factor (dB)	Antenna Height (cm)	Table Angle (Degree)	Remark
5755	90.55	81.34			34.66	8.66	34.11	200	186	Average
5755	97.95	88.74			34.66	8.66	34.11	200	186	Peak
11510	47.47	32.36	54	-6.53	37.9	12.6	35.39	126	326	Average
11510	56.16	41.05	74	-17.84	37.9	12.6	35.39	126	326	Peak

<Out of Band Emission (OOBE)>

Antenna Polarity & Test Distance: Horizontal at 3 m										
Frequency (MHz)	Emission Level (dBuV/m)	Read Level (dBuV)	Limit (dBuV/m)	Margin (dB)	Antenna Factor (dB/m)	Cable Loss (dB)	Preamp Factor (dB)	Antenna Height (cm)	Table Angle (Degree)	Remark
*5609.2	53.93	44.9	68.2	-14.27	34.5	8.61	34.08	100	169	Peak
5659.6	53.12	44.03	75.3	-22.18	34.56	8.63	34.1	100	169	Peak
5914.75	53.18	43.8	75.78	-22.6	34.81	8.73	34.16	100	169	Peak
*6002.95	54	44.51	68.2	-14.2	34.9	8.76	34.17	100	169	Peak
Antenna Polarity & Test Distance: Vertical at 3 m										
Frequency (MHz)	Emission Level (dBuV/m)	Read Level (dBuV)	Limit (dBuV/m)	Margin (dB)	Antenna Factor (dB/m)	Cable Loss (dB)	Preamp Factor (dB)	Antenna Height (cm)	Table Angle (Degree)	Remark
*5601.325	53.69	44.66	68.2	-14.51	34.5	8.61	34.08	200	186	Peak
5664.325	53.38	44.29	78.8	-25.42	34.56	8.63	34.1	200	186	Peak
5916.325	51.91	42.53	74.62	-22.71	34.81	8.73	34.16	200	186	Peak
*5926.825	54.99	45.59	68.2	-13.21	34.83	8.73	34.16	200	186	Peak

Remarks:

- Emission Level = Read Level + Antenna Factor + Cable Loss - Preamp Factor
Margin value = Emission level – Limit value
- 5755 MHz: Fundamental Frequency
- *: Out of Restricted Band
- The emission levels of other frequencies were very low against the limit

EUT Test Condition		Measurement Detail	
Channel	Channel 159	Frequency Range	1 GHz ~ 40 GHz
Input Power	120 Vac, 60 Hz	Detector Function	Peak (PK) Average (AV)
Environmental Conditions	25 deg. C, 65 % RH	Tested By	Charles Hsiao

<Spurious Emission>

Antenna Polarity & Test Distance: Horizontal at 3 m										
Frequency (MHz)	Emission Level (dBuV/m)	Read Level (dBuV)	Limit (dBuV/m)	Margin (dB)	Antenna Factor (dB/m)	Cable Loss (dB)	Preamp Factor (dB)	Antenna Height (cm)	Table Angle (Degree)	Remark
5795	88.73	79.49			34.69	8.68	34.13	100	169	Average
5795	95.55	86.31			34.69	8.68	34.13	100	169	Peak
11590	48.17	32.8	54	-5.83	38.02	12.72	35.37	105	206	Average
11590	56.17	40.8	74	-17.83	38.02	12.72	35.37	105	206	Peak
Antenna Polarity & Test Distance: Vertical at 3 m										
Frequency (MHz)	Emission Level (dBuV/m)	Read Level (dBuV)	Limit (dBuV/m)	Margin (dB)	Antenna Factor (dB/m)	Cable Loss (dB)	Preamp Factor (dB)	Antenna Height (cm)	Table Angle (Degree)	Remark
5795	93.34	84.1			34.69	8.68	34.13	200	186	Average
5795	100.29	91.05			34.69	8.68	34.13	200	186	Peak
11590	47.92	32.55	54	-6.08	38.02	12.72	35.37	134	322	Average
11590	56.12	40.75	74	-17.88	38.02	12.72	35.37	134	322	Peak

<Out of Band Emission (OOBE)>

Antenna Polarity & Test Distance: Horizontal at 3 m										
Frequency (MHz)	Emission Level (dBuV/m)	Read Level (dBuV)	Limit (dBuV/m)	Margin (dB)	Antenna Factor (dB/m)	Cable Loss (dB)	Preamp Factor (dB)	Antenna Height (cm)	Table Angle (Degree)	Remark
*5566.15	53.25	44.26	68.2	-14.95	34.47	8.59	34.07	100	169	Peak
5655.925	51.24	42.15	72.58	-21.34	34.56	8.63	34.1	100	169	Peak
5920.525	54.16	44.78	71.51	-17.35	34.81	8.73	34.16	100	169	Peak
*5997.175	54.12	44.63	68.2	-14.08	34.9	8.76	34.17	100	169	Peak
Antenna Polarity & Test Distance: Vertical at 3 m										
Frequency (MHz)	Emission Level (dBuV/m)	Read Level (dBuV)	Limit (dBuV/m)	Margin (dB)	Antenna Factor (dB/m)	Cable Loss (dB)	Preamp Factor (dB)	Antenna Height (cm)	Table Angle (Degree)	Remark
*5637.025	53.64	44.57	68.2	-14.56	34.54	8.62	34.09	200	186	Peak
5661.7	53.28	44.19	76.86	-23.58	34.56	8.63	34.1	200	186	Peak
5920.525	52.83	43.45	71.51	-18.68	34.81	8.73	34.16	200	186	Peak
*6010.825	53.93	44.43	68.2	-14.27	34.92	8.76	34.18	200	186	Peak

Remarks:

- Emission Level = Read Level + Antenna Factor + Cable Loss - Preamp Factor
Margin value = Emission level – Limit value
- 5795 MHz: Fundamental Frequency
- *: Out of Restricted Band
- The emission levels of other frequencies were very low against the limit

802.11ac (VHT80)

EUT Test Condition		Measurement Detail	
Channel	Channel 42	Frequency Range	1 GHz ~ 40 GHz
Input Power	120 Vac, 60 Hz	Detector Function	Peak (PK) Average (AV)
Environmental Conditions	25 deg. C, 65 % RH	Tested By	Charles Hsiao

Antenna Polarity & Test Distance: Horizontal at 3 m

Frequency (MHz)	Emission Level (dBuV/m)	Read Level (dBuV)	Limit (dBuV/m)	Margin (dB)	Antenna Factor (dB/m)	Cable Loss (dB)	Preamp Factor (dB)	Antenna Height (cm)	Table Angle (Degree)	Remark
5149.55	45.91	37.66	54	-8.09	34.12	8.13	34	128	207	Average
5149.55	55.95	47.7	74	-18.05	34.12	8.13	34	128	207	Peak
5210	87.43	79.07			34.17	8.19	34	128	207	Average
5210	94.67	86.31			34.17	8.19	34	128	207	Peak
5406.54	43.55	34.83	54	-10.45	34.32	8.44	34.04	128	207	Average
5406.54	53.03	44.31	74	-20.97	34.32	8.44	34.04	128	207	Peak
*10420	53.11	38.7	68.2	-15.09	37.15	12.42	35.16	107	5	Peak

Antenna Polarity & Test Distance: Vertical at 3 m

Frequency (MHz)	Emission Level (dBuV/m)	Read Level (dBuV)	Limit (dBuV/m)	Margin (dB)	Antenna Factor (dB/m)	Cable Loss (dB)	Preamp Factor (dB)	Antenna Height (cm)	Table Angle (Degree)	Remark
5150	45.13	36.88	54	-8.87	34.12	8.13	34	200	196	Average
5150	54.06	45.81	74	-19.94	34.12	8.13	34	200	196	Peak
5210	85.55	77.19			34.17	8.19	34	200	196	Average
5210	92.89	84.53			34.17	8.19	34	200	196	Peak
5441.3	43.56	34.77	54	-10.44	34.35	8.48	34.04	200	196	Average
5441.3	53.3	44.51	74	-20.7	34.35	8.48	34.04	200	196	Peak
*10420	53.24	38.83	68.2	-14.96	37.15	12.42	35.16	115	24	Peak

Remarks:

- Emission Level = Read Level + Antenna Factor + Cable Loss - Preamp Factor
Margin value = Emission level – Limit value
- 5210 MHz: Fundamental Frequency
- *: Out of Restricted Band
- The emission levels of other frequencies were very low against the limit

EUT Test Condition		Measurement Detail	
Channel	Channel 58	Frequency Range	1 GHz ~ 40 GHz
Input Power	120 Vac, 60 Hz	Detector Function	Peak (PK) Average (AV)
Environmental Conditions	25 deg. C, 65 % RH	Tested By	Charles Hsiao

Antenna Polarity & Test Distance: Horizontal at 3 m										
Frequency (MHz)	Emission Level (dBuV/m)	Read Level (dBuV)	Limit (dBuV/m)	Margin (dB)	Antenna Factor (dB/m)	Cable Loss (dB)	Preamp Factor (dB)	Antenna Height (cm)	Table Angle (Degree)	Remark
5128.1	43.14	34.92	54	-10.86	34.11	8.1	33.99	116	188	Average
5128.1	53.32	45.1	74	-20.68	34.11	8.1	33.99	116	188	Peak
5290	91.77	83.24			34.23	8.32	34.02	116	188	Average
5290	98.22	89.69			34.23	8.32	34.02	116	188	Peak
5350.66	46.08	37.45	54	-7.92	34.28	8.38	34.03	116	188	Average
5350.66	57.89	49.26	74	-16.11	34.28	8.38	34.03	116	188	Peak
*10580	54.42	39.77	68.2	-13.78	37.27	12.65	35.27	157	197	Peak

Antenna Polarity & Test Distance: Vertical at 3 m										
Frequency (MHz)	Emission Level (dBuV/m)	Read Level (dBuV)	Limit (dBuV/m)	Margin (dB)	Antenna Factor (dB/m)	Cable Loss (dB)	Preamp Factor (dB)	Antenna Height (cm)	Table Angle (Degree)	Remark
5115.65	43.12	34.92	54	-10.88	34.09	8.1	33.99	190	196	Average
5115.65	53.61	45.41	74	-20.39	34.09	8.1	33.99	190	196	Peak
5290	90.53	82			34.23	8.32	34.02	190	196	Average
5290	97.86	89.33			34.23	8.32	34.02	190	196	Peak
5350.44	46.33	37.7	54	-7.67	34.28	8.38	34.03	190	196	Average
5350.44	57.87	49.24	74	-16.13	34.28	8.38	34.03	190	196	Peak
*10580	54	39.35	68.2	-14.2	37.27	12.65	35.27	125	299	Peak

Remarks:

- Emission Level = Read Level + Antenna Factor + Cable Loss - Preamp Factor
Margin value = Emission level – Limit value
- 5290 MHz: Fundamental Frequency
- *: Out of Restricted Band
- The emission levels of other frequencies were very low against the limit

EUT Test Condition		Measurement Detail	
Channel	Channel 106	Frequency Range	1 GHz ~ 40 GHz
Input Power	120 Vac, 60 Hz	Detector Function	Peak (PK) Average (AV)
Environmental Conditions	25 deg. C, 65 % RH	Tested By	Charles Hsiao

Antenna Polarity & Test Distance: Horizontal at 3 m										
Frequency (MHz)	Emission Level (dBuV/m)	Read Level (dBuV)	Limit (dBuV/m)	Margin (dB)	Antenna Factor (dB/m)	Cable Loss (dB)	Preamp Factor (dB)	Antenna Height (cm)	Table Angle (Degree)	Remark
5458.16	46.25	37.43	54	-7.75	34.36	8.51	34.05	100	199	Average
5458.16	55.42	46.6	74	-18.58	34.36	8.51	34.05	100	199	Peak
*5469.52	56.42	47.59	68.2	-11.78	34.37	8.51	34.05	100	199	Peak
5530	87.4	78.47			34.42	8.58	34.07	100	199	Average
5530	94.64	85.71			34.42	8.58	34.07	100	199	Peak
*5724.52	52.4	43.24	68.2	-15.8	34.62	8.65	34.11	100	199	Peak
10600	45.58	30.9	54	-8.42	37.28	12.67	35.27	168	107	Average
10600	55.15	40.47	74	-18.85	37.28	12.67	35.27	168	107	Peak

Antenna Polarity & Test Distance: Vertical at 3 m										
Frequency (MHz)	Emission Level (dBuV/m)	Read Level (dBuV)	Limit (dBuV/m)	Margin (dB)	Antenna Factor (dB/m)	Cable Loss (dB)	Preamp Factor (dB)	Antenna Height (cm)	Table Angle (Degree)	Remark
5459.44	47.64	38.82	54	-6.36	34.36	8.51	34.05	173	214	Average
5459.44	57.81	48.99	74	-16.19	34.36	8.51	34.05	173	214	Peak
*5468.08	57.3	48.47	68.2	-10.9	34.37	8.51	34.05	173	214	Peak
5530	90.92	81.99			34.42	8.58	34.07	173	214	Average
5530	97.94	89.01			34.42	8.58	34.07	173	214	Peak
*5725.64	52.65	43.49	68.2	-15.55	34.62	8.65	34.11	173	214	Peak
10600	45.66	30.98	54	-8.34	37.28	12.67	35.27	151	82	Average
10600	55.11	40.43	74	-18.89	37.28	12.67	35.27	151	82	Peak

Remarks:

- Emission Level = Read Level + Antenna Factor + Cable Loss - Preamp Factor
Margin value = Emission level – Limit value
- 5530 MHz: Fundamental Frequency
- *: Out of Restricted Band
- The emission levels of other frequencies were very low against the limit

EUT Test Condition		Measurement Detail	
Channel	Channel 122	Frequency Range	1 GHz ~ 40 GHz
Input Power	120 Vac, 60 Hz	Detector Function	Peak (PK) Average (AV)
Environmental Conditions	25 deg. C, 65 % RH	Tested By	Charles Hsiao

Antenna Polarity & Test Distance: Horizontal at 3 m										
Frequency (MHz)	Emission Level (dBuV/m)	Read Level (dBuV)	Limit (dBuV/m)	Margin (dB)	Antenna Factor (dB/m)	Cable Loss (dB)	Preamp Factor (dB)	Antenna Height (cm)	Table Angle (Degree)	Remark
5435.44	43.68	34.89	54	-10.32	34.35	8.48	34.04	100	196	Average
5435.44	54.36	45.57	74	-19.64	34.35	8.48	34.04	100	196	Peak
*5469.68	52.93	44.1	68.2	-15.27	34.37	8.51	34.05	100	196	Peak
5610	88.11	79.08			34.5	8.61	34.08	100	196	Average
5610	96.08	87.05			34.5	8.61	34.08	100	196	Peak
*5725.56	53.05	43.89	68.2	-15.15	34.62	8.65	34.11	100	196	Peak
11220	46.18	31.09	54	-7.82	37.73	12.8	35.44	135	190	Average
11220	55.63	40.54	74	-18.37	37.73	12.8	35.44	135	190	Peak

Antenna Polarity & Test Distance: Vertical at 3 m										
Frequency (MHz)	Emission Level (dBuV/m)	Read Level (dBuV)	Limit (dBuV/m)	Margin (dB)	Antenna Factor (dB/m)	Cable Loss (dB)	Preamp Factor (dB)	Antenna Height (cm)	Table Angle (Degree)	Remark
5457.2	43.6	34.78	54	-10.4	34.36	8.51	34.05	228	213	Average
5457.2	53.37	44.55	74	-20.63	34.36	8.51	34.05	228	213	Peak
*5470.48	52.38	43.55	68.2	-15.82	34.37	8.51	34.05	228	213	Peak
5610	91.31	82.28			34.5	8.61	34.08	228	213	Average
5610	99.18	90.15			34.5	8.61	34.08	228	213	Peak
*5725.48	53.86	44.7	68.2	-14.34	34.62	8.65	34.11	228	213	Peak
11220	47.24	32.15	54	-6.76	37.73	12.8	35.44	143	189	Average
11220	56.85	41.76	74	-17.15	37.73	12.8	35.44	143	189	Peak

Remarks:

- Emission Level = Read Level + Antenna Factor + Cable Loss - Preamp Factor
Margin value = Emission level – Limit value
- 5610 MHz: Fundamental Frequency
- *: Out of Restricted Band
- The emission levels of other frequencies were very low against the limit

EUT Test Condition		Measurement Detail	
Channel	Channel 155	Frequency Range	1 GHz ~ 40 GHz
Input Power	120 Vac, 60 Hz	Detector Function	Peak (PK) Average (AV)
Environmental Conditions	25 deg. C, 65 % RH	Tested By	Charles Hsiao

<Spurious Emission>

Antenna Polarity & Test Distance: Horizontal at 3 m										
Frequency (MHz)	Emission Level (dBuV/m)	Read Level (dBuV)	Limit (dBuV/m)	Margin (dB)	Antenna Factor (dB/m)	Cable Loss (dB)	Preamp Factor (dB)	Antenna Height (cm)	Table Angle (Degree)	Remark
5775	82.05	72.82			34.68	8.67	34.12	100	169	Average
5775	89.02	79.79			34.68	8.67	34.12	100	169	Peak
11550	48.26	32.99	54	-5.74	37.97	12.68	35.38	187	8	Average
11550	55.86	40.59	74	-18.14	37.97	12.68	35.38	187	8	Peak
Antenna Polarity & Test Distance: Vertical at 3 m										
Frequency (MHz)	Emission Level (dBuV/m)	Read Level (dBuV)	Limit (dBuV/m)	Margin (dB)	Antenna Factor (dB/m)	Cable Loss (dB)	Preamp Factor (dB)	Antenna Height (cm)	Table Angle (Degree)	Remark
5775	87.77	78.54			34.68	8.67	34.12	200	186	Average
5775	94.78	85.55			34.68	8.67	34.12	200	186	Peak
11550	47.92	32.65	54	-6.08	37.97	12.68	35.38	137	55	Average
11550	55.59	40.32	74	-18.41	37.97	12.68	35.38	137	55	Peak

<Out of Band Emission (OOBE)>

Antenna Polarity & Test Distance: Horizontal at 3 m										
Frequency (MHz)	Emission Level (dBuV/m)	Read Level (dBuV)	Limit (dBuV/m)	Margin (dB)	Antenna Factor (dB/m)	Cable Loss (dB)	Preamp Factor (dB)	Antenna Height (cm)	Table Angle (Degree)	Remark
*5626	53.89	44.84	68.2	-14.31	34.52	8.61	34.08	100	169	Peak
5654.35	51.39	42.3	71.42	-20.03	34.56	8.63	34.1	100	169	Peak
5921.575	51.65	42.25	70.73	-19.08	34.83	8.73	34.16	100	169	Peak
*5992.45	54.27	44.78	68.2	-13.93	34.9	8.76	34.17	100	169	Peak
Antenna Polarity & Test Distance: Vertical at 3 m										
Frequency (MHz)	Emission Level (dBuV/m)	Read Level (dBuV)	Limit (dBuV/m)	Margin (dB)	Antenna Factor (dB/m)	Cable Loss (dB)	Preamp Factor (dB)	Antenna Height (cm)	Table Angle (Degree)	Remark
*5527.825	53.78	44.85	68.2	-14.42	34.42	8.58	34.07	200	186	Peak
5658.55	53.5	44.41	74.53	-21.03	34.56	8.63	34.1	200	186	Peak
5921.575	52.83	43.43	70.73	-17.9	34.83	8.73	34.16	200	186	Peak
*6001.9	54.23	44.74	68.2	-13.97	34.9	8.76	34.17	200	186	Peak

Remarks:

- Emission Level = Read Level + Antenna Factor + Cable Loss - Preamp Factor
Margin value = Emission level – Limit value
- 5775 MHz: Fundamental Frequency
- *: Out of Restricted Band
- The emission levels of other frequencies were very low against the limit

9 kHz ~ 30 MHz Data:

The amplitude of spurious emissions attenuated more than 20 dB below the permissible value is not required to be report.

30 MHz ~ 1 GHz Worst-Case Data:

802.11ac (VHT80)

EUT Test Condition		Measurement Detail	
Channel	Channel 155	Frequency Range	30 MHz ~ 1 GHz
Input Power	120 Vac, 60 Hz	Detector Function	Peak (PK) Quasi-peak (QP)
Environmental Conditions	25 deg. C, 65 % RH	Tested By	Charles Hsiao

Horizontal

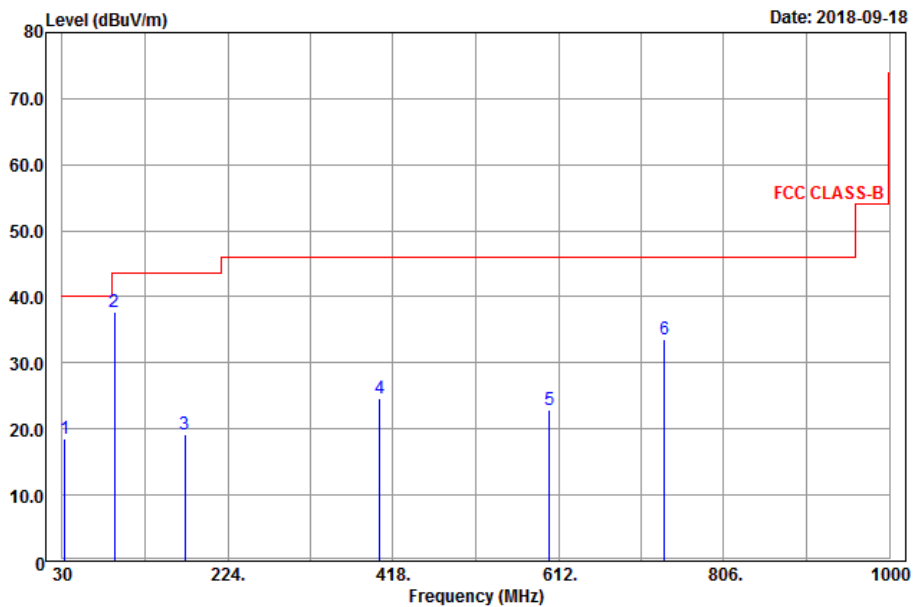

Vertical

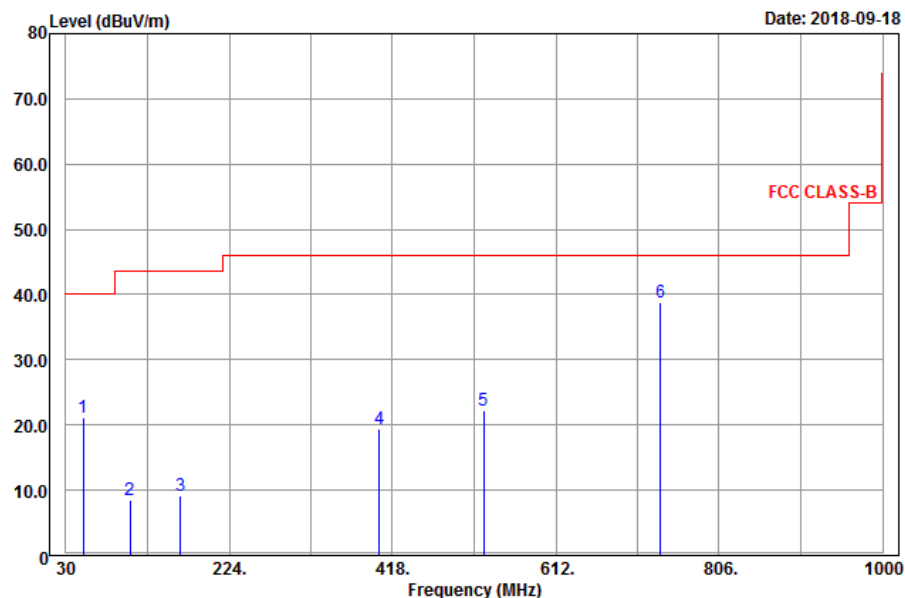

Antenna Polarity & Test Distance: Horizontal at 3 m

Frequency (MHz)	Emission Level (dBuV/m)	Read Level (dBuV)	Limit (dBuV/m)	Margin (dB)	Antenna Factor (dB/m)	Cable Loss (dB)	Preamp Factor (dB)	Antenna Height (cm)	Table Angle (Degree)	Remark
33.24	18.55	34.59	40	-21.45	15.47	0.74	32.25	169	158	Peak
91.56	37.67	59.31	43.5	-5.83	9.02	1.11	31.77	103	265	Peak
173.91	19.11	39.59	43.5	-24.39	10.15	1.61	32.24	115	188	Peak
402.2	24.55	36.37	46	-21.45	18.06	2.34	32.22	123	162	Peak
601.7	22.97	31.19	46	-23.03	21.1	2.87	32.19	147	184	Peak
736.8	33.48	39.15	46	-12.52	23.3	3.16	32.13	104	155	Peak

Antenna Polarity & Test Distance: Vertical at 3 m

Frequency (MHz)	Emission Level (dBuV/m)	Read Level (dBuV)	Limit (dBuV/m)	Margin (dB)	Antenna Factor (dB/m)	Cable Loss (dB)	Preamp Factor (dB)	Antenna Height (cm)	Table Angle (Degree)	Remark
50.25	21.09	44.64	40	-18.91	7.77	0.9	32.22	121	154	Peak
106.41	8.44	29.9	43.5	-35.06	9.51	1.28	32.25	188	195	Peak
166.62	9.11	29.55	43.5	-34.39	10.29	1.52	32.25	114	175	Peak
402.2	19.33	31.15	46	-26.67	18.06	2.34	32.22	133	162	Peak
526.8	22.14	30.93	46	-23.86	20.66	2.7	32.15	159	165	Peak
736.8	38.88	44.55	46	-7.12	23.3	3.16	32.13	125	185	Peak

Remarks:

- Emission Level = Read Level + Antenna Factor + Cable Loss - Preamp Factor
Margin value = Emission level – Limit value
- The emission levels of other frequencies were very low against the limit

4.2 Conducted Emission Measurement

4.2.1 Limits of Conducted Emission Measurement

Frequency (MHz)	Conducted Limit (dBUV)	
	Quasi-Peak	Average
0.15 - 0.5	66 - 56	56 - 46
0.50 - 5.0	56	46
5.0 - 30.0	60	50

- Note: 1. The lower limit shall apply at the transition frequencies.
 2. The limit decreases in line with the logarithm of the frequency in the range of 0.15 to 0.50 MHz.

4.2.2 Test Instruments

Description & Manufacturer	Model No.	Serial No.	Date of Calibration	Due Date of Calibration
Test Receiver ROHDE & SCHWARZ	ESCI	100613	Nov. 23, 2017	Nov. 22, 2018
RF signal cable Woken	5D-FB	Cable-cond1-01	Sep. 05, 2018	Sep. 04, 2019
LISN/AMN ROHDE & SCHWARZ (EUT)	ENV216	101826	Feb. 26, 2018	Feb. 25, 2019
LISN/AMN ROHDE & SCHWARZ (Peripheral)	ESH3-Z5	100311	Aug. 19, 2018	Aug. 18, 2019
Software ADT	BV ADT_Cond_ V7.3.7.4	NA	NA	NA

- Note: 1. The calibration interval of the above test instruments is 12 months and the calibrations are traceable to NML/ROC and NIST/USA.
 2. The test was performed in HwaYa Shielded Room 1.
 3. The VCCI Site Registration No. is C-2040.

4.2.3 Test Procedures

- a. The EUT was placed 0.4 meters from the conducting wall of the shielded room with EUT being connected to the power mains through a line impedance stabilization network (LISN). Other support units were connected to the power mains through another LISN. The two LISNs provide 50 ohm/ 50uH of coupling impedance for the measuring instrument.
- b. Both lines of the power mains connected to the EUT were checked for maximum conducted interference.
- c. The frequency range from 150 kHz to 30 MHz was searched. Emission levels under (Limit -20 dB) was not recorded.

Note: All modes of operation were investigated and the worst-case emissions are reported.

4.2.4 Deviation from Test Standard

No deviation.

4.2.5 Test Setup

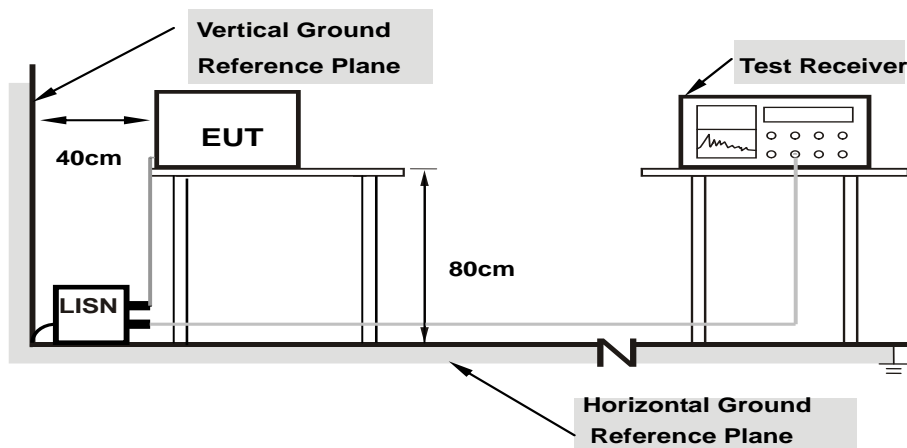

- Note:**
1. Support units were connected to second LISN.
 2. Both of LISNs (AMN) are 80 cm from EUT and at least 80 from other units and other metal planes

For the actual test configuration, please refer to the attached file (Test Setup Photo).

4.2.6 EUT Operating Conditions

- a. Placed the EUT on a testing table.
- b. Use the software to control the EUT under transmission condition continuously at specific channel frequency.

4.2.7 Test Results

Frequency Range	150kHz ~ 30MHz	Detector Function & Resolution Bandwidth	Quasi-Peak (QP) / Average (AV), 9kHz
Input Power	120Vac, 60Hz	Environmental Conditions	25°C, 65%RH
Tested by	Jisyong Wang	Test Date	2018/9/13

Phase Of Power : Line (L)										
No	Frequency (MHz)	Correction Factor (dB)	Reading Value (dBuV)		Emission Level (dBuV)		Limit (dBuV)		Margin (dB)	
			Q.P.	AV.	Q.P.	AV.	Q.P.	AV.	Q.P.	AV.
1	0.15000	9.67	34.96	20.51	44.63	30.18	66.00	56.00	-21.37	-25.82
2	0.17346	9.67	31.51	15.86	41.18	25.53	64.79	54.79	-23.61	-29.26
3	0.23211	9.67	29.44	17.67	39.11	27.34	62.37	52.37	-23.26	-25.03
4	0.61868	9.66	31.33	15.12	40.99	24.78	56.00	46.00	-15.01	-21.22
5	14.60527	9.88	31.34	15.32	41.22	25.20	60.00	50.00	-18.78	-24.80
6	18.39797	9.90	25.23	9.05	35.13	18.95	60.00	50.00	-24.87	-31.05

Remarks:

1. Q.P. and AV. are abbreviations of quasi-peak and average individually.
2. The emission levels of other frequencies were very low against the limit.
3. Margin value = Emission level – Limit value
4. Correction factor = Insertion loss + Cable loss
5. Emission Level = Correction Factor + Reading Value

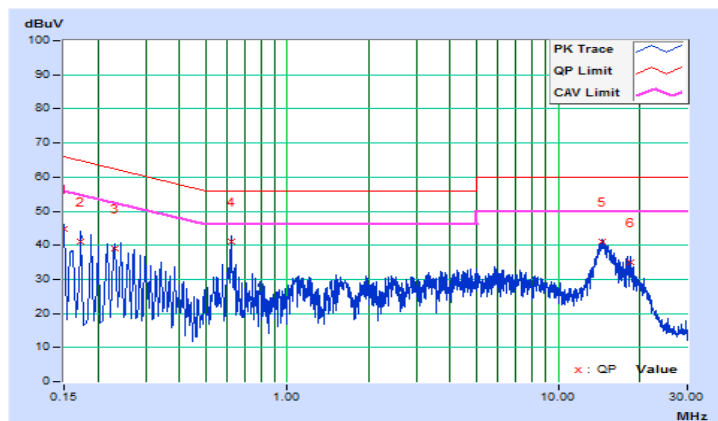

Frequency Range	150kHz ~ 30MHz	Detector Function & Resolution Bandwidth	Quasi-Peak (QP) / Average (AV), 9kHz
Input Power	120Vac, 60Hz	Environmental Conditions	25°C, 65%RH
Tested by	Jisyong Wang	Test Date	2018/9/13

Phase Of Power : Neutral (N)										
No	Frequency (MHz)	Correction Factor (dB)	Reading Value (dBuV)		Emission Level (dBuV)		Limit (dBuV)		Margin (dB)	
			Q.P.	AV.	Q.P.	AV.	Q.P.	AV.	Q.P.	AV.
1	0.16139	9.68	19.38	1.35	29.06	11.03	65.39	55.39	-36.33	-44.36
2	0.18910	9.67	19.24	1.10	28.91	10.77	64.08	54.08	-35.17	-43.31
3	0.21647	9.67	17.66	0.26	27.33	9.93	62.95	52.95	-35.62	-43.02
4	0.25948	9.67	20.58	3.44	30.25	13.11	61.45	51.45	-31.20	-38.34
5	0.61138	9.66	20.27	2.55	29.93	12.21	56.00	46.00	-26.07	-33.79
6	14.51143	9.93	16.89	2.82	26.82	12.75	60.00	50.00	-33.18	-37.25

Remarks:

1. Q.P. and AV. are abbreviations of quasi-peak and average individually.
2. The emission levels of other frequencies were very low against the limit.
3. Margin value = Emission level – Limit value
4. Correction factor = Insertion loss + Cable loss
5. Emission Level = Correction Factor + Reading Value

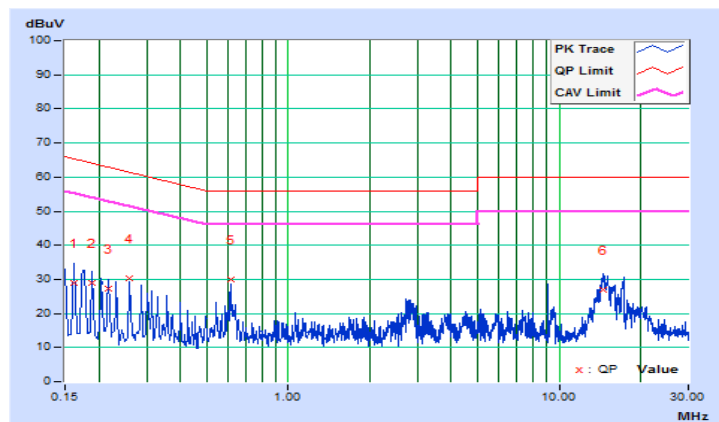

4.3 Transmit Power Measurement

4.3.1 Limits of Transmit Power Measurement

Operation Band	EUT Category		Limit
U-NII-1		Outdoor Access Point	1 Watt (30 dBm) (Max. e.i.r.p \leq 125 mW (21 dBm) at any elevation angle above 30 degrees as measured from the horizon)
		Fixed point-to-point Access Point	1 Watt (30 dBm)
		Indoor Access Point	1 Watt (30 dBm)
	√	Mobile and Portable client device	250 mW (24 dBm)
U-NII-2A		√	250 mW (24 dBm) or 11 dBm + 10 log B*
U-NII-2C		√	250 mW (24 dBm) or 11 dBm + 10 log B*
U-NII-3		√	1 Watt (30 dBm)

*B is the 26 dB emission bandwidth in megahertz

4.3.2 Test Setup

<Power Output Measurement>

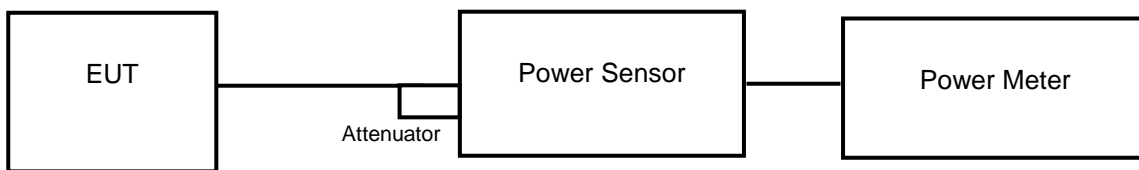

or

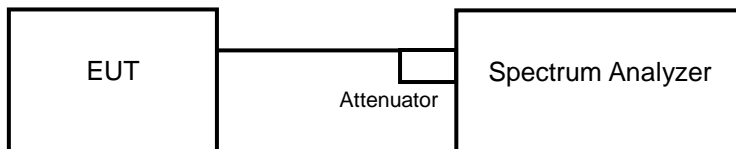

<26 dB Bandwidth>

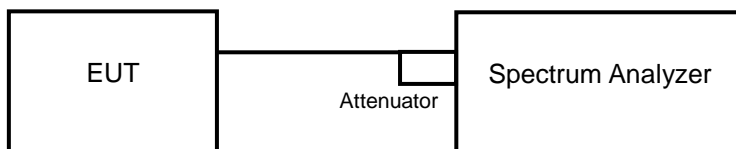

4.3.3 Test Instruments

Refer to section 4.1.2 to get information of above instrument.

4.3.4 Test Procedure

Average Power Measurement

<802.11a, 802.11n (HT20), 802.11n (HT40)>

Method PM is used to perform output power measurement, trigger and gating function of wide band power meter is enabled to measure max output power of TX on burst. Duty factor is not added to measured value.

<802.11ac (VHT80)>

- a. Set span to encompass the entire 26 dB EBW (or, alternatively, the entire 99 % occupied bandwidth) of the signal.
- b. Set sweep trigger to "free run".
- c. Set RBW = 1 MHz.
- d. Set VBW \geq 3 MHz
- e. Number of points in sweep \geq 2 Span / RBW.
- f. Sweep time \leq (number of points in sweep) * T
- g. Using emission bandwidth to determine the frequency span for integration the channel bandwidth.
- h. Detector = RMS.
- i. Trace mode = max hold.
- j. Allow max hold to run for at least 60 seconds, or longer as needed to allow the trace to stabilize.

26 dB Bandwidth

- a. Set RBW = approximately 1 % of the emission bandwidth.
- b. Set the VBW > RBW.
- c. Detector = Peak.
- d. Trace mode = max hold.
- e. Measure the maximum width of the emission that is 26 dB down from the peak of the emission. Compare this with the RBW setting of the analyzer. Readjust RBW and repeat measurement as needed until the RBW/EBW ratio is approximately 1 %.

4.3.5 Deviation from Test Standard

No deviation.

4.3.6 EUT Operating Conditions

The software provided by client to enable the EUT under transmission condition continuously at lowest, middle and highest channel frequencies individually.

4.3.7 Test Results

Power Output:

802.11a

Channel	Frequency (MHz)	Maximum Conducted Power (mW)	Maximum Conducted Power (dBm)	Power Limit (dBm)	Pass / Fail
36	5180	50.816	17.06	24	Pass
40	5200	54.576	17.37	24	Pass
48	5240	58.479	17.67	24	Pass
52	5260	61.094	17.86	24	Pass
60	5300	60.674	17.83	24	Pass
64	5320	54.450	17.36	24	Pass
100	5500	33.497	15.25	24	Pass
116	5580	54.828	17.39	24	Pass
140	5700	29.648	14.72	24	Pass
149	5745	19.770	12.96	30	Pass
157	5785	55.847	17.47	30	Pass
165	5825	52.845	17.23	30	Pass

Note:

For U-NII-2A, U-NII-2C Band:

1. $11 \text{ dBm} + 10\log(23.46) = 24.70 \text{ dBm} > 24 \text{ dBm}$.
2. $11 \text{ dBm} + 10\log(22.61) = 24.54 \text{ dBm} > 24 \text{ dBm}$.
3. $11 \text{ dBm} + 10\log(23.23) = 24.66 \text{ dBm} > 24 \text{ dBm}$.
4. $11 \text{ dBm} + 10\log(22.88) = 24.59 \text{ dBm} > 24 \text{ dBm}$.
5. $11 \text{ dBm} + 10\log(23.01) = 24.62 \text{ dBm} > 24 \text{ dBm}$.
6. $11 \text{ dBm} + 10\log(23.20) = 24.65 \text{ dBm} > 24 \text{ dBm}$.

802.11n (HT20)

Channel	Frequency (MHz)	Maximum Conducted Power (mW)	Maximum Conducted Power (dBm)	Power Limit (dBm)	Pass / Fail
36	5180	46.238	16.65	24	Pass
40	5200	51.286	17.10	24	Pass
48	5240	55.463	17.44	24	Pass
52	5260	54.450	17.36	24	Pass
60	5300	53.456	17.28	24	Pass
64	5320	47.643	16.78	24	Pass
100	5500	29.242	14.66	24	Pass
116	5580	52.602	17.21	24	Pass
140	5700	27.542	14.40	24	Pass
149	5745	17.579	12.45	30	Pass
157	5785	53.333	17.27	30	Pass
165	5825	46.559	16.68	30	Pass

Note:

For U-NII-2A, U-NII-2C Band:

1. $11 \text{ dBm} + 10\log(24.18) = 24.83 \text{ dBm} > 24 \text{ dBm}$.
2. $11 \text{ dBm} + 10\log(23.47) = 24.71 \text{ dBm} > 24 \text{ dBm}$.
3. $11 \text{ dBm} + 10\log(23.44) = 24.70 \text{ dBm} > 24 \text{ dBm}$.
4. $11 \text{ dBm} + 10\log(23.89) = 24.78 \text{ dBm} > 24 \text{ dBm}$.
5. $11 \text{ dBm} + 10\log(24.08) = 24.82 \text{ dBm} > 24 \text{ dBm}$.
6. $11 \text{ dBm} + 10\log(23.52) = 24.71 \text{ dBm} > 24 \text{ dBm}$.

802.11n (HT40)

Channel	Frequency (MHz)	Maximum Conducted Power (mW)	Maximum Conducted Power (dBm)	Power Limit (dBm)	Pass / Fail
38	5190	17.498	12.43	24	Pass
46	5230	30.761	14.88	24	Pass
54	5270	29.785	14.74	24	Pass
62	5310	19.187	12.83	24	Pass
102	5510	13.305	11.24	24	Pass
110	5550	32.810	15.16	24	Pass
134	5670	31.769	15.02	24	Pass
151	5755	17.179	12.35	30	Pass
159	5795	32.211	15.08	30	Pass

Note:

For U-NII-2A, U-NII-2C Band:

1. $11 \text{ dBm} + 10\log(42.32) = 27.26 \text{ dBm} > 24 \text{ dBm}$.
2. $11 \text{ dBm} + 10\log(42.56) = 27.29 \text{ dBm} > 24 \text{ dBm}$.
3. $11 \text{ dBm} + 10\log(42.25) = 27.26 \text{ dBm} > 24 \text{ dBm}$.
4. $11 \text{ dBm} + 10\log(42.68) = 27.30 \text{ dBm} > 24 \text{ dBm}$.
5. $11 \text{ dBm} + 10\log(42.33) = 27.27 \text{ dBm} > 24 \text{ dBm}$.

802.11ac (VHT80)

Channel	Frequency (MHz)	Maximum Conducted Power (mW)	Maximum Conducted Power (dBm)	Power Limit (dBm)	Pass / Fail
42	5210	23.768	13.76	24	Pass
58	5290	32.285	15.09	24	Pass
106	5530	31.915	15.04	24	Pass
122	5610	30.620	14.86	24	Pass
155	5775	24.604	13.91	30	Pass

Note:

For U-NII-2A, U-NII-2C Band:

1. $11 \text{ dBm} + 10\log(84.76) = 30.28 \text{ dBm} > 24 \text{ dBm}$.
2. $11 \text{ dBm} + 10\log(85.02) = 30.30 \text{ dBm} > 24 \text{ dBm}$.
3. $11 \text{ dBm} + 10\log(84.48) = 30.27 \text{ dBm} > 24 \text{ dBm}$.

26 dB Bandwidth:
802.11a

Channel	Frequency (MHz)	26 dBc Bandwidth (MHz)
36	5180	22.84
40	5200	22.55
48	5240	23.26
52	5260	23.46
60	5300	22.61
64	5320	23.23
100	5500	22.88
116	5580	23.01
140	5700	23.20

802.11n (HT20)

Channel	Frequency (MHz)	26 dBc Bandwidth (MHz)
36	5180	23.93
40	5200	22.97
48	5240	23.96
52	5260	24.18
60	5300	23.47
64	5320	23.44
100	5500	23.89
116	5580	24.08
140	5700	23.52

802.11n (HT40)

Channel	Frequency (MHz)	26 dBc Bandwidth (MHz)
38	5190	42.21
46	5230	42.61
54	5270	42.32
62	5310	42.56
102	5510	42.25
110	5550	42.68
134	5670	42.33

802.11ac (VHT80)

Channel	Frequency (MHz)	26 dBc Bandwidth (MHz)
42	5210	84.25
58	5290	84.76
106	5530	85.02
122	5610	84.48

Spectrum Plot of Worst Value

802.11a

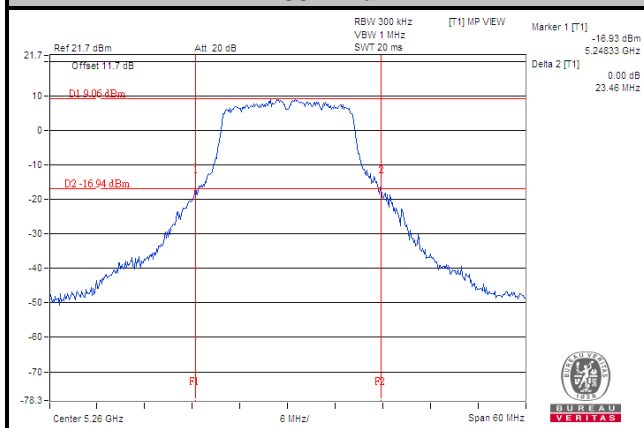

802.11n (HT20)

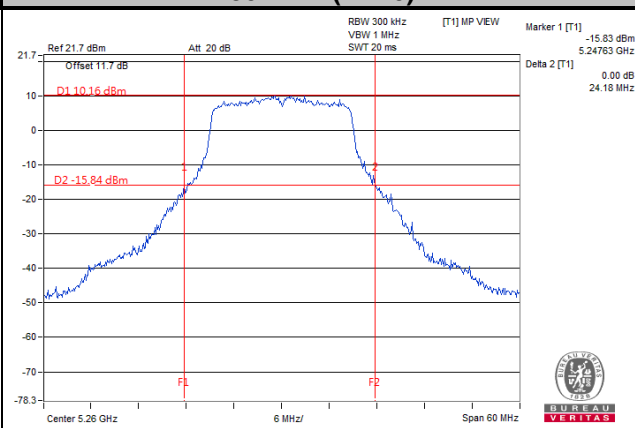

802.11n (HT40)

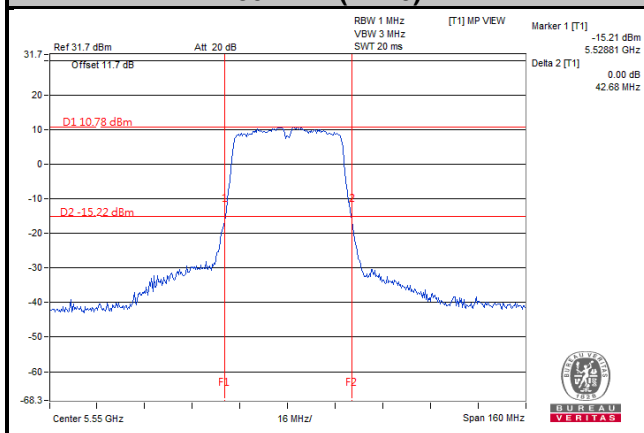

802.11ac (VHT80)

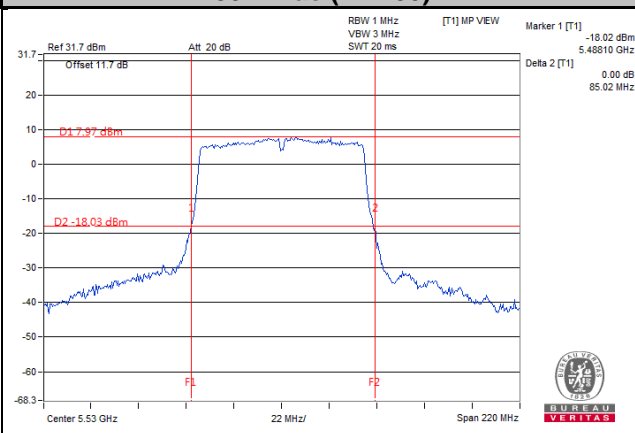

4.4 Occupied Bandwidth Measurement

4.4.1 Test Setup

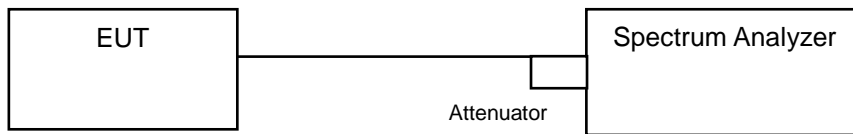

4.4.2 Test Instruments

Refer to section 4.1.2 to get information of above instrument.

4.4.3 Test Procedure

The transmitter output was connected to the spectrum analyzer through an attenuator. The bandwidth of the fundamental frequency was measured by spectrum analyzer with resolution bandwidth in the range of 1 % to 5 % of the anticipated emission bandwidth, and a video bandwidth at least 3x the resolution bandwidth and set the detector to SAMPLE. The width of a frequency band such that, below the lower and above the upper frequency limits, the mean powers emitted are each equal to a specified percentage 0.5 % of the total mean power of a given emission.

4.4.4 Test Results

802.11a

Channel	Channel Frequency (MHz)	Occupied Bandwidth (MHz)
36	5180	16.68
40	5200	16.56
48	5240	16.68
52	5260	16.68
60	5300	16.68
64	5320	16.80
100	5500	16.80
116	5580	16.68
140	5700	16.68
149	5745	16.73
157	5785	16.64
165	5825	16.74

802.11n (HT20)

Channel	Channel Frequency (MHz)	Occupied Bandwidth (MHz)
36	5180	17.88
40	5200	16.68
48	5240	17.88
52	5260	17.88
60	5300	17.88
64	5320	17.88
100	5500	17.88
116	5580	17.88
140	5700	17.88
149	5745	17.88
157	5785	17.94
165	5825	17.82

802.11n (HT40)

Channel	Channel Frequency (MHz)	Occupied Bandwidth (MHz)
38	5190	36.60
46	5230	36.60
54	5270	36.60
62	5310	36.72
102	5510	36.60
110	5550	36.48
134	5670	36.60
151	5755	36.60
159	5795	36.54

802.11ac (VHT80)

Channel	Channel Frequency (MHz)	Occupied Bandwidth (MHz)
42	5210	75.84
58	5290	75.84
106	5530	75.84
122	5610	75.60
155	5775	75.72

Spectrum Plot of Worst Value

802.11a

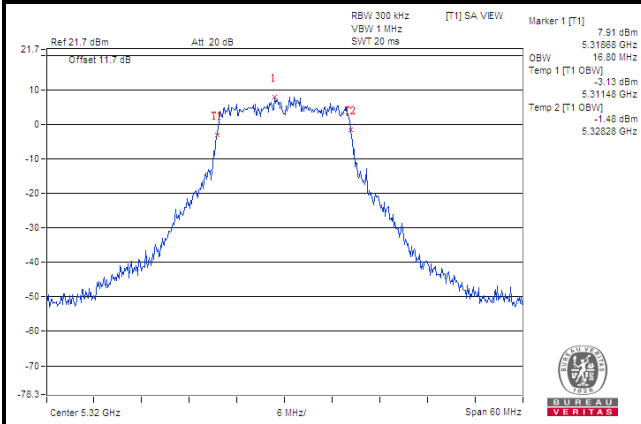

802.11n (HT20)

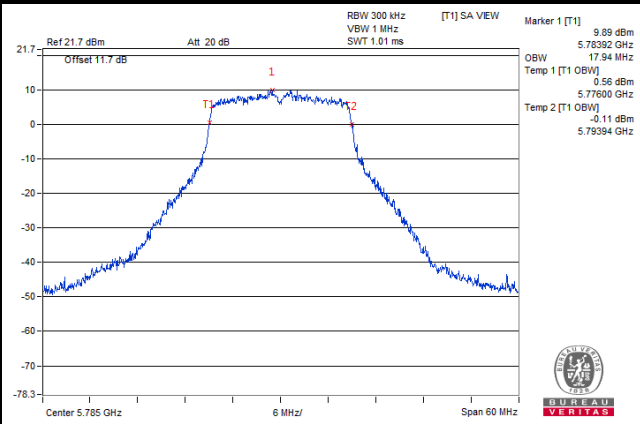

802.11n (HT40)

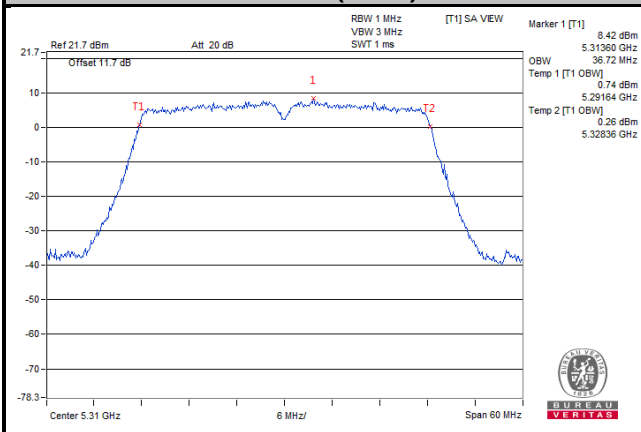

802.11ac (VHT80)

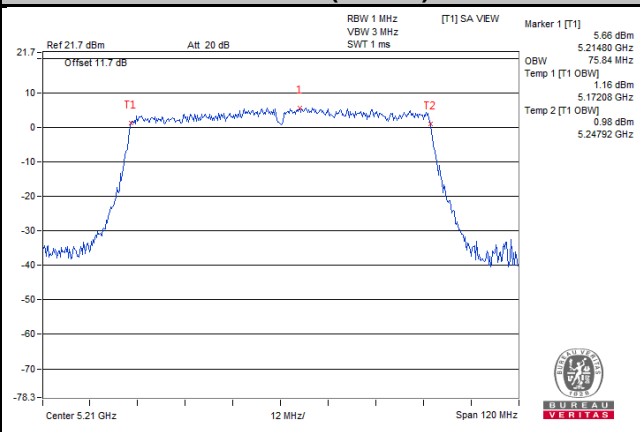

4.5 Peak Power Spectral Density Measurement

4.5.1 Limits of Peak Power Spectral Density Measurement

Operation Band	EUT Category		Limit
U-NII-1		Outdoor Access Point	17 dBm/MHz
		Fixed point-to-point Access Point	
		Indoor Access Point	
	√	Mobile and Portable client device	11 dBm/MHz
U-NII-2A		√	11 dBm/MHz
U-NII-2C		√	11 dBm/MHz
U-NII-3		√	30 dBm/500 kHz

4.5.2 Test Setup

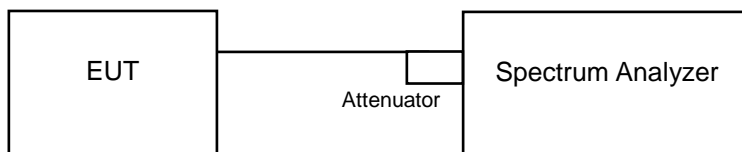

4.5.3 Test Instruments

Refer to section 4.1.3 to get information of above instrument.

4.5.4 Test Procedures

For U-NII-1, U-NII-2A, U-NII-2C band:

Using method SA-2

1. Set span to encompass the entire emission bandwidth (EBW) of the signal.
2. Set RBW = 1 MHz, Set VBW \geq 3 RBW, Detector = RMS
3. Sweep time = auto, trigger set to "free run".
4. Trace average at least 100 traces in power averaging mode.
5. Record the max value and add $10 \log (1/\text{duty cycle})$

※For U-NII-3:

1. Set span to encompass the entire emission bandwidth (EBW) of the signal.
2. Set RBW = 500 kHz, Set VBW \geq 3 RBW, Detector = RMS
3. Use the peak marker function to determine the maximum power level in any 500 kHz band segment within the fundamental EBW.
4. Sweep time = auto, trigger set to "free run".
5. Trace average at least 100 traces in power averaging mode.
6. Record the max value and add $10 \log (1/\text{duty cycle})$

4.5.5 Deviation from Test Standard

No deviation.

4.5.6 EUT Operating Conditions

The software provided by client to enable the EUT under transmission condition continuously at lowest, middle and highest channel frequencies individually.

4.5.7 Test Results

802.11a

Channel	Frequency (MHz)	PSD w/o Duty Factor (dBm/MHz)	Duty Factor (dB)	PSD with Duty Factor (dBm/MHz)	Maximum Limit (dBm/MHz)	Pass / Fail
36	5180	3.27	0.38	3.65	11	Pass
40	5200	3.59	0.38	3.97	11	Pass
48	5240	3.65	0.38	4.03	11	Pass
52	5260	3.68	0.38	4.06	11	Pass
60	5300	3.92	0.38	4.30	11	Pass
64	5320	3.32	0.38	3.70	11	Pass
100	5500	1.77	0.38	2.15	11	Pass
116	5580	4.41	0.38	4.79	11	Pass
140	5700	1.91	0.38	2.29	11	Pass

Note: Refer to section 3.3 for duty cycle spectrum plot.

802.11n (HT20)

Channel	Frequency (MHz)	PSD w/o Duty Factor (dBm/MHz)	Duty Factor (dB)	PSD with Duty Factor (dBm/MHz)	Maximum Limit (dBm/MHz)	Pass / Fail
36	5180	5.89	0.34	6.23	11	Pass
40	5200	6.89	0.34	7.23	11	Pass
48	5240	6.71	0.34	7.05	11	Pass
52	5260	6.53	0.34	6.87	11	Pass
60	5300	6.25	0.34	6.59	11	Pass
64	5320	5.82	0.34	6.16	11	Pass
100	5500	4.06	0.34	4.40	11	Pass
116	5580	6.59	0.34	6.93	11	Pass
140	5700	3.83	0.34	4.17	11	Pass

Note: Refer to section 3.3 for duty cycle spectrum plot.

802.11n (HT40)

Channel	Frequency (MHz)	PSD w/o Duty Factor (dBm/MHz)	Duty Factor (dB)	PSD with Duty Factor (dBm/MHz)	Maximum Limit (dBm/MHz)	Pass / Fail
38	5190	-1.56	0.71	-0.85	11	Pass
46	5230	0.92	0.71	1.63	11	Pass
54	5270	0.56	0.71	1.27	11	Pass
62	5310	-1.59	0.71	-0.88	11	Pass
102	5510	-2.72	0.71	-2.01	11	Pass
110	5550	1.21	0.71	1.92	11	Pass
134	5670	1.11	0.71	1.82	11	Pass

Note: Refer to section 3.3 for duty cycle spectrum plot.

802.11ac (VHT80)

Channel	Frequency (MHz)	PSD w/o Duty Factor (dBm/MHz)	Duty Factor (dB)	PSD with Duty Factor (dBm/MHz)	Maximum Limit (dBm/MHz)	Pass / Fail
42	5210	-4.00	1.15	-2.85	11	Pass
58	5290	-2.99	1.15	-1.84	11	Pass
106	5530	-2.48	1.15	-1.33	11	Pass
122	5610	-2.44	1.15	-1.29	11	Pass

Note: Refer to section 3.3 for duty cycle spectrum plot.

Spectrum Plot of Worst Value

802.11a

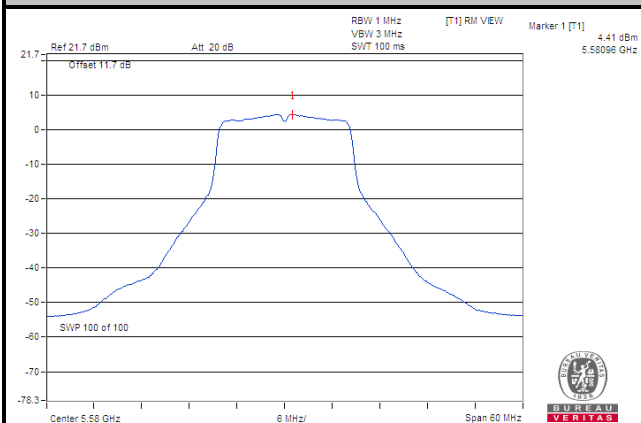

802.11n (HT20)

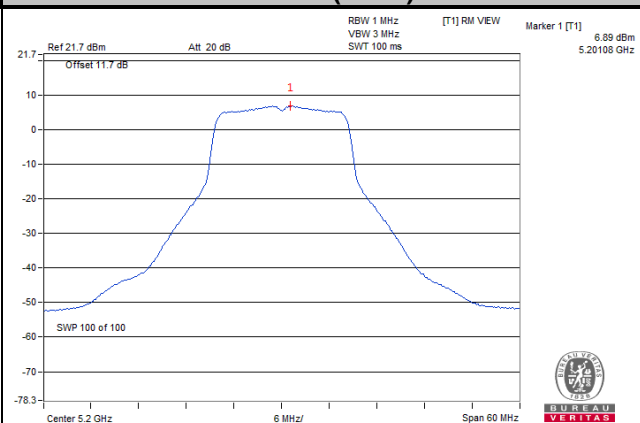

802.11n (HT40)

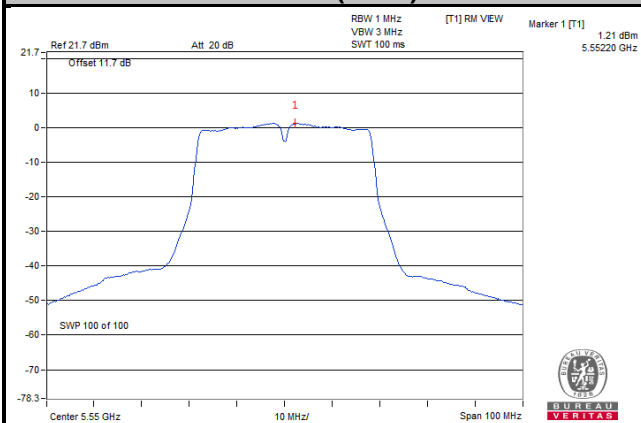

802.11ac (VHT80)

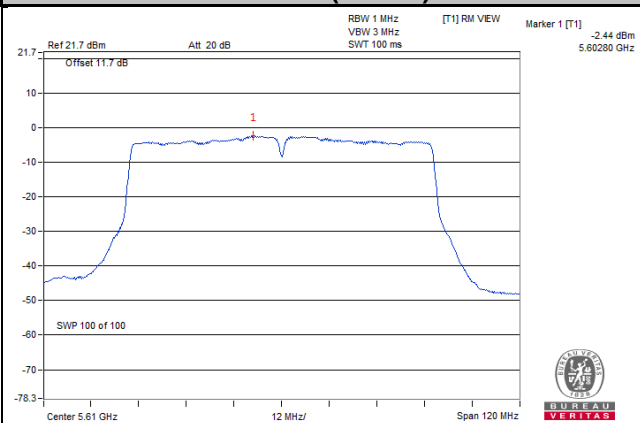

For U-NII-3 Band

802.11a

Channel	Frequency (MHz)	PSD w/o Duty Factor (dBm/500 kHz)	Duty Factor (dB)	PSD with Duty Factor (dBm/500 kHz)	Limit (dBm/500 kHz)	Pass / Fail
149	5745	-7.89	0.38	-7.51	30	Pass
157	5785	-3.68	0.38	-3.30	30	Pass
165	5825	-3.98	0.38	-3.60	30	Pass

Note: Refer to section 3.3 for duty cycle spectrum plot.

802.11n (HT20)

Channel	Frequency (MHz)	PSD w/o Duty Factor (dBm/500 kHz)	Duty Factor (dB)	PSD with Duty Factor (dBm/500 kHz)	Limit (dBm/500 kHz)	Pass / Fail
149	5745	-3.16	0.34	-2.82	30	Pass
157	5785	1.51	0.34	1.85	30	Pass
165	5825	1.04	0.34	1.38	30	Pass

Note: Refer to section 3.3 for duty cycle spectrum plot.

802.11n (HT40)

Channel	Frequency (MHz)	PSD w/o Duty Factor (dBm/500 kHz)	Duty Factor (dB)	PSD with Duty Factor (dBm/500 kHz)	Limit (dBm/500 kHz)	Pass / Fail
151	5755	-6.88	0.71	-6.17	30	Pass
159	5795	-4.11	0.71	-3.40	30	Pass

Note: Refer to section 3.3 for duty cycle spectrum plot.

802.11ac (VHT80)

Channel	Frequency (MHz)	PSD w/o Duty Factor (dBm/500 kHz)	Duty Factor (dB)	PSD with Duty Factor (dBm/500 kHz)	Limit (dBm/500 kHz)	Pass / Fail
155	5775	-8.46	1.15	-7.31	30	Pass

Note: Refer to section 3.3 for duty cycle spectrum plot.

Spectrum Plot of Worst Value

802.11a

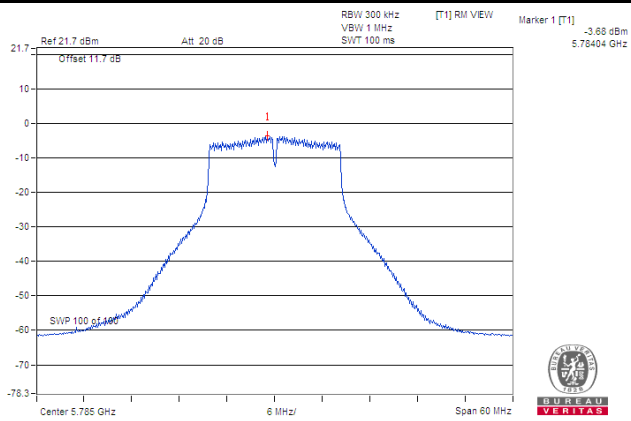

802.11n (HT20)

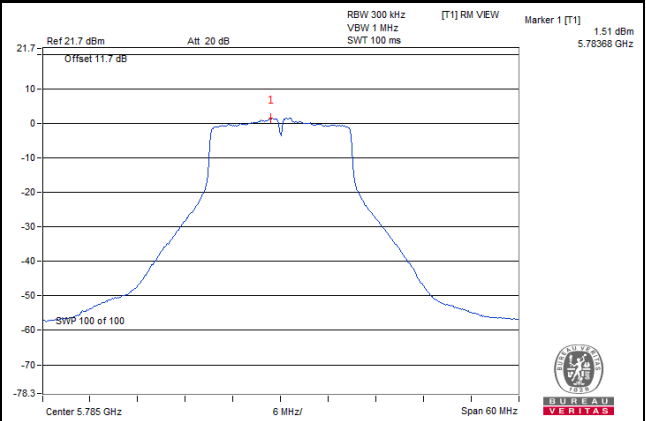

802.11n (HT40)

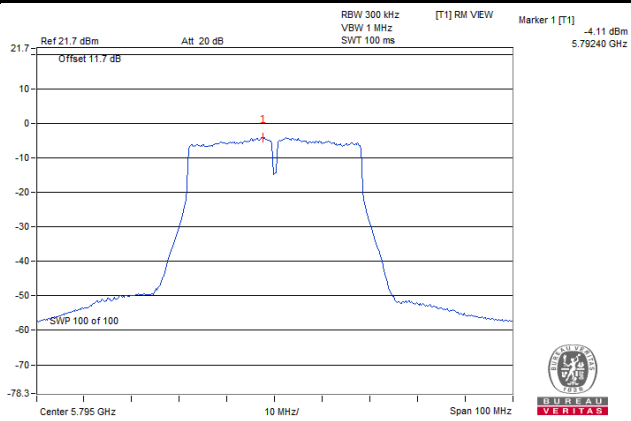

802.11ac (VHT80)

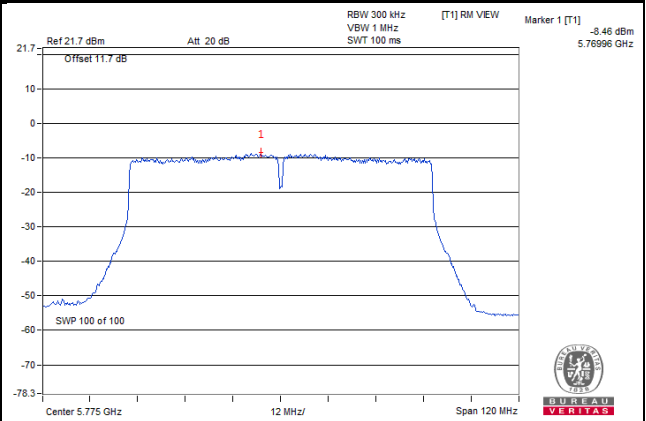

4.6 Frequency Stability

4.6.1 Limit of Frequency Stability Measurement

The frequency of the carrier signal shall be maintained within band of operation.

4.6.2 Test Setup

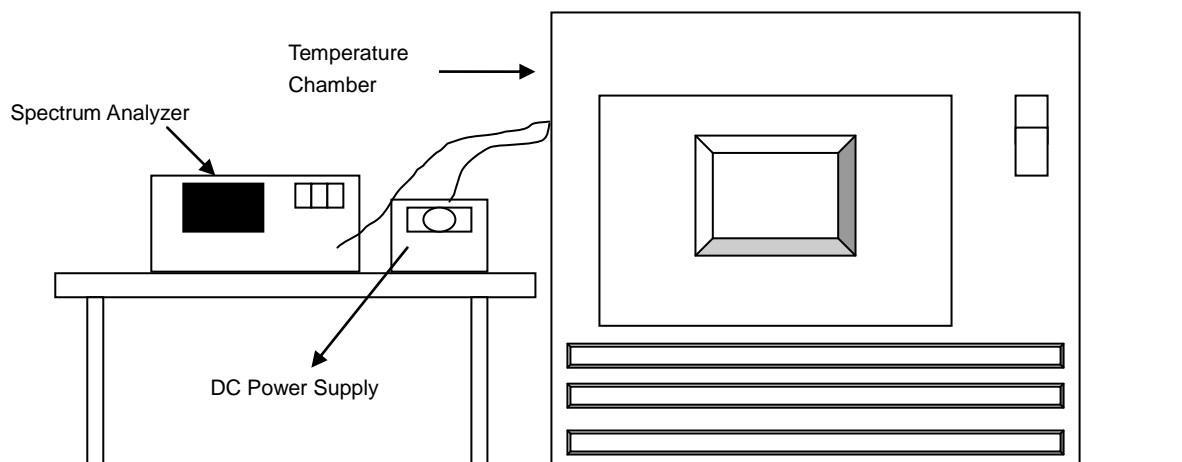

4.6.3 Test Instruments

Refer to section 4.1.3 to get information of above instrument.

4.6.4 Test Procedure

- To ensure emission at the band edge is maintained within the authorized band, those values shall be measured by radiation emissions at upper and lower frequency points, and finally compensated by frequency deviation as procedures below.
- The EUT was operated at the maximum output power, and connected to the spectrum analyzer, which is set to maximum hold function and peak detector. The peak value of the power envelope was measured and noted. The upper and lower frequency points were respectively measured relatively 10 dB lower than the measured peak value.
- The frequency deviation was calculated by adding the upper frequency point and the lower frequency point divided by two. Those detailed values of frequency deviation are provided in table below.

4.6.5 Deviation from Test Standard

No deviation.

4.6.6 EUT Operating Condition

Set the EUT transmit at un-modulation mode to test frequency stability.

4.6.7 Test Results

Frequency Stability Versus Temp.									
Operating Frequency: 5180 MHz									
Temp. (°C)	Power Supply (Vdc)	0 Minute		2 Minute		5 Minute		10 Minute	
		Measured Frequency (MHz)	Result	Measured Frequency (MHz)	Result	Measured Frequency (MHz)	Result	Measured Frequency (MHz)	Result
60	3.8	5179.9912	PASS	5179.9916	PASS	5179.9946	PASS	5179.994	PASS
50	3.8	5179.9904	PASS	5179.992	PASS	5179.9946	PASS	5179.9916	PASS
40	3.8	5180.0144	PASS	5180.0168	PASS	5180.0164	PASS	5180.0147	PASS
30	3.8	5180.0214	PASS	5180.0214	PASS	5180.0204	PASS	5180.0192	PASS
20	3.8	5180.0025	PASS	5179.9996	PASS	5179.9991	PASS	5180.0017	PASS
10	3.8	5180.0044	PASS	5180.0079	PASS	5180.0061	PASS	5180.0075	PASS
0	3.8	5180.0043	PASS	5180.0067	PASS	5180.0023	PASS	5180.0039	PASS
-10	3.8	5180.0207	PASS	5180.0248	PASS	5180.0233	PASS	5180.0246	PASS
-20	3.8	5180.0186	PASS	5180.0194	PASS	5180.0178	PASS	5180.0198	PASS
-30	3.8	5180.0183	PASS	5180.0123	PASS	5180.0151	PASS	5180.0199	PASS

Frequency Stability Versus Temp.									
Operating Frequency: 5180 MHz									
Temp. (°C)	Power Supply (Vdc)	0 Minute		2 Minute		5 Minute		10 Minute	
		Measured Frequency (MHz)	Result	Measured Frequency (MHz)	Result	Measured Frequency (MHz)	Result	Measured Frequency (MHz)	Result
20	4.37	5180.021	PASS	5180.0222	PASS	5180.0212	PASS	5180.0191	PASS
	3.8	5180.0214	PASS	5180.0214	PASS	5180.0204	PASS	5180.0192	PASS
	3.23	5180.022	PASS	5180.0219	PASS	5180.0211	PASS	5180.0191	PASS

4.7 6 dB Bandwidth Measurement

4.7.1 Limits of 6 dB Bandwidth Measurement

The minimum of 6 dB Bandwidth Measurement is 0.5 MHz.

4.7.2 Test Setup

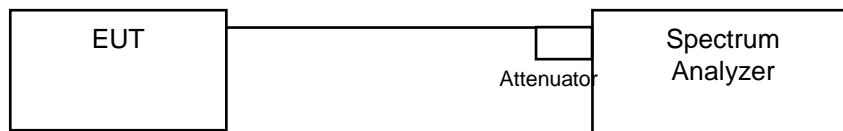

4.7.3 Test Instruments

Refer to section 4.1.3 to get information of above instrument.

4.7.4 Test Procedure

MEASUREMENT PROCEDURE REF

- Set resolution bandwidth (RBW) = 100 kHz
- Set the video bandwidth (VBW) $\geq 3 \times$ RBW, Detector = Peak.
- Trace mode = max hold.
- Sweep = auto couple.
- Measure the maximum width of the emission that is constrained by the frequencies associated with the two amplitude points (upper and lower) that are attenuated by 6 dB relative to the maximum level measured in the fundamental emission

4.7.5 Deviation from Test Standard

No deviation.

4.7.6 EUT Operating Condition

The software provided by client to enable the EUT under transmission condition continuously at lowest, middle and highest channel frequencies individually.

4.7.7 Test Results

802.11a

Channel	Frequency (MHz)	6 dB Bandwidth (MHz)	Minimum Limit (MHz)	Pass / Fail
149	5745	15.31	0.5	Pass
157	5785	15.46	0.5	Pass
165	5825	15.68	0.5	Pass

802.11n (HT20)

Channel	Frequency (MHz)	6 dB Bandwidth (MHz)	Minimum Limit (MHz)	Pass / Fail
149	5745	15.18	0.5	Pass
157	5785	15.72	0.5	Pass
165	5825	15.33	0.5	Pass

802.11n (HT40)

Channel	Frequency (MHz)	6 dB Bandwidth (MHz)	Minimum Limit (MHz)	Pass / Fail
151	5755	36.07	0.5	Pass
159	5795	35.53	0.5	Pass

802.11ac (VHT80)

Channel	Frequency (MHz)	6 dB Bandwidth (MHz)	Minimum Limit (MHz)	Pass / Fail
155	5775	75.31	0.5	Pass

Spectrum Plot of Worst Value

802.11a

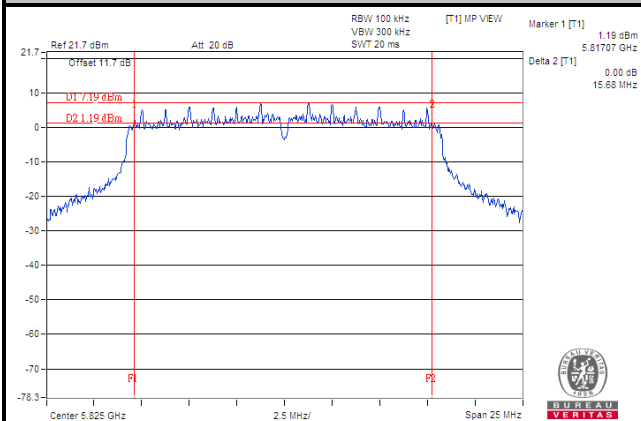

802.11n (HT20)

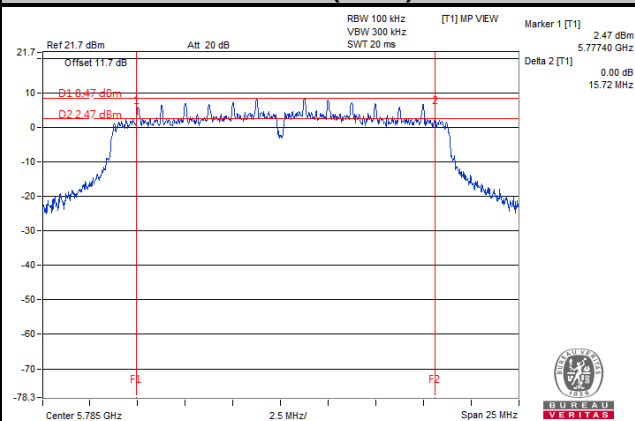

802.11n (HT40)

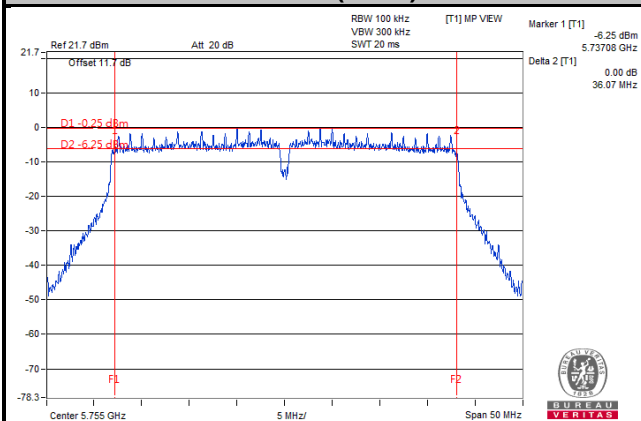

802.11ac (VHT80)

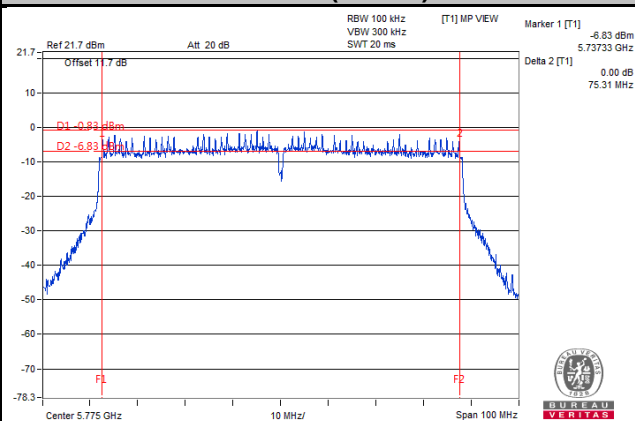

5 Pictures of Test Arrangements

Please refer to the attached file (Test Setup Photo).

Annex A- Radiated Out of Band Emission (OOBE) Measurement (For U-NII-3 band)

802.11a

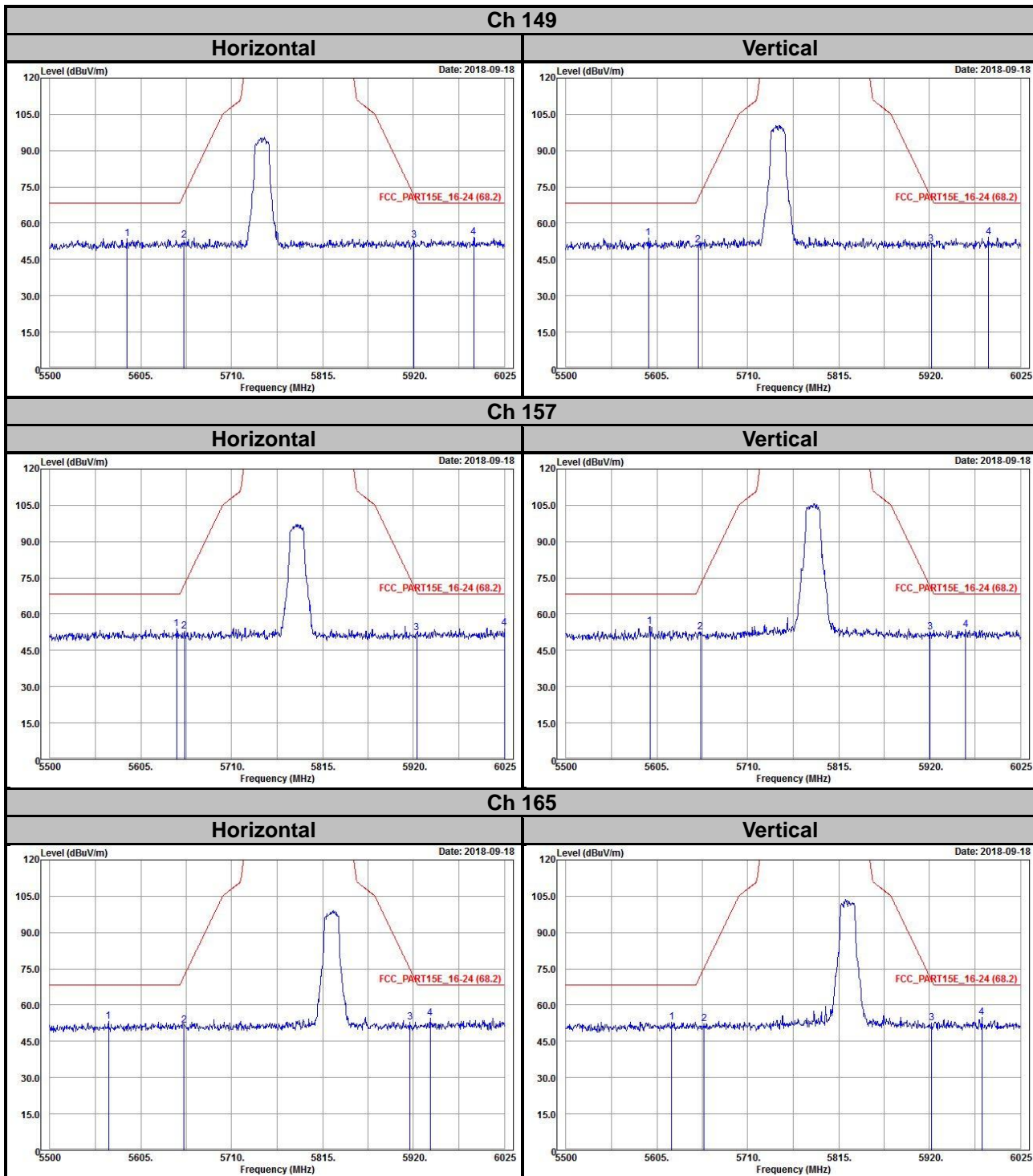

802.11n (HT20)

Ch 149

Horizontal

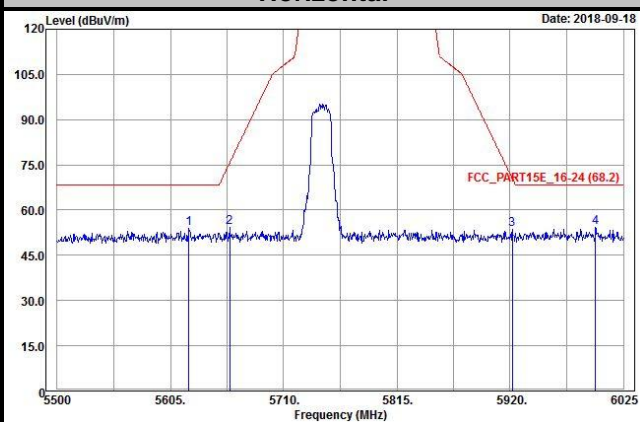

Vertical

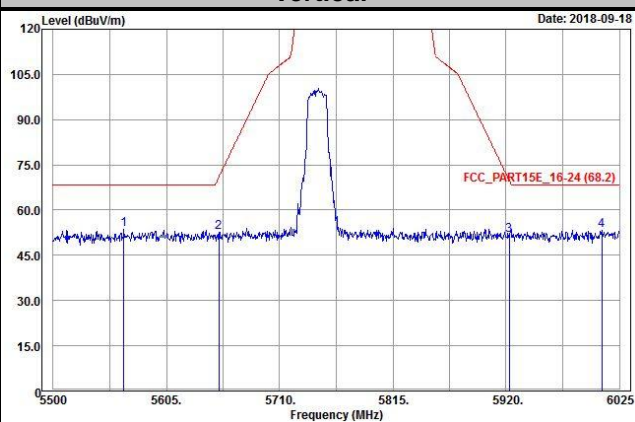

Ch 157

Horizontal

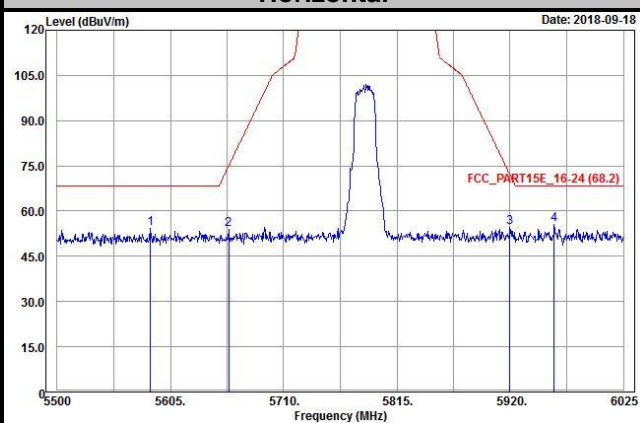

Vertical

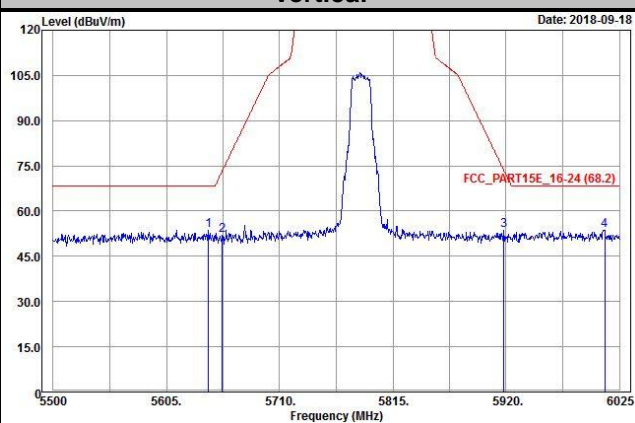

Ch 165

Horizontal

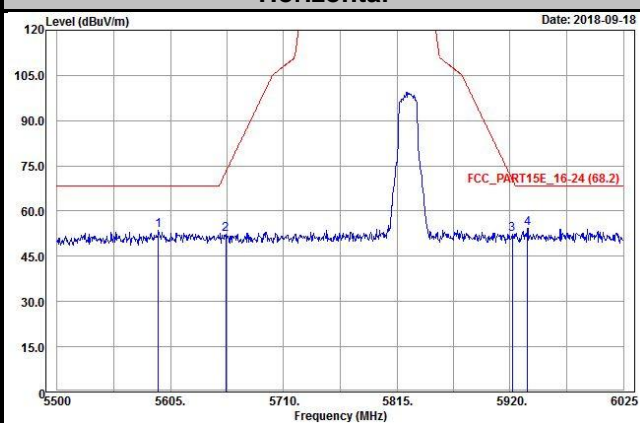

Vertical

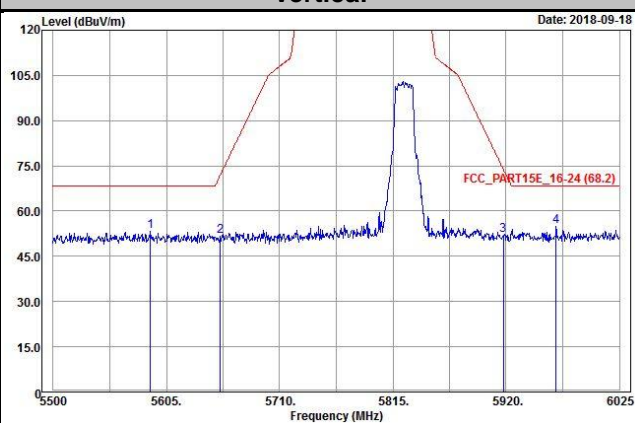

802.11n (HT40)

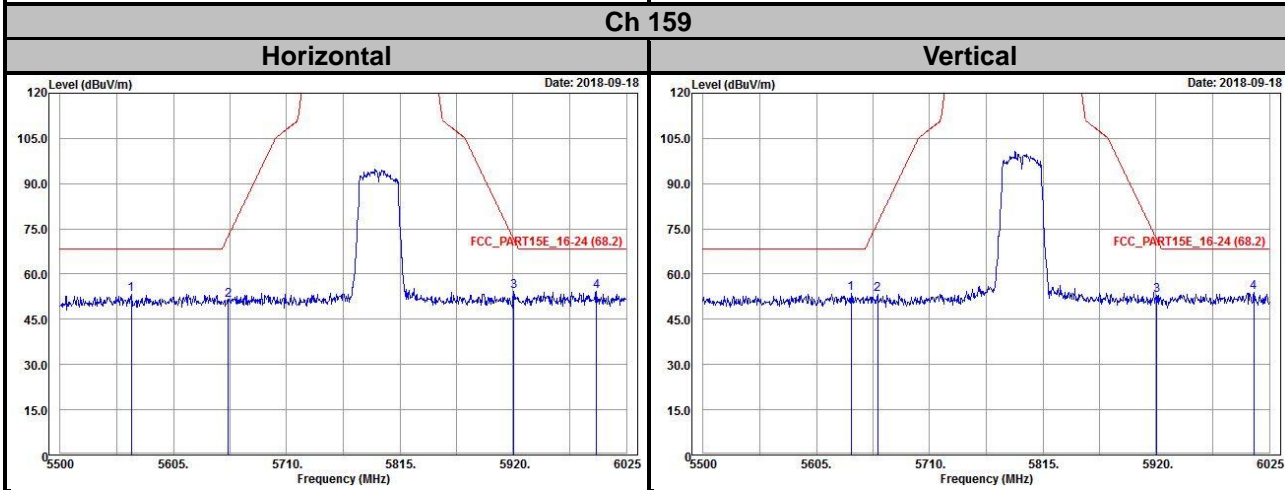
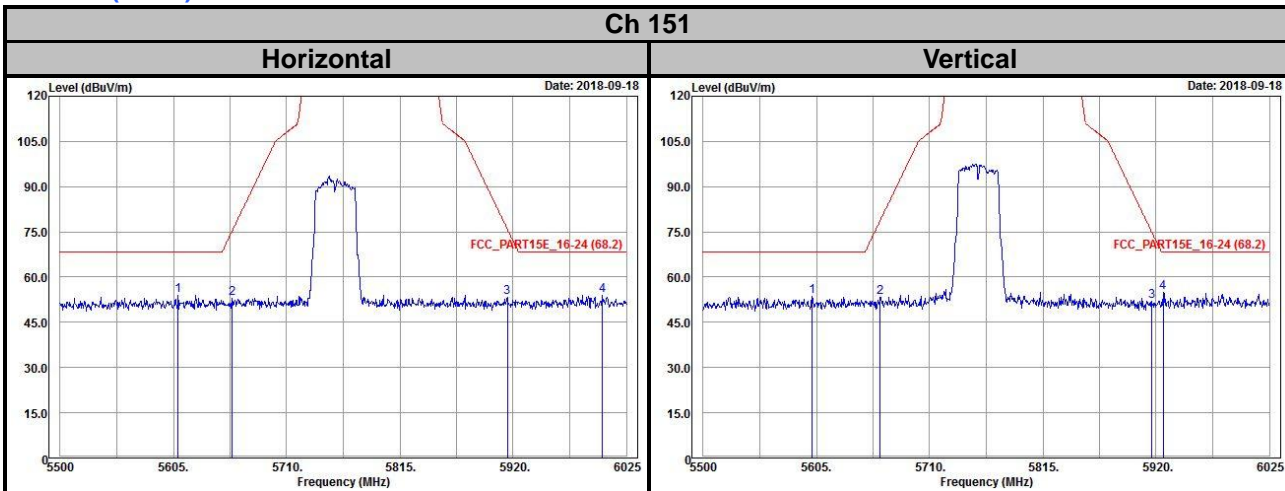

802.11ac (VHT80)

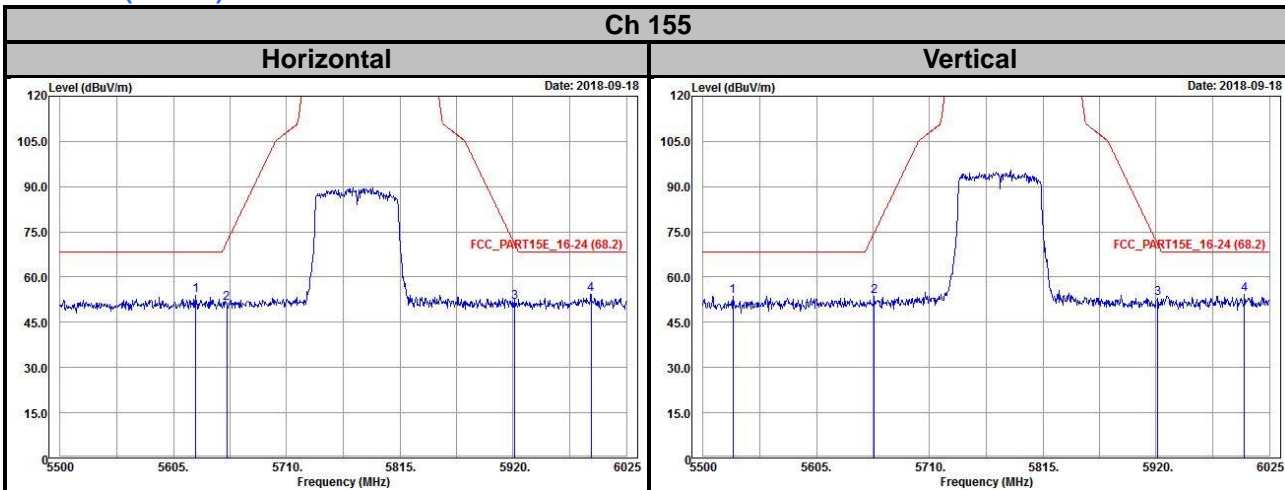

Appendix – Information on the Testing Laboratories

We, Bureau Veritas Consumer Products Services (H.K.) Ltd., Taoyuan Branch, were founded in 1988 to provide our best service in EMC, Radio, Telecom and Safety consultation. Our laboratories are FCC recognized accredited test firms and accredited according to ISO/IEC 17025.

If you have any comments, please feel free to contact us at the following:

Linko EMC/RF Lab

Tel: 886-2-26052180

Fax: 886-2-26051924

Hsin Chu EMC/RF/Telecom Lab

Tel: 886-3-6668565

Fax: 886-3-6668323

Hwa Ya EMC/RF/Safety

Tel: 886-3-3183232

Fax: 886-3-3270892

Email: service.adt@tw.bureauveritas.com

Web Site: www.bureauveritas-adt.com

The address and road map of all our labs can be found in our web site also.

--- END ---