

## FCC Test Report

**Report No.:** RF180821C20-3

**FCC ID:** V65E6910

**Test Model:** E6910

**Received Date:** Aug. 21, 2018

**Test Date:** Sep. 13, 2018 ~ Sep. 18, 2018

**Issued Date:** Sep. 25, 2018

**Applicant:** Kyocera Corporation c/o Kyocera International, Inc.

**Address:** 8611 Balboa Avenue, San Diego, CA 92123

**Issued By:** Bureau Veritas Consumer Products Services (H.K.) Ltd., Taoyuan Branch

**Lab Address:** No. 47-2, 14th Ling, Chia Pau Vil., Lin Kou Dist., New Taipei City, Taiwan  
( R.O.C )

**Test Location (1):** No.19, Hwa Ya 2nd Rd., Wen Hwa Vil., Kwei Shan Dist., Taoyuan City  
33383, Taiwan, R.O.C.

**Test Location (2):** No.215, Sec. 3, Beixin Rd., Xindian Dist., New Taipei City 231, Taiwan,  
R.O.C

**FCC Registration /  
Designation Number:** 427177 / TW0011



This report is for your exclusive use. Any copying or replication of this report to or for any other person or entity, or use of our name or trademark, is permitted only with our prior written permission. This report sets forth our findings solely with respect to the test samples identified herein. The results set forth in this report are not indicative or representative of the quality or characteristics of the lot from which a test sample was taken or any similar or identical product unless specifically and expressly noted. Our report includes all of the tests requested by you and the results thereof based upon the information that you provided to us. You have 60 days from date of issuance of this report to notify us of any material error or omission caused by our negligence, provided, however, that such notice shall be in writing and shall specifically address the issue you wish to raise. A failure to raise such issue within the prescribed time shall constitute your unqualified acceptance of the completeness of this report, the tests conducted and the correctness of the report contents. Unless specific mention, the uncertainty of measurement has been explicitly taken into account to declare the compliance or non-compliance to the specification. The report must not be used by the client to claim product certification, approval, or endorsement by TAF or any government agencies.

## Table of Contents

<b>Release Control Record</b> .....	<b>4</b>
<b>1 Certificate of Conformity</b> .....	<b>5</b>
<b>2 Summary of Test Results</b> .....	<b>6</b>
2.1 Measurement Uncertainty .....	6
2.2 Modification Record .....	6
<b>3 General Information</b> .....	<b>7</b>
3.1 General Description of EUT .....	7
3.2 Description of Test Modes .....	8
3.2.1 Test Mode Applicability and Tested Channel Detail .....	9
3.3 Duty Cycle of Test Signal .....	11
3.4 Description of Support Units .....	12
3.4.1 Configuration of System under Test .....	12
3.5 General Description of Applied Standards .....	12
<b>4 Test Types and Results</b> .....	<b>13</b>
4.1 Radiated Emission and Bandedge Measurement .....	13
4.1.1 Limits of Radiated Emission and Bandedge Measurement .....	13
4.1.2 Test Instruments .....	14
4.1.3 Test Procedures .....	15
4.1.4 Deviation from Test Standard .....	16
4.1.5 Test Set Up .....	17
4.1.6 EUT Operating Conditions .....	18
4.1.7 Test Results .....	19
4.2 Conducted Emission Measurement .....	30
4.2.1 Limits of Conducted Emission Measurement .....	30
4.2.2 Test Instruments .....	30
4.2.3 Test Procedures .....	31
4.2.4 Deviation from Test Standard .....	31
4.2.5 Test Setup .....	31
4.2.6 EUT Operating Conditions .....	31
4.2.7 Test Results .....	32
4.3 6 dB Bandwidth Measurement .....	34
4.3.1 Limits of 6 dB Bandwidth Measurement .....	34
4.3.2 Test Setup .....	34
4.3.3 Test Instruments .....	34
4.3.4 Test Procedure .....	34
4.3.5 Deviation from Test Standard .....	34
4.3.6 EUT Operating Conditions .....	34
4.3.7 Test Result .....	35
4.4 Occupied Bandwidth Measurement .....	37
4.4.1 Test Setup .....	37
4.4.2 Test Instruments .....	37
4.4.3 Test Procedure .....	37
4.4.4 Deviation from Test Standard .....	37
4.4.5 EUT Operating Conditions .....	37
4.4.6 Test Results .....	38
4.5 Conducted Output Power Measurement .....	40
4.5.1 Limits of Conducted Output Power Measurement .....	40
4.5.2 Test Setup .....	40
4.5.3 Test Instruments .....	40
4.5.4 Test Procedures .....	40
4.5.5 Deviation from Test Standard .....	40
4.5.6 EUT Operating Conditions .....	40
4.5.7 Test Results .....	41

4.6	Power Spectral Density Measurement .....	42
4.6.1	Limits of Power Spectral Density Measurement.....	42
4.6.2	Test Setup.....	42
4.6.3	Test Instruments .....	42
4.6.4	Test Procedure .....	42
4.6.5	Deviation from Test Standard .....	42
4.6.6	EUT Operating Condition .....	42
4.6.7	Test Results .....	43
4.7	Conducted Out of Band Emission Measurement .....	45
4.7.1	Limits of Conducted Out of Band Emission Measurement.....	45
4.7.2	Test Setup.....	45
4.7.3	Test Instruments .....	45
4.7.4	Test Procedure .....	45
4.7.5	Deviation from Test Standard .....	45
4.7.6	EUT Operating Condition .....	45
4.7.7	Test Results .....	46
<b>5</b>	<b>Pictures of Test Arrangements.....</b>	<b>52</b>
	<b>Appendix – Information on the Testing Laboratories .....</b>	<b>53</b>

### Release Control Record

Issue No.	Description	Date Issued
RF180821C20-3	Original Release	Sep. 25, 2018

## 1 Certificate of Conformity

**Product:** Smart Phone

**Brand:** Kyocera

**Test Model:** E6910

**Sample Status:** Identical Prototype

**Applicant:** Kyocera Corporation c/o Kyocera International, Inc.

**Test Date:** Sep. 13, 2018 ~ Sep. 18, 2018

**Standards:** 47 CFR FCC Part 15, Subpart C (Section 15.247)  
ANSI C63.10:2013

The above equipment has been tested by **Bureau Veritas Consumer Products Services (H.K.) Ltd., Taoyuan Branch**, and found compliance with the requirement of the above standards. The test record, data evaluation & Equipment Under Test (EUT) configurations represented herein are true and accurate accounts of the measurements of the sample's RF characteristics under the conditions specified in this report.

**Prepared by :** , **Date:** Sep. 25, 2018  
Ivonne Wu / Supervisor

**Approved by :** , **Date:** Sep. 25, 2018  
Dylan Chiou / Project Engineer

## 2 Summary of Test Results

47 CFR FCC Part 15, Subpart C (Section 15.247)			
FCC Clause	Test Item	Result	Remarks
15.207	AC Power Conducted Emission	Pass	Meet the requirement of limit. Minimum passing margin is -14.66 dB at 0.61138 MHz.
15.205 / 15.209 / 15.247(d)	Radiated Emissions and Band Edge Measurement	Pass	Meet the requirement of limit. Minimum passing margin is -7.93 dB at 91.83 MHz.
15.247(d)	Antenna Port Emission	Pass	Meet the requirement of limit.
15.247(a)(2)	6 dB Bandwidth	Pass	Meet the requirement of limit.
---	Occupied Bandwidth Measurement	Pass	Reference only
15.247(b)	Conducted power	Pass	Meet the requirement of limit.
15.247(e)	Power Spectral Density	Pass	Meet the requirement of limit.
15.203	Antenna Requirement	Pass	No antenna connector is used.

### 2.1 Measurement Uncertainty

Where relevant, the following measurement uncertainty levels have been estimated for tests performed on the EUT as specified in CISPR 16-4-2:

Measurement	Frequency	Expanded Uncertainty (k=2) (±)
Conducted Emissions at mains ports	150 kHz ~ 30 MHz	2.44 dB
Radiated Emissions up to 1 GHz	30 MHz ~ 200 MHz	2.0153 dB
	200 MHz ~ 1000 MHz	2.0224 dB
Radiated Emissions above 1 GHz	1 GHz ~ 18 GHz	1.0121 dB
	18 GHz ~ 40 GHz	1.1508 dB

### 2.2 Modification Record

There were no modifications required for compliance.

### 3 General Information

#### 3.1 General Description of EUT

<b>Product</b>	Smart Phone
<b>Brand</b>	Kyocera
<b>Test Model</b>	E6910
<b>Status of EUT</b>	Identical Prototype
<b>Power Supply Rating</b>	3.8 Vdc (Battery) 5 Vdc or 9 Vdc or 12 Vdc (Adapter) 5 Vdc (Host equipment)
<b>Modulation Type</b>	CCK, DQPSK, DBPSK for DSSS 64QAM, 16QAM, QPSK, BPSK for OFDM
<b>Modulation Technology</b>	DSSS, OFDM
<b>Transfer Rate</b>	802.11b: 11.0 / 5.5 / 2.0 / 1.0 Mbps 802.11g: 54.0 / 48.0 / 36.0 / 24.0 / 18.0 / 12.0 / 9.0 / 6.0 Mbps 802.11n: up to 72.2 Mbps
<b>Operating Frequency</b>	2412 ~ 2462 MHz
<b>Number of Channel</b>	11 for 802.11b, 802.11g, 802.11n (HT20)
<b>Output Power</b>	153.815 mW
<b>Antenna Type</b>	Fixed Internal antenna with -1.0 dBi gain
<b>Antenna Connector</b>	N/A
<b>Accessory Device</b>	Refer to Note as below
<b>Data Cable Supplied</b>	Refer to Note as below

Note:

1. The EUT provides one transmitter and receiver.

Modulation Mode	Tx Function
802.11b	1TX
802.11g	1TX
802.11n (HT20)	1TX

2. The EUT's accessories list refers to Ext. Pho.
3. The above EUT information is declared by manufacturer and for more detailed features description, please refers to the manufacturer's specifications or user's manual.

### 3.2 Description of Test Modes

11 channels are provided for 802.11b, 802.11g and 802.11n (HT20):

Channel	Frequency (MHz)	Channel	Frequency (MHz)
1	2412	7	2442
2	2417	8	2447
3	2422	9	2452
4	2427	10	2457
5	2432	11	2462
6	2437		



### 3.2.1 Test Mode Applicability and Tested Channel Detail

EUT Configure Mode	Applicable To				Description
	RE $\geq$ 1G	RE<1G	PLC	APCM	
-	√	√	√	√	-

Where **RE $\geq$ 1G**: Radiated Emission above 1 GHz      **RE<1G**: Radiated Emission below 1 GHz  
**PLC**: Power Line Conducted Emission      **APCM**: Antenna Port Conducted Measurement

**NOTE:** The EUT had been pre-tested on the positioned of each 3 axis. The worst case was found when positioned on **X-plane**.

**NOTE:** “-” means no effect.

#### **Radiated Emission Test (Above 1 GHz):**

- Pre-Scan has been conducted to determine the worst-case mode from all possible combinations between available modulations, data rates and antenna ports (if EUT with antenna diversity architecture).
- Following channel(s) was (were) selected for the final test as listed below.

EUT Configure Mode	Mode	Available Channel	Tested Channel	Modulation Technology	Modulation Type	Data Rate (Mbps)
-	802.11b	1 to 11	1, 6, 11	DSSS	DBPSK	1.0
-	802.11g	1 to 11	1, 6, 11	OFDM	BPSK	6.0
-	802.11n (HT20)	1 to 11	1, 6, 11	OFDM	BPSK	6.5

#### **Radiated Emission Test (Below 1 GHz):**

- Pre-Scan has been conducted to determine the worst-case mode from all possible combinations between available modulations, data rates and antenna ports (if EUT with antenna diversity architecture).
- Following channel(s) was (were) selected for the final test as listed below.

EUT Configure Mode	Mode	Available Channel	Tested Channel	Modulation Technology	Modulation Type	Data Rate (Mbps)
-	802.11n (HT20)	1 to 11	11	OFDM	BPSK	6.5

#### **Power Line Conducted Emission Test:**

- Pre-Scan has been conducted to determine the worst-case mode from all possible combinations between available modulations, data rates and antenna ports (if EUT with antenna diversity architecture).
- Following channel(s) was (were) selected for the final test as listed below.

EUT Configure Mode	Mode	Available Channel	Tested Channel	Modulation Technology	Modulation Type	Data Rate (Mbps)
-	802.11n (HT20)	1 to 11	11	OFDM	BPSK	6.5

### Bandedge Measurement:

- Pre-Scan has been conducted to determine the worst-case mode from all possible combinations between available modulations, data rates and antenna ports (if EUT with antenna diversity architecture).
- Following channel(s) was (were) selected for the final test as listed below.

EUT Configure Mode	Mode	Available Channel	Tested Channel	Modulation Technology	Modulation Type	Data Rate (Mbps)
-	802.11b	1 to 11	1, 11	DSSS	DBPSK	1.0
-	802.11g	1 to 11	1, 11	OFDM	BPSK	6.0
-	802.11n (HT20)	1 to 11	1, 11	OFDM	BPSK	6.5

### Antenna Port Conducted Measurement:

- This item includes all test value of each mode, but only includes spectrum plot of worst value of each mode.
- Pre-Scan has been conducted to determine the worst-case mode from all possible combinations between available modulations, data rates and antenna ports (if EUT with antenna diversity architecture).
- Following channel(s) was (were) selected for the final test as listed below.

EUT Configure Mode	Mode	Available Channel	Tested Channel	Modulation Technology	Modulation Type	Data Rate (Mbps)
-	802.11b	1 to 11	1, 6, 11	DSSS	DBPSK	1.0
-	802.11g	1 to 11	1, 6, 11	OFDM	BPSK	6.0
-	802.11n (HT20)	1 to 11	1, 6, 11	OFDM	BPSK	6.5

### Test Condition:

Applicable To	Environmental Conditions	Input Power	Tested by
RE $\geq$ 1G	25 deg. C, 65 % RH	120 Vac, 60 Hz	Charles Hsiao
RE<1G	25 deg. C, 65 % RH	120 Vac, 60 Hz	Charles Hsiao
PLC	25 deg. C, 65 % RH	120 Vac, 60 Hz	Jisyong Wang
APCM	25 deg. C, 65 % RH	3.8 Vdc	Gavin Wu

### 3.3 Duty Cycle of Test Signal

Duty cycle of test signal is < 98 %, duty factor shall be considered.

**802.11b:** Duty cycle =  $0.937/1.037 = 0.904$ , Duty factor =  $10 * \log(1/0.904) = 0.44$

**802.11g:** Duty cycle =  $1.342/1.442 = 0.931$ , Duty factor =  $10 * \log(1/0.931) = 0.31$

**802.11n (HT20):** Duty cycle =  $1.255/1.37 = 0.916$ , Duty factor =  $10 * \log(1/0.916) = 0.38$



### 3.4 Description of Support Units

The EUT has been tested as an independent unit together with other necessary accessories or support units. The following support units or accessories were used to form a representative test configuration during the tests.

No.	Product	Brand	Model No.	Serial No.	FCC ID
1.	Earphone	Funkey	FK130102	N/A	N/A

No.	Signal Cable Description of The Above Support Units
1.	N/A

Note:

1. All power cords of the above support units are non-shielded (1.8m).

#### 3.4.1 Configuration of System under Test

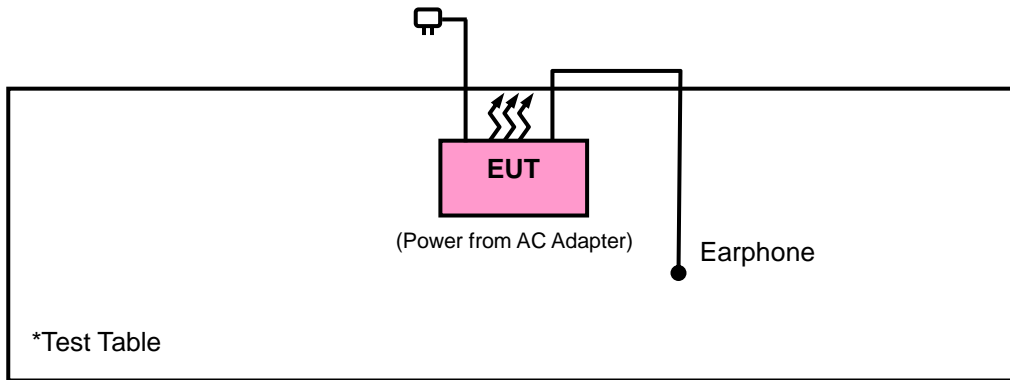

### 3.5 General Description of Applied Standards

The EUT is a RF Product. According to the specifications of the manufacturer, it must comply with the requirements of the following standards:

**FCC Part 15, Subpart C (15.247)**

**KDB 558074 D01 15.247 Meas Guidance v05**

ANSI C63.10-2013

All test items have been performed and recorded as per the above standards.

## 4 Test Types and Results

### 4.1 Radiated Emission and Bandedge Measurement

#### 4.1.1 Limits of Radiated Emission and Bandedge Measurement

Radiated emissions which fall in the restricted bands must comply with the radiated emission limits specified as below table. Other emissions shall be at least 20 dB below the highest level of the desired power:

Frequencies (MHz)	Field Strength (microvolts/meter)	Measurement Distance (meters)
0.009 ~ 0.490	2400/F (kHz)	300
0.490 ~ 1.705	24000/F (kHz)	30
1.705 ~ 30.0	30	30
30 ~ 88	100	3
88 ~ 216	150	3
216 ~ 960	200	3
Above 960	500	3

**NOTE:**

1. The lower limit shall apply at the transition frequencies.
2. Emission level (dBuV/m) = 20 log Emission level (uV/m).
3. For frequencies above 1000 MHz, the field strength limits are based on average detector, however, the peak field strength of any emission shall not exceed the maximum permitted average limits, specified above by more than 20 dB under any condition of modulation.

## 4.1.2 Test Instruments

Description & Manufacturer	Model No.	Serial No.	Date of Calibration	Due Date of Calibration
Test Receiver Agilent Technologies	N9038A	MY52260177	Aug. 20, 2018	Aug. 19, 2019
Spectrum Analyzer ROHDE & SCHWARZ	FSU43	101261	Jan. 11, 2018	Jan. 10, 2019
HORN Antenna ETS-Lindgren	3117	00143293	Dec. 13, 2017	Dec. 12, 2018
BILOG Antenna SCHWARZBECK	VULB 9168	9168-616	Dec. 14, 2017	Dec. 13, 2018
HORN Antenna SCHWARZBECK	BBHA 9170	9170-480	Dec. 01, 2017	Nov. 30, 2018
Fixed Attenuator Woken	00801A1GGAM02Y	NA	May 17, 2018	May 16, 2019
Loop Antenna	EM-6879	269	Sep. 07, 2018	Sep. 06, 2019
Preamplifier Agilent	310N	187226	Jun. 19, 2018	Jun. 18, 2019
Preamplifier Agilent	83017A	MY39501357	Jun. 19, 2018	Jun. 18, 2019
Power Meter Anritsu	ML2495A	1012010	Sep. 05, 2018	Sep. 04, 2019
Power Sensor Anritsu	MA2411B	1315050	Sep. 04, 2018	Sep. 03, 2019
RF signal cable ETS-LINDGREN	5D-FB	Cable-CH1-01(RFC -SMS-100-SMS-12 0+RFC-SMS-100-S MS-400)	Jun. 19, 2018	Jun. 18, 2019
RF signal cable ETS-LINDGREN	8D-FB	Cable-CH1-02(RFC -SMS-100-SMS-24)	Jun. 19, 2018	Jun. 18, 2019
Boresight Antenna Fixture	FBA-01	FBA-SIP01	NA	NA
Software BV ADT	E3 8.130425b	NA	NA	NA
Antenna Tower MF	NA	NA	NA	NA
Turn Table MF	NA	NA	NA	NA
Antenna Tower & Turn Table Controller MF	MF-7802	NA	NA	NA

- Note: 1. The calibration interval of the above test instruments is 12 months and the calibrations are traceable to NML/ROC and NIST/USA.
2. The test was performed in HsinTien Chamber 1.
3. The horn antenna and preamplifier (model: 83017A) are used only for the measurement of emission frequency above 1 GHz if tested.
4. The IC Site Registration No. is IC7450I-1.

#### 4.1.3 Test Procedures

##### **For Radiated Emission below 30 MHz**

- a. The EUT was placed on the top of a rotating table 0.8 meters above the ground at a 3 meter chamber room. The table was rotated 360 degrees to determine the position of the highest radiation.
- b. The EUT was set 3 meters away from the interference-receiving antenna, which was mounted on the top of a variable-height antenna tower.
- c. Parallel, perpendicular, and ground-parallel orientations of the antenna are set to make the measurement.
- d. For each suspected emission, the EUT was arranged to its worst case and the rotatable table was turned from 0 degrees to 360 degrees to find the maximum reading.
- e. The test-receiver system was set to Quasi-Peak Detect Function and Specified Bandwidth with Maximum Hold Mode.

##### **Note:**

1. The resolution bandwidth and video bandwidth of test receiver/spectrum analyzer is 9 kHz at frequency below 30 MHz.

##### **For Radiated Emission above 30 MHz**

- a. The EUT was placed on the top of a rotating table 0.8 meters (for 30 MHz ~ 1 GHz) / 1.5 meters (for above 1 GHz) above the ground at 3 meter chamber room for test. The table was rotated 360 degrees to determine the position of the highest radiation.
- b. The EUT was set 3 meters away from the interference-receiving antenna, which was mounted on the top of a variable-height antenna tower.
- c. The height of antenna is varied from one meter to four meters above the ground to determine the maximum value of the field strength. Both horizontal and vertical polarizations of the antenna are set to make the measurement.
- d. For each suspected emission, the EUT was arranged to its worst case and then the antenna was tuned to heights from 1 meter to 4 meters and the rotatable table was turned from 0 degrees to 360 degrees to find the maximum reading.
- e. The test-receiver system was set to quasi-peak detect function and specified bandwidth with maximum hold mode when the test frequency is below 1 GHz.
- f. The test-receiver system was set to peak and average detected function and specified bandwidth with maximum hold mode when the test frequency is above 1 GHz. If the peak reading value also meets average limit, measurement with the average detector is unnecessary.

##### **Note:**

1. The resolution bandwidth and video bandwidth of test receiver/spectrum analyzer is 120 kHz for Quasi-peak detection (QP) at frequency below 1 GHz.
2. The resolution bandwidth of test receiver/spectrum analyzer is 1 MHz and the video bandwidth is 3 MHz for Peak detection (PK) at frequency above 1 GHz.
3. The resolution bandwidth of test receiver/spectrum analyzer is 1 MHz and the video bandwidth is  $\geq 1/T$  (Duty cycle < 98 %) or 10 Hz (Duty cycle  $\geq 98$  %) for Average detection (AV) at frequency above 1 GHz.  
(11b: RBW = 1 MHz, VBW = 1 kHz ; 11g: RBW = 1 MHz, VBW = 1 kHz ;  
11n (HT20): RBW = 1 MHz, VBW = 1 kHz)
4. All modes of operation were investigated and the worst-case emissions are reported.

#### 4.1.4 Deviation from Test Standard

No deviation.



4.1.5 Test Set Up

<Radiated Emission below 30 MHz>

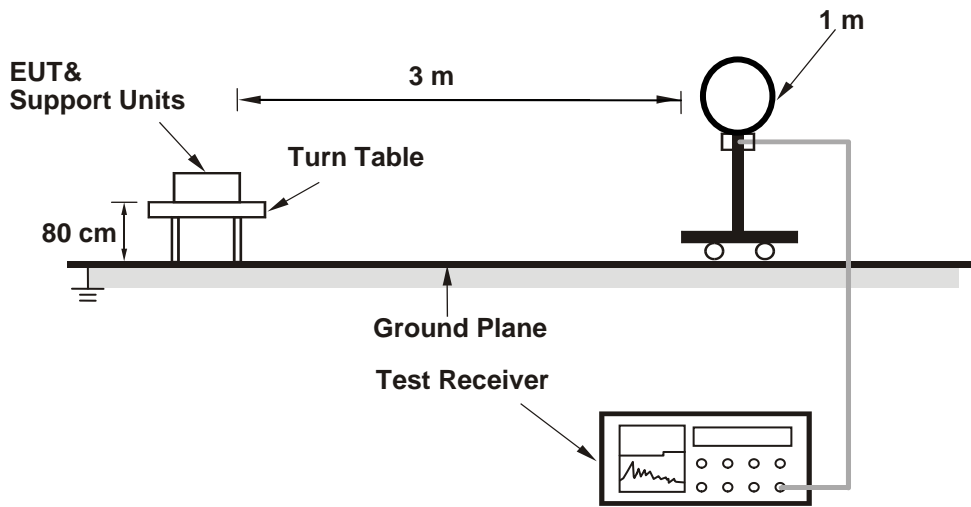

<Radiated Emission 30 MHz to 1 GHz>

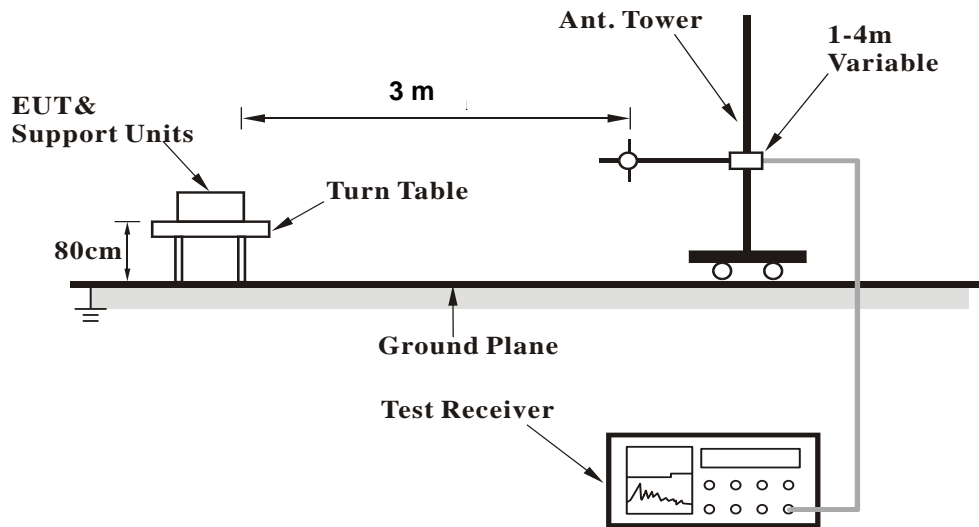

### <Radiated Emission above 1 GHz>

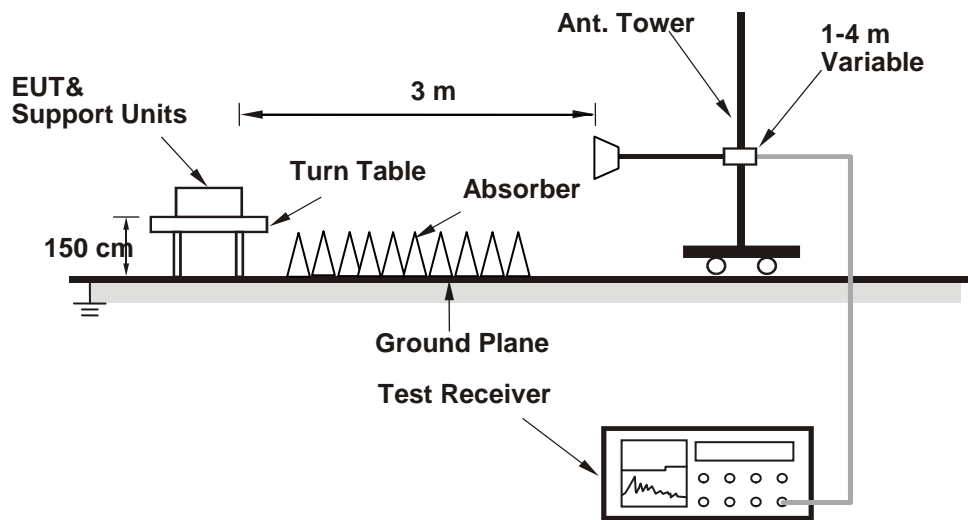

For the actual test configuration, please refer to the attached file (Test Setup Photo).

#### 4.1.6 EUT Operating Conditions

- Placed the EUT on a testing table.
- Use the software to control the EUT under transmission condition continuously at specific channel frequency.

4.1.7 Test Results

Above 1 GHz Data :  
802.11b

EUT Test Condition		Measurement Detail	
Channel	Channel 1	Frequency Range	1 GHz ~ 25 GHz
Input Power	120 Vac, 60 Hz	Detector Function	Peak (PK) Average (AV)
Environmental Conditions	25 deg. C, 65 % RH	Tested By	Charles Hsiao

Antennal Polarity & Test Distance: Horizontal at 3 m										
Frequency (MHz)	Emission Level (dBuV/m)	Read Level (dBuV)	Limit (dBuV/m)	Margin (dB)	Antenna Factor (dB/m)	Cable Loss (dB)	Preamp Factor (dB)	Antenna Height (cm)	Table Angle (Degree)	Remark
2389.29	40.4	38.69	54	-13.6	31.8	5.4	35.49	131	342	Average
2389.29	51.9	50.19	74	-22.1	31.8	5.4	35.49	131	342	Peak
2412	103.51	101.74			31.81	5.43	35.47	131	342	Average
2412	105.75	103.98			31.81	5.43	35.47	131	342	Peak
4824	40.01	31.88	54	-13.99	33.97	8.26	34.1	142	9	Average
4824	48.42	40.29	74	-25.58	33.97	8.26	34.1	142	9	Peak

Antennal Polarity & Test Distance: Vertical at 3 m										
Frequency (MHz)	Emission Level (dBuV/m)	Read Level (dBuV)	Limit (dBuV/m)	Margin (dB)	Antenna Factor (dB/m)	Cable Loss (dB)	Preamp Factor (dB)	Antenna Height (cm)	Table Angle (Degree)	Remark
2389.11	40.54	38.83	54	-13.46	31.8	5.4	35.49	113	265	Average
2389.11	51.49	49.78	74	-22.51	31.8	5.4	35.49	113	265	Peak
2412	101.61	99.84			31.81	5.43	35.47	113	265	Average
2412	103.86	102.09			31.81	5.43	35.47	113	265	Peak
4824	39.72	31.59	54	-14.28	33.97	8.26	34.1	128	300	Average
4824	47.13	39	74	-26.87	33.97	8.26	34.1	128	300	Peak

Remarks:

- Emission Level = Read Level + Antenna Factor + Cable Loss - Preamp Factor  
Margin value = Emission level – Limit value
- 2412 MHz: Fundamental frequency.
- The emission levels of other frequencies were very low against the limit.

EUT Test Condition		Measurement Detail	
Channel	Channel 6	Frequency Range	1 GHz ~ 25 GHz
Input Power	120 Vac, 60 Hz	Detector Function	Peak (PK) Average (AV)
Environmental Conditions	25 deg. C, 65 % RH	Tested By	Charles Hsiao

Antennal Polarity & Test Distance: Horizontal at 3 m										
Frequency (MHz)	Emission Level (dBuV/m)	Read Level (dBuV)	Limit (dBuV/m)	Margin (dB)	Antenna Factor (dB/m)	Cable Loss (dB)	Preamp Factor (dB)	Antenna Height (cm)	Table Angle (Degree)	Remark
2340.87	40.39	38.82	54	-13.61	31.74	5.33	35.5	100	242	Average
2340.87	51.84	50.27	74	-22.16	31.74	5.33	35.5	100	242	Peak
2437	101.7	99.85			31.85	5.46	35.46	100	242	Average
2437	104.16	102.31			31.85	5.46	35.46	100	242	Peak
2492.12	40.92	38.9	54	-13.08	31.9	5.53	35.41	100	242	Average
2492.12	51.96	49.94	74	-22.04	31.9	5.53	35.41	100	242	Peak
4874	40.18	31.99	54	-13.82	33.98	8.27	34.06	147	46	Average
4874	46.63	38.44	74	-27.37	33.98	8.27	34.06	147	46	Peak
Antennal Polarity & Test Distance: Vertical at 3 m										
Frequency (MHz)	Emission Level (dBuV/m)	Read Level (dBuV)	Limit (dBuV/m)	Margin (dB)	Antenna Factor (dB/m)	Cable Loss (dB)	Preamp Factor (dB)	Antenna Height (cm)	Table Angle (Degree)	Remark
2389.92	40.35	38.62	54	-13.65	31.8	5.4	35.47	101	228	Average
2389.92	51.79	50.06	74	-22.21	31.8	5.4	35.47	101	228	Peak
2437	98.59	96.74			31.85	5.46	35.46	101	228	Average
2437	101.05	99.2			31.85	5.46	35.46	101	228	Peak
2499.56	40.88	38.86	54	-13.12	31.9	5.53	35.41	101	228	Average
2499.56	51.76	49.74	74	-22.24	31.9	5.53	35.41	101	228	Peak
4874	39.72	31.53	54	-14.28	33.98	8.27	34.06	112	258	Average
4874	46.81	38.62	74	-27.19	33.98	8.27	34.06	112	258	Peak

Remarks:

1. Emission Level = Read Level + Antenna Factor + Cable Loss - Preamp Factor  
Margin value = Emission level – Limit value
2. 2437 MHz: Fundamental frequency.
3. The emission levels of other frequencies were very low against the limit.

EUT Test Condition		Measurement Detail	
Channel	Channel 11	Frequency Range	1 GHz ~ 25 GHz
Input Power	120 Vac, 60 Hz	Detector Function	Peak (PK) Average (AV)
Environmental Conditions	25 deg. C, 65 % RH	Tested By	Charles Hsiao

Antennal Polarity & Test Distance: Horizontal at 3 m										
Frequency (MHz)	Emission Level (dBuV/m)	Read Level (dBuV)	Limit (dBuV/m)	Margin (dB)	Antenna Factor (dB/m)	Cable Loss (dB)	Preamp Factor (dB)	Antenna Height (cm)	Table Angle (Degree)	Remark
2462	101.47	99.54			31.87	5.5	35.44	100	242	Average
2462	104.72	102.79			31.87	5.5	35.44	100	242	Peak
2483.84	40.96	39	54	-13.04	31.88	5.5	35.42	100	242	Average
2483.84	52.93	50.97	74	-21.07	31.88	5.5	35.42	100	242	Peak
4924	39.87	31.62	54	-14.13	33.99	8.28	34.02	124	333	Average
4924	46.91	38.66	74	-27.09	33.99	8.28	34.02	124	333	Peak
Antennal Polarity & Test Distance: Vertical at 3 m										
Frequency (MHz)	Emission Level (dBuV/m)	Read Level (dBuV)	Limit (dBuV/m)	Margin (dB)	Antenna Factor (dB/m)	Cable Loss (dB)	Preamp Factor (dB)	Antenna Height (cm)	Table Angle (Degree)	Remark
2462	98.65	96.72			31.87	5.5	35.44	101	228	Average
2462	101.06	99.13			31.87	5.5	35.44	101	228	Peak
2483.72	40.94	38.98	54	-13.06	31.88	5.5	35.42	101	228	Average
2483.72	52.58	50.62	74	-21.42	31.88	5.5	35.42	101	228	Peak
4924	39.81	31.56	54	-14.19	33.99	8.28	34.02	133	346	Average
4924	48.12	39.87	74	-25.88	33.99	8.28	34.02	133	346	Peak

Remarks:

- Emission Level = Read Level + Antenna Factor + Cable Loss - Preamp Factor  
Margin value = Emission level – Limit value
- 2462 MHz: Fundamental frequency.
- The emission levels of other frequencies were very low against the limit.

802.11g

EUT Test Condition		Measurement Detail	
Channel	Channel 1	Frequency Range	1 GHz ~ 25 GHz
Input Power	120 Vac, 60 Hz	Detector Function	Peak (PK) Average (AV)
Environmental Conditions	25 deg. C, 65 % RH	Tested By	Charles Hsiao

Antennal Polarity & Test Distance: Horizontal at 3 m										
Frequency (MHz)	Emission Level (dBuV/m)	Read Level (dBuV)	Limit (dBuV/m)	Margin (dB)	Antenna Factor (dB/m)	Cable Loss (dB)	Preamp Factor (dB)	Antenna Height (cm)	Table Angle (Degree)	Remark
2389.83	40.45	38.72	54	-13.55	31.8	5.4	35.47	131	342	Average
2389.83	51.21	49.48	74	-22.79	31.8	5.4	35.47	131	342	Peak
2412	97.52	95.75			31.81	5.43	35.47	131	342	Average
2412	105.93	104.16			31.81	5.43	35.47	131	342	Peak
4824	39.75	31.62	54	-14.25	33.97	8.26	34.1	155	134	Average
4824	47.23	39.1	74	-26.77	33.97	8.26	34.1	155	134	Peak

Antennal Polarity & Test Distance: Vertical at 3 m										
Frequency (MHz)	Emission Level (dBuV/m)	Read Level (dBuV)	Limit (dBuV/m)	Margin (dB)	Antenna Factor (dB/m)	Cable Loss (dB)	Preamp Factor (dB)	Antenna Height (cm)	Table Angle (Degree)	Remark
2389.65	40.72	39.01	54	-13.28	31.8	5.4	35.49	113	265	Average
2389.65	52.03	50.32	74	-21.97	31.8	5.4	35.49	113	265	Peak
2412	94.57	92.8			31.81	5.43	35.47	113	265	Average
2412	103.14	101.37			31.81	5.43	35.47	113	265	Peak
4824	39.9	31.77	54	-14.1	33.97	8.26	34.1	109	210	Average
4824	46.21	38.08	74	-27.79	33.97	8.26	34.1	109	210	Peak

Remarks:

- Emission Level = Read Level + Antenna Factor + Cable Loss - Preamp Factor  
Margin value = Emission level – Limit value
- 2412 MHz: Fundamental frequency.
- The emission levels of other frequencies were very low against the limit.

EUT Test Condition		Measurement Detail	
Channel	Channel 6	Frequency Range	1 GHz ~ 25 GHz
Input Power	120 Vac, 60 Hz	Detector Function	Peak (PK) Average (AV)
Environmental Conditions	25 deg. C, 65 % RH	Tested By	Charles Hsiao

Antennal Polarity & Test Distance: Horizontal at 3 m										
Frequency (MHz)	Emission Level (dBuV/m)	Read Level (dBuV)	Limit (dBuV/m)	Margin (dB)	Antenna Factor (dB/m)	Cable Loss (dB)	Preamp Factor (dB)	Antenna Height (cm)	Table Angle (Degree)	Remark
2378.85	51.48	49.82	74	-22.52	31.78	5.37	35.49	100	242	Peak
2378.85	39.97	38.31	54	-14.03	31.78	5.37	35.49	100	242	Peak
2437	97.49	95.64			31.85	5.46	35.46	100	242	Average
2437	104.46	102.61			31.85	5.46	35.46	100	242	Peak
2483.6	41.39	39.43	54	-12.61	31.88	5.5	35.42	100	242	Average
2483.6	52.17	50.21	74	-21.83	31.88	5.5	35.42	100	242	Peak
4874	39.85	31.66	54	-14.15	33.98	8.27	34.06	100	360	Average
4874	46.59	38.4	74	-27.41	33.98	8.27	34.06	100	360	Peak
Antennal Polarity & Test Distance: Vertical at 3 m										
Frequency (MHz)	Emission Level (dBuV/m)	Read Level (dBuV)	Limit (dBuV/m)	Margin (dB)	Antenna Factor (dB/m)	Cable Loss (dB)	Preamp Factor (dB)	Antenna Height (cm)	Table Angle (Degree)	Remark
2389.74	40.75	39.04	54	-13.25	31.8	5.4	35.49	101	228	Average
2389.74	51.48	49.77	74	-22.52	31.8	5.4	35.49	101	228	Peak
2437	94.55	92.7			31.85	5.46	35.46	101	228	Average
2437	101.06	99.21			31.85	5.46	35.46	101	228	Peak
2483.8	40.98	39.02	54	-13.02	31.88	5.5	35.42	101	228	Average
2483.8	52.42	50.46	74	-21.58	31.88	5.5	35.42	101	228	Peak
4874	39.97	31.78	54	-14.03	33.98	8.27	34.06	133	360	Average
4874	46.98	38.79	74	-27.02	33.98	8.27	34.06	133	360	Peak

Remarks:

- Emission Level = Read Level + Antenna Factor + Cable Loss - Preamp Factor  
Margin value = Emission level – Limit value
- 2437 MHz: Fundamental frequency.
- The emission levels of other frequencies were very low against the limit.

EUT Test Condition		Measurement Detail	
Channel	Channel 11	Frequency Range	1 GHz ~ 25 GHz
Input Power	120 Vac, 60 Hz	Detector Function	Peak (PK) Average (AV)
Environmental Conditions	25 deg. C, 65 % RH	Tested By	Charles Hsiao

Antennal Polarity & Test Distance: Horizontal at 3 m										
Frequency (MHz)	Emission Level (dBuV/m)	Read Level (dBuV)	Limit (dBuV/m)	Margin (dB)	Antenna Factor (dB/m)	Cable Loss (dB)	Preamp Factor (dB)	Antenna Height (cm)	Table Angle (Degree)	Remark
2462	97.66	95.73			31.87	5.5	35.44	100	242	Average
2462	104.38	102.45			31.87	5.5	35.44	100	242	Peak
2483.84	41.64	39.68	54	-12.36	31.88	5.5	35.42	100	242	Average
2483.84	52.41	50.45	74	-21.59	31.88	5.5	35.42	100	242	Peak
4924	39.9	31.65	54	-14.1	33.99	8.28	34.02	139	146	Average
4924	49.36	41.11	74	-24.64	33.99	8.28	34.02	139	146	Peak
Antennal Polarity & Test Distance: Vertical at 3 m										
Frequency (MHz)	Emission Level (dBuV/m)	Read Level (dBuV)	Limit (dBuV/m)	Margin (dB)	Antenna Factor (dB/m)	Cable Loss (dB)	Preamp Factor (dB)	Antenna Height (cm)	Table Angle (Degree)	Remark
2462	94.56	92.63			31.87	5.5	35.44	101	228	Average
2462	101.04	99.11			31.87	5.5	35.44	101	228	Peak
2497.36	41.09	39.07	54	-12.91	31.9	5.53	35.41	101	228	Average
2497.36	52.05	50.03	74	-21.95	31.9	5.53	35.41	101	228	Peak
4924	39.86	31.61	54	-14.14	33.99	8.28	34.02	147	211	Average
4924	47.08	38.83	74	-26.92	33.99	8.28	34.02	147	211	Peak

Remarks:

- Emission Level = Read Level + Antenna Factor + Cable Loss - Preamp Factor  
Margin value = Emission level – Limit value
- 2462 MHz: Fundamental frequency.
- The emission levels of other frequencies were very low against the limit.



802.11n (HT20)

EUT Test Condition		Measurement Detail	
Channel	Channel 1	Frequency Range	1 GHz ~ 25 GHz
Input Power	120 Vac, 60 Hz	Detector Function	Peak (PK) Average (AV)
Environmental Conditions	25 deg. C, 65 % RH	Tested By	Charles Hsiao

**Antennal Polarity & Test Distance: Horizontal at 3 m**

Frequency (MHz)	Emission Level (dBuV/m)	Read Level (dBuV)	Limit (dBuV/m)	Margin (dB)	Antenna Factor (dB/m)	Cable Loss (dB)	Preamp Factor (dB)	Antenna Height (cm)	Table Angle (Degree)	Remark
2389.11	40.67	38.96	54	-13.33	31.8	5.4	35.49	131	342	Average
2389.11	51.73	50.02	74	-22.27	31.8	5.4	35.49	131	342	Peak
2412	93.97	92.2			31.81	5.43	35.47	131	342	Average
2412	102.45	100.68			31.81	5.43	35.47	131	342	Peak
4824	39.53	31.4	54	-14.47	33.97	8.26	34.1	157	8	Average
4824	47.6	39.47	74	-26.4	33.97	8.26	34.1	157	8	Peak

**Antennal Polarity & Test Distance: Vertical at 3 m**

Frequency (MHz)	Emission Level (dBuV/m)	Read Level (dBuV)	Limit (dBuV/m)	Margin (dB)	Antenna Factor (dB/m)	Cable Loss (dB)	Preamp Factor (dB)	Antenna Height (cm)	Table Angle (Degree)	Remark
2389.2	40.83	39.12	54	-13.17	31.8	5.4	35.49	113	265	Average
2389.2	51.77	50.06	74	-22.23	31.8	5.4	35.49	113	265	Peak
2412	94.14	92.37			31.81	5.43	35.47	113	265	Average
2412	102.52	100.75			31.81	5.43	35.47	113	265	Peak
4824	40	31.87	54	-14	33.97	8.26	34.1	192	269	Average
4824	47.19	39.06	74	-26.81	33.97	8.26	34.1	192	269	Peak

Remarks:

- Emission Level = Read Level + Antenna Factor + Cable Loss - Preamp Factor  
Margin value = Emission level – Limit value
- 2412 MHz: Fundamental frequency.
- The emission levels of other frequencies were very low against the limit.

EUT Test Condition		Measurement Detail	
Channel	Channel 6	Frequency Range	1 GHz ~ 25 GHz
Input Power	120 Vac, 60 Hz	Detector Function	Peak (PK) Average (AV)
Environmental Conditions	25 deg. C, 65 % RH	Tested By	Charles Hsiao

Antennal Polarity & Test Distance: Horizontal at 3 m										
Frequency (MHz)	Emission Level (dBuV/m)	Read Level (dBuV)	Limit (dBuV/m)	Margin (dB)	Antenna Factor (dB/m)	Cable Loss (dB)	Preamp Factor (dB)	Antenna Height (cm)	Table Angle (Degree)	Remark
2384.7	40.35	38.66	54	-13.65	31.78	5.4	35.49	100	242	Average
2384.7	51.82	50.13	74	-22.18	31.78	5.4	35.49	100	242	Peak
2437	96.65	94.8			31.85	5.46	35.46	100	242	Average
2437	103.1	101.25			31.85	5.46	35.46	100	242	Peak
2484.68	41.36	39.37	54	-12.64	31.88	5.53	35.42	100	242	Average
2484.68	53.23	51.24	74	-20.77	31.88	5.53	35.42	100	242	Peak
4874	39.74	31.55	54	-14.26	33.98	8.27	34.06	175	230	Average
4874	46.73	38.54	74	-27.27	33.98	8.27	34.06	175	230	Peak
Antennal Polarity & Test Distance: Vertical at 3 m										
Frequency (MHz)	Emission Level (dBuV/m)	Read Level (dBuV)	Limit (dBuV/m)	Margin (dB)	Antenna Factor (dB/m)	Cable Loss (dB)	Preamp Factor (dB)	Antenna Height (cm)	Table Angle (Degree)	Remark
2389.92	40.51	38.78	54	-13.49	31.8	5.4	35.47	101	228	Average
2389.92	52.3	50.57	74	-21.7	31.8	5.4	35.47	101	228	Peak
2437	93.64	91.79			31.85	5.46	35.46	101	228	Average
2437	100.71	98.86			31.85	5.46	35.46	101	228	Peak
2498.4	40.94	38.92	54	-13.06	31.9	5.53	35.41	101	228	Average
2498.4	51.82	49.8	74	-22.18	31.9	5.53	35.41	101	228	Peak
4874	39.78	31.59	54	-14.22	33.98	8.27	34.06	133	349	Average
4874	46.58	38.39	74	-27.42	33.98	8.27	34.06	133	349	Peak

Remarks:

- Emission Level = Read Level + Antenna Factor + Cable Loss - Preamp Factor  
Margin value = Emission level – Limit value
- 2437 MHz: Fundamental frequency.
- The emission levels of other frequencies were very low against the limit.

EUT Test Condition		Measurement Detail	
Channel	Channel 11	Frequency Range	1 GHz ~ 25 GHz
Input Power	120 Vac, 60 Hz	Detector Function	Peak (PK) Average (AV)
Environmental Conditions	25 deg. C, 65 % RH	Tested By	Charles Hsiao

Antennal Polarity & Test Distance: Horizontal at 3 m										
Frequency (MHz)	Emission Level (dBuV/m)	Read Level (dBuV)	Limit (dBuV/m)	Margin (dB)	Antenna Factor (dB/m)	Cable Loss (dB)	Preamp Factor (dB)	Antenna Height (cm)	Table Angle (Degree)	Remark
2462	96.36	94.43			31.87	5.5	35.44	100	242	Average
2462	103.02	101.09			31.87	5.5	35.44	100	242	Peak
2483.68	41.76	39.8	54	-12.24	31.88	5.5	35.42	100	242	Average
2483.68	52.92	50.96	74	-21.08	31.88	5.5	35.42	100	242	Peak
4924	40.19	31.94	54	-13.81	33.99	8.28	34.02	124	159	Average
4924	47.22	38.97	74	-26.78	33.99	8.28	34.02	124	159	Peak
Antennal Polarity & Test Distance: Vertical at 3 m										
Frequency (MHz)	Emission Level (dBuV/m)	Read Level (dBuV)	Limit (dBuV/m)	Margin (dB)	Antenna Factor (dB/m)	Cable Loss (dB)	Preamp Factor (dB)	Antenna Height (cm)	Table Angle (Degree)	Remark
2462	93.18	91.25			31.87	5.5	35.44	101	228	Average
2462	100.42	98.49			31.87	5.5	35.44	101	228	Peak
2483.72	41.31	39.35	54	-12.69	31.88	5.5	35.42	101	228	Average
2483.72	52.49	50.53	74	-21.51	31.88	5.5	35.42	101	228	Peak
4924	39.71	31.46	54	-14.29	33.99	8.28	34.02	124	222	Average
4924	48	39.75	74	-26	33.99	8.28	34.02	124	222	Peak

Remarks:

- Emission Level = Read Level + Antenna Factor + Cable Loss - Preamp Factor  
Margin value = Emission level – Limit value
- 2462 MHz: Fundamental frequency.
- The emission levels of other frequencies were very low against the limit.

**9 kHz ~ 30 MHz Data:**

The amplitude of spurious emissions attenuated more than 20 dB below the permissible value is not required to be report.

**30 MHz ~ 1 GHz Worst-Case Data:**

**802.11n (HT20)**

EUT Test Condition		Measurement Detail	
Channel	Channel 11	Frequency Range	30 MHz ~ 1 GHz
Input Power	120 Vac, 60 Hz	Detector Function	Peak (PK)
Environmental Conditions	25 deg. C, 65 % RH	Tested By	Charles Hsiao

**Horizontal**

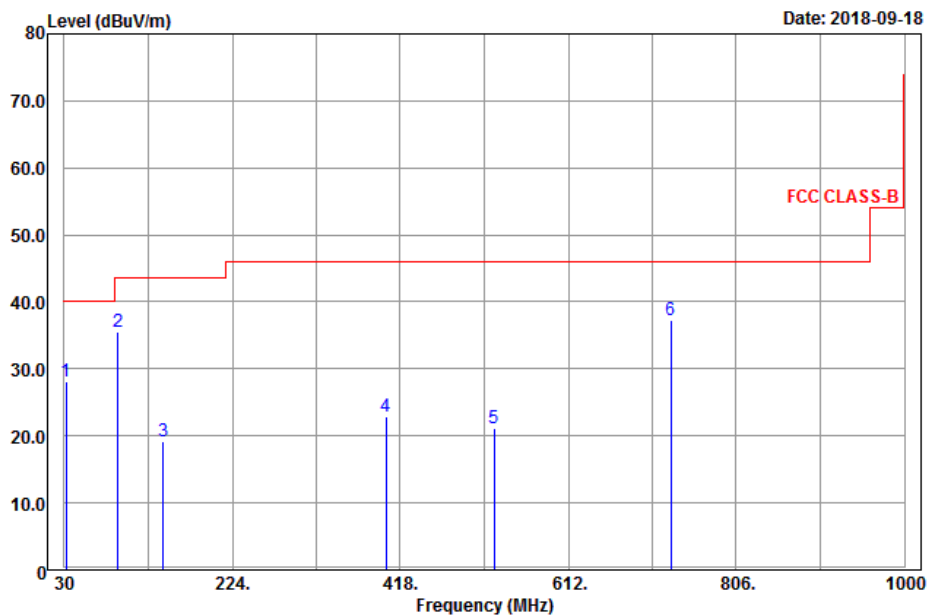

**Vertical**

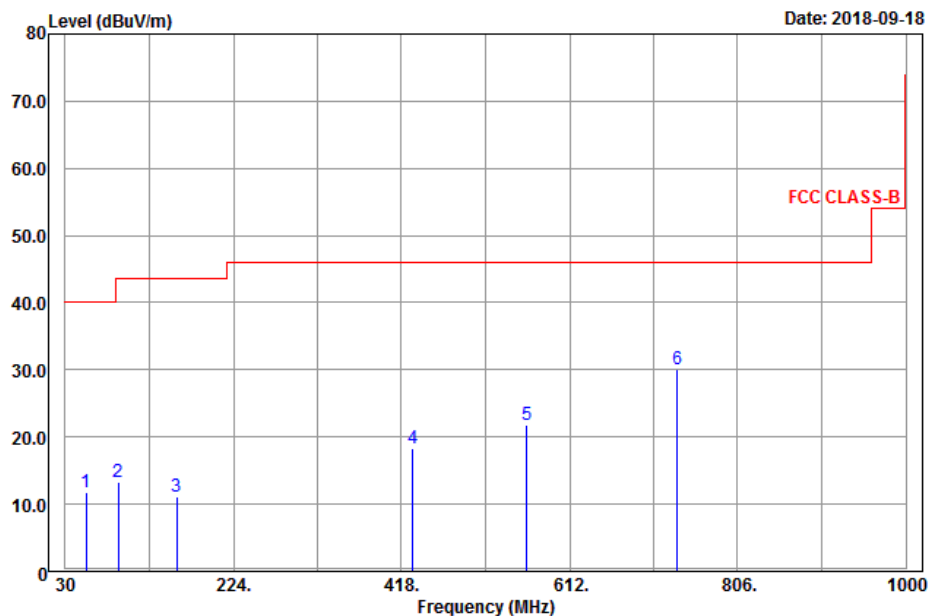

**Antennal Polarity & Test Distance: Horizontal at 3 m**

Frequency (MHz)	Emission Level (dBuV/m)	Read Level (dBuV)	Limit (dBuV/m)	Margin (dB)	Antenna Factor (dB/m)	Cable Loss (dB)	Preamp Factor (dB)	Antenna Height (cm)	Table Angle (Degree)	Remark
31.89	28.15	43.34	40	-11.85	16.33	0.74	32.26	166	198	Peak
91.83	35.57	57.22	43.5	-7.93	9.06	1.11	31.82	105	187	Peak
144.48	19.21	40.43	43.5	-24.29	9.67	1.38	32.27	102	144	Peak
401.5	22.83	34.65	46	-23.17	18.06	2.34	32.22	122	136	Peak
526.8	21.25	30.04	46	-24.75	20.66	2.7	32.15	101	145	Peak
730.5	37.2	42.79	46	-8.8	23.37	3.16	32.12	101	147	Peak

**Antennal Polarity & Test Distance: Vertical at 3 m**

Frequency (MHz)	Emission Level (dBuV/m)	Read Level (dBuV)	Limit (dBuV/m)	Margin (dB)	Antenna Factor (dB/m)	Cable Loss (dB)	Preamp Factor (dB)	Antenna Height (cm)	Table Angle (Degree)	Remark
54.3	11.8	35.77	40	-28.2	7.36	0.9	32.23	115	195	Peak
90.75	13.23	34.91	43.5	-30.27	8.98	1.11	31.77	148	147	Peak
158.79	11.08	31.09	43.5	-32.42	10.74	1.52	32.27	112	154	Peak
430.9	18.22	30.21	46	-27.78	17.78	2.41	32.18	102	132	Peak
562.5	21.75	30.93	46	-24.25	20.2	2.82	32.2	162	195	Peak
736.8	30.18	35.85	46	-15.82	23.3	3.16	32.13	147	188	Peak

**Remarks:**

- Emission Level = Read Level + Antenna Factor + Cable Loss - Preamp Factor  
Margin value = Emission level – Limit value.
- The emission levels of other frequencies were very low against the limit.

## 4.2 Conducted Emission Measurement

### 4.2.1 Limits of Conducted Emission Measurement

Frequency (MHz)	Conducted Limit (dBuV)	
	Quasi-Peak	Average
0.15 - 0.5	66 - 56	56 - 46
0.50 - 5.0	56	46
5.0 - 30.0	60	50

- Note: 1. The lower limit shall apply at the transition frequencies.  
 2. The limit decreases in line with the logarithm of the frequency in the range of 0.15 to 0.50 MHz.

### 4.2.2 Test Instruments

Description & Manufacturer	Model No.	Serial No.	Date of Calibration	Due Date of Calibration
Test Receiver ROHDE & SCHWARZ	ESCI	100613	Nov. 23, 2017	Nov. 22, 2018
RF signal cable Woken	5D-FB	Cable-cond1-01	Sep. 05, 2018	Sep. 04, 2019
LISN/AMN ROHDE & SCHWARZ (EUT)	ENV216	101826	Feb. 26, 2018	Feb. 25, 2019
LISN/AMN ROHDE & SCHWARZ (Peripheral)	ESH3-Z5	100311	Aug. 19, 2018	Aug. 18, 2019
Software ADT	BV ADT_Cond_ V7.3.7.4	NA	NA	NA

- Note: 1. The calibration interval of the above test instruments is 12 months and the calibrations are traceable to NML/ROC and NIST/USA.  
 2. The test was performed in HwaYa Shielded Room 1.  
 3. The VCCI Site Registration No. is C-2040.

#### 4.2.3 Test Procedures

- a. The EUT was placed 0.4 meters from the conducting wall of the shielded room with EUT being connected to the power mains through a line impedance stabilization network (LISN). Other support units were connected to the power mains through another LISN. The two LISNs provide 50 ohm/50 uH of coupling impedance for the measuring instrument.
- b. Both lines of the power mains connected to the EUT were checked for maximum conducted interference.
- c. The frequency range from 150 kHz to 30 MHz was searched. Emission levels under (Limit – 20 dB) was not recorded.

**Note:** The resolution bandwidth and video bandwidth of test receiver is 9 kHz for quasi-peak detection (QP) and average detection (AV) at frequency 0.15 MHz – 30 MHz.

#### 4.2.4 Deviation from Test Standard

No deviation.

#### 4.2.5 Test Setup

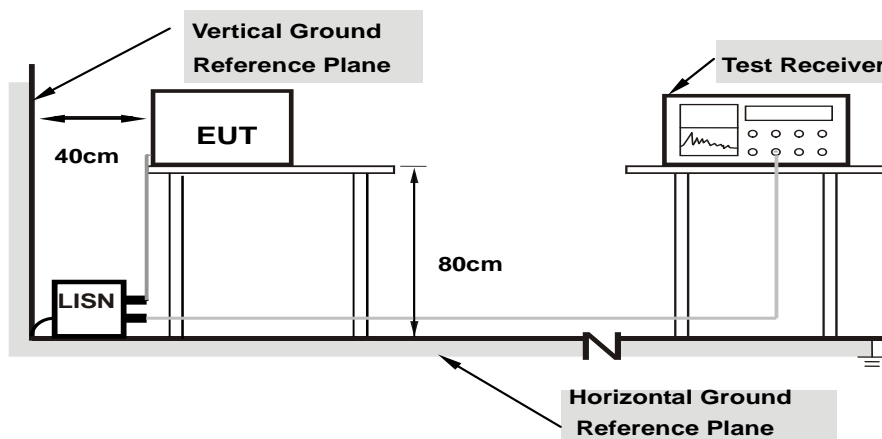

**Note:** 1.Support units were connected to second LISN.

For the actual test configuration, please refer to the attached file (Test Setup Photo).

#### 4.2.6 EUT Operating Conditions

- a. Placed the EUT on a testing table.
- b. Use the software to control the EUT under transmission condition continuously at specific channel frequency.

#### 4.2.7 Test Results

Frequency Range	150kHz ~ 30MHz	Detector Function & Resolution Bandwidth	Quasi-Peak (QP) / Average (AV), 9kHz
Input Power	120Vac, 60Hz	Environmental Conditions	25°C, 65%RH
Tested by	Jisyong Wang	Test Date	2018/9/13

Phase Of Power : Line (L)										
No	Frequency (MHz)	Correction Factor (dB)	Reading Value (dBuV)		Emission Level (dBuV)		Limit (dBuV)		Margin (dB)	
			Q.P.	AV.	Q.P.	AV.	Q.P.	AV.	Q.P.	AV.
1	0.16564	9.67	32.93	17.50	42.60	27.17	65.18	55.18	-22.58	-28.01
2	0.19301	9.67	32.17	18.69	41.84	28.36	63.91	53.91	-22.07	-25.55
3	0.22024	9.67	27.91	13.83	37.58	23.50	62.81	52.81	-25.23	-29.31
4	0.61138	9.66	31.68	15.83	41.34	25.49	56.00	46.00	-14.66	-20.51
5	15.01582	9.89	30.22	17.81	40.11	27.70	60.00	50.00	-19.89	-22.30
6	17.52995	9.90	25.84	10.43	35.74	20.33	60.00	50.00	-24.26	-29.67

Remarks:

1. Q.P. and AV. are abbreviations of quasi-peak and average individually.
2. The emission levels of other frequencies were very low against the limit.
3. Margin value = Emission level – Limit value
4. Correction factor = Insertion loss + Cable loss
5. Emission Level = Correction Factor + Reading Value

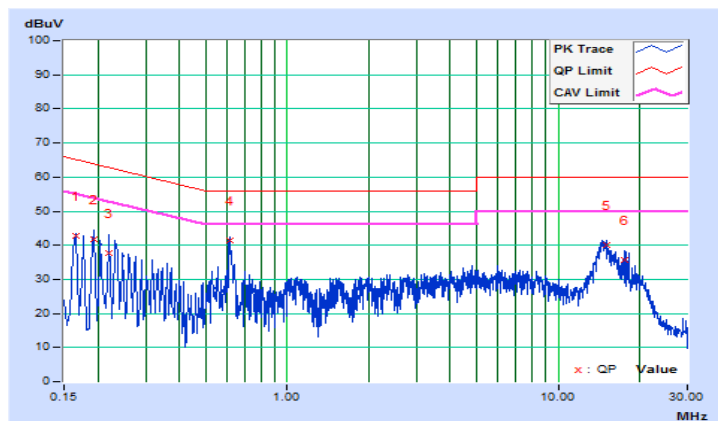



Frequency Range	150kHz ~ 30MHz	Detector Function & Resolution Bandwidth	Quasi-Peak (QP) / Average (AV), 9kHz
Input Power	120Vac, 60Hz	Environmental Conditions	25°C, 65%RH
Tested by	Jisyong Wang	Test Date	2018/9/13

Phase Of Power : Neutral (N)										
No	Frequency (MHz)	Correction Factor (dB)	Reading Value (dBuV)		Emission Level (dBuV)		Limit (dBuV)		Margin (dB)	
			Q.P.	AV.	Q.P.	AV.	Q.P.	AV.	Q.P.	AV.
1	0.15391	9.68	26.66	8.43	36.34	18.11	65.79	55.79	-29.45	-37.68
2	0.18122	9.67	19.00	2.16	28.67	11.83	64.43	54.43	-35.76	-42.60
3	0.19717	9.67	17.90	0.74	27.57	10.41	63.73	53.73	-36.16	-43.32
4	0.29467	9.67	12.28	1.26	21.95	10.93	60.39	50.39	-38.44	-39.46
5	0.61529	9.66	19.91	5.52	29.57	15.18	56.00	46.00	-26.43	-30.82
6	14.35503	9.93	21.54	6.53	31.47	16.46	60.00	50.00	-28.53	-33.54

Remarks:

1. Q.P. and AV. are abbreviations of quasi-peak and average individually.
2. The emission levels of other frequencies were very low against the limit.
3. Margin value = Emission level – Limit value
4. Correction factor = Insertion loss + Cable loss
5. Emission Level = Correction Factor + Reading Value

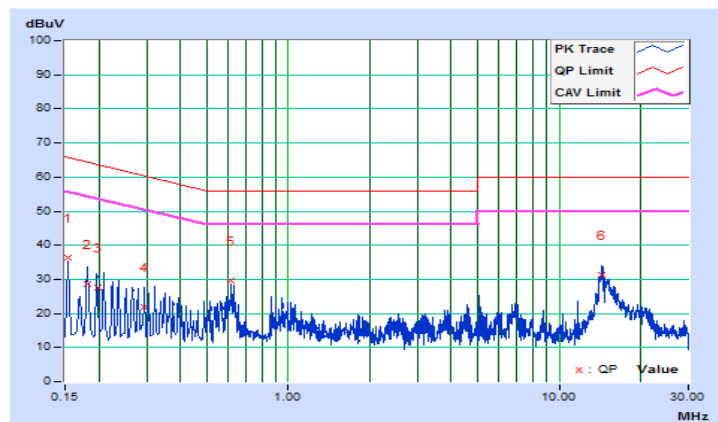

### 4.3 6 dB Bandwidth Measurement

#### 4.3.1 Limits of 6 dB Bandwidth Measurement

The minimum of 6 dB Bandwidth Measurement is 0.5 MHz.

#### 4.3.2 Test Setup

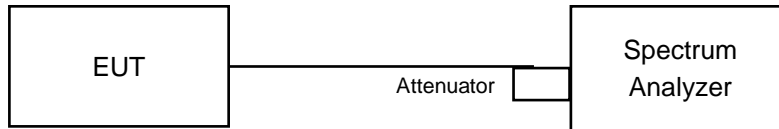

#### 4.3.3 Test Instruments

Refer to section 4.1.2 to get information of above instrument.

#### 4.3.4 Test Procedure

- Set resolution bandwidth (RBW) = 100 kHz
- Set the video bandwidth (VBW)  $\geq 3 \times$  RBW, Detector = Peak.
- Trace mode = max hold.
- Sweep = auto couple.
- Measure the maximum width of the emission that is constrained by the frequencies associated with the two amplitude points (upper and lower) that are attenuated by 6 dB relative to the maximum level measured in the fundamental emission

#### 4.3.5 Deviation from Test Standard

No deviation.

#### 4.3.6 EUT Operating Conditions

The software provided by client to enable the EUT under transmission condition continuously at lowest, middle and highest channel frequencies individually.

#### 4.3.7 Test Results

##### 802.11b

Channel	Frequency (MHz)	6 dB Bandwidth (MHz)	Minimum Limit (MHz)	Pass / Fail
1	2412	7.11	0.5	Pass
6	2437	7.57	0.5	Pass
11	2462	7.11	0.5	Pass

##### 802.11g

Channel	Frequency (MHz)	6 dB Bandwidth (MHz)	Minimum Limit (MHz)	Pass / Fail
1	2412	15.73	0.5	Pass
6	2437	15.68	0.5	Pass
11	2462	15.50	0.5	Pass

##### 802.11n (HT20)

Channel	Frequency (MHz)	6 dB Bandwidth (MHz)	Minimum Limit (MHz)	Pass / Fail
1	2412	15.37	0.5	Pass
6	2437	16.79	0.5	Pass
11	2462	16.09	0.5	Pass

### Spectrum Plot of Worst Value

#### 802.11b

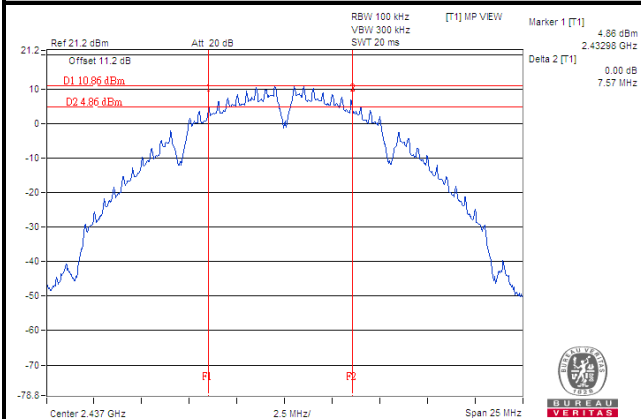

#### 802.11g

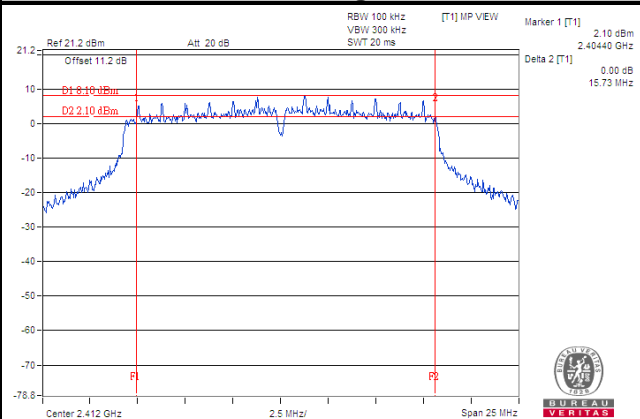

#### 802.11n (HT20)

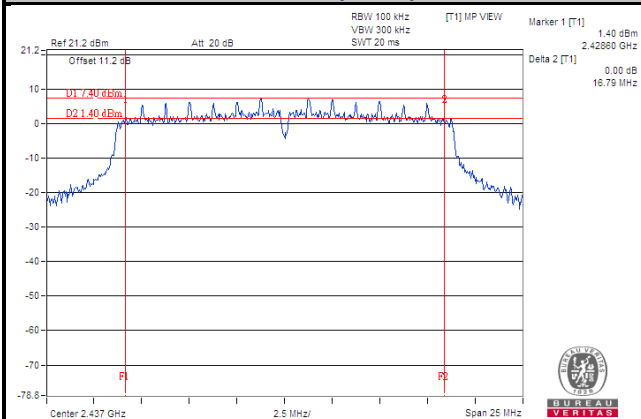

## 4.4 Occupied Bandwidth Measurement

### 4.4.1 Test Setup

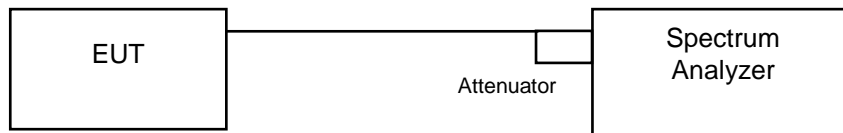

### 4.4.2 Test Instruments

Refer to section 4.1.2 to get information of above instrument.

### 4.4.3 Test Procedure

The transmitter output was connected to the spectrum analyzer through an attenuator. The bandwidth of the fundamental frequency was measured by spectrum analyzer with resolution bandwidth in the range of 1 % to 5 % of the anticipated emission bandwidth, and a video bandwidth at least 3x the resolution bandwidth and set the detector to PEAK. The width of a frequency band such that, below the lower and above the upper frequency limits, the mean powers emitted are each equal to a specified percentage 0.5 % of the total mean power of a given emission.

### 4.4.4 Deviation from Test Standard

No deviation.

### 4.4.5 EUT Operating Conditions

The software provided by client to enable the EUT under transmission condition continuously at lowest, middle and highest channel frequencies individually.

#### 4.4.6 Test Results

##### 802.11b

Channel	Frequency (MHz)	Occupied Bandwidth (MHz)	Pass / Fail
1	2412	12.50	Pass
6	2437	12.70	Pass
11	2462	12.59	Pass

##### 802.11g

Channel	Frequency (MHz)	Occupied Bandwidth (MHz)	Pass / Fail
1	2412	16.74	Pass
6	2437	16.74	Pass
11	2462	16.83	Pass

##### 802.11n (HT20)

Channel	Frequency (MHz)	Occupied Bandwidth (MHz)	Pass / Fail
1	2412	17.88	Pass
6	2437	17.88	Pass
11	2462	17.89	Pass

### Spectrum Plot of Worst Value

#### 802.11b

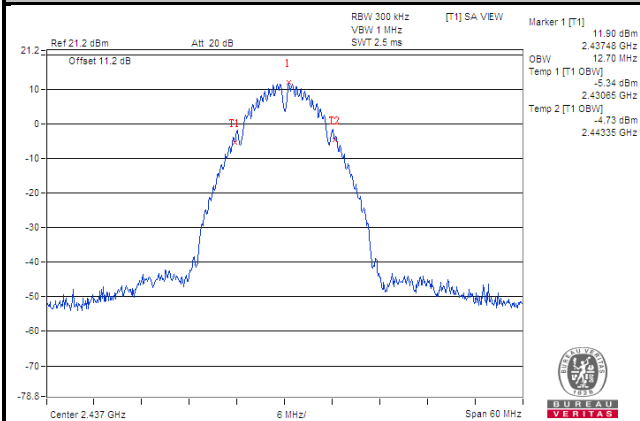

#### 802.11g

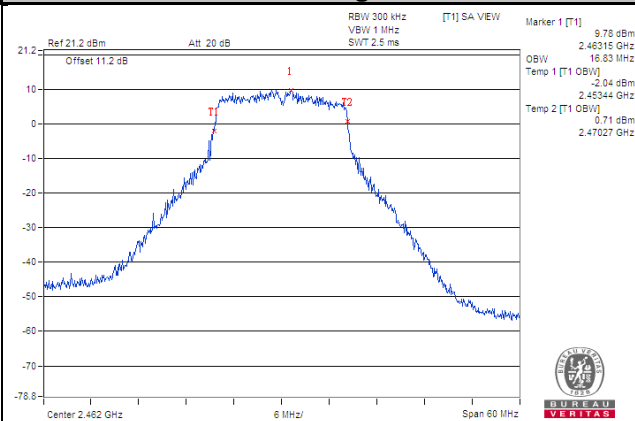

#### 802.11n (HT20)

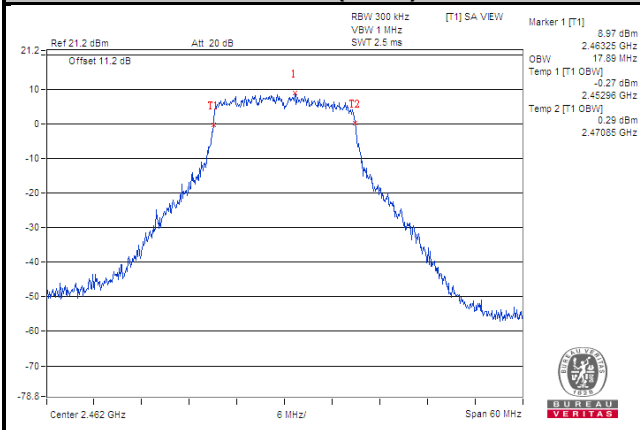

## 4.5 Conducted Output Power Measurement

### 4.5.1 Limits of Conducted Output Power Measurement

For systems using digital modulation in the 2400–2483.5 MHz bands: 1 Watt (30 dBm)

### 4.5.2 Test Setup

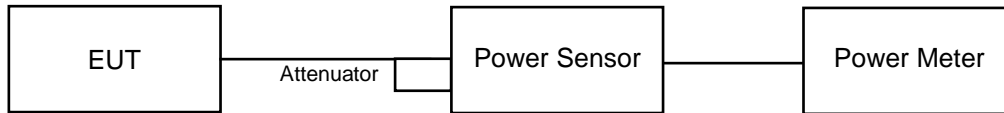

### 4.5.3 Test Instruments

Refer to section 4.1.2 to get information of above instrument.

### 4.5.4 Test Procedures

A peak power sensor was used on the output port of the EUT. A power meter was used to read the response of the peak power sensor. Record the power level.

### 4.5.5 Deviation from Test Standard

No deviation.

### 4.5.6 EUT Operating Conditions

The software provided by client to enable the EUT under transmission condition continuously at lowest, middle and highest channel frequencies individually.



#### 4.5.7 Test Results

##### 802.11b

Channel	Frequency (MHz)	Peak Power (mW)	Peak Power (dBm)	Limit (dBm)	Pass / Fail
1	2412	133.66	21.26	30	Pass
6	2437	127.35	21.05	30	Pass
11	2462	130.317	21.15	30	Pass

##### 802.11g

Channel	Frequency (MHz)	Peak Power (mW)	Peak Power (dBm)	Limit (dBm)	Pass / Fail
1	2412	153.815	21.87	30	Pass
6	2437	148.936	21.73	30	Pass
11	2462	147.911	21.70	30	Pass

##### 802.11n (HT20)

Channel	Frequency (MHz)	Peak Power (mW)	Peak Power (dBm)	Limit (dBm)	Pass / Fail
1	2412	136.144	21.34	30	Pass
6	2437	135.519	21.32	30	Pass
11	2462	133.66	21.26	30	Pass

## 4.6 Power Spectral Density Measurement

### 4.6.1 Limits of Power Spectral Density Measurement

The Maximum of Power Spectral Density Measurement is 8 dBm.

### 4.6.2 Test Setup

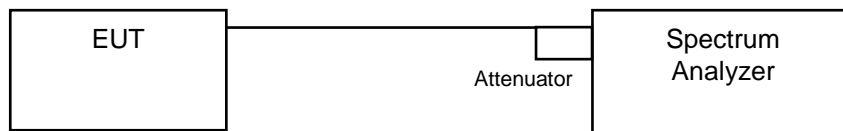

### 4.6.3 Test Instruments

Refer to section 4.1.2 to get information of above instrument.

### 4.6.4 Test Procedure

- a. Set analyzer center frequency to DTS channel center frequency.
- b. Set the span to 1.5 times the DTS bandwidth.
- c. Set the RBW to:  $3 \text{ kHz} \leq \text{RBW} \leq 100 \text{ kHz}$ .
- d. Set the VBW  $\geq 3 \times \text{RBW}$ .
- e. Detector = peak.
- f. Sweep time = auto couple.
- g. Trace mode = max hold.
- h. Allow trace to fully stabilize.
- i. Use the peak marker function to determine the maximum amplitude level within the RBW.

### 4.6.5 Deviation from Test Standard

No deviation.

### 4.6.6 EUT Operating Condition

The software provided by client to enable the EUT under transmission condition continuously at lowest, middle and highest channel frequencies individually.

#### 4.6.7 Test Results

##### 802.11b

Channel	Frequency (MHz)	PSD (dBm/3 kHz)	Limit (dBm/3 kHz)	Pass / Fail
1	2412	-4.25	8	Pass
6	2437	-4.78	8	Pass
11	2462	-3.69	8	Pass

##### 802.11g

Channel	Frequency (MHz)	PSD (dBm/3 kHz)	Limit (dBm/3 kHz)	Pass / Fail
1	2412	-8.00	8	Pass
6	2437	-7.68	8	Pass
11	2462	-8.29	8	Pass

##### 802.11n (HT20)

Channel	Frequency (MHz)	PSD (dBm/3 kHz)	Limit (dBm/3 kHz)	Pass / Fail
1	2412	-7.98	8	Pass
6	2437	-9.18	8	Pass
11	2462	-7.56	8	Pass

### Spectrum Plot of Worst Value

#### 802.11b

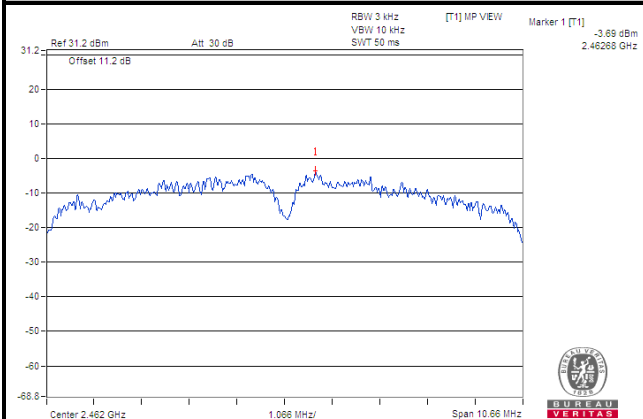

#### 802.11g

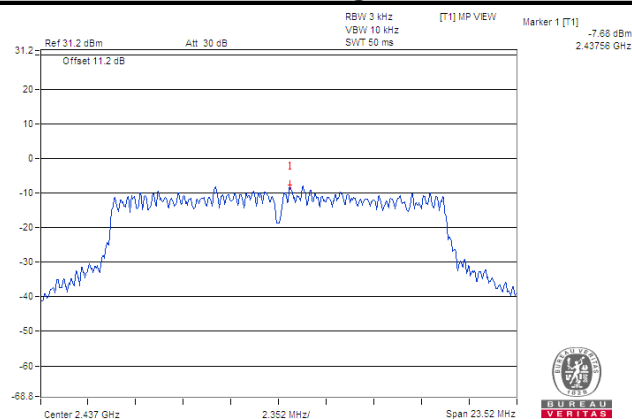

#### 802.11n (HT20)

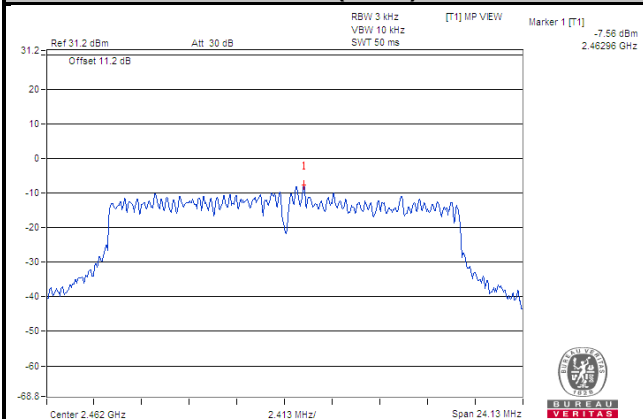

## 4.7 Conducted Out of Band Emission Measurement

### 4.7.1 Limits of Conducted Out of Band Emission Measurement

Below -20 dB of the highest emission level of operating band (in 100 kHz Resolution Bandwidth).

### 4.7.2 Test Setup

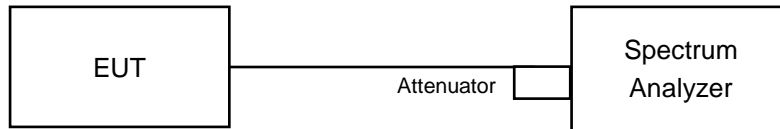

### 4.7.3 Test Instruments

Refer to section 4.1.2 to get information of above instrument.

### 4.7.4 Test Procedure

#### MEASUREMENT PROCEDURE REF

1. Set the RBW = 100 kHz.
2. Set the VBW  $\geq$  300 kHz.
3. Detector = peak.
4. Sweep time = auto couple.
5. Trace mode = max hold.
6. Allow trace to fully stabilize.
7. Use the peak marker function to determine the maximum power level in any 100 kHz band segment within the fundamental EBW.

#### MEASUREMENT PROCEDURE OOB

1. Set RBW = 100 kHz.
2. Set VBW  $\geq$  300 kHz.
3. Detector = peak.
4. Sweep = auto couple.
5. Trace Mode = max hold.
6. Allow trace to fully stabilize.
7. Use the peak marker function to determine the maximum amplitude level.

### 4.7.5 Deviation from Test Standard

No deviation.

### 4.7.6 EUT Operating Condition

The software provided by client to enable the EUT under transmission condition continuously at lowest, middle and highest channel frequencies individually.

### 4.7.7 Test Results

The spectrum plots are attached on the following images. D1 line indicates the highest level, and D2 line indicates the 20 dB offset below D1. It shows compliance with the requirement.

#### 802.11b

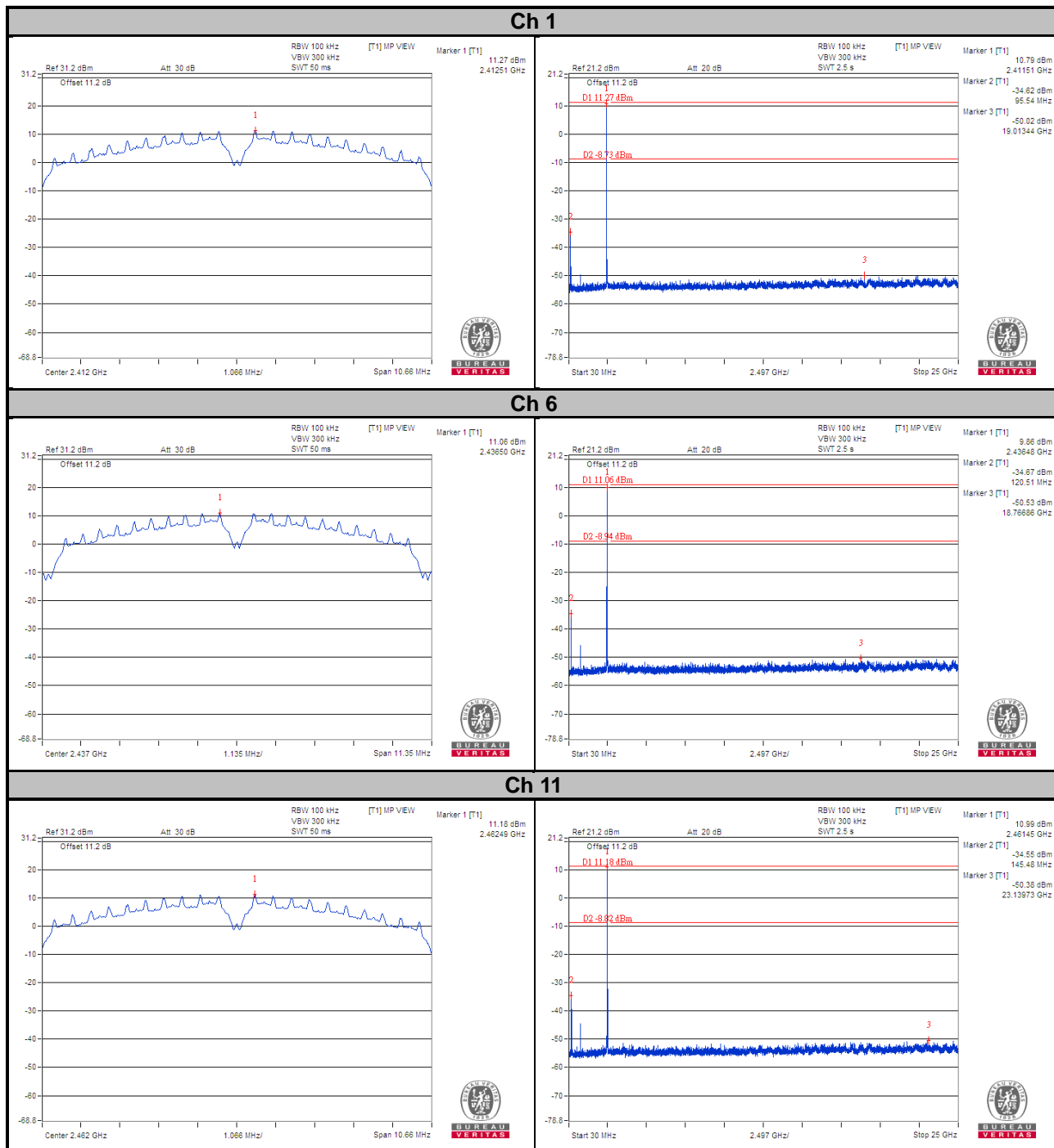

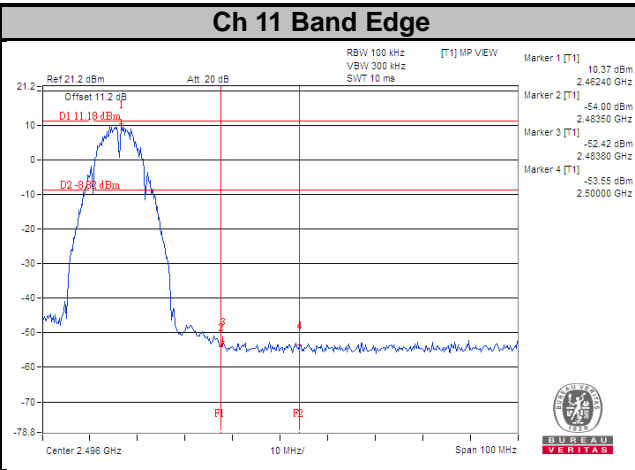
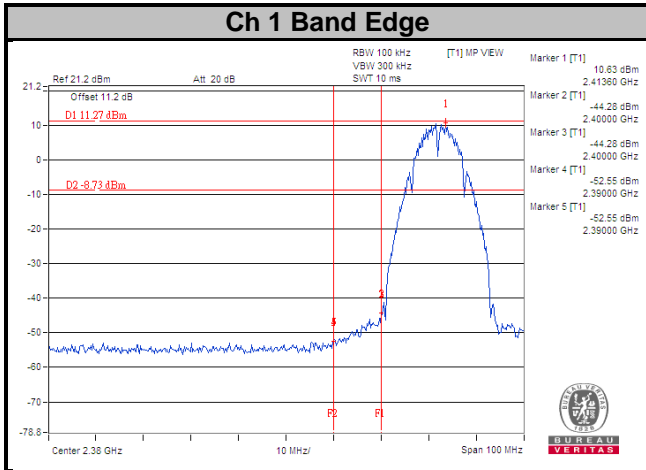

# 802.11g

## Ch 1

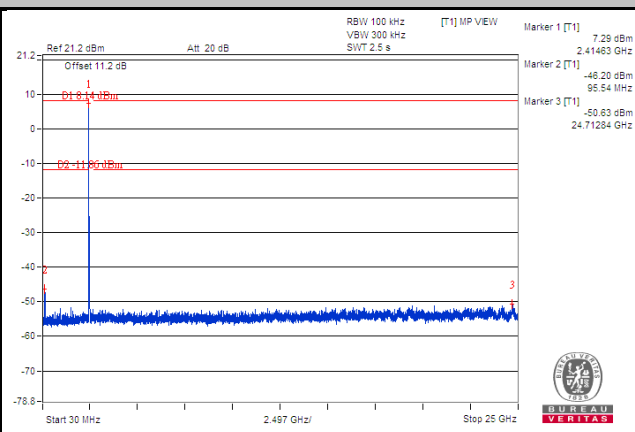
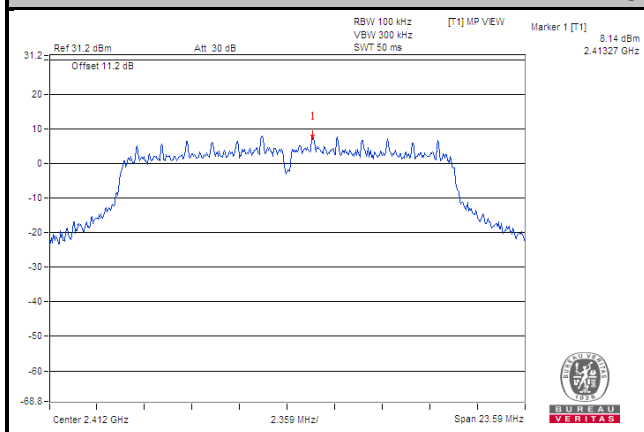

## Ch 6

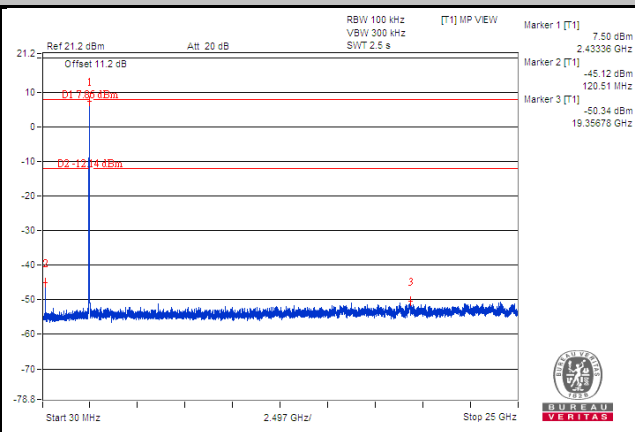
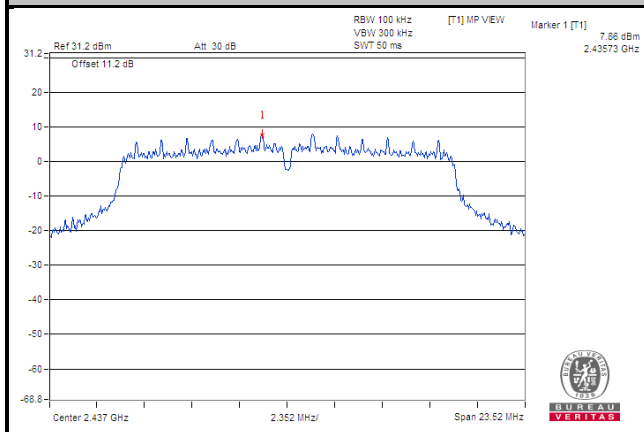

## Ch 11

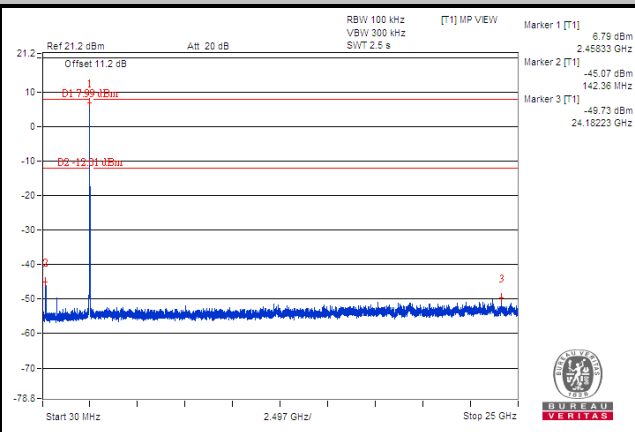
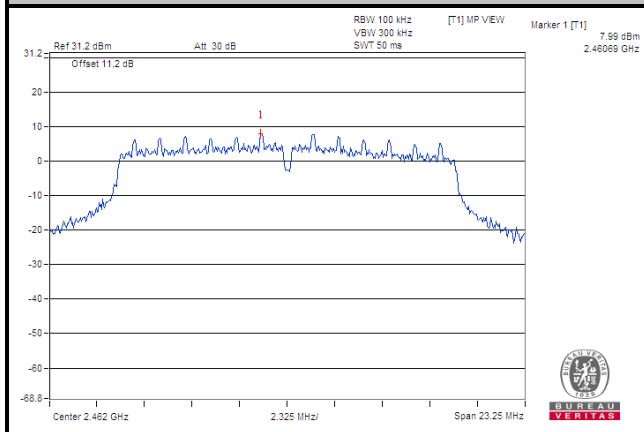



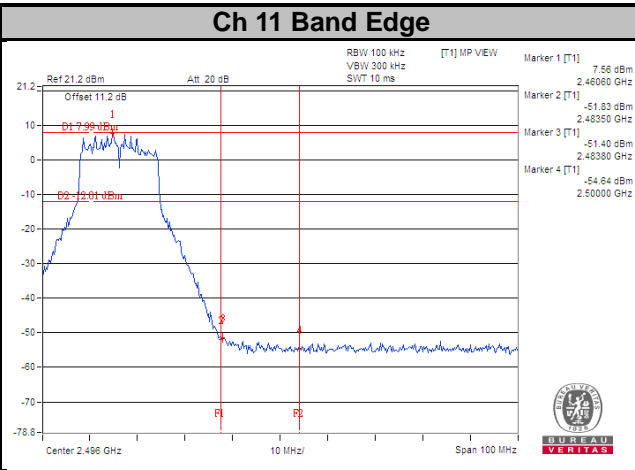
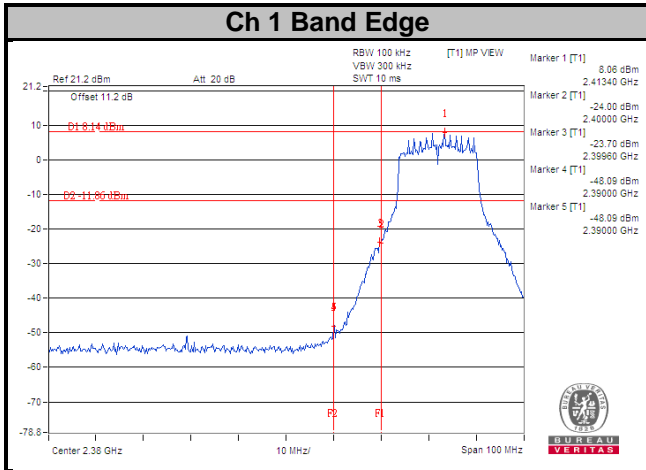

# 802.11n (HT20)

## Ch 1

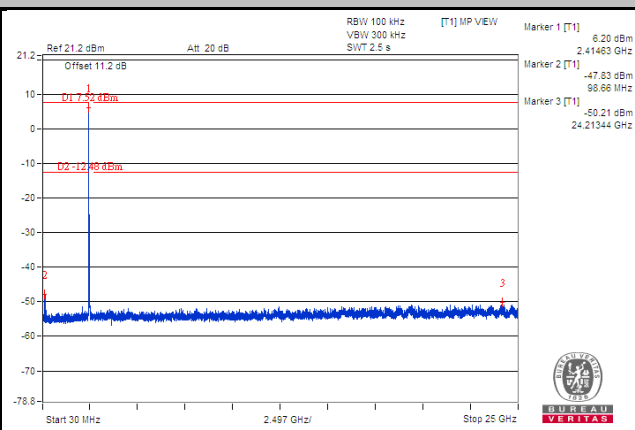
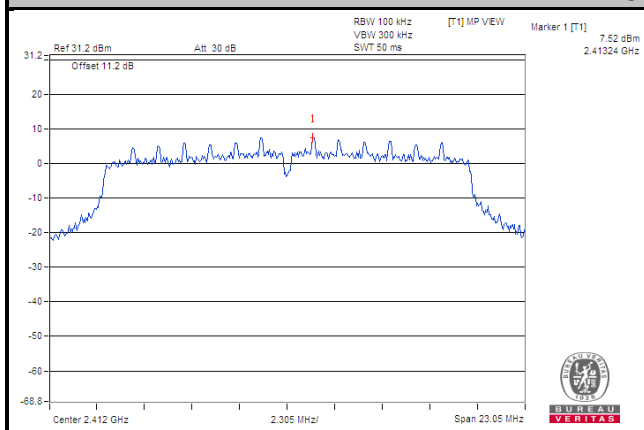

## Ch 6

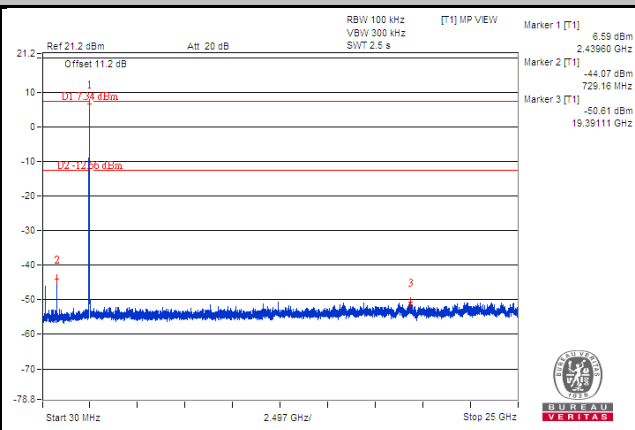
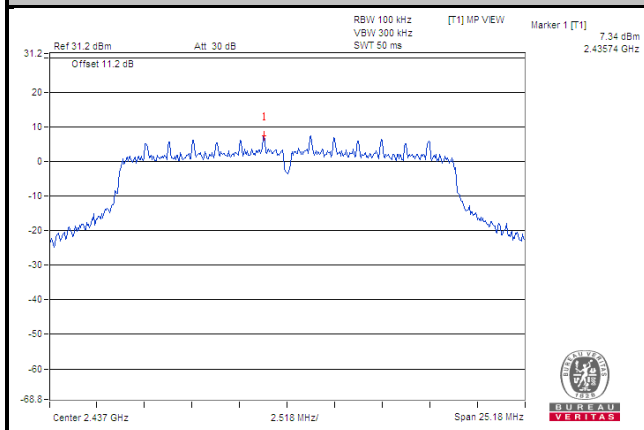

## Ch 11

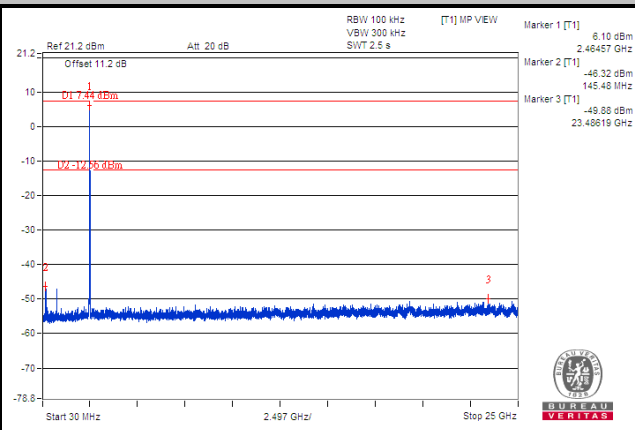
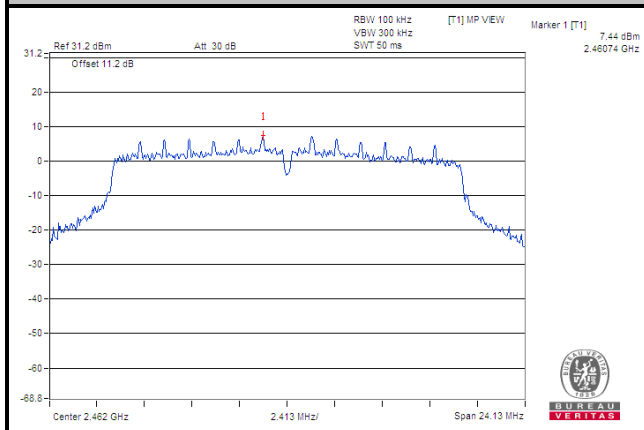

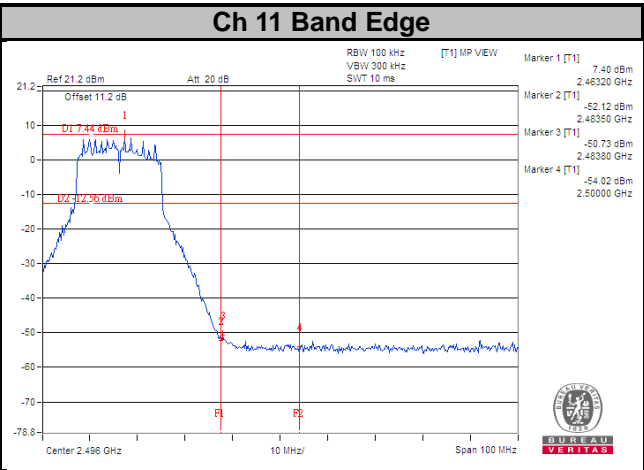
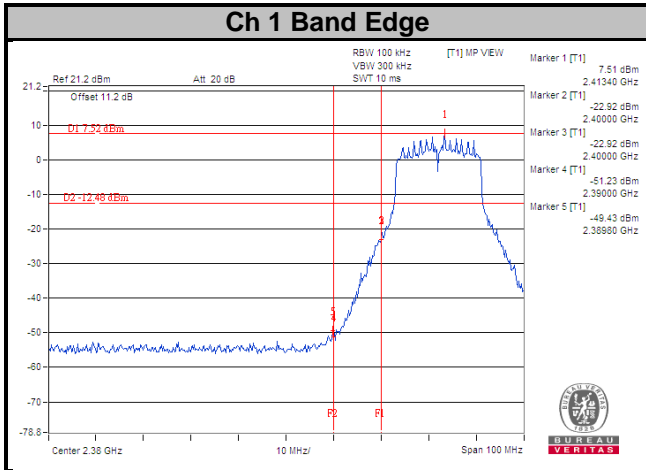

## 5 Pictures of Test Arrangements

Please refer to the attached file (Test Setup Photo).

## Appendix – Information on the Testing Laboratories

We, Bureau Veritas Consumer Products Services (H.K.) Ltd., Taoyuan Branch, were founded in 1988 to provide our best service in EMC, Radio, Telecom and Safety consultation. Our laboratories are FCC recognized accredited test firms and accredited according to ISO/IEC 17025.

If you have any comments, please feel free to contact us at the following:

**Linko EMC/RF Lab**

Tel: 886-2-26052180

Fax: 886-2-26051924

**Hsin Chu EMC/RF/Telecom Lab**

Tel: 886-3-6668565

Fax: 886-3-6668323

**Hwa Ya EMC/RF/Safety Lab**

Tel: 886-3-3183232

Fax: 886-3-3270892

**Email:** [service.adt@tw.bureauveritas.com](mailto:service.adt@tw.bureauveritas.com)

**Web Site:** [www.bureauveritas-adt.com](http://www.bureauveritas-adt.com)

The address and road map of all our labs can be found in our web site also.

--- END ---