

## FCC Test Report

**Report No.:** RF180821C20

**FCC ID:** V65E6910

**Test Model:** E6910

**Received Date:** Aug. 21, 2018

**Test Date:** Sep. 13, 2018 ~ Sep. 18, 2018

**Issued Date:** Sep. 25, 2018

**Applicant:** Kyocera Corporation c/o Kyocera International, Inc.

**Address:** 8611 Balboa Avenue, San Diego, CA 92123

**Issued By:** Bureau Veritas Consumer Products Services (H.K.) Ltd., Taoyuan Branch

**Lab Address:** No. 47-2, 14th Ling, Chia Pau Vil., Lin Kou Dist., New Taipei City, Taiwan  
( R.O.C )

**Test Location (1):** No.19, Hwa Ya 2nd Rd., Wen Hwa Vil., Kwei Shan Dist., Taoyuan City  
33383, Taiwan, R.O.C.

**Test Location (2):** No.215, Sec. 3, Beixin Rd., Xindian Dist., New Taipei City 231, Taiwan,  
R.O.C

**FCC Registration /  
Designation Number:** 427177 / TW0011



This report is for your exclusive use. Any copying or replication of this report to or for any other person or entity, or use of our name or trademark, is permitted only with our prior written permission. This report sets forth our findings solely with respect to the test samples identified herein. The results set forth in this report are not indicative or representative of the quality or characteristics of the lot from which a test sample was taken or any similar or identical product unless specifically and expressly noted. Our report includes all of the tests requested by you and the results thereof based upon the information that you provided to us. You have 60 days from date of issuance of this report to notify us of any material error or omission caused by our negligence, provided, however, that such notice shall be in writing and shall specifically address the issue you wish to raise. A failure to raise such issue within the prescribed time shall constitute your unqualified acceptance of the completeness of this report, the tests conducted and the correctness of the report contents. Unless specific mention, the uncertainty of measurement has been explicitly taken into account to declare the compliance or non-compliance to the specification. The report must not be used by the client to claim product certification, approval, or endorsement by TAF or any government agencies.

## Table of Contents

<b>Release Control Record</b> .....	<b>4</b>
<b>1 Certificate of Conformity</b> .....	<b>5</b>
<b>2 Summary of Test Results</b> .....	<b>6</b>
2.1 Measurement Uncertainty .....	6
2.2 Modification Record .....	6
<b>3 General Information</b> .....	<b>7</b>
3.1 General Description of EUT .....	7
3.2 Description of Test Modes .....	8
3.2.1 Test Mode Applicability and Tested Channel Detail .....	9
3.3 Description of Support Units .....	11
3.3.1 Configuration of System under Test .....	11
3.4 General Description of Applied Standards .....	12
<b>4 Test Types and Results</b> .....	<b>13</b>
4.1 Radiated Emission and Bandedge Measurement .....	13
4.1.1 Limits of Radiated Emission and Bandedge Measurement .....	13
4.1.2 Test Instruments .....	14
4.1.3 Test Procedures .....	15
4.1.4 Deviation from Test Standard .....	15
4.1.5 Test Set Up .....	16
4.1.6 EUT Operating Conditions .....	17
4.1.7 Test Results .....	18
4.2 Conducted Emission Measurement .....	26
4.2.1 Limits of Conducted Emission Measurement .....	26
4.2.2 Test Instruments .....	26
4.2.3 Test Procedures .....	27
4.2.4 Deviation from Test Standard .....	27
4.2.5 Test Setup .....	27
4.2.6 EUT Operating Condition .....	27
4.2.7 Test Results .....	28
4.3 Number of Hopping Frequency Used .....	30
4.3.1 Limits of Hopping Frequency Used Measurement .....	30
4.3.2 Test Setup .....	30
4.3.3 Test Instruments .....	30
4.3.4 Test Procedure .....	30
4.3.5 Deviation from Test Standard .....	30
4.3.6 Test Results .....	31
4.4 Dwell Time on Each Channel .....	32
4.4.1 Limits of Dwell Time on Each Channel Measurement .....	32
4.4.2 Test Setup .....	32
4.4.3 Test Instruments .....	32
4.4.4 Test Procedures .....	32
4.4.5 Deviation from Test Standard .....	32
4.4.6 Test Results .....	33
4.5 Channel Bandwidth .....	35
4.5.1 Limits of Channel Bandwidth Measurement .....	35
4.5.2 Test Setup .....	35
4.5.3 Test Instruments .....	35
4.5.4 Test Procedure .....	35
4.5.5 Deviation from Test Standard .....	35
4.5.6 EUT Operating Condition .....	35
4.5.7 Test Results .....	36
4.6 Occupied Bandwidth Measurement .....	37
4.6.1 Test Setup .....	37

4.6.2	Test Instruments .....	37
4.6.3	Test Procedure .....	37
4.6.4	Deviation from Test Standard .....	37
4.6.5	EUT Operating Conditions.....	37
4.6.6	Test Results .....	38
4.7	Hopping Channel Separation.....	39
4.7.1	Limits of Hopping Channel Separation Measurement.....	39
4.7.2	Test Setup.....	39
4.7.3	Test Instruments .....	39
4.7.4	Test Procedure .....	39
4.7.5	Deviation from Test Standard .....	39
4.7.6	Test Results .....	40
4.8	Maximum Output Power .....	41
4.8.1	Limits of Maximum Output Power Measurement .....	41
4.8.2	Test Setup.....	41
4.8.3	Test Instruments .....	41
4.8.4	Test Procedure .....	41
4.8.5	Deviation from Test Standard .....	41
4.8.6	EUT Operating Condition .....	41
4.8.7	Test Results .....	42
4.9	Conducted Out of Band Emission Measurement .....	43
4.9.1	Limits Of Conducted Out of Band Emission Measurement.....	43
4.9.2	Test Instruments .....	43
4.9.3	Test Procedure .....	43
4.9.4	Deviation from Test Standard .....	43
4.9.5	EUT Operating Condition .....	43
4.9.6	Test Results .....	43
<b>5</b>	<b>Pictures of Test Arrangements.....</b>	<b>48</b>
	<b>Appendix – Information on the Testing Laboratories .....</b>	<b>49</b>

### Release Control Record

Issue No.	Description	Date Issued
RF180821C20	Original Release	Sep. 25, 2018

## 1 Certificate of Conformity

**Product:** Smart Phone

**Brand:** Kyocera

**Test Model:** E6910

**Sample Status:** Identical Prototype

**Applicant:** Kyocera Corporation c/o Kyocera International, Inc.

**Test Date:** Sep. 13, 2018 ~ Sep. 18, 2018

**Standards:** 47 CFR FCC Part 15, Subpart C (Section 15.247)  
ANSI C63.10:2013

The above equipment has been tested by **Bureau Veritas Consumer Products Services (H.K.) Ltd., Taoyuan Branch**, and found compliance with the requirement of the above standards. The test record, data evaluation & Equipment Under Test (EUT) configurations represented herein are true and accurate accounts of the measurements of the sample's RF characteristics under the conditions specified in this report.

**Prepared by :** , **Date:** Sep. 25, 2018  
Ivonne Wu / Supervisor

**Approved by :** , **Date:** Sep. 25, 2018  
Dylan Chiou / Project Engineer

## 2 Summary of Test Results

47 CFR FCC Part 15, Subpart C (Section 15.247)			
FCC Clause	Test Item	Result	Remarks
15.207	AC Power Conducted Emission	Pass	Meet the requirement of limit. Minimum passing margin is -15.23 dB at 0.63875 MHz.
15.247(a)(1)(iii)	Number of Hopping Frequency Used	Pass	Meet the requirement of limit.
15.247(a)(1)(iii)	Dwell Time on Each Channel	Pass	Meet the requirement of limit.
15.247(a)(1)	1. Hopping Channel Separation 2. Spectrum Bandwidth of a Frequency Hopping Sequence Spread Spectrum System	Pass	Meet the requirement of limit.
15.247(b)	Maximum Peak Output Power	Pass	Meet the requirement of limit.
---	Occupied Bandwidth Measurement	Pass	Reference only
15.205 & 209	Radiated Emissions	Pass	Meet the requirement of limit. Minimum passing margin is -8.61 dB at 729.80 MHz.
15.247(d)	Band Edge Measurement	Pass	Meet the requirement of limit.
15.247(d)	Antenna Port Emission	Pass	Meet the requirement of limit.
15.203	Antenna Requirement	Pass	No antenna connector is used.

**Note:** If The Frequency Hopping System operating in 2400-2483.5 MHz band and the output power less than 125 mW. The hopping channel carrier frequencies separated by a minimum of 25 kHz or two-thirds of the 20 dB bandwidth of hopping channel whichever is greater.

### 2.1 Measurement Uncertainty

Where relevant, the following measurement uncertainty levels have been estimated for tests performed on the EUT as specified in CISPR 16-4-2:

Measurement	Frequency	Expanded Uncertainty (k=2) (±)
Conducted Emissions at mains ports	150 kHz ~ 30 MHz	2.44 dB
Radiated Emissions up to 1 GHz	30 MHz ~ 200 MHz	2.0153 dB
	200 MHz ~ 1000 MHz	2.0224 dB
Radiated Emissions above 1 GHz	1 GHz ~ 18 GHz	1.0121 dB
	18 GHz ~ 40 GHz	1.1508 dB

### 2.2 Modification Record

There were no modifications required for compliance.

### 3 General Information

#### 3.1 General Description of EUT

<b>Product</b>	Smart Phone
<b>Brand</b>	Kyocera
<b>Test Model</b>	E6910
<b>Status of EUT</b>	Identical Prototype
<b>Power Supply Rating</b>	3.8 Vdc (Battery) 5 Vdc or 9 Vdc or 12 Vdc (Adapter) 5 Vdc (Host equipment)
<b>Modulation Type</b>	GFSK, $\pi/4$ -DQPSK, 8DPSK
<b>Transfer Rate</b>	1/2/3 Mbps
<b>Operating Frequency</b>	2402 ~ 2480 MHz
<b>Number of Channel</b>	79
<b>Output Power</b>	5.346 mW
<b>Antenna Type</b>	Fixed Internal antenna with -1.0 dBi gain
<b>Antenna Connector</b>	N/A
<b>Accessory Device</b>	Refer to Note as below
<b>Data Cable Supplied</b>	Refer to Note as below

Note:

1. The EUT's accessories list refers to Ext. Pho.
2. The above EUT information is declared by manufacturer and for more detailed features description, please refers to the manufacturer's specifications or User's Manual.

### 3.2 Description of Test Modes

79 channels are provided to this EUT:

Channel	Freq. (MHz)	Channel	Freq. (MHz)	Channel	Freq. (MHz)	Channel	Freq. (MHz)
0	2402	20	2422	40	2442	60	2462
1	2403	21	2423	41	2443	61	2463
2	2404	22	2424	42	2444	62	2464
3	2405	23	2425	43	2445	63	2465
4	2406	24	2426	44	2446	64	2466
5	2407	25	2427	45	2447	65	2467
6	2408	26	2428	46	2448	66	2468
7	2409	27	2429	47	2449	67	2469
8	2410	28	2430	48	2450	68	2470
9	2411	29	2431	49	2451	69	2471
10	2412	30	2432	50	2452	70	2472
11	2413	31	2433	51	2453	71	2473
12	2414	32	2434	52	2454	72	2474
13	2415	33	2435	53	2455	73	2475
14	2416	34	2436	54	2456	74	2476
15	2417	35	2437	55	2457	75	2477
16	2418	36	2438	56	2458	76	2478
17	2419	37	2439	57	2459	77	2479
18	2420	38	2440	58	2460	78	2480
19	2421	39	2441	59	2461		



### 3.2.1 Test Mode Applicability and Tested Channel Detail

EUT Configure Mode	Applicable To				Description
	RE $\geq$ 1G	RE<1G	PLC	APCM	
-	√	√	√	√	-

Where **RE $\geq$ 1G**: Radiated Emission above 1 GHz      **RE<1G**: Radiated Emission below 1 GHz  
**PLC**: Power Line Conducted Emission      **APCM**: Antenna Port Conducted Measurement

**Note:**

1. For Radiated emission test, pre-tested GFSK,  $\pi/4$ -DQPSK, 8DPSK modulation type and found 8DPSK was the worse, therefore chosen for the final test and presented in the test report.
2. The EUT had been pre-tested on the positioned of each 3 axis. The worst case was found when positioned on **Y-plane**.
3. "-" means no effect.

**Radiated Emission Test (Above 1 GHz):**

- Pre-Scan has been conducted to determine the worst-case mode from all possible combinations between available modulations, data rates and antenna ports (if EUT with antenna diversity architecture).
- Following channel(s) was (were) selected for the final test as listed below.

EUT Configure Mode	Available Channel	Tested Channel	Modulation Technology	Modulation Type	Packet Type
-	0 to 78	0, 39, 78	FHSS	GFSK	DH5
-	0 to 78	0, 39, 78	FHSS	8DPSK	3DH5

**Radiated Emission Test (Below 1 GHz):**

- Pre-Scan has been conducted to determine the worst-case mode from all possible combinations between available modulations, data rates and antenna ports (if EUT with antenna diversity architecture).
- Following channel(s) was (were) selected for the final test as listed below.

EUT Configure Mode	Available Channel	Tested Channel	Modulation Technology	Modulation Type	Packet Type
-	0 to 78	78	FHSS	8DPSK	3DH5

**Power Line Conducted Emission Test:**

- Pre-Scan has been conducted to determine the worst-case mode from all possible combinations between available modulations, data rates and antenna ports (if EUT with antenna diversity architecture).
- Following channel(s) was (were) selected for the final test as listed below.

EUT Configure Mode	Available Channel	Tested Channel	Modulation Technology	Modulation Type	Packet Type
-	0 to 78	78	FHSS	8DPSK	3DH5

**Antenna Port Conducted Measurement:**

- This item includes all test value of each mode, but only includes spectrum plot of worst value of each mode.
- Pre-Scan has been conducted to determine the worst-case mode from all possible combinations between available modulations, data rates and antenna ports (if EUT with antenna diversity architecture).
- Following channel(s) was (were) selected for the final test as listed below.

EUT Configure Mode	Available Channel	Tested Channel	Modulation Technology	Modulation Type	Packet Type
-	0 to 78	0, 39, 78	FHSS	GFSK	DH5
-	0 to 78	0, 39, 78	FHSS	8DPSK	3DH5

**Test Condition:**

Applicable To	Environmental Conditions	Input Power	Tested by
RE $\geq$ 1G	25 deg. C, 65 % RH	120 Vac, 60 Hz	Harry Hsueh
RE $<$ 1G	25 deg. C, 65 % RH	120 Vac, 60 Hz	Harry Hsueh
PLC	25 deg. C, 65 % RH	120 Vac, 60 Hz	Jisyong Wang
APCM	25 deg. C, 65 % RH	3.8 Vdc	Gavin Wu

### 3.3 Description of Support Units

The EUT has been tested as an independent unit together with other necessary accessories or support units. The following support units or accessories were used to form a representative test configuration during the tests.

No.	Product	Brand	Model No.	Serial No.	FCC ID
1.	Earphone	Funkey	FK130102	N/A	N/A

No.	Signal Cable Description Of The Above Support Units
1.	N/A

Note:

1. All power cords of the above support units are non-shielded (1.8m).

#### 3.3.1 Configuration of System under Test

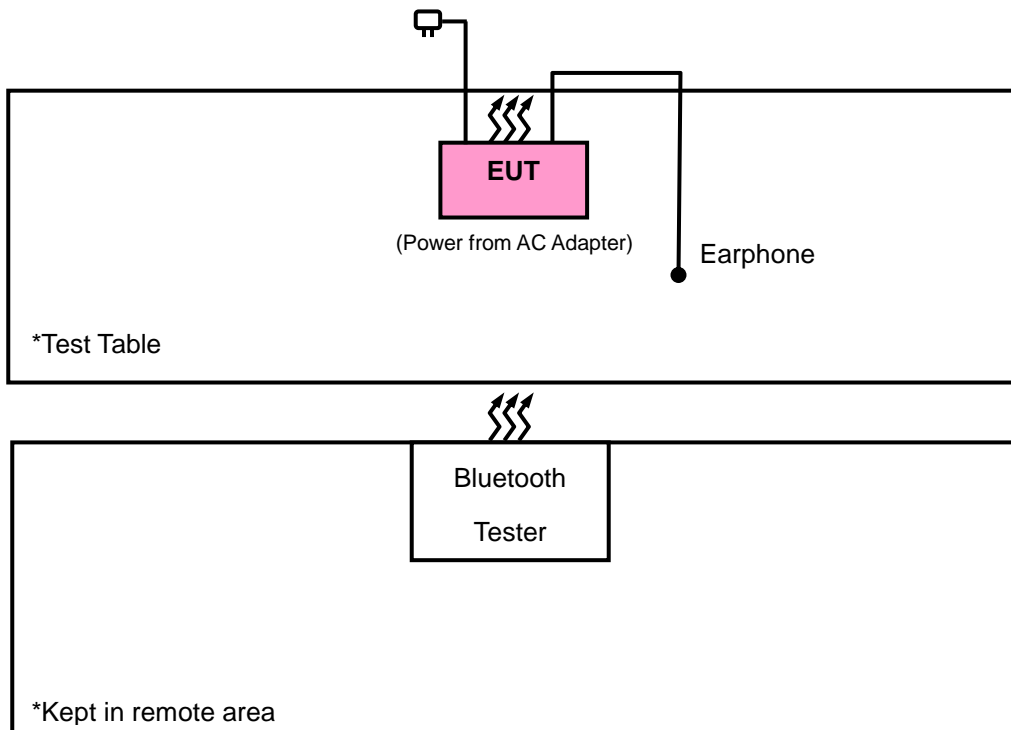

### 3.4 General Description of Applied Standards

The EUT is a RF Product. According to the specifications of the manufacturer, it must comply with the requirements of the following standards:

**FCC Part 15, Subpart C (15.247)**

**KDB 558074 D01 15.247 Meas Guidance v05**

ANSI C63.10-2013

All test items have been performed and recorded as per the above standards.

## 4 Test Types and Results

### 4.1 Radiated Emission and Bandedge Measurement

#### 4.1.1 Limits of Radiated Emission and Bandedge Measurement

Radiated emissions which fall in the restricted bands must comply with the radiated emission limits specified as below table. Other emissions shall be at least 20 dB below the highest level of the desired power:

Frequencies (MHz)	Field Strength (microvolts/meter)	Measurement Distance (meters)
0.009 ~ 0.490	2400/F (kHz)	300
0.490 ~ 1.705	24000/F (kHz)	30
1.705 ~ 30.0	30	30
30 ~ 88	100	3
88 ~ 216	150	3
216 ~ 960	200	3
Above 960	500	3

**Note:**

- a. The lower limit shall apply at the transition frequencies.
- b. Emission level (dBuV/m) = 20 log Emission level (uV/m).
- c. For frequencies above 1000 MHz, the field strength limits are based on average detector, however, the peak field strength of any emission shall not exceed the maximum permitted average limits, specified above by more than 20 dB under any condition of modulation.

## 4.1.2 Test Instruments

Description & Manufacturer	Model No.	Serial No.	Date of Calibration	Due Date of Calibration
Test Receiver Agilent Technologies	N9038A	MY52260177	Aug. 20, 2018	Aug. 19, 2019
Spectrum Analyzer ROHDE & SCHWARZ	FSU43	101261	Jan. 11, 2018	Jan. 10, 2019
HORN Antenna ETS-Lindgren	3117	00143293	Dec. 13, 2017	Dec. 12, 2018
BILOG Antenna SCHWARZBECK	VULB 9168	9168-616	Dec. 14, 2017	Dec. 13, 2018
HORN Antenna SCHWARZBECK	BBHA 9170	9170-480	Dec. 01, 2017	Nov. 30, 2018
Fixed Attenuator Woken	00801A1GGAM02Y	NA	May 17, 2018	May 16, 2019
Bluetooth Tester	CBT	100980	Jun. 28, 2017	Jun. 27, 2019
Loop Antenna	EM-6879	269	Sep. 07, 2018	Sep. 06, 2019
Preamplifier Agilent	310N	187226	Jun. 19, 2018	Jun. 18, 2019
Preamplifier Agilent	83017A	MY39501357	Jun. 19, 2018	Jun. 18, 2019
Power Meter Anritsu	ML2495A	1012010	Sep. 05, 2018	Sep. 04, 2019
Power Sensor Anritsu	MA2411B	1315050	Sep. 04, 2018	Sep. 03, 2019
RF signal cable ETS-LINDGREN	5D-FB	Cable-CH1-01(RFC -SMS-100-SMS-12 0+RFC-SMS-100-S MS-400)	Jun. 19, 2018	Jun. 18, 2019
RF signal cable ETS-LINDGREN	8D-FB	Cable-CH1-02(RFC -SMS-100-SMS-24)	Jun. 19, 2018	Jun. 18, 2019
Boresight Antenna Fixture	FBA-01	FBA-SIP01	NA	NA
Software BV ADT	E3 8.130425b	NA	NA	NA
Antenna Tower MF	NA	NA	NA	NA
Turn Table MF	NA	NA	NA	NA
Antenna Tower & Turn Table Controller MF	MF-7802	NA	NA	NA

- Note: 1. The calibration interval of the above test instruments is 12 / 24 months and the calibrations are traceable to NML/ROC and NIST/USA.
2. The test was performed in HsinTien Chamber 1.
3. The horn antenna and preamplifier (model: 83017A) are used only for the measurement of emission frequency above 1 GHz if tested.
4. The IC Site Registration No. is IC7450I-1.

#### 4.1.3 Test Procedures

##### **For Radiated Emission below 30 MHz**

- a. The EUT was placed on the top of a rotating table 0.8 meters above the ground at a 3 meter chamber room. The table was rotated 360 degrees to determine the position of the highest radiation.
- b. The EUT was set 3 meters away from the interference-receiving antenna, which was mounted on the top of a variable-height antenna tower.
- c. Both Parallel, perpendicular, and ground-parallel orientations of the antenna are set to make the measurement.
- d. For each suspected emission, the EUT was arranged to its worst case and the rotatable table was turned from 0 degrees to 360 degrees to find the maximum reading.
- e. The test-receiver system was set to Quasi-Peak Detect Function and Specified Bandwidth with Maximum Hold Mode.

##### **Note:**

1. The resolution bandwidth and video bandwidth of test receiver/spectrum analyzer is 9 kHz at frequency below 30 MHz.

##### **For Radiated Emission above 30 MHz**

- a. The EUT was placed on the top of a rotating table 0.8 meters (for 30 MHz ~ 1 GHz) / 1.5 meters (for above 1 GHz) above the ground at 3 meter chamber room for test. The table was rotated 360 degrees to determine the position of the highest radiation.
- b. The EUT was set 3 meters away from the interference-receiving antenna, which was mounted on the top of a variable-height antenna tower.
- c. The height of antenna is varied from one meter to four meters above the ground to determine the maximum value of the field strength. Both horizontal and vertical polarizations of the antenna are set to make the measurement.
- d. For each suspected emission, the EUT was arranged to its worst case and then the antenna was tuned to heights from 1 meter to 4 meters and the rotatable table was turned from 0 degrees to 360 degrees to find the maximum reading.
- e. The test-receiver system was set to quasi-peak detect function and specified bandwidth with maximum hold mode when the test frequency is below 1 GHz.
- f. The test-receiver system was set to peak and average detected function and specified bandwidth with maximum hold mode when the test frequency is above 1 GHz. If the peak reading value also meets average limit, measurement with the average detector is unnecessary.

##### **Note:**

1. The resolution bandwidth and video bandwidth of test receiver/spectrum analyzer is 120 kHz for Quasi-peak detection (QP) at frequency below 1 GHz.
2. The resolution bandwidth of test receiver/spectrum analyzer is 1 MHz and the video bandwidth is 3 MHz for Peak detection (PK) at frequency above 1 GHz.
3. The resolution bandwidth of test receiver/spectrum analyzer is 1 MHz and the video bandwidth is  $\geq 1/T$  (Duty cycle < 98 %) or 10 Hz (Duty cycle  $\geq 98$  %) for Average detection (AV) at frequency above 1 GHz. (RBW = 1 MHz, VBW = 3 kHz)
4. All modes of operation were investigated and the worst-case emissions are reported.

#### 4.1.4 Deviation from Test Standard

No deviation.

4.1.5 Test Set Up

<Radiated Emission below 30 MHz>

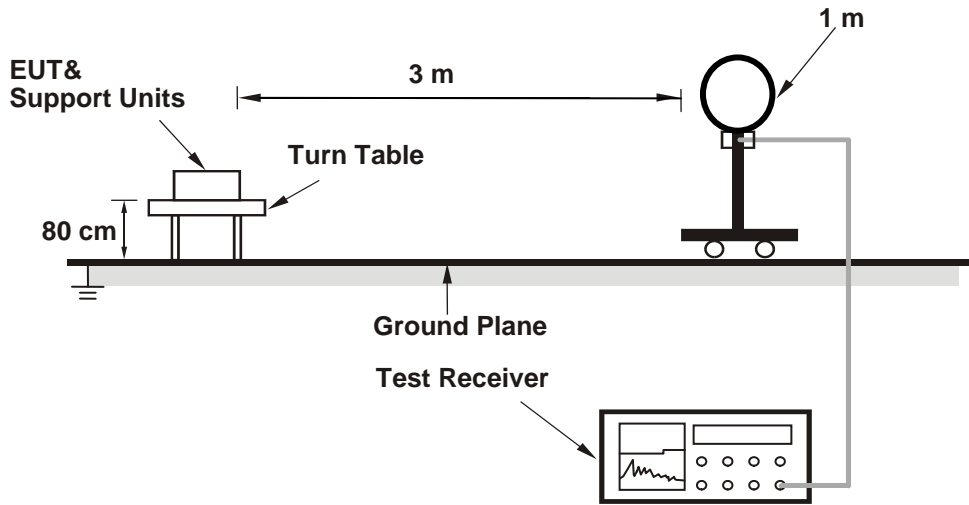

<Radiated Emission 30 MHz to 1 GHz>

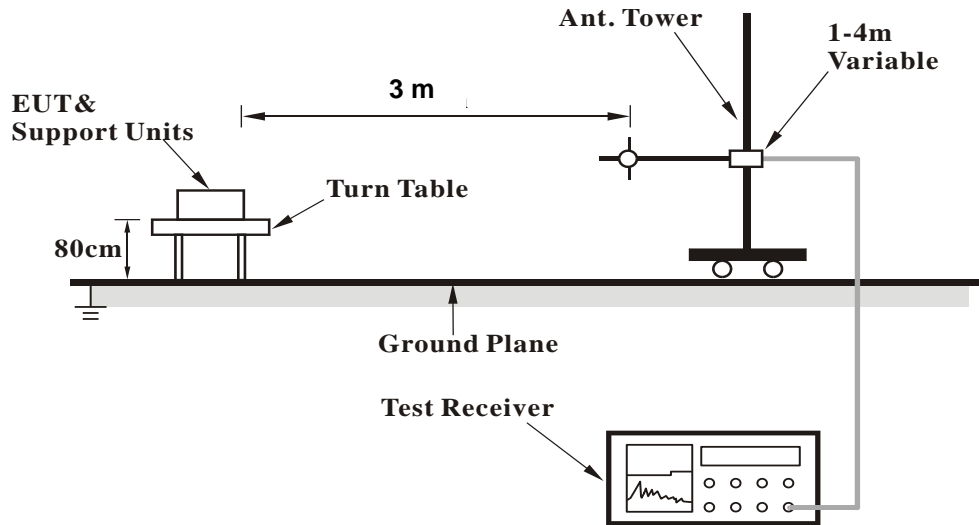



**<Radiated Emission above 1 GHz>**

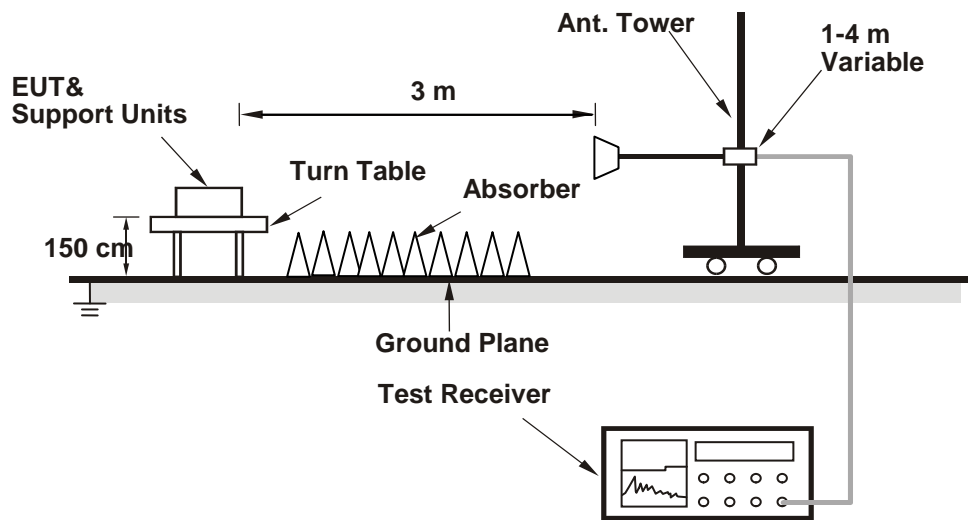

For the actual test configuration, please refer to the attached file (Test Setup Photo).

**4.1.6 EUT Operating Conditions**

Set the EUT under transmission condition continuously at specific channel frequency.

4.1.7 Test Results

Above 1 GHz Data:  
GFSK

EUT Test Condition		Measurement Detail	
Channel	Channel 0	Frequency Range	1 GHz ~ 25 GHz
Input Power	120 Vac, 60 Hz	Detector Function	Peak (PK) Average (AV)
Environmental Conditions	25 deg. C, 65 % RH	Tested By	Harry Hsueh

Antenna Polarity & Test Distance: Horizontal at 3 m										
Frequency (MHz)	Emission Level (dBuV/m)	Read Level (dBuV)	Limit (dBuV/m)	Margin (dB)	Antenna Factor (dB/m)	Cable Loss (dB)	Preamp Factor (dB)	Antenna Height (cm)	Table Angle (Degree)	Remark
2384.52	41.38	39.69	54	-12.62	31.78	5.4	35.49	198	14	Average
2384.52	52.56	50.87	74	-21.44	31.78	5.4	35.49	198	14	Peak
2402	102.45	100.72			31.8	5.4	35.47	198	14	Average
2402	103.99	102.26			31.8	5.4	35.47	198	14	Peak
4804	39.47	31.38	54	-14.53	33.96	8.25	34.12	196	321	Average
4804	47.73	39.64	74	-26.27	33.96	8.25	34.12	196	321	Peak

Antenna Polarity & Test Distance: Vertical at 3 m										
Frequency (MHz)	Emission Level (dBuV/m)	Read Level (dBuV)	Limit (dBuV/m)	Margin (dB)	Antenna Factor (dB/m)	Cable Loss (dB)	Preamp Factor (dB)	Antenna Height (cm)	Table Angle (Degree)	Remark
2386.86	41.33	39.62	54	-12.67	31.8	5.4	35.49	185	252	Average
2386.86	51.71	50	74	-22.29	31.8	5.4	35.49	185	252	Peak
2402	105.08	103.35			31.8	5.4	35.47	185	252	Average
2402	106.79	105.06			31.8	5.4	35.47	185	252	Peak
4804	39.16	31.07	54	-14.84	33.96	8.25	34.12	123	157	Average
4804	47.29	39.2	74	-26.71	33.96	8.25	34.12	123	157	Peak

Remarks:

- Emission Level = Read Level + Antenna Factor + Cable Loss - Preamp Factor  
Margin value = Emission level – Limit value
- 2402 MHz: Fundamental frequency.
- The emission levels of other frequencies were very low against the limit.

EUT Test Condition		Measurement Detail	
Channel	Channel 39	Frequency Range	1 GHz ~ 25 GHz
Input Power	120 Vac, 60 Hz	Detector Function	Peak (PK) Average (AV)
Environmental Conditions	25 deg. C, 65 % RH	Tested By	Harry Hsueh

Antenna Polarity & Test Distance: Horizontal at 3 m										
Frequency (MHz)	Emission Level (dBuV/m)	Read Level (dBuV)	Limit (dBuV/m)	Margin (dB)	Antenna Factor (dB/m)	Cable Loss (dB)	Preamp Factor (dB)	Antenna Height (cm)	Table Angle (Degree)	Remark
2388.75	41.26	39.55	54	-12.74	31.8	5.4	35.49	198	14	Average
2388.75	51.76	50.05	74	-22.24	31.8	5.4	35.49	198	14	Peak
2441	101.44	99.57			31.85	5.46	35.44	198	14	Average
2441	102.26	100.39			31.85	5.46	35.44	198	14	Peak
2487.12	41.94	39.95	54	-12.06	31.88	5.53	35.42	198	14	Average
2487.12	51.89	49.9	74	-22.11	31.88	5.53	35.42	198	14	Peak
4882	38.42	30.23	54	-15.58	33.98	8.27	34.06	122	154	Average
4882	48.22	40.03	74	-25.78	33.98	8.27	34.06	122	154	Peak

Antenna Polarity & Test Distance: Vertical at 3 m										
Frequency (MHz)	Emission Level (dBuV/m)	Read Level (dBuV)	Limit (dBuV/m)	Margin (dB)	Antenna Factor (dB/m)	Cable Loss (dB)	Preamp Factor (dB)	Antenna Height (cm)	Table Angle (Degree)	Remark
2385.24	41.42	39.73	54	-12.58	31.78	5.4	35.49	185	252	Average
2385.24	52.51	50.82	74	-21.49	31.78	5.4	35.49	185	252	Peak
2441	106.44	104.57			31.85	5.46	35.44	185	252	Average
2441	107.44	105.57			31.85	5.46	35.44	185	252	Peak
2492.4	42.86	40.84	54	-11.14	31.9	5.53	35.41	185	252	Average
2492.4	51.97	49.95	74	-22.03	31.9	5.53	35.41	185	252	Peak
4882	38.05	29.86	54	-15.95	33.98	8.27	34.06	166	157	Average
4882	47.75	39.56	74	-26.25	33.98	8.27	34.06	166	157	Peak

Remarks:

- Emission Level = Read Level + Antenna Factor + Cable Loss - Preamp Factor  
Margin value = Emission level – Limit value
- 2441 MHz: Fundamental frequency.
- The emission levels of other frequencies were very low against the limit.

EUT Test Condition		Measurement Detail	
Channel	Channel 78	Frequency Range	1 GHz ~ 25 GHz
Input Power	120 Vac, 60 Hz	Detector Function	Peak (PK) Average (AV)
Environmental Conditions	25 deg. C, 65 % RH	Tested By	Harry Hsueh

Antenna Polarity & Test Distance: Horizontal at 3 m										
Frequency (MHz)	Emission Level (dBuV/m)	Read Level (dBuV)	Limit (dBuV/m)	Margin (dB)	Antenna Factor (dB/m)	Cable Loss (dB)	Preamp Factor (dB)	Antenna Height (cm)	Table Angle (Degree)	Remark
2480	101.5	99.54			31.88	5.5	35.42	198	14	Average
2480	103.37	101.41			31.88	5.5	35.42	198	14	Peak
2484.32	43.17	41.18	54	-10.83	31.88	5.53	35.42	198	14	Average
2484.32	52.02	50.03	74	-21.98	31.88	5.53	35.42	198	14	Peak
4960	42.17	33.9	54	-11.83	33.99	8.29	34.01	126	332	Average
4960	49.68	41.41	74	-24.32	33.99	8.29	34.01	126	332	Peak
Antenna Polarity & Test Distance: Vertical at 3 m										
Frequency (MHz)	Emission Level (dBuV/m)	Read Level (dBuV)	Limit (dBuV/m)	Margin (dB)	Antenna Factor (dB/m)	Cable Loss (dB)	Preamp Factor (dB)	Antenna Height (cm)	Table Angle (Degree)	Remark
2480	105.59	103.63			31.88	5.5	35.42	185	252	Average
2480	106.8	104.84			31.88	5.5	35.42	185	252	Peak
2483.56	42.59	40.63	54	-11.41	31.88	5.5	35.42	185	252	Average
2483.56	52.21	50.25	74	-21.79	31.88	5.5	35.42	185	252	Peak
4960	40.08	31.81	54	-13.92	33.99	8.29	34.01	146	112	Average
4960	49.77	41.5	74	-24.23	33.99	8.29	34.01	146	112	Peak

Remarks:

- Emission Level = Read Level + Antenna Factor + Cable Loss - Preamp Factor  
Margin value = Emission level – Limit value
- 2480 MHz: Fundamental frequency.
- The emission levels of other frequencies were very low against the limit.

## 8DPSK

EUT Test Condition		Measurement Detail	
Channel	Channel 0	Frequency Range	1 GHz ~ 25 GHz
Input Power	120 Vac, 60 Hz	Detector Function	Peak (PK) Average (AV)
Environmental Conditions	25 deg. C, 65 % RH	Tested By	Harry Hsueh

### Antenna Polarity & Test Distance: Horizontal at 3 m

Frequency (MHz)	Emission Level (dBuV/m)	Read Level (dBuV)	Limit (dBuV/m)	Margin (dB)	Antenna Factor (dB/m)	Cable Loss (dB)	Preamp Factor (dB)	Antenna Height (cm)	Table Angle (Degree)	Remark
2386.2	39.57	37.86	54	-14.43	31.8	5.4	35.49	105	33	Average
2386.2	53.3	51.59	74	-20.7	31.8	5.4	35.49	105	33	Peak
2402	100.6	98.87			31.8	5.4	35.47	105	33	Average
2402	105.28	103.55			31.8	5.4	35.47	105	33	Peak
4804	40.22	32.13	54	-13.78	33.96	8.25	34.12	122	154	Average
4804	46.85	38.76	74	-27.15	33.96	8.25	34.12	122	154	Peak

### Antenna Polarity & Test Distance: Vertical at 3 m

Frequency (MHz)	Emission Level (dBuV/m)	Read Level (dBuV)	Limit (dBuV/m)	Margin (dB)	Antenna Factor (dB/m)	Cable Loss (dB)	Preamp Factor (dB)	Antenna Height (cm)	Table Angle (Degree)	Remark
2388.3	41.83	40.12	54	-12.17	31.8	5.4	35.49	183	75	Average
2388.3	53.23	51.52	74	-20.77	31.8	5.4	35.49	183	75	Peak
2402	103.95	102.22			31.8	5.4	35.47	183	75	Average
2402	108.27	106.54			31.8	5.4	35.47	183	75	Peak
4804	39.96	31.87	54	-14.04	33.96	8.25	34.12	166	158	Average
4804	48.2	40.11	74	-25.8	33.96	8.25	34.12	166	158	Peak

#### Remarks:

- Emission Level = Read Level + Antenna Factor + Cable Loss - Preamp Factor  
Margin value = Emission level – Limit value
- 2402 MHz: Fundamental frequency.
- The emission levels of other frequencies were very low against the limit.

EUT Test Condition		Measurement Detail	
Channel	Channel 39	Frequency Range	1 GHz ~ 25 GHz
Input Power	120 Vac, 60 Hz	Detector Function	Peak (PK) Average (AV)
Environmental Conditions	25 deg. C, 65 % RH	Tested By	Harry Hsueh

Antenna Polarity & Test Distance: Horizontal at 3 m										
Frequency (MHz)	Emission Level (dBuV/m)	Read Level (dBuV)	Limit (dBuV/m)	Margin (dB)	Antenna Factor (dB/m)	Cable Loss (dB)	Preamp Factor (dB)	Antenna Height (cm)	Table Angle (Degree)	Remark
2385.66	41.59	39.88	54	-12.41	31.8	5.4	35.49	105	33	Average
2385.66	51.94	50.23	74	-22.06	31.8	5.4	35.49	105	33	Peak
2441	99.75	97.88			31.85	5.46	35.44	105	33	Average
2441	104.85	102.98			31.85	5.46	35.44	105	33	Peak
2486.7	41.75	39.76	54	-12.25	31.88	5.53	35.42	105	33	Average
2486.7	51.85	49.86	74	-22.15	31.88	5.53	35.42	105	33	Peak
4882	39.05	30.86	54	-14.95	33.98	8.27	34.06	122	66	Average
4882	48.76	40.57	74	-25.24	33.98	8.27	34.06	122	66	Peak

Antenna Polarity & Test Distance: Vertical at 3 m										
Frequency (MHz)	Emission Level (dBuV/m)	Read Level (dBuV)	Limit (dBuV/m)	Margin (dB)	Antenna Factor (dB/m)	Cable Loss (dB)	Preamp Factor (dB)	Antenna Height (cm)	Table Angle (Degree)	Remark
2385.8	41.47	39.76	54	-12.53	31.8	5.4	35.49	183	75	Average
2385.8	52.49	50.78	74	-21.51	31.8	5.4	35.49	183	75	Peak
2441	103.66	101.79			31.85	5.46	35.44	183	75	Average
2441	108.85	106.98			31.85	5.46	35.44	183	75	Peak
2486.9	42.79	40.8	54	-11.21	31.88	5.53	35.42	183	75	Average
2486.9	51.86	49.87	74	-22.14	31.88	5.53	35.42	183	75	Peak
4882	38.44	30.25	54	-15.56	33.98	8.27	34.06	165	25	Average
4882	47.73	39.54	74	-26.27	33.98	8.27	34.06	165	25	Peak

Remarks:

- Emission Level = Read Level + Antenna Factor + Cable Loss - Preamp Factor  
Margin value = Emission level – Limit value
- 2441 MHz: Fundamental frequency.
- The emission levels of other frequencies were very low against the limit.

EUT Test Condition		Measurement Detail	
Channel	Channel 78	Frequency Range	1 GHz ~ 25 GHz
Input Power	120 Vac, 60 Hz	Detector Function	Peak (PK) Average (AV)
Environmental Conditions	25 deg. C, 65 % RH	Tested By	Harry Hsueh

Antenna Polarity & Test Distance: Horizontal at 3 m										
Frequency (MHz)	Emission Level (dBuV/m)	Read Level (dBuV)	Limit (dBuV/m)	Margin (dB)	Antenna Factor (dB/m)	Cable Loss (dB)	Preamp Factor (dB)	Antenna Height (cm)	Table Angle (Degree)	Remark
2480	100.75	98.79			31.88	5.5	35.42	105	33	Average
2480	105.81	103.85			31.88	5.5	35.42	105	33	Peak
2485.15	43.88	41.89	54	-10.12	31.88	5.53	35.42	105	33	Average
2485.15	52.22	50.23	74	-21.78	31.88	5.53	35.42	105	33	Peak
4960	43.18	34.91	54	-10.82	33.99	8.29	34.01	105	33	Average
4960	50.08	41.81	74	-23.92	33.99	8.29	34.01	105	33	Peak
Antenna Polarity & Test Distance: Vertical at 3 m										
Frequency (MHz)	Emission Level (dBuV/m)	Read Level (dBuV)	Limit (dBuV/m)	Margin (dB)	Antenna Factor (dB/m)	Cable Loss (dB)	Preamp Factor (dB)	Antenna Height (cm)	Table Angle (Degree)	Remark
2480	103.08	101.12			31.88	5.5	35.42	185	68	Average
2480	108.95	106.99			31.88	5.5	35.42	185	68	Peak
2483.98	42.08	40.12	54	-11.92	31.88	5.5	35.42	185	68	Average
2483.98	52.19	50.23	74	-21.81	31.88	5.5	35.42	185	68	Peak
4960	40.14	31.87	54	-13.86	33.99	8.29	34.01	155	20	Average
4960	49.45	41.18	74	-24.55	33.99	8.29	34.01	155	20	Peak

Remarks:

- Emission Level = Read Level + Antenna Factor + Cable Loss - Preamp Factor  
Margin value = Emission level – Limit value
- 2480 MHz: Fundamental frequency.
- The emission levels of other frequencies were very low against the limit.

**9 kHz ~ 30 MHz Data:**

The amplitude of spurious emissions attenuated more than 20 dB below the permissible value is not required to be report.

**30 MHz ~ 1 GHz Worst-Case Data:**

EUT Test Condition		Measurement Detail	
Channel	Channel 78	Frequency Range	30 MHz ~ 1 GHz
Input Power	120 Vac, 60 Hz	Detector Function	Peak (PK) Quasi-peak (QP)
Environmental Conditions	25 deg. C, 65 % RH	Tested By	Harry Hsueh

**Horizontal**

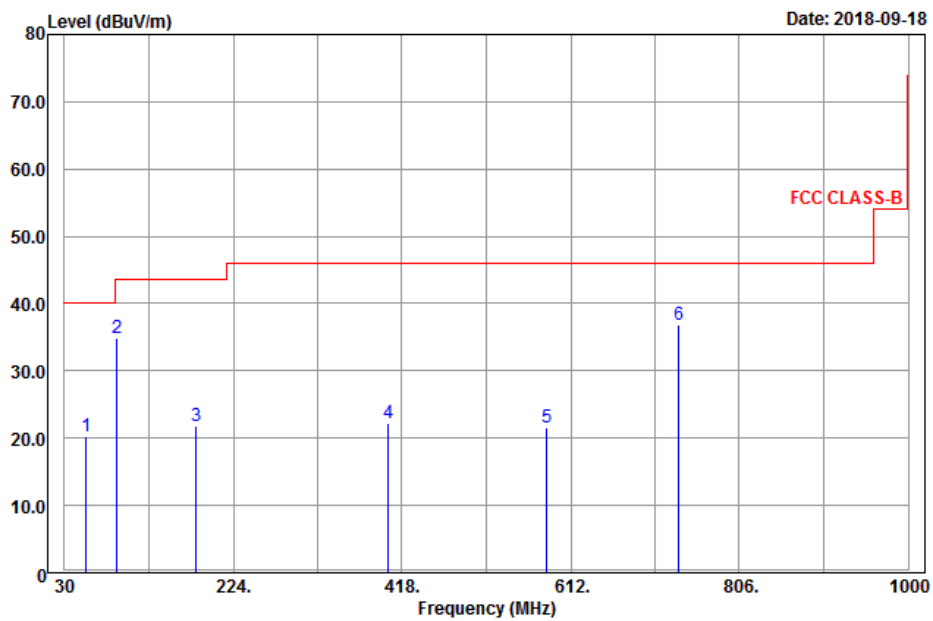

**Vertical**

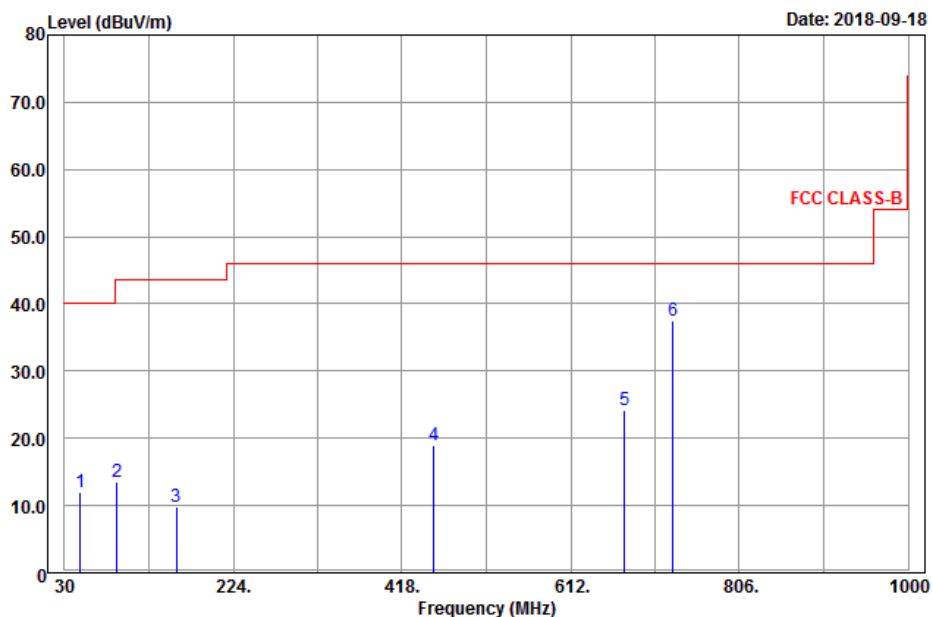



**Antenna Polarity & Test Distance: Horizontal at 3 m**

Frequency (MHz)	Emission Level (dBuV/m)	Read Level (dBuV)	Limit (dBuV/m)	Margin (dB)	Antenna Factor (dB/m)	Cable Loss (dB)	Preamp Factor (dB)	Antenna Height (cm)	Table Angle (Degree)	Remark
54.84	20.35	44.38	40	-19.65	7.3	0.9	32.23	142	195	Peak
90.48	34.8	56.46	43.5	-8.7	8.94	1.11	31.71	102	155	Peak
181.47	21.78	42.01	43.5	-21.72	10.4	1.61	32.24	114	187	Peak
402.2	22.25	34.07	46	-23.75	18.06	2.34	32.22	113	162	Peak
584.9	21.53	30.43	46	-24.47	20.48	2.82	32.2	144	159	Peak
736.8	36.91	42.58	46	-9.09	23.3	3.16	32.13	103	162	Peak

**Antenna Polarity & Test Distance: Vertical at 3 m**

Frequency (MHz)	Emission Level (dBuV/m)	Read Level (dBuV)	Limit (dBuV/m)	Margin (dB)	Antenna Factor (dB/m)	Cable Loss (dB)	Preamp Factor (dB)	Antenna Height (cm)	Table Angle (Degree)	Remark
48.36	12.04	35.05	40	-27.96	8.31	0.9	32.22	152	118	Peak
90.21	13.59	35.25	43.5	-29.91	8.94	1.11	31.71	144	187	Peak
158.79	9.78	29.79	43.5	-33.72	10.74	1.52	32.27	102	30	Peak
454.7	18.88	30.35	46	-27.12	18.18	2.49	32.14	123	162	Peak
673.8	24.23	29.9	46	-21.77	23.4	3.05	32.12	118	175	Peak
729.8	37.39	42.98	46	-8.61	23.37	3.16	32.12	102	154	Peak

Remarks:

- Emission Level = Read Level + Antenna Factor + Cable Loss - Preamp Factor  
Margin value = Emission level – Limit value
- The emission levels of other frequencies were very low against the limit.

## 4.2 Conducted Emission Measurement

### 4.2.1 Limits of Conducted Emission Measurement

Frequency (MHz)	Conducted Limit (dBuV)	
	Quasi-Peak	Average
0.15 - 0.5	66 - 56	56 - 46
0.50 - 5.0	56	46
5.0 - 30.0	60	50

- Note: 1. The lower limit shall apply at the transition frequencies.  
 2. The limit decreases in line with the logarithm of the frequency in the range of 0.15 to 0.50 MHz.

### 4.2.2 Test Instruments

Description & Manufacturer	Model No.	Serial No.	Date of Calibration	Due Date of Calibration
Test Receiver ROHDE & SCHWARZ	ESCI	100613	Nov. 23, 2017	Nov. 22, 2018
RF signal cable Woken	5D-FB	Cable-cond1-01	Sep. 05, 2018	Sep. 04, 2019
LISN/AMN ROHDE & SCHWARZ (EUT)	ENV216	101826	Feb. 26, 2018	Feb. 25, 2019
LISN/AMN ROHDE & SCHWARZ (Peripheral)	ESH3-Z5	100311	Aug. 19, 2018	Aug. 18, 2019
Software ADT	BV ADT_Cond_ V7.3.7.4	NA	NA	NA

- Note: 1. The calibration interval of the above test instruments is 12 months and the calibrations are traceable to NML/ROC and NIST/USA.  
 2. The test was performed in HwaYa Shielded Room 1.  
 3. The VCCI Site Registration No. is C-2040.

#### 4.2.3 Test Procedures

- The EUT was placed 0.4 meters from the conducting wall of the shielded room with EUT being connected to the power mains through a line impedance stabilization network (LISN). Other support units were connected to the power mains through another LISN. The two LISNs provide 50 ohm/ 50 uH of coupling impedance for the measuring instrument.
- Both lines of the power mains connected to the EUT were checked for maximum conducted interference.
- The frequency range from 150 kHz to 30 MHz was searched. Emission levels under (Limit – 20 dB) was not recorded.

**Note:** The resolution bandwidth and video bandwidth of test receiver is 9 kHz for quasi-peak detection (QP) and average detection (AV) at frequency 0.15 MHz - 30 MHz.

#### 4.2.4 Deviation from Test Standard

No deviation.

#### 4.2.5 Test Setup

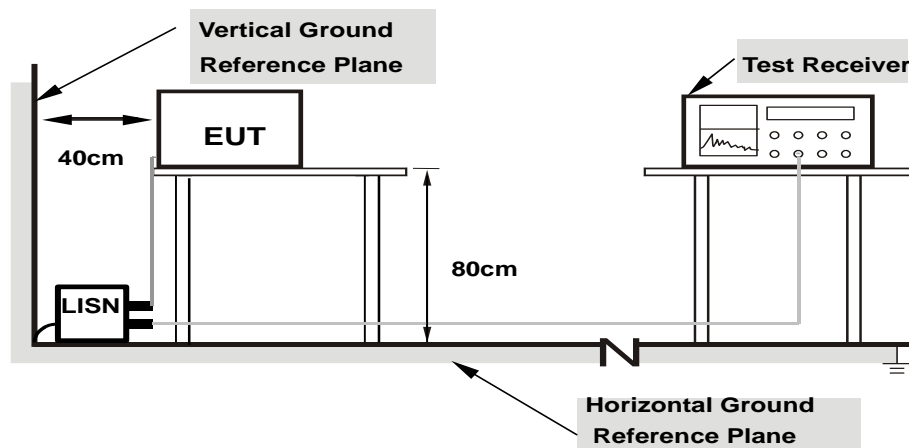

- Note:**
- Support units were connected to second LISN.
  - Both of LISNs (AMN) are 80 cm from EUT and at least 80 cm from other units and other metal planes

For the actual test configuration, please refer to the attached file (Test Setup Photo).

#### 4.2.6 EUT Operating Condition

Set the EUT under transmission condition continuously at specific channel frequency.

4.2.7 Test Results

**CONDUCTED WORST-CASE DATA : 8DPSK**

Frequency Range	150kHz ~ 30MHz	Detector Function & Resolution Bandwidth	Quasi-Peak (QP) / Average (AV), 9kHz
Input Power	120Vac, 60Hz	Environmental Conditions	25°C, 65%RH
Tested by	Jisyong Wang	Test Date	2018/9/13

Phase Of Power : Line (L)										
No	Frequency (MHz)	Correction Factor (dB)	Reading Value (dBuV)		Emission Level (dBuV)		Limit (dBuV)		Margin (dB)	
			Q.P.	AV.	Q.P.	AV.	Q.P.	AV.	Q.P.	AV.
1	0.15391	9.67	38.93	25.68	48.60	35.35	65.79	55.79	-17.19	-20.44
2	0.19305	9.67	35.25	22.02	44.92	31.69	63.90	53.90	-18.98	-22.21
3	0.22038	9.67	32.15	18.15	41.82	27.82	62.80	52.80	-20.98	-24.98
4	0.27903	9.67	27.99	15.70	37.66	25.37	60.84	50.84	-23.18	-25.47
5	0.63875	9.66	31.11	15.63	40.77	25.29	56.00	46.00	-15.23	-20.71
6	14.86724	9.88	28.74	11.91	38.62	21.79	60.00	50.00	-21.38	-28.21

Remarks:

1. Q.P. and AV. are abbreviations of quasi-peak and average individually.
2. The emission levels of other frequencies were very low against the limit.
3. Margin value = Emission level – Limit value
4. Correction factor = Insertion loss + Cable loss
5. Emission Level = Correction Factor + Reading Value

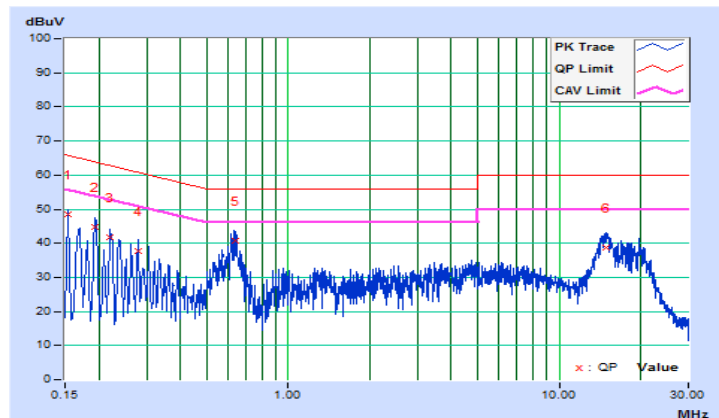

Frequency Range	150kHz ~ 30MHz	Detector Function & Resolution Bandwidth	Quasi-Peak (QP) / Average (AV), 9kHz
Input Power	120Vac, 60Hz	Environmental Conditions	25°C, 65%RH
Tested by	Jisyong Wang	Test Date	2018/9/13

Phase Of Power : Neutral (N)										
No	Frequency (MHz)	Correction Factor (dB)	Reading Value (dBuV)		Emission Level (dBuV)		Limit (dBuV)		Margin (dB)	
			Q.P.	AV.	Q.P.	AV.	Q.P.	AV.	Q.P.	AV.
1	0.16564	9.68	24.24	5.86	33.92	15.54	65.18	55.18	-31.26	-39.64
2	0.17744	9.67	22.98	5.27	32.65	14.94	64.60	54.60	-31.95	-39.66
3	0.20511	9.67	16.69	0.93	26.36	10.60	63.40	53.40	-37.04	-42.80
4	0.62702	9.66	14.47	1.92	24.13	11.58	56.00	46.00	-31.87	-34.42
5	14.72648	9.94	21.44	3.74	31.38	13.68	60.00	50.00	-28.62	-36.32
6	16.67366	9.96	21.13	0.64	31.09	10.60	60.00	50.00	-28.91	-39.40

Remarks:

1. Q.P. and AV. are abbreviations of quasi-peak and average individually.
2. The emission levels of other frequencies were very low against the limit.
3. Margin value = Emission level – Limit value
4. Correction factor = Insertion loss + Cable loss
5. Emission Level = Correction Factor + Reading Value

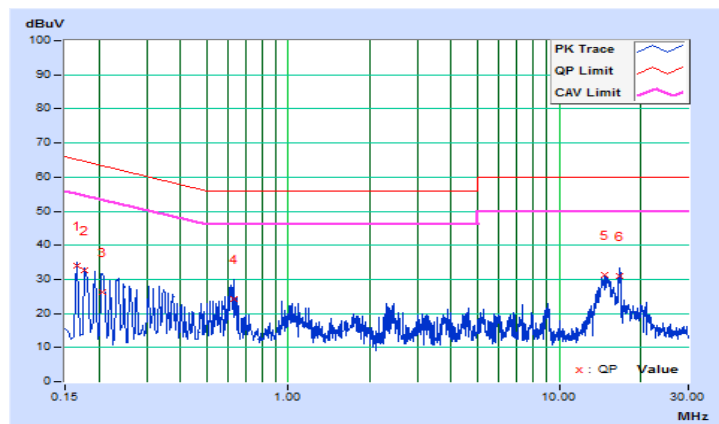

### 4.3 Number of Hopping Frequency Used

#### 4.3.1 Limits of Hopping Frequency Used Measurement

At least 15 channels frequencies, and should be equally spaced.

#### 4.3.2 Test Setup



#### 4.3.3 Test Instruments

Refer to section 4.1.2 to get information of above instrument.

#### 4.3.4 Test Procedure

- Check the calibration of the measuring instrument (SA) using either an internal calibrator or a known signal from an external generator.
- Turn on the EUT and connect its antenna terminal to measurement via a low loss cable. Then set it to any one measured frequency within its operating range and make sure the instrument is operated in its linear range.
- Set the SA on MaxHold Mode, and then keep the EUT in hopping mode. Record all the signals from each channel until each one has been recorded.
- Set the SA on View mode and then plot the result on SA screen.
- Repeat above procedures until all frequencies measured were complete.

#### 4.3.5 Deviation from Test Standard

No deviation.

### 4.3.6 Test Results

There are 79 hopping frequencies in the hopping mode. Please refer to next page for the test result. On the plots, it shows that the hopping frequencies are equally spaced.

#### <GFSK>

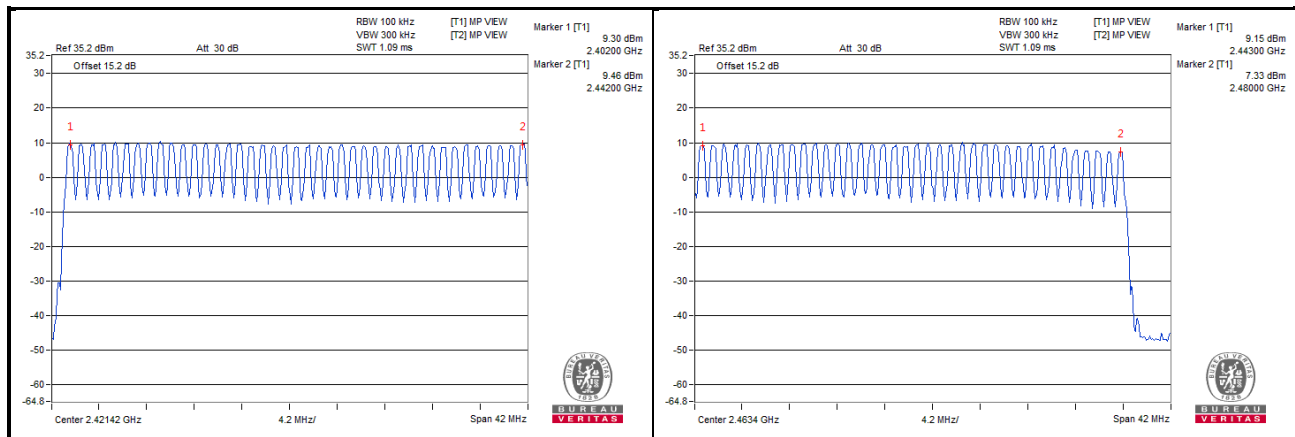

#### <8DPSK>

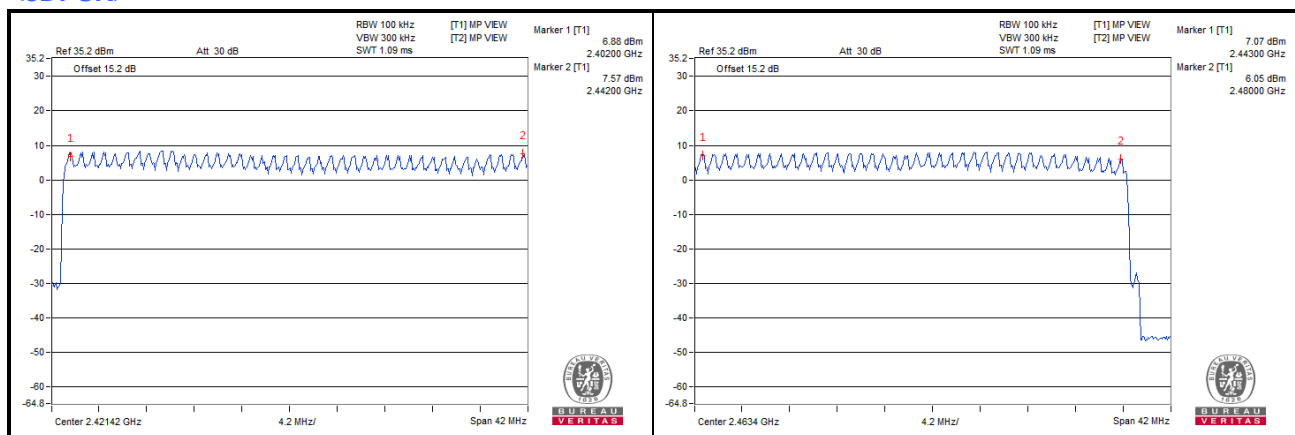

#### 4.4 Dwell Time on Each Channel

##### 4.4.1 Limits of Dwell Time on Each Channel Measurement

The average time of occupancy on any channel shall not be greater than 0.4 seconds within a period of 0.4 seconds multiplied by the number of hopping channels employed.

##### 4.4.2 Test Setup

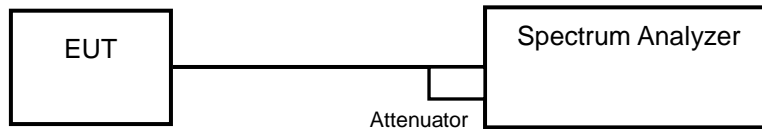

##### 4.4.3 Test Instruments

Refer to section 4.1.2 to get information of above instrument.

##### 4.4.4 Test Procedures

- a. Check the calibration of the measuring instrument (SA) using either an internal calibrator or a known signal from an external generator.
- b. Turn on the EUT and connect its antenna terminal to measurement via a low loss cable. Then set it to any one measured frequency within its operating range and make sure the instrument is operated in its linear range.
- c. Adjust the center frequency of SA on any frequency be measured and set SA to zero span mode. And then, set RBW and VBW of spectrum analyzer to proper value.
- d. Measure the time duration of one transmission on the measured frequency. And then plot the result with time difference of this time duration.
- e. Repeat above procedures until all different time-slot modes have been completed.

##### 4.4.5 Deviation from Test Standard

No deviation.



### 4.4.6 Test Results

#### GFSK

Mode	Number of Transmission in a 31.6 (79 Hopping*0.4)	Length of Transmission Time (msec)	Result (msec)	Limit (sec)
DH1	52 (times / 5 sec) * 6.32 = 328.64 times	0.46	151.17	0.4
DH3	27 (times / 5 sec) * 6.32 = 170.64 times	1.69	288.38	0.4
DH5	17 (times / 5 sec) * 6.32 = 107.44 times	2.97	319.1	0.4

**Note:** Test plots of the transmitting time slot are shown as below.

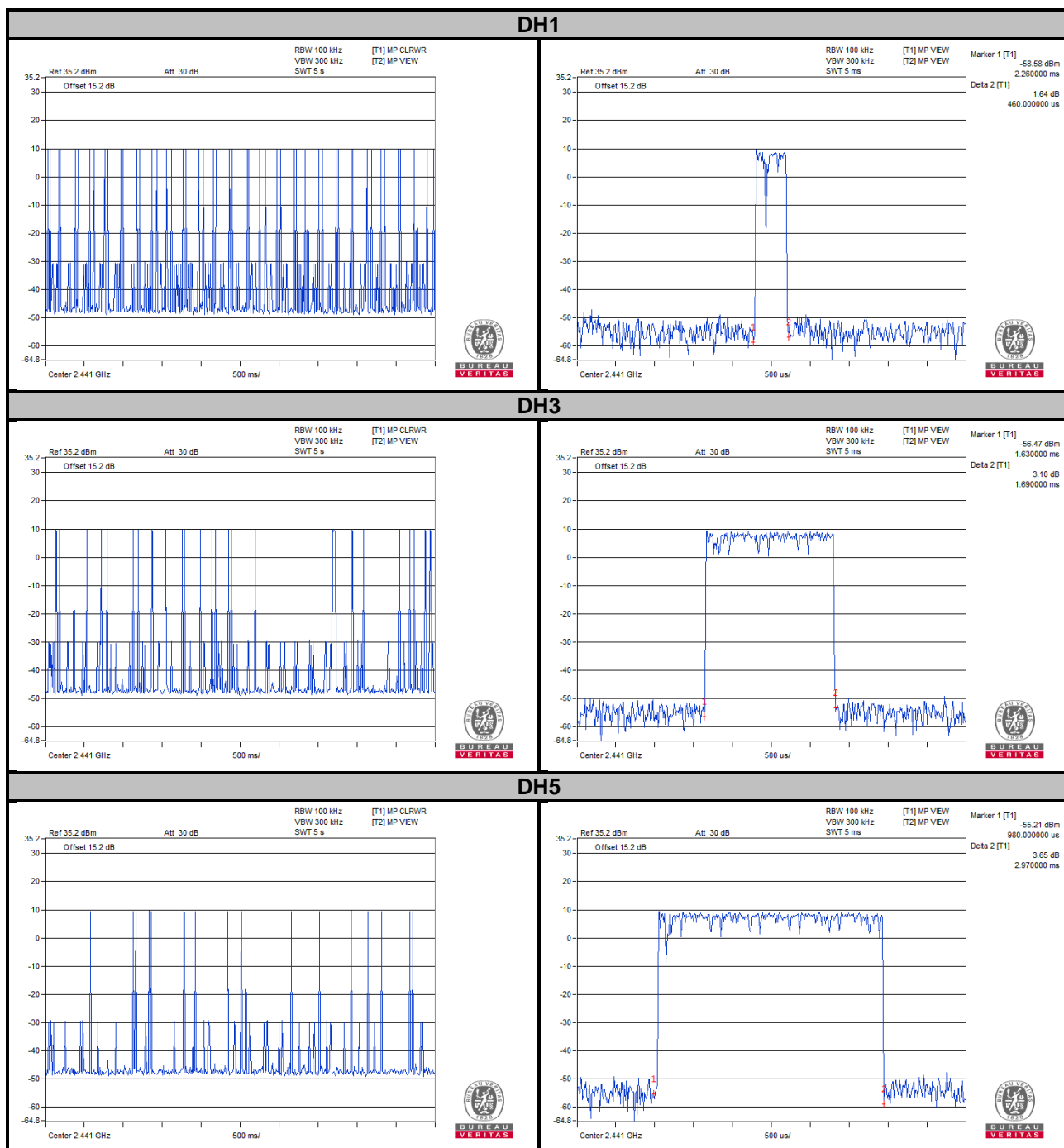

### 8DPSK

Mode	Number of Transmission in a 31.6 (79 Hopping*0.4)	Length of Transmission Time (msec)	Result (msec)	Limit (sec)
3DH1	50 (times / 5 sec) * 6.32 = 316 times	0.44	139.04	0.4
3DH3	25 (times / 5 sec) * 6.32 = 158 times	1.73	273.34	0.4
3DH5	17 (times / 5 sec) * 6.32 = 107.44 times	2.96	318.02	0.4

**Note:** Test plots of the transmitting time slot are shown as below.

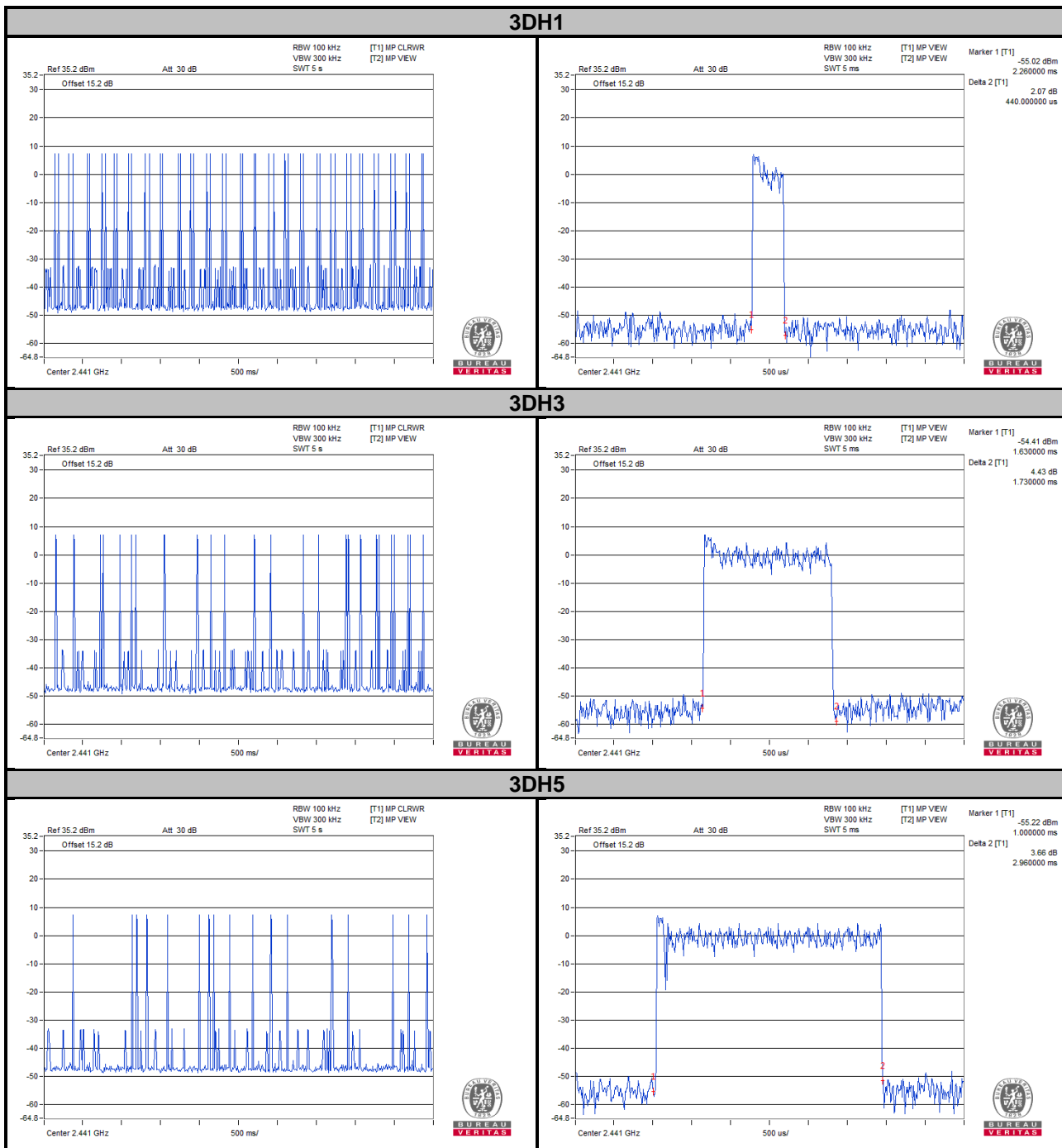

## 4.5 Channel Bandwidth

### 4.5.1 Limits of Channel Bandwidth Measurement

For frequency hopping system operating in the 2400-2483.5 MHz, if the 20 dB bandwidth of hopping channel is greater than 25 kHz, two-thirds 20 dB bandwidth of hopping channel shall be a minimum limit for the hopping channel separation.

### 4.5.2 Test Setup

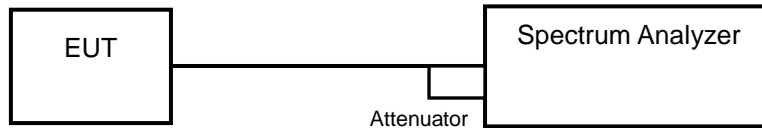

### 4.5.3 Test Instruments

Refer to section 4.1.2 to get information of above instrument.

### 4.5.4 Test Procedure

- Check the calibration of the measuring instrument using either an internal calibrator or a known signal from an external generator.
- Turn on the EUT and connect it to measurement instrument. Then set it to any one convenient frequency within its operating range. Set a reference level on the measuring instrument equal to the highest peak value.
- Measure the frequency difference of two frequencies that were attenuated 20 dB from the reference level. Record the frequency difference as the emission bandwidth.
- Repeat above procedures until all frequencies measured were complete.

### 4.5.5 Deviation from Test Standard

No deviation.

### 4.5.6 EUT Operating Condition

The software provided by client enabled the EUT to transmit and receive data at lowest, middle and highest channel frequencies individually.

#### 4.5.7 Test Results

Channel	Frequency (MHz)	20 dB Bandwidth (MHz)	
		GFSK	8DPSK
0	2402	0.96	1.31
39	2441	0.96	1.31
78	2480	0.96	1.34

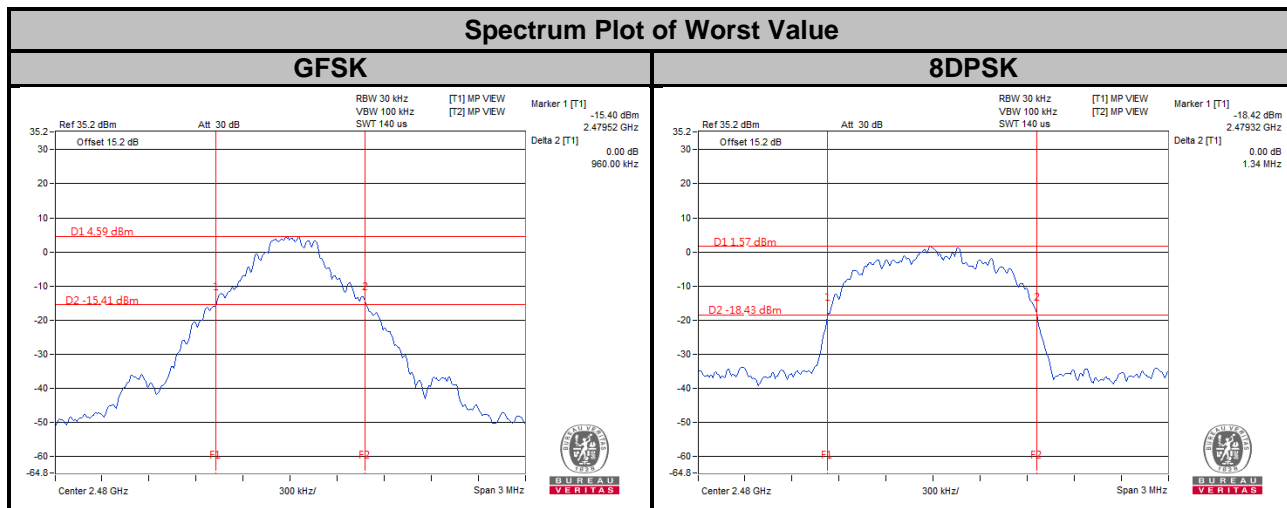

## 4.6 Occupied Bandwidth Measurement

### 4.6.1 Test Setup

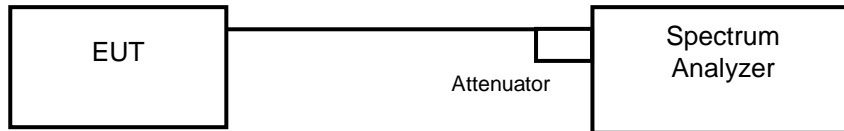

### 4.6.2 Test Instruments

Refer to section 4.1.2 to get information of above instrument

### 4.6.3 Test Procedure

The transmitter output was connected to the spectrum analyzer through an attenuator. The bandwidth of the fundamental frequency was measured by spectrum analyzer with resolution bandwidth in the range of 1 % to 5 % of the anticipated emission bandwidth, and a video bandwidth at least 3x the resolution bandwidth and set the detector to PEAK. The width of a frequency band such that, below the lower and above the upper frequency limits, the mean powers emitted are each equal to a specified percentage 0.5 % of the total mean power of a given emission.

### 4.6.4 Deviation from Test Standard

No deviation.

### 4.6.5 EUT Operating Conditions

The software provided by client to enable the EUT under transmission condition continuously at lowest, middle and highest channel frequencies individually.

#### 4.6.6 Test Results

Channel	Frequency (MHz)	Occupied Bandwidth (MHz)	
		GFSK	8DPSK
0	2402	0.88	1.19
39	2441	0.87	1.18
78	2480	0.87	1.19

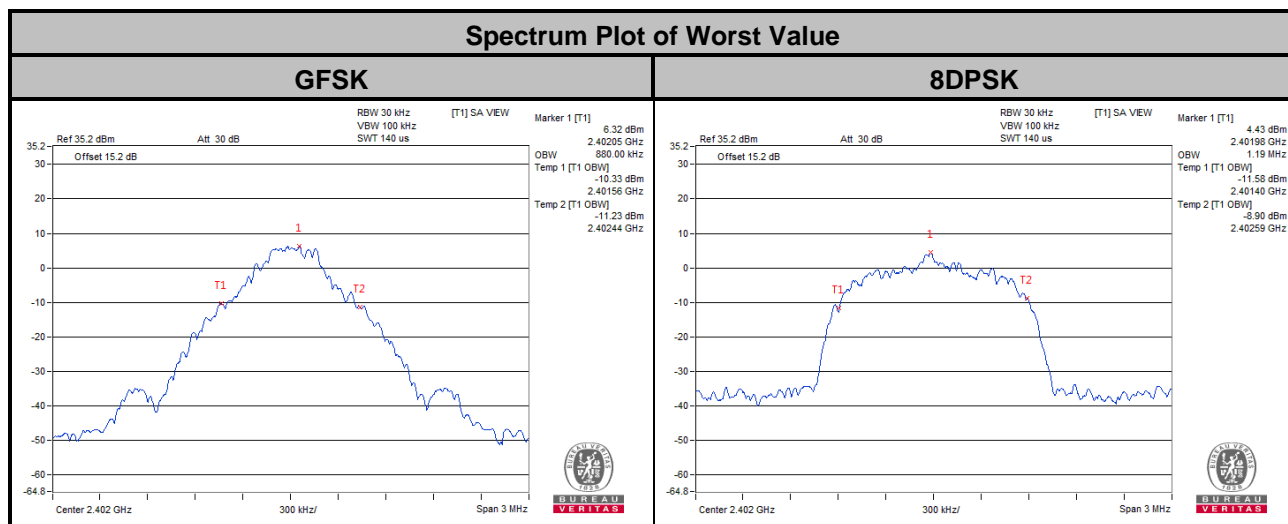

## 4.7 Hopping Channel Separation

### 4.7.1 Limits of Hopping Channel Separation Measurement

At least 25 kHz or two-third of 20 dB hopping channel bandwidth (whichever is greater).

### 4.7.2 Test Setup



### 4.7.3 Test Instruments

Refer to section 4.1.2 to get information of above instrument.

### 4.7.4 Test Procedure

#### Measurement Procedure REF

- Check the calibration of the measuring instrument using either an internal calibrator or a known signal from an external generator.
- Turn on the EUT and connect it to measurement instrument. Then set it to any one convenient frequency within its operating range.
- By using the MaxHold function record the separation of two adjacent channels.
- Measure the frequency difference of these two adjacent channels by SA MARK function. And then plot the result on SA screen.
- Repeat above procedures until all frequencies measured were complete.

### 4.7.5 Deviation from Test Standard

No deviation.

#### 4.7.6 Test Results

Channel	Freq. (MHz)	Adjacent Channel Separation (MHz)		20 dB Bandwidth (MHz)		Minimum Limit (MHz)		Pass / Fail
		GFSK	8DPSK	GFSK	8DPSK	GFSK	8DPSK	
0	2402	1.00	1.00	0.96	1.31	0.64	0.88	Pass
39	2441	1.00	1.00	0.96	1.31	0.64	0.88	Pass
78	2480	1.00	1.00	0.96	1.34	0.64	0.9	Pass

**Note:**

- The minimum limit is two-third 20 dB bandwidth.

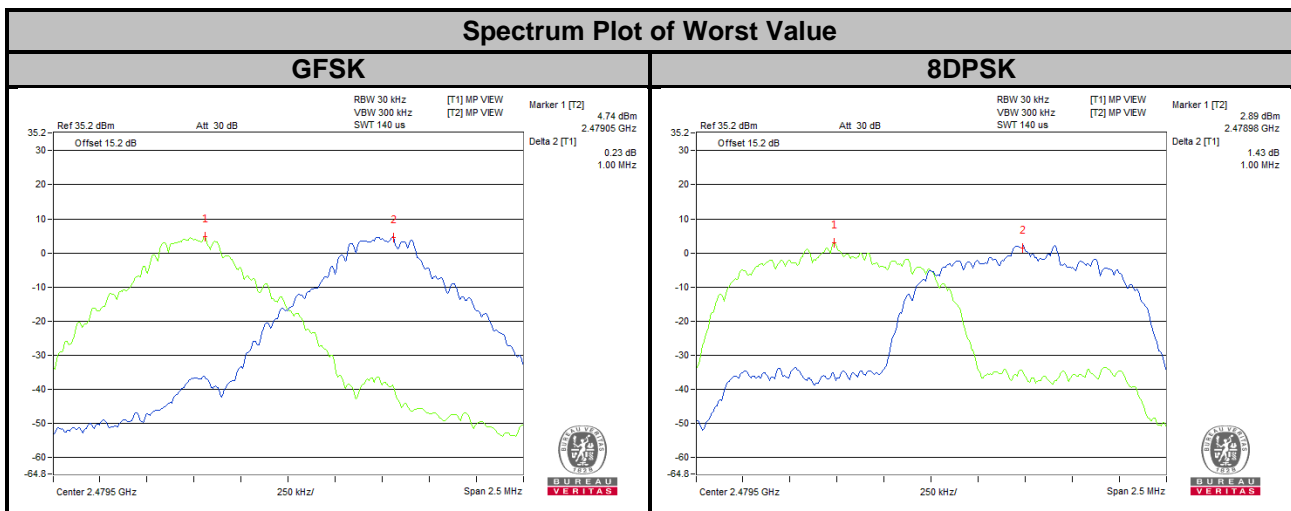



## 4.8 Maximum Output Power

### 4.8.1 Limits of Maximum Output Power Measurement

The Maximum Output Power Measurement is 125 mW.

### 4.8.2 Test Setup



### 4.8.3 Test Instruments

Refer to section 4.1.2 to get information of above instrument.

### 4.8.4 Test Procedure

- Check the calibration of the measuring instrument using either an internal calibrator or a known signal from an external generator.
- Turn on the EUT and connect it to measurement instrument. Then set it to any one convenient frequency within its operating range. Set a reference level on the measuring instrument equal to the highest peak value.
- The center frequency of the spectrum analyzer is set to the fundamental frequency and using 3 MHz RBW and 10 MHz VBW.
- Measure the captured power within the band and recording the plot.
- Repeat above procedures until all frequencies required were complete.

### 4.8.5 Deviation from Test Standard

No deviation.

### 4.8.6 EUT Operating Condition

The software provided by client enabled the EUT to transmit and receive data at lowest, middle and highest channel frequencies individually.

### 4.8.7 Test Results

#### <GFSK>

Channel	Freq. (MHz)	Output Power (mW)	Output Power (dBm)	Power Limit (mW)	Pass / Fail
0	2402	9.397	9.73	125	Pass
39	2441	8.414	9.25	125	Pass
78	2480	5.984	7.77	125	Pass

#### <8DPSK>

Channel	Freq. (MHz)	Output Power (mW)	Output Power (dBm)	Power Limit (mW)	Pass / Fail
0	2402	8.356	9.22	125	Pass
39	2441	7.43	8.71	125	Pass
78	2480	5.346	7.28	125	Pass

### Spectrum Plot of Worst Value

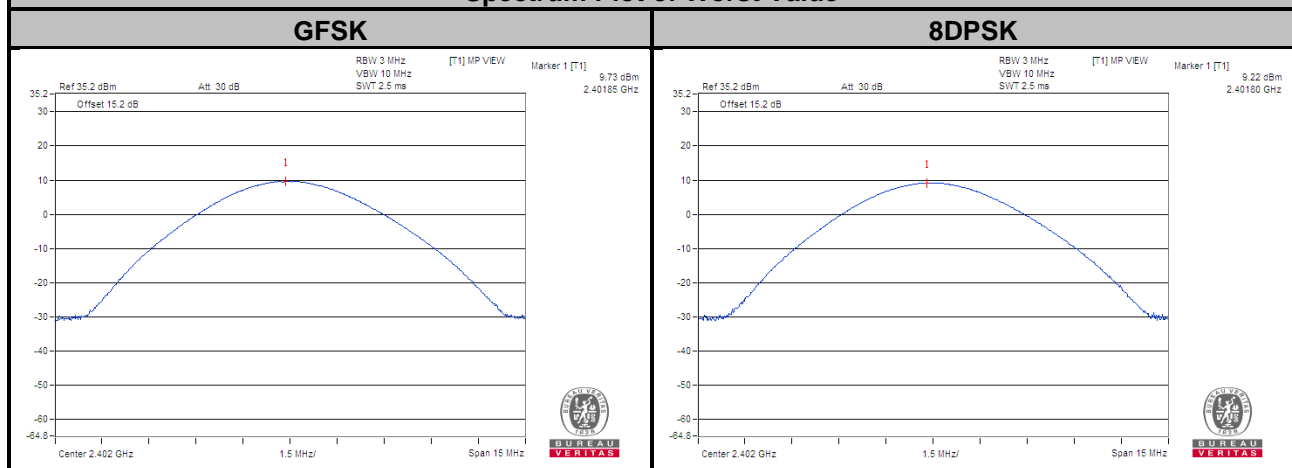

## 4.9 Conducted Out of Band Emission Measurement

### 4.9.1 Limits Of Conducted Out of Band Emission Measurement

Below  $-20$  dB of the highest emission level of operating band (in 100 kHz RBW).

### 4.9.2 Test Instruments

Refer to section 4.1.2 to get information of above instrument.

### 4.9.3 Test Procedure

The transmitter output was connected to the spectrum analyzer via a low lose cable. Set both RBW and VBW of spectrum analyzer to 100 kHz and 300 kHz with suitable frequency span including 100 MHz bandwidth from band edge. The band edges was measured and recorded.

### 4.9.4 Deviation from Test Standard

No deviation.

### 4.9.5 EUT Operating Condition

The software provided by client enabled the EUT to transmit and receive data at lowest, middle and highest channel frequencies individually.

### 4.9.6 Test Results

The spectrum plots are attached on the following images. D1 line indicates the highest level, D2 line indicates the 20 dB offset below D1. It shows compliance with the requirement.

GFSK

Hopping Disabled\_Low Channel

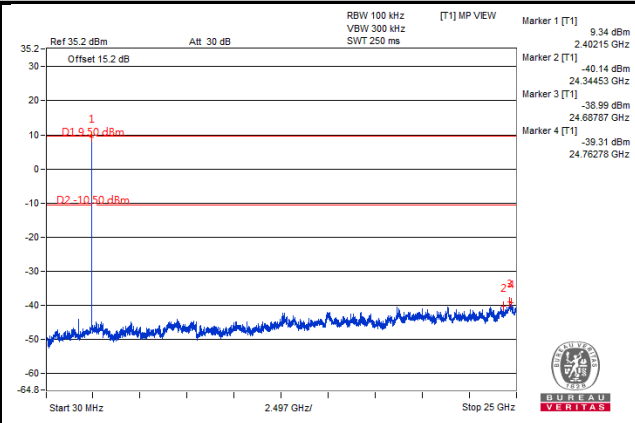
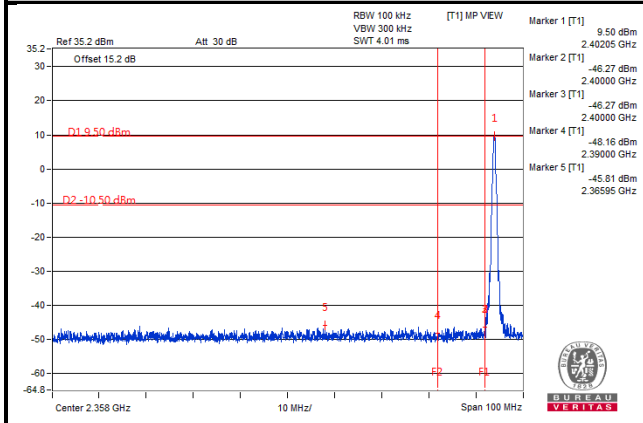

Hopping Disabled\_Middle Channel

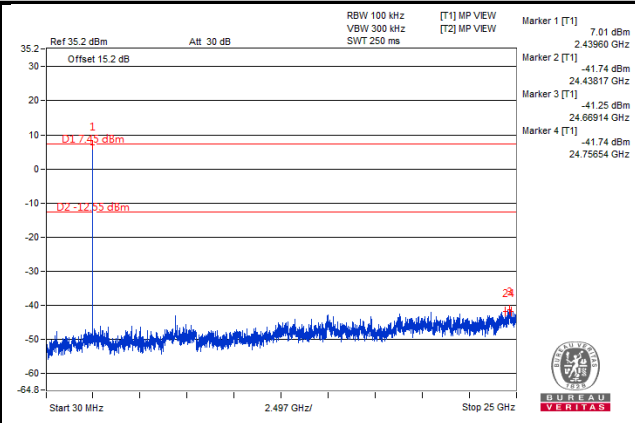
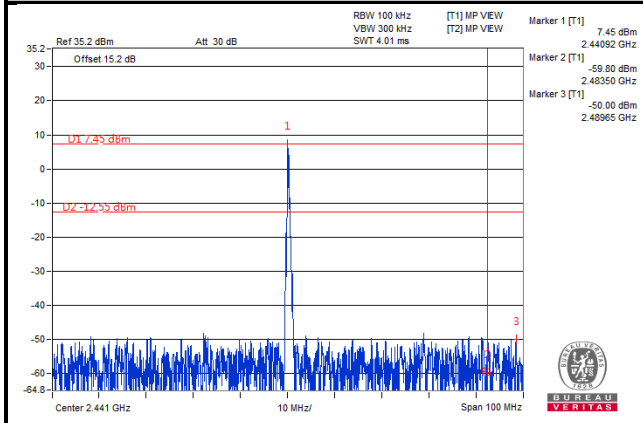

Hopping Disabled\_High Channel

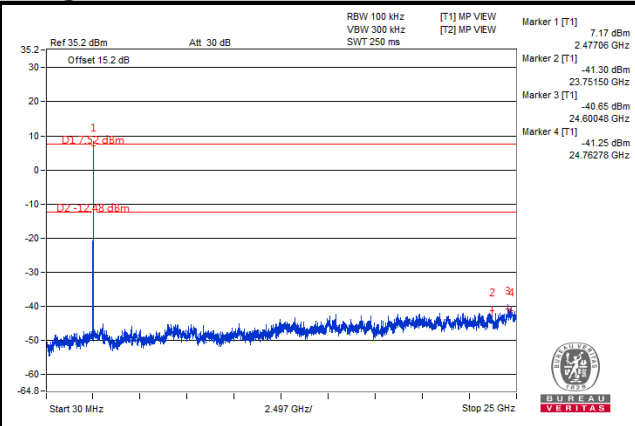
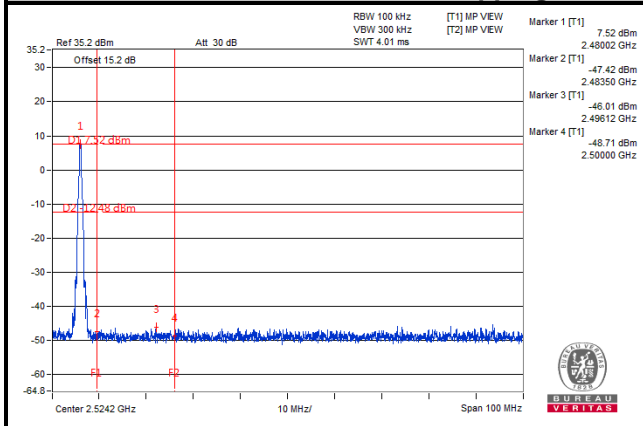

### Hopping Enabled\_Low Channel

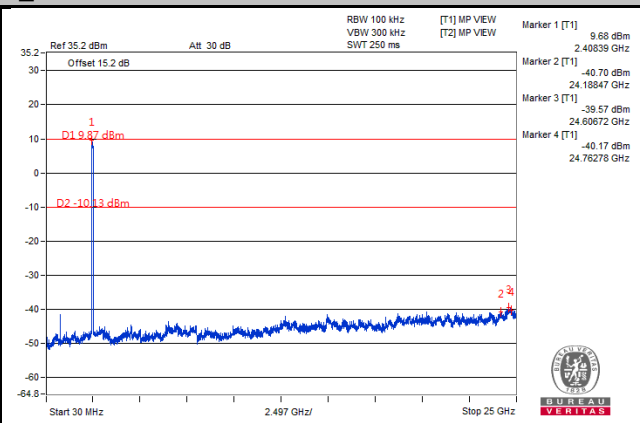
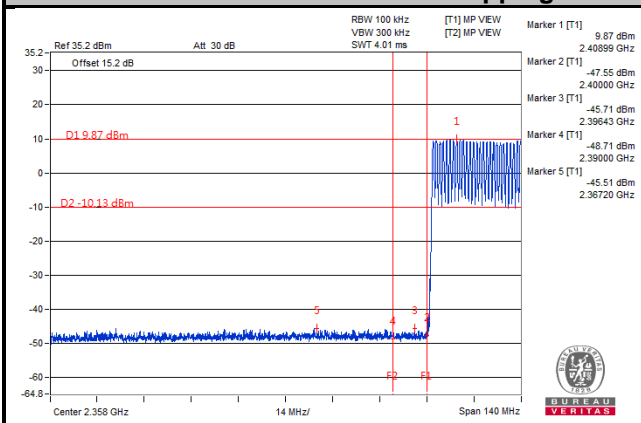

### Hopping Enabled\_High Channel

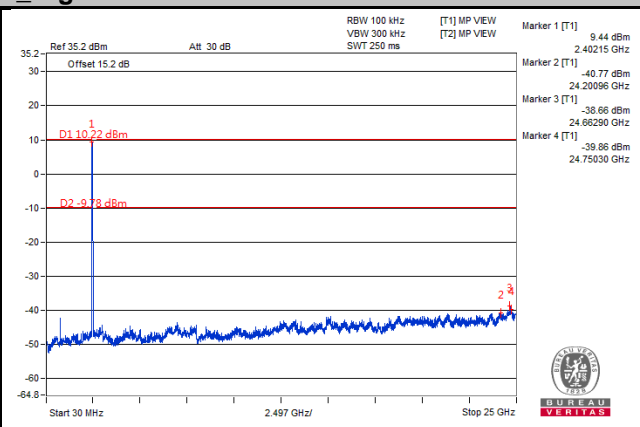
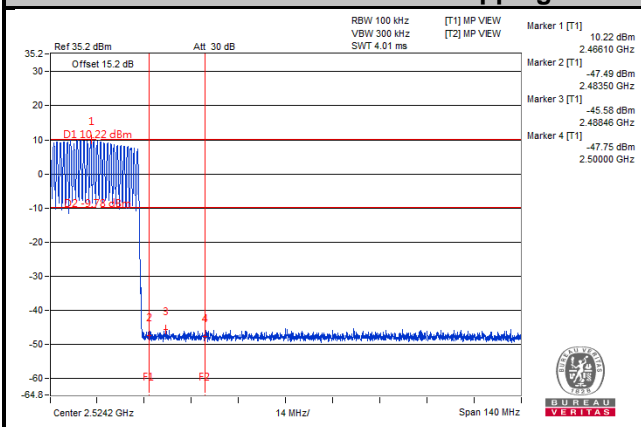

# 8DPSK

## Hopping Disabled\_Low Channel

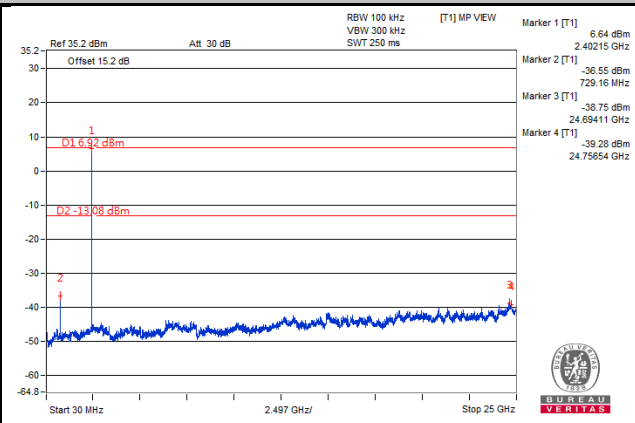
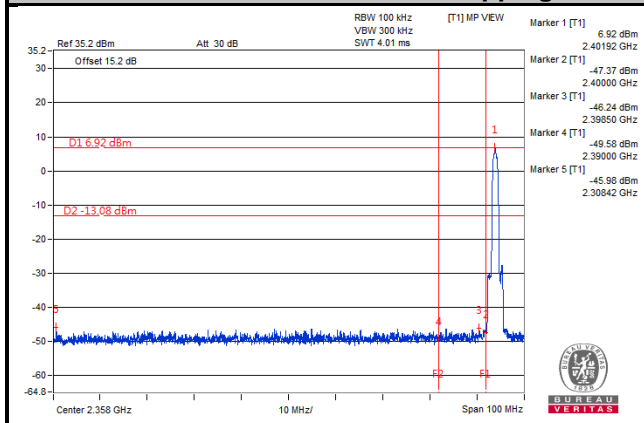

## Hopping Disabled\_Middle Channel

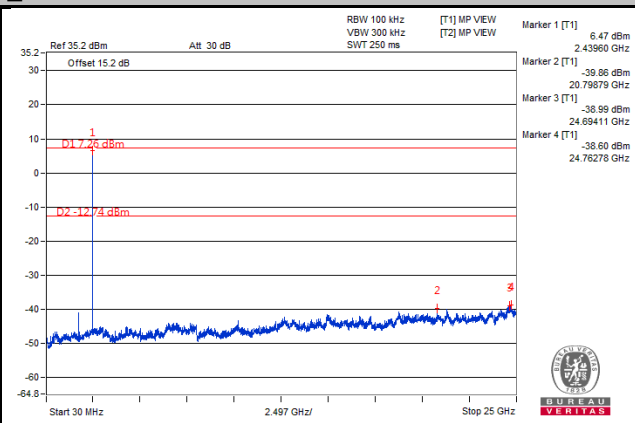
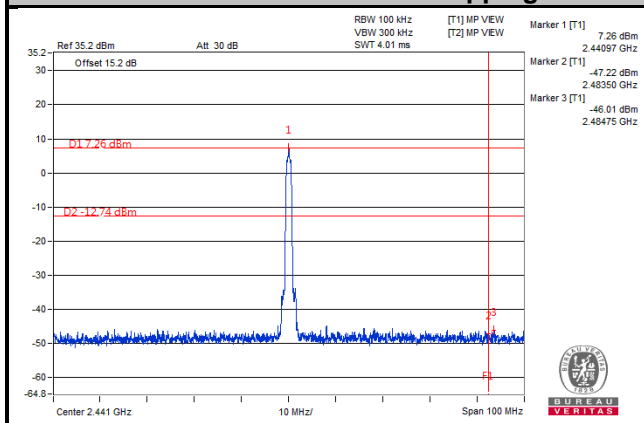

## Hopping Disabled\_High Channel

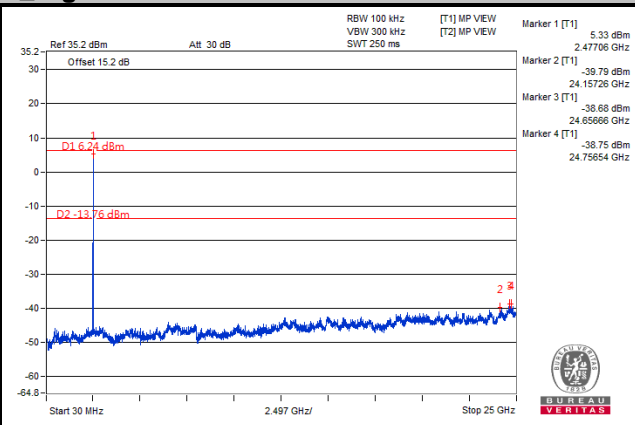
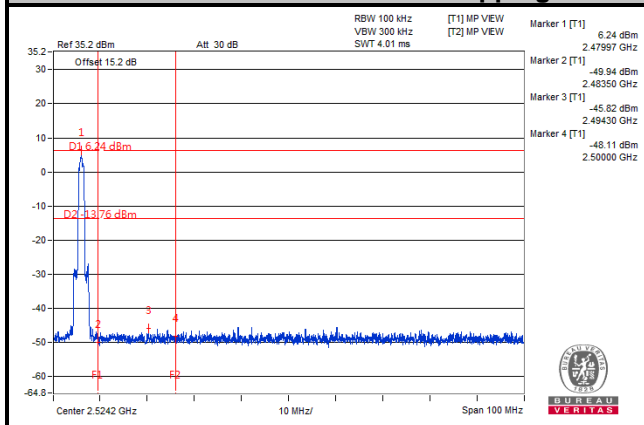

### Hopping Enabled\_Low Channel

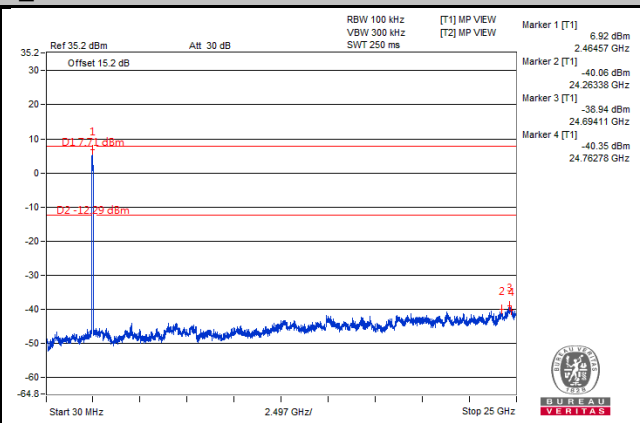
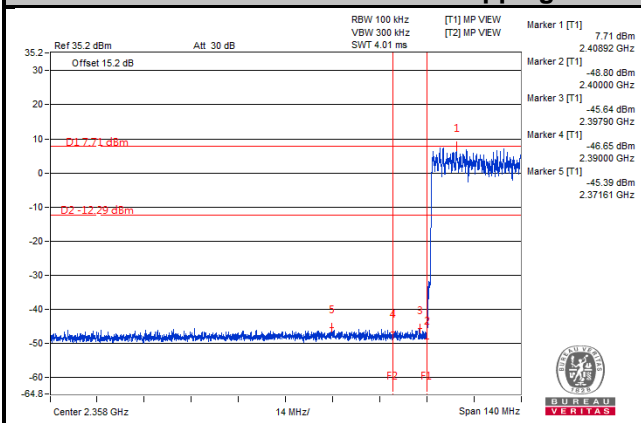

### Hopping Enabled\_High Channel

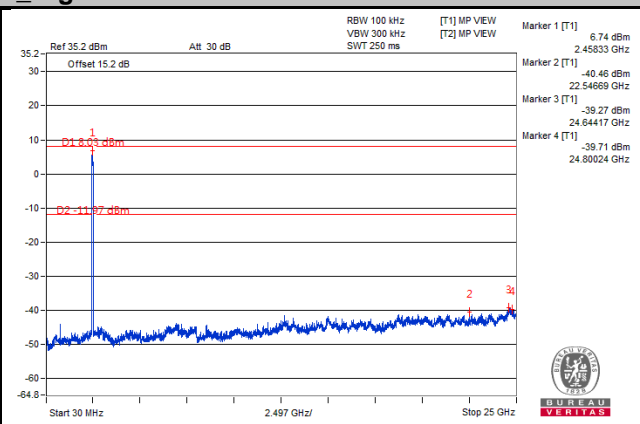
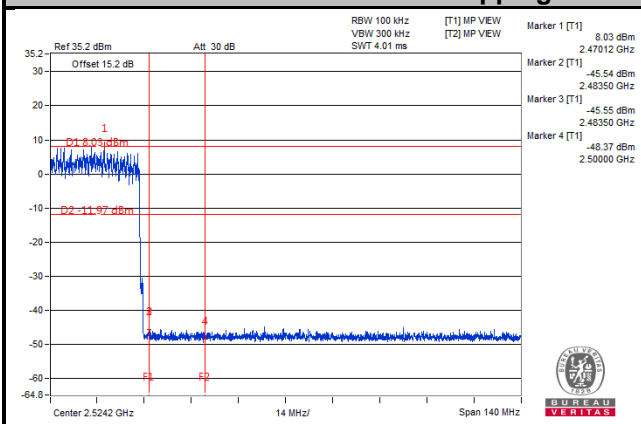

## 5 Pictures of Test Arrangements

Please refer to the attached file (Test Setup Photo).



## Appendix – Information on the Testing Laboratories

We, Bureau Veritas Consumer Products Services (H.K.) Ltd., Taoyuan Branch, were founded in 1988 to provide our best service in EMC, Radio, Telecom and Safety consultation. Our laboratories are FCC recognized accredited test firms and accredited according to ISO/IEC 17025.

If you have any comments, please feel free to contact us at the following:

**Linko EMC/RF Lab**

Tel: 886-2-26052180

Fax: 886-2-26051924

**Hsin Chu EMC/RF/Telecom Lab**

Tel: 886-3-6668565

Fax: 886-3-6668323

**Hwa Ya EMC/RF/Safety**

Tel: 886-3-3183232

Fax: 886-3-3270892

**Email:** [service.adt@tw.bureauveritas.com](mailto:service.adt@tw.bureauveritas.com)

**Web Site:** [www.bureauveritas-adt.com](http://www.bureauveritas-adt.com)

The address and road map of all our labs can be found in our web site also.

--- END ---